

EMERALD

and
OTHER
BERYLS



JOHN SINKANKAS

GIA
0201113

EMERALD \$64.95 and +TAX OTHER BERYLS

by
JOHN SINKANKAS

This consummate portrait of *Emerald and Other Beryls* is a permanent reference for jewelers, gemological historians, mineralogists, geologists, and mineral collectors. John Sinkankas, a widely respected authority on the earth sciences, here provides a scholarly yet eminently readable monograph on every facet of beryl: cultural and natural history; structure and composition; lapidary and synthesis; and world occurrences, including gems, collector's specimens, and the ore of the rare metal beryllium.

Beginning with Egypt 5500 years ago, the author traces the story of the dazzling emerald—from the fabled Table of Solomon to Queen Elizabeth II's Coronation jewels—and its less renowned relatives, the pink morganite, the golden beryl and the blue aquamarine. The role of beryl in ornament, magic and medicine is a fascinating tale interwoven with history's most compelling people and events. Together with a unique nomenclature appendix of synonyms in all languages for beryl and its varieties, this cultural archive is of special interest to historians, archeologists, linguists and students of curious lore.

In the second part, Sinkankas explores the natural history of emerald and beryl and the advances in mineralogical knowledge from antiquity, through the Christian Era, the Middle Ages, and into the highly technological modern era of exotic uses for a mineral that was once considered suitable only for ornamentation. The author culled and synthesized the extensive literature of every language to bring to one volume all the significant material on crystal structure, chemical composition, physical and optical properties, and causes of color. A chapter is also devoted to cutting emerald and other beryls into jewelry stones.

Unmatched anywhere in the literature, the third part is an encyclopedic guide to major beryl deposits, with special notes on sources of fine crystal specimens and gem materials. Sinkankas has compressed a colossal amount

(Continued on back flap)

GIA

EMERALD
AND OTHER BERYLS

JOHN SINKANKAS

SCIENCE PRESS
SERIES 100

EMERALD
AND OTHER BEYLS

EMERALD and OTHER BERYLS

JOHN SINKANKAS

CAPTAIN, U.S. NAVY (RET.)
FELLOW, MINERALOGICAL SOCIETY OF AMERICA

GEOSCIENCE PRESS
PRESCOTT, ARIZONA

CLARK, M.B.
AND
WILLIAMS, H.T.O.

First published by Geoscience Press in 1989

Copyright © 1981 by John Sinkankas

Library of Congress Catalog Card No. 81-66282

ISBN 0-945005-03-2

All rights reserved. No part of this work covered by the copyright hereon may be reproduced or used in any form or by any means — graphic, electronic, or mechanical, including photocopying, recording, taping, or information storage systems — without written permission of the publisher.

Printed in the United States of America

Published by Geoscience Press

1040 Hyland Circle

Prescott, AZ 86303

Telephone: (602) 445-8058

9 8 7 6 5 4 3 2

To
MARGUERITE BRISTOL TIFFANY
Teacher, Mentor, and Friend

CONTENTS

PREFACE, xiii
ACKNOWLEDGMENTS, xv

Part I **HISTORY AND LORE**

1. EMERALD AND BERYL IN ANTIQUITY

Emerald in Ancient Egypt, 4
Emerald and Beryl in Ancient India, 9
Beryl in the Ancient East, 11
Beryl in Graeco-Roman Times, 13
Pliny's *Natural History*, 17
Early Use of Beryl in the Americas, 21

2. EMERALD AND BERYL IN MEDIEVAL AND MODERN EUROPE

Biblical Lapidaries, 24
Other Early Lapidaries, 24
The *Speculum Lapidum*, 27
New World Emeralds, 29
Agricola's *De Natura Fossilium*, 30
Gesner's *De Rerum Fossilium*, 32
Value of Emerald and Other Gemstones, 32

Some Early 17th-Century Lapidaries,
37

DeBoodt's Landmark Lapidary, 37
Nicols' *History of Pretious Stones*, 39
Mineralogy in the Mid-17th Century,
41

Boyle and His Contemporaries, 43
Advances of the 18th Century, 47
The Brückmann Treatises, 48
Advances in Chemical and Physical
Analysis, 50
Haüy and His Successors, 53

3. BERYL IN MAGIC, MYSTERY, AND MEDICINE

Early Egyptian and Greek Lore, 61
Indian Gem Lore, 63
Early European Lore, 65
Occult Properties, 67
Personal Traits and Character, 67
Corporal Dangers, 69
Love and Marriage, 70
Business Transactions, 70
Demons and Evil Spirits, 71
Divination, Dreams and Discoveries, 72

CONTENTS

- Therapeutic Uses of Emerald and Beryl, 73
 Vision and Diseases of the Eyes, 76
 Poisons and Venomous Bites, 77
 Epilepsy, 77
 Pregnancy, Childbirth, and Fertility, 78
 Fevers and Contagious Disease, 78
 Digestive Tract Ailments, 78
 Other Ailments, 79
 Emerald and Beryl in the Bible, 80
 The Breastplate of the High Priest, 81
 Emerald and Beryl in the Foundation Stones, 86
 Emerald and Beryl as Birthstones, 87
 Astrology and Beryl in India, 90
 Emerald Lore in Colombia and Peru, 93
 Miscellaneous Lore, 94
 Engraved Emeralds and Beryls as Talismans, 95
 Emeralds in Fable, 97
 The Ring of Polycrates, 97
 Enormous Emeralds, 98
 The Table of Solomon, 98
 Nero's Emerald Eyeglass, 99
 The Tabula Smaragdina, 99
 Large European Emerald Objects, 100
 The Emerald Buddha, 101
 The Buddha's Tooth Emerald, 102
 Hernando Cortez' Emeralds, 102
4. BERYL IN
 ART AND ORNAMENT
 Engraved Beryl Gems, 106
 Inscribed Emeralds of Islam, 112
 Carvings in Beryl, 115
 Emerald and Beryl in Collections, 120
 Iran, 120
 Turkey, 121
 Russia, 124
 Austria, 127
 Germany, 127
 Italy, 130
 France, 131
 Spain, 132
 Portugal, 134
 England, 134
 United States and Canada, 140
 Miscellaneous American Beryls, 143
 South America, 144
 Modern Emerald and Beryl Jewelry, 146
- Part II**
CHEMICAL AND PHYSICAL PROPERTIES
5. CRYSTAL STRUCTURE AND
 CHEMICAL COMPOSITION OF BERYL
 The Beryl Structure, 157
 Space Group and Symmetry Elements, 159
 Unit Cell and Axial Ratio, 160
 Changes in Cell Dimensions, 162
 Chemical Composition, 163
 Silica, Alumina and Beryllia, 164
 Water in Beryl, 164
 Alkalis in Beryl, 167
 Transition Elements in Beryl, 168
 Other Elements in Beryl, 170
 Substitutions, 170
 Channel Ions, 171
 Substituting Structural Ions, 172
 Displacements, 172
 Beryl Formulas, 172
 Alterations and Pseudomorphs of Beryl, 173
 Chemical Decomposition and Analysis of Beryl, 175
 Chemical Field Tests, 177
 Other Field Tests, 179

Contents

6. PHYSICAL PROPERTIES

- Fracture and Cleavage, 184
- Hardness, 186
- Elasticity and Compressibility, 186
- Thermal Expansion, 187
- Thermal Conductivity, 187
- Specific Heat, 188
- Thermal Destruction, 188
- Melting Points and Melts, 189
- Electrical and Magnetic Properties, 189
- Density and Specific Gravity, 190

7. OPTICAL PROPERTIES

- Luster, 194
- Chatoyancy and Asterism, 194
- Refraction of Light, 196
- Refractive Index Ranges, 197
- Influence of Composition on Refractive Indexes, 199
- Refractive Indexes and Color, 200
- Variation of Refractive Indexes with Wavelength, 201
- Dispersion, 201
- Refractive Indexes and Temperature, 201
- Optical Anomalies, 201

8. COLOR AND LUMINESCENCE

- Dichroism, 207
- Color Zoning, 207
- Emerald Color, 208
- Color Filters for Emerald, 217
- Aquamarine, Yellow Beryl, and Goshenite, 217
- Maxixe-Type Beryls, 220
- Color Filters for Aquamarines, 221
- Heliodor, 221
- Pink (Morganite) and Orange Beryls, 222
- Red Beryl or "Bixbite," 223
- Bazzite, 224
- Infrared Absorption in Beryl, 224
- Color Changes Induced by Heat, 224
- Heat-Treatment Methods, 227

- Color Changes Induced by Irradiation, 228
- Summary of Color Changes, 230
- Luminescence, 231

9. CRYSTALLOGRAPHY

- Origins of Crystallography, 236
- Axes and Symmetry, 237
- Faces and Forms, 240
 - Bravais-Miller Indexes and Symbols, 243
 - Pinacoid, 243
 - First Order Prism, 246
 - Second Order Prism, 247
 - Dihexagonal Prisms, 248
 - First Order Bipyramids, 250
 - Second Order Bipyramids, 252
 - Dihexagonal Bipyramids, 254
- Frequency and Predominance of Forms, 255
- Interfacial Angles, 258
- Twinning, 262
- Trapiche Emeralds, 262
- Etch Figures, 264
- Surface Growth Features, 268
- Polygonal Textures, 272
- "Shell" Crystals, 272
- Deformed Crystals, 275
- Record-Size Crystals, 275
- X-Ray Data on Beryl, 276

10. INCLUSIONS

- Historical Notes, 280
- Protogenetic Inclusions, 282
- Syngenetic Inclusions, 285
- Syngenetic Liquid Inclusions, 285
- Epigenetic Inclusions, 287
- Solid Inclusions, 287

11. ARTIFICIAL AND SYNTHETIC BERYLS

- Glass and Other Imitations, 292
- Composite Gems, 294
- Synthetic Gemstones Resembling Beryls, 295

CONTENTS

- Chronology of Beryl Synthesis, 295
 Simple Fusion Synthesis, 298
 Flux-Fusion Synthesis, 299
 Chatham Emeralds, 304
 Eppler Emeralds, 306
 Linares et al. Emeralds, 307
 Lefever et al. Emeralds, 307
 Zerfass Emeralds, 308
 Gilson Emeralds, 308
 Hydrothermal Synthesis, 313
 Lechleitner Emerald-Coated Beryl,
 316
 Linde Hydrothermal Synthesis,
 317
 Emelyanova et al. Syntheses, 321
 Bazzite Synthesis, 321
 Properties of Synthetic Emeralds, 321
12. CUTTING AND POLISHING BERYL
 Historical Review, 324
 Lapidary Features of Beryl, 326
 Selection of Rough According to
 Color, 327
 Immersion Fluids for Inspecting
 Rough, 328
 Inclusions in Cut Gems, 329
 Chatoyant Beryls, 330
 Lapidary Treatment for Cabochons,
 331
 Beryl Carvings, 332
 Faceted Gems, 332
 Proportions and Angles of Faceted
 Gems, 333
 Deviations from Recommended
 Angles and Proportions,
 335
 Polishing Laps and Agents, 336
13. BERYL DEPOSITS
 Volcanic, 339
 Red Beryl in Rhyolite, 339
 Early Magmatic, 339
 Beryl Disseminations in Granite,
 339
 Miarolitic and Schlieren Beryl
 Deposits, 339
 Late Magmatic, 342
 Granitic Pegmatites, 342
 Simple, Unzoned Pegmatites, 346
 Simple, Zoned Pegmatites, 346
 Complex, Zoned and Replaced
 Bodies, 348
 Metamorphic-Hydrothermal, 349
 Schist Type Beryl Deposits, 349
 Hydrothermal, 351
 Greisens, 351
 Carbonate Veins and Tactite
 Bodies, 353
 Alpine Clefts, 353
 Sedimentary Deposits, 354
- Part III**
BERYL LOCALITIES
14. WORLD SOURCES OF ORE AND
 GEM BERYL
 Afghanistan, 359
 Algeria, 361
 Angola, 361
 Antarctica, 361
 Argentina, 361
 Australia, 363
 Austria, 371
 Bolivia, 377
 Brazil, 378
 Bulgaria, 399
 Burma, 400
 Canada, 400
 Chile, 407
 Colombia, 407
 Czechoslovakia, 435
 Ecuador, 438
 Ethiopia, 438
 Finland, 438
 France, 439
 French Guiana, 442
 German Democratic Republic, 442

Contents

- Germany, 443
Ghana, 445
Greenland, 445
India, 445
Inner Mongolia, 455
Ireland (Eire), 456
Italy, 456
Ivory Coast, 462
Japan, 462
Kenya, 463
Madagascar (Malagasy Republic), 463
Malawi (Nyasaland), 480
Mexico, 480
Mongolian Republic, 481
Morocco (French Morocco), 482
Mozambique, 482
Nepal, 485
New Guinea, 485
Nigeria, 485
Northern Ireland, 485
Norway, 486
Pakistan (West), 488
Peru, 489
Peoples Republic of China, 489
Poland, 490
Portugal, 490
Republic of South Africa, 491
Romania, 500
Rwanda-Burundi, 500
Somali Republic, 500
South West Africa (Namibia), 501
Spain, 507
Sri Lanka (Ceylon), 507
Sudan, 508
Swaziland, 508
Surinam (Dutch Guiana), 508
Sweden, 508
Switzerland, 510
Tanzania (Tanganyika), 511
Turkey, 513
Uganda, 513
Union of Soviet Socialist Republics,
513
United Arab Republic (Egypt), 542
United Kingdom, 548
United States of America, 549
Yugoslavia, 601
Zaire (formerly Belgian Congo), 601
Zambia, 602
Zimbabwe (formerly Rhodesia), 603

APPENDIX

- The Names of Beryl, 611
Derivations of Names and Terms, 616

- GENERAL AND LOCALITY INDEX, 627
AUTHOR INDEX, 651

[The text on this page is extremely faint and illegible. It appears to be a multi-column document, possibly a ledger or a list of entries, with several columns of text separated by vertical lines. The content is too light to transcribe accurately.]

PREFACE

This book, the first comprehensive monograph on the emerald and other beryl family minerals, owes its inspiration to Joseph E. Pogue's splendid and still unsurpassed work, *The Turquoise*, first published in 1915 by the National Academy of Sciences, Washington, D.C. Pogue's book contains an enormous amount of information painstakingly assembled from widely scattered sources, treating "not only of its mineralogy and geology, but of its history, ethnology, and technology as well." Pogue gave as his objective the intent to "arouse a greater interest in a fascinating field—that concerned with precious stones in their relation to mankind."

This objective has also been adopted for the present work on beryl, but the scope has been necessarily expanded to include certain aspects of the beryl family which are absent in the case of turquoise. For example, beryls occur in transparent forms in a large variety of hues ranging from the rich greens of emerald to the delicate pale greens and blues of aquamarines and the yellows of golden beryls. All these varieties provide transparent gems, whereas turquoise only appears in slightly translucent forms. Additionally, beryls occur in large, handsome, glistening crystals which are much sought after by collectors and museums; turquoise crystals, on the other hand, are both extremely small and very rare. Lastly, unlike the turquoise, which contains only common elements, the beryls contain the rare and valuable element beryllium, the unique properties of which have caused more beryl to be mined in this century than in all others before.

The history of beryl is to be traced mainly through written records of emerald. In exploring this history, it becomes apparent that the preservation of such knowledge as we have was due largely to people's desires to acquire beautiful objects for

PREFACE

display or self-adornment, as a means of concentrating wealth, or, to a lesser extent, to take advantage of certain protective and therapeutic powers which the emerald and other beryls were thought to possess. Thus the largest part of the history of beryl is interwoven with mankind's cultural heritage, and to ignore this aspect by restricting oneself to a dry recital of beryl's scientific aspects is to ignore history itself. Furthermore, the scientific information we presently possess on the beryl has been accumulated only within the last three centuries, whereas the fund of cultural knowledge has been growing steadily since several thousand years B.C.

Accordingly, the present work first discusses the cultural history, the magical, medical, and astrological lore, the role of beryls as ornaments, and the arts of the lapidary. Part II presents the natural (and scientific) history of the beryl, including geology of deposits, mineralogical characters, crystallization, and synthesis of beryls. Part III surveys the world deposits and the ore, specimen, and gemstone beryls found in them. Because of the readily available literature on many of these deposits in the United States and Canada, major emphasis has been placed on descriptions of less well-known deposits in other parts of the world, especially where such deposits have been described in languages other than English.

At the end of the book appears a special appendix on the nomenclature of beryls, still a source of astonishment to me simply because of the sheer numbers of terms that were found during research of the literature.

The fifteen years I spent researching the beryls naturally resulted in a plethora of data which had to be sifted through in order to include only the most significant. Some important data may have been overlooked in this process, but I hope that the material included presents an adequate portrait of a mineral whose history is inextricably intertwined with that of mankind.

JOHN SINKANKAS
San Diego, California
October, 1981

ACKNOWLEDGMENTS

As may be expected in a work which has taken so many years to research and complete, the list of persons and organizations to whom I owe thanks is long, but principally I acknowledge the assistance of my wife, Marjorie Jane, who for many of those years sought out the references that were needed to insure that no important aspect of the subject was neglected. Her searches were encouraged and facilitated by Dr. Gustaf O. Arrhenius of Scripps Institution of Oceanography and by the librarians of that institution and of the University of California, San Diego main library.

The many authorities from whose works I have drawn information are indicated in the text and in the references which follow each chapter, while those whose illustrations I have used or based my own drawings upon are acknowledged in the captions.

Additionally, I wish to thank the following who in large or small measure have contributed to the completion of this work: Dr. Peter Bancroft, Fallbrook, CA; John F. Barlow, Appleton, WI; Allen Bassett, Paris, France; Gerhard Becker, Idar-Oberstein, Germany; British Museum (Natural History), London, especially librarians Mr. Atkins and Mrs. Brunton; Dr. Donald M. Burt, Tempe, AZ; Allan Caplan, New York, NY; Carroll Chatham, San Francisco, CA; David Eidahl, Fallbrook, CA; Peter G. Embrey, British Museum (Natural History); Dr. Eugene E. Foord, Denver, CO; Dr. Pierre Gilson, Campagne les Wardreques, Pas de Calais, France; Prof. Giorgio Graziani, Rome, Italy; Harry Winston, Inc., New York, NY; Dr. D. B. Hoover, Lakewood, CO; W. E. Johansen, Morgan Hill, CA; R. W. Jones, Phoenix, AZ; Carl Krotki, New York, NY; William Larson, Fallbrook, CA; Neil

ACKNOWLEDGMENTS

Letson; Dr. R. T. Liddicoat, Santa Monica, CA; Mary M. Murphy, New York, NY; Dr. Kurt Nassau, Bernardsville, NJ; Renato Pagano, Monfalcone, Italy; Roland Reed, El Cajon, CA; Marie and Roberto Sanchez, Fallbrook, CA; Dr. K. Schmetzer, Heidelberg, Germany; Josephine E. Scripps, Oceanside, CA; Milton Sklar, Oceanside, NY; Prof. Dr. H. A. Stalder, Berne, Switzerland; Hans Stern, Rio De Janeiro, Brazil; Dr. Helmut Trnek, Vienna, Austria; the United States Geological Survey, Washington, D.C. and its several branches and library at Reston, VA; Harold and Erica Van Pelt, Los Angeles, CA; Victoria and Albert Museum, London; Dr. Heinz Weininger, Leoben, Austria; David P. Wilber, Fallbrook, CA; Wendell E. Wilson, Tucson, AZ; and Miriam and Julius Zweibel, Woodmere, NY.

My special thanks are owing to William Larson, who furnished the beryl crystals from which I prepared most of the watercolor drawings shown in the color illustrations, and to John F. Barlow, who sent me his superb Utah red beryl to depict in the same manner.

PART

I

HISTORY AND LORE

That the Scarcity, the Lustre and the Preciousness of Gems have made them in all ages to be reckon'd among the finest and choicest of Nature's Productions, is generally granted.

R. BOYLE, *Origine & Virtues of Gems*, 1672

The following information is being provided to you for your information only. It is not intended to constitute an offer of insurance or any other financial product. The information is provided for your information only and should not be relied upon as a basis for any investment decision.

PART I

THE HISTORY AND FORE

The following information is being provided to you for your information only. It is not intended to constitute an offer of insurance or any other financial product. The information is provided for your information only and should not be relied upon as a basis for any investment decision.

This document is not intended to constitute an offer of insurance or any other financial product. The information is provided for your information only and should not be relied upon as a basis for any investment decision.

CHAPTER

I

EMERALD AND BERYL IN ANTIQUITY

ALTHOUGH ordinary beryl is the principal ore of the element beryllium, the mineral is far better known as the source of beautiful colored gems produced from clear specimens of emerald, aquamarine, and other colored varieties. Colors range from the rich green of emerald, through many tints of green, blue, and yellow, and include rich red and even a completely colorless gem known as goshenite. Emerald and other gem beryls have been known to mankind far beyond the bounds of recorded history, and it is impossible to say where or when the species was first recognized as a distinct mineral and its colored varieties put to decorative use. If the mica deposits of India were known tens of centuries ago, which seems reasonable since they form distinctive outcrops which can scarcely fail to attract attention, then it is also possible that the paler varieties of beryl that accompany the mica could have been discovered as well. And if, as suggested by some ethnologists, the original home of mankind is India, the first use of beryl may have been very early indeed. The deposits which produce mica in India also produce some beryl even today, including crystals containing clear gem areas.

Assuming prehistoric men and women made their way across the narrow straits separating the island of Ceylon from the Indian mainland, the gravels of that island, known since antiquity for producing gemstone pebbles, must also have yielded up to them pebbles of aquamarine, a gemstone still found there today. Because beryl is also known in Mongolia, the Asiatic portions of the USSR, Japan, and elsewhere in Asia, it is likely that crystals of beryl have long been picked up as attractive curiosities, if not cut and polished into gems.

HISTORY AND LORE

However, while it is possible that beryl was recognized early in various parts of Asia, it is not until the settlement of the Mediterranean regions and the development of advanced cultures along its shores that written records preserved for us definite knowledge of the beryl, more especially the emerald.

EMERALD IN ANCIENT EGYPT

The first reliable accounts of emerald are found in Egyptian records, but exactly when Egypt's emerald deposits were first exploited is still a subject of controversy. The deposits are located in a bleak desert, far to the southeast of Cairo, and the earliest date ventured for their exploitation is given as about 3500 B.C. by H. P. Little.¹ Little had studied a translation of the oldest extant Egyptian manuscript, entitled "The Instruction of Ptah-Hotep," and concluded from a sentence therein that the emerald was known at least by Ptah-Hotep's time. However, Little hastened to add that the term for emerald used in the manuscript may not have been applied to the mineral we now know as beryl.

Nearly the same date for the earliest knowledge of beryl in Egypt, namely 3400 B.C., was given by S. H. Ball in two papers on the history of gemstone mining and commerce in antiquity.^{2,3} According to Ball, the emerald mines were already being worked by the 12th Dynasty, or in the period 2000–1788 B.C. The love of wealthy Egyptians for jewels and the many decorative uses to which gemstones were put on large and small objects alike resulted in a thriving industry devoted to the recovery and trading of precious metals and gemstones. Ball noted that "from approximately 3500 B.C. to about 200 B.C., Egypt, drawing on its turquoise, emerald, olivine [peridot], and semi-precious stone mines, was the world's most important gem producer."³

In a later work, Ball⁴ also noted that "emerald and beryl appear first commonly in the jewelry of rich Egyptians in the 12th Dynasty . . . but C. M. Firth found at Dakka on the Nile beryl beads in several predynastic graves." He further remarked that tools discovered in the emerald mines, to which a date can be fixed with certainty, were from the reign of Sesortis II in the 12th Dynasty.

On the other hand, Oskar Schneider,⁵ the German archeologist and Egyptologist, searched the literature for references to early knowledge of this gemstone and concluded that "the Egyptian emerald was already being mined and used in personal ornament and amulets by at least the 18th Dynasty," or about 1500 B.C., a date much later than that proposed by Ball.

The problem of dating is complicated by uncertainties attending the use of ancient terms for emerald. Apparently the Egyptian *mafek* and the Greek *smaragdus* (the latter believed to be derived from a similar term in Sanskrit) were both applied indiscriminately to any greenish stone that either was emerald or looked like emerald. It is this ambiguity which is the crux of the problem. Furthermore, as A.

Emerald and Beryl in Antiquity

Lucas,⁶ an authority on the nature and uses of ancient Egyptian materials, was careful to point out, many archeologists made the same mistake, as evidenced by collections in which many greenish stones were labeled "emerald" when they were not, or described by the even vaguer appellation "mother-of-emerald."

Lucas also noted that extensive workings in the Egyptian mines are "probably of Graeco-Roman date age, and there is no evidence that the mines were worked in the reign of Amenophis III as stated by Wilkinson,"⁷ and "so far as can be ascertained, beryl was never used in ancient Egypt before Ptolemaic times [*i.e.*, prior to 332 B.C.] and all the stones of earlier date called beryl that have been examined by the author have been found not to be beryl." Several misidentifications were noted by Lucas, showing that some jewelry stones and scarabs labeled as emerald were made from green feldspar or some other greenish mineral.

The opinion of Lucas, whose qualifications as a chemist in the employ of the Department of Antiquities at Cairo seem beyond question, casts justifiable doubt upon the extremely early dates assigned by Ball, Schneider, and others. It is far more certain that the mines were vigorously worked during the Graeco-Roman periods of Mediterranean domination, or roughly from 330 B.C. onward, and more or less continuously thereafter up to about the year 1237 A.D., during the reign of Sultan al-Kaamel. Desultory exploration continued until approximately 1740 A.D., after which the mines were totally abandoned and lapsed into an obscurity so profound that they were considered "lost." Indeed some people believed them never to have existed at all.

It was not until the French explorer Frédéric Cailliaud rediscovered the mines in 1816 that their existence was reconfirmed.⁸ An excellent chronology of events concerning these mines appears in Schneider.⁵ The latest scientific-geological investigation of these deposits and associated workings in the Wadi Sikait region was made in 1961 by Basta and Zaki, who provided detailed geological and mineralogical information but also commented discouragingly on the feasibility of working the mines for profit.⁹

Until the 16th century, when the remarkable gems from Colombia gained widespread notice, the Egyptian deposits were the only known source of emeralds. The Egyptian mines were worked to satisfy a vigorous demand despite great natural hardships, poor working conditions, problems in logistic support, and the difficulty of recovering emeralds from hard rock without fracturing the crystals. Compared to Colombian stones, those of Egypt were murky, filled with disfiguring inclusions and flaws, generally quite small, and frequently of inferior color. Possibly it was the unique grass-green color of emeralds in general, coupled with a considerable fund of magical and curative powers these gems were deemed to possess, that encouraged mining despite meager yields and the appalling conditions under which they were recovered. The mines must have been profitable, however, because the



Fig. 1-1 *Top*: F. Cailliaud's rendering of the view across Wadi Sikait looking north, showing numerous buildings of the emerald miners, with the principal and lesser temples to the right. Plate 3 of *Travels in the Oasis of Thebes* (London, 1822). *Bottom*: A modern photograph, looking northwest from near the principal temple, taken in March 1980 by Dr. Peter Bancroft.



Fig. 1-2 Top: F. Cailliaud's rendering of the principal temple at Wadi Sikait. Plate 5 of *Travels in the Oasis of Thebes* (London, 1822). Since then much of the temple has disintegrated, as shown in the bottom photograph, taken by Dr. Peter Bancroft in March 1980.

HISTORY AND LORE

stones found their way via trade channels throughout the civilized world of the Mediterranean, Near East, and India.

As reported by modern visitors, the Egyptian mines consist of an astounding network of inclines, tunnels, and chambers, accompanied by ruins of elaborate housekeeping structures on the surface, suggesting that substantial quantities of stones must have been produced. There are no early production statistics, but the lure of profits led to several modern attempts to reopen the mines, the most ambitious being that of Streeter & Company, the firm of London jewelers. In 1899 they recovered only extremely small quantities of gem material and were soon forced to abandon mining. The progress of this campaign was described by D. A. MacAlister, the geologist member of the expedition.¹⁰ Later attempts by other parties were equally unsuccessful, which suggests that the richest portions of the deposits had been mined out or that the deposits were never very productive but could be made to pay in ancient times through use of slave labor.

All evidence strongly suggests that the ancient Egyptian emeralds were small and suited only for shaping into beads or rudely polished geometric shapes to be inset into precious metal jewelry and ornamental or symbolic objects. It is unlikely that many reasonably flawless and richly colored gems were ever produced in weights beyond several carats. It is the small gemstones that tend to disappear with the passage of time, or at least become indistinguishable from more modern emeralds, and the larger, finer stones that are preserved.

But if so many were mined, where have they gone? In today's collections of antiquities, there seems to be a paucity of emeralds of *any* description that can be surely given an Egyptian origin. For example, in a catalog of Greek, Etruscan, and Roman jewelry of the British Museum,¹¹ F. H. Marshall noted that "in spite of the popularity of this stone in ancient times, it is not often found in antique jewellery." He mentions only two pieces in the collection set with undoubted Egyptian emeralds, and "it seems certain, that the term *smaragdus*, which occurs often in descriptions of ancient jewellery, must have also included the plasma [a dark green quartz] which is so common in Roman times."

Careless application of the term *emerald* to any green gem without the benefit of a mineralogical identification led to overestimates of quantity, G. Maspero being among those guilty of this mistake. In a work on Egyptian archeology,¹² he enthusiastically describes a "profusion" of small figurines in precious stones, including emerald, that were found during his explorations among the tombs of Egypt, as well as large scarabs of emerald that could be dated to the First Theban Empire (about 2160 B.C.). All of these, however, turned out to be some other green stones. Other evidence for the scarcity of Egyptian emeralds even in authentic ancient jewelry is noted by Gregoriotti,¹³ who stated that this gemstone "is rarely found in Egyptian jewelry from tombs, although a small number has been found on mum-

Emerald and Beryl in Antiquity

mies." Vilimkova's study of ancient Egyptian jewelry¹⁴ makes no mention at all of emerald, and its numerous color plates show the pieces to be devoid of emeralds. As will be shown later, emerald was not an important stone in engraved gems during Graeco-Roman times.

The conclusions to be reached from this discussion are several. First, one must conclude that large quantities of stones were not produced from the Egyptian mines, and that most of those that were produced were small and mediocre in quality, with very few specimens of importance. Secondly, such small stones probably disappeared into less valuable forms of jewelry that have been lost in the passage of time. It is also possible that much of the poor grade of emerald was absorbed in amulets and in medicines, as will be discussed in Chapter 3. Amulets usually vanish into the same graves as their owners, and gems used in crushed form as medicines are utterly wasted. Because the belief in the magical and medicinal virtues of precious stones has always been most firm in India, possibly much of the Egyptian emerald found its way to that country, to which we will now turn.

EMERALD AND BERYL IN ANCIENT INDIA

Knowledge and use of beryl and emerald in India may be even older than in ancient Egypt, but it lacks convincing documentation. According to S. M. Tagore, who prepared a monumental study of gemstones with special reference to their position in Indian culture,¹⁵ "the emerald has been used amongst the Hindus from time immemorial," being held so high in esteem that "even any other flawless gem assuming the form of an emerald is highly prized." Tagore devoted a number of pages to discussions of emerald and beryl, quoting from ancient Sanskrit sources and attesting to the rich fund of gemological knowledge possessed by the ancient inhabitants.

G. C. M. Birdwood, in a monograph on Indian industrial arts,¹⁶ mentions references to the emerald in ancient writings, noting especially the amulet or talisman composed of nine gems known as the *nava-ratna* or *nao-ratan*, of which one stone was the emerald. Tagore and Birdwood also mention the *vedas*, the most ancient of Hindu sacred writings, in which legends, deities, rituals, and other matters important to the ordered conduct of life, religion, and profession were set forth for guidance. The *vedas* contain frequent references to precious stones, including the beryl and emerald. The most important of these with respect to the lore of gems (matters still of grave interest to modern Indians) is the *Rig-Veda*, which, like other *vedas* is dated to the so-called Vedic Period of about 1500 to 1000 B.C.

Inasmuch as the *vedas* speak of precious stones as if they were well known at the time of writing, it seems that knowledge of the emerald must antedate the Vedic Period, or must have originated some time before 1500 B.C. This provides a fair correspondence to the period in Egypt when the mines were flourishing. On the

HISTORY AND LORE



Fig. 1-3 The "Necklace of Many Gems" as shown on a title page of S. Tagore's *Mani Mālā*, (Calcutta, 1879). The gems are diamond (top left), then ruby, cat's-eye, pearl, zircon, coral, emerald, topaz, sapphire, chrysoberyl, garnet, carnelian, quartz, and rock crystal (top right).

Emerald and Beryl in Antiquity

other hand, it cannot be unequivocally stated that all early Indian emerald came from Egypt, as witness the discovery in 1944 in Rajasthan of important emerald deposits of the same type as the Egyptian. This discovery suggests the possibility that this region could have supplied these gems in an earlier time. Furthermore, aquamarines have been found in several widely scattered areas in India in mica deposits and elsewhere. Aquamarine is regularly found in the gem gravels of Ceylon, and its transport to India many centuries ago would have posed no problem. In fact, Ball's chronology of gem mining³ gives beryls as being produced in India by 400 B.C.

Regardless of where the inhabitants of India obtained their first beryls, it now appears that a brisk trade in emeralds developed at the same time that the ancient mines in Egypt were in operation. H. C. Beck described a hoard of beads found in the ruins of the city of Taxila in the Punjab, among which were beads of beryl.¹⁷ He suggested an age for the hoard of between 700 B.C. and 500 A.D., which is even earlier than the age given by Ball. Strabo, the celebrated Greek geographer who lived between 63 B.C. and 19 A.D., and to whom we owe much of our knowledge of the ancient world, visited India and remarked on the extensive use of beryls and other gemstones in the ornamentation of drinking vessels and other small objects belonging to the wealthy. Indian interest in gemstones continued unabated from this early period onward, as evidenced by the prominent display of precious stones in personal ornaments and small implements, vessels, and costume accessories. Birdwood¹⁶ provided a number of illustrations of such objects from relatively recent periods, as did B. J. Bhushan¹⁸ in a richly illustrated monograph on Indian jewelry. However, the fullest and best treatment of native jewelry and ornament is that by T. H. Hendley¹⁹ in which color plates of considerable beauty, many depicting emeralds, are a prominent feature (see figure 4-7).

BERYL IN THE ANCIENT EAST

Aquamarine and other pale-colored varieties of beryl, but not emerald, occur in Japan, Mongolia, and a few other places in the Far East, but their use in antiquity appears to have been very limited. There is no evidence that the emerald was used in the Orient prior to the Christian Era, and only infrequent mentions of it, largely speculative, are to be found in works by students of Chinese or Japanese cultural history. In the past century, the Chinese have used aquamarine and other pale beryls for small carvings as snuff bottles and figurines, but the sources of the mineral are rarely mentioned. However, the use of elongated sculptured prisms of stone for personal documentary seals suggests the use of the prismatic crystals of aquamarine that are known to occur in Mongolia.

In his study of numerous materials used in ancient Persia and China, B. Laufer²⁰ states that "the emerald appears to be first mentioned in the *Co k'en lu*,

HISTORY AND LORE

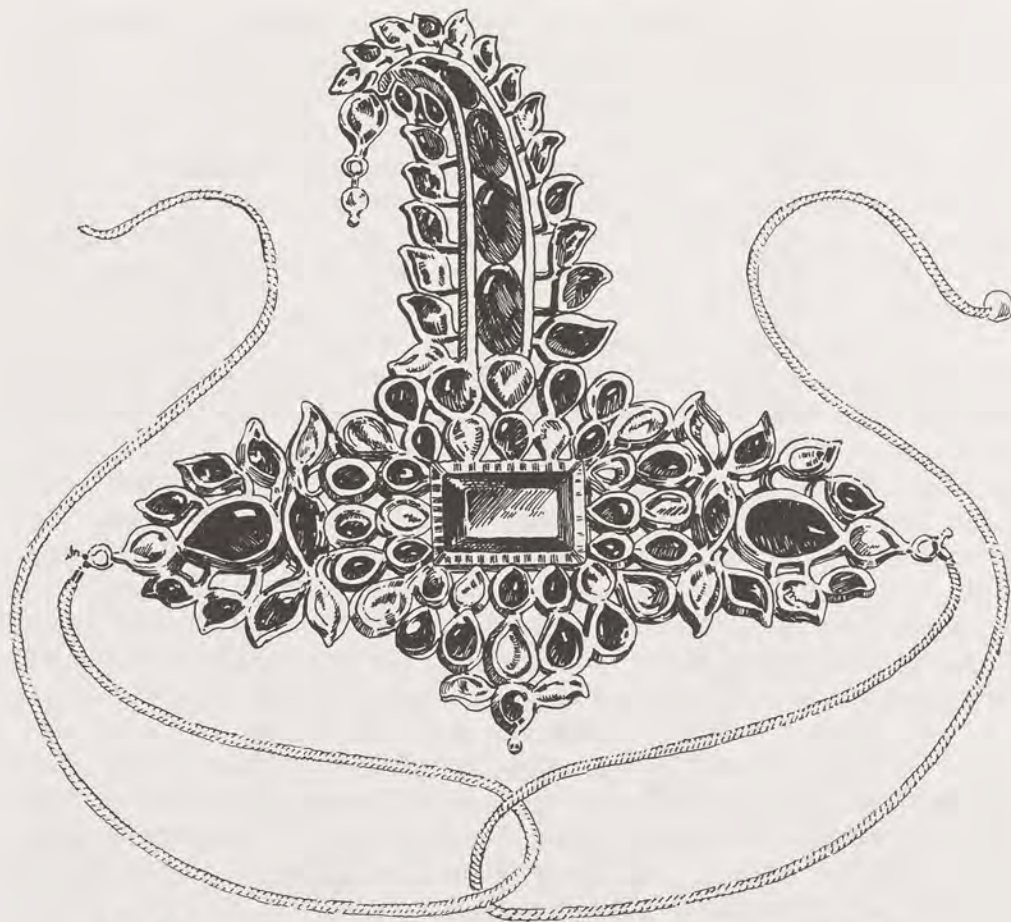

Fig. 1-4 Fine example of the Mogul jeweler's art in the form of a gold aigrette, set with cabochon emeralds and rubies, and meant to be fastened to the turban by means of the ties shown. After an illustration in E. Jannettaz et al. *Diamants et Pierres Precieuses* (Paris, 1881).

written in 1366," while in his work on jade²¹ he noted that emeralds "were unknown to the Chinese in the Han period" (206 B.C.–221 A.D.). Furthermore, he states that "the Chinese made its acquaintance only in recent times from India and in the 'Imperial Dictionary of Four Languages' it is called *tsie-mu-lu* (Manchu *niowarimbu wehe* 'greenish stone') corresponding to Tibetan *mar-gad* and Mongol *markat*, both the latter derived from Sanskrit *marakata*, which itself is a loan word from Greek *smaragdos*; to the same group belongs the Persian *zumurrud*, to which the Chinese word seems to be directly traceable."

Emerald and Beryl in Antiquity

In their compendium of minerals and stones used in Chinese medicine, taken from a Chinese work of 1597 entitled *Pen Ts'ao Kang Mu*, Read and Pak²² mention only the "oriental topaz" or "gold beryl" in a single definition, suggesting that no clear distinction was then drawn between these two minerals. In another place, Laufer²¹ mentions that the Emir Suleiman of the Kingdom of the Caliphs sent a "flask of jade ornamented with jewels" to an ambassador of China in 716 A.D. If this is true, it suggests that the jeweled jades of the Moguls of Iran-India—and the small polished gems used to decorate them, namely diamonds, rubies and emeralds—were known at a very early time to the Chinese, thus pushing back even farther the date by which the Chinese became acquainted with the emerald.

While beryl has been found in Japan, Hong Kong, Malaya, and in one place in Burma, none of the deposits are important, so it is not surprising that beryl is a mineral only lately known to the Far East. The absence of beryls is specifically mentioned by the French gem dealer and traveler Jean-Baptiste Tavernier (1605–1689), who traveled to India and brought back gems of great value. The latest edition of his travels, edited by Crooke,²³ states that:

As for the emerald, it is an ancient error of many people to suppose that it was originally found in the East, and the majority of jewellers and artisans, when they see an emerald of high colour inclining to black, are still accustomed to call it an oriental emerald, in which they are mistaken. I confess I have not been able to find the places in our Continent from whence these kinds of stones are obtained. But I am assured that the East has never produced them, either on the mainland or on the islands; and having made a strict inquiry during all my journeys, no one has been able to indicate any place in Asia where they are found.

As given in a footnote by Crooke, "Tavernier appears to have been wholly unaware of the true source of the emerald in early times. Although common beryl is abundant in India, the emerald, though highly-esteemed, and well known at a very remote epoch, does not appear to have been found there." Ignorant of the fact that emeralds came from Egypt, Tavernier went on to suggest that some Colombian emeralds were shipped from South America to Spanish colonies in the Philippines and then shipped westward to the Far East and ultimately to Europe, wherein they were mislabeled "oriental emeralds."

BERYL IN GRAECO-ROMAN TIMES

One of the earliest mentions of emerald by someone who could claim expertise in mineralogy appears in the *Peri Lithon* ("Of Stones"), written by Theophrastus (ca. 372–287 B.C.), a disciple of Aristotle, and preserved for us only in a fragment of a larger work. Theophrastus described emerald and its curious powers, and it is



Fig. 1-5 Portrait of Jean-Baptiste Tavernier from *Beschreibung der Sechs Reisen*, a German translation of the original French edition, published in Genff in 1681.

Emerald and Beryl in Antiquity

he who is responsible for the oft-repeated claim that gazing upon an emerald strengthens the eyesight.

The first English translation of *Peri Lithon* by John Hill²⁴ is now superseded by two modern translations which clarify obscure points and introduce new information. The first of these, by E. R. Caley and J. F. C. Richards,²⁵ returns to the fundamental question which must always be asked in taking the words of ancient authorities at face value, that is, is the emerald (or beryl) of antiquity the same mineral that we know today? Caley and Richards suggest that "the statements of Theophrastus make it doubtful whether true emerald was even known to him, and there appears no certain evidence on other grounds of its use among the Greeks." This view is supported by D. E. Eichholz²⁶ in the second modern translation of Theophrastus. Both translations comment on the obvious impossibility of certain large monuments of the ancients being made of *smaragdoi* (emeralds), as claimed by Theophrastus, and thus cast doubt on his real knowledge of the true emerald.

To some degree this doubt is confirmed by R. A. Higgins, who wrote authoritatively on ancient Greek and Roman jewelry,²⁷ noting that in the earliest periods gemstones and enamels were very sparingly used, the preference in ornaments being for gold alone. However, during the Hellenistic period "inlaying [with gems] was lavishly practised" while "in the second and first centuries we also find emeralds, amethysts, plasma and pearls." Despite these doubts about Theophrastus's testimony, well-authenticated pieces employing engraved gems and dating from well before his time confirm the fact that emeralds and beryls were known during that period.

During the past several centuries, Graeco-Roman engraved gems have received much careful study, primarily as archeological artifacts, but careful and accurate mineralogical identification of the stones and minerals used in them is a relatively recent development. In regard to the emerald, for example, C. W. King, the noted English expert on engraved gems, stated that in his experience gems made from beryl antedated those made from emerald, usually being fine works of the Greek school.²⁸ In a catalog of the engraved gems in the Fitzwilliam Museum, Cambridge, J. H. Middleton²⁹ declared:

Though the emerald was rarely employed for the engraved gems of the Greeks, yet it was often used, chiefly for pendants, to decorate gold jewellery. Small emeralds frequently occur in the form of necklace beads, mixed with beads of amethyst and rock crystals, in many cases these emeralds are not cut; the natural hexagonal form of the crystal is preserved, and nothing is done to the gem except that a hole is drilled through its axis for the insertion of the gold wire which holds it. (*See figure 1-6.*)

In his monumental work on engraved gems, A. Furtwängler³⁰ discussed the use of emerald and beryl and cited several examples of famous intaglios cut from

HISTORY AND LORE



Fig. 1-6 Drawing of a gold, pearl, and emerald necklace found at Scafati, Italy, dating from the 1st century B.C. to the 1st century A.D. The emeralds are merely polished prism sections of Egyptian crystals, alternating with gold links and pearls. Total length 38.8 cm (15 $\frac{5}{16}$ in). Collection of the National Museum of Naples. After plate 152, R. Siviero, *Jewelry and Amber of Italy* (New York: McGraw Hill Book Co., 1959).

them, but he also noted that while the emerald was much used for jewelry gems it was seldom engraved, and that the beryl did not come into common use for engraved gems until the time of the Romans. These opinions are repeated by G. M. A. Richter in her work on Greek and Etruscan engraved gems.³¹ She furnishes a color photograph of the more precious gems in which appears a small greenish-blue intaglio of aquamarine and a light green intaglio of emerald.

The scarcity of beryls among the Greeks is emphasized by the total lack of mention of either emerald or aquamarine as gem materials in the large work on Greek engraved gems by J. Boardman.³² Nevertheless, it is clear from the statements of others that beryls were known to the Greeks and one cannot claim that Theophrastus was totally ignorant of the true emerald.

Emerald and Beryl in Antiquity



Fig. 1-7 Antique intaglio gems. Left: Neptune in aquamarine; right: the head of an unidentified woman in emerald. The actual gems are only a fraction of the size shown here. From P. S. Bartoli's engravings in *Museum Odescalcum* (Rome, 1747), the catalog of the collection of antiquities then owned by Livio, Duke of Bracciano and nephew of Pope Innocent XI.

PLINY'S NATURAL HISTORY

Nearly at the height of its domination of the civilized world, Rome produced one of its most famous citizens, Caius Plinius Secundus, or Pliny the Elder (23–79 A.D.), a highly disciplined and learned individual. He conceived the idea of compiling in one book everything that was known about nature and its productions, and the final result was his famous *Natural History*. It contains information from more than 2,000 sources, many of them ancient and now lost, so that our knowledge of them is preserved only in this encyclopedia. Since the original Latin version, over 250 editions have appeared in many languages, but only three complete editions in English exist, the first by Philemon Holland,³³ first published in 1601, the second by J. Bostock and H. T. Riley,³⁴ published in 1855–57, and the third the Loeb Classical Library edition³⁵ of ten volumes, published from 1938 to 1962, of which the last volume, comprising books 36–37 and translated by D. E. Eichholz, is of interest here. The most detailed study of Pliny's gemstone references, including emerald and beryl, is that of S. H. Ball.⁴

HISTORY AND LORE

THE
HISTORIE
OF THE WORLD:

Commonly called,
THE NATVRALL HISTORIE OF
C. PLINIVS SECVNDVS.

*Translated into English by PHILEMON HOLLAND
Doctor of Physicke.*

The first Tome.



LONDON,

Printed by *Adam Islip*, and are to be sold by *Iohn
Grismond*, in *Ivy-lane* at the Signe of
the *GUN*. 1635.

Fig. 1-8 Title page of a later printing of Philemon Holland's translation of Pliny's *Natural History*, the first printing being in London, 1601. His was the first English translation of this enormously important compilation, assembled by Pliny by 79 A.D., the year of his death.

Emerald and Beryl in Antiquity

The emerald is treated by Pliny in chapter 16 of book 37. However, because he depended on information garnered from secondhand sources, it raises more questions than it answers regarding the identification and sources of the minerals. He indiscriminately lumps them all together under the term *smaragdus* ("emerald"), of which he describes no less than twelve kinds. Obviously all of them cannot be beryl because he includes among them the enormous columns and other architectural monuments previously mentioned by Theophrastus, from whose *Peri Lithon* he drew information.

Of the twelve kinds, the best, according to Pliny, is the Scythian emerald, from a supposed source in an ancient land that once extended an indefinite distance north and northeast of the Black Sea and east of the Aral Sea. The entire region is now in the USSR, and the discovery of true emeralds in 1830 in the Ural Mountains, spurred speculation about these deposits being the source of Pliny's Scythian emeralds. Eichholz³⁵ clings to this view, but it is not shared by others. Despite intensive exploration of the deposits, no trace has ever been found of prehistoric workings or the presence of artifacts that would confirm ancient mining activity.

The same lack of archaeological evidence haunts the second most favored emeralds of Pliny, those from Bactria. Eichholz suggests the Bactrian emerald was a garbled paraphrase of Theophrastus's, "alluding to one of the blue stones used by the Persians in inlay-work, probably the blue turquoise," and for this reason "the Bactrian *smaragdus* is therefore a fiction." However, it is interesting to note that splendid aquamarines, among other gemstones, have recently been found in northeastern Afghanistan, whose territory coincides more or less with that encompassed by ancient Bactria.

Pliny's third-ranking emerald is identified as found around Coptos, or the city now known as Qift on the Nile River north of Thebes. No emeralds exist here, but ancient Coptos was the terminal of a caravan route to the Red Sea which passed through the emerald mine district, and it could have been a trading center for these stones. Probably these mines, in the Wadi and Gebel Sikait district, correspond to those labeled "Ethiopian" by Pliny. In chapter 18, Pliny cites a King Juba who gave the location of the mines as "three days journey from Coptos," according to Holland's translation, or "twenty-five days" according to Bostock and Riley as well as Eichholz. The latter time is far more reasonable considering it is approximately 180 miles (285 km) from Coptos to the mines.

All other *smaragdi* described by Pliny are clearly materials other than emerald. In some instances they seem to be greenish copper minerals, massive quartz varieties, or even green monumental stones. Only one other mineral, called *limoniatis* by Pliny, is classed as a possible emerald by Ball.⁴

Following his discussion of emerald and emerald-like stones, Pliny describes the *beryllus* and its varieties. Ball interprets these kinds of beryl as aquamarine,

HISTORY AND LORE

golden beryl (called "chrysoberyl" by Pliny), the chrysoprase (of Pliny), the *hyacinthozontes* (a deep blue beryl), the *aeroides* (a pale blue beryl) and the common beryl. Pliny observed that many persons considered the *berylli* to be of the same nature as *smaragdi*, or at least very similar, and remarked that beryls came from India, rarely from elsewhere, and that they are cut with six angles or "cut by skilled craftsmen to a smooth hexagonal shape." This suggests that Pliny was aware of the usual hexagonal prismatic shapes assumed by beryl crystals.⁴

In regard to lapidary treatment of beryls, Pliny contradicts himself by stating that "in the case . . . of the stones of Scythia and Egypt, their hardness is such, that it would be quite impossible to penetrate them." (Despite Pliny's statement, Egyptian emerald was cut with little more difficulty than the many varieties of quartz that were used to make engraved gems.) In the same passage he says, "It was universally agreed upon among mankind in respect to these stones, and to forbid their surface to be engraved," the reason given that when left unengraved they benefit the eyesight.³⁴ If there is any truth in this remark, it could possibly account for the general scarcity of engraved emerald gems as noted above. Pliny also noted that Alexander the Great allowed only the celebrated gem engraver, Pyrgoteles, the privilege of copying his visage on gems and then only when made of emerald.

In her treatise on Roman engraved gems, G. M. A. Richter³⁶ described 783 specimens, of which only ten could be identified as beryl and only two of those as emerald. The absence of this mineral in engraved gems in the Roman period is puzzling because it was known that supplies of emerald were forthcoming from the Egyptian mines, and one would imagine that so precious a material would seem eminently suited for the highly prized engraved gems which were in demand by the wealthy. As previously suggested, however, it may be that extremely few of the crystals were suitable for such purpose, and any gem engraver would be sure to look askance at a raw material filled with dark inclusions and fissures which could be exposed during engraving, resulting in the loss of detail as well as unsightly areas.

The availability of Egyptian emeralds in the Roman period is shown by examples of emerald-set jewelry in R. Siviero's catalog³⁷ of the collection of jewelry in the National Museum in Naples. A number of pieces contain crudely shaped and polished hexagonal crystal sections, some drilled parallel with the prism faces as a means of fastening them in their mounts, as shown in Figure 1-6. Most of the museum pieces were recovered from the ruins of Pompeii and Herculaneum, cities not far from Naples that were buried in the ashes of the great eruption of Mount Vesuvius in 79 A.D. Pliny himself, impelled by scientific curiosity rather than regard for personal safety, insisted on viewing the eruption close at hand and thereby lost his life. Siviero's catalog clearly shows the poor quality of the emeralds, by present-day standards, and supports the view previously maintained that extremely few good-quality emeralds ever came from the Egyptian mines.

Emerald and Beryl in Antiquity

After the Roman Empire crumbled in the 4th century A.D., much of the knowledge of gemstones, that was passed along during the Middle Ages continued to lean heavily on Pliny, and little new information was added. Excellent discussions of writings that appeared in this era are to be found in the monumental works of L. Thorndike³⁸ and in the discussion of the development of the geological sciences by F. D. Adams.³⁹

EARLY USE OF BERYL IN THE AMERICAS

At the time of the Spanish Conquest of the New World in the 16th century, emeralds were already well known there and employed in ornament and objects of ceremony. According to Ball,⁴ "Colombian emerald was so common in Peru that for at least two centuries after the Conquest it was known as Peruvian emerald." In the same reference, Ball gives the date of 1000 A.D. as that by which emerald was in the hands of the natives and "hence Muzo or other Colombian mines were probably already opened up." He also recorded the use of beryl by North American Indians and by the aborigines of Brazil.

G. F. Kunz⁴⁰ describes a labret made from an oval beryl 3.5 inches (89 mm) long and one inch (25 mm) thick that was found among artifacts of the Botocundo Indians of Brazil. Other pre-Columbian finds of emerald and beryl confirm that these minerals were known to the Indians well before the discovery of America. Furthermore, Colombian emeralds were not only traded to other South American countries but also into Panama and as far north as Mexico. Important finds of emeralds in grave sites of Coclé, Panama, are described by S. K. Lothrop.⁴¹

In the pre-Columbian era, only the emerald deposits of Colombia were systematically worked, no other deposits being known in the entire Western Hemisphere despite the presence of enormous resources of alluvial beryls in the interior of Brazil. These were apparently not known to its natives or, if known, ignored. As remarked by Ball,⁴ a few beryls were put to ornamental use by Indians in Idaho and in North Carolina, but nowhere was this mineral specifically sought out except in Colombia. More on Colombian emeralds appears in Chapter 2.

Literature Cited

1. Little, H. P. 1917. An ancient reference to the emerald. *Science* 45, no. 1160, pp. 291-2.
2. Ball, S. H. 1928. Egyptian gem stones of the pre-Ptolemaic days. *Jewelers' Circular* 96 (Feb. 23):147-57.
3. ———. 1931. Historical notes on gem mining. *Economic Geology* 26:681-738.
4. ———. 1950. *A Roman Book on Precious Stones*. Los Angeles: Gemological Institute of America. 338 pp.
5. Schneider, O. 1892. Der aegyptische Smaragd . . . nebst einer vergleichenden mineralogischen Untersuchung der Smaragde von Alexandrien, vom Gebel Sabara und vom Ural. *Zeitschrift für Ethnologie* 24:41-100.
6. Lucas, A. 1934. *Ancient Egyptian Materials and Industries*. 2nd ed. London: Edward Arnold & Co. 447 pp.
7. Wilkinson, J. G. 1890. *The Ancient Egyptians*. Vol. 2, p. 237; cited in Lucas, above.
8. Cailliaud, F. 1821. *Voyage à l'Oasis de Thèbes . . . fait pendant les années 1815-1816, 1817-1818*. 2 vol. Paris: Imprimerie Royale. English summary: *Travels in the Oasis of Thebes . . .*, edited by E.

HISTORY AND LORE

- F. Jomard. London: Sir Richard Phillips & Co., 1822. 66 pp.
9. Basta, E. Z., and Zaki, M. 1966. Geology and mineralisation of Wadi Sikait area, South-eastern Desert. *Journal of Geology of the United Arab Republic* 5:1-38.
 10. MacAlister, D. A. 1900. The emerald mines of northern Etbai. *Geographical Journal* (London) 16:537-49.
 11. Marshall, F. H. 1969. *Catalogue of the Jewellery, Greek, Etruscan, and Roman, in the Departments of Antiquities, British Museum*. London: The Trustees of the British Museum. 400 pp.
 12. Maspero, G. 1887. *L'Archeologie Egyptienne*. Paris. pp. 161, 234-6.
 13. Gregorietti, G. 1969. *Jewelry Through the Ages*. New York: American Heritage. 319 pp.
 14. Vilimkova, M. 1969. *Egyptian Jewellery*. London: Paul Hamlyn. 142 pp.
 15. Tagore, S. M. 1879. *Mani Málá, or a Treatise on Gems*. 2 vols. Calcutta. Stanhope Press. 1046 pp.
 16. Birdwood, G. C. M. 1880. *The Industrial Arts of India*. London: Chapman and Hall. 344 pp.
 17. Beck, H. C. 1941. The beads from Taxila. *Memoirs of the Archaeological Survey of India*, no. 65. 66 pp.
 18. Bhushan, B. J. 1955. *Indian Jewellery*. Bombay: D. B. Taraporevala Sons. 168 pp.
 19. Hendley, T. H. 1906-09. *Indian Jewellery*. London: Journal of Indian Art. 189 pp., 167 pls.
 20. Laufer, B. 1919. *Sino-Iranica: Chinese Contributions to the History of Civilization in Ancient Iran*. Field Museum of Natural History Publication 201, Anthropological Series, vol. 15, no. 3. Chicago: Field Museum of Natural History. pp. 185-630.
 21. ———. 1912. *Jade: A Study in Chinese Archaeology and Religion*. Field Museum of Natural History Publication 154, Anthropological Series, vol. 10. Chicago: Field Museum of Natural History. 370 pp.
 22. Read, B. E. and Pak, C. 1928. A compendium of minerals and stones used in Chinese medicine from the Pen Ts'ao Kang Mu . . . 2nd ed. *Peking Society of Natural History Bulletin* 3, part 2, 98 pp.
 23. Tavernier, J.-B. 1925. *Travels in India by Jean-Baptiste Tavernier, Baron of Aubonne*. Translated by V. Ball from the original French edition of 1676. 2nd ed. Edited by W. Crooke. 2 vols. London: Oxford University Press.
 24. Hill, J. 1774. *Theophrastus's History of Stones*. 2nd ed. London. 342 pp.
 25. Caley, E. R., and Richards, J. F. C. 1956. *Theophrastus on Stones*. Ohio State University Graduate School Monographs, Contributions in Physical Science, no. 1. Columbus: Ohio State University Press. 238 pp.
 26. Eichholz, D. E., ed. and trans. 1965. *Theophrastus De Lapidibus*. Oxford: Clarendon Press. 141 pp.
 27. Higgins, R. A. 1961. *Greek and Roman Jewellery*. London: Methuen and Co. 236 pp.
 28. King, C. W. 1866. *Antique Gems, Their Origin, Uses and Value*. 2nd ed. London: J. Murray. 498 pp.
 29. Middleton, J. H. 1891. *The Engraved Gems of Classical Times, with a Catalogue of the Gems in the Fitzwilliam Museum*. Cambridge: University Press. 157 pp.
 30. Furtwängler, A. 1900. *Die antiken Gemmen: Geschichte der Steinschneidekunst im klassischen Altertum*. 3 vols. Leipzig: Giesecke & Devrient. Vol. 3, 464 pp.
 31. Richter, G. M. A. 1968. *The Engraved Gems of the Greeks, Etruscans and Romans*. Part I. Engraved Gems of the Greeks and Etruscans. London: Phaidon Press. 339 pp.
 32. Boardman, J. 1970. *Greek Gems and Finger Rings, Early Bronze Age to Late Classical*. London: Thames & Hudson. 458 pp.
 33. Holland, P., trans. 1601. *The Historie of the World, commonly called, the Naturall Historie of C. Plinius Secundus*. 2 vols. London: Adam Islip.
 34. Bostock, J. and Riley, H. T., trans. 1855-57. *The Natural History of Pliny*. Vol. 6. London: Henry G. Bohn. 529 pp.
 35. Pliny. 1962. *Natural History. With an English Translation in Ten Volumes*. Vol. 10, Books 36-37. Translated by D. E. Eichholz. Loeb Classical Library. Edited by T. E. Page et al. London: William Heinemann. 343 pp.
 36. Richter, G. M. A. 1971. *The Engraved Gems of the Greeks, Etruscans and Romans*. Part II. Engraved Gems of the Romans. London: Phaidon Press. 307 pp.
 37. Siviero, R. 1959. *Jewelry and Amber of Italy: A Collection in the National Museum of Naples*. New York: McGraw-Hill Book Co. 153 pp.
 38. Thorndike, L. 1923-58. *A History of Magic and Experimental Science*. 8 vols. New York: Columbia University Press. See especially vols. 1, 2, 6, and 7.
 39. Adams, F. D. 1938. *The Birth and Development of the Geological Sciences*. Baltimore: Williams & Wilkins. 506 pp.
 40. Kunz, G. F. 1889. Report on jewelry. *Universal Exposition of 1889 at Paris*. pp. 381-7.
 41. Lothrop, S. K., et al. 1937. *Coclé, an Archaeological Study of Central Panama. Part I: Historical Background, Excavations at the Sitio Conte, Artifacts and Ornaments*. Memoirs of the Peabody Museum of Archaeology and Ethnology, Harvard University, vol. 7. Cambridge: The Museum. 327 pp.

CHAPTER

2

EMERALD AND BERYL IN MEDIEVAL AND MODERN EUROPE

THE painfully slow progress of science in Europe during the first thirteen centuries A.D. is thoroughly documented by Thorndike,¹ who found only rudimentary mineralogical information on emerald and beryl among European writings and some tidbits of curious lore on the emerald. In the same vein, Adams² noted that "nothing was known in these ancient times concerning either the chemical composition or crystallographic form of minerals, although these are now considered to be the most important factors in the distinction of mineral species."

The fact that the post-Plinian era developed little new scientific knowledge on beryl is not surprising in view of the hardness of this mineral and its complete resistance to any kind of chemical attack that the ancients could devise. For all practical purposes, beryl was unassailable, its constituents unknown, and only its reaction to the ministrations of the lapidary provided any clue to its affinities to other similar-appearing minerals. It was not until the 18th century that beryl could be broken down and its components examined chemically.

Some attempts were made in the post-Plinian era to classify gemstones according to color and other obvious external features, but on the whole Pliny's information was relied upon and uncritically repeated in book after book, often embellished with ingenious speculations and unwarranted conclusions. Such books, or "lapidaries," dealt not only with gemstones but many other products of the earth as well, including fossils, stone-like animal calculi or bezoars, and organic substances such as amber, coral, jet, and pearl.

HISTORY AND LORE

BIBLICAL LAPIDARIES

The first of many lapidaries to concern itself with gemstones mentioned in the Bible made its appearance as a brief treatise by Epiphanius (310?–402 A.D.), Bishop of Constantia in Cyprus. Although written in the 4th century, it was first placed in print as part of Conrad Gesner's compilation of mineralogical and gemological works entitled *De Omne Rerum Fossilium*,³ published in Zurich in 1565. Emerald and beryl are both included, and C. W. King⁴ has especially noted Epiphanius's descriptions of "Neronian" and "Domitian" emeralds, which are "particularly austere and green in tint," supposedly due to immersion in an oil pigmented with verdigris to turn them darker green.

In her excellent summary of early lapidaries, incidental to her analysis of Albertus Magnus's work on stones, Wyckoff⁵ noted the "unease" manifested by Church authorities concerning magical virtues attributed to gemstones. Despite the attitude of the Church toward heathen superstitions, she remarks,

Even devout Christians could not entirely shake off the old belief that precious stones possess some sort of supernatural powers or significance. . . . this interest was to some extent legitimized by focusing attention on the stones mentioned in the Bible, especially the two (different) lists of 'twelve stones'—those in the breastplate . . . and those in the foundations of the New Jerusalem.

Thorndike¹ also noted that Epiphanius's treatment of the breastplate stones "perhaps gives an excuse and sets the fashion for the Christian medieval *Lapidaries*." Thus a model was established not only for medieval lapidaries but also for all books treating gemstones, for there is scarcely one of importance that does not include a substantial treatment of Biblical gems.

An extended scholarly study of Epiphanius's Biblical lapidary is to be found in Blake and De Vis,⁶ who examined an Old Georgian version and fragments of the same treatise written in other languages. The subject of Christian lapidaries in general, including Epiphanius, is discussed in detail by Evans,⁷ but much more information on emerald and beryl is given in Blake and De Vis, even more than can be found in the version incorporated in Gesner. Biblical beryl gemstones will be discussed fully in Chapter 3.

OTHER EARLY LAPIDARIES

Another important early work is an encyclopedic compilation prepared in manuscript for Isidore of Seville and called *Etymologiae*. Isidore became Bishop of Seville about 599 A.D., and presumably the manuscript was written near the close of the 6th century. It is mentioned by Adams² and discussed more fully by Thorndike,¹ who, however, does not refer to the mineralogical portions of the work.

Emerald and Beryl in Medieval and Modern Europe

As early as the 9th century, the prophylactic and curative powers of gemstones were formally recognized, and in a work by Costa ben Luca (or Qusta ibn Luqa) of Baalbek, issued in 862–866 A.D. for Caliph al-Musta, the “marvelous powers of gems worn suspended from the neck or set in a ring upon the finger” were affirmed, as was the “fact” that “emerald wards off epilepsy.”

The most important and influential lapidary of the medieval era was that written by Marbod or Marbodus, Bishop of Rennes, who lived during the 11th century. According to Thorndike, it was “very likely completed . . . before the close of the eleventh century.” Both Thorndike¹ and Adams² devote much space to it, Thorndike going so far as to say it is “the classic on the subject of the marvellous properties

**LIBELLVS DE LAPIDIBVS
PRECIOSIS NVPER
EDITVS.**

Cuspinianus Lectori.

**SI VARRONIS. Celii. Galbæ. Mutiani. Cor. Nepotis
Pisonis. Fabii. Tuberonis. Fabiani Catonis monumenta
extarēt: ut interim Græcos omittā: qui de gēnis ac lapi/
dibus scriptitarūt. superuacuū eset hūc prodire libellū in
publicū. Nam & Theophrasti liber de lapidibus ad nos
lacer puenit. Et Nicander a plerisq; ob difficultatē negligē
Sed & diis lacte supplicamus & mola falsa litamus ut ille
ait: quū thura nō habemus. Iccirco hūc amicis libellū am/
plectere brachiis candide lector. Quod si obscura quædā
tibi uidebunt: quædā abstrusa: si Viennæ es: nō pudeat te
Gymnasiū nostrū publicum subire: atq; ea excerptere quæ
quotidie haud negligēter dictamus: nulla enī tibi uerecū/
dia inde accedet si nō erit ingēs aliqua utilitas. Si abes: ex/
pecta donec nostri egredient cōmentarioli. Interea Pliniū
& eius Metaphrastē. Solinū. Dioscoridē. Galenū. Aui/
cennā. Serapionē: & Albertū: hic digito tibi signatos per/
lustrato & gemmarū tibi patefcent uires. Vale.**

Fig. 2-1 The incipit of Marbod's famous poem on precious stones, the *Libellus de Lapidibus*, the first edition of which appeared in Vienna, 1511.

HISTORY AND LORE

of stones," while Adams states that it is "the earliest lapidary of the Middle Ages, and also the one which is quoted most widely."

In his analysis of Marbod, Adams divided the stones described in five categories, the first containing twenty-six stones that are mythical and for which the descriptions are "so trivial that it is impossible to connect the name to any particular mineral." The second category contains six stones of animal origin, while the third includes four stones that, with some confidence, can be recognized as minerals. The fourth contains fourteen varieties of quartz, and the fifth and last group, of special interest here, contains fifteen minerals, including emerald and beryl. As usual, very little physical description but much curious lore is given.

Marbod's work appears in an English translation by C. W. King in his *Antique Gems*,⁸ parts of which are quoted in Chapter 3. Wyckoff⁵ noted that Marbod's information was largely obtained from Solinus, Isidore, and other early writers, but rarely from Pliny, although it must be said that the writers mentioned depended heavily on Pliny for *their* information.

Chronologically, Albertus Magnus' work on minerals is next after Marbod. It is characterized by Wyckoff as "an impressive attempt to organize the science of mineralogy," and while it includes much that is superstitious and speculative, it does introduce new data. The first printed version appeared in Padua in 1476 and, as the work proved very popular, it was quickly followed by other editions. Adams called it "one of the best and most comprehensive of the western medieval lapidaries" and remarked that while Albertus attempted to explain the formation of minerals and gemstones, causes of color, and other properties, he also "enlarges at length on their mystical and wonder-working powers and virtues, . . . there [being] scarcely an ill that flesh is heir to, for which he does not indicate some stone that will act as a protector."

In connection with beryl, Albertus remarked on its high degree of transparency, comparing it to rock crystal, its generally pale colors, the fact that it is produced mainly in India, and recited its magical and medicinal properties. An unidentified stone, called *diadocos* (by others *diadochos*), is said to be pale in color and to resemble the beryl. Wyckoff comments that "the mysterious powers attributed to it by later lapidaries come from Damigeron [an ancient writer] . . . and seem to have to do with its use in some ritual of hydromancy or crystal-gazing," for which last purpose some authorities claim that clear beryl, shaped into spherical form, has been used. Emerald also is mentioned by Albertus, but he repeats the unclear distinctions among the numerous varieties originally listed and described by Pliny, indicating that Albertus was not only unfamiliar with them but had to repeat old information in lieu of anything better.

Almost at the same time that Albertus was preparing his manuscript, another lapidary was being composed for Alfonso X, King of Spain, ca. 1278 A.D. In this

Emerald and Beryl in Medieval and Modern Europe

splendidly illuminated and illustrated work, the original of which is preserved in the Escorial Library in Madrid, the principal object was to demonstrate the connections of gemstones and other minerals to celestial bodies. It thus forms the first major work on the astrological significance of gemstones. A facsimile edition⁹ in color, published in 1881, is discussed by Adams² and extensively treated by Evans.⁷ In it appear several hundred stones, whose treatment reflects the views of Arabic science. The manuscript was originally, according to Adams, "a Chaldean lapidary of unknown date, which was translated into Arabic by Abolays and from Arabic into Spanish by Garci-Perez." The stones are classed by color and placed under the twelve zodiacal signs with brief remarks on properties, uses, and medicinal virtues, but with careful attention paid to how the powers and virtues are influenced by planets and stars. In commenting on this work, G. F. Kunz¹⁰ reports that the emerald is said to be "controlled by Jupiter, and also by Mercury and Venus," while the planet Venus "also lent virtue to the beryl."

THE SPECULUM LAPIDUM

Of much greater importance than the works described so far is a treatise on stones by Leonardus Camillus, a physician of Pesaro, Italy, first put in book form in 1502 under the title *Speculum Lapidum*,¹¹ or "mirror of stones." The latter title was adopted for the anonymous English translation printed in London in 1750.¹² As can be seen from the span of 350 years between these editions, the book long retained popularity and importance. Adams has noted that it marked the passage of the Middle Ages into the Renaissance and "bridged over the transitional period between the old and new mineralogy, since the first edition appeared . . . forty-four years before the publication of Agricola's *De Natura Fossilium* [first ed., 1546]."

As customary, Leonardus gathered his information from previous writers but with the important difference of adopting the first glimmerings of scientific method. He treated more thoroughly than ever the physical properties of minerals and gemstones, such as diaphaneity, hardness, specific gravity (but without numerical values), compactness, color, form, and geographic origins. The second part describes a large number of minerals and gemstones previously recorded by other writers and still others that were fabulous and remain unidentifiable. A third part, omitted in the English translation of 1750, dealt with virtues and properties of gems as enhanced by having their surfaces engraved with suitable signs and symbols.

Concerning the beryl, Leonardus noted that its color is "olive" or "like sea water," and nine varieties are known but "all of a pale green," and that India and Babylon produce beryls, but those from India are finest. He recounts virtues assigned to beryl and its uses in medicine. The *crissopassus* mentioned by Solinus is taken to be "a species of Beryl, having the gold Colour mixed with purple." It

HISTORY AND LORE

T H E

M I R R O R

O F

S T O N E S:

I N W H I C H

The Nature, Generation, Properties, Virtues and various Species of more than 200 different Jewels, precious and rare Stones, are distinctly described.

Also certain and infallible Rules to know the Good from the Bad, how to prove their Genuineness, and to distinguish the Real from Counterfeits.

Extracted from the Works of *Aristotle, Pliny, Isidorus, Dionysius Alexandrinus, Albertus Magnus, &c.*

By *Camillus Leonardus, M. D.*

A Treatise of infinite Use, not only to Jewellers, Lapidaries, and Merchants who trade in them, but to the Nobility and Gentry, who purchase them either for Curiosity, Use, or Ornament.

Dedicated by the Author to CÆSAR BORGIA.

Now first Translated into *English*.

L O N D O N:

Printed for *J. Freeman* in *Fleet-street*, 1750.

Fig. 2-2 Title page of the English translation of Camillus Leonardus's *Speculum Lapidum*. First published in Latin in 1502, it exercised an enormous influence on succeeding treatises on gemstones.

Emerald and Beryl in Medieval and Modern Europe

is one of the gemstones now unidentifiable. The *crisopilon* and *crisoberillus* are also given as beryl varieties, while *diadocus* is "like Beryl in Colour, with a Paleness." Under the term *smaragdus* for emerald, Leonardus described its many varieties and sources, quality of color, and reflectivity when polished. He also recorded several anecdotes of enormously large emeralds which he properly calls "false emeralds." Finally, in a surprising departure from custom, he affirmed that emerald affords "grateful Refreshment to the Eyes" when gazed upon, but dismissed other magical or medicinal properties with the remark that "many virtues are fabled of it."

NEW WORLD EMERALDS

Until the early decades of the 16th century, emerald came exclusively from Egypt, but the discovery of America and the subsequent colonization of South America resulted in enormous quantities of far larger and finer emeralds being suddenly cast upon the market. A new era in the history of this gemstone had begun.

Although the sources of New World emeralds were variously given by early writers of the 16th and 17th centuries as Mexico, Ecuador, Peru, and New Granada (Colombia), it was later established that deposits in Colombia were the sole source and that those stones found in other regions as far north as Mexico were obtained through trade. Ball¹³ gives 1000 A.D. or earlier as the time by which the Indians of Colombia had discovered emeralds, but the lack of records makes it impossible to fix a firmer date. Widespread trade in emeralds suggests that they had been found considerably earlier.

According to Lothrop,¹⁴ the first stones to fall into the hands of Europeans were obtained by the Spanish explorer Pedrarias when he touched at a place now called Santa Marta on the north coast of Colombia while enroute to Darien in Panama. In 1519, Hernando Cortes received gifts, including splendid emeralds, from Montezuma in Mexico, and later obtained other fine specimens looted from Tenochtitlan. The great quantity of emeralds in his possession is well documented. Upon his return to Spain in 1528 he reportedly presented costly carved emeralds to his bride Doña Juana de Zuniga, and in his history of Spain, Juan de Mariana mentions vases cut from emeralds owned by Cortes that were valued at 300,000 ducats.

These early emeralds were obtained through looting, and it was not until 1537, when Jiménez de Quesada conquered Colombia territory (then bearing the name New Granada), that the first rumors were heard of emerald mines at a place called Somondoco. Following up these stories, de Quesada located the deposits in an area now called Chivor. However, according to Schumacher¹⁵ and Canova,¹⁶ the first Spaniard to actually view the mines was Captain Pedro Fernandez Valenzuela.

HISTORY AND LORE

In August 1537, de Quesada conquered the town of Tunja, seized 1,815 emeralds from the residence of the fleeing tribal chief, and ultimately obtained about 7,000 stones during his campaign of conquest.¹⁴ Sometime before 1555, Valenzuela began working Chivor with great energy and presumably at great profit inasmuch as the natives were enslaved as miners. However, the other great emerald deposits of Muzo, which were in the same general region and were capable of producing even larger and finer crystals, defied Spanish efforts to locate them until about 1560, when, according to Codazzi¹⁷ and Otero Muñoz,¹⁸ the first Spanish mayor of the newly founded town of Muzo discovered them.

By mid-16th century, a flood of emeralds and gold inundated Spain and swelled the coffers of the Spanish royal treasury. One would assume from the size of the hoard that numerous large and fine emeralds would still be found among the crown jewels of Spain, but curiously this is not the case. Despite holding a complete monopoly on the production and distribution of New World emeralds, it seems that Spanish authorities and nobility were not given to storing up treasures of precious stones, as was the practice in many other European kingdoms, and instead regarded emeralds as merely another commodity to be exchanged for the far more expendable gold, of which they seemed never able to get enough. How else can one account for the enormous quantity of stones that, up until modern times, found their way into the hands of the rulers of Egypt, the Ottoman Empire, Persia and India? By the 17th century, emeralds were so abundant in Persia and India that Tavernier¹⁹ was moved to remark that no true emeralds occurred in the East at all and those in the hands of the potentates must surely have come from the New World, possibly via the Spanish colonies in the Philippines. The depressing effect of flooding the market with New World emeralds will be returned to later in this chapter.

AGRICOLA'S *DE NATURA FOSSILIIUM*

One of the most important mineralogical-gemological works of all time appeared in 1546 under the title *De Natura Fossilium*, written by Georgius Agricola, now known as "The Father of Mineralogy." An excellent translation of the first edition was prepared by Bandy and Bandy,²⁰ from which the following remarks are derived. Agricola devoted an entire "book" or large chapter to the subject of gemstones, and, unlike his predecessors, provided many illuminating comments of considerable accuracy on the nature, properties, and treatment of gemstones, indicating a firsthand knowledge of many of the species and varieties mentioned.

As is to be expected, Agricola was forced to depend on Pliny, among other authorities, for descriptions of stones with which he was not personally familiar. For example, he mentioned the "Bactrian" emeralds as being collected by horsemen because they lie scattered on the surface of the ground. He repeated the error that Egyptian emerald is too hard to be engraved but almost in the same breath



GEORG AGRICOLA

Fig. 2-3 Portrait of Georg Agricola after an engraving of Sambucus done about 1584.

stated that lapidaries customarily cut and polish emeralds without apparent difficulty. The use of metal reflective foils set behind gems to increase brilliance is also explained, a green foil being used for emerald and the "chrysoberyllus." He also explains that this practice makes it impossible to determine the true color of the gem unless it is removed from its mounting.

By Agricola's time, the use of green glass to imitate emerald was a long-established practice, but such falsifications, said Agricola, can be detected by the scratch test, glass being softer than emerald, and by the touch test, emerald feeling colder than glass, and also by the fact that "glass is usually rough on the surface," perhaps referring to the tendency for glass to abrade readily when worn in a ring. Agricola must have had considerable experience with cut gems. For example, his descriptions of flaws in emerald and beryl, though brief, are precise. (For extended remarks on Agricola's treatise, see Adams.²)

HISTORY AND LORE

GESNER'S *DE RERUM FOSSILUM*

Conrad Gesner's *De Rerum Fossilium*,³ published in 1565, has been mentioned in connection with Biblical gemstones, but it calls for further comment here because it contains other works of importance besides Epiphanius's treatise on the twelve Biblical stones. Among the eight short works it contains is Franciscus Rueus's *De Gemmis Aliquot*, a general treatise on gemstones first published in 1547 but appearing in its second edition in Gesner's work. The emerald and beryl are briefly described without incorporating any new material. Rueus's work is discussed by Thorndike¹ as part of a much longer commentary on the compilation as a whole. Gesner included an essay written by himself entitled *De Rerum Fossilium, Lapidum et Gemmarum*. Thorndike calls this treatise "purely descriptive and classificatory," meaning that Gesner attempted to organize minerals, gemstones, and fossils in some scheme based on external features, placing them into fifteen categories (which are discussed at some length by Adams).

For the first time in a purely mineralogical work, Gesner introduced woodcut text illustrations of minerals, crystals, fossils, and even cut gems. One of these depicts a striated, prismatic, terminated crystal of tourmaline, which Gesner calls a "Brazilian emerald" (see figure 2-5). The tourmaline obviously bears little resemblance to the true emerald crystals of Egypt, and its inclusion in Gesner's book indicates the inability even of experts of that period to clearly distinguish similarly colored minerals from each other or to see anything remarkable in decided differences in crystal form. By use of the term "Brazilian emerald," Gesner perpetuated a misnomer which lasted into our present century. Thus green tourmalines from Brazil were called "emeralds" on the basis of color, and green sapphires from Ceylon became "oriental emeralds," while the true emerald was labeled "occidental" in allusion to its source in the Western Hemisphere. It is possible that Gesner did not recognize the differences in crystal forms between the true emerald and the Brazilian tourmaline; nevertheless, in another place in his text he accurately describes the six-sided crystals of beryl, which he classes in the same group as similar six-sided quartz crystals.

VALUE OF EMERALD AND OTHER GEMSTONES

In 1572, not long after Gesner's book was published, the first book to give a systematic means for evaluating precious metals and gems appeared in Valladolid. Entitled *Quilator de la Plata, Oro y Piedras*, it was written by a goldsmith, Juan Arphe de Villafañe or Juan de Arfe y Villafañe.²¹ The third book of this treatise establishes rules for appraising gems; it includes emeralds but entirely ignores other varieties of beryl. A woodcut diagram of the recommended style of cut for the emerald (see figure 2-7) is apparently the first illustration of an accepted facet cut for emerald to appear in print. It shows a simple square-cut gem, cut unacceptably

Emerald and Beryl in Medieval and Modern Europe

CONRADI GESNERI

DE RERVM

FOSSILIVM, LAPIDVM ET GEMMARVM

maximè, figuris & similitudinibus Liber: non solum Medicis, sed omnibus rerum Naturæ ac Philologiæ studiosis, utilis & iucundus futurus.



Cum Gratia & Privilegio S. C. ¹⁵⁶⁵ late-
statis ad annos VII.

TIGVRI M. D. LXV.

Fig. 2-4 Title page of Conrad Gesner's essay on minerals, stones, and gems, part of a large compilation published in Zurich in 1565.

shallow by today's standards, but satisfactory in those days when almost all gems were backed with foil to assure a reflective brilliance. Today this brilliance is achieved solely by cutting to proper proportions. The emerald is ranked third in importance, after diamond and ruby, and *esmeraldas viejas* ("old emeralds") are valued more highly than *esmeraldas nuevas* ("new emeralds"). The "old emeralds" were actually green sapphires, called "oriental emeralds" by some because

HISTORY AND LORE

De figuris lapidum, &c.

minatur. Amianti veri è Cypro quem
Franciscus Calceolarius, pharmaco-
pola Veronensis vt artis suæ peritissi-
mus, i omnium simplicium medica-
mentorum indagator acerrimus, ad
me misit, frustulum delineatū hîc ex-
hibeo: quod fila molliuscula neri te-
xiq̃ apta remittit, & ab alumine scif-
sili tum vero & aluminis vim sapor-
remq̃ referente, tum falso & insipi-
do, quod alumen plumę hactenus vo-
care soliti sunt Medici, non parum
differt.



- 1 *Amiantus è*
Cypro.
- 2 *Smaragdus*
Bresilicus, cy-
lindri specie.
- 3 *Hammites*

vel Ammonites, minor, minimis piscium o-
vis vel araneorum similis, velutiq̃ ex arenu-
lis coagmentatus.

Hîc & alij aliquot in locis, optime Lector, non
vnam solùm, vel plures, sed instituto ordini con-
uenien-

Fig. 2-5 The earliest known illustration of a tourmaline crystal, misleadingly called "Brazilian emerald" in the caption (#2). The other figures are asbestos from Cyprus (#1) and a fossil (#3). From Conrad Gesner's essay, *De Rerum Fossilium* (Zurich 1565).

Emerald and Beryl in Medieval and Modern Europe

QVILATADOR DE LA PLATA, ORO, Y PIEDRAS,

COMPUESTO POR IOAN ARPHE
de Villafañe: natural de Leō: vezino de Valladolid.



Impresso en Valladolid, por Alonso y Diego Fernández de Cordoua, Impressores de su Magestad. Año M. D. LXXII.

CON PRIVILEGIO.

Fig. 2-6 Title page of *Quilatador de la Plata, Oro y Piedras* by Arphe de Villafañe, published in Valladolid in 1572. This work for jewelers gave rules for the valuation of precious metals and gems.

of their origin in the East, and the "new emeralds" or "occidental emeralds" were the gems that originated in Colombia.

Arphe included tables of values in ducats for increasing weights of cut gems for diamond, ruby, oriental or old emerald, the *meridional* or "southern" emerald (another name for the Colombian stones), and the spinel. Each table is accompanied by a small woodcut showing the actual size of the gem for each weight. As is to be expected, the values increase with increasing weight, but in every instance the green sapphire is valued at exactly twice that of the emerald, which seems to confirm the fact that flooding the Spanish market with Colombian emeralds did

HISTORY AND LORE

T E R C E R O .

48

dor, que no ay cosa criada tan verde como ella, ni que mas de leyte la vilita. Fueron otro tiempo mas estimadas que Diamâtes y Rubis tamaño por tamaño, halta que en las Indias de España hallaron otras species de ellas: y algunos grandes pedaços que por auer sido en cantidad, auenido a menor precio que solian valer. Pero con todo esto son muy estimadas las orietales de la prouincia de Egipto, que llaman Esmeraldas viejas, por que ay pocas. Dizese dellas, que tienen virtud contra el gota coral: y que inclinan a augmentar riquezas: y a condicion apazible. Labranse como los Diamâtes, aun que no son aplanicie llana, sino tum-bada: y los angulos y esquinas romas: y el gruesso al quarto de su plaça, poco mas o menos, que esto no importa. El color a de ser muy encendido y de grã fuerza y resplandor: y siendo en perfeccion se taslan por el area de los Diamantes. Por que si vna Esmeralda vieja oriental es tan grande como



Propiedades
de la Esme-
ralda.

Fig. 2-7 One of the earliest illustrations of a standard cut for emeralds, showing curvature of top facets, a shallow, rounded pavilion, and angles calculated to give maximum "spread" but little reflection from the back facets. From Arphe de Villafañe's *Quilatador de la Plata, Oro y Piedras* (Valladolid, 1572).

indeed depress their value. This may also have encouraged gem dealers to divest themselves of surplus stock by selling stones to dealers in other countries of Europe as well as in Arabic and Indian states, the rulers of the latter, one may be sure, recognizing bargains and snapping them up.

Another Spanish book on precious metal and gem valuation appeared in 1721 in Madrid as *Litho-Statica, Theorica, y Practica de Medir Piedras Preciosas*.²² Also written by a jeweler, one Dionisio de Mosquera, it provides a businesslike summary of all the factors that must be considered in evaluating cut gems. Mosquera mentioned the *aguacate* or "avocado" shape of pendant emeralds, apparently an

Emerald and Beryl in Medieval and Modern Europe

accepted form of drop-cut, even though polished without facets. He also described defects in emerald which diminish their value and provided tables of prices for cut gems of specified weights. Like his predecessor Arphe de Villafañe, he also valued "without exception" the "oriental emerald" above the "occidental emerald."

SOME EARLY 17TH-CENTURY LAPIDARIES

Andrea Bacci published his *Le XII Pietre Pretiose*²³ in Rome in 1587, another treatise on the twelve Biblical gems containing no new information and only mentioning the emerald and beryl. Considerably more information, as well as additional remarks on curious lore, was provided by Gabelchover in his Latin translation of this work, published in Frankfurt in 1603 as *De Gemmis et Lapidibus Pretiosis*.²⁴ It may be the first gemological treatise to specifically draw attention to the Colombian emeralds, which are labeled "Peruvian" after their supposed country of origin.

In 1605 a substantial work on gemstones, entitled *Libro de las Virtudes y Propriedades Maravillosas de las Piedras Preciosas*,²⁵ appeared in Madrid, written by the apothecary Gaspar de Morales. As Thorndike remarks, the title suggests that the work is entirely on curious lore, but in fact the first book contains a number of chapters which treat origin of gemstones, Biblical stones, physical properties, distinction of genuine from false gems, how gemstones acquired their virtues, an alphabetical list of gem colors, medicines made from gemstones, and other information. The second and third books describe a large number of gemstones, including the emerald and beryl, with remarks on varieties, sources, qualities, and properties. Curiously, Morales did not mention the emerald of the New World, although they were already known in Spain.

Also in 1605, J. B. Silvaticus of Milan published an odd treatise combining discussions of the medicinal virtues of such unrelated substances as unicorn horn (narwhal tusk), bezoar, emerald, and pearl in a single work entitled *De Unicornu Lapide Bezaar Smaragdo et Margaritis Eorumque in Feribus Pestilentialibus Usu*. Thorndike briefly discusses this book, noting that Silvaticus dismissed emerald as being ineffective in medicines.

DE BOODT'S LANDMARK LAPIDARY

In 1609 appeared a true landmark in lapidaries, and the most important work of all those so far described. It was written by Anselm Boetius de Boodt (ca. 1550–1632) and entitled *Gemmarum et Lapidum Historia*.²⁶ Published in Hanover, it received prompt acclaim and wide distribution, and it exerted an enormous influence on succeeding works. It was republished in 1636 with a commentary by Adrian Toll, a French translation appeared in 1644, and a third and last edition appeared in 1647. Adams called it "in many respects the most important lapidary of the seventeenth century," while Thorndike found that "it shows a marked ad-

HISTORY AND LORE

vance in several respects . . . it completely omits all matter concerning marvel-working images carved on gems [and] profits by the discovery of the new world and knowledge of distant lands." In regard to the value of emeralds, Thorndike noted "de Boodt says that Peruvian emeralds have brought down the price of that stone and are preferred by most dealers to those from the orient."

Evans⁷ remarked that this work "is an attempt . . . to arrive at a rational classification of precious stones according to . . . opposites," that is, whether they are large or small, soft or hard, rare or common, etc. This scheme received harsh criticism from Adams, who, largely concerned with scientific advancement, found de Boodt's scheme of little value. On the other hand, Thorndike, ever concerned with curious lore, pointed out that de Boodt's writing combined skepticism with credulity in regard to the powers and virtues of minerals and gemstones.

Regardless of Adams's criticism, de Boodt's treatise is a fund of information accurately reflecting contemporary knowledge. De Boodt cited his authorities but augmented borrowings with firsthand information of his own which he must have garnered in his capacity as adviser on gemological matters to the court of Emperor Rudolf II in Prague. (His primary duty was court physician.) It is apparent from reading his material on lapidary work in particular that he brought to his writing a far greater expertise than had been possessed by previous authors of gemological treatises.

In regard to emerald, de Boodt repeated the most important contributions of previous writers and emphasized that the prevailing custom among jewelers was to classify gems according to "oriental" and "occidental" origins. This unfortunately perpetuated confusion when such terms were applied to beryls. In describing localities of origin, he mentioned emerald from Brittany and other places in Europe but gave no specifics, and he noted that Peruvian emeralds are a "very pleasing green" and obtainable in such large specimens that "some exceed in size the palm of the hand." He also evaluated emeralds against values of cut diamond gems. Beryl, he noted, is found in Germany and Bohemia.

Often appended to and bound up with the third (1647) edition of de Boodt is Joannes de Laet's work of the same date, *De Gemmis et Lapidibus*.²⁷ It was also issued separately and was meant to serve both as a supplement to de Boodt and as an independent work. De Laet, or Jan Van Laet (died ca. 1650), amplified de Boodt's remarks on emerald and used for the first time in a gemological book the word "America" when speaking of Colombian emeralds. He described the locality somewhat more accurately, but still inadequately, as "the Promontory of Helen in the Province of Manta, Peru." He also notes the "Brazilian emerald" of Gesner and the latter's illustration of it, but de Laet did not question the identification. Some information is provided on beryl but none of it is new.

*Mineralogia, Sive Naturalis Philosophiae Thesauri*²⁸ was an encyclopedic min-

Emerald and Beryl in Medieval and Modern Europe

erological treatise in which gemstones receive due attention. Written by Bernardo Cesi (ca. 1581–1630), it was published in Lyon, in 1636. Both Thorndike and Adams comment unfavorably upon it. When the entries for emerald and beryl are examined, it will be found that each is described twice, once as stones in the High Priest's breastplate and again in the Apocalypse. Cesi added nothing new to the then current knowledge of gems.

NICOLS' HISTORY OF PRETIOUS STONES

Not too long after the publication of Cesi's work, a vastly superior work appeared in England when Thomas Nicols published his *A Lapidary: Or, The History of Pretious Stones*²⁹ at Cambridge in 1652. It holds the distinction of being the first worthy gemological monograph published in the English language and is remarkable for its terse, sometimes dry recitals of information rendered in the quaint diction of the time. The material was gathered from traditional as well as recent sources and included much new information as well. While the dedication freely acknowledges use of de Boodt, Nicols states that his aim was "to take away that confusion about the *species* of gemms, which doth cause them to be hardly and difficultly known of what *species* and kinds they are." He goes on to say that he not only studied de Boodt "but also divers other Lapidists, to shew the true way of discerning factitious and artificiall stones or gemms, from those that are really and truly the works of nature." The folding table of classification which he includes is very similar to that found in de Boodt.

The first part of Nicols's work, the "Generall Treatise," discusses such topics as origin of gemstones, color, properties, adulterations and "improvements," artificial gems, and lapidary treatments, with several interesting essays on the supernatural characteristics of gemstones, their causes, and rules on how to discover them. The second part is descriptive, emerald and beryl receiving fair treatment. Here we find recommendations on use of reflective foils for transparent beryl gems, specific recipes for making imitative glasses, and remarks on nomenclature, varieties, localities, properties, and curious lore.

Nicols also perpetuated the terms "oriental" and "occidental" as applied to emeralds, noting that the "best [are] brought from the East-Indies" (he was probably referring to green sapphires), but that "excellent ones [are also] found in the Occidentall or Western parts, and in the parts of Europe." The emeralds of Colombia are described as having a "pleasant green colour, but send forth no rayes, these are softer than the Orientall ones, and often full of green clouds." On the whole, this is a good description of typically included emeralds which, because of the abundance of inclusions, reflect light poorly from their back facets.

In another place, Nicols described the "Smaragdo-Prassius" as "a transparent green gemme . . . betwixt a *Prasius* and an *Emerauld* . . . which Boetius [de

HISTORY AND LORE

A
LAPIDARY:
 OR,
THE HISTORY
 OF
PRETIOUS STONES:

With cautions for the undeceiving of
 all those that deal with
Pretious Stones.

By **THOMAS NICOLS,**
 sometimes of *Jesús-Colledge* in
CAMBRIDGE.

Inest sua gratia parvis.

CAMBRIDGE:
 Printed by **THOMAS BUCK,** Printer to
 the Univerſitie. 1652

A. 2

Fig. 2-8 Title page of the first English work on gemology,
 published by Thomas Nicols in Cambridge, 1652.

Boodt] taketh for a kind of *Emerauld*, or a bastard *Smaragde*." There are two kinds, one from Bohemia "which are transparent through a fine cloud" and another, "American ones, which are half-transparent, like unto *Vitriol*." Both are possibly beryls, perhaps yellow-green beryls or aquamarines known to occur in Bohemia and in Brazil. (Nicols's term "America" might be a reference to Brazil.)

Concerning clear beryl, Nicols noted its use in spheres whose "form hath the same power of begetting fire from the Sunne by its beams, that a Crystall glass hath" and that "the price of *Beryll* is augmented or diminisht according to the elegancie of its colour," going on to add wisely that "this rule is to be observed in the price of all jewells."

MINERALOGY IN THE MID-17TH CENTURY

In Bologna in 1648 a large and impressively illustrated work on the products of the mineral kingdom entitled *Musaeum Metallicum in Libros IIII Distributum*³⁰ was published posthumously for its author, Ulyssis Aldrovandi (1522–1605), the celebrated Italian naturalist. It is typical of the encyclopedic natural history works of that period because it attempted to gather everything known about minerals, stones, ores, fossils, and gemstones under one cover. One of its distinctions, according to Adams,² is the fact that “this is the first instance in which the word *Geologia* or *Geology* appears in literature when used approximately in its present sense.” In regard to beryls, Aldrovandi repeated material in Marbod and de Boodt, among other authorities, and treated beryl and emerald in terms of synonymy, descriptions, properties, localities, varieties, imitations, curious lore, and medicinal uses.

Among its woodcut illustrations are several purporting to be beryl specimens, but they are so poorly done that, as Adams pointed out, “since specimens of rocks and those of many minerals do not lend themselves easily to pictorial representation, some of these cuts can scarcely be said to illustrate the text, they rather require the text to explain them.” None of the beryl illustrations are recognizable as such; indeed, several are obviously druses of quartz, as shown in figure 2-10.

Adams closed his chapter on medieval mineralogy with a discussion of Aldrovandi's work, and his remarks are fitting:

Medieval mineralogy in fact was not a science . . . not a solid tower of learning . . . but a fairy castle, the insubstantial fabric of a dream, often quaint and even beautiful, but destined to crumble away because it had no foundation in reality . . . it was now to be succeeded by a true science of mineralogy built upon the basis of close observation and diligent study of the materials of the earth's crust.

It is at this point in time—the mid-17th century—that gemology began to divide into two branches, the first becoming part of the developing science of mineralogy, and the second retaining the romantic aspects of gemology still so dear to many today and treasured by many more in the past. The commercial aspects of the gemstone trade tended to resist the injection of too much science into gemology, and consequently books written on gems tended to emphasize lore and romance over the unglamorous mineralogical facts. The names of gemstones, long established to the satisfaction of gem merchants and customers, proved particularly resistant to change, as evidenced by the extremely long time that the names “oriental” and “occidental” remained appended to emeralds and other gems. If an “oriental emerald” could always be sold under that name, even if it happened to be a misnomer, or if a “balas ruby” lent the impression that a variety of true ruby was being offered, what harm was done? Thus gemological knowledge tended

HISTORY AND LORE



Fig. 2-9 Engraved title page with a portrait of Ulyssis Aldrovandi from his *Musaeum Metallicum*, a work on products of the earth, published in Bologna in 1648.

II. Tabella cum tribus Beryllorum differentijs.

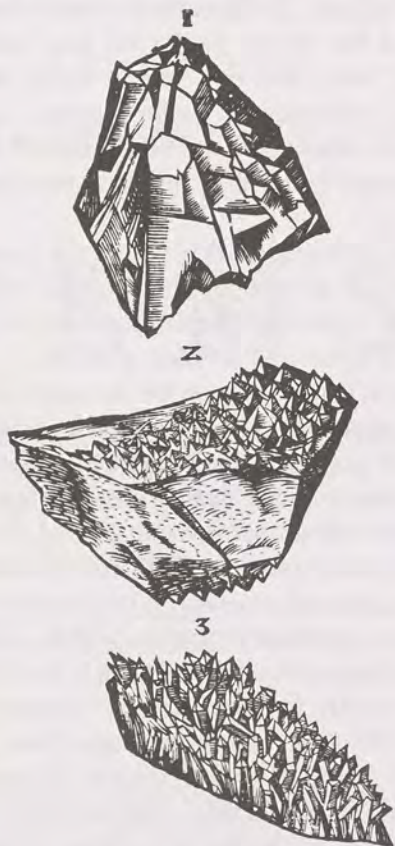

Fig. 2-10 Ulysis Aldrovandi's woodcut illustrations of "beryl" specimens, the lower two of which appear to be ordinary druses of quartz crystals. Taken from his *Musaeum Metallicum* (Bologna, 1648), these appear to be the first attempt to depict natural beryl in a book.

toward stasis and continued to embody much that was romantic and little that was scientific, a state of affairs that lasted for a very long time.

BOYLE AND HIS CONTEMPORARIES

In the latter part of the 17th century, several important works mentioning emerald and beryl appeared, the first being *Le Mercure Indien, ou le Tresor des Indes*,³¹ written by a Pierre de Rosnel and published in Paris in 1667. Despite

HISTORY AND LORE

claiming familiarity with the West Indies and their products, the exact source of Colombian emeralds is not given, possibly because the Spanish were not anxious to reveal this information. Rosnel merely said "the common opinion is that they occur in the mountains called Manta or Porto Viejo," both places in Ecuador. Rosnel, like others of his day, had examined color-zoned crystals of emerald from Colombia and repeated the widely held view that such crystals, part white, part green, were "unripe," and, had they grown under the blazing sun of the East, would have eventually darkened to a uniform green. In another place, he spoke of the quality of "Mexican emeralds" and others from "several parts of the Indies," again repeating a common belief that emeralds occurred in many places in South America.

The second work published in this period (in London in 1672) is as close to being completely scientific as was possible in those days. It was written by Robert Boyle (1627-1691), the celebrated English physicist. Its somewhat misleading title, *An Essay About the Origine and Virtues of Gems*,³² suggests a tract largely on curious lore, but in fact it is primarily on the formation of minerals and their crystals through the agency of mineralizing solutions, with relatively minor remarks on the general impossibility of gemstone medicines being effective because of their insolubility. In a rambling discourse typical of his writings, he introduced material on crystallography and physical properties and showed that he habitually used hydrostatic weighings to ascertain stone densities and thus aid in their identification.

Boyle not only mentioned emerald in connection with its color and how that varies from specimen to specimen, or even within a single crystal, but also cited José de Acosta's famous account of the Spanish in the New World, *Historia Natural y Moral de las Indias* (1590), to the effect that "Emeralds grow in Stones like unto Christels, and that he had seen them in the same Stone fashioned like a Vein; And they seem, adds he, by little and little to thicken and refine. And in the same place this Learned Author has a memorable observation that may confirm what I have just now related, and what we mentioned a little below, about *colourless Gems I have seen*, sayes he, *some that were half White and half Green; others all White, and some Green and very perfect.*"

In regard to medicinal properties of gemstones, Boyle adopted a somewhat ambiguous view of their effectiveness, inclining mostly to doubt the efficacy of gemstones in pharmaceutical preparations but still admitting that some soluble minerals, or at least soluble constituents in them, might have some effect. (This subject was of special interest to Thorndike,¹ who devotes an entire chapter to Boyle.)

Not long after Boyle's essay appeared, two works were published in Europe which held up to ridicule the magical and medicinal properties of gemstones. In 1687 at Leipzig University, Johann Jakob Spener published a short academic dissertation entitled *De Gemmis Errores Vulgares*³³ in which he reviewed some of the more glaring examples of erroneous belief quoted by earlier writers, including the

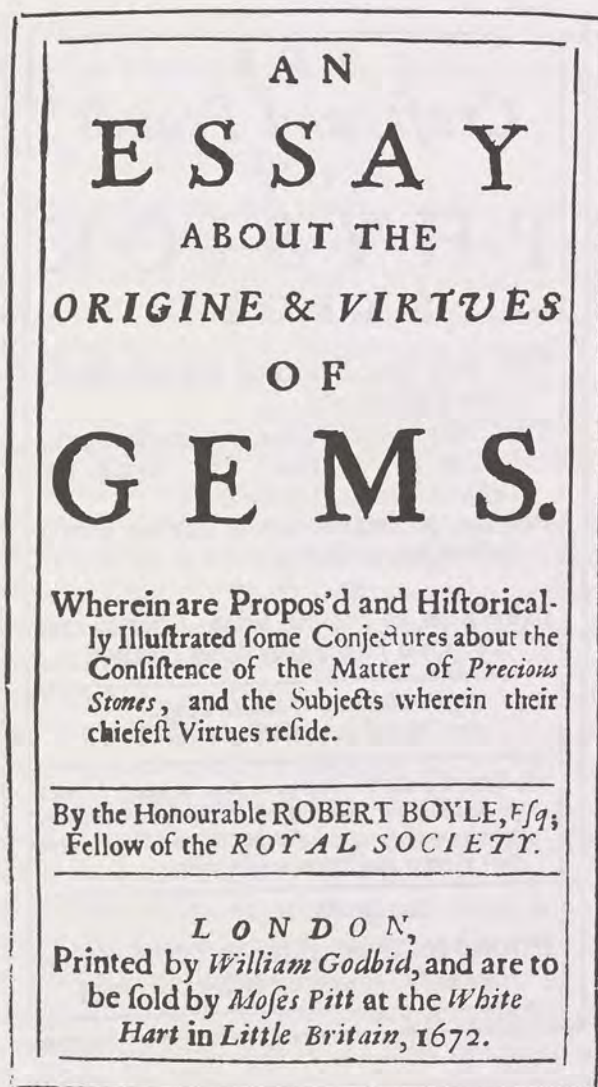

Fig. 2-11 Title page of Robert Boyle's famous dissertation on the formation of minerals and gemstones.

fascinating if unsupportable conviction that an emerald worn during intercourse would shatter, particularly if the coupling were illicit. Also dismissed was the belief that emeralds were good for warding off demons.

The second work on this theme, first published in 1703, came from the pen of a famous London physician, Dr. Robert Pitt, and was entitled *The Craft and Frauds of Physick Expos'd*.³⁴ As the *Dictionary of National Biography* puts it, it

HISTORY AND LORE

T H E
Craft and Frauds
 O F
P H Y S I C K
 E X P O S ' D.

The very low Prices of the best Medicines Discover'd.
 The Costly Medicines, now in greatest Esteem, such as *Bezoar, Pearl, &c.* As also the *Distill'd Waters*, Cenfur'd.
 And the too frequent Use of Physick prov'd Destructive to Health.

W I T H

Instructions to Prevent being Cheated and Destroy'd by the prevailing Practice.

Discite Justitiam Moniti. Virgil.
Arte Medicâ nulla fructuosior est. Plin.

The Second Edition, improv'd. And Augmented with an Alphabetical Index of all the Simples and Compounds now in use, referring to the Page where their Virtues and Prices are set down.

L O N D O N :

Printed for **Tim. Childe**, at the *White-Hart* in *St. Paul's Church-yard*, 1703.

Fig. 2-12 Title page of an early 18th century exposé of medicinal frauds by Dr. Robert Pitt of London.

was "written to show the small cost of the really useful drugs, the worthlessness of some expensive ones, and the folly of taking too much physic. The book gives a clear exposition of the therapeutics of that day, and is full of shrewd observations." Pitt pointed out that the essential insolubility of gemstones made it impossible for them to chemically affect the body and noted that stones ingested by birds "were found to have past through, without any change of Colour or Figure," and in the case of the "Confection of Hyacinth," the precious hard stones "can only

Emerald and Beryl in Medieval and Modern Europe

make the pretence of its being sold at a dearer rate." Lastly, he remarks, only "the smallest and vilest" of such stones as hyacinth, sapphire, smaragd, and topaz are used in such preparations.

ADVANCES OF THE 18TH CENTURY

By the commencement of the 18th century, much was being done to systematize mineralogy and chemically analyze minerals, salts, and other substances, but little could be accomplished with the means then at hand in respect to chemical analysis of the many hard, resistant oxide and silicate minerals, among which gemstones figure prominently. In 1730, Magnus von Bromell (1678–1731) published results of fusion experiments on many minerals and established a fusibility scale which still finds use today in determinative mineralogy. The more heat-resistant species, including beryl, remain unmelted in the blowpipe flame and thus were put in the "infusible" category.

The first, albeit indirect, steps taken to solve the puzzle of chemical composition of gemstones were those of Johann Heinrich Pott (1692–1777) of Germany, who, encouraged by the King of Prussia, began a series of fusion experiments aimed at the discovery of the ingredients of porcelain. His results, published during 1751–57 as his *Lithogéognosie*,³⁵ were called by Thomson³⁶ "one of the most extraordinary productions of the age." Pott fused a variety of "earthy" substances, alone or mixed with other substances, including fusions of the topaz of Saxony and several crystalline and cryptocrystalline varieties of quartz. These experiments led to the recognition of silica and alumina as constituents of some of the harder and hitherto most resistant gemstones and minerals, and they demonstrated the usefulness of certain alkalis in facilitating fusion. The resulting melts could now be chemically attacked and their components determined. While beryl eventually succumbed to analysis via the fusion method, the presence of its unique element, beryllium, was not detected until the end of the century. At this time beryl was thought to contain only silica and alumina as principal constituents.

In 1747, a mineralogical work that is generally conceded to be the first to introduce a modern scheme for classification of minerals was published by Johann Gottschalk Wallerius (1709–1785) in Stockholm as *Mineralogia, Eller Mineral-Riket*.³⁷ Disappointingly meager in its discussions of emerald and beryl, it nevertheless provides a few valuable bits of information, primarily on current sale values of gems. Unlike the diamond, the prices demanded for emerald are quite variable because of differences among stones in color and clarity. For pure-colored and clean small emeralds, the base price was fixed at 4 riksdalers per carat, but for one-carat gems the price ranged between 30 to as much as 80 riksdalers, depending upon vividness and purity of color. However, the price did not escalate with increased weight, as does the price of diamond, because larger emeralds were rarely

HISTORY AND LORE

pure and without flaw. Wallerius gives a table comparing the prices for rose-cut diamonds and emeralds, which shows that the base price for the diamonds was 64 riksdalers per carat in Hamburg and 70 riksdalers in Amsterdam, or somewhat over twice the price demanded for emeralds of comparable size.

THE BRÜCKMANN TREATISES

The state of mid-18th century gemological knowledge is nowhere better recounted than in the compilations of fragmenta assembled by U. F. B. Brückmann in his *Abhandlung von Edelsteinen*,³⁸ first published in 1757 and appearing subsequently in a second edition and supplements. Brückmann maintained a wide correspondence with European scientists, collectors, and connoisseurs and acted as a clearinghouse for all new developments in gemology, thus making his treatises exceptionally useful storehouses of extant knowledge.

In the first edition of 1757, emerald is treated in terms of nomenclature, physical properties, and other salient data, with Brückmann noting that while emerald loses color during heating, the color returns upon cooling. Emerald crystals are erroneously described as "five-sided," but only a fragment of a crystal was available for his examination. Localities included Cyprus, Brittany, Bohemia, Switzerland, and America. Concerning value, he says, "Before the emerald appeared so abundantly from America, it was valued close to the diamond, but now for those which are very good and clean the value is not far from one-fourth that of diamond, so that if a diamond is reckoned at 800 thaler, the emerald of the same weight can only bring 200, or less, in our day." In another place he mentioned a popular conviction that emerald color was due to copper.

Brückmann also described beryl and golden beryl, but the physical properties given are largely incorrect. Brückmann claimed that when beryl was heated, it lost color and melted into a glass, and that such color as was present owed its origin to a "mixture of iron and copper." The value of beryls was equated to that of topaz. The golden beryl or "chrysoberillus" was classed by Brückmann as a kind of chrysolite, perhaps a peridot, which indicates the confusion that still reigned as to the true identities of the various beryls and minerals which superficially resembled them.

Brückmann's second edition of 1773, much larger and more elaborate than the first, provided more information on beryl. Here the hardness of emerald was stated to be the same as that of beryl and aquamarine. Brückmann disagreed with one authority who claimed that the "oriental emerald" was supremely hard, Brückmann apparently having examined true emerald while the other authority had examined green sapphire. In regard to melting, Brückmann found that emerald could be fused into a glass providing its crushed powder was first mixed with borax. At the time of writing, the value of "beautiful emeralds, of 3 to 4 carats" was about 50 to 60

Emerald and Beryl in Medieval and Modern Europe

thalers. Emerald worn in rings "readily loses its polish and acquired fissures," said Brückmann, but such can be easily corrected by recutting the gem on a lead lap charged with emery followed by polishing on a tin lap with tripoli. Thus he gave for the first time accurate information on lapidary techniques used for emerald and other beryls.

Brückmann noted that beryl occurred in fairly large specimens but was seldom found without inclusions or flaws, and it was not related to topaz because the latter gemstone was unaffected by fire whereas the beryl melted into a glass when fluxed with borax. An earlier statement on beryl color was also modified to claim that it was owing to lead and copper instead of iron and copper. "A beautiful aquamarine glass" could be made from lead-glass plus copper and cobalt. Little value was placed in those days on beryl gems, ordinary kinds selling for from 4 to 5 thalers per carat in 2-carat size.

Ceylon and Pegu (Burma) are mentioned as localities for emerald, as are Italy, Germany, and Hungary. Localities for American emeralds were still not known and were given in this edition as the valleys of the Tunka and Tomana rivers and formerly from the Manta Valley. Beryl is said to occur in Saxony, Bohemia, and Hungary, and other places in Europe.

The recently discovered pyroelectric properties of "Brazilian emerald," or tourmaline, were taken by Brückmann as evidence that some gems bearing this name must now be classed as tourmalines instead of beryls, for "when warmed, they draw to themselves ashes and other light materials." The discovery of this property of tourmaline was due to the work of John Canton in 1754 and Franz Ulrich Aepinus in 1757, and when publicized it did much to discourage the use of the misnomer "Brazilian emerald."

After his second edition, Brückmann published two supplements, one in 1778 and the other in 1783. In the first supplement he cited Romé de Lisle's recently published *Essai de Cristallographie*³⁹ on emerald and commented on an emerald matrix specimen in the Davila collection catalog,⁴⁰ which was particularly rich in beryl specimens. Pyrite inclusions in emerald of "Peru" were noted for the first time, and the "Peruvian emerald mine" is described as being "in the Tunia Valley, or Tomana Valley, not far from Cartagena, between the mountains of Granada and Popoyan, from whence they are brought to Cartagena." However, confusion as to exact source still existed, for on the same page is the claim that "emeralds are also found on the entire Peruvian coast, from Cape St. Helena in the Province of Manta to the Bay of Bonaventura," and further, "various streams in this region are named the Ry de Esmeraldas, Ry pueblo de Esmeraldas, because they provide emeralds."

The second supplement of 1783 contained a further miscellany of information, including for the first time several chemical analyses by Achard and Bergmann, whose work is discussed below. The supplement also contains remarks on the new

HISTORY AND LORE

and very important Siberian aquamarines, which Brückmann had obtained for his collection in 1780. The largest of these crystals was a six-sided prism with flat termination, measuring 1½ inches (38 mm) long and ½ inch (13 mm) thick, of a "beautiful sea-green color." Although Brückmann does not supply a definite locality, they probably came from the same source in the Altay Mountains of Asiatic Russia that Peter Simon Pallas, the distinguished Prussian traveler and naturalist, had described in a letter to Brückmann of 15 December 1780 as being in "high snowy mountains" along the Chinese border.

ADVANCES IN CHEMICAL AND PHYSICAL ANALYSIS

Despite advances in chemical and crystallographic mineralogy, the distinction between "oriental emerald" (or sapphire) and "occidental emerald" (or beryl) remained unclear. For example, in his *Essai de Cristallographie*,³⁹ published in 1772, Romé de Lisle, also de L'Isle (1736–1770) discussed both gemstones in the same breath and seemed not to appreciate the significance of their different crystal forms, even though these differences were plain to see in the drawing which accompanied his text. Furthermore, he included the "emerald or Peridot of Brazil" with other varieties of emerald, although his drawing showed it clearly to be a crystal of tourmaline. However, in a greatly enlarged edition of this work,⁴¹ published in 1783, these errors were corrected, the beryls were put together, the sapphire placed with other corundums, and the tourmaline placed by itself as distinct species. Thus long-standing confusions were cleared up. In this edition, Romé de Lisle included values for specific gravity as determined by Brisson (see below), which was a further valuable identification tool.

By the late 18th century, much progress had been made in the chemical analysis of the harder, hitherto intractable minerals, including beryl, through fusion of the powdered mineral with alkalis and the production of water-soluble residues which could be analyzed by wet methods. Some authorities credit the celebrated Swedish chemist, Torbern Bergman (1735–1784), with this innovation in 1780,⁴² but the German chemist Franz Carl Achard (1753–1821) published in 1779 the results of his somewhat earlier experiments, showing that he had accomplished essentially the same kind of analysis.⁴³ Achard analyzed ruby, sapphire, emerald, zircon, pyrope, and chrysoprase, and discovered in emerald a proportional composition of 6.5 for silica, 2.5 for lime, 18 for alumina, and 1.5 for iron. He reaffirmed the fact that heating did not destroy the color of emerald, but that very high heat resulted in fusion to a glassy mass that resembled milky chrysoprase in hue.

Specific gravity of minerals and other substances was determined with considerable accuracy by Mathurin Brisson (1723–1806), who published his results in 1787 in *Pesanteur Spécifique des Corps*.⁴⁴ This treatise also contained an engraved plate of crystal forms, leaving no doubt that beryl was the mineral he actually

Emerald and Beryl in Medieval and Modern Europe

Pl. II.

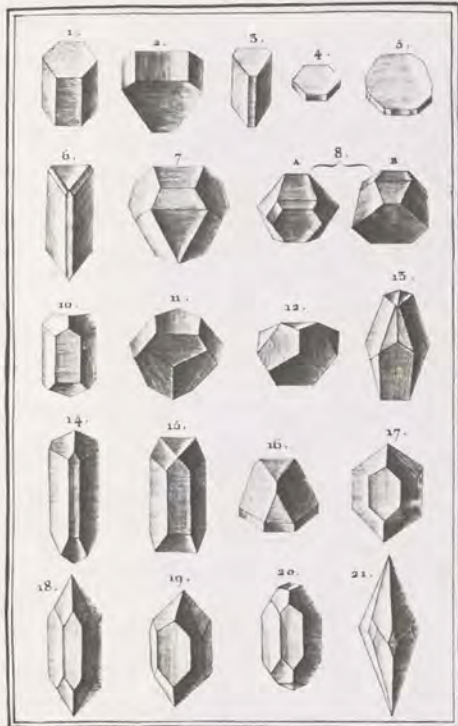

Designé par l'artiste.

Pl. III.

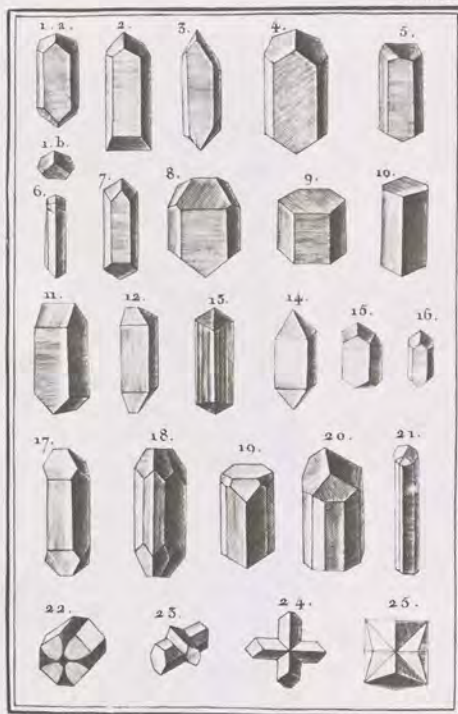

Designé par l'artiste.

Fig. 2-13 Romé de Lisle's representations of crystals of the "emerald of Peru," figure 1 of Plate II and figure 23 of Plate III. From his *Essai de Cristallographie* (Paris, 1772), which provided one of the earliest systematic descriptions of the crystal forms of many minerals.

measured. Table 2-1 compares Brisson's values to modern values of specific gravity of beryls and other minerals often confused with beryl.

Brisson's values are reasonably close to presently accepted figures, and for many years they were the standard. The accuracy of his figures did much to remove confusion between true beryls and similarly colored species such as corundum, tourmaline, olivine (peridot), and chrysoberyl.

Near the close of the 18th century, the discovery of beryllium oxide finally permitted the first accurate analysis of beryl. This noteworthy chemical achievement was made by French Chemist Nicolas Louis Vauquelin (1763-1829), acting upon the suggestion of Abbe René Just Haüy (1743-1822), the great French mineralogist and crystallographer who had noted similarities between emerald and other varieties of beryl and suspected they were one and the same species. In 1798 Vauquelin analyzed beryls and discovered the presence of the unique oxide, which he called

HISTORY AND LORE



Portrait de dessin de F. Weyss

par R. Leveau del.

Un savant (Auteur des Traites de Physique et de Minéralogie)

J. A. H. Lucas son Elevé

Fig. 2-14 Engraved portrait of René Just Haüy (1743–1822) from the frontispiece of the first part of J. A. H. Lucas's *Tableau Méthodique des Espèces Minérales* (Paris, 1806).

Emerald and Beryl in Medieval and Modern Europe

Table 2-1
BRISSON'S SPECIFIC GRAVITIES

Name	Mineral	Brisson's Specific Gravity	Modern Value ^a
Emerald of Peru	Beryl	27755 (2.7755)	2.71
Chrysolite of Brazil	Beryl	26923 (2.6923)	2.7
Occidental aquamarine	Beryl	27227 (2.7227)	2.69
Oriental aquamarine	Topaz	35489 (3.5489)	3.53
Emerald of Brazil	Tourmaline	31555 (3.1555)	3.06

^aMean values, from B. W. Anderson, *Gem Testing*, 8th ed. (London: Butterworth's, 1971), pp. 370-1.

glucina (beryllia).⁴⁵ A new element was obviously present, but it was not isolated until 1828 when Friedrich Wöhler and Antoine A. B. Bussy independently produced small quantities of beryllium, or glucinum, as the French called it.⁴⁶

In the same year that he found beryllium oxide, Vauquelin published the first reasonably accurate chemical analysis of beryl⁴⁷ (see table 2-2).

This was the first analysis to show the element chromium in emerald, it previously having been mistaken for iron, and Vauquelin was the first to suggest that chromium was the element responsible for the typical color. Later analyses of beryl by Vauquelin and others corrected the error of including lime (calcium oxide) as an essential component of beryl.

HAÜY AND HIS SUCCESSORS

Within a few years at the end of the 18th century, more scientific knowledge of the beryl was accumulated than had been garnered in all the previous centuries. There were now reasonably accurate analyses, good values for specific gravity, and a clear understanding of the fundamental crystal forms of beryl. Such information was duly incorporated in what may be called the first modern textbook of mineralogy, Abbe René Just Haüy's *Traité de Minéralogie*,⁴⁸ published in Paris in 1801. Following the custom of French mineralogists, he called beryl "émeraude," but he modified the basic term with adjectives to designate other varieties. His text included information on nomenclature, physical properties, crystallography, chemistry, special features of beryl, and descriptions of other minerals that looked like beryl and could be mistaken for it. Classic sources of specimens were also mentioned, such as the small but fine crystals from Elba, the beautiful prisms of aquamarine and golden beryl from Adun Chilon in Transbaikalia, and a new source in the Forèz of Burgundy. Haüy also mentioned that beryls from Colombia were as large as 16 cm

HISTORY AND LORE

Table 2-2
 VAUQUELIN'S 1798 ANALYSIS
 OF EMERALD

Component	Composition %
Silica	64.60
Alumina	14.00
Glucina	13.00
Lime	2.56
Chromium oxide	3.50
Water and volatiles	2.00
Total	99.66%

(6 in) long and 54 mm (2 in) in diameter but that most were much smaller. Much larger crystals were noted from Siberian sources.

Haüy acknowledged the chemical work of Vauquelin, and he noted the electrical properties in beryl claimed to have been observed by Kirwan, the optical property of double refraction, and the presence of typical inclusions in emerald which caused gems of "beautiful green, transparent and free of flaws" to command high prices because of their rarity. Importantly, Haüy believed that iron was the coloring agent in aquamarine but that chromium was responsible for the color of emerald.

From the gemological standpoint, an even greater milestone was reached in 1817 when Haüy published his *Traité des Caractères Physiques des Pierres Précieuses*.⁴⁹ This is the first scientific scheme for systematic gemstone identification, setting forth how gemstones, especially those that were in cut form, could be tested without damage according to color (as the opening argument), specific gravity, hardness, presence or absence of double refraction, frictional electricity, and pyroelectricity. A large table listed stones by color and gave their distinctive properties. For the first time, an optical property, namely double refraction, was recognized as a valuable clue to identity. Haüy admitted the danger of testing for hardness but urged that scratch tests be applied below the girdle of a cut gem where a mark would not be conspicuous.

As an outgrowth of Haüy's work, a small pocketbook of gemology was published in 1832 by Johann Reinhard Blum.⁵⁰ Despite its small size, it contains a remarkable fund of accurate information as well as very specific gem identification methods. The author, later to become an eminent mineralogist of Germany, brought to his writing a scientific background in mineralogy coupled with several years

Emerald and Beryl in Medieval and Modern Europe

practical experience in a jewelry manufacturing center of Germany. Blum provided a good account of beryl, including crystallography, inclusions, properties, streak and blowpipe reactions, fusion, chemical analysis, and locality information. The emerald deposit near Salzburg in Austria is mentioned for the first time in a gemological treatise, as are the recently discovered (1830) emerald deposits of the Urals.

Blum stated that emerald was sawn with emery grit, the facets cut with emery on a copper lap, and then polished on a tin lap using tripoli, pumice, or "tin ash" (tin oxide). Cutting styles and the use of reflective foils were also discussed. Cut emeralds of "medium quality, clear and beautiful, but somewhat light color" were valued at 18 to 24 gulden. Dark stones of the "first water," that is, virtually free of inclusions were much more expensive, fetching from 50 gulden for a 4-grain (ca. 1 carat) gem to as much as 1,600 gulden for a 48-grain (12 carat) stone. Defects of emerald were unevenness or murkiness of color, white flecks or clouds, fissures, and feathers.

Blum provided similar information on beryls, with a note on the relatively recent discoveries of splendid crystals in Russia at Mursinka, Miask, and near Nerchinsk on the mountain Adun Chilon in Siberia, in Transbaikalia. Beryls from Brazil and Scotland were also noted, as was the 1811 discovery in Brazil of an aquamarine crystal weighing 15 pounds and the 1825 discovery of a rolled pebble of "noble beryl of very beautiful color," weighing 4 pounds, which was offered for sale in England at a price of £600.

In 1860, the first truly modern book on gemology, *Handbuch der Edelsteinkunde*,⁵¹ by Karl Emil Kluge (1830–1864), appeared in Leipzig and at once established the pattern for later works on the same subject because the author had discarded curious and romantic lore and enlarged the text sections devoted to the scientific aspects of gemstones. The first or "general" part took up crystallography, physical, optical, and chemical properties, type deposits, uses of gemstones in antiquity, lapidary treatment, chemical and heat treatments aimed at improving color, and gemstones as objects of commerce. The second, or "special" part systematically provided descriptions and sources for all classes of gemstones, including pearls and corals, and tables of properties to be used in identification. Emerald and beryl were accorded much space, and recent scientific data, refinements of older data, and some new locality information on them were incorporated.

Other works along the same lines quickly followed, but the most complete was the now-famous *Edelsteinkunde*⁵² of German mineralogist Max Herman Bauer (1844–1917), first published in 1896, and passing into a third edition in 1932. Bauer devotes twenty-two pages to beryl alone and includes a color plate of beryl rough and cut gems and several crystal drawings. An English translation, *Precious Stones*, completed in 1904 by Leonard J. Spencer,⁵² the English mineralogist, is still regarded as an authoritative work. Bauer's work is notable not only for inclusion

HISTORY AND LORE

Taf. II.

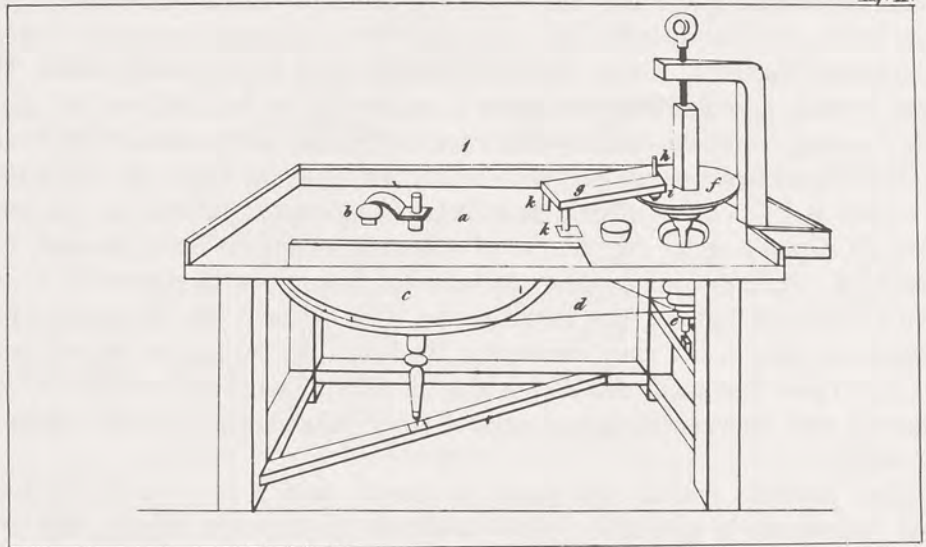

Taf. III.

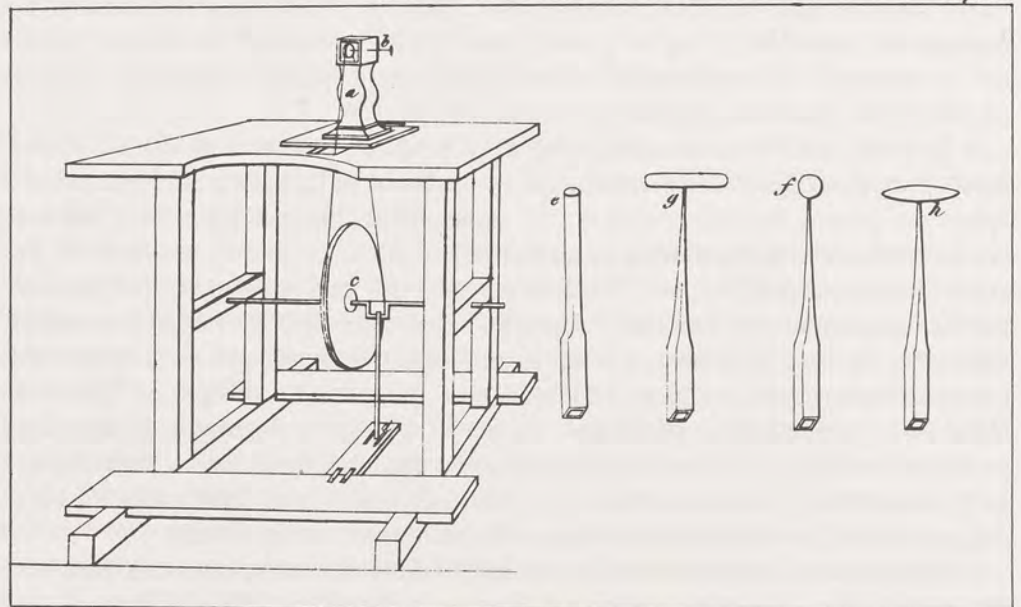

Fig. 2-15 Lapidary apparatus in use in Europe in the early part of the last century. Top: Hand-driven lap (right) with device for holding a gemstone in fixed position. Bottom: Gem engraver's bench with a selection of cutting points. From J. R. Blum's *Taschenbuch der Edelsteinkunde* (Stuttgart, 1832) plates 2 and 3.

Emerald and Beryl in Medieval and Modern Europe

of much information developed since Kluge's book of 1860, but also for much greater attention and accuracy to the sources of gemstones around the world. In addition it features excellent colored lithographic plates of gemstones which are prized for faithfulness to their originals and the beauty of their coloration. Spencer's English edition is still available in facsimile reprints published by Dover Publications of New York and Charles E. Tuttle of Rutland, Vermont.

By the end of the 19th century, much had been learned about emerald and other members of the beryl family regarding physical and optical properties, chemical composition, and the types of deposits in which they were found, and crystallographic studies which defined the numerous types of faces found upon natural crystals and their geometrical relationships to one another had also been devised. Thus it seemed that emerald and beryl, among other minerals, were now fully describable and that nothing further could be learned about them unless some scientific "breakthrough" occurred. Such a discovery was not long in coming, as will be seen below, and involved the use of certain electromagnetic radiations, called x-rays, to penetrate into mineral crystals and derive information about their inner structures that hitherto could only be surmised from external clues.

While the characteristic atomic structure for beryl and other crystalline minerals had long been suspected from such external evidence, it was not until x-rays, discovered by W. K. Röntgen (1845–1923) in 1895, were passed through crystals and their reflections photographically recorded that the regular internal arrangement of atoms could be confirmed. This event, of great importance in the investigation of solids, came about in 1912 when the German physics students, Friedrich and Knipping, following the instructions of their professor Max von Laue (1879–1960), who had first conceived the idea, passed a beam of x-rays through a crystal and recorded a symmetrical pattern of spots on a photographic film. This provided the first concrete evidence that the hitherto conjectured regular arrangement within crystals did in fact exist.

The significance of this experiment was not lost on the father and son team of the English physicists W. H. Bragg (1862–1942) and W. L. Bragg (b. 1890), who surmised that measurements of such spots could result in establishing the positions of the atoms within crystals. Their initial findings and methods of investigation were described in their classic treatise *X-rays and Crystal Structure*, published in 1915.⁵³ They proclaimed that "instead of guessing the internal arrangement of the atoms from the outward form assumed by the crystal, we find ourselves able to measure the actual distances from atom to atom and to draw a diagram as if we were making a plan of a building" (p. 4).⁵³ It is interesting to note that one of the earliest of their spot-production experiments used beryl, for plate 1 of their book shows the pattern produced by passing x-rays parallel to the long or *c*-axis of a beryl crystal. This pattern proves that the external six-fold symmetry of faces on

HISTORY AND LORE

natural beryl crystals is indeed due to a like arrangement of atoms within. Further investigations by W. L. Bragg and J. West resulted in working out the detailed structure, with findings published in 1926.⁵⁴ This structure is described and depicted in Chapter 5 and remains the accepted model.

Literature Cited

1. Thorndike, L. 1923-59. *A History of Magic and Experimental Science*. 8 vols. New York: Columbia University Press. See especially vols. 1, 2, 6, and 7.
2. Adams, F. D. 1938. *The Birth and Development of the Geological Sciences*. Baltimore: Williams & Wilkins. 506 pp.
3. Gesner, C. 1565. *De Omne Rerum Fossilium*. Zurich, 8 books in one.
4. King, C. W. 1865. *The Natural History, Ancient and Modern, of Precious Stones and Gems, and of the Precious Metals*. London: Bell and Daldy. 442 pp.
5. Wyckoff, D. 1967. *Albertus Magnus Book of Minerals*. Oxford: Clarendon Press. 309 pp.
6. Blake, R. P., and De Vis, H. 1934. *Epiphanius De Gemmis*. London: Christophers. 335 pp.
7. Evans, J. 1922. *Magical Jewels of the Middle Ages and the Renaissance*. Oxford: Clarendon Press. 264 pp.
8. King, C. W. 1866. *Antique Gems, Their Origin, Uses and Value*. 2nd ed. London: J. Murray. 498 pp.
9. Alfonso X. 1881. *Lapidario del Rey D. Alfonso X., Codice Original*. Madrid: Imprenta de la Iberia. ca. 200 pp.
10. Kunz, G. F. 1913. *The Curious Lore of Precious Stones*. Philadelphia and London: J. B. Lippincott. 406 pp.
11. Leonardus Camillus 1502. *Speculum Lapidum*. Venice. ca. 120 pp.
12. ———. 1750. *The Mirror of Stones*. London: Printed for J. Freeman. 240 pp.
13. Ball, S. H. 1931. Historical notes on gem mining. *Economic Geology* 26:681-738.
14. Lothrop, S. K., et al. 1937. *Coclé, an Archaeological Study of Central Panama. Part I: Historical Background, Excavations at the Sitio Conte, Artifacts and Ornaments*. Memoirs of the Peabody Museum of Archaeology and Ethnology, Harvard University, vol. 7. Cambridge: The Museum. 327 pp.
15. Schumacher, H. A. 1875. Ueber die columbischen Smaragden. *Zeitschrift der Gesellschaft für Erdkunde* 10:38-62.
16. Canova, L. J. 1921. *Chivor-Somondoco Emerald Mines of Colombia*. New York: Colombian Emerald Syndicate. 30 pp.
17. Codazzi, R. L. 1929. Minas des Esmeraldas. *Boletín de Minas y Petroleos de Colombia* (Bogotá) 1:114-43.
18. Otero Muñoz, G., and Barriga Villalba, A. M. 1948. *Esmeraldas de Colombia*. Bogotá: Banco de la Republica. 133 pp.
19. Tavernier, J.-B. 1925. *Travels in India by Jean-Baptiste Tavernier, Baron of Aubonne* Translated by V. Ball from the original French edition of 1676. 2nd ed. Edited by W. Crooke. 2 vols. London: Oxford University Press. 335, 399 pp.
20. Bandy, M. C., and Bandy, J. A., trans. 1955. *De Natura Fossilium (Textbook of Mineralogy)*, by G. Agricola. Geological Society of America Special Paper 63. New York: Geological Society of America. 240 pp.
21. Arphe de Villafañe, J. 1572. *Quitador de la Plata, Oro y Piedras*. Valladolid. ca. 142 pp.
22. Mosquera, D. de. 1721. *Litho-Statica, Theorica, y Practica de Medir Piedras Preciosas*. Madrid: Francisco del Hierro. 202 pp.
23. Bacci, A. 1587. *Le XII Pietre Pretiose*. Rome. 148 pp.
24. ———. 1603. *De Gemmis et Lapidibus Pretiosis*. Latin translation by Wolfgang Gabelchovero. Frankfurt: Matthiae Beckeri. 231 pp.
25. Morales, G. 1605. *Libro de las Virtudes y Propiedades Maravillosas de las Piedras Preciosas*. Madrid: Luis Sanchez. 378 pp.
26. Boodt, A. B. de. 1609. *Gemmarum et Lapidum Historia*. Hanover: Typis Wecheliani. 2nd and 3rd ed., Leiden: Joannis Maire, 1636 and 1647. French translation, Lyon: Jean-Antoine Huguetau, 1644.
27. Laet, J. de. 1647. *De Gemmis et Lapidibus . . . Theophrasti Liber de Lapidibus*. Lugduni Batavorum. Also Leiden: Joannis Maire; incorporated in 3rd ed. of Boodt above. 210 pp.
28. Cesi, B. 1636. *Mineralogia, Sive Naturalis Philosophiae Thesauri*. Lyon: Iacobi & Petri Prost. ca. 626 pp.
29. Nicols, T. 1652. *A Lapidary: Or, The History of Pretious Stones*. Cambridge: Thomas Buck. 239 pp.
30. Aldrovandi, U. 1648. *Musaeum Metallicum in Libros IIII Distributum*. Bologna: Baptistae Ferronij. 979 pp.
31. Rosnel, P. de. 1667. *Le Mercure Indien, ou le Tresor des Indes*. Paris: Robert Chevillion. 64 pp.

Emerald and Beryl in Medieval and Modern Europe

32. Boyle, R. 1672. *An Essay About the Origine and Virtues of Gems*. London: William Godbid. 185 pp.
33. Spener, J. J. 1687. *De Gemmis Errores Vulgares*. Leipzig: Typis Christophori Fleischneri. 40 pp.
34. Pitt, R. 1703. *The Craft and Frauds of Physick Expos'd*. London: Tim. Childe. 203 pp.
35. Pott, J. H. 1753. *Lithogéognosie, ou Examen Chymique des Pierres et des Terres en Général*. Paris: J. T. Herissant. 431 pp.
36. Thomson, T. 1831? *The History of Chemistry*. 2nd ed. London: Henry Colburn and Richard Bentley. 349, 325 pp.
37. Wallerius, J. G. 1747. *Mineralogia, Eller Mineral-Riket*. Stockholm. 479 pp. French edition published in Paris, 1753.
38. Brückmann, U. F. B. 1757. *Abhandlung von Edelsteinen*. Braunschweig: Fürstl. Waisenhaus-Buchhandlung; 143 pp. 2nd ed., 1773, 415 pp.; with *Beiträge zu seiner Abhandlung* [supplements], 1778; Zwote Fortsetzung [continuation] of the *Beiträge*, 1783.
39. Romé de Lisle, J. B. L. de. 1772. *Essai de Cristallographie*. Paris: Chez Didot. 427 pp.
40. Romé de Lisle, J. B. L. de, and Duguat, Abbé. 1767. *Catalogue Systématique et Raisonné des Curiosités de la Nature et de l'Art qui Composent le Cabinet de M. Davila*. 3 vols. Paris: Chez Briasson.
41. Romé de Lisle, J. B. L. de. 1783. *Cristallographie, ou Description des Formes . . . du Regne Minéral*. 2nd ed. 4 vols. Paris: L'Imprimerie de Monsieur.
42. Bergman, T. O. 1784. *Physical and Chemical Essays, Translated from the Original Latin . . . by Edward Cullen*. vol. 2. London: J. Murray. 518 pp.
43. Achard, F. C. 1779. *Bestimmung der Bestandtheile einiger Edelgesteine*. Berlin: Arnold Wever. 128 pp.
44. Brisson, M. J. 1787. *Pesanteur Spécifique des Corps*. Paris: Imprimerie Royale. 453 pp. German edition published in Leipzig, 1795.
45. Vauquelin, N. L. 1798. Analyse de l'aigue marine, ou béril; et découverte d'une terre nouvelle dans cette pierre. *Annales de Chimie*. 26:155-70.
46. Weeks, M. E. 1939. *Discovery of the Elements*. 4th ed. Easton, Pa.: Journal of Chemical Education. 470 pp.
47. Vauquelin, N. L. 1798. Analyse de l'émeraude du Pérou. *Annales de Chimie* 26:259.
48. Haüy, R. J. 1801. *Traité de Minéralogie*. 5 vols. Paris: Chez Louis.
49. ———. 1817. *Traité des Caractères Physiques des Pierres Précieuses*. Paris: Mme Ve Courcier. 253 pp.
50. Blum, J. R. 1832. *Taschenbuch der Edelsteinkunde*. Stuttgart: Carl Hoffman. 356 pp. 2nd ed., 1834; 3rd ed., 1887, 341 pp.
51. Kluge, K. E. 1860. *Handbuch der Edelsteinkunde*. Leipzig: F. A. Brockhaus. 561 pp.
52. Bauer, M. H. 1896. *Edelsteinkunde*. Leipzig: C. H. Tauchnitz. 2nd ed., 1909; 3rd ed. revised by K. Schlossmacher, 1932, 871 pp. English edition: *Precious Stones*, translated by L. J. Spencer. London: Charles Griffin and Co., 1904. 627 pp.
53. Bragg, W. H. and Bragg, W. L. 1915. *X-rays and Crystal Structure*. London: G. Bell and Sons. 228 pp.
54. Bragg, W. L. and West, J. 1926. The structure of beryl. *Proceedings of the Royal Society of London*. A-111, pp. 691-714.

CHAPTER

3

BERYL IN MAGIC, MYSTERY,
AND MEDICINE

MUCH gemstone lore is derived from the teachings of astrology, an ancient science that "treats of the influence of the stars upon human affairs, and of foretelling terrestrial events by their positions and aspects" (*Webster's New International Dictionary*, 2nd ed., unabridged, 1944). Astrology was practiced by the Chaldeans, Egyptians, Greeks, Romans, Persians, and Hindus, among others, and even flourished in Europe until the 17th century. Its greatest development was reached in countries, such as those along the Mediterranean and in the Near East, where a dry climate permitted prolonged observations of celestial bodies.

The obvious role of the sun in giving warmth and light and encouraging the growth of plant and animal life through the mysterious agency of its rays lent credence to the view that all celestial bodies exercised similar influence. Also, the fact that the sun, moon, and planets traveled across the heavens along predictable paths, sometimes nearing each other, sometimes drifting apart, further suggested that their separate influences could work together at auspicious moments to exercise greater force than if working singly. Thus the powers of the celestial bodies, coupled with their movements, were deemed to implant in individuals a character and preordained destiny from the moment of birth, and future planetary conjunctions were thought to influence not only individuals but entire populations as well.

Heavenly bodies were also thought to influence inanimate objects, particularly metals, minerals, and gemstones, imbuing them with part of their powers. In turn, such substances re-radiated these energies, forming auras about themselves that influenced anyone coming within their range. Not all substances were empowered

Beryl in Magic, Mystery, and Medicine

alike, according to the astrologers; some substances received their greatest energy from one celestial body in particular and formed bonds of "sympathy" with that body as well as with other substances that shared similar sympathies. For this reason it was vital that a person learn what celestial events established his life-pattern at birth and thenceforth wear or use only those substances, including gemstones, which harmonized with this pattern and with his own spiritual, mental, and physical traits.

From these fundamental astrological principles are derived the beliefs in the beneficial, protective, or healing properties of stones and the conviction that one must avoid contact with stones that may be harmful. This is the basis for birthstones, amulets, and talismans, all worn to promote good fortune and provide personal protection against baleful influences.

EARLY EGYPTIAN AND GREEK LORE

Because the first emeralds came from Egypt, Egypt is also the source of the earliest attributions of magical power to that gemstone. Its color, the color of vegetation, assumed great significance to the ancient Egyptians and was the color cherished above all others, as we are told by Schneider,¹ citing Heinrich Brugsch, the noted Egyptologist. Green symbolized the cycle of sowing, nurturing, and harvesting of crops, and it represented in particular the annual flooding of the Nile lowlands in what seemed to be a miraculous restoration of life to a land that stood parched and brown throughout most of the year. Green therefore became the symbol for joy and desire and fertility in females. (The importance of color in symbolism and superstition is emphasized by the space devoted to green alone in Kunz's *Curious Lore*.²) Giacinto Gimma, writing in Italy in the 18th century on the lore of gemstones,³ noted that green signified joy, transitory hope, decline of friendship, and, for women, unfounded ambition, childish delight, and change. Moreover, anyone dreaming of a green gem would become famous and meet with truth and fidelity.

In his studies of Egyptian amulets, Petrie⁴ found several that employed beryl. An amulet in the shape of a heart, three of which are shown in figure 3-1, signified "power of living and will." Another, shaped like a papyrus frond, meant "flourishing," as in green plants, and also "youth," while an amulet in the form of two feathers meant "elevation." Petrie also recorded amulets of beryl which were designed to protect their wearers from snake bites and recurrent malarial fevers, although in a later work on scarabs,^{4a} he flatly states that "beryl and emerald is unknown in scarabs, and was only worked after the cessation of scarab making."

Egyptian lore gradually spread to other lands through cultural and trade connections, but it is now impossible to observe any direct influence of such lore on the ancient Greeks, judging from its absence in Theophrastus's *Peri Lithon*.⁵ However, Theophrastus contributed one bit of lore by noting that the emerald suffuses

HISTORY AND LORE

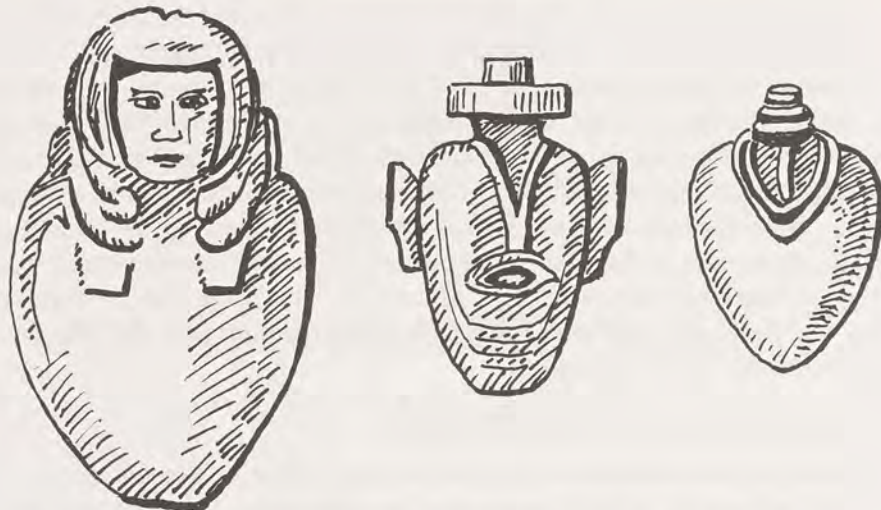

Fig. 3-1 Beryl was sometimes carved into talismans, like these "heart" talismans of ancient Egypt.

a green light throughout water in which it is immersed. This statement was taken up by Pliny in his *Natural History*, but with the important modification that the suffusion affects the air surrounding the stone, failing to mention that Theophrastus limited the effect to water.⁶ Thus Pliny stated "when viewed from a distance . . . [emeralds] . . . appear all the larger to the sight."

Of greater interest by far is the statement made by Theophrastus and elaborated upon by Pliny that merely viewing the emerald soothed the eyes, for which reason, said Pliny, "people carry seals made from it, so as to see better." Eventually these simple statements gave rise to a host of protective and curative powers involving the emerald and eyesight, as will be noted further along in this chapter.

Pliny also incorporated bits of emerald lore taken from sources other than Theophrastus, the best known being the observation that Emperor Nero viewed the gladiatorial games in Rome through an emerald eyeglass. However, Pliny's original statement merely said that Nero viewed the games "upon a smaragdus." Through later recounting, the story became transformed into viewing the games *through* an emerald, suggesting that Nero used some sort of lens, possibly to correct a vision defect. In view of the small size and imperfection of Egyptian emeralds, it seems highly unlikely that Nero ever owned such a lens. Furthermore, the term "smaragdus," as noted before, may actually have referred to some sort of green stone other than emerald, for example, a polished piece of green jasper, which could have been easily obtained in large size and served as a mirror rather than a lens.

INDIAN GEM LORE

While little curious lore on emerald and other beryl varieties can be traced to ancient Egyptian and Greek sources, a veritable flood emanated from ancient India. Tagore⁷ provides a wealth of information derived from Sanskrit sources and possibly incorporating some Egyptian lore, as in the case of emeralds being effective against poisons and snake bites. These ideas could have germinated in both lands at once, but it is more likely that they were imported into India along with the emeralds of Egypt. On the other hand, it seems certain that a large body of curious lore was indigenous to India and was transmitted to Arabic lands and into Spain via the Moors. A late development of gemstone lore in India is suggested by Finot,⁸ who stated that the ancient Indian books on stones, the subject of his monograph, existed only in the 6th century A.D. They might have been written earlier, but Finot could find no evidence to that effect.

Indian gem lore is remarkable for its quantity and complexity. In it we can find many attributes of beryls which appear in European lapidaries of later periods. Because the Sanskrit works examined by Tagore and Finot bore the weight and importance of pronouncements from the Gods of the Hindu pantheon, it is not to be wondered why an elaborate ritual in the wearing of gems is even now observed in India. This is made clear by Tagore,⁷ who noted that the *Puranás* (one of four classes of *Shastas*, or Hindu scriptures) require the wearing of gems because this "brings respect, fame, longevity, wealth, happiness, strength, and fruition," while "over and above this, it wards off evil astral influence, makes the body healthy, removes misery and ill-fortune, and washes away sin."

These benefits, however, were restricted to only the "precious nine gems," namely, diamond, ruby, cat's-eye chrysoberyl, pearl, zircon, coral, emerald, topaz, and sapphire.⁸ These are the classic talismanic gems of the *nava-ratna* or *nao-ratan* of Hindu lore, which Birdwood⁹ compares to the *urim* and *thummim* of the Jews, and which were commonly strung together in necklaces to signify the nine sages of the court of Vikramaditya (56 B.C.).

The great importance attached to gems was reflected in the detailed advice given in the Sanskrit lapidaries on their selection in respect to color and freedom from flaws. Tagore, for example, described the color shades of emerald, and likened them to similar hues in plants and animals, and enumerated the "seven defects" which must be avoided. "An emerald which is not cool, is called a *Rukshma*; it leads to disease. That which has a yellow spot, is called *Bishfota*. Death from wounds inflicted by a weapon may be apprehended from wearing it." Other defects include "an emerald to which a stone fragment is inseparably attached," which is baleful in its influence, while one that is dirty, called a *Bic'c'háya*, may bring on a variety of diseases. Another kind, "containing gritty fragments," is termed *Kara-*

HISTORY AND LORE

kara and causes the death of the owner's son. An "ugly" emerald is a *Jathara* and "renders one liable to bites." Even worse is an emerald "the colour of which is like that of *Mashakalai* [not further defined] which is fatal to its wearer."

In another place, Tagore mentioned that "purity, weight, coolness, freedom from dust, and beauty, are the five principal qualities of Emeralds" and such "cleanses men from all sin." Furthermore, the emerald "causes increase in wealth, brings success in wars, cures cases of poisoning, and renders successful the rites performed according to the *Atharva-Veda*." Tagore also noted that "any gem excepting an Emerald found to be broken should not be worn;—nay, should not by any one who has a care for his good."

Several simple tests for emerald are available, according to Tagore. "Any Emerald which raises doubts as to its genuineness, should be rubbed against a real one, when the former, if false, will be broken" and "scratch an Emerald with . . . the iron pen . . . and then smear it with lime. By this process a false Emerald will grow exceedingly dim, while a real one will attain additional brilliancy."

These ancient admonitions persist in modern Indian gemological works, such as in Tank,¹⁰ whose book is a paradoxical mixture of modern scientific gemology and ancient wisdom. According to Tank, "a fine emerald possesses the following seven merits:—(1) rich green colour . . . (2) weighty, of high specific gravity . . . (3) lovely, luminescent . . . (4) twinkles, sparkles with brilliance . . . (5) it captivates the heart and brings a feeling of peace to the mind. It has a quality almost physically soothing to the eye . . . (6) transparent . . . [and] (7) it is of a velvety reflection."

Two distinct aspects of Indian lore are apparent: first, the insistence on high quality in the choice of an emerald, and second, the direct connection between quality and the powers attributed to the stone. Thus the higher the quality, the greater the powers, and conversely, the poorer the quality, the greater the danger that the gem will be actually harmful rather than merely weak in its influence. The baleful effects of wearing a wrong gem were vividly described by Bhattacharyya,¹¹ who cited the case of a merchant who wore the wrong gem, in this instance a ruby, and promptly fell sick. A horoscope cast by an astrologer identified the ruby as the baleful influence, and when it was removed from the person, and from the house itself, the merchant instantly became well.

It should be noted that almost the entire body of Indian lore recounted by Tagore, Tank, and others makes its appearance in Europe. This strongly suggests, as mentioned before, that much Western emerald lore is derived from the Indian.

Ancient Indian writings also account for the origin of gemstones, including the emerald. Tagore recites this colorful tale from the *Puranás*: An adversary of the gods, an *asura* (demon) by the name of Vala, had defeated the gods and proved invincible to their powers. However, he was tricked into turning himself into a

Beryl in Magic, Mystery, and Medicine

sacrificial beast, thus losing his invincibility. He subsequently whirled himself through the air and destroyed himself completely, but the merit acquired by this sacrifice made every part of his body the origin of gems. Wherever his bones fell, there formed diamonds. His blood, each corpuscle the germ of a gem, showered down into the vale of Ceylon, forever endowing its streams with a variety of gems. His teeth fell into the sea, forming pearls. Meanwhile, the bile of Vala had been acquired by the snake Sessa, the monarch of all snakes, but, frightened by an attack from Garuda, the king of all birds, Sessa dropped the bile on the shores of an ocean and, ever since, that place has been a mine of emeralds. (This last sentence suggests Egypt, which was accessible by sea from India, especially via the Red Sea port of Berenice, which is not far from the inland emerald mines.)

EARLY EUROPEAN LORE

The development of a large body of curious lore in Europe is noted by Thordike,¹² Adams,¹³ and especially Kunz in his *Curious Lore*² and *Magic of Jewels and Charms*.¹⁴ The role played by beryl varieties in amulets and talismans is the subject of comprehensive works by Bonner,¹⁵ Budge,¹⁶ the Pavitts,¹⁷ and more recently by Hansmann and Kris-Rettenbeck.¹⁸

According to *Webster's New International Dictionary* (2nd ed., unabridged 1944), "talisman, amulet, charm are often interchangeable. But Talisman connotes wider and more positive powers than Amulet, which applies esp. to an object worn to avert evil." Bonner¹⁵ considers talisman "virtually a synonym" of amulet, "although some writers have attempted without support in general usage, to differentiate the two." Some idea of the bewildering variety of form that these charms have taken appears in Budge¹⁶ and in Hansmann and Kris-Rettenbeck,¹⁸ the latter especially fine because of its illustrations of types developed in many lands at various times. Egyptian charms are also treated extensively in Petrie.⁴

The purpose of all such charms is protection of the person and, to a lesser extent, enhancement of physical and mental powers. In ages when disease struck down rich and poor alike, when life was subject to the wildest uncertainties, it was only natural that disasters were ascribed to the caprices of gods and spirits who might be appeased through the employment of magical devices, incantations, and sacrifice. Thus Bonner¹⁵ noted that the "belief in the efficacy of amulets depends upon certain primitive concepts of mind, namely, notions that supernatural power may be inherent in some person, animal, or material object, or that it may at least reside there temporarily."

Much of early European lore was incorporated in the celebrated poem on gemstones written by Marbod, Bishop of Rennes (ca. 1035–1123 A.D.). Composed between 1067 and 1101, it contains stanzas on both emerald and beryl. These stanzas are excerpted here from King's translation.¹⁹ The substance of the poem

HISTORY AND LORE

was taken from Pliny, Isidore of Seville, and other sources. The poem represents a summary of the lore known up to Marbod's time, and it became the basis for virtually all statements made on curious lore by succeeding writers. It is discussed at length by Thorndike¹² and Adams.¹³

THE LAPIDARIUM OF MARBODUS

Stanza VII

Of all green things which bounteous earth supplies
 Nothing in greenness with the *Emerald* vies;
 Twelve kinds it gives, sent from the Cythia clime,
 The Bactrian mountain, and old Nilus' slime;
 And some from copper mines of viler race
 Marked by the dross drawn from their matrix base:
 The Carchedonian from the Punic vale—
 To name the others were a tedious tale.
 From all the rest the Scythian bear the palm
 Of higher value and of brighter charm,
 From watchful gryphons in the desert isle
 Stol'n by the vent'rous Arimaspians' guile.
 Higher *their* value which admit the sight,
 And tinge with green the circumambient light:
 Unchanged by sun or shade their lustre glows,
 The blazing lamp no dimness on it throws.
 Such as a smooth or hollow surface spread
 Like slumbering ocean in its tranquil bed.
 These like a mirror in the beholder's face
 Exactly image with reflected rays:
 And thus did Nero, if report say true,
 The mimic warfare of the arena view.
 But best the gem that shews an even sheen,
 Lustrous with equal never varying green.
 Of mighty use to seers who seek to pry
 Into the future hid from mortal eye
 Wear it with reverence due, 'twill wealth bestow
 And words persuasive from thy lips shall flow,
 As though the gift of eloquence inspired
 The stone itself or living spirit fired.
 Hung round the neck it cures the ague's chill,
 Or falling sickness, dire mysterious ill;
 Its hues so soft refresh the wearied eye,
 And furious tempests banish from the sky:
 So with chaste power it tames the furious mood
 And cools the wanton thoughts that fire the blood.
 If steeped in verdant oil or bathed in wine
 Its deepened hues with perfect lustre shine.

From C. W. King, *Antique Gems, Their Origin, Uses and Value*. London: J. Murray, 1860, pp. 396-98

Beryl in Magic, Mystery, and Medicine

Stanza XII

Cut with six facets shines the *Beryl* bright,
Else a pale dullness clouds its native light;
The most admired display a softened beam
Like tranquil seas or olive's oily gleam.
This potent gem, found in far India's mines,
With mutual love the wedded couple binds;
The wearer shall to wealth and honours rise
And from all rivals bear the wished-for prize:
Too tightly grasped, as if instinct with ire,
It burns th' incautious hand with sudden fire.
Lave this in water, it a wash supplies
For feeble sight and stops convulsive sighs.
Its species nine, for so the learned divide,
Avail the liver and tortured side.

OCCULT PROPERTIES

Despite the large number of properties assigned to emerald and beryl in the list below, most are merely variants or embroideries on a few fundamental themes, almost all arising from the belief that these gemstones confer protection against real or imagined evils, hazards, and illnesses, or somehow improve the mind and character of the user. It is impossible to cite all authorities who have at one time or another commented on the occult lore of beryls, and only those of greatest importance are noted.

Personal Traits and Character

Agreeableness—Emerald renders one agreeable²⁰ or amiable;² beryl is a "sweet-tempered" stone.²¹

Benevolence of Heart—Emerald imparts.²²

Candor—Emerald promotes;²³ emerald "forces confession."²¹

Celestial Communion—emerald promotes.²²

Charity—Beryl symbolic of (from Swedenborg²⁴); emerald symbolic of.²⁵

Cleverness—Beryl confers (from A. Magnus²⁶); emerald "sharpens wits" (from Cardan²).

Constancy of Mind—Emerald promotes (from Cardan²).

Courage—Emerald symbolic of.²⁸

Dignity—Emerald confers (from Mandeville²⁸).

Discretion—Emerald imparts.²⁰

Eloquence—One of the principal personal traits imparted by beryl: early mention by Marbod;¹⁹ emerald aids persuasiveness in pleading one's cause (from A.

HISTORY AND LORE

Magnus²⁶); emerald makes one "comfortable with words";³⁰ emerald imparts (from Braun¹⁴) or promotes.³¹ Beryl aids in promoting one's view but only if immersed in water, the latter exposed to the sun and then drunk.³¹ Emerald bestows eloquence but only if worn by those born between 22 June and 23 July, and by those with the moon in a good aspect.¹⁸

Faith—Beryl symbolic of²¹ (and from Swedenborg²⁴); emerald bolsters faith during struggles with enemies or during adversity^{25,31} or symbolizes "exalted faith,"¹⁸ or "faith in adversity."³²

Fame—Delivered by wearing an emerald.^{7,18}

Friendship—Emerald signifies decline of³ but also promotes(!)^{23,28,32}

Glory—Emerald symbolic of "divine glory."³³

Goodness—Emerald symbolic of^{25,28,32} or promotes.³¹

Grace—Emerald confers,³⁰ promotes,³¹ or symbolic of.²⁵

Happiness, Cheerfulness, Joyousness—Emerald imparts^{24,25,31,34} or brings⁷ or imparts "holy joy."²² Emerald signifies³ and was used in rings by early church officials in England for such.³⁵

Harmony—Emerald symbolic of³¹ or promotes.²³

Honesty, Incorruptibility—Emerald makes its owner honest (from Mandeville;²⁹ from Cardan²). Aids owner if actions based on honesty, but works against owner if not.^{24,31} Beryl confers.²⁴

Honor—Beryl confers,²⁴ beryl confers (from Marbod¹⁹), dreams of beryl may confer.³¹

Hope—Emerald denotes²⁵ or signifies "transitory hope."³

Humility—Emerald symbolic of, traced to Catholic Church of 15th c.³³

Humor—Emerald "softens biting humor."³¹

Idleness—Emerald cures,² but beryl is "sovereign remedy against."¹⁸

Immortality—Emerald imparts possibility of²² or is symbolic of "hope of immortality," attributed to Eastern lore;¹⁸ emerald symbolic of.^{21,25}

Insight—Beryl confers;²⁵ gives, to cabalists.²¹

Intellect, Intelligence—Emerald strengthens;³¹ quickens (from Cardan,² but Fobes²⁵ also cited Cardan, stating that it improves intelligence by making persons more honest and true).

Judgment—Emerald augments (from Cardan³⁶).

Kindness—Emerald symbolic of.^{25,32}

Knowledge—Emerald imparts.³⁷

Memory—Emerald improves²⁰ (and from A. Magnus;²⁶ and from old Indian lore);¹⁸ emerald aids³⁸ or strengthens (from Braun¹⁴); when worn in a ring, strengthens;¹⁸ improves memory, but best results obtained if worn on index finger.²⁵

Mental Weakness or Panic—Emerald prevents,²⁴ is good for,³⁹ averts terrors of;⁴⁰ emerald hung about the neck dispels "vain fears" (from Braun¹⁴).

Mercy—Emerald symbolic of.²⁵

Beryl in Magic, Mystery, and Medicine

Narcissism—A flat emerald is a very good mirror for self-admiration (from Mandeville²⁹).

Obedience—Emerald and the color green are symbolic of.³³

Prudence—Emerald augments (from Cardan³⁶).

Purity—Beryl revered in East as symbol of;¹⁸ one's thoughts are purified by gazing into an emerald.²⁵

Respect—Brought in part by emerald.⁷

Sin—Emerald "washes away";⁷ gives victory over²¹ or fights against.³¹

Sincerity—Aided by golden beryl.³¹

Skepticism—Emerald imparts (from Cardan²).

Slovenliness—Emerald enemy of (old Russian legend).

Spiritual Weakness—Emerald prevents.²⁴

Sympathy—Golden beryl generates.³¹

Temperament—Emerald, worn or taken as a medicine, confers contentment of mind;^{7,41} tames fury and wanton thoughts (from Marbod¹⁹), or avoids tempests (of the mind?),³⁰ or calms a stormy disposition (from Mandeville²⁹), but A. Magnus says beryl imparts mildness²⁶ and Fairholt³⁵ noted that emerald was symbol of tranquility when worn in the rings of early English church officials. Emerald makes one ready for peace.³¹

Temptation—Emerald aids in resisting.³¹

Truth—Beryl symbolic of (from Swedenborg²⁴); emerald blesses the truth-seeker;³¹ emerald promotes.²³

Understanding—Emerald promotes.³¹

Wisdom—Emerald imparts²² and makes owner "wise in speech" (from Mandeville²⁹).

Youthfulness of Heart—Emerald promotes.^{25,31}

Corporal Dangers

Ambushes—Beryl averts;⁴⁰ emerald averts.⁴⁴

Combat—Emerald gives victory in²¹ (and from A. Magnus²⁶); makes wearer "unconquerable" or helps win battles;² bolsters one's faith in battles against enemies.³¹

Disasters—Beryl especially effective against "sudden."³¹

Fishermen, Mariners, Travelers at Sea—Protected by wearing beryl (old Greek lore, cited in Kunz,² who noted that all such amulets were designed to appease Poseidon); beryl protects against dangers and illnesses while at sea;³¹ emerald protects, but must be worn around the neck with stone lying on breast, the part of the body ruled by Cancer;¹⁸ beryl protects, while emerald protects due to its connection with Isis, the moon, and the tides.³⁹

Imprisonment—Emerald engraved as a gnostic gem releases from.²¹

Invisibility—Emerald may confer, if wearer is celibate,^{21,25} Jones⁴³ cites story

HISTORY AND LORE

of Shah of Persia who carried about a small casket studded with emeralds which conferred invisibility, providing he remained celibate.

Travelers on Land, Adventurers—Emerald protects if worn on left arm attached with green cord, then especially effective against evil spirits met along the way (old Persian^{18,39}); emerald generally protects,^{23,31} on land or water.²⁸ Beryl protects against dangers and illness.³¹ Emerald confers success in travel and change but must be worn as a birthstone, engraved with Gemini design or the name Saraiel.²⁸

War—Emerald assures success in.⁷

Love and Marriage

Adultery—Emerald uncovers²⁰ or reveals (from Braun¹⁴).

Chastity—Emerald confers (from Marbod¹⁹) or is symbolic of (from A. Magnus;^{26,30,33}) emerald preserves,^{20,24} but only in women(!)⁴⁰; spontaneously breaks as a sign of a woman's loss of.⁴⁰

Fertility—Emerald brings;⁷ emerald, or other green stone, is symbolic of.¹⁷

Love—Emerald revives conjugal;³⁰ color deepens as love heightens;^{25,28,31,34} reveals truth or falsity in love, and reawakens;² confers happiness in;^{21,25} emerald is most appropriate gift among loving couples.³⁹ Beryl enhances mutual love²⁴ and preserves and increases it, and keeps it "true and constant";¹⁸ preserves and increases conjugal love;³⁴ aquamarine brings luck to a loving couple because it assures "truth."³⁹

Marriage—Emerald promotes domestic felicity²⁸ and is best for binding together.²³ Beryl helps reach agreement in (from A. Magnus²⁶), binds together (from Marbod^{19,24}); aquamarine amulet assures a "fortunate marriage."³⁹

Sexual Intercourse—Emerald, if "good and genuine," shatters during (from A. Magnus, citing experience of King of Hungary²⁶); shatters during^{2,20,24} (and from Mandeville²⁹ and Cardan³⁶); betrays violation of woman's chastity by breaking.⁴⁰

Passionate or Wanton Thoughts—Emerald suppresses (from Marbod¹⁹); is symbolic of.²

Virility—Amulet with emerald or other green stone is symbolic of (old Egyptian¹⁶).

Wedding Gift—A beryl gem is very appropriate "morning gift" on day after wedding from bridegroom to bride: it absorbs and preserves the wonderful atmosphere of young love (old Roman⁴⁵); aquamarine or beryl a most appropriate gift.^{18,31,39}

Business Transactions

Business Dealings—Emerald worn during increases owner's importance in presence and speech (from Aristotle¹⁹); if worn during, confers advantages, provided dealings are honestly conducted.²⁴

Beryl in Magic, Mystery, and Medicine

Disputes—Beryl helpful in winning, while emerald confers persuasive speech in pleading one's case (from A. Magnus²⁶); emerald gives victory of "trial";²¹ emerald helps settle litigation.²

Enemies—An emerald set in a ring confers on wearer power to strike terror in hearts of all who would look at him;⁷ beryl or aquamarine vanquishes, or protects from (from A. Magnus²⁶); emerald brings strength in battle against (from Rabanus Maurus³⁹); emerald pacifies,²¹ or protects from "bad women who attract men in order to kill them" (from Mandeville²⁹).

Favor of Rulers—Emerald gains.²¹

Loss of Possessions—Emerald helps recover (from Marbod¹⁹).

Misery—Emerald removes.⁷

Slander—Beryl protects from.¹⁸

Strife—Beryl protects from.³¹

Success—Beryl confers^{7,24} (and from Marbod¹⁹) or increases.³⁰

Treachery—Emerald jumps from setting if present; Fernie⁴⁷ cites case of George III who lost American colonies when his coronation was marred by an emerald dropping from diadem.

Trickery—Emerald is enemy of.²⁵

Wealth—Owner of an emerald never becomes poor;⁷ emerald confers^{24,25} (and from Marbod,¹⁹ from Mandeville,²⁹ from Braun¹⁴); emerald increases (from A. Magnus²⁶). Aquamarine imparts.³¹ Emerald confers by imparting frugality to owner (from Cardan²).

Demons and Evil Spirits

Demons—Summoned, when a beryl is gazed into (from Marbod¹⁹); emerald drives away "water demons and mermaids."²¹

Evil—Cannot stand in presence of an emerald;¹⁸ emerald soothes persons whose behavior is evil (from Mandeville²⁹).

Evil Spirits—Emerald repels;⁴⁰ drives away when worn around neck (from Braun¹⁴); efficacious against;^{41,42} evil astral influence warded off by emerald.⁷

Evil Eye—Emerald wards off;^{23,31} with other stones, wards off.¹⁷

Evil Spirits Met during Travel—Emerald tied to left arm by green cord effective against (old Persian^{18,39}).

Fascination and Spells—Beryl and emerald effective in countering helplessness against (from old Egyptian lore¹⁷); emerald worn on left arm avoids (from Cardan) or prevents magician from casting a spell;²⁵ emerald confers "disenchantment".²¹ But powers of beryls against demons and evil spirits are lost if emerald or beryl is allowed to touch a corpse (from Marbod¹⁹); Albertus Magnus²⁶ notes that these stones have a "horror of death." Pavitt¹⁸ claims that when the power of an emerald to deflect or nullify evil influences is lost, it will fall from its setting.

HISTORY AND LORE

Magic—According to Kunz,² a magician in China, to most effectively perform his rites, must wear certain robes and gems for each day of the week: “on Thursday, appointed for the Works of Religion or Politics . . . a ring must be worn set either with emerald or sapphire. On Friday, however, the celebrant of the rites must wear a tiara set with lapis lazuli and a beryl.”

Divination, Dreams and Discoveries

Calls—The “diadochus,” thought to be a beryl, effective in calling up spirits by magicians (from A. Magnus²⁶). Beryl is successful in calling spirits of the departed, but the stones must first be engraved with an eagle or the plant *Artemisia dracunculus*.⁴⁵ Emerald held in mouth is effective in calling up the Devil and obtaining answers to questions put to him.²⁵

Discovery of Lost or Hidden Things—Beryl effective in finding.¹⁸

Discovery of Secrets—Emerald helps (from old Indian lore¹⁸); also,³⁹ emerald “opens” secrets.³¹

Divination—Emerald effective for “all types” (from Aristotle,¹⁹ from Marbod,¹⁹ and from Mandeville²⁹); confers power of (from Braun²). A. Magnus²⁶ claims ability in divination improved by use of emerald; effective only if placed under tongue;⁴⁵ used in India.¹⁸ Beryl especially effective in;^{18,24,31} gives “insight, foresight, and second-sight.”²¹ Emerald can predict future, but only if “light green” and placed under tongue, when it confers second-sight and foresight;²⁵ on the other hand, the same author, Fobes,²⁵ notes that the emerald is the enemy of conjurers and tricksters and that magicians cannot weave spells if an emerald is near!

Dreams of Emerald or Beryl—Who dreams of emerald will become renowned and will meet with truth and fidelity;³ also signifies worldly goodness and benefit, happy news to come, or loving friendships;²⁴ implies climb to higher position of honor;³¹ much to look forward to.²⁵

Dreams, Disturbing—Emerald protects against if worn on breast or drives away “idle dreams” if worn around neck.^{31,34}

False Friends—Emerald effective in discovering treachery by jumping out of setting (old Roman legend); discovers by changing color;⁴⁰ effective against.²⁸

False Witnesses—Emerald discovers by changing color.^{28,40}

Falsehood—Emerald discovers by becoming paler.¹⁸

Oracular Uses—Beryl, if held in mouth, enables one to call upon any “elemental” and receive satisfaction of any question asked (from Freeman²⁴); emerald teaches “unknown secrets.”¹⁸

Divination methods employing beryl, described by Kozminsky²⁴ and Fobes,²⁵ required suspending a beryl by a thread over a bowl of water, and, according to Kozminsky, just touching the surface. The inner edges of the bowl are lettered with the alphabet and while the diviner holds the top of the thread, the beryl, presumably

Beryl in Magic, Mystery, and Medicine

impelled by a spiritual influence, strikes certain letters which spell out answers to questions. Fobes claimed this was practiced in 17th-century Europe. Another method, also involving a water-filled bowl, merely requires that the beryl be thrown into the water, and from the resulting surface disturbances the seer is able to divine messages.

Another divination method was to gaze into a polished sphere of beryl and interpret the images seen therein. Thomas's monograph on crystal-gazing⁴⁸ cites Aubrey's *Miscellanies* (1696) regarding such a crystal, it being "a perfect sphere, the diameter of which I guess to be something more than an inch," which size is consistent with the scarcity of reasonably clear beryl crystals at that time. This is the only mention of beryl in Thomas's book, yet Jones⁴³ stated that the "crystal has been the most popular of all oracles [and] the favourite stone was a beryl." This was echoed by Melville⁴⁹ in his monograph on crystal-gazing, in which he says that "the crystal which has ever found the most favour for the purposes of 'crystallomancy,' or divination through the medium of 'crystal-gazing' is the *Beryl*." Fernie⁴⁷ repeats this claim, going on to say that the "favourite shade of the Crystal, as used by ancient seers, was that of the pale water-green Beryl, or delicate aquamarine; this water-green being astrologically considered as a colour especially under the influence of the moon, an orb exerting great magnetic influence."

Fernie and others attribute the effectiveness of beryl to its slight content of iron as revealed in modern chemical analyses, thus accounting for the "magnetic influence," which presumably affected the user of the sphere. However, it is highly unlikely that reasonably large and clear crystals of beryl were available in Europe in such early periods, much less being so abundant that they became the "favorite." A more likely explanation is that "beryl" spheres were merely common glass, one of the most common kinds being tinged with precisely the "water-green" color mentioned above.

THERAPEUTIC USES OF EMERALD AND BERYL

The idea that gemstones were efficacious in treating disease probably originated concurrently with the gems' employment in amulets designed to supplicate the gods, bring good fortune, or provide personal protection. Indeed, if the gems could exert such powers externally, why shouldn't they be even more effective when crushed into a powder and swallowed to bring them closer to the seat of trouble?

In reviewing the knowledge of the ancients, Thorndike (vol. 1)¹² makes clear that the Egyptians and other peoples of the Near East already had a well-developed pharmacology, and while the use of gemstones in pharmaceutical preparations is not specifically mentioned, it may be assumed that because of the widespread faith in amulets and pharmacological practices of the time, gems may have been used in medicinal preparations.

HISTORY AND LORE

Schmidt³³ is of the opinion, however, that the real home of gemstone homeopathic medicine is India, where "precious stones, as effective healing agents, were given in old medical books along with gold." He goes on to say that "in the ancient-classical literature there are no evidences of medicinal use of precious stones aside from a few in Dioscorides concerning lapis-lazuli, sapphire, and bloodstone, which were counted among the mineral medicines," and that the "Arabs first shaped gemstone therapy into a system." Schmidt also cited H. Fühner's *Lithotherapie* (Berlin, 1902) as the authority for a note on Arab physicians being the first to separate the medicinal uses of gemstones from their superstitious or talismanic uses, thus placing gemstones in the class of specific medicines capable of being prescribed for specific ailments. "The really hard gemstones," said Fühner, among them the emerald, "were first introduced into European pharmacopeias through the Arabs."

In contrast to the belief in the *chemical* effectiveness of internally administered gemstones is the belief in the effectiveness of gemstones due to their "auras of energy." In fact, mere contact with skin over some point of pain or seat of ailment was considered sufficient to alleviate or cure. This belief persisted for many centuries in Europe and appears very much alive in present-day India. For example, Parahansa Yogananda, in his *Autobiography* (Los Angeles: Self-Realization Fellowship, 1956) writes that "pearls and other jewels as well as metals and plants, applied directly to the human skin, exercise an electromagnetic influence over the physical cells."

An even more recent Indian work on gem therapy by Bhattacharyya¹¹ emphasizes the importance of colored light rays, especially as embodied in gems, and gives specific instructions on how their "colour contents" can be converted into medicines or used in "distant healing." Thus the modern discovery of the electromagnetic spectrum is used by these and other writers to explain the "aura of energy" that since antiquity was supposed to surround gemstones and to influence those who came within their domains. The great importance of physical contact with curative or protective gems is also emphasized by Saha,⁴⁴ who lists over forty diseases, ailments, and malfunctions for which astrological explanations and specific gem remedies are given.

Kunz¹⁴ pointed out that the emerald, among other gemstones, was an indispensable part of *materia medica* as late as the 16th century, and, indeed, well into the 18th century. Nevertheless, serious doubts as to the efficacy of such hard, insoluble gemstones were expressed several centuries ago. Kunz cites a certain Francesco India, writing in 1593, who "after establishing the distinction between alimentary and medicinal substances . . . proceeds to exclude from the latter category the jacinth, emerald, sapphire, etc., because although they could be reduced to a powder, they could not be dissolved, so that when taken in a potion they could

Beryl in Magic, Mystery, and Medicine

be absorbed in the human system." Francesco India recognized that "these stones are not remedial agents fit to be administered or used by any rational physician."

Kunz also quotes from Robert Boyle's *On the Usefulness of Experimental Philosophy* (Oxford, 1664), in which Boyle is more cautious than India, firmly rejecting magical virtues in gems but still saying, "I am not altogether of their mind, that absolutely reject the internal use of Leaf-Gold, Rubies, Saphyrs, Emeralds, and other Gems, as things that are unconquerable by the heat of the stomach . . . the Stomach acts not on Medicines barely upon the account of its heat, but is endowed with a subtle dissolvent . . . by which it performs divers things not to be done by so languid a heat." This theme appears again in Boyle's *Origine and Virtues of Gems*,⁵⁰ wherein he says "even the Natural heat of the Human Stomach, nay perhaps the outward parts of the Body, may be able, though not to digest precious stones, yet to sollicit out some of their Virtues." As mentioned in chapter 2, Dr. Robert Pitt⁵¹ of London added his voice to the chorus of the unconvinced when he published his work on medical frauds, in which he categorically denied the effectiveness of hard gemstones in pharmaceutical preparations.

To make the medicinal preparations, emerald and beryl were usually crushed to a fine powder, sometimes after a preliminary calcination or chemical treatment. The powder was then incorporated into a sweet-tasting paste to be applied topically or mixed with other ingredients to be swallowed. A preparation of this kind was widely used to counter the Black Death, the plague that made repeated appearances in Medieval Europe, the most catastrophic of which, in 1347–48, took an estimated 13 million lives.¹⁴ In one such preparation "there appear as ingredients pearls, jargoons, emeralds and coral, one-sixth drachm of each of these materials entered into the composition." Similar recipes are described and discussed by Garboe,⁵² who noted that a respected authority, the *Pharmacopeia Augustana* of 1622, gave recipes in which emerald and other gemstones were combined with plant and animal substances. Etereo Ardente⁵³ gave two recipes of this sort, labeled "giacinto" or "hyacinth" recipes because of their use of zircon, a gemstone which also appeared in English recipes called "confection of hyacinth." One recipe required no less than thirty-three ingredients and another thirty-four, with emerald called for in both.

The high cost of genuine emerald induced the less scrupulous to use the poorest and cheapest grades available, and failing that, to use other stones as long as they were green. Kunz¹⁴ quoted prices demanded for various medicinal gemstones, including emerald, from an ingredients price-list printed by a German pharmaceutical firm in 1757, and showed that even at this late date gemstones were regularly used in medicines.

In the sections that follow, all classes of ailments are given which, if not cured by emerald or beryl, were at least supposed to be arrested or ameliorated by their use. Both external and internal applications appear, the first depending for effec-

HISTORY AND LORE

tiveness upon the supposed ability of radiations from the gemstones to pass through flesh and bone and reach affected parts, and the second depending upon some kind of chemical reaction or the enhanced power of the rays when they are brought closer to the ailing organ through ingestion. A large number of ailments are given below, but the principal ills which beryls are supposed to work against are connected with vision, poisons, epilepsy, childbirth and fever.

Vision and Diseases of the Eyes

The psychological effects of color have long been recognized. The use of the standard "hospital green," for instance, is based on the acknowledged ability of green to induce a sense of calm and rest. Effects of color were recognized very early on, by Theophrastus,⁵ for one, who remarked of the smaragdus that "it is also good for the eyes, and for this reason people carry seals made from it, so as to see better." This brief statement was amplified by Pliny in his *Natural History*,⁶ where he wrote of the emerald that "indeed there is no stone, the colour of which is more delightful to the eye . . . and the only one that feeds the sight without satiating it. Even when the vision has been fatigued with intently viewing other objects, it is refreshed by being turned upon this stone; and the lapidaries know of nothing that is more gratefully soothing for the eyes, its soft green tints being wonderfully adapted for assuaging lassitude, when felt in these organs."

These relatively unpretentious claims were seized upon by later writers and enlarged and embroidered until the emerald became a remedy for a host of ills which in some way, however tenuous, could be connected with the eyes. The eyes were organs of the head, and since what was good for one organ was probably good for all the rest, the emerald, and to some extent the beryl, came to be considered efficacious for many ailments of the cranium and its contents.

Eyesight—Emerald good for the eyes, improves vision, comforts, soothes, rests, refreshes, etc.^{5,6,54} (and from Marbod,¹⁹ from Mandeville,²⁹ from A. Magnus²⁶); strengthens and clarifies,³⁰ rejuvenates and restores,²⁰ or dissipates obscurations of (from Aristotle³⁶).

Eye Diseases—Beryl good for³⁰ or cures (from Psellus⁵⁵).

Eye Medicines—Lave eyes in water in which beryl³⁴ or emerald²⁵ previously immersed; beryl particularly effective for curing even most serious injuries to eyeballs if applied in small quantity as finely crushed powder into eye each morning⁵⁴ or laid in the corners of the eyes.²³

Watery Eyes—Emerald helpful in curing (A. Magnus²⁶); emerald "stops the flow of a fluid substance from the eyes (caused by weakness of the optical nerves), if it be applied to that part, in the shape of *Surma* or powder; and brings out all the impurities of the eyes if it is kept constantly fixed before them" (Indian lore⁷).

Poisons and Venomous Bites

The power of emerald and beryl against poisonous substances is a belief of long standing according to Petrie,⁴ who described ancient Egyptian scarab amulets of beryl which were said to protect against snake bites or ameliorate the effect of the venom. This belief may stem from the Arabic conviction that the eyesight (and therefore the stare of the snake?) is destroyed by gazing at an emerald. The true origin of this superstition is unknown, but Jones⁴³ noted its appearance in an ancient treatise on stones written by Ahmed Ben Abdalaziz, while Kunz² mentions the experience of a 13th-century Arabian gem dealer, Ahmed Teifaschi, who told how he experimented with a "strong and vigorous" viper and destroyed its eyes by forcing the serpent to look upon an emerald thrust before it in the cleft of a stick.

Poisons in Food—Presence of, secretly mixed in food, detected by an emerald worn in a ring "perspiring immediately on its coming in contact with the edibles" (old Persian Arabic lore⁷); if emerald is set in a gold ring and placed on the "solar finger" of left hand, when the sun enters Taurus, food poison can be detected (old Rosicrucian belief²⁴).

Poisons and Venoms—Emerald prescribed for^{20,25,38,42,46,56} (and from Aristotle,³⁶ from Abenzoar,⁴⁰ from Cardan³⁶). Beryl effective against;³¹ emerald protects from (South American Indian lore²⁴).

Poison Antidotes—The following preparation "neutralized the deadly action of poisonous insect bites . . . provided it is taken before the poison spreads all over the body:" emerald powder, in quantities corresponding with the weight of 8 wheat corns; also, "the dose of the Emerald, as an antidote to poison, is one *dung* or weight of 16 barley-corns; the *Zuburzud* of the same weight may, in the absence of the Emerald, be used for the purpose" (old Persian-Arabic lore⁷). Kunz² told the experience of Abenzoar, the Arab physician of antiquity, who claimed that having taken a poisonous herb, he safeguarded himself by placing an emerald in his mouth and another on his abdomen, after which he was entirely cured. In a much later period, Rueus⁵⁷ asserted that a weight of eighty barley-corns of emerald powder given to one dying from poison would save his life.

Epilepsy

Virtually all authorities mention emerald as effective against epilepsy or its symptoms, such as sudden collapse, or the "falling sickness," and/or convulsions. In a few instances, other varieties of beryl were claimed to be equally effective.

Preventive Measures—Evans⁵⁵ quoted Ibnu'l Baitar, an Arab author, as saying that emeralds were "worn by royal children from their birth, since, set in pendants or rings, they prevent epileptic seizures." Aristotle^{24,36} claimed that an emerald

HISTORY AND LORE

hung from the neck or worn on a finger protected the wearer; A. Magnus²⁶ and others essentially said the same.^{20,25,30,39,54} Lonicer⁵⁸ emphasized the importance of wear before attacks.

Cures—Emerald cures epilepsy^{23,40,45,46,59} (and old Persian lore,²⁴ Marbod¹⁹). Beryl is also effective (from Psellus⁵⁶); aquamarine is effective (attributed to Hermes Trismegetus³⁶).

Pregnancy, Childbirth, and Fertility

Leonardus³⁴ claimed that the emerald prevented “abortive births” and protected the mother in her labor. Braun, cited by Kunz,¹⁴ stated that childbirth is hastened if the emerald is tied to the woman’s thigh. Emerald is said by some to ease or alleviate pains during labor.^{23,31,40} It is especially lucky for pregnant women to wear one around the neck so that the stone rests on the breasts.³⁹

According to Budge,¹⁶ an emerald or other green stone amulet was believed by the ancient Egyptians to symbolize fertility, while Tagore⁷ noted that wearing emeralds conferred fertility.

Fevers and Contagious Disease

Fevers—Emerald and beryl commonly prescribed for, but descriptions of the fever seem most often to refer to that induced by malaria. For example, beryl was used in ancient Egypt in the form of a scarab amulet to prevent “quartan” fever,¹⁶ a term referring to the periodic recurrence of malarial fever, while Marbod¹⁹ said that “semi-tertian” fever is cured by emerald. Probably most if not all other authorities also refer to malaria. Emerald fights (from Mandeville²⁹); cures if hung around the neck (A. Magnus²⁶); “pestilential” fevers cured by emerald;⁴⁰ as late as the 17th century, an English physician, Dr. Rowland,⁴⁷ claimed that the “tertian ague” was cured by wearing an emerald hung around the neck. Only Fobes²⁵ noted a cure by the ingestion of powdered emerald.

Cholera—Cured by emerald, if the stone is set in a gold ring and worn on the finger (old Persian-Arabic lore⁷); prescribed for the plague (from Libavius⁵²). Emerald protects from “pestilences” but is more effective if inscribed with a verse from the Koran.¹⁸

Leprosy—Emerald “sovereign” remedy for;⁷ cured by taking beryl with “an equal quantity of silver.”³⁴

Digestive Tract Ailments

Dysentery—Acute form avoided by use of emerald (old Indian lore⁴¹); relief afforded by holding emerald in mouth, according to Avenzoar;⁵² arrests or cures.^{20,25,40,45,54} Fernie⁴⁷ cites Dr. Rowland of England (1669) as recommending emerald as a cure and cited Lemery and Tournefort of France (1712) as claiming that Eastern or Western emeralds are equally effective.

Beryl in Magic, Mystery, and Medicine

Liver Complaints—Emerald “sovereign” remedy for (old Persian-Arabic lore^{7,24}). Beryl said to alleviate pains of;^{26,30} beryl cures indispositions of;³⁴ aquamarine effective against;³⁹ “weakness” of liver cured by chrysoberyllus powder taken in water.⁵⁸

Gall Bladder Ailments—Emerald “sovereign” remedy for (old Persian-Arabic lore;⁷ old Indian lore⁴¹).

Belching and Discomfort from Gas—Emerald cures biliousness.⁷ Beryl good against belching;^{26,30} hiccoughs stopped by drinking water in which a beryl was steeped.¹⁴

Hemorrhoids—Emerald reduces or arrests.^{20,40,54}

Colic Pain—Cured by finely crushed emerald in rose or *keora* water¹⁰ or cured by wearing an emerald engraved with a harpy which has under its feet a lamprey eel.⁴⁶

Miscellaneous Digestive Ills—Emerald arrests “stomach flux;”⁴⁰ aquamarine applied externally is generally effective for stomach ailments;³⁹ according to old Persian-Arabic lore, emerald prevents vomiting of blood,⁷ and one recipe calls for “one *Kirit* (Carat) or other weight of four barley-corns;” emerald stimulates the appetite;^{7,41} is a laxative;⁷ is “nutritious;”⁷ aids digestion.⁷ An “unhealthy”⁷ or “unnatural”²⁴ thirst is cured by emerald (old Persian-Arabic lore.) Emerald relieves “stricture” or the localized binding or closing of a passage, as the esophagus;^{7,24} emerald also is a general cure for stomach ailments, and some other malfunctions mentioned above according to Lonicer⁵⁸ and Hildegard von Bingen.⁵⁹

Other Ailments

Kidney Disease—Cured by finely crushed emerald in rose or *keora* water;¹⁰ aquamarine good for (from Hermes Trismegetus³⁶).

Kidney Stones—Emerald “sovereign” remedy for (old Persian-Arabic lore^{7,24}); small stones ejected from kidneys and bladder through improved urination under influence of an emerald tied to the arm.⁴⁰

Skin Diseases—Aristotle³⁶ claimed that emerald powder taken internally prevented loss of hair and “excoriation” of the skin. Emerald combats skin maladies, especially blemishes (from Mandeville²⁹). Ib-Badja,³⁶ an Arabian physician, recommended powdered emerald with other ingredients for topical application for scalp ringworm. Finely crushed emerald in rose or *keora* water cures leucoderma, or white patches on the skin.¹⁰ Ulcers are healed by rubbing affected places with ashes of burnt emerald (old Persian-Arabic lore⁷), while emerald in a poultice cures abscesses caused by worms and expels them.⁵⁹

Wounds and Hemorrhages—Wearing an emerald containing a yellow spot will result in death from wounds.⁷ Emerald is effective in stopping bleeding if carried on the person or if the powder is taken internally (from Ibn-Massouih⁴⁶); it arrests bleeding if held in the mouth (from Dr. Rowland⁴⁷), or is generally effective against

HISTORY AND LORE

hemorrhaging²⁰ (and from Lemery and Tournefort⁴⁷). Kunz² reports emerald was held to be effective against lung hemorrhages.

Heart Ailments—Emerald quickens pulse;⁷ if finely crushed in rose or *keora* water, it is good for diseases of the heart and will purify blood;¹⁰ or good for heart trouble including "tremors."⁴⁰ Beryl is used in "all distempers" of the heart (Wurtzung^{57,59}).

Head and Neck—Leonardus³⁴ prescribed beryl for all manner of head, throat, and jaw disorders; cures severe sore throat or quinsy;^{2,30} swollen neck glands reduced by rubbing over with beryl;²⁰ aquamarine necklace helpful for toothaches and other jaw ailments.³⁹ Boodt⁴⁰ prescribed emerald for "head-pounding," while Lonicer⁵⁸ claimed headaches were relieved by it.

Breathing—Shortness of breath treated with beryl;²⁶ effects of asthma reduced by drinking water in which beryl previously steeped.³⁰

Sleep and Insomnia—Beryl induces sleep;²¹ emerald prevents insomnia.³¹

Miscellaneous—Emerald, through the "soul-world" renews physical strength,²³ while the latter is symbolized by emerald or other green stone (old Egyptian lore¹⁶). Emerald brings physical strength.⁷ Tagore⁷ also repeats an old legend to the effect that emerald confers longevity, presumably because of its general health-imparting effects, and that it gives nourishment to the soul, heart, brains, and stomach, and removes all pains of the body and mind. However, he also noted that a *Rukshma*, an emerald which is not "cool," led to disease. Dragsted⁴⁶ claimed that an emerald need not be crushed to powder to be internally effective, a solid stone providing the same benefit if it is first engraved with the figure of a harpy and a lamprey eel; furthermore, if the stone is rubbed with the fat of a lamprey its effectiveness is increased. Melancholia is cured by taking emerald powder three times a day for nine days;⁶⁰ deafness and dumbness, by taking crushed emerald in rose of *keora* water.¹⁰ Giddiness is prevented by emerald.¹⁸

Emerald or other green stone amulets are symbolic of rain (old Egyptian lore¹⁶). The term "tempest" is used in several old lapidaries which claim its banishment (Marbod,¹⁹ A. Magnus²⁶) or avoidance³⁰ by use of beryl, but it is not clear whether these refer to mental disturbances or weather phenomena.

EMERALD AND BERYL IN THE BIBLE

The problem of nomenclature is particularly acute in the case of beryls mentioned in the Bible, where, it seems, translations of ancient Hebrew names for gemstones are matters of opinion and the translators are far from achieving even a reasonable concordance of views. Despite intensive studies of just what gemstones the ancient Jews had in mind when they used Hebraic terms to identify them, there is no general agreement that emerald or any other variety of beryl was actually designated in the Bible. The arguments pro and con appear in many works dealing with Biblical gemstones, but they are best marshalled in C. W. Cooper's *The*

Beryl in Magic, Mystery, and Medicine

Precious Stones of the Bible,⁶¹ in G. F. Kunz's *The Curious Lore of Precious Stones*,² and more recently in J. Bolman's *De Edelsteenen uit den Bijbel*.⁶² For religious uses other than those mentioned in the Bible, see also Kunz's *The Magic of Jewels and Charms*.¹⁴

The Breastplate of the High Priest

The earliest mention of precious stones in the Bible occurs in Exodus 28: 17–20 in the description of the breastplate worn by Aaron (born ca. 1600 B.C.), the first High Priest of Israel. This object bore twelve stones, on which were engraved the names of the twelve tribes of Israel, and it was supplemented by a pouch for carrying the *urim* and *thummim*, two as yet unidentified objects or instruments used to assist the High Priest in divining the will of Jehovah. According to instructions in Exodus, the stones are arranged in four rows, each containing three stones, as follows:

- Row 1: Odem, Pitdah, Bareketh
- Row 2: Nophak, Sappir, Yahalom
- Row 3: Leshem, Shebo, Ahlamah
- Row 4: Tarshish, Shoham, Yashpneh.



THE
HIGH PRIEST'S DRESS;
OR
CHRIST ARRAYED
IN
AARON'S ROBES.

BY THE
REV. D. F. JARMAN, B. A.,
MINISTER OF BEDFORD EPISCOPAL CHAPEL, BLOOMSBURY.

"In Minimis Maximus."

LONDON:
JAMES NISBET & Co., BERNERS STREET; W. F. CROFTS,
10, DUKE STREET, BLOOMSBURY.













MDCCCL.

Fig. 3-2 Title page and facing plate of D. F. Jarman's 1850 study of the vestments of the High Priest, showing his conception of the costume, its accessories, and the jeweled breastplate.

HISTORY AND LORE

REPRESENTATION OF THE BREAST PLATE.

With its precious Stones, their Colours
and Signification.

Celestial.		Spiritual.	
<i>First Row.</i>	<i>Second Row.</i>	<i>Third Row.</i>	<i>Fourth Row.</i>
<i>Red.</i>	<i>Reddish Blue.</i>	<i>Whitish Blue.</i>	<i>Blueish White.</i>
<i>Ruby.</i>  1.	<i>Chrysoloprasus.</i>  4.	<i>Cyanus.</i>  7.	<i>Turkish.</i>  10.
<i>Topaz.</i>  2.	<i>Sapphire.</i>  5.	<i>Agate.</i>  8.	<i>Onyx.</i>  11.
<i>Carbuncle.</i>  3.	<i>Diamond.</i>  6.	<i>Amethyst.</i>  9.	<i>Jasper.</i>  12.
<i>Celestial Good.</i>	<i>Celestial Truth.</i>	<i>Spiritual Good.</i>	<i>Spiritual Truth.</i>

<i>First Row. Downwards</i>	<i>Red</i>	<i>Celestial Love of Good.</i>
<i>Second Row.</i>	<i>Reddish Blue.</i>	<i>Celestial Love of Truth.</i>
<i>Third Row . . .</i>	<i>Whitish Blue.</i>	<i>Spiritual Love of Good.</i>
<i>Fourth Row . . .</i>	<i>Blueish White.</i>	<i>Spiritual Love of Truth.</i>

Fig. 3-3 Robert Hindmarsh's conception of the breastplate of the High Priest showing the stones, their locations, colors and attributes. From the frontispiece color plate in his *Precious Stones . . . Mentioned in the Sacred Scriptures* (London, 1851).

Beryl in Magic, Mystery, and Medicine

Table 3-1, which is derived from a number of authorities, compares the nomenclature for those breastplate stones that might have been beryl, among others, and shows how the identities changed in successive versions of the Bible.

It is clear from Table 3-1 that wide differences in opinion existed as to which stones were actually inserted in the breastplate. Some consistency is seen in the case of the *smaragdus*, but, as pointed out in Chapter 1, it is precisely this term whose meaning is subject to the greatest doubt. In 79 A.D., Pliny described no less than twelve varieties of *smaragdus*, many of them certainly not emerald. When the translators of the original Hebrew version of the Bible transformed "bareketh" into "smaragdus," which of the many *smaragdi* was meant? Did they mean the real emerald or some other green stone?

Although true emerald was known in Egypt by 250 B.C., the date of the Septuagint version of the Bible in which the first mention of *smaragdus* appears, it is unlikely that emerald was actually the stone used in the breastplate. According to Kunz, (1856–1932), the foremost gemological expert in the United States during his time and author of several large works on the curious lore of gemstones that remain the standard authorities today, the probable size of the breastplate and its stones appears to eliminate use of emerald. Kunz suggested that the breastplate measured about 8 to 9 inches (20–23 cm) square and the stones themselves perhaps as large as $2 \times 2\frac{1}{2}$ inches (5×6.3 cm). These dimensions were not deemed excessive "in view of the number of characters required to express some of the tribal names."² Because of the absence of archeological evidence as to the actual size and design of the original breastplate, and the lack of any surviving specimens of Egyptian emerald large enough and flawless enough to fashion a breastplate stone of the dimensions given above, the conclusion drawn by Kunz is that some green stone other than emerald was used. A far more likely gemstone that could have been used for this purpose is jasper, which commonly occurred in large and fracture-free masses.

Further analyzing the possible features of the breastplate, Kunz² concluded that no member of the beryl family was used and that the third stone, the bareketh, was probably green feldspar (amazonite), a material commonly in use in Egypt at about the time the breastplate was fabricated (ca. 1600 B.C.). The fourth stone, the nophak, was changed to "emerald" by the translators of the Authorized version of the Bible, for reasons which are now unknown. Originally it was probably garnet. Kunz believed that the tenth stone, the tarshish, was yellow jasper, but inexplicably it was changed to beryl in the Authorized version. The eleventh stone, the shoham, was probably malachite, according to Kunz, despite its suggestive name "berylion" in the Septuagint version. The twelfth stone, the yashpneh, is green jasper or jade, according to Kunz, rather than any variety of beryl as given in Josephus and the Vulgate version.

HISTORY AND LORE

Table 3-1
COMPARATIVE TABLE OF POSSIBLE
BERYL GEMSTONES IN HIGH PRIEST'S BREASTPLATE^a

Source	Original Hebrew				
	Bareketh	Nophak	Tarshish	Shoham	Yashpneh
Septuagint Version (Greek, ca. 200 B.C.)	Smaragdos	Anthrax	Chrysolithos	Beryllos	Onychion
Masora Version ^b (Early Hebrew)	Emerald	Carbuncle	Chrysolite	Onyx	Jasper
Physiologus ^c (ca. 150 B.C.)	Smaragdos	Anthrax	Chrysolithos	Beryllos	Onychion
Josephus (Greek, ca. 70-90 A.D.)	Smaragdos	Ruby Anthrax	Chrysolithos	Onyx Beryllion	Beryllos Onychion
Epiphanius (ca. 350 A.D.)	Smaragdos	Carbunculus	Chrysolithos	Beryllos	Onyx
Vulgate Version (Latin, ca. 400 A.D.)	Smaragdos	Carbunculus	Chrysolithos	Onychinus	Beryllus
Moerentorf (1599) ^d	Smaragd	Carbuncle	Chrysolite	Nagelsteen	Berillus
Authorized Version (English, 1611)	Carbuncle	Emerald	Beryl	Onyx	Jasper
Schopper (1614) ^e	Smaragd	Carbuncle	Chrysolite	Onix	Sardonix
Authorized Version (1637)	Carbuncle	Emerald	Turquoise	Sardonix	Jaspis
Revised Version (English, 1884)	Carbuncle or Emerald	Emerald or Carbuncle	Beryl or Chalcedony	Onyx or Beryl	Jasper
Leyden Version (1900)	Smaragd	Carbuncle	Chrysolite	Onyx or Beryl	Sardonyx
Bolman (1938) ^f	Malachite	Hematite	Turquoise	Chrysoptase	Nephrite

^aPrincipally from Kunz,² p. 301 and Bolman,⁶² p. 73.

^bA. P. Davis, *Aaron's Breastplate*, St. Louis, priv. publ., p. 17.

^cVersion not identified by Bolman; original probably composed in Alexandria in 2nd century A.D.

^dNot further identified by Bolman

^eJ. Schopper, *Biblich Edelgestein Büchlein*, Nürnberg, 1614.

^fBolman's interpretation

Beryl in Magic, Mystery, and Medicine

The confusion in names and meanings is further compounded by citing authors other than those named above. For example, in the past century, E. F. C. Rosenmüller⁶³ gave *baraket* as equivalent to "oriental emerald," which he identifies as "the noblest kind of that mineral . . . which is called Corundum." He thus dismisses emerald in one breath, but he casts doubt on his statement in another when he cites Pliny as having "recognized twelve species of this stone," which, as we have seen in Chapter 1, did not include any members of the corundum family.

T. M. Harris,⁶⁴ a well-known student of the natural history of the Bible, included in his book a considerable number of minerals, but he failed to mention the bareketh at all. He did, however, identify the emerald with the nophak. C. W. Cooper,⁶¹ perhaps the soundest of all commentators on this problem, presented evidence that the bareketh was the modern emerald, but he stated that "if there is any doubt about the precise nature of this gem, it lies between being the true *Emerald* and the *Aquamarine* (the Beryl of the ancients) because of the extreme rarity of an emerald large enough to fill the space assigned to the stones of the Breastplate." Unfortunately, he did not venture an opinion as to how large this space could have been.

In the 17th century, the nophak acquired the identity of the emerald although much earlier it was called "anthrax" which is taken by many authorities to mean garnet. Rosenmüller⁶³ gave it as carbuncle, Harris⁶⁴ as emerald, and Cooper⁶¹ noted that while it is translated in the Authorized version as emerald, "there is little doubt that this rendering is wrong, and that it should be translated Carbuncle." Differing from all of these opinions is that of Bolman,⁶² who claims that the stone was hematite.

The tarshish also suffered a checkered etymological career, beginning as chrysolite in the Septuagint, turning into beryl, turquoise, or chalcedony in later versions of the Bible or in the authorities cited in Table 3-1. Rosenmüller accepted chrysolite for the original Hebrew name, but Harris refused to commit himself, saying that the stone could have been either chrysolite or beryl.

The shoham first appeared as "beryllos" in the Septuagint, but is given as onyx in the Masora, with onyx and beryl given as alternatives in later versions or authorities. Bolman⁶² gave "nagelsteen" or "nail-stone" but failed to identify this stone, and in his conclusion as to the identities of the breastplate stones, gave chrysoptase as the stone originally meant by "shoham," a view which finds no support from other authorities. On the other hand, Rosenmüller considered the shoham to be a beryl and cited Bellerman's belief⁶³ (pp. 39-40) that the prismatic shape of beryl crystals suggests that they could have been used as the two shoulderpieces from which the breastplate was hung. Harris does not mention the shoham. Cooper claimed it to be an onyx and did not consider beryl a likely candidate.

The last stone to be considered, the yashpneh, began its confused identity as

HISTORY AND LORE

onychion (onyx) in the Septuagint, then as jasper in the Masora, then was given alternatively with the beryllus—a term that prevailed for a time—then as sardonix by Schopper, or jasper by other authorities, and finally as nephrite, one of the two principal kinds of jade, by Bolman, for which he presents unconvincing arguments. Rosenmüller believed the yashpeh to be green jasper, with Harris sharing this opinion, but Cooper preferred plasma, a greenish, impure type of quartz.

Another stone mentioned in the Bible that is sometimes suggested as a beryl variety is the *bdellium*. Harris⁶⁴ (pp. 34–5) states that some translators mistakenly give it as beryl, while others think it to have been pearl or a vegetable resin that bears a similar name. Harris himself was convinced that a gemstone of some sort was meant.

Exodus 21:15–30 clearly directs that the breastplate stones be engraved “with the names of the children of Israel, twelve, according to their names, like the engravings of a signet; every one with his name shall they be according to the twelve tribes.” Unfortunately, this instruction failed to link the stones to their tribes, with the result that another fertile field for speculation was opened. Attempts to correlate tribes to stones of the breastplate appear in Kunz² (p. 289), Cooper⁶¹ (pp. 14, 17), Clapton⁶⁵ (p. xxviii), and Alcott²¹ (p. 45), who mentions emerald and beryl, but their efforts are unconvincing.

Emerald and Beryl in the Foundation Stones

Revelation 21:9–21 names emerald as the fourth stone of the Foundation of the New Jerusalem and names beryl as the eighth stone, according to Kunz² and Cooper.⁶¹ However, as previously shown, these identifications cannot be established to everyone’s satisfaction and ancillary information derived therefrom must be conjectural at best. Furthermore, the order in which the foundation stones appear does not correspond to that of the breastplate stones, and therefore supplies no helpful identification. Elsewhere in the Scriptures, it is said that each of these stones was engraved with the name of one of the twelve apostles. Kunz² (pp. 303–4) supplied three different lists of stones and corresponding apostles, in which the fourth stone, the emerald, can be associated with John (twice) or Andrew. The beryl, the eighth stone, can signify Matthew or Thomas (twice). Kunz cites Andreas, Bishop of Caesarea, in the late 10th century as saying of the emerald “we conceive this stone to signify John the Evangelist,” while beryl “seems to suggest the admirable Thomas.”² Other correlations appear in Alcott,²¹ Clapton,⁶⁵ and Schopper.⁶⁶

Obviously grave uncertainty exists as to the identification of Biblical gemstones, particularly the emerald and beryl. While much shrewd speculation exists in the literature, almost all of it founders on the ambiguity of the original Hebraic terms. It is unfortunate that among the few ancient Biblical antiquities that survived no breastplate is to be found from which direct evidence can be obtained.

EMERALD AND BERYL AS BIRTHSTONES

The belief that certain stones were beneficial to their wearers according to their month of birth is said by Kunz² to have originated with Flavius Josephus, the Jewish historian who wrote in the first century A.D., and with St. Jerome, who wrote in the early part of the 5th century A.D. "Both of these authors distinctly proclaim the connection between the twelve stones of the high-priest's breastplate and the twelve months of the year, as well as the twelve zodiacal signs." Despite the antiquity of these declarations, Kunz was unable to trace any regular use of birthstones until the custom became established in Poland in the 18th century.

Table 3-2, Beryl Birthstones, incorporates portions of a much larger table provided by Kunz² (p. 315), along with information gleaned from other sources. Typically, there is little consistency in the assignment of birthstones, except in the assignment of beryl or aquamarine to the month of October. In this century, substitution of appropriately colored synthetic stones has become a common practice.

While birthstones are popularly assigned to calendar months, it is actually the zodiacal period in which a person is born that governs the choice. There are twelve such periods, each representing a constellation that lies within the belt of the heavens through which the sun, moon, and planets appear to move. Thus a person born between March 21 and April 20 is said to be born under the sign of Aries, the ram, one of the twelve constellations. Hence, according to some birthstone lists, that person should choose the aquamarine as a birthstone. However, because of the precession, or shifting of the celestial date-keeping points over the centuries, none of today's zodiacal periods correspond accurately to the actual position of the constellation in the sky, but this does not seem to cause much concern among modern astrologers.

The constant change in birthstone lists makes it difficult for anyone to determine just when the wearing of an emerald or beryl is appropriate, as can be seen in the conflicting recommendations given in Table 3-2. In general, buyers of birthstone gems must depend on the recommendations of their jewelers, the latter, in turn, depending on the "latest" lists as issued by national and international jewelry-trade organizations. In any event, if one follows the custom developed over many centuries, it is the zodiacal gem that should be chosen and not the monthly gem, or so-called birthstone, inasmuch as the latter is arbitrarily assigned to a calendar month. For example, a person may be told that he should wear an emerald if born in May, but if actually born before the twenty-second of that month, the appropriate gem would not be the emerald but either the diamond or a sapphire.

The assignment of gemstones to specific zodiacal periods began many centuries ago and probably originated among ancient Egyptian or Arabian astrologers. The *Oedipus Aegyptiacus*, a work written by Athanasius Kircher and published in Rome in 1635, provides the earliest extant lists of twelve zodiacal stones. It includes the

HISTORY AND LORE

Table 3-2
BERYL BIRTHSTONES

Month	March	May	June	September	October
Zodiacal Period	3/21-4/20	5/22-6/21	6/22-7/23	9/24-10/23	10/24-11/22
Sign	Aries	Gemini	Cancer	Libra	Scorpio
Authority					
Jews ²			emerald		aquamarine
Romans ²			emerald		aquamarine
Isidore ² (635 A.D.)			emerald		aquamarine
Arabians ²		emerald			aquamarine
Poles ²		emerald			aquamarine
Russians ²		emerald			beryl
Italians ²			emerald		beryl
15th-20th c. ²		emerald agate			beryl opal
18th-20th c. ⁶⁷		emerald agate	cat's-eye emerald turquoise agate	beryl chrysolite	aquamarine beryl pearl opal
Blum ⁶⁸ (1832)		agate emerald	emerald chalcedony agate, onyx		beryl aquamarine
Jones ⁴³ (1880)			emerald		beryl
Alcott ²¹ (1887)			emerald		beryl aquamarine
Bratley ²⁸ (1907)		emerald			
U.S.A. (1912) Nat. Jewelers Assoc.	aquamarine bloodstone	emerald			
Dragsted ⁴⁶ (1933)			emerald		beryl
Grant-Taylor ⁶⁹ (1936)		agate emerald	emerald agate		aquamarine opal
B.I.B.O.A. ^a (1937)	aquamarine blue tourmaline blue topaz	emerald green tourmaline chrysoptase olivine			
U.K. list (1937) Heaps ⁷⁰	aquamarine bloodstone	emerald chrysoptase			

^aFédération Internationale des Associations de l'Industrie, de l'Artisanat et du Commerce des Diamants, Perles et Pierres Précieuses, de Bijouterie, Joaillerie, Orfèvrerie et Horlogerie (B.I.B.O.A.)

Beryl in Magic, Mystery, and Medicine

beryl, in fifth place, associated with the constellation Leo and the symbolic color "aureus" (golden). Emerald, the ninth stone, is assigned to Saggitarius with symbolic color "flammeus" (flame-colored).

Miro⁷¹ examined an ancient manuscript and found that beryl was assigned to the constellation of Cancer and emerald to Saggitarius, and they were associated, furthermore, with specific stars for each stone, "el can mayor" (Sirius) in Cancer for the beryl and "la spica turginis" (Spica virginis) in Libra for the emerald. Kunz² repeated the same associations but attributed them to Gaspar de Morales's *De las Piedras Preciosas*, published in Madrid in 1605.⁷² Alcott²¹ (p. 45) provides a comprehensive table of "birthday facts and fancies" in which emerald is linked to Cancer but is also considered symbolically associated with the apostle Thomas, the tribal patriarch Simeon, and the guardian angel Muriel whose talismanic gem is said to be the emerald. Alcott links both beryl and aquamarine to Scorpio and also to apostle Simon the Zealous, tribal patriarch Asher, and guardian angel Bariel. Bratley²⁸ connects emerald only to Gemini and makes no further mention of beryls. However, in another place, he not only joins emerald to Gemini, but insists that this stone, if it is to be effective when worn, must be engraved with the name Saraiel, plus the design for the constellation of Gemini, and then set in platinum, quite ignoring the fact that platinum was first identified in the early part of the 18th century and unknown to ancient astrologers.

Related to the lore of birthstones is the belief mentioned earlier that certain stones were imbued with powers radiated to them by celestial bodies. For example, Kunz² points out that the Chaldeans believed the emerald to be influenced by the planet Venus, but also indicates later that the emerald was associated from time to time with Mercury and the beryl with Venus and Mars. The only planetary association mentioned by Bratley²⁸ is emerald with Jupiter. In an attempt, possibly to arouse more interest in birthstones, Kunz² (p. 323) appears to be responsible for linking certain gemstones to the seasons, noting that "the emerald is the gem of spring . . . no precious stone is more appropriate . . . its beautiful color is that of Nature, for Nature clothes herself with green when she awakens from her long rest of winter," thus voicing a sentiment which, as we have seen, Petrie⁴ attributed to the ancient Egyptians.

Certain gemstones have also been suggested beneficial if worn on certain days of the week. For example, the talismanic gem for Monday, according to Kunz,² is the emerald, but it may also be worn instead of ruby on Tuesday, and worn again on Friday when it is considered the prime gemstone. Bratley,²⁸ however, gives emerald and sapphire as the gemstones to be worn on Thursdays only, while Fernie⁴⁷ warns *against* wearing the emerald on Friday, pointing out that while this custom arose from linking the emerald to Venus, the goddess of that weekday, "a mistaken notion underlies this practice, considering that the Scandinavian Venus, Freya, is here signified, the wife of Odin, and a woman of bad character."

HISTORY AND LORE

In 1952, councils of jewelry tradesmen in several countries agreed on standard lists of gemstones for weekdays, recommending emerald or cat's-eye for Friday, and even listing stones for each of the twenty-four hours of the day, with emerald for 2 P.M. and beryl for 3 P.M. Another periodical assignment is emerald as the symbol of the 55th wedding anniversary.

In an interesting attempt to increase sales of symbolic gems, Kunz² suggested a list of stones corresponding to the months but also specifying gemstone localities in the United States for each, further suggesting that they could be worn by citizens in a "spirit of patriotism." Among beryl gems, the golden beryl from California, Connecticut, or North Carolina was nominated for the month of August; and for October, the gem considered appropriate was the aquamarine from sources in North Carolina, Maine, and California.

In summary, birthstone lists, even when confined merely to members of the beryl family, as in the case of Table 3-2, become increasingly confusing with the passage of time. In the table cited, for example, emerald and aquamarine were agreed upon by most authorities up to the 18th-20th-century period, at which time a number of "alternative" stones began to appear, many suggested by members of the jewelry industry both here and abroad, and probably reflecting the desire of dealers in gems and jewelry to expand the choices that could be offered to customers. It would be difficult to find any logical reason why such gems as pearl, opal, chalcedony, onyx, and others could be considered as valid alternatives to the traditional beryl gems. In the case of the B.I.B.O.A. list, adopted by an international federation of jewelry tradesmen, the aquamarine is not only moved to an untraditional position but several other blue gems, mineralogically unrelated to beryl, are officially recognized as alternative stones. Emerald, however, is allowed to retain its earliest zodiacal position, but several green-colored gemstones, again mineralogically unrelated to beryl, are sanctioned as alternatives. Even more bizarre is the practice since the last part of the 19th century of condoning the use of synthetic blue and green gems made from spinel and corundum, or similarly-colored glasses, as substitutes for the traditional natural stones. If any wearer of birthstones is convinced that some protection is offered thereby, he or she should at least insist upon obtaining either natural emerald or beryl as listed in the earliest portion of Table 3-2.

ASTROLOGY AND BERYL IN INDIA

Virtually all gem lore of India is firmly founded in the belief that the sun, moon, planets, and stars pervasively influence all earthbound activity. For example, Finot⁸ (p. 175) and Kunz² (p. 242) cite instructions for composing a powerful "nine-gem" jewel, the *nava-ratna*, in such a manner that a special gem is associated with a celestial direction, the emerald, representing Mercury, being used for the

Beryl in Magic, Mystery, and Medicine

Northwest. The purpose of this jewel is to combine all celestial influences in one, presumably to draw such benefits as may be transmitted by the gems themselves, following the "aura of energy" principle, or to appease celestial deities who were thought to reside on the planets or at certain strategic points in the heavens.

Similar jewels are still in use, although they generally contain only the five most influential gems, namely diamond, pearl, ruby, sapphire, and emerald. Tagore⁷ noted that Sanskrit writings told of the "seats" of these celestial beings, including one for the emerald, the seat of Ráhu, a great demon of Hindu mythology who swallows the sun and thus causes eclipses. He also mentions other uses of the emerald, all designed to appease the wrath of gods or to ward off evil influences emanating from Ráhu and his equally fearful companion, Ketu. The *Puranás*, according to Tagore (vol. 2, p. 579), contain a curious instruction to kings, cautioning them to use seats of precious stones to avert evil influences, and that "in the rainy season, kings should use seats of emeralds; and when the clouds begin to roar, they should sit on seats of pure gems." This ancient admonition suggests a reason for the popularity of heavily jewel-encrusted chairs or thrones among Eastern potentates.

Tagore⁷ (vol. 2, p. 619) also noted that the *Puranás* designated "auspicious" stones for the months, somewhat like our birthstone custom, but without any connection to zodiacal periods. Only the emerald, among beryl varieties, is mentioned, being the gem designated for May. Tank¹⁰ mentioned that Hindu astrologers urge the wearing of emerald to those born during the phase of the planet Mercury. The jewel should be made of gold and worn on the neck, arm, or finger, on Wednesday, in the morning, two hours after sunrise.

In a modern treatise on gem therapy as practiced in India, Bhattacharyya¹¹ cites the *Kurma Puraná* (ch. 43, vol. 1-2), written in the early centuries of the Christian era, as the Hindu source for beliefs in the celestial influences upon gems, stressing the importance of colored rays that are said to permeate the entire universe, including the stars, planets and all things on Earth. Certain gemstones, as described below, derive their powers directly from the planets. According to the *Kurma Puraná*, "the Great Lord, the Lord of Lords, the Universal Grandfather," is composed of seven colored rays which are "omnipresent, and illumine the limitless worlds in the Universe, and among them seven are the best and highest because they form the matrices of the Seven Planets." The planets themselves are conceived as condensations of the seven different colours of the rainbow" and are shown in Table 3-3 with their associated colors and gems.

Not only are the planets believed to be "condensations" of the color force emanating from the Overlord of the Universe, but the gems are also conceived as concentrations of the same energy passed directly to them from the planets.

In addition to these concepts, Hindu cosmology establishes the "Five Great

HISTORY AND LORE

Table 3-3
PLANETARY COLORS AND GEMS ACCORDING TO HINDU
ASTROLOGY

<i>Planet</i>	<i>Color</i>	<i>Gem</i>	<i>Sex</i>	<i>Temperature</i>
Sun	Red	Ruby	Male	Hot
Moon	Orange	Pearl	Female	Cool
Mars	Yellow	Coral	Male	Hot
Mercury	Green	Emerald	Female	Cool
Jupiter	Blue	Moonstone ^a	Male	Hot
Venus	Indigo	Diamond	Female	Cool
Saturn	Violet	Sapphire	Female	Cool

^a Alternative stones are topaz, or "pusparaga," the latter not identified, but possibly the orange sapphire known as "padparadschah."

Elements" Earth, Water, Fire, Air, and Ether. These too are viewed as condensations of the color forces, with the Earth specifically embodying green and hence connected directly to the emerald. Bhattacharyya¹¹ notes, furthermore, that because of the connection of emerald to Earth, the organs of the body known as "heavy viscera," as well as bone, flesh, liver, spleen, kidneys, and intestines, are strongly influenced by the emerald because "their health in a large measure depends on cosmic Green." In the practice of gem therapy, therefore, the emerald can be worn externally to ward off or cure ailments connected with any part of the body influenced by this gem, or the emerald can be administered internally by first calcining or "burning" the stone, then placing the ashes (bhasma) in a suitable medicine for internal consumption.

In another modern work on gem therapy, Saha⁴⁴ notes that while the second finger (madhyama) of the hand is dominated by Saturn, the emerald may also be worn on it because, Mercury, the planet associated with emerald, is a "friend" of Saturn. Saha also repeats current Hindu astrological lore by pointing out that "Mercury governs the intellect and wisdom," and that if "the gem emerald is fitted in gold only during the time when Mercury will be in Virgo . . . it could capture and tap the magical powers of Mercury in the ring itself."

Among a series of "di-graha yogas" described by Saha, or combinations of two planets in one house of the zodiac, are those of Mercury with the Sun, Moon, and planets which exercise great influence on mortals, baleful and beneficial, and which can be taken advantage of (or counteracted) by the wearing of suitable gems, including the emerald. The instructions given by Saha are both specific and em-

Beryl in Magic, Mystery, and Medicine

phatic, with detailed directions for employing gems for almost every conceivable ailment, physical and mental, that can afflict the body.

Thus in India, the wear of gems has been, and to a large extent, still remains far more significant than mere personal adornment. The associations of gems to celestial influences via all-pervasive color radiations are based on fundamental tenets of religion as well as on real or imaginary physico-psychic phenomena.

EMERALD LORE IN COLOMBIA AND PERU

The Guatavita Lagoon, lying about 25 miles (40 km) north of Bogota, is mentioned by Kunz¹⁴ as being sacred to the local Indian inhabitants long before the advent of the Spanish conquerors. Certain religious rites required that precious objects, including gold and emeralds, be cast into its waters to appease the powerful god or demon residing there. These ceremonies were held semiannually, with the *caciques* or chiefs paddling boats into the exact center of the lake to cast their offerings into the water. The Cacique of Guatavita, divested of all clothing and dusted with gold, dived into the water, and, after washing himself, swam to shore. At the moment he entered the lake, the natives along the banks threw their offerings into the water over their shoulders. This spectacle is thought to be the origin of the legend of El Dorado, the "golden one." Klein⁷³ dismisses the entire story as the figment of someone's imagination. However, a story by P. Lernoux⁷⁴ that appeared in the *San Diego Union* in 1966 reported that the lake, located in the crater of an extinct volcano at an altitude of 9,250 feet (2760 m), was partly drained by a certain Antonio Sepulveda sometime in the 16th century, at which time he recovered considerable treasure, including emeralds of great value. A good discussion of attempts to drain the lagoon appears in Bray⁸⁹ (pp. 4-23).

Canova⁷⁵ provided an interesting but probably apocryphal legend about Colombian emeralds attributed to the native Chibcha Indians. A young warrior, in love with the only sister of his tribal chief, was denied her hand in marriage because the chief had another suitor in mind. The warrior was banished from the tribe and could not return until he had won fame in battle, obtained a great treasure, or had received a sign from the God of Light that his suit was favored. The young man rushed into the forest where he was caught in a landslide, that unearthed a deposit of emeralds, from which he obtained two crystals. These were taken back to the chief who acknowledged them as a sign of the god's favor and gave his sister's hand in marriage with his blessings.

Garcilaso de la Vega,⁷⁶ an 18th-century Peruvian historian born in Cuzco, wrote a history of the Incas in which he relates a legend concerning an enormous egg-shaped emerald said to be in the possession of native priests in the City of Manta at the time the Spaniards entered the land (vol. 2, pp. 255-7). It was exhibited only on special religious days when natives came from far and wide to bring

HISTORY AND LORE

gifts to this "Emerald Goddess," whose name was Umiña. The priests shrewdly suggested to the devout that since emerald crystals were the "daughters" of the goddess, such offerings would please her most. By this device, it is said, a vast store of emeralds was accumulated. Eventually this treasure fell into the hands of the conquerors, but the main prize, the emerald Umiña, was concealed by the priests and never recovered. Kunz² mentions another religious custom, practiced by the natives of Colombia, which was to burn gold and emeralds before images of the sun and moon, their highest divinities.

De la Vega⁷⁶ also speaks of the ignorance of the Spanish in respect to the mineralogical properties of emerald, inasmuch as they swallowed whole a story given them by the natives, who, observing their great greed for these stones, told them that the test of a true emerald was its enormous hardness. A genuine emerald, according to them, could be placed on a hard surface and struck with a hammer without harm, but a false stone would shatter. Countless crystals were destroyed before someone more knowledgeable among the Conquistadores put a stop to the useless destruction.

De la Vega firmly believed that emeralds grew within host rocks like fruits on a tree, acquiring a richer hue the longer the stone was allowed to stay in the ground, and that the part of the crystal closest to the sun acquired the darkest color, which explained why the crystals were dark green at their terminations but only light green or even colorless near the base or point of attachment to the host rock. Rosnel,⁷⁷ writing in 1664, repeated this belief but attributed the story to the Indians themselves.

MISCELLANEOUS LORE

Odd bits of curious lore concerning the emerald are not confined to the countries previously mentioned, but often appear in the unlikeliest places, as in the following accounts. Bratley²⁸ (p. 119) states that beryl is "used by the South Sea Islanders as a rainmaker, and [is] said to be equally efficacious in bringing drought on their enemies." But Bratley gives no support for this statement, and it is unlikely that any could be found considering that rainfall in the South Seas is remarkable both for its abundance and certainty. There is no record of this mineral ever having been found upon these islands, most of which are coral-rimmed volcanic mounts where beryl never occurs.

Kunz² (p. 256) recorded that certain gemstones were worn by Chinese mandarins to indicate rank, possibly in accordance with some earlier religious or ceremonial custom, blue beryl the stone of the third rank. In another place (p. 335), he noted that the fashion in some parts of the Orient decreed the wearing of clothing and ornaments of special colors according to the days of the week. Green materials and emeralds, for example, were to be worn on Thursdays. Thursday was the day

Beryl in Magic, Mystery, and Medicine

appointed for "works of religion and politics," and on that day magicians were to wear a ring set with an emerald or sapphire. On Friday, the day honoring Venus, the celebrant of rites was required to wear a tiara set with lapis lazuli and beryl.

ENGRAVED EMERALDS AND BERYLS AS TALISMANS

If gemstones possessed supernatural powers, a logical inference was that these could be augmented or directed by carving the stone with a suitable image of a deity or with symbols or writings (see figure 3-4). As Budge remarked in his *Egyptian Magic*,⁷⁸ the carved scarab, considered sacred by the ancient Egyptians, commonly appeared on amulets. He cited an ancient Greek papyrus which gave detailed instructions for the conduct of the "ceremony of the beetle," by which a carved scarab is invested with power so that it may be worn as a protective talisman. The instructions direct that the stone be emerald and that beneath the carved scarab appear the engraved image of Holy Isis, and that the stone be bored to take a gold wire for fastening. This same rite is described by Kunz² in an entire chapter devoted to magical engraved gems. As mentioned earlier, Petrie⁴ also remarked on the use of scarab gems as amulets for protection against snake bites and fever.

The belief in the effectiveness of engraved gems persisted for centuries despite the round condemnation by Pliny,⁶ who derided the statements of earlier writers that engraved amethysts conferred protection against noxious spells and other evils. Such writers, he said, "make similar promises, too, in reference to the smaragdus, if graven with the figure of an eagle or a scarabaeus: statements which, in my opinion, they cannot have committed to writing without a feeling of contempt and derision for the rest of mankind."

As noted in Chapter 1, most engraved gems were fashioned from materials other than emerald or beryl, for which several reasons can be offered. First, neither of these were as common as stones (e.g., varieties of chalcedony) which were also suitable for the exquisite work exerted upon them. Second, both emerald and beryl were much more brittle than chalcedony and presented the danger to the engraver



Fig. 3-4 Persian characters inscribed on an emerald set in a ring in the Townshend Collection of the Victoria and Albert Museum, London. The stone, measuring 22 × 16 mm (ca. 7/8 × 5/8 in) was originally part of the Hope Collection. *Courtesy Victoria and Albert Museum, London.*

HISTORY AND LORE

that a moment's inattention could result in chipping or breakage. Third, it was extremely difficult to find an Egyptian emerald sufficiently free of internal defects and at the same time large enough for a suitable size gem, as has been noted before in connection with the use of emerald in the breastplate of the High Priest. Other beryl varieties, such as aquamarine and golden beryl, though known to the ancient engravers, apparently were not found in quantity and may have been even more rare than emerald. Lastly, an injunction mentioned by Pliny⁶ (p. 409) may have had some effect on the use of emerald, for he stated "that it is universally agreed upon among mankind to respect these stones, and to forbid their surface to be engraved."

The subjects carved on gems are legion. Several books on this theme, such as that by King,¹⁹ concern themselves primarily with descriptions of the carvings and interpretation of their meanings. Several examples of magical subjects will suffice to demonstrate the effects these were supposed to have in addition to those of the basic gem itself. Evans⁵⁵ cited the *Kyranides*, an ancient Greek medical work, wherein it says power could be obtained from a beryl if it is first engraved with a crow below which is engraved a crab, after which the owner must "put beneath a little sprig of cypress, a little of the bird's heart and a part of a crab, and wear it how you will." This remarkable talisman was also described by Fernie,⁴⁷ who used an English translation of the *Kyranides* entitled the *Magick of Kiram and of Harpocraton*. But Fernie noted that the stone is to be worn for "Joy, and Exultation, and Acquisition, and Union, and Conjugal Love; and it will make the Bearer cheerful, and Rich; and it is excellent as anything for lascivious and Conjugal Love."

Fernie also gives another example, this time an emerald engraved with "the Bird Harpe: and under its feet a Sea Lamprey," and which is to be worn against "disturbance, and dreams, and stupidity," and because "it causes Rest to Lunatics, and to them that are troubled with the Cholick; and it is better if the Fat of the Sea-Lamprey be put underneath; for such is Divine."

A similar example appears in King,¹⁹ who cites an old manuscript appended to Marbod's poem, in which the seeker of a powerful beryl talisman is enjoined to "engrave upon it a lobster and under its legs a raven, and put under the gem a vervain leaf enclosed in a little plate of gold; it being consecrated and worn, makes the wearer conqueror of all bad things, and gives protection against all diseases of the eyes . . . if you put this stone in water, and give this water to one to drink, it cures stoppage of the breath and hiccups, and dispels pains of the liver . . . [and] he that hath this gem upon him shall be victorious in battle over all his foes."

Bonner¹⁵ and Evans⁵⁵ both cite a Greek lapidary ascribed to Socrates and Dionysius concerning use of an engraved beryl as a protective amulet for seamen

Beryl in Magic, Mystery, and Medicine

and fishermen. It was to be carved with the figure of Poseidon, the Greek god of the sea, with a dolphin under his right foot and a trident in his right hand (Bonner) or showing Poseidon in a chariot (Evans).

From a mystical work by Ragiél, Kunz² noted that "a frog, engraved on a beryl, will have the power to reconcile enemies and produce friendship where there was discord," and "a hoopoo [or hoopoe, a European bird] with a tarragon herb before it, represented on a beryl, confers the power to invoke water-spirits and to converse with them, as well as to call up the mighty dead and to obtain answers to questions addressed to them."

Bratley²⁸ (p. 135), in what seems to be an exercise in pure invention, described a series of engraved gems for wear for each day of the week. Thursday, for example, requires an emerald or sapphire, set in tin, engraved with a king-with-javelin riding on a stag or with a woman bedecked with flowers. For Friday, a beryl, turquoise, or lapis lazuli may be used, engraved with a king astride a camel or engraved with a naked woman, and the gem is to be set in copper. Elsewhere Bratley states that the emerald birthstone should be engraved with the design of the Gemini, or with the name of the angel Saraiel.

Engraved emeralds were specially favored among Moslems. Karabacek⁷⁹ notes that the Arabic work, *Kitab el-muwaschscha* of Mohammed ibn Ishak el-Waschscha, written sometime during 860-936 A.D., speaks of the love of jewels among upper-class Arabians, and that the emerald and aquamarine gems, among others, were "artistic intaglios, with inscriptions that could be simply the names of the owners, or pious statements, spiritualistic sentences, or talismanic inscriptions." Many were prepared from turquoise, which was available in large pieces from the Persian mines, but with the introduction of large crystals of emerald from Colombia, these too were used, resulting in gems notable not only for the precious material employed but also for the beautiful calligraphy which is characteristic of Arabic writing. Kunz² (p. 79) remarks on a talismanic emerald of this kind weighing 78 carats, once owned by the Mogul ruler of Delhi, which bore around its edge the inscription "he who possesses this charm shall enjoy the special protection of God."

EMERALDS IN FABLE

The Ring of Polycrates

Polycrates, ruler of the Aegean island of Samos in the 5th century B.C., enjoying a singular prosperity, sought to stave off retribution of Fortune by sacrificing his most prized possession, a finger ring of great value. According to Pliny⁶ (Book 37), the ring was set with a sardonyx, but as Bostock and Riley point out in their commentary, Herodotus, Pausanias, and other ancient writers familiar with the tale claimed that the stone was an engraved emerald. In any event, Polycrates boarded

HISTORY AND LORE

a ship, put out to sea, and cast the ring into the water. Sinking to the bottom, the ring attracted the greed of a fish, who swallowed it. Several days later the fish was caught and, being a splendid specimen, was deemed worthy of the king's table, to which it was brought. Upon being cut open, the ring was discovered inside. Thus Polycrates' attempt to avoid ill-fortune was a vain one. In 522 B.C. he was lured to the mainland by Oroetes, Persian satrap of Lydia, and crucified there.

Because this ring was set with an engraved emerald, it attracted the attention of C. W. King,¹⁹ who commented fully on the tale as well as on the stone itself, noting that Herodotus "expressly terms it a signet of emerald, set in gold, the work of Theodorus of Samos" and that Pausanias affirmed this statement. King further noted that an engraved emerald, found in a vineyard at Aricia in Italy, was claimed by enthusiastic antiquaries to be none other than the engraved emerald of Polycrates.

Enormous Emeralds

It appears from the indiscriminate use of the term *smaragdos* by Pliny and other early writers, notably Theophrastus, that certain green stones, used in monuments, were also labeled "emeralds." For example, Theophrastus⁵ wrote that "among the gifts from the King of the Babylonians a *smaragdos* was once sent to them [the kings of Egypt] which was six feet in length and four and a half in width, and that four such stones are deposited as an offering in the obelisk of Zeus. These were sixty feet long, and their width was six feet at one end and three at the other." That this was not the modern emerald seems clear, and even Theophrastus expressed skepticism when he finished his remarks saying, "these statements depend entirely on their writings," by which he meant certain records concerning the Egyptian kings which are now lost.

Pliny^{6,80} repeated Theophrastus's description of these colossal *smaragdi* and added other examples of huge stones, all of which could not have anything in common with true emerald except a green color. Far more likely is that these massive monuments were shaped from blocks of some igneous rock, perhaps a porphyry of a kind known to exist in Egypt.

The Table of Solomon

Another enormously large "emerald" of antiquity figures in the legendary Table of Solomon, described by Ball⁸¹ as a slab of flawless emerald, encircled by rows of pearls, and supported by gold feet set with gems. It was said to possess supernatural powers because it was made by certain genies for the king. Along with other spoils, including various vessels also said to have been made from emerald, it was removed from the sanctuary at Jerusalem by Emperor Vespasian (9-79 A.D.) and placed in the Temple of Concord in Rome. Later, these treasures were carried

Beryl in Magic, Mystery, and Medicine

off to Spain by Alaric and his Goths. It was last heard of when the Saracens under Musca captured Toledo in 712 A.D. and removed the table again, this time to Damascus.

Nero's Emerald Eyeglass

The best-known fable about emerald concerns the emerald eyeglass said to have been used by Emperor Nero (37–68 A.D.) to view the gladiatorial games in Rome. Some have supposed it to have been cut as a lens, Veltheim⁸² going so far as to speculate as to whether the near-sighted Nero required a concave lens in order to see at a distance, but thought it more reasonable that the stone was an aquamarine rather than an emerald. As noted already in Chapter 1, Pliny's statement concerning this object⁶ (p. 409) merely says "the Emperor Nero used to view the combats of the gladiators upon a smaragdus." Eichholz⁸⁰ (p. 215) translated this as "the Emperor Nero used to watch the fights between gladiators in a reflecting 'smaragdus.'" Both translators were of the opinion that reflection rather than transmission of light was involved. Because of the uncertainty as to what kind of smaragdus Pliny meant, there is no reason to even assume that a true emerald was used. If the stone was used as a mirror rather than a lens, and taking into account its considerable size if it were a mirror, it was most likely a highly polished slab of some compact rock, perhaps jasper.

The Tabula Smaragdina

Both Holmyard⁸³ and Doberer⁸⁴ discuss a fabulous "emerald table" or tablet, the Tabula Smaragdina, which is frequently mentioned in the alchemical literature as being once the property of the celebrated Egyptian priest Hermon, or Hermes Trismegetus, also known as the Egyptian god Toth or Thoth, who flourished about 100 A.D. He was noted for his scientific writings and speculations on the nature of matter and was considered by some to be the "founder of Chemistry." Holmyard cited ancient authorities who claimed that Alexander the Great discovered the table in the sepulchre of Hermes. According to legend, it was fashioned from a single enormous emerald, upon which was engraved cryptic but extremely important alchemical information, the substance of which was then copied into a literary work bearing the same title as the tablet. Holmyard concluded that the work was written at least 400 years ago, possibly as much as 1200 years ago, and that "its existence in a Greek form is rendered in the highest degree probable, and it must be acknowledged that in the Tabula we have one of the oldest alchemical fragments known."

Doberer stated that, among other things, the inscriptions told how to make gold, but at the same time he noted that their length made it unlikely that the original tablet was cut from emerald; more likely it was green glass or a greenish

HISTORY AND LORE

stone. Considering the difficulties experienced at this time in casting large masses of glass, if such a table did exist, it was probably made from stone, which also happened to be the most readily available material.

Large European Emerald Objects

A monstrous "emerald" weighing 28.75 pounds (12.9 kg) was given to the Benedictine Abbey at Reichenau, near Constance, Switzerland, by Charlemagne (742–814 A.D.), according to abbey records.⁸¹ However, on a visit to the abbey, William Coxe, Rector of Bemerton, saw the stone and conjectured that it was "nothing more than a transparent green spathfluor," that is, green fluorite.

Robert de Berquen in his *Merveilles des Indes*²⁰ told of an emerald as large as "half a melon" which "glittered extraordinarily," and was hung from the top of the nave in the Cathedral of Mainz some 600 years before his time, or about 1060. The existence of this remarkable object has never been confirmed.

Another equally famous emerald is the Sacra Catina, or Holy Grail, a shallow circular vessel or dish preserved in the sacristy of the Cathedral of San Giovanni in Genoa. Its history as a religious relic begins during Biblical times when it was presented, so the story goes, by the Queen of Sheba to King Solomon, remaining for centuries thereafter in Jerusalem. In King Herod's reign, it was part of the royal table service, and just before the crucifixion, it was used by the celebrants of the Last Supper.⁸⁵ One account went so far to say that Christ himself drank from the vessel at the supper.² Succeeding in their siege of Caesarea Palastina in 1102, the Crusaders discovered the vessel and gave it over to the Genoans to fulfill a promise of loot-sharing in return for Genoan help. It was sent to Genoa for safekeeping in the cathedral where twelve nobles, called the Clavigeri, were appointed its guard.⁸¹ Once a year, it was exhibited to the public, but only from a distance, and only the most privileged were permitted to closely examine it.

Because of its diameter, reported as "16–17 inches broad," or more commonly as about 14 inches (36 cm) in diameter and 5 inches (12.5 cm) deep, the sacred vessel was recognized as glass as early as the 16th century.⁸⁵ Later visitors, when shown the vessel, confirmed this identification and even remarked on the presence of bubbles typical of glass. In 1880, Genoa fell to Napoleon and the Sacra Catina was sent to Paris for examination by experts of the Cabinet of Antiquities who pronounced it a fine example of antique glass work. An edict of the Congress of Vienna of 1815, called to settle European affairs after Napoleon's fall, directed that the vessel be returned to Genoa. It was broken along the way but was skillfully repaired and fitted with a rim of gold filigree and a tripod stand. Even today, some Genoese claim that the present object is merely a glass model that was tested at Paris and that the genuine object, made of emerald, always remained in Genoa and is still in safekeeping.

Beryl in Magic, Mystery, and Medicine

Among the largest and most remarkable emeralds that Georg Agricola had heard of, in addition to the Sacra Catina, was a giant specimen shaped into a dish or shallow cup, also claimed to be the holy grail, preserved in a monastery near Lyons.⁸⁶ Both this object and the Sacra Catina are mentioned by Conrad Gesner in his mineralogical work of 1565.⁸⁷ Another colossal emerald mentioned by Agricola, said to be kept in a small shrine dedicated to King Wenceslaus at Prague, "is not small since it is over nine inches long." Kunz² (p. 259) offers the view that it was probably made from Silesian chrysoprase, a green variety of chalcedonic quartz which occurred in masses large enough for the purpose. Lastly, Agricola mentioned an even larger specimen at Magdeburg, "which forms the base for the small tower-shaped golden chest in which the sacrament is carried."

The Emerald Buddha

In the East, the most famous "emerald" object is the statue of Buddha in Bangkok, Thailand, which presumably because of its color has been named the "Emerald Buddha," although it is now admitted by the government that the stone is not emerald. The statue reposes high atop an elaborately ornamented pedestal in the Chapel of the Emerald Buddha in the Grand Palace grounds in Bangkok. It is available for viewing by the public, but no one may approach closer than about 30 feet (10 m).

The history of the Emerald Buddha is told in the *Chronicle of the Emerald Buddha*, as translated from a palm-leaf manuscript in Pali language by C. Notton.⁸⁸ Notton described the many vicissitudes of the statue, through all of which it had emerged unscathed. A pretty legend is attached to the origin of the carving. Nagasena, a pupil of Maha Dhamma Rakitta, determined to make the religion of Lord Buddha "very prosperous" and conceived the idea of creating a statue of him out of precious stone. The an-el Indra, hearing of this, came to Nagasena and instructed him to go to Mount Vipulla where large precious stones were known to exist. However, at the mountain, the guardian genies would not surrender a suitable stone, but they suggested an alternative material, Keo Amarakata, or "crystal-smaragd," which is "a magnificent gem measuring about four times the size of the fist and three fingers in width, and about one cubit one hand in length." A heavenly sculptor by the name of Visukamma was given the stone to carve, and in about seven days and seven nights had completed the statue, about one cubit (ca. 18 in or 45 cm) in height.

According to an official government guidebook to the Grand Palace obtained during my visit in 1977, "the effigy was first discovered in Chiengrai in 1464, brought down to Lampang where it remained till King Tilok of Lannatai brought it to Chienmai, the capital, where it was fitly enshrined." At some later time it was taken by King Jayajettha to Luang Prabang, thence to the town of Wiengchand

HISTORY AND LORE

where it remained for a long period. A punitive expedition launched against Luang Prabang by the King of Dhonburi returned the statue to what now is the site of Bangkok. The temple in which the statue now rests was built in 1785 by King Rama I.

During my visit to the temple, I observed the statuette of Buddha in the seated position in good light but from the considerable distance mentioned above. The color is dull grayish-green, resembling the color of celadon ceramic glazes, and the surfaces glisten with polish that is almost glassy in appearance. Both the uniformity and brilliance of polish, plus the considerable size, suggest that the material is some fine-grained igneous rock or possibly a siliceous material akin to jasper. The official guidebook, however, says that it is "one-piece jade."

The Buddha's Tooth Emerald

Ball⁸¹ briefly described a stone, purporting to be an emerald, which supports the sacred relic known as "Buddha's tooth," preserved in the Dalada Malagawa temple at Kandy, Sri Lanka. The carving, said to be about 4 inches (10 cm) long and 2 inches (5 cm) deep, shows Buddha holding the sacred tooth in one hand. It is enclosed in seven cases, each successively more ornate than the last, and once a year the shrine is paraded through the streets of Kandy atop an elephant. Ball noted that "as the original shrine and the tooth were utterly destroyed by the Portuguese in 1560 the carving is evidently a relatively recent one." There appears to be no official identification of the stone itself, and it cannot be said at this time whether it is indeed an emerald.

Hernando Cortez' Emeralds

In his Third Letter of May 1522, Hernando Cortez reported to the Spanish Court the accomplishments of his expedition into Mexico and described an enormous emerald, shaped like a pyramid, that rested on a skull in the Hall of Justice in Texcoco. Surrounded by feathers and costly gems, it was known as the Tribunal of God and was used by the Aztec judges as an aide in deciding the guilt or innocence of accused parties brought before them. The size of the stone was such that its base was as broad as the palm of the hand.

This object, along with Cortez's letter, was sent to Spain in the care of two compatriots, one of whom died in a drunken brawl in the Azores, and the other, presumably with the emerald still in his possession, was captured by a French privateer. According to Ball,⁸¹ much of the loot obtained by the privateer passed into the hands of Francis I, King of France, but to this day no one has been able to account for the emerald itself.

Beryl in Magic, Mystery, and Medicine

Literature Cited

1. Schneider, O. 1892. Der aegyptische Smaragd . . . nebst einer vergleichenden mineralogischen Untersuchung der Smaragde von Alexandrien, vom Gebel Sabara und vom Ural. *Zeitschrift für Ethnologie* 24:41-100.
2. Kunz, G. F. 1913. *The Curious Lore of Precious Stones*. Philadelphia and London: J. B. Lippincott. 406 pp.
3. Gimma, G. 1730. *Della Storia Naturale delle Gemme*. 2 vols. Naples: Gennaro Muzio. 551, 603 pp.
4. Petrie, W. M. F. 1914. *Amulets: Illustrated by the Egyptian Collection in the University College, London*. London: Constable & Co. 58 pp.
- 4a. Petrie, W. M. F. 1917. *Scarabs and Cylinders with Names*. London: British School of Archaeology in Egypt, et al. 46 pp., 73 pls.
5. Caley, E. R., and Richards, J. F. C. 1956. *Theophrastus on Stones*. Ohio State University Graduate School Monographs, Contributions in Physical Science, no. 1. Columbus: Ohio State University Press. 238 pp.
6. Bostock, J., and Riley, H. T., trans. 1855-57. *The Natural History of Pliny*. Vol. 6. London: Henry G. Bohn. 529 pp.
7. Tagore, S. M. 1879. *Mani-Mála, or a Treatise on Gems*. 2 vols. Calcutta: Stanhope Press. 1046 pp.
8. Finot, L. 1896. *Les Lapidaires Indiens*. Paris: E. Bouillon. 280 pp.
9. Birdwood, G. C. M. 1880. *The Industrial Arts of India*. 2 vols. London: Chapman and Hall. 344 pp.
10. Tank, R. R. ca. 1968. *Indian Gemmology*. Jaipur: Dulichand Tank. 171 pp.
11. Bhattacharyya, B. 1976. *Gem Therapy*. Revised and enlarged by A. K. Bhattacharya. Calcutta: Firma KLM Ltd. 123 pp.
12. Thorndike, L. 1923-59. *A History of Magic and Experimental Science*. 8 vols. New York: Columbia University Press; see especially vol. 1, 2, 6, and 7.
13. Adams, F. D. 1938. *The Birth and Development of the Geological Sciences*. Baltimore: Williams & Wilkins. 506 pp.
14. Kunz, G. F. 1915. *The Magic of Jewels and Charms*. Philadelphia and London: J. B. Lippincott. 422 pp.
15. Bonner, C. 1950. *Studies in Magical Amulets, Chiefly Graeco-Egyptian*. Ann Arbor: University of Michigan Press. 334 pp.
16. Budge, E. A. W. 1930. *Amulets and Superstitions*. London: Humphrey Milford. 543 pp.
17. Pavitt, W. T., and Pavitt, K. 1914. *The Book of Talismans, Amulets and Zodiacal Gems*. Philadelphia: D. McKay. 292 pp.
18. Hansmann, L., and Kris-Rettenbeck, L. 1966. *Amulett und Talisman, Erscheinungen und Geschichte*. Munich: Verlag Georg D. W. Callwey. 270 pp.
19. King, C. W. 1866. *Antique Gems, Their Origin, Uses and Value*. 2nd ed. London: J. Murray. 498 pp.
20. Berquen, R. de. 1661. *Les Merveilles des Indes Orientales et Occidentales . . .* Paris: C. Lambin. 112 pp.
21. Alcott, T. ca. 1887. *Nativity: Its Facts and Fancies, Legends and Lore*. New York: J. Wiley & Sons. 112 pp.
22. Charubel. 1907. *Psychology of Botany, Minerals and Precious Stones*. Tyldsley: R. Welch. 351 pp.
23. Laars, R. H. 1932. *Das Buch der Amulette und Talismane*. 3rd ed. Leipzig: Richard Hummel Verlag. 304 pp.
24. Kozminsky, I. 1922. *The Magic and Science of Jewels and Stones*. New York and London: G. P. Putnam's Sons. 434 pp.
25. Fobes, H. K. ca. 1924. *Mystic Gems*. Boston: R. G. Badger. 117 pp.
26. Wyckoff, D. 1967. *Albertus Magnus Book of Minerals*. Oxford: Clarendon Press. 309 pp.
27. [deleted]
28. Bratley, G. H. 1906. *The Power of Gems and Charms*. London: Gay and Bird. 198 pp.
29. Sotto, I. del. 1862. *Le Lapidare du Quatorzième Siècle*. Vienna: Imprimerie Imperiale et Royale de la Cour et de l'État. 213 pp.
30. Megenberg, K. von. 1962. *Das Buch der Natur von Konrad von Megenberg: die erste Naturgeschichte in Deutschersprache*. Hildesheim: Georg Olms. 807 pp.
31. Holstein, O., and Koch, W. 1934. *Die Seele der Edelsteine*. Leipzig: Richard Hummel Verlag. 226 pp.
32. Stopford, F. 1920. *The Romance of the Jewel*. London: Privately published. 96 pp.
33. Schmidt, P. 1948. *Edelsteine: Ihr Wesen und ihr Wert bei den Kulturvölkern*. Bonn: Verlag der Buchgemeinde. 172 pp.
34. Leonardus, Camillus. 1750. *The Mirror of Stones*. London: J. Freeman. 240 pp.
35. Fairholt, F. W. 1871. *Rambles of an Archaeologist Among Old Books and in Old Places*. London: Virtue and Co. 529 pp.
36. Santini de Riols, E. N. 1905. *Les Pierres Magiques Histoire Complète des Pierres Précieuses*. Paris: Bibliothèque Chacornac. 173 pp.
37. Epiphanius. 1565. *De XII Gemmis . . .* Zurich: Conrad Gesner. ca. 56 pp.
38. Taille de Bondaroy, J. de la 1574. *La Geomance . . . Ensemble le Blason des Pierres Precieuses . . .* Paris: Lucas Breyer. 68 pp.
39. Villiers, E. 1927. *Amulette und Talismane und an-*

HISTORY AND LORE

- dere geheime Dinge. Edited and enlarged by A. M. Pachinger. Munich: Drei Masken Verlag. 314 pp.
40. Boodt, A. B. de. 1647. *Gemmarum et Lapidum Historia* . . . Postea Adrianus Tollius. . . . 3rd ed. Leiden: Joannis Maire. 576 pp.
 41. Garbe, R. von. 1882. *Die indischen Mineralien, ihre Namen und die ihren zugeschriebener Kräfte*. Leipzig: S. Hirzel. 104 pp.
 42. Alfonso X. 1881. *Lapidario del Rey D. Alfonso X., Codice Original*. Madrid: Imprenta de la Iberia. ca. 300 pp.
 43. Jones, W. 1880. *History and Mystery of Precious Stones*. London: Richard Bentley and Son. 384 pp.
 44. Saha, N. N. 1977. *Healing Through Gems*. New Delhi: Sterling Publishers. 152 pp.
 45. D. M. L. M. D. S. 1667. *Denombrement, Facultez et Origine des Pierres Precieuses*. Paris: Chez André Boutonné. 71 pp.
 46. Dragsted, A. 1933. *De aedle Stene og deres Mystik*. Copenhagen: Arnold Busck. 239 pp.
 47. Fernie, W. T. 1907. *Precious Stones: For Curative Wear and Other Remedial Uses: Likewise the Nobler Metals*. Bristol: J. Wright & Co. 486 pp.
 48. Thomas, N. W. ca. 1905. *Crystal Gazing, Its History and Practice*. New York: Dodge Publishing. 162 pp.
 49. Melville, J. 1903. *Crystal-Gazing*. New and rev. ed. London: Nichols & Co. 98 pp.
 50. Boyle, R. 1672. *An Essay about the Origine and Virtues of Gems*. London: William Godbid. 185 pp.
 51. Pitt, R. 1703. *The Craft and Frauds of Physick Expos'd*. London: Tim. Childe. 203 pp.
 52. Garboe, A. 1915. *Kulturhistoriske Studier over Aedelstene med Saerligt Henblik paa det 17 Aarhundrede*. Copenhagen and Christiana: Gyldendalske Boghandel. 274 pp.
 53. Etereo, Ardente [Arnobio, Cleandre]. 1619. *Tesoro delle Giole*. . . . Milano: Gio. Battista Bidelli. 209 pp.
 54. Bacci, A. 1587. *Le XII. Pietre Pretiose*. . . . Rome: Giovanni Martinelli. 130 pp.
 55. Evans, J. 1922. *Magical Jewels of the Middle Ages and the Renaissance*. Oxford: Clarendon Press. 264 pp.
 56. Nicols, T. 1652. *A Lapidary: Or, The History of Pretious Stones*. Cambridge: Thomas Buck. 239 pp.
 57. Rueus, F. 1565. *De Gemmis Aliquot*. 2nd ed. Zurich: Conrad Gesner. ca. 170 pp.
 58. Lonicer, A. 1679. *Kreuterbuch, Kunstliche Conterfeytunge der Bäume . . . dessgleichen von Metallen, Ertze, Edelgesteinen*. Rev. ed. by Petrus Uffenbachus. Ulm: Matthäus Wagner. Facsimile reprint, including the preface of the original 1582 edition, Naunhof near Leipzig: F. W. Hendel Verlag, 1934. 750 pp.
 59. Bingen, H. von. 1922. *Schriften der Heiligen Hildeward von Bingen*. Leipzig: Insel Verlag.
 60. Aldrovandi, U. 1648. *Musaeum Metallicum in Libros III Distributum*. Bologna: Marcus Antonius Bernia. 979 pp.
 61. Cooper, C. W. ca. 1924. *The Precious Stones of the Bible*. London: H. R. Allenson. 127 pp.
 62. Bolman, J. 1938. *De Edelsteen en uit den Bijbel gezien in het licht der hedendaagsche Edelsteenkunde*. Amsterdam: H. J. Paris. 138 pp.
 63. Rosenmüller, E. F. C. 1840. *The Mineralogy and Botany of the Bible*. Edinburgh: Thomas Clark. 342 pp.
 64. Harris, T. M. 1833. *A Dictionary of the Natural History of the Bible or a Description of All the Quadrupeds, Birds, . . . and Precious Stones Mentioned in the Sacred Scriptures*. Rev. ed. London: T. T. and J. Tegg. 350 pp.
 65. Clapton, E. 1899. *The Precious Stones of the Bible: Descriptive and Symbolical*. 2nd ed. London: Simpkin, Marshall, Hamilton, Kent & Co. 231 pp.
 66. Schopper, J. 1604. *Biblisches Edelgesteinbüchlein*. Altenburg and Nurnberg: cited in P. Schmidt (see 33, above).
 67. Kunz, G. F. 1928. *Birthstones, Natal Stones, Sentiments and Superstitions Associated with Precious Stones*. 28th ed. New York: Tiffany & Co. 29 pp.
 68. Blum, J. R. 1832. *Taschenbuch der Edelsteinkunde*. Leipzig: F. A. Brockhaus. 561 pp.
 69. Taylor, I. G. 1936. *The History and Significance of Birthstones and Their Link with Planetary Influences*. London: Grant's, Ltd. 78 pp.
 70. Heaps, W. 1969. *Birthstones*. New York: Meredith Press. 138 pp.
 71. Miro y Argenter, J. I. 1870. *Estudio de las Piedras Preciosas*. Madrid: Imprenta á Cargo de C. Moro. 288 pp.
 72. Morales, G. de. 1605. *Libro de las Virtudes Y Propiedades . . . de las Piedras Preciosas*. Madrid: Luis Sanchez. 378 pp.
 73. Klein, F. 1941. *Smaragde unter dem Urwald*. Berlin: Oswald Arnold Verlag. 285 pp.
 74. Lernoux, P. 1966. *Columbia's Lost Treasure Sought by U. S. Combine*. *San Diego Union*, February 6, p. G4.
 75. Canova, L. J. 1921. *Chivor-Somondoco Emerald Mines of Colombia*. New York: Colombian Emerald Syndicate. 30 pp.
 76. Vega, G. de la. 1715. *Histoire des Incas*. Translated by J. Baudoin. 2 vols. Amsterdam.
 77. Rosnel, P. de. 1667. *Le Mercure Indien, ou le Tresor des Index*. 2 pts. Paris. 64, 176 pp.
 78. Budge, E. A. W. ca. 1965. *Egyptian Magic*. Facsimile reprint. New Hyde Park: University Books. 234 pp.
 79. Karabacek, J. 1893. *Ein römischer Cameo aus dem Schatze der Aijübiden-Sultane von Hamäh*. *Sir-*

Beryl in Magic, Mystery, and Medicine

- zungsberichte der königliche Akademie der Wissenschaften, Philosophische-historische Klasse, Wien, vol. 129. 22 pp.
80. Pliny. 1962. *Natural History. With an English Translation in Ten Volumes*. Vol. 10, Books 36-37. Translated by D. E. Eichholz. Loeb Classical Library. Edited by T. E. Page et al. London: William Heinemann. 343 pp.
81. Ball, S. H. 1924. Some facts about famous emeralds. *Jewelers' Circular* 88, no. 10, pp. 63-65.
82. Veltheim, A. F. von. 1800. *Sammlung einiger Aufsätze historischen, antiquarischen, mineralogischen und ähnlichen Inhalts*. 2 vols. Helmstadt: C. G. Fleckeisen. 268, 291 pp.
83. Holmyard, E. J. 1923. The emerald table. *Nature* (London) 112, no. 2814. pp. 525-6.
84. Doberer, K. K. 1948. *The Goldmakers: 10,000 Years of Alchemy*. London: Nicholson & Watson. 301 pp.
85. Stella, E. 1530. *De Gemmis Libellus Unicus*. Strassburg. 128 pp.
86. Bandy, M. C., and Bandy, J. A. trans. 1955. *De Natura Fossilium (Textbook of Mineralogy)*, by G. Agricola. Geological Society of America Special Paper 63. New York: Geological Society of America. 240 pp.
87. Gesner, C. 1565. *De Rerum Fossilium, Lapidum et Gemmarum*. . . . Zurich. ca. 340 pp.
88. Notton, C. 1932. *The Chronicle of the Emerald buddha*. Bangkok: Bangkok Times Press. 52 pp.
89. Bray, W. 1978. *The Gold of El Dorado*. London: Times Newspapers, Ltd. 240 pp.

CHAPTER

4

BERYL IN ART AND ORNAMENT

THE first artistic treatment of beryl occurred in ancient Egypt when emeralds were carved into scarabs and amuletic figures. In a later period, when the Greeks dominated the Mediterranean, their love for personal adornment expressed itself in gold jewelry employing single crystals of Egyptian emerald, squared off upon their ends, and the natural crystal planes polished to remove irregularities. Some were set in jewelry, but most of the stubby hexagonal prisms were bored through so that they could be used as beads or held in place with gold wires. Exceptional specimens of emerald and beryl were also carved into the miniature sculptures known as engraved gems, but faceted gems, of the kind that are so common today, were then unknown.

ENGRAVED BERYL GEMS

The most important collections of engraved gems in the British Isles are in the British Museum, London, the descriptions of which are given in several catalogs issued by the museum.^{1,2,3} Because such gems were commonly set in rings, the splendid catalog of rings by Marshall⁴ should also be consulted. Most engraved gems are cut *intaglio*, that is, with the design incised below the upper surface of the gem. This is to be contrasted to the *cameo* style, in which the designs are actually shallow sculptures raised above the surface of the base of the gem.

Among the British Museum gems are a number executed in blue aquamarine and a smaller number in emerald. One of special merit is a Medusa head carved in emerald and set in an elaborate mounting of Italian renaissance workmanship. This piece is depicted in color in Davenport.⁵ A Graeco-Roman emerald gem, inscribed

Beryl in Art and Ornament

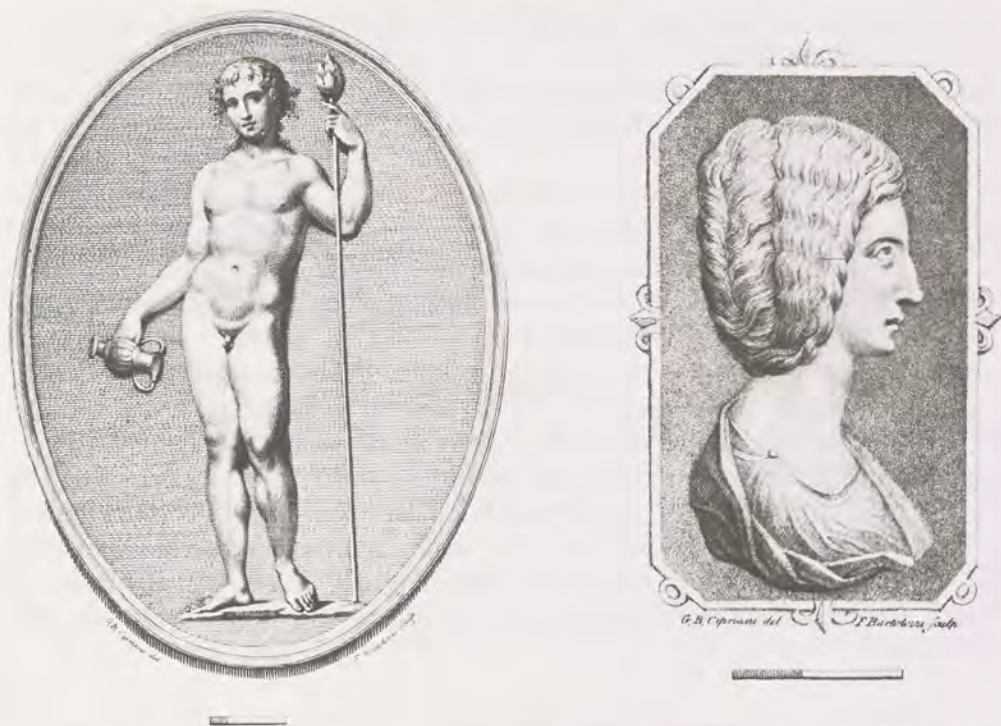

Fig. 4-1 Engraved gems in aquamarine formerly in the collection of the 4th Duke of Marlborough (1739–1817) and depicted in engravings in the catalog entitled *Gemmarum Antiquarum Delectus*, vol. 1, published about 1780. Left: a figure of Bacchus; right: bust of Julia Domna (ca. 170–217 A.D.), wife of the Roman emperor Septimius Severus. The actual heights of the gems are 14 mm ($\frac{1}{4}$ in) and 24 mm (1 in) respectively.

with Greek letters, is No. 577 in Marshall's catalog, which also includes several other antique emerald-set rings that are not engraved in any manner. The inscribed example mentioned above is also included in Richter's catalog⁶ as No. 401. The latter catalog also includes a Roman gem of aquamarine (No. 457), an aquamarine intaglio ornamented by small facets around its girdle (No. 637), both of which are in the Duke of Devonshire's collection as well as a large blue beryl intaglio of 24 × 20 mm ($1 \times \frac{13}{16}$ in) (No. 656).

Elsewhere in London, the C. H. Townshend collection in the Victoria and Albert Museum contains a splendid, richly colored emerald of 22 × 18 mm ($\frac{7}{8} \times \frac{3}{4}$ in) engraved with Persian script as shown in Figure 3-4. This gem was originally in the Hope collection and is also shown on plate 14 of the Hope collection catalog.⁷ It is said to have cost Townshend £45 when purchased in 1840.⁸ Among other emerald objects from the Hope collection, but whose whereabouts are un-

HISTORY AND LORE

known, are a small, dark green emerald head of Anacreon, measuring on plate 14 of Hope's catalog 16×14 mm ($\frac{5}{8} \times \frac{9}{16}$ in) and a finely-carved miniature of an owl with a human face, measuring on the plate about 18 mm ($\frac{3}{4}$ in) high and 10×12 mm ($\frac{3}{8} \times \frac{1}{2}$ in) square. These objects are believed to be approximately the sizes mentioned.

Magnificent engraved gems are preserved in several French collections, the largest and most important being that in the Cabinet des Médailles in Paris.^{9,10} Several examples in emerald and aquamarine are included, from an extremely old Egyptian cylinder of emerald to relatively modern pieces. The best known is the portrait of Julia, daughter of Emperor Titus (40?–81 A.D.), which is Chabouillet's No. 2089 (see figure 4-2). The material is called blue "oriental" aquamarine, presumably because of its fine color. It measures 50×35 mm ($2 \times 1\frac{3}{8}$ in), and the signature of Euodos, the engraver, appears on its back. Described by Middleton¹¹ as "one of the noblest glyptic portraits in the world," it was once owned by Charlemagne (742–814 A.D.). He presented it to the Abbey of St. Denis after it was fixed in a setting of pearls and precious stones and mounted at the apex of a reliquary, which became known as the Oratorium of Charlemagne. Elsewhere in France, some excellent engraved gems of beryl varieties are in the Troyes Cathedral collection.¹²



Fig. 4-2 Aquamarine intaglio of Julia, daughter of the Emperor Titus, engraved by Euodos and measuring 50×35 mm ($2 \times 1\frac{3}{8}$ in). Located in the Cabinet des Médailles, Paris. From C. W. King's *Antique Gems and Rings*, vol. 2 (London, 1872), plate 50.

1.

Beryl in Art and Ornament

In the United States, a large, important collection is in the Metropolitan Museum of Art, New York. The collection contains several examples fashioned from beryl.^{13,14} The Museum of the University of Pennsylvania, Philadelphia, houses the Somerville collection, in which appear several engraved gems of emerald and aquamarine.^{15,16} An extremely large engraved gem of Julius Caesar was obtained in 1928 by Arthur Silberfeld, a New York gem dealer, and at the time was suggested as having been a prized possession of Napoleon. The carving was done by Henri August Burdy of France upon a piece of rough that weighed over 1,000 carats, with the finished gem weighing 225 carats. In 1931 it was offered for sale and more recently it appeared in the hands of a jewelry firm in Boston^{17,18} and, as of 1980, remained unsold.

An engraved emerald to which considerable historical importance is attached came into prominence in connection with the Irish Rebellion and the continuing difficulties experienced in that country between the British and certain Irish dissidents. While not of exceptional quality in terms of material, the gem, measuring "about one square inch in size," bears upon its face a skillfully executed engraving of a maiden kneeling before the traditional Irish harp and plucking its strings. The gem was acquired by Robert Emmet (1778–1803), an Irish Nationalist and physician to the Lord Lieutenant of Ireland, from Sir John Temple, who had brought the



122

HENRY IV.

Roi de France, par Coldoré.

Emeraude

Fig. 4-3 An engraved gem in beryl executed in the 18th century, depicting Henry IV, King of France. The actual size is shown in the upper left-hand panel. From P. J. Mariette, *Traité des Pierres Gravées*, vol. 2 (Paris, 1750).

HISTORY AND LORE

stone from India. Presumably it was originally in rough or cabochon form, and the design, said to be the seal of the United Irishmen of 1803, was engraved later. Because of its use as a symbol and mark of identity, it was the object of an intensive but unsuccessful search on the part of the British. Eventually it made its way into the hands of the Emmet family of Washington, D.C., who intended to present it to the Dublin Museum.¹⁹

Several Italian museums contain important engraved gem collections, but the best known single gem is that in the Treasury of St. Petronio, Bologna. It is an enormous emerald, cut from a slice of a crystal, about 50 mm (2 in) across. Carved in 1750 in Rome by the celebrated artist Carlo Costanzi, it represents on one side the bust of Pope Benedict (a native of Bologna) and, on the other, the heads of St. Peter and St. Paul. The work took two and one-half years and the artist claimed it to be his finest accomplishment.²⁰ At the time, the gem was set in a *morse*, or brooch, and was used by the pope to fasten the cope worn during high festivals. As the story goes, Pope Benedict wore it only once, then presented the brooch to the Church of St. Petronio.

Another papal emerald, which has now been lost, was the so-called Emerald Vernicle of the Vatican,²¹ which bore upon it the head of Christ. It was given to Pope Innocent VIII by Sultan Bajazet II in about 1488. There seems to be no truth in the legend that it had been engraved at the time of Christ by order of Tiberius Caesar. C. W. King²¹ claims that the work was done sometime before 1453 by an unknown Byzantine artist. When Constantinople fell to the Turks in that year, the gem became part of the treasure looted from the city.

Another famous Italian gem, also lost, is described in an amusing story attributed to Leonardo Da Vinci.²² The goldsmith Salomone de la Sessa had obtained the special favor of Pope Alexander VI (papacy, 1492–1503) by presenting him with a large flat emerald depicting the Callypugian Venus. This pleased the pope so much that he had the gem set in a cross used to bless the populace at St. Peter's in Rome. As the story goes, "every time he kissed the cross, he also pressed the beautiful goddess to his lips."

The engraved gems of the Prussian State Cultural Museum in Berlin include two dark green emeralds labeled as "Indian" in respect to origin, although it seems clear that they must have been Egyptian stones because of the age assigned to them²³ (No. 559, 560). An earlier catalog of this collection by Furtwängler²⁴ shows that out of nearly 12,000 engraved gems, only two are aquamarine and four are emerald, thus corroborating earlier remarks about the scarcity of beryl in antiquity.

The U.S.S.R. Diamond Fund in Moscow contains a remarkable emerald intaglio with faceted edges and bearing the portrait of Catherine the Great (1729–1796). It is a fitting commemoration of her connoisseurship of gems, of which she amassed a great collection. This gem, 29 × 22 mm (1³/₁₆ × ⁷/₈ in) in size, weighs 26 carats and is Colombian material, engraved by Eger in the second

LXXXVII. THE EMERALD VERNICLE.



Fig. 4-4 The fabled portrait of Jesus Christ said to have been carved on a large flat emerald. From C. W. King's *Handbook of Engraved Gems* (London, 1885).

half of the 18th century.²⁵ The expansion of Mediterranean cultural influences into the Black Sea region beginning by at least 500 B.C. is reflected in numerous engraved gems found in ancient town ruins of the Scythians along the north coast, particularly on the Crimean Peninsula. Of the several hundred examples described in a memoir on the subject, only two emeralds are included.²⁶

Several engraved emeralds are in the collection of the Thorvaldsen Museum in Copenhagen. They are all of small size and of Graeco-Roman workmanship.²⁷ The Kunsthistorisches Museum in Vienna, Austria, boasts a splendid emerald cameo of 33 × 29 mm (1⁵/₁₆ × 1³/₁₆ in) depicting Kaiser Leopold I (1640–1705), engraved by the noted goldsmith and medallist Daniel Vogt.²⁸

HISTORY AND LORE



Fig. 4-5 Emerald cameo portrait of Kaiser Leopold I (1640–1705) of the Holy Roman Empire, engraved by Daniel Vogt. The emerald measures 33×29 mm ($1\frac{1}{16} \times 1\frac{3}{16}$ in). Courtesy Kunsthistorisches Museum, Vienna.

INSCRIBED EMERALDS OF ISLAM

A common and often beautiful feature of Islamic art is the employment of the graceful Arabic script in the decoration of many kinds of objects, paintings, and other forms of pictorial art. Often such writings are quotations from the Koran, sentimental or magical sayings, statements of ownership, or signs of veneration and esteem. Being available in relatively large sizes, the turquoise was a favorite gem for such inscriptions, but they are also found on rubies, spinels, emeralds, and even diamonds. The famous Shah diamond of 88.70 carats preserved in the Diamond Fund in Moscow bears no less than three inscriptions.²⁹ Emeralds from Colombia were particularly desired because the large crystals could be sliced across to provide broad areas for engraving and pleasing hexagonal shapes. These sections were sometimes polished flat, or with a slight curvature, to receive the inscription, while the other side was decorated with shallow carving of foliage and flowers. Such jewels were greatly esteemed by the Mogul princes of India, and it is from their treasuries that most surviving examples have come.

A beautifully carved emerald of this sort is described by Caplan³⁰ and shown in figure 4-6. It is $50 \times 37 \times 10$ mm ($2 \times 1\frac{1}{2} \times \frac{3}{8}$ in) and weighs 217.80 carats. All surfaces are delicately engraved and carved, one face bearing floral work and the other five face panels inscribed with prayers in Arabic calligraphy. The American Museum of Natural History in New York owns a square engraved emerald of 88 carats, known as the Schettler emerald after its donor. It is also of Indian workmanship, like a companion piece of 67 carats in the same collection, and was

Beryl in Art and Ornament



Fig. 4-6 One of the finest known examples of Arabic calligraphy engraved on a gem, in this instance, a fine emerald. The inscription consists of several Islamic prayers and bears the Mohammedan date of 1107 A.H. or 1695 A.D. The reverse side is beautifully engraved with floral ornamentation in shallow relief. Protuberances on the sides are drilled to permit attachment of the ornament to clothing or in a jewel. $2 \times 1\frac{1}{2} \times \frac{3}{8}$ in ($5 \times 3.8 \times 1$ cm), 217.80 carats. Courtesy Allan Caplan Collection, Precious Stone Importer, New York City.

probably carved during the 17th century. Among the lovely colored plates in Stopford's book on jewels,³¹ plate 13 shows several examples of fine carved Mogul emeralds. According to Stopford, a little before 1920 an engraved Mogul emerald of 78 carats appeared in London bearing upon its edge Persian script declaring that "he who possesses this charm shall enjoy the special protection of God."

In the early part of the last century, Shah Shuja (1780?-1842) presented a magnificent carved emerald to the East India Company. In the shape of a finger ring, it was cut from a single emerald crystal, measured about 31 mm ($1\frac{1}{4}$ in) in diameter, and bore the name of Jehangir (1569-1627), the Mogul Emperor of India. It eventually passed into the hands of Lord Auckland (1784-1849), then governor-general of India, but by 1867 it was in the possession of a certain Miss Eden of England. A similar ring, but without inscription, is shown in the lower right in figure 4-7.

Even more astonishing as a tour de force was the *bazu band* or *bajoobund* once owned by the Nawab of Dacca (also shown in figure 4-7). This object was tied to the arm as a kind of ceremonial ornament much favored by Indian nobility,

HISTORY AND LORE

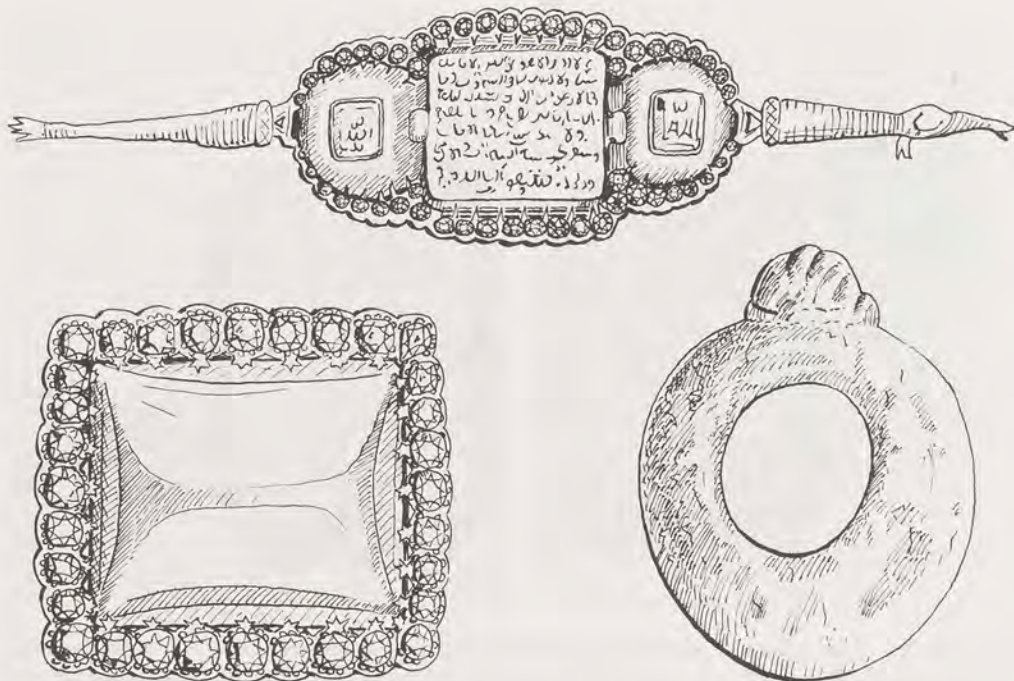

Fig. 4-7 Sketches of large and important Indian emerald jewels employing Colombian emeralds, after illustrations of T. H. Hendley, *Indian Jewellery* (London, 1909). *Top*: A "bazu band" or armband composed of three interlinking emeralds. The center stone is engraved with verses from the Koran and the side stones are set with diamonds engraved with the word for Allah. *Lower left*: Clasp or buckle for a state sword, which, like the armband, once belonged to the Nawab of Dacca; the large central emerald is a cushion-cut cabochon, "wonderfully free from flaws, and is of considerable antiquity." *Lower right*: An archer's bow ring cut from a single enormous emerald crystal and believed to be 17th-century Mogul.

but its unique feature is that it consisted of three interlocking links all carved from a single emerald crystal. The central link bore upon its upper surface inscribed verses from the Koran, while the side pieces were each set with large diamonds inscribed with the name of Allah. As depicted in color on plate 113 in Hendley's great work on Indian jewelry,³² it measures about 77 mm (3 in) long and the central stone is about 28 mm (1 1/8 in) long. According to Hendley, "the three emeralds are cut in the form of a hinge, and require no setting to hold them together." The same plate also depicts a splendid, nearly flawless cushion-shaped emerald cabochon set in a diamond-jeweled mounting, and a remarkable gold cup largely fabricated of cut emeralds and rubies.

In 1850 and 1851 the British Government in India conducted a series of auction sales to dispose of property confiscated from the royal treasury of Lahore in ac-

Beryl in Art and Ornament

cordance with the terms of the Treaty of Lahore. The vast treasure, as indicated in several sales catalogs,³³ contained jewels, single gems, ornamental objects, weapons, clothing, jeweled horse trappings, and many other precious items, all formerly belonging to Maharajah Duleep Singh (1837–1893), son of the famous Ranjit Singh (1780–1839), the “Tiger of the Punjab.” Ranjit Singh is best known among gem experts for having extorted the Koh-i-Nur diamond from Shah Shuja while the latter was seeking refuge in his court after being deposed from his throne in Afghanistan.³⁴ Ranjit Singh remained on friendly terms with the British occupants of India, but his son, Duleep, was deposed in 1849 for having instigated several revolts against the British, and his Punjab kingdom was annexed to the rest of India.

The quantity of jewels and precious gems comprising the treasure of Lahore almost surpasses belief. Among them were “a most valuable emerald pommel, set in rich gold: it consists of 5 immensely large emeralds of a very beautiful colour, surrounded by 24 smaller ditto, the whole estimated to weigh upwards of 600 rutties [ca. 300 cts].”³³ This object was said to have been the property of the Nadir Shah (1688–1747). Another exceptional item was “a very valuable and beautiful emerald and diamond Kulgee [plume-ornament holder], formed of 1 very fine coloured emerald of upwards of 2½ inches long, and 5 diamonds . . . formerly in the possession of the Nadir Shah, whose name is engraved on the emerald.”

Hoping to arouse public opinion in his behalf, Duleep Singh republished the catalogs with the argument that the confiscated treasures were “personal” rather than “state” property, but this availed him nothing. The Koh-i-Nur, also part of the Lahore treasure, was sent to England, recut into its present form, and made part of the Royal English Crown Jewels. The remainder of the treasure was widely dispersed, and it now seems likely that the very large emeralds were cut into smaller, more readily saleable gems, their identities lost forever.

Several remarkable inscribed emeralds are in the Iranian royal treasure in Tehran, about which more will be said later in this chapter. This hoard was described and depicted by Meen and Tushingham.³⁵ One of the emeralds is a deep green, flat, circular seal, 49 mm (2 in) in diameter and 8.6 mm ($\frac{5}{16}$ in) thick, weighing 189.22 carats and engraved with personal names dated to 1607–8. The famous Globe of the World, made of gold and paved in gemstones of various colors to represent lands and seas, contains a fine large emerald set in the Pacific Ocean and inscribed “Jahangir Shah 1018” (1609–10 A.D.). Another magnificent emerald is a low, rounded cabochon retaining the original hexagonal crystal form, and covered with fine Arabic script.

CARVINGS IN BERYL

No large sculptures in beryl were made until the enormous emerald crystals from Colombia became available in the 16th century. The earliest for which some authentic record exists are those that Hernando Cortez brought back to Spain after

HISTORY AND LORE

his triumphs in the New World. These carvings were described by Ball³⁶ and Epler.²² Returning from Mexico in 1528, Cortez presented his bride, Doña Juana de Zuniga, a suite of carved emeralds as follows: a carving of a rose, another in the form of a horn, a fish with eyes of gold, a bell fitted with a fine pearl as the clapper and with an inscription along the rim saying that "blessed is he who created thee," and a small emerald cup to which were attached gold feet and four gold chainlets attached to a large pearl. The rim of the cup was edged in gold and bore a Latin motto. It is said that the Queen of Spain passionately coveted these jewels but Cortez refused to part with them and instead presented the Queen with other jewels. Her pique was not allayed, however, and through her intercession Cortez's influence in the court steadily declined. Sometime later, Cortez participated in an expedition against Algiers during which he took along his emerald carvings, only to see them lost when his vessel was wrecked.

Juan de Mariana (1536–1623), writing in his Latin history of Spain, mentioned that Cortez also owned two vessels made of emerald valued at 300,000 gold ducats. Whether these objects were actually emerald has been questioned from time to time, but Ball³⁶ was of the opinion that they were. Ball also mentioned a carving of a parrot in emerald that was given by King Pedro II of Portugal to his bride, the Princess of Savoy in 1668. It is said that it passed into the collection of the Tsar of Russia and was kept in the Winter Palace, but there seems to be no modern record of this piece.

Moving from the rumored to the known, a splendid emerald carving is the unguent jar shaped from a single enormous dark green Colombian crystal, which is housed in the Kunsthistorisches Museum in Vienna (see figure 4-8). It measures about 10 cm (4 in) tall and weighs 2,680 carats. Exquisite trceries of enameled gold serve as fittings and provide a hinge for a matching carved lid. The work, completed in about 1642, is attributed to the celebrated Dionysio Miseroni (d. 1661), one of a family of Milanese lapidaries. This vessel, along with other treasures of the Viennese collection, was sent on an international tour and was exhibited in the United States in 1949.³⁷

A regal baton, carved from an emerald, and capped with a carved ruby bird, was once owned by an Indian rajah and was said to have originally belonged to Harun-al-Rashid (746–809 A.D.), the most famous caliph of Bagdad. It was purchased from a gem dealer by the name of Muslim Ibn'Abdallah, according to Karabacek,³⁸ but Karabacek suggests that the staff was made from beryl rather than emerald. The whereabouts of this object is unknown.

Another unusual emerald carving, a kind of container, described by King²⁰ as "monstrous" in size, was supposedly acquired by an explorer named Major Pearse during travels in India. The emerald measured 75 mm (3 in) long and 50 mm (2 in) thick and was bored through half its length to take a gold case, the size of the

Beryl in Art and Ornament



Fig. 4-8 Emerald unguent jar carved by Dionysio Miseroni out of a single enormous Colombian emerald crystal, with faceted emerald lid, gold fittings. The color is dark green. Height ca. 10 cm (4 in). *Courtesy Kunsthistorisches Museum, Vienna.*

little finger, in which were preserved two very small finger joints of a Buddhist saint.

A large Colombian emerald crystal was put to more prosaic use in 17th century London when a jeweler made a splendid watch case and matching lid from slices of a hexagonal emerald prism. The dial itself was enameled green to match the emerald, and the hinged lid was so transparent that the time could be easily read through it. This beautiful object was found with many other jewels, evidently part of the jeweler's stock, which were uncovered by workmen digging in an area of Cheapside. It is part of the Cheapside Hoard, described by Wheeler³⁹ and illustrated by Black.⁴⁰

As mentioned before, the large and fine Colombian emeralds quickly found favor among the rulers of the Near East and India, but they were rarely cut into faceted gems. Most were carved into plaques or made into beads, sometimes of enormous size. A favorite surface treatment of such beads was the "melon" style of carving, where a series of grooves were incised around the bead causing it to resemble a ribbed melon. This treatment added interest and at the same time enabled lapidaries to remove or disguise flaws. Excellent examples of melon beads appear in the crown made for Empress Farah's coronation in Iran in 1967 as shown in

HISTORY AND LORE

Heiniger⁴¹ (p. 80) and in Meen and Tushingham.³⁵ A drawing of the crown is shown in figure 4-9.

The splendid 200-carat carved emerald pendant formerly belonging to celebrated opera star Madame Ganna Walska and sold on April 1, 1971 at auction for the sum of \$54,000 by Parke-Bernet Galleries of New York, is one of the truly important examples of Mogul-type carving in emerald. Its present owner is unknown, the name of the purchaser at the time not having been given. However, it is exceeded in size by the enormous emerald plaque bearing shallow sculptures representing, according to Hughes,⁴² personages from "Hindu mythology" and, on its back, a "Moghul flower." It is trapezoidal in outline, with a curved bottom

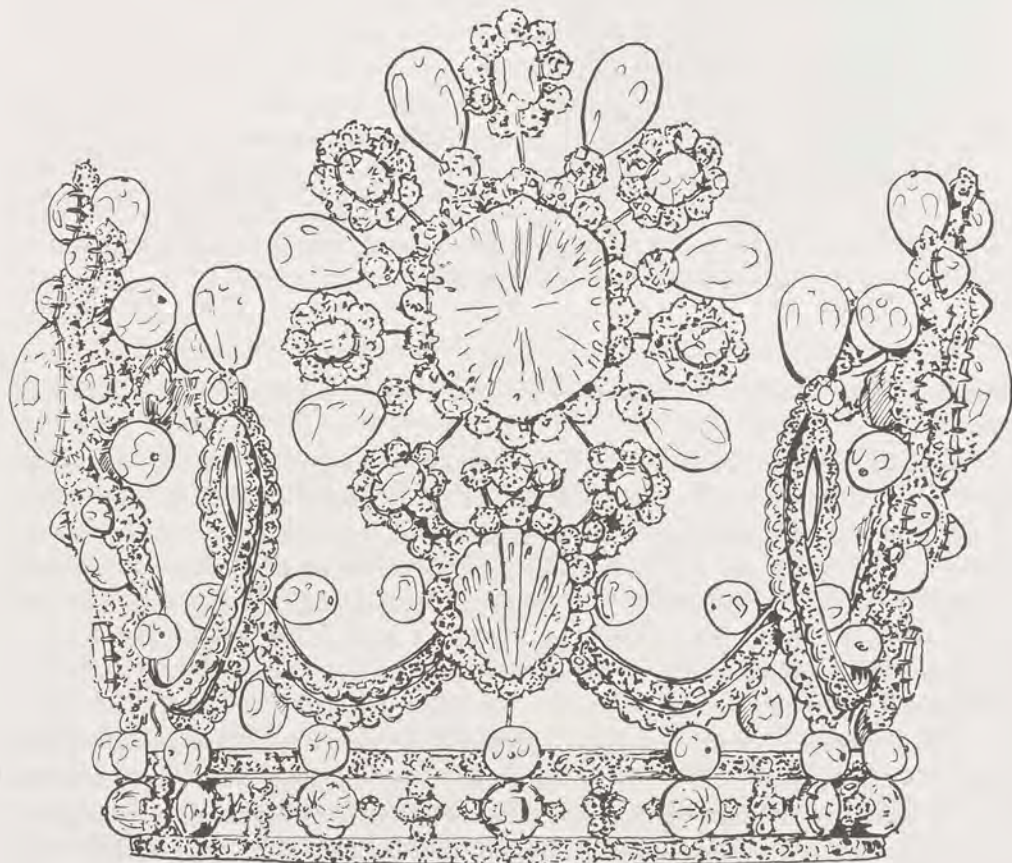

Fig. 4-9 The jeweled crown made for the coronation of Empress Farah of Iran in 1967. The two large central stones are carved emeralds with other emeralds being employed in the band and elsewhere. Altogether there are 36 emeralds, 34 rubies, 2 spinels, 105 pearls, and 1,469 diamonds. The crown weighs 1,480.9 grams.

Beryl in Art and Ornament

edge, and measures an astonishing 9 cm (3 $\frac{5}{8}$ in) across. According to Hughes, who shows the piece in color, the plaque is drilled through along the top edge for suspension and was "worn . . . as a family heirloom by a north-west Indian maharajah since the nineteenth century, and sold in 1971 for £100,000 (\$260,000)." The same gem, now mounted in a precious metal and diamond pendant, is shown nearly full size in Heiniger⁴¹ (p. 296). Here it is called "The Great Mogul Emerald," and its weight given as 362.45 carats, but its provenance is "veiled in mystery." The scene depicted is said to be that of "noblemen and noblewomen of the ruling dynasty," and the style of carving "would date this gem to approximately the 16th century."

Turning to other varieties of beryl, it is remarkable that so few important carvings can be found in aquamarine, golden beryl, and morganite, despite the availability of large crystals eminently suitable for such purpose. It was not long after the discovery of emerald mines in Colombia that explorations in Brazil uncovered fine and large crystals of beryl, but, it seems, most were cut into faceted gems and very few, perhaps because of paleness of color, were ever utilized for in-the-round sculpture.

Among works of art in stone, Chinese snuff bottles made of aquamarine and golden beryl are some of the rarest and therefore most highly prized types. According to Perry,⁴³ "the fashion of taking snuff started in China and Europe almost at the same time, roughly about 1650," and it is from this date that these small snuff containers began to be made from a large variety of materials and with the exercise of considerable skill and ingenuity in design. As explained in Chapter 1, beryl crystals were not available from Chinese sources until relatively recently when deposits were found in Mongolia. However, it is possible that the long prismatic crystals found in the mountains of Transbaikalia, U.S.S.R., near the Mongolian border, and known to have been mined since early in the 18th century, may have been traded into China to supply their lapidaries with the necessary material. In general, snuff bottles made from aquamarine and golden beryl reflect the shapes of the original crystals by being rather narrow in width in relation to height. Many contained flaws which were cleverly disguised in the finished product by choosing designs in which depressions would remove cracks and inclusions, or at least make them less noticeable. Perry remarked on the scarcity of beryl snuff bottles, and especially those made from golden beryl and morganite, the pink variety, but this merely reflects the fact that these varieties were far less common than aquamarine, while in the case of morganite, this variety occurs in far fewer places, not including sources in Transbaikalia and Mongolia.

Both the Chinese and Japanese used prismatic crystals of beryl for seal-stones, retaining the usual elongated shape of the crystals and flattening one end to receive the owner's name. In many instances, such seals began as prisms about 10 cm (4

HISTORY AND LORE

in) long but as they passed from hand to hand, the previous owner's name was ground away and the name of the new owner carved in its place. This resulted in a steady shortening of the prism until it became too small to hold comfortably in the fingers, perhaps becoming as short as 2.5 cm (1 in)—such short dimension being in itself a clue to the antiquity of the piece.

Occasionally aquamarine was carved into Japanese *netsuke*, the ornamental buttons used with traditional men's costumes since about the Tenshō period (1573–1592), according to F. M. Jonas, *Netsuke* (Rutland: Charles E. Tuttle Co., 1960). These buttons hooked under the waist sash and were used to suspend small tobacco or medicine boxes known as *inro*. Jonas claims that by about 1830 the custom of wearing netsuke died out more or less completely. The extremely few beryl netsuke that I have seen appear to have been made in China for ornamenting a costume or serving as a clothes button rather than being carved specifically as netsuke.

Among the very few notable modern carvings in beryl is a splendid morganite figurine in the William Boyce Thompson collection in the American Museum of Natural History in New York. It is Madagascar material carved in China, standing 15 cm (6 in) tall. According to Pough,⁴⁴ the former curator of the collection, it is “without any doubt, the largest and finest morganite carving in existence.”

EMERALD AND BERYL IN COLLECTIONS

Iran

The crown jewels of Iran are housed in a large basement vault in the National Bank of Iran, Tehran, and the exhibits are open to the public. They form what are generally conceded to be the “richest and most dazzling single collection of jewels in the world.”⁴⁵ The beginning of the collection dates to the Savafid period (1501–1736), with the greatest enlargement due to Shah Abbas (1587–1629). He was not only largely responsible for forging the Iranian empire into a powerful state but was also a connoisseur of gems and jewels and an ardent collector. After remaining virtually unknown for several centuries, the collection was organized, cases installed, and the exhibits first opened to the public in 1960. The best descriptive catalog of the collection, lavishly illustrated and most carefully detailed, is that of Meen and Tushingham.³⁵

Emeralds appear in many of the cases but are concentrated in two, of which Meen and Tushingham say “both set and unset . . . in number, quality, and size exceed any display of emeralds known elsewhere.” After I viewed the Topkapi Museum collection in Istanbul several years ago, I thought I had seen the best, but this idea was quickly dispelled by a glance at the first few cases in the vault in Tehran. Not only are emeralds present in vast quantities, many of superb quality and individually worth many thousands of dollars, but it also becomes apparent that it would be utterly impossible to place a monetary value on the emeralds alone, not

Beryl in Art and Ornament

to mention the diamonds, rubies, spinels, and other gems, as well as objects of art worked in gems and precious metals.

By far most emeralds in the collection are Colombian; indeed, Meen and Tushingham go so far as to say that they could not surely recognize any as Egyptian or Indian, while "emeralds from the Russian Urals are present in relatively small numbers" (p. 31). The richest hoard of emeralds is in several boxes overflowing with large, rounded and polished crystals, many well over 100 carats each, accompanied by emerald-decorated jewels and rings. However, a singular emerald-jeweled box, which is "probably the most valuable of all the jewels, apart from the Darya-i Nur [diamond]," features a solid pavé of dark-green faceted emeralds on all sides and on the lid, the latter being crowned by a single emerald of 25×18 mm ($1 \times 1\frac{1}{16}$ in) estimated to weigh 25 carats. Most of the value of the box lies in the fact that the stones are of superior color and remarkably free from flaws.

Another small box, evidently cut from a single emerald crystal, consists of a lid and bottom of emerald, each fully carved, and fastened with gold-enamel work. This exquisite object is signed by Michael Perchin, a workmaster of Fabergé. A splendid *jiqua*, or turban ornament, takes the form of a plume in precious metals, paved overall with diamonds, and bearing in its center a magnificent round cabochon emerald estimated to weigh 65 carats. A drawing of this jewel appears in figure 4-10. The imperial sword, studded with large gems, contains numerous faceted emeralds, among which are two of about 100 and 110 carats. Several modern ornaments, such as the tiara of the recently deposed empress, also feature outstanding emeralds. The tiara, made by Harry Winston of New York, is set with many fine emeralds, but perhaps its most notable feature is the use of colored diamonds along the headband. Emeralds, carved in the so-called "melon" shape, are also prominent in the empress's coronation crown shown in the drawing of figure 4-9.

Finally, but no means last, is the jeweled globe of our planet, which is called "The Great Globe" by Meen & Tushingham,³⁵ who enthusiastically state that "surely this is the most resplendent globe ever created!" This stunning object stands 108 cm (43 in) high; the rotatable globe measures 45 cm (18 in) in diameter and is almost entirely covered by closely set precious stones, numbering more than 51,000. The major portion is paved with emeralds because they were chosen to represent the ocean and other bodies of water. In its manufacture, 34 kg (75 lb) of gold were used. According to Meen & Tushingham, a plaque set in the north Pacific Ocean bears the inscription "Nasir ud-Din Shah, the Sultan, Son of the Sultan, May God Perpetuate His Reign, 1291," or 1874-75 A.D.

Turkey

The hoard of jewels preserved in the Topkapi Palace Museum in Istanbul is open to the public and popular with tourists, especially since the motion picture *Topkapi* publicized its treasures. Collected by past rulers of Turkey and the Ottoman

HISTORY AND LORE

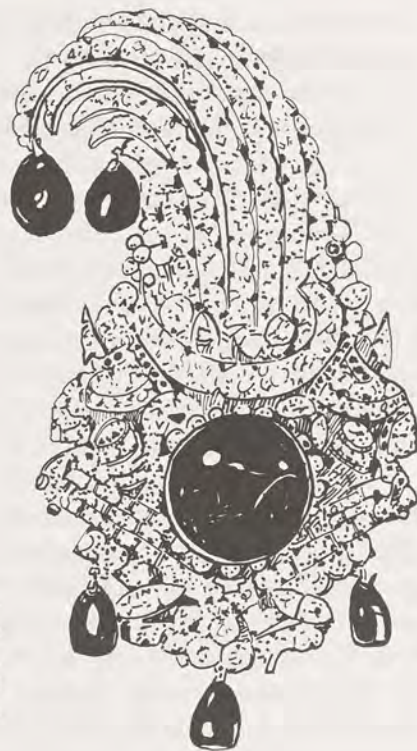

Fig. 4-10 The Nadir Shah jiqua, or turban ornament, preserved in the treasury of the Crown Jewels of Iran, made of precious metals and studded with hundreds of diamonds, some small rubies, magnificent emerald drops, and a central emerald cabochon of about 65 carats. Height is 12.8 cm (5 in).

Empire, the treasure includes splendid, large high-quality emeralds of Colombian origin. The famous dagger, represented in figure 4-11, which was the object of theft in the motion picture, is a curved weapon whose golden handle is set with three extremely large cabochon emeralds of somewhat irregular form. Diamonds stud the spaces between these stones, and the end of the handle is fitted with a jeweled watch capped with a translucent emerald cover. The large emeralds measure about 3 to 4 cm ($1\frac{1}{4}$ to $1\frac{5}{8}$ in) and are of excellent transparency and color, but they contain a considerable number of flaws. This weapon was made as a present from Sultan Mahmud I (1696–1754) of Turkey to Nadir Shah (1688–1747), according to one account,⁴¹ but the official guidebook⁴⁶ states that the dagger, among other gifts, had been sent from Nadir Shah to Turkey, not the other way around.

One of the most impressive objects in the Topkapi Palace Museum is a pendant of gold, studded with diamonds and tasselled with strings of pearls, with the central portion occupied by three dark green cabochon emeralds retaining the original hexagonal crystal form (see figure 4-12). Meen⁴⁷ took optical measurements from a distance and determined these stones to measure about 53 mm ($2\frac{1}{8}$ in) across and the two others, set below that, about 46 mm ($1\frac{13}{16}$ in). This splendid jewel was

Beryl in Art and Ornament

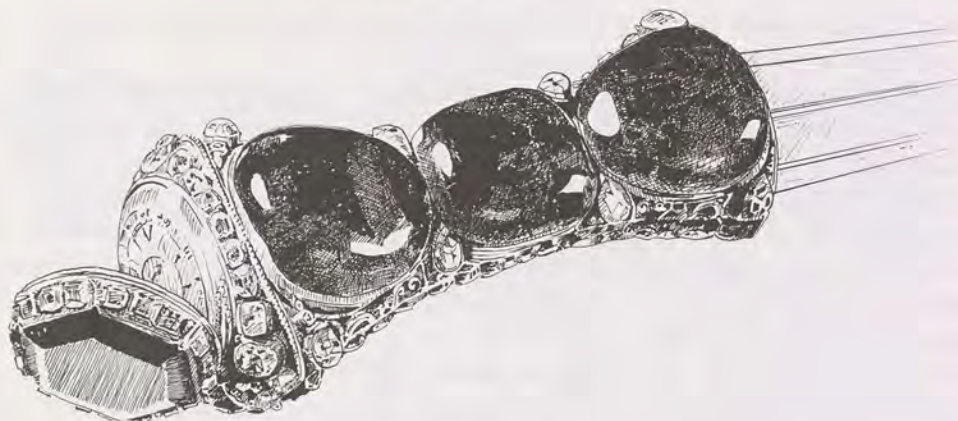

Fig. 4-11 The emerald-studded dagger from the collection in the Topkapi Palace Museum, Istanbul, made famous by the motion picture, *Topkapi*. It is 35 cm (13¾ in) long, and the handle is set with 3-4 cm cabochon emeralds amid diamond ornamentation and gold scroll-work. An interesting feature is the watch set in the butt and covered by a large, very clear hexagonal emerald section. A matching, jeweled scabbard accompanies the blade.

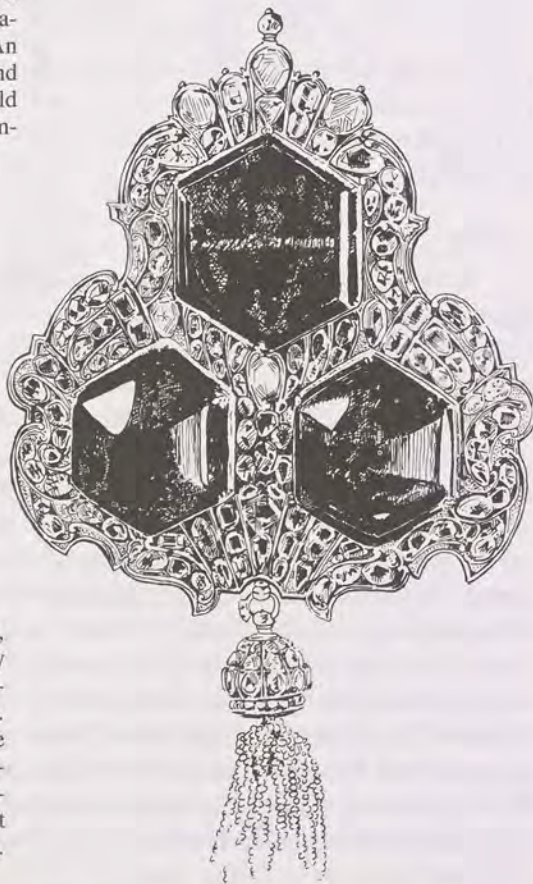

Fig. 4-12 Magnificent emerald, gold, diamond, and pearl pendant, among the jewels formerly belonging to the Sultans of Turkey and on exhibit in the Topkapi Palace Museum, Istanbul. As is apparent from the shapes, the three large emeralds were cut from cross-sections of enormous Colombian emerald prisms. The top emerald shows traces of a borehole suggesting that it may have been half of a much thicker slice. This stone is about 5 cm (2 in) in diameter.

HISTORY AND LORE

sent by Sultan Abdul Hamid I (1725–1789) to the Prophet's Tomb in Medina in the 18th century, but it was later returned to Turkey.

Other Topkapi emeralds include an astonishing "egg-size" single hexagonal crystal, hollowed out and polished all over to form a container, and mounted in jeweled gold as a pendant. It is said to have been sent to Medina by Sultan Ahmed I (1589–1617), but returned to Istanbul by Fahrettin Pasha.⁴⁶ Other large and fine emerald objects are also on display, but one of the most intriguing, especially to the lapidary who looks upon it as potential gem material, is an enormous polished hemisphere of Colombian emerald that is so dark in hue that it appears black. It measures approximately 102×90 mm ($4\frac{1}{16} \times 3\frac{5}{8}$ in) and weighs 6,550 carats! Even larger is a flattish cabochon, also almost black in appearance, which weighs 16,300 carats. Unfortunately, these stones were too far away in poor light to be able to judge more accurately their gem quality.

Among the personal jewels accumulated by Abdul-Hamid II, Sultan of Turkey from 1876–1909, which were sold at auction in Paris in 1911,⁴⁸ are several splendid pieces featuring large emeralds. These include a "grand devant de corsage" or corselet of three rows of large pear-shaped cabochon emeralds suspended from precious metal links studded with diamonds (figure 4-13). The piece contains forty-two emeralds, many of which are nearly 2.5 cm (1 in) in length. Unset emeralds in the collection included a cabochon of 45.29 carats and a "rondelle," pierced in its center, weighing 92.25 carats.

Russia

Remnants of Tsarist treasures are preserved in the armory of the Kremlin in Moscow. Among the pieces is the fur-rimmed conical cap of Vladimir Monomakh, Grand Prince of Kiev during the 12th century. The gold filigree ornamenting the cap is set with gems, among them several large rectangular step-cut emeralds.⁴⁹ The gold bow quiver of Tsar Mikhail, made in the Kremlin Armory in 1628, is studded with over 700 sapphires, rubies, zircons, diamonds, and emeralds, the latter alone numbering 135 and weighing an aggregate 184 carats. Five of the stones weigh 40 carats each, two are 10 carats each, and sixteen together weigh 60 carats.

Fine, dark green emeralds appear as studs on the gold-enamel covers of a gospel, which weighs altogether 26 kilograms (56 lb). In another work of art, dating from the reign of the third Romanov tsar, Feodor Alexeivich (1676–1682), an enormous heart-shaped cabochon emerald forms a mitre directly over the crown of an enameled figure of Christ. Despite their similarity to typical Colombian emeralds, Duncan⁴⁹ (p. 116) maintained that "these stones probably came from the emerald mines in the Ural Mountains which had been worked since the earliest recorded Russian times" (!) and "it is most unlikely that any of these gems came from the great Muzo mines of Colombia." He advances no evidence for these statements, however.

Beryl in Art and Ornament



Fig. 4-13 *Devant de corsage*, or breast ornament, made of cabochon and drop emeralds with diamonds, approximately 28 cm (11 in) across. Once the property of Abdul-Hamid II, Sultan of Turkey, it was sold in Paris in 1911 after his exile.

In 1980, a splendid faceted emerald set in a diamond-studded brooch, shown in figure 4-14, was purchased by J. and S. S. De Young, jewelers, of Boston. The piece had been given by Catherine the Great as a wedding gift to a member of the Prussian Hohenzollern family, thence it passed through a number of noble owners until it was purchased by the Boston firm. The weight of the stone is between 70 and 80 carats.

Among modern emeralds in the U.S.S.R. Diamond Fund in Moscow, pride of place is taken by a magnificent rectangular step-cut Colombian emerald, 36×32.5 mm ($1\frac{7}{16} \times 1\frac{5}{16}$ in) in size, weighing 136.5 carats (figure 4-14). It has surprisingly few flaws and is mounted in a pierced gold and silver frame decorated with diamonds. The work is attributed to the second quarter of the 19th century.²⁵ Fersman,⁵⁰ however, gave the weight as 135.25 carats, noting at the same time that

HISTORY AND LORE

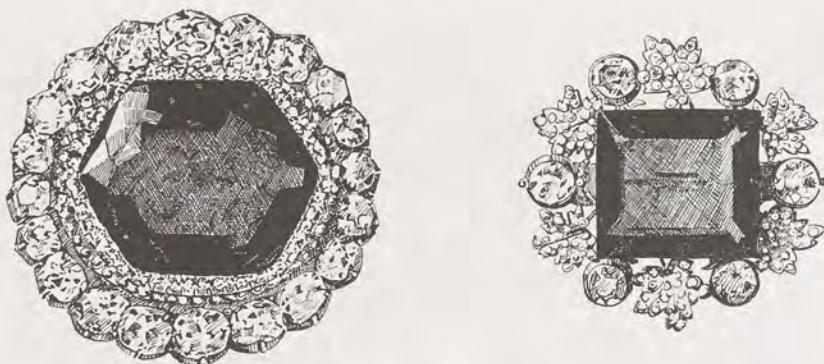

Fig. 4-14 *Left*: Catherine the Great's emerald, weighing between 70 and 80 carats, surrounded with rows of rose-cut and brilliant-cut diamonds (outer row). It is owned by J. & S. S. De Young, Inc., jewelers of Boston, Massachusetts. (Sketched after an advertising photograph.) *Right*: Step-cut emerald of superb color and clarity set in a gold-silver mounting with large round diamonds and numerous small diamonds studding the leaves. The gem measures 3.6×3.25 cm (ca. $1\frac{1}{2} \times 1\frac{1}{16}$ in) and weighs 136.5 carats. It is a former Tsarist treasure and is now in the Diamond Fund of the U.S.S.R.

the gem is fine quality but "rubbed," and that it was mounted during the reign of Tsar Nicholas I in about 1830.

Other outstanding emeralds mentioned by Fersman include a great cracked Uralian stone of about 245 carats; Colombian cabochons of 153.75, 65, 28.80 carats; and step-cut gems of high quality of 42.035, 41.50, and 40 carats, the last bearing an inscription in Persian characters. Referring to an early catalog of Russian crown jewels, Lord Twining⁵¹ mentioned a drop emerald of 110 carats, a sévigné set with three emeralds of 140, 174.10, and 21.90 carats, and an aquamarine of 231.65 carats set in a medallion.

No discussion of Russian jewelry can omit mentioning the use of beryl gems by the great court jeweler Carl Gustavovich Fabergé (1846–1920), who is noted both for his imaginative designs and his faultless workmanship. One of his best-known pieces is a small, beautifully detailed miniature of the famous equestrian statue of Peter the Great in Nevsky Prospekt, Leningrad. It measures only 50 mm (2 in) across, and has a base made from an emerald.⁵² The "Swan Egg," one of his masterpieces, presented to Alexandra Feodorovna by Nicholas II in 1906, contains a large section of pale aquamarine forming the "lake" on which floats a platinum swan whose wings, tail, and feet move when a concealed motor is wound. The whole fits into the egg and is the "surprise" for which Fabergé's eggs were noted.⁵³ One of the prizes of the Fabergé collection of Lillian Thomas Pratt, housed in the Virginia Museum in Richmond, is a rock crystal egg enclosing miniature

Beryl in Art and Ornament

paintings of the Tsarist residences. These are hinged to a central shaft which is rotated by means of a large, fine Uralian emerald at its apex.⁵⁴

Austria

The Holy Roman Empire crown jewels, which are on exhibit in the Weltliche Schatzkammer, or secular treasury, in the Hofburg, Vienna, include the elaborate gem-studded crown of István Bocskay (1557–1606), who received the crown from Sultan Achmed I.⁵¹ A number of emeralds are used in its decoration but are not identified as to source.

In the collections of the Kunsthistorisches Museum in Vienna is a fine altar-piece, shown in figure 4-15, in which part of the religious scene depicted is "Jacob's Well," made from a large emerald crystal. Another fascinating object is a 492-carat oval faceted aquamarine mounted in a swivel-stand (figure 4-16).

The most important royal jewels belonged to the Austrian Hapsburgs. Considered personal rather than state treasures, they were removed by Emperor Charles I (Karl Franz Josef, 1887–1922) when he abdicated in 1918. These are listed and described by Twining⁵¹ (p. 14–16), and include a suite of emerald jewelry, known as the Maria Theresa emeralds, which had formed a large corsage made for Empress Maria Theresa (1717–1780) and which was later worn by Empress Marie Louisa, wife of Leopold I. During the 19th century, the corsage was dismantled and the emeralds reset in a diadem, corsage, necklace, two bracelets, two slides, and a watch with chatelaine, the watch being set within an oval case made from a single emerald crystal.

Ball³⁶ stated that in about 1875 an emerald weighing 2,005 carats was among the crown jewels and valued at \$58,000. The fate of this stone is unknown and Twining does not mention it.

Germany

Two treasuries in Germany contain remarkable collections of jewels and precious objects once owned by royal families. The largest and most important collection is in the Grüne Gewölbe or "Green Vaults" of Dresden in the German Democratic Republic. The collection commenced with Augustus the Strong (1670–1733), the ruler of Saxony, who, as a connoisseur and ardent collector, lost few chances to acquire or commission marvelous examples of lapidary and goldsmith art. Emeralds are prominent in many of the objects. One of particular interest, recently sent to the United States for exhibit, is a statue of a black boy holding a tray on which rests a large stone studded with natural Colombian emerald crystals of large size. Far more emeralds in cut form may be seen in the "Emerald Suite," on display in the eighth of the treasury rooms, in which cut emeralds are inset in pendants, buckles, drops, studs, a cane top, and two swords. This collection is



Fig. 4-15 A remarkable house altarpiece or shrine ascribed to the Florentine court workshops and made for the Grand Duke of Tuscany, Ferdinand I (1549–1605). Its size is 38 × 23 cm (15 × 9 in). The frame consists of rock crystal, gold, and enamel and surrounds a pietre dure (stone mosaic or inlay) scene in the Holy Land with Christ and a samaritan before Jacob's Well, the latter made from a single large emerald crystal. *Courtesy Kunsthistorisches Museum, Vienna.*

Beryl in Art and Ornament



Fig. 4-16 Oval faceted aquamarine of 492 carats exhibited in the Weltliche Schatzkammer in Vienna. It weighs 492 carats and is mounted in a swiveling gold setting; provenance unknown, possibly Russian, dated to about 1600. The stone is not flawless but contains inconspicuous liquid-filled feather inclusions, some minute tubular inclusions, and faint color zones. *Courtesy Kunsthistorisches Museum, Vienna.*

described in Menzhausen's detailed historical work,⁵⁵ notable for its many illustrations.

The second great collection, in the Treasury of the Residenz in Munich, represents the precious objects assembled by members of the ruling Wittelsbach family of Bavaria. Its most important pieces are described and illustrated in Twining⁵¹ and in the detailed catalog of Thoma and Brunner.⁵⁶ Easily the most splendid object, perhaps one of the greatest examples of the goldsmith's art ever created, is the statuette of St. George and the Dragon, made in about 1590 from gold, silver gilt, and gemstones. The horse's body is beautifully carved from a single piece of agate, equipped with trappings of enameled and gem-set gold. St. George, made of gem-studded and enameled gold, sits astride the horse holding a sword of rock crystal aimed at the dragon at the horse's feet. The dragon is green enamel and studded with many fine emeralds. This remarkable statuette is mounted on an elaborately

HISTORY AND LORE

decorated plinth and the whole is 50 cm (20 in) tall, 34.2 cm (13½ in) long and 19.8 cm (8 in) wide. In the same room is a splendid example of 16th century jewelry, a ceremonial necklace made of enameled gold links set with gems, among which are a number of large and fine green stones. These stones, faithful imitations in green glass, were substituted for the original emeralds some time after 1931, according to museum officials. They are identified as emeralds by Twining⁵¹ but Thoma and Brunner⁵⁶ correctly identify them as copies.

Another large emerald in this collection is part of a rosary made from gold and diamonds. The emerald measures about 3 × 4 cm (1¼ × 1½ in) and has facets over its entire upper surface. A matching piece on the other side is green glass. Emeralds are also set in the hilt of the Bavarian Imperial sword, in the garniture of the Order of St. George, and in other objects. The collection formerly contained a number of fine and large unset emeralds, according to a catalog of 1879⁵¹ (p. 38), including gems of 80, 70, 52, and 27¹³/₁₆ carats, and an uncut emerald of 120 carats which was acquired in 1565 and was thus one of the first Colombian emeralds to pass into hands other than Spanish. In 1931, on behalf of the Treasury, Christie's of London auctioned off nine emeralds from the collection totaling 476 carats and fetching the round sum of £19,000. None of these gems were less than 28 carats; the largest, hexagonal in outline, of "magnificent" quality and weighing 98.98 carats, sold for £3,000.⁵¹ Were these the emeralds taken from the ceremonial necklace mentioned above?

Among other German royal treasures, Twining mentions the German Imperial Crown, fitted with a large, fine emerald in one of its side panels, an aquamarine said to have been in the clasp of Napoleon's coronation mantle, and other large emeralds set in jewels and ornaments in the treasures of the Prussian royal house.

Italy

The largest and most important emeralds in Italian collections are those in the Vatican Museum which have been used to ornament papal tiaras, although a pair of very early crowns made for King Agilulf (ca. 600 A.D.) and his Queen, Theodolinda of Lombardy, employed emeralds among other stones in their decoration⁵¹ (p. 417). The earliest emerald-ornamented tiara was that of Pope Boniface VIII (papacy, 1294–1303) which contained forty-three balas rubies, seventy-two sapphires, and forty-five *praxini* (emeralds). Much later, the tiara of Pope Julius II (papacy, 1503–1513) was decorated with the largest recorded emerald ever used in these headpieces, a hemispherical stone engraved with the legend "Gregorius XIII Pont. Opt. Max." It was attached to the apex of the tiara, to which was added a gold cross. This gem is shown in a watercolor sketch in Twining⁵¹ (p. 380) as being carved in fluted style, but in another photograph (plate 114), which shows the gem on top of the tiara of Pius VI, it is seen to be almost spherical in shape and smoothly

Beryl in Art and Ornament

polished. Some accounts²² give the dimensions as 5.5 cm (2¼ in) in diameter and 3 cm (1¼ in) in height. However, it is obvious from Twining's illustration that it cannot be more than about 25 mm (1 in) in diameter. Twining also said that the stone was Egyptian in origin, of fine dark green color, and that the engraving was done in 1503. If the last date is correct, the stone could not have been Colombian, and it may be one of the very few large and fine emeralds from Egypt.

This particular emerald has a most interesting history. It was among the treasures taken from the Vatican to meet the enormous sum demanded by Napoleon under the terms of the Treaty of Tolentino in 1797. All major papal tiaras had to be dismantled and the stones removed, and the large emerald passed into the hands of the French. In 1804, when Pius VI agreed to travel to Paris to anoint Napoleon, the Vatican treasury was so depleted that no fitting tiara could be made from what was left. Informed of this regrettable state of affairs, "Napoleon made good the omission by ordering a new one which he gave to the Pope as a present," and which included the large emerald.⁵¹ A detailed contemporary description of the tiara gave the weight of the emerald as about 1,000 carats. The tiara is still in the Papal Treasury and retains the large emerald, although many other stones have been removed and replaced over the years.

France

The collection in the Louvre in Paris contains an example of early use of emeralds in a gold pectoral, suspended from a chain, which is set with a large black stone scarab ornamented with pearls and emeralds. It is dated to the 3rd or 4th century A.D. and is remarkable for the fact that the chain employs short beads of emerald, almost rondelles in shape, that were obviously cut from basal sections of Egyptian crystals.⁵⁷ Twining⁵¹ mentioned that emeralds were commonly used in early French royal jewels. At the time of her death in 1372, Queen Jeanne d'Evreux owned many jewels, the best having been given to the Convent of Grands Carmes, Paris, in 1349. Among other objects, she left a crown set with emeralds and a "coronel" largely decorated with these stones.

In 1811, Napoleon presented to his second wife, Marie-Louise of Austria (1791-1847), a magnificent emerald and diamond tiara when she bore him a son. The tiara outlasted his reign and remained in the hands of the Hapsburgs until it was sold by Van Cleef & Arpels of New York. At this time it was broken up and the large and fine emeralds placed in modern settings. The entire suite, originally containing 79 emeralds and 1,015 diamonds, was valued at \$1 million.

In 1887, the major portion of the French Royal Crown jewels were dispersed through auction in Paris, at which time several pieces rich in emerald gems were sold.⁵⁸ The finest of the lot was a diadem studded with 1,031 diamond brilliants weighing altogether 176 carats and 40 large and small emeralds totaling 77 carats

HISTORY AND LORE

in weight. This piece was the favorite jewel of Empress Eugenie (1826–1920), wife of Napoleon III, and was bought by a certain Mr. Bachrach at the auction for 49,500 francs.

A most remarkable lapidary object, now in the Louvre in Paris, is a jeweled map of France presented by Tsar Nicholas II to President Loubet as a token of goodwill to the French people. About 1 meter (3 ft) square, it is a mosaic composed entirely of Russian gem and ornamental stones representing political divisions and cities. An emerald valued at 900 rubles was used to designate the city of Marseilles. This map was exhibited in the Russian section of the Art Industry Building at the Paris Exposition of 1900.⁵⁹

Spain

In regard to Spanish royal treasures, Twining (p. 579) stated that "strictly speaking there are no Spanish crown jewels," almost everything in the way of personal ornamentation being considered private rather than public property. In only one place does Twining mention a significant object in which emeralds were used, that being the Emerald Crown of Blanche of Anjou, wife of King James II, who reigned in the late 13th and early 14th centuries. Of course, the emeralds were not Colombian. Considering that the Spanish were the ones to discover and exploit the enormously rich emerald deposits of Colombia and that they controlled both production and distribution of the stones, the paucity of emeralds among the treasures of Spain is perplexing. A necklace of twenty-five large emeralds was said to have been presented to the King of Spain as a gift from the administrators of the Muzo mines, and other important emerald gifts were made later.³⁶ Apparently all of these were sold or otherwise disposed of, because no trace of them exists. As mentioned before, the royal houses of Spain seemed uninterested in amassing jewels, even though opportunities to do so must have been abundant.

The most important precious object in Spain in which emerald figured prominently was the elaborate jeweled gold crown made for the statue of the Virgen del Sagrario in the Cathedral of Toledo, the work of a jeweler of that city, one Don Diego Alejo de Montoya. He is said to have begun his task in 1574 and completed the crown twelve years later. Miro's illustration⁶⁰ (p. 135) shows that it is studded with several large gems, the largest and most important being a spherical emerald of 40 mm (1 $\frac{5}{8}$ in) diameter placed on top (figure 4-17). According to Miro, the emerald was "prime color, limpid and brilliant." The crown was stolen from the cathedral in 1869 and never recovered. Kunz⁶¹ suggested that even before that date the emerald ball had been substituted by one made of green glass. Kunz relates the story that in 1809 during the French occupation, Marshal Andoche Junot, when shown the crown by church officials, tore the emerald from its setting and remarked



Fig. 4-17 The gold crown used on ceremonial occasions to adorn the image of the Virgen del Sagrario and preserved in the cathedral of Toledo, Spain. The large, spherical emerald at the apex measures 40 mm (1½ in) in diameter and is of "prime color, limpid and brilliant." Height of crown 27 cm (10¾ in), diameter 22 cm (8¾ in). From an engraving in J. I. Miro's *Estudio de las Piedras Preciosas* (Madrid, 1870).

HISTORY AND LORE

to the horrified bystanders that "this belongs to me!" Presumably Junot had the ball recut into smaller stones because it was never seen again.

Portugal

Among the modest crown jewels still preserved in Lisbon, only a corsage ornament, in the shape of ribbons tied in a bow, contains significant emeralds. It is described⁵¹ as being "set with 28 emeralds of 301.44 carats including one stone of 47.81 carats in the centre; and brilliants weighing 195.72 carats, the largest being 23.89 carats." This jewel was the property of Queen Maria Anna of Austria, consort of John V (1689–1750), and was fabricated in the first half of the 18th century.

England

Emeralds are not conspicuous among the gems employed in the Crown Jewels of England; in fact, compared with the exceptionally large and fine diamonds, they pale into insignificance. However, the Imperial Crown of India, made in 1911 at a cost of £60,000, contains nine emeralds of the highest quality, including a very fine cabochon of 36 carats mounted in the front of the headband. Another very fine, but considerably smaller emerald is set in the center of the diamond-studded cross at the top.⁵¹ The king's scepter and orb, made for Charles II in the 17th century, are adorned with emeralds, and a very fine emerald of considerable value is set in the scabbard of the state sword.

Among the coronation jewels, many large, important emeralds may be noted, the most remarkable, or at least the most curious, being a girdle of cloth around which are fastened elaborately carved gold panels, studded with diamonds, pearls, and emeralds. Each of the panels contains nineteen very large flat emeralds, four of which are carved. Twining's illustration (p. 186) shows that most stones were cut from hexagonal cross-sections, almost certainly from large Colombian crystals. These stones "were originally set in the trappings of a horse belonging to Maharajah Ranjit Singh and were remounted as a girdle by his successor, Maharajah Shere Singh." The girdle was acquired in India by the East India Company and given to Queen Victoria in 1851; it is presently displayed in the Indian Room of Buckingham Palace.

Among the personal jewels of Queen Elizabeth II, large and important emeralds are abundantly represented. A splendid tiara, consisting of interlocked loops of precious metal studded with diamonds, is one of the most impressive pieces (figure 4-18). The center opening in each of the fifteen loops is occupied by a dangling pear-shaped emerald cabochon, each about 25 mm (1 in) in length. These can be removed and drop-shaped pearls substituted.⁶² Another splendid piece is a necklace containing nine cabochons of fine dark color. It is specially remarkable for a large pendant cabochon of emerald, alongside which is placed a marquise diamond, the

Beryl in Art and Ornament



Fig. 4-18 The beautiful emerald and diamond tiara of Queen Elizabeth II, consisting of fifteen interlinked circles in which are suspended magnificent emerald drops, graduated in size and interchangeable with an equivalent set of graduated pearl drops. *Crown copyright reserved.*

sixth gem cut from the Cullinan. Queen Mary liked to wear a set of jewels in which emeralds were a prominent feature, including the necklace just described, and a large stomacher set with emeralds even larger than those in the necklace. This latter piece contains the fifth gem cut from the Cullinan. With this set was commonly worn a brooch of two rows of diamonds encircling an enormous dark-colored emerald of hexagonal outline.⁶²

Though less precious, an equally remarkable piece of jewelry belonging to the queen is an elaborate necklace featuring nine graduated step-cut blue aquamarines of exceptional color (figure 4-19). These were presented to the queen by the president and people of Brazil. They are matched in a tiara and a pair of earrings, also set with aquamarines of similar quality. According to Young,⁶² the stones for the necklace "had taken the Brazilians a whole year to collect, for stocks of the gems were low and a fine match was deemed necessary." Furthermore, "the Queen was so delighted with it that she had made a small tiara of aquamarines and diamonds which she wore with it." In 1958, the people of Brazil supplemented this gift with

HISTORY AND LORE

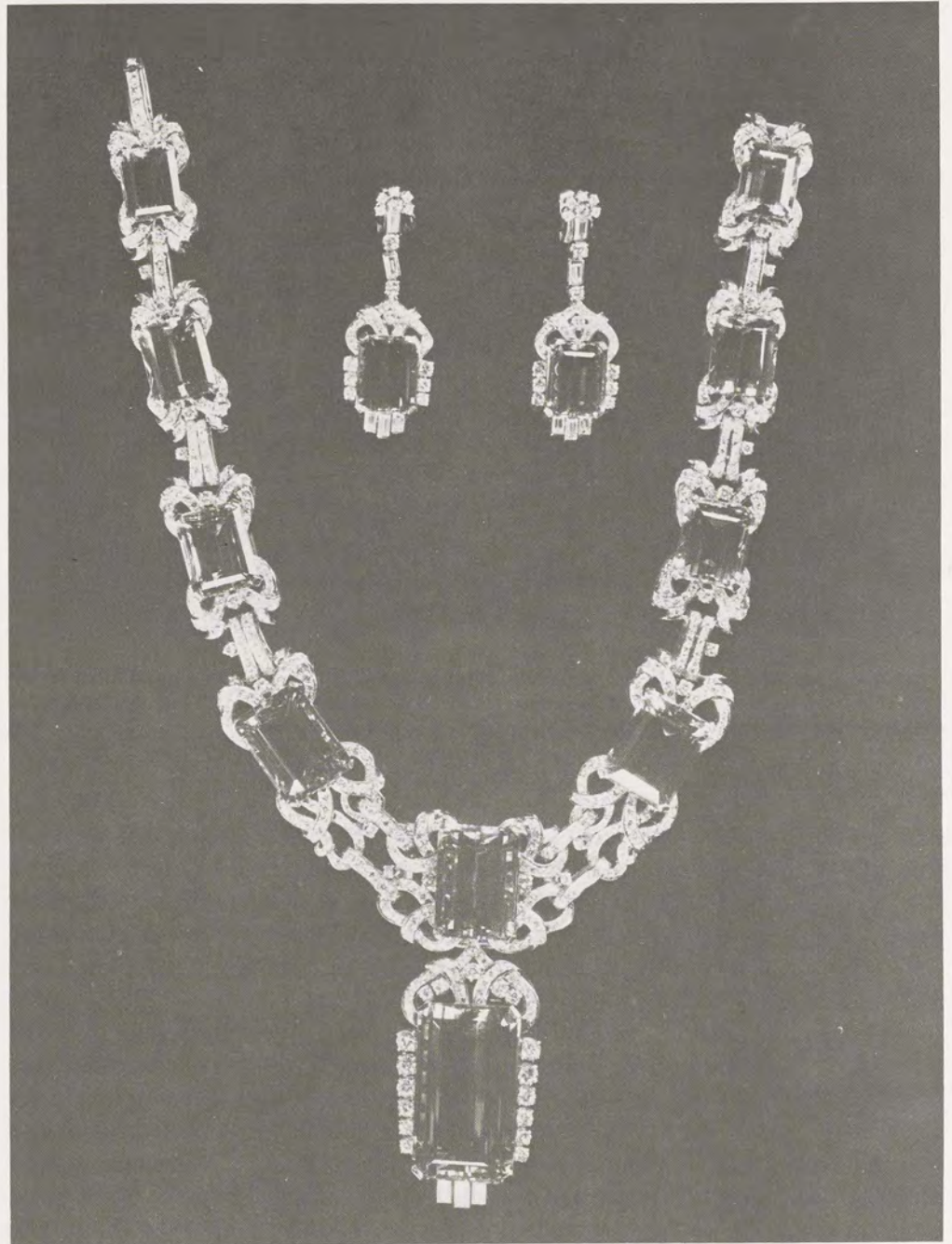

Fig. 4-19 The Brazilian aquamarine necklace and earrings presented to Queen Elizabeth II by the President and people of Brazil. *Crown copyright reserved.*

Beryl in Art and Ornament

a bracelet set with seven aquamarines among hundreds of small diamonds clustered into crowns.

The British Museum (Natural History) in London contains the finest and largest pink Madagascar faceted morganite gem known. It is brilliant-cut, in the style known as "antique," and weighs 598.7 carats (see color figure 12). Another splendid beryl gem is an oval step-cut aquamarine from Russia, sea-green in color and flawless, weighing 879.5 carats.⁶³ Next door, in the Geological Museum, an exceptional collection of cut and rough gems features an unusual chatoyant aquamarine cabochon weighing 114 carats and a remarkable brown step-cut beryl weighing 9.08 carats.⁶⁴

The Victoria and Albert Museum also contains remarkable beryl gems, especially those in the Townshend Collection, which were left to the museum under the terms of Townshend's will.⁸ Several examples are shown in the line drawings of figure 4-20. These were formerly in the Henry Philip Hope Collection, best known

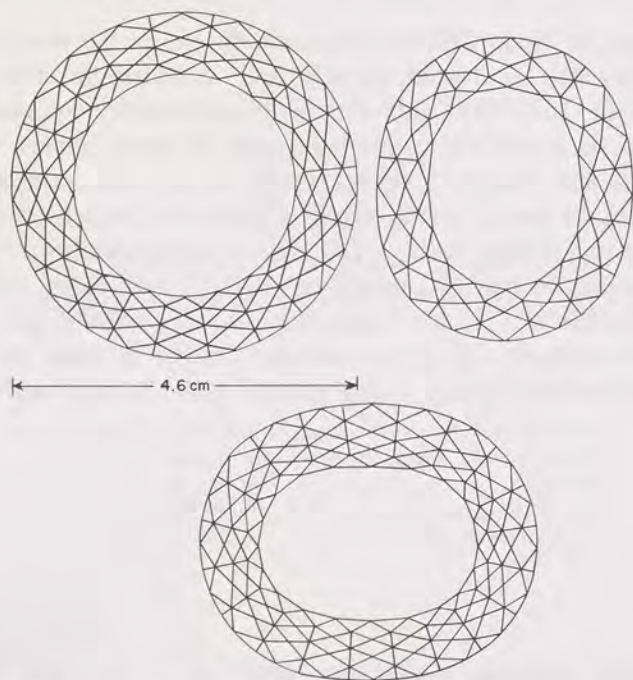

Fig. 4-20 Three very large faceted gems cut from aquamarine, part of the Townshend Collection in the Victoria and Albert Museum, London. The round stone, the largest, weighs about 331 carats and is sea-green in color. To its right is another weighing about 197 carats of a yellow-green color, while the bottom stone is fine sea-green and weighs about 293 carats.

HISTORY AND LORE

for having once contained the celebrated Hope diamond, now housed in the National Museum of Natural History in Washington, D.C. The Hope specimens have been catalogued by Hertz.⁷ Hertz described the large round brilliant gem shown in figure 4-20 as “extraordinarily fine . . . beautiful sea-green colour, with a slight admixture of yellow, though, nevertheless, of a pure and decided tint; this beautiful gem is of the highest effulgence, and of the greatest perfection.” However, the largest Hope aquamarine is not owned by the museum and I have been unable to discover its whereabouts. According to Hertz, it weighed 5 ounces, 17 pennyweights, 12 grains (about 645 carats) and was cut in oval brilliant style. No sources for the roughs for these gems are given, but presumably they are Russian in origin.

One of the more remarkable gems in the Townshend Collection is the “fixed star” emerald cabochon shown in figure 4-21. Unlike normal stars, such as those observed in star sapphires, which are caused by reflections from numerous bundles of parallel fibers and which appear to move as the gem is tilted, the dark-colored symmetrically arranged inclusions in the Townshend gem neither reflect much light nor move.

Also among the Hope Collection was surely one of the most remarkable examples of lapidary art ever created, namely the “sword handle” that once belonged to Joachim Marat (1767?–1815), the famous French cavalry commander who married Napoleon’s sister and ultimately was made King of Naples. He earned the additional title of the “Dandy King” for his love of ostentation and for his foppishness in dress, the sword handle being an instance in which ornamentation was deemed more important than utility. This object was described in Hertz’s catalog⁷ as “a matchless aquamarine . . . cut all around with long facets which cross each other obliquely; it is of the most beautiful sea-green colour, and of the utmost perfection.” (See figure 4-22.) The mounting for it was made from “fine gold, ornamented with brilliants, turquois and garnets, and a most beautiful carbuncle on



Fig. 4-21 Remarkable “fixed star” emerald in the Townshend Collection, formerly part of the Hope Collection, in Victoria and Albert Museum, London. The dark bands are formed of inclusions arranged symmetrically around the *c*-axis. Diameter about 12.5 mm (½ in). *Courtesy Victoria and Albert Museum.*

Beryl in Art and Ornament

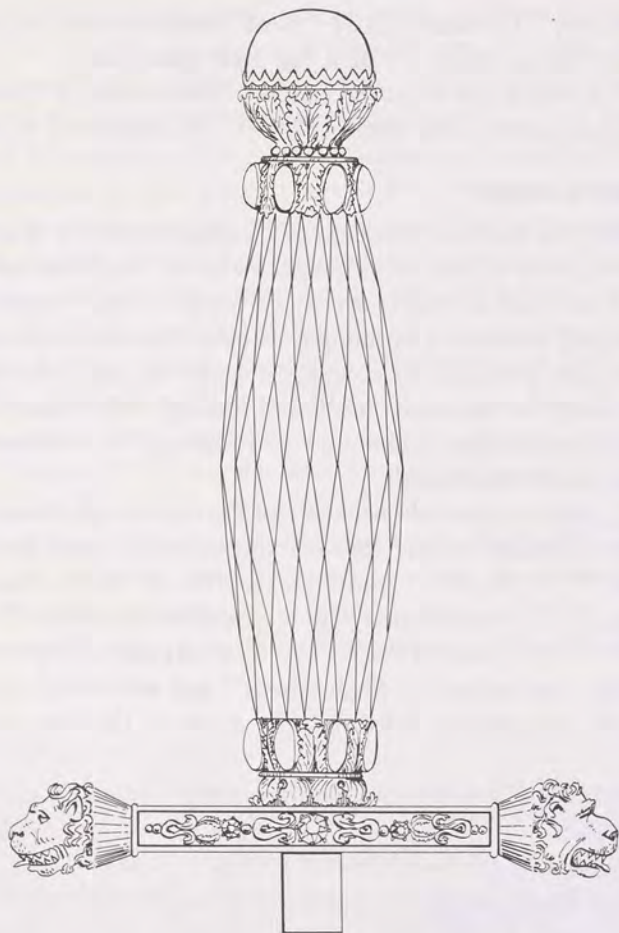

Fig. 4-22 A masterpiece of the lapidary's art, a magnificent faceted aquamarine, about 10 cm (4 in) long, formerly owned by Marat and later set into a jeweled sword handle by Henry Philip Hope. After plate 15 in B. Herz, *A Catalogue of the Collection . . . Formed by Henry Philip Hope* (London, 1839).

top; it is four inches long." The weight was given as 3 ounces, 6 pennyweights (approximately 422 carats). This gem has not been recorded since it was sold out of the Hope Collection.

The Hope Collection also contained a fine square cushion-cut brilliant emerald, measuring approximately 31 mm (1¼ in) across. Hertz gives the weight as 532³/₁₆

HISTORY AND LORE

grains (approximately 172 carats). It is "most extraordinarily large and beautiful . . . from the East Indies [*sic*] . . . of a fine light green tint . . . it has two flaws in the interior, but which are scarcely visible." Hertz says it "formerly adorned the turban of Tippoo Saiib [Tipu Sahib (1751–1799), Sultan of Mysore]."

United States and Canada

On the whole, the National Museum of Natural History in Washington, D.C., holds the best collection of cut beryl gems, many of which are on display in the Hall of Gems. Fine emerald gems are to be found in the "Spanish Inquisition necklace," so named because it is thought to have been made during that period. In addition to its fine emeralds, it contains a series of large, stubby briolettes of diamond which, with the emeralds, are bored through with suspension holes! The largest emerald in the necklace is about 24×15 mm ($1 \times \frac{5}{8}$ in) and weighs about 60 carats^{66,67} (see color illustration).

A splendidly barbaric emerald necklace of Persian design, donated by Marjorie Merriweather Post, features twenty-four baroque stones of good quality, the largest measuring about $23 \times 20 \times 15$ mm ($1\frac{5}{16} \times 1\frac{3}{16} \times \frac{5}{8}$ in). Another Post gift, also antique Persian, is a brooch fitted with large carved emeralds. The major central stone is $33 \times 31 \times 14.5$ mm ($1\frac{5}{16} \times 1\frac{1}{4} \times \frac{5}{8}$ in) and is engraved on one side with script stating "the servant of Shah Abbas" and with floral decoration on the other. This gem is exhibited at Hillwood, the estate of the Post family, in Washington, D.C.

An anonymous donation to the museum, a superb step-cut Colombian emerald, measures $22.2 \times 19.4 \times 11.8$ mm ($\frac{7}{8} \times \frac{3}{4} \times \frac{1}{2}$ in) and weighs 37.82 carats (it originally weighed 38.38 carats before recutting to its present form). Set in a ring, and described by Desautels⁶⁶ as being possibly "the finest single large emerald in America," it is said to have been owned by the rulers of Baroda in India for several centuries. The "Maximilian emerald," a step-cut gem of 21.04 carats, also donated by Post, was reputedly worn by Ferdinand Maximilian Joseph, the first and only emperor of Mexico (1864–67). Another Post gem is a fine, clear emerald weighing approximately 31 carats. Another notable gem, donated by Mrs. Stewart Hooker, was once set in a belt buckle that belonged to Abdul-Hamid II (1842–1918), the last Sultan of Turkey.⁶⁸ It is a remarkably clear, square, step-cut of 75 carats (see color figure 20).

Other museum holdings include a very large emerald of 157.5 carats, cut in oval brilliant style, and an oval cabochon of Colombian emerald weighing 117 carats. A recent addition to the collection is the 858-carat Gachalá emerald, named after its source in Colombia, donated by the late Harry Winston, and consisting of single, terminated stubby prism with glassy faces.⁶⁵

Besides the emeralds, the Natural History Museum collection includes many

Beryl in Art and Ornament

fine and large gems of aquamarine, golden beryl, and morganite, among other varieties.^{66,69,70} The largest aquamarine, a step-cut gem of "more green than blue" color, cut in scissors style, weighs 1,000 carats. There are also a pale blue Russian aquamarine of 263.5 carats, a 187-carat fine blue step-cut gem of Brazilian material, a pale blue gem from Maine of 66.3 carats (Isaac Lea Collection), and a beautiful, clean blue aquamarine of 911 carats from Brazil. The rare aquamarines of Idaho are represented by a pale cut gem, very clean, weighing 108 carats.

The best morganite, from Brazil, is rich pink in color and weighs 235.5 carats, while two others, cut from morganite rough from the White Queen mine in San Diego County, California, weigh 122.2 and 113 carats. Among the largest of all beryl gems is the flawless golden, somewhat greenish-tinged step-cut gem of 2,054 carats, cut by the author (see figure 4-23 and color figure 15). It is believed to be the largest cut golden beryl in existence. Another unusual golden beryl in the collection, a cat's-eye of 43.5 carats, was also cut by the author from Madagascar rough.

In New York, the gem hall in the American Museum of Natural History contains large and important beryl specimens, among them the famous Patrizius, Patrice, or St. Patrick's emerald crystal from Chivor, Colombia, a sketch of which is shown in figure 4-24, and a dark green Russian crystal of 2,800 carats. A fragment

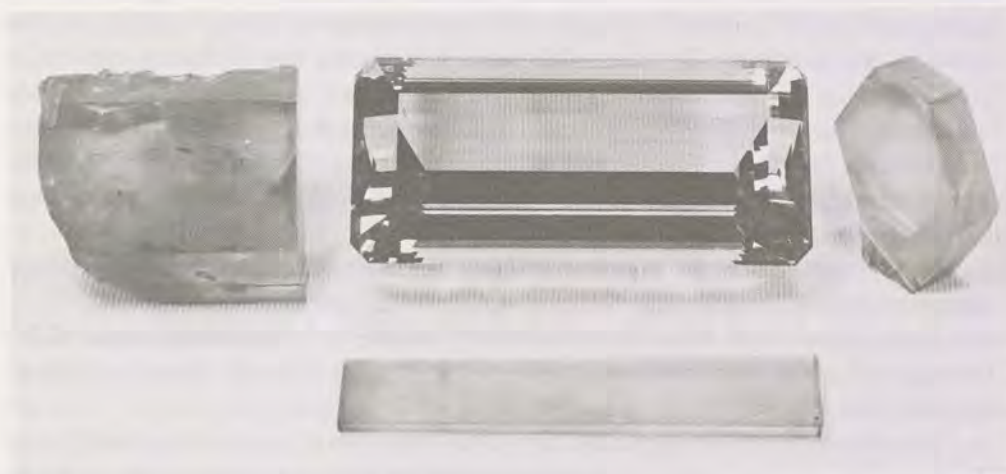

Fig. 4-23 An enormous golden beryl cut gem from Brazil. Weighing 2,054 carats and measuring 10.5 cm ($4\frac{1}{8}$ in) in length, it is believed to be the largest cut golden beryl in existence. It was cut by the author from a simple prism of beryl, the base of which appears on the left and the termination at the right. The thin slab in the foreground was cut from one of the prism faces to eliminate inclusions. The gem, now in the collection of the National Museum of Natural History, Washington D.C., is flawless. *Courtesy Smithsonian Institution.*

HISTORY AND LORE

Fig. 4-24 The "Patrizius" emerald crystal, found at Chivor in 1921 by Fritz Klein and named by him after St. Patrick, patron saint of Ireland. It is 8 cm (3¼ in) tall, about 5.5 cm (2¼ in) in diameter, and weighs 630 carats. The crystal is terminated by a large face of $c\{0001\}$ and bounded on the sides by almost equally developed faces of first order prism $m\{10\bar{1}0\}$ and second order prism $a\{11\bar{2}0\}$. After a color plate in Klein's *Smaragde unter dem Urwald* (Berlin: Oswald Arnold, 1941).



of a dark blue aquamarine crystal, weighing 6 kg (13 lb) is also on exhibit and an object of continual envy on the part of lapidaries. Among cut aquamarines are a fine blue step-cut of 144.51 carats, another of 400 carats, and a greenish-blue faceted oval of 737 carats.⁴⁴ Several pale aquamarines of Russian origin are also included, one weighing 271 carats. Morganites include a fine Brazilian step-cut of 235 carats, but it is overshadowed in terms of color by a superb step-cut gem from Madagascar material that weighs 123.58 carats. In a daring robbery in October 1964, thieves broke into the old mineral room and removed the 737-carat and 400-carat aquamarines as well as several carved Indian emeralds, but the gems were later recovered.⁷¹

In Chicago, the Field Museum of Natural History contains the largest aquamarine so far cut from United States material, a 137-carat square brilliant of pale blue color, from rough found near Stoneham, Maine; it is sketched in figure 4-25. There is also a fine Siberian aquamarine gem, said to be from the Hope Collection, weighing 341 carats.⁷²

Elsewhere, excellent cut beryls are in the collection of the Los Angeles County Museum. On April 5, 1979, the *San Diego Union* carried a story and photographs of an enormous greenish aquamarine step-cut gem that was prepared from a 6,021-carat Brazilian aquamarine crystal by Pala Properties International of Fallbrook, California. The finished gem, claimed to be the largest cut aquamarine in existence, weighs 2,594 carats and is valued at \$120,000.

In Canada, the Royal Ontario Museum in Toronto contains fine beryl gems,

Beryl in Art and Ornament

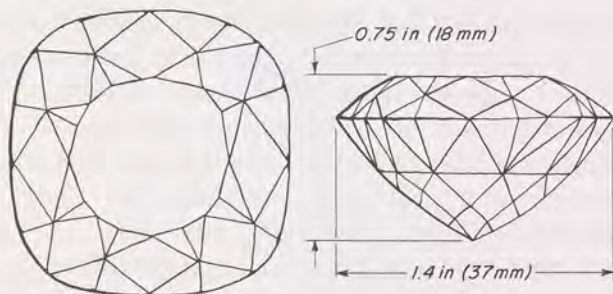

Fig. 4-25 Sketch of a 137-carat pale blue aquamarine of fine quality cut from a crystal found near Stoneham, Maine, and now in the Gem Hall, Field Museum of Natural History, Chicago. After a sketch by G. F. Kunz.

but the largest and perhaps most interesting is a scissors-cut stone weighing 1,625 carats.⁷³ When cut, it was a superb orange color. Unfortunately, the color of the morganites from this particular deposit in Brazil fades, and in time the hue changes to a stable pink color.

Miscellaneous American Beryls

The largest cut emerald from a North American deposit is a fine-colored, step-cut gem of 13.14 carats prepared from North Carolina material, which, according to Crowningshield,⁷⁴ is indistinguishable from similar colored bright Muzo emeralds valued at \$1,500 to \$2,000 per carat. The gem was sold in 1971 for an undisclosed amount to R. Santangelo, an investment banker of New York City, and valued by Henry B. Platt, Vice President of Tiffany & Company at \$100,000.

In recent decades, several fine emerald necklaces have reappeared, such as the one shown in the December 29, 1953, issue of *Life* magazine and owned at the time by Van Cleef & Arpels of New York. According to the story, it once belonged to a Polish countess who was in love with Andrzej Bonwentura Kosciuszko, the Polish patriot who went to America in 1776 to serve in the Revolutionary Army. To aid the cause, the countess gave the necklace to Benjamin Franklin while he was envoy in Paris. Franklin stored the necklace in a bank, but it disappeared during the French Revolution and was not seen again until 1850 when it was offered for sale in a pawnshop. Another historical emerald necklace, recently in the hands of Cartier's of New York, was depicted by Baerwald and Mahoney.¹⁷ The prize stone was a very dark green emerald set in a pendant, cut in rectangular step-cut style and weighing 107 carats. It was reputed to have belonged to Tsar Alexander II (1818–1881).

It is claimed that the popularity of aquamarine increased greatly in the United

HISTORY AND LORE

States when it was made known that Alice Roosevelt, Theodore Roosevelt's daughter, received from Vice-President Taft a faceted heart-shaped aquamarine upon her marriage to Nicholas Longworth in the White House in 1906. In 1935, President Franklin D. Roosevelt and Mrs. Roosevelt visited Brazil and were presented, as a token of friendship between Brazil and the United States, with a magnificent flawless step-cut aquamarine of fine blue color, weighing 1,847 carats. This gem is on exhibit in the Roosevelt Museum, Hyde Park, New York. The custom of giving aquamarines to important visitors to Brazil was repeated in 1947 when another fine blue gem, set in a brooch, was given to Mrs. Harry S. Truman when she and the president visited the country to participate in the Pan-American Conference.

South America

The devastating plague that swept over the west coast of South America in 1590 decimated the populations of many cities but curiously passed by the city of Popoyan, Colombia. Its citizens, taking this as a sign of celestial favor, expressed their gratitude by commissioning a gold and emerald crown to be placed atop an effigy of the Virgin Mary in their cathedral. Known as the Crown of the Andes, it is said to have been carved from solid masses of gold weighing over 100 pounds (46 kg), with the finished weight 12 pounds (5.5 kg). There are 453 emeralds altogether weighing 1,521 carats, with the principal stone being the Atahuallpa Emerald of 45 carats set in the central arch directly beneath the apex cross (figure 4-26). Dangling from the arches are seventeen pear-shaped emeralds weighing from 12 to 24 carats each. The subsequent history of the crown is adventurous, and it is remarkable that the crown survived at all. In 1650, for example, British pirates raided Popoyan and seized the crown, but they later yielded it to the Spanish. During the War of Independence in Colombia in 1812, the crown changed hands several times but always was returned to the city. In 1909, however, cathedral officials decided to sell the crown to raise funds for hospitals and orphanages, a promising purchaser being Tsar Nicholas II. Delays in approval of the sale by the Vatican prevented the crown from becoming available until 1914, by which time Russia was embroiled in war and no sale was possible. In 1936, a syndicate headed by Chicago jeweler Warren J. Piper purchased the crown and sent it around the United States in exhibitions to which admission fees were charged. Finally, in 1963, according to contemporary newspaper accounts, the crown was sold at auction in London to a Dutch jeweler for \$155,000. Its present status is uncertain.

Elsewhere in Colombia, the Church of San Ignacio in Bogota treasures a gold monstrance made over 250 years ago which is notable for its jeweled decorations. It stands 80 cm (32 in) tall and weighs 8.3 kg (19 lb, 3 oz) and is studded with 1,485 native emeralds valued at \$2 million in 1928. Other gems include 28 diamonds, 13 rubies, 62 pearls, 168 amethysts, a sapphire, and a large topaz. A cross

Beryl in Art and Ornament



Fig. 4-26 Crown of The Andes, commissioned in 1593 and occupying the complete efforts of twenty-five goldsmiths over a period of six years. There are 453 emeralds set into the crown or suspended as drops from the arches. Total weight of the emeralds is 1,521 carats.

HISTORY AND LORE

on top is set with 22 large faceted emeralds, and a huge cabochon emerald is placed at its foot. In an unusual touch, the golden wings of an angel on the monstrance are overlaid with an enamel made from powdered emeralds. Because the predominant color is green, Colombians called the monstrance "La Lechuga" or "the lettuce."⁷⁵

MODERN EMERALD AND BERYL JEWELRY

The dispersal of vast quantities of emeralds from the treasuries of Indian rulers resulted in many of the stones being employed in modern pieces of jewelry, like that shown in figure 4-27, in which irregular or "baroque" emeralds, probably already drilled with suspension holes at the time of setting in the necklace, were combined with circlets of diamond-studded precious metal to make up an attractive design.

More typical of modern designs are the pieces shown in figure 4-28, in which the cuts of the gems and the design are strictly formal. In such pieces, precise cutting of the gems, fully symmetrical arrangements, and the employment of platinum are common features. A minor departure from strict formality in cutting styles for emeralds is shown in figure 4-29, where large and fine emeralds have been cut into pear shapes and their importance emphasized by surrounds and dangles of diamonds.

In the large and important necklace of diamonds and emeralds shown in figure 4-30, step-cut emeralds have been cleverly worked into a floral design which is both impressive and pleasing to the eye. The foliage and petals are represented by numerous marquise and pear-shaped diamonds. A similar motif is employed in the upper bracelet of figure 4-31, but here the emeralds are dark green, high-quality cabochons. The lower bracelet in the same figure is made more formal through employment of carefully matched and similarly cut square step-cut emeralds and marquise diamonds, all of large size. Other examples of emerald-set jewelry are shown in the color illustrations.

The intensity of color in dark green emeralds of top grade is such that even small examples can be effectively set in jewelry, but this is not the case with aquamarines, golden beryls, and other members of the beryl family, all of which tend to be pale in color if cut below certain critical dimensions. In many the color is so delicate that in stones of only several carats weight one cannot always be sure that any color is present at all unless the stone is placed on a piece of white paper. Naturally, the most desirable specimens of these beryls are those in which the hue is most intense, but such gems are much rarer and command much higher prices. It is for these reasons that the majority of ordinary gem-quality beryls other than emerald are seldom cut below five carats in weight. In most cases, it is desirable to cut them to at least ten or fifteen carats to insure sufficient richness of color.

Beryl in Art and Ornament



Fig. 4-27 *Art deco* cabochon emerald and diamond necklace sold on April 22, 1980, at Christie's auction in New York for \$210,000. The baroque shape of the emeralds, all of which are bored through for suspension, suggests that they may have been part of an antique Indian emerald necklace. *Courtesy Christie, Manson & Woods International Inc., New York.*



Fig. 4-28 Emerald and diamond jewelry set in platinum, formerly in the Estate of Nelson A. Rockefeller and sold at Christie's auction on October 16, 1979 in New York. The ring is set with an emerald of about 8.56 carats (\$95,000). The necklace contains several emeralds over 4 carats and all emeralds together weigh 37.33 carats with 64.65 carats of diamonds (\$350,000). The bracelet contains 19.68 carats of emeralds and 38.73 carats of diamonds (\$220,000). *Courtesy of Christie, Manson & Woods International Inc., New York.*

Beryl in Art and Ornament



Fig. 4-29 Emerald and diamond ear pendants, sold at auction by Christie's of Geneva on November 21, 1979, for \$930,000. The pear-shaped emeralds weigh 18.11 and 18.07 carats. *Courtesy Christie, Manson & Woods International Inc., New York.*

Many faintly tinted beryl crystals are found in very large sizes and from them can be cut gems of several hundred carats, often completely flawless. However, while they may display fairly intense color, they are too large for jewelry and are only useful as exhibit pieces in gem collections.

The preferred cutting style for such pale-colored varieties of beryl is the step-cut, in which light is reflected in narrow strips. Occasionally they are cut in brilliant styles or mixed cuts that combine features of both styles. However, large step-cuts are a severe test of lapidary accuracy because any appreciable deviation from parallelism between the top (crown) facets and bottom (pavilion) facets becomes easily apparent as the stone is turned about under a good light, at which time one may see reflections that are long tapered triangles instead of parallel-sided strips. These difficulties commonly result in the cutting of very large beryls in brilliant or mixed styles where slight inaccuracies are lost in the general dazzle of numerous light reflections.

Another difficulty that besets the lapidary in making step-cuts from aquamarine, golden beryl, or morganite is the devastating effect of permitting even a few

HISTORY AND LORE



Fig. 4-30 A modern necklace employing graduated step-cut emeralds with diamonds. Diameter of necklace approximately 6 inches (15 cm). *Courtesy Harry Winston, Inc., New York.*

tiny flaws to remain in the pre-shaped rough. If the flaws are located near the center of the stone, they will be repeatedly reflected until the stone seems filled with lines or bands of flaws. In contrast, emeralds of appreciable size with no flaws are extremely rare, and due to the rarity of this gemstone even in small sizes, many minor flaws are acceptable, even in those cut in step-styles. Flaws in other varieties of beryl are not tolerated, however. Thus, richly colored, accurately cut, flawless beryls, though rarely as costly as good emeralds, are nevertheless true prizes in terms of fine gems and are valued for use in first-class jewelry.

Beryl in Art and Ornament

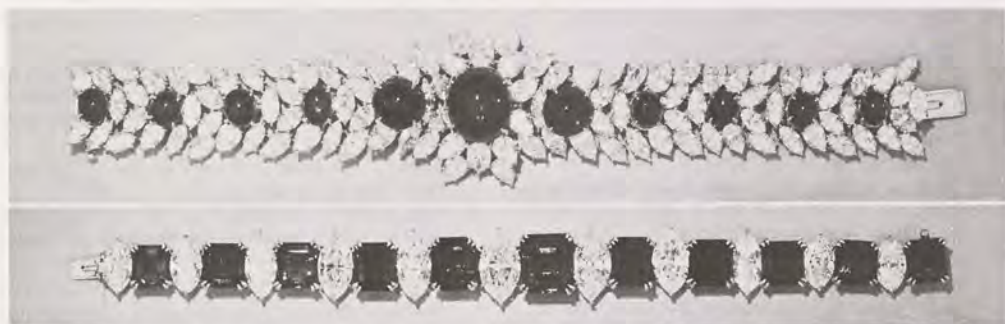

Fig. 4-31 Modern bracelets employing emeralds and diamonds. The top bracelet contains cabochon emeralds surrounded by marquise and pear-shaped diamonds, while the bottom bracelet uses graduated step-cut emeralds separated by graduated marquise diamonds. Courtesy Harry Winston, Inc., New York.

Literature Cited

1. Smith, A. H. 1888. *A Catalogue of Engraved Gems in the British Museum (Department of Greek and Roman Antiquities)*. Revised by A. S. Murray. London: Trustees of the British Museum, 253 pp.
2. Dalton, O. M. 1915. *Catalogue of the Engraved Gems of the Post-Classical Periods in the Department of British and Mediaeval Antiquities and Ethnography in the British Museum*. London: Trustees of the British Museum. 257 pp.
3. Walters, H. B. 1926. *Catalogue of the Engraved Gems and Cameos, Greek, Etruscan, and Roman, in the British Museum*. Revised and enlarged ed. London: Trustees of the British Museum. 419 pp.
4. Marshall, F. H. 1907. *Catalogue of the Finger Rings, Greek, Etruscan, and Roman, in the Department of Antiquities, British Museum*. London: Trustees of the British Museum. 258 pp.
5. Davenport, C. 1900. *Cameos*. London: Seeley and Co. 66 pp.
6. Richter, G. M. A. 1971. *The Engraved Gems of the Greeks, Etruscans and Romans. Pt. II. Engraved Gems of the Romans*. London: Phaidon Press. 307 pp.
7. Hertz, B. 1839. *A Catalogue of the Collection of Pearls and Precious Stones Formed by H. P. Hope*. . . London: Printed by William Clowes and Sons. 112 pp.
8. O'Donoghue, M. J. 1970. The Townshend collection of precious stones in the Victoria and Albert Museum. *Journal of Gemmology* (London) 12, no. 1, pp. 1-5.
9. Chabouillet, P. M. A. 1858. *Catalogue Général et Raisonné des Camées et Pierres Gravées de la Bibliothèque Impériale*. . . Paris: Au Cabinet des Médailles. 634 pp.
10. Cabinet des Médailles, Paris. 1930. *Guide du Visiteur*.
11. Middleton, J. H. 1891. *The Engraved Gems of Classical Times, with a Catalogue of the Gems in the Fitz-William Museum*. Cambridge: University Press. 157 pp.
12. Le Brun-Dalbanne 1880. *Les Pierres Gravées du Trésor de la Cathédrale de Troyes*. Paris: Rapilly, Libraire. 154 pp.
13. King, C. W. 1882. *The Johnston Collection of Engraved Gems in the . . . Metropolitan Museum of Art*. New York: Metropolitan Museum of Art. 83 pp.
14. Richter, G. M. A. 1956. *Catalogue of Engraved Gems, Greek, Etruscan, and Roman*. Rome: Published for the Museum by "L'Erma" di Bretschneider. 143 pp.
15. Sommerville, M. 1877. *Engraved Gems: Their Place in the History of Art*. Philadelphia: Porter & Coates. 71 pp.
16. Vermeule, C. C. 1956. *Cameo and Intaglio: Engraved Gems from the Somerville Collection*. Philadelphia: University Museum. 36 pp.
17. Baerwald, M., and Mahoney, T. 1949. *Gems and Jewelry Today*. New York: Marcel Rodd & Co. 303 pp.
18. *Fortune Magazine*, December, 1931. p. 138.
19. Rowan, F. 1958. Emerald of Erin is not for wearin'. *Washington [D.C.] Post*, September.

HISTORY AND LORE

20. King, C. W. 1872. *Antique Gems and Rings*. 2 vols. London: Bell and Daldy. 483, 86 pp.
21. ———. 1873. *Early Christian Numismatics, and Other Antiquarian Tracts*. London. 324 pp.
22. Eppler, W. F. 1924. Berühmte Edelsteine. *Deutsche Goldschmiede-Zeitung* (Stuttgart) 52:394-99.
23. Zwierlein-Diehl, E. 1969. *Antike Gemmen in deutschen Sammlungen. Vol. 2. Staatliche Museen Preussischer Kulturbesitz Antikenabteilung*. Munich: Prestel Verlag. 324 pp.
24. Furtwängler, A. 1896. *Beschreibung der geschnittenen Steine im Antiquarium der Königl. Museen zu Berlin*. Berlin: W. Spemann. 391 pp.
25. Rybakova, B. A. 1967. [Treasures of the U.S.S.R. Diamond Fund]. Moscow: Sovetskii Khudozhnik. 160 pp.
26. Kibaltchitch, T. W. 1910. *Gemmes de la Russie Meridionale*. Berlin: Reinke et Grounwald. 66 pp.
27. Fossing, P. 1929. *The Thorvaldsen Museum Catalogue of the Antique Engraved Gems and Cameos*. Copenhagen: G. E. C. Gad. 301 pp.
28. Eichler, F., and Kris, E. 1927. *Die Kameen im Kunsthistorischen Museum Beschreibender Katalog*. Vienna: Anton Schroll. 246 pp.
29. Copeland, L. L. 1974. *Diamonds: Famous, Notable and Unique*. Revised by R. A. P. Gaal. Los Angeles: Gemological Institute of America. 204 pp.
30. Caplan, A. 1968. An important carved emerald from the Mogul Period of India. *Lapidary Journal* 21:1336-7.
31. Stopford, F. 1920. *The Romance of the Jewel*. London: [Mappin & Webb]. 96 pp.
32. Hendley, T. H. 1906-1909. *Indian Jewellery*. London: Journal of Indian Art. 189 pp., 167 pls.
33. Duleep Singh, Maharajah. [1885]. *A Reprint of Two Sales Catalogues of Jewels & Other Confiscated Property*. N.p.: privately published. 131 pp.
34. Streeter, E. W. 1882. *The Great Diamonds of the World: Their History and Romance Collected from Official, Private, and Other Sources during Many Years of Correspondence and Inquiry*. Edited and annotated by J. Hatton and A. Keane. London: G. Bell & Sons. 321 pp.
35. Meen, V. B., and Tushingam, A. D. 1968. *Crown Jewels of Iran*. Toronto: University of Toronto Press. 159 pp.
36. Ball, S. H. 1924. Some facts about famous emeralds. *Jewelers' Circular-Keystone* 88, no. 10, 9 pp.
37. Vienna 1949. *Art Treasures from Vienna Collections*. Lent by the Austrian Government. N.p.: n.d., 67 pp.
38. Karabacek, J. 1893. Ein römischer Cameo aus dem Schatze der Ajjubiden-Sultane von Hamah. *Sitzungsberichte der Königl. Akademie der Wissenschaften, philosophische-historische Klasse, Wien*, vol. 129. 22 pp.
39. Wheeler, R. E. M. 1928. *The Cheapside Hoard of Elizabethan and Jacobean Jewellery*. London Museum Catalogues, No. 2. London: Lancaster House. 35 pp.
40. Black, J. A. 1974. *A History of Jewels*. London: Orbis Publishing. 400 pp.
41. Heiniger, E. A., and Heiniger, J. 1974. *The Great Book of Jewels*. Boston: New York Graphic Society. 316 pp.
42. Hughes, G. 1972. *The Art of Jewellery: a Survey of Craft and Creation*. London: Studio Vista. 248 pp.
43. Perry, L. S. 1960. *Chinese Snuff Bottles: The Adventures and Studies of a Collector*. Rutland: Charles E. Tuttle Co. 158 pp.
44. Pough, F. H. 1964. The gem collection of the American Museum of Natural History. New York City. *Lapidary Journal* 18:4-14, 76-81.
45. Bank Markazi Iran. 1964. *The Crown Jewels of Iran*. Tehran. 45 pp.
46. Topkapi Palace Museum. ca. 1977. *Guide Book: The Treasury Department of the Topkapi Palace Museum*. Istanbul: Kemal Cig. 64 pp.
47. Meen, V. B. 1966. Topkapi Palace, Istanbul, Turkey. *Lapidary Journal* 20:297-302, 416-7.
48. Abdul Hamid. 1911. *Catalogue des Perles, Pierrieres Bijoux . . . dont la vente aura lieu à Paris, Nov. 1911*. Paris:n.p. 58 pp.
49. Duncan, D. D. 1960. *The Kremlin*. Greenwich: New York Graphic Society. 170 pp.
50. Fersman, A. E. 1925. [Historical stones of the "Diamond Treasure"]. *Izvestiya Akademii Nauk SSSR*, (Moscow), ser. 6, vol. 19, pp. 721-30.
51. Twining, Lord. 1960. *A History of the Crown Jewels of Europe*. London: B. T. Batsford. 707 pp.
52. Snowman, A. K. 1961. *Easter Eggs and other Precious Objects by Carl Fabergé: A Private Collection of Masterworks Made for the Imperial Russian Court*. Washington, D.C.: Corcoran Gallery of Art. 60 pp.
53. ———. 1953. *The Art of Carl Fabergé*. London: Faber and Faber. 167 pp.
54. Lesley, P. 1976. *Fabergé: A Catalog of the Lillian Thomas Pratt Collection of Russian Imperial Jewels*. Richmond: Virginia Museum. 160 pp.
55. Menzhausen, J. 1968. *The Green Vaults*. Leipzig: Edition Leipzig. 114 pp.
56. Thoma, H., and Brunner, H. 1964. *Schatzkammer der Residenz München*. Munich: Bayerische Verwaltung der Staatlichen Garten und Seen. 391 pp.
57. Coche de la Ferte, E. 1962. *Antique Jewellery*. Orbis Pictus 7. Berne: Hallwag, Ltd. 8 pp., 19 pls.
58. Bloche, A. 1888. *La Vente des Diamants de la Couronne: son Histoire, ses Préparatifs, ses Résultats avec le Catalogue raisonné des Joyaux*. Paris: Quantin. 108 pp.

Beryl in Art and Ornament

59. Kunz, G. F. 1901. Precious Stones. Chapter in *U. S. Geological Survey Mineral Resources of the United States for 1900*, pp. 749-78.
60. Miro, J. I. 1870. *Estudio de las Piedras Preciosas*. Madrid: Imprenta á Cargo de C. Moro. 288 pp.
61. Kunz, G. F. 1913. *The Curious Lore of Precious Stones*. Philadelphia & London: J. B. Lippincott. 406 pp.
62. Young, S. 1969. *The Queen's Jewellery: The Jewels of H. M. Queen Elizabeth II*. New York: Taplinger Publishing. 199 pp.
63. Smith, G. F. H. 1972. *Gemstones*. 14th ed. Revised by F. C. Phillips. London: Chapman and Hall. 580 pp.
64. Jobbins, E. A. 1964. Gemstone collections of the Geological Museum, South Kensington, London. *Lapidary Journal* 18:18-34.
65. Trapp, F. W. 1969. The Gachala emerald shares the spotlight with the Hope diamond at the Smithsonian. *Lapidary Journal* 23:628.
66. Desautels, P. E. 1974. The National Collection of Gems in the Smithsonian Institution, 1965-1974. *Lapidary Journal* 28:84-100.
67. Dunn, P. J. 1975. Emeralds in the Smithsonian Gem Collection. *Lapidary Journal* 28:1572-5.
68. *Smithsonian Magazine* 8 (1977), no. 9, p. 28.
69. Desautels, P. E. 1965. The gemstone collection of the U.S. National Museum. *Lapidary Journal* 19:4-36.
70. ———. 1972. *Gems in the Smithsonian*. Washington, D.C.: The Smithsonian Press. 61 pp.
71. *Time Magazine*, November 6, 1964, p. 23.
72. MacFall, R. P. 1973. The Hall of Gems of the Field Museum. *Lapidary Journal* 27:746-50, 766-771.
73. Meen, V. B. 1963. The gem collection of the Royal Ontario Museum. *Lapidary Journal* 17:18-42.
74. Crowningshield, R. 1971. America's largest faceted emerald. *Lapidary Journal* 25:40, 42.
75. Wolf, B. 1958. The green treasures of the Andes. *Saturday Evening Post*, October 11, p. 24.

[The text on this page is extremely faint and illegible. It appears to be a multi-column document, possibly a ledger or a report, with several columns of text and some headings that cannot be discerned.]

PART



CHEMICAL AND PHYSICAL
PROPERTIES

*From these atomic shapes are built so many
things.*

Lucretius: De Rerum Natura, A.D. WINSPEAR, 1956

PART
II

CHEMICAL AND PHYSICAL
PROPERTIES

CHAPTER

5

CRYSTAL STRUCTURE AND CHEMICAL COMPOSITION OF BERYL

ALTHOUGH the arrangement of atoms within the beryl crystal structure was not known until recently, both Romé de Lisle¹ (in 1783) and Haüy² (in 1822) concluded that beryl could be referred to the hexagonal system of symmetry. As late as 1887, however, Wiik³ suggested that beryl was hexagonal only at high temperatures and was rhombohedral at lower temperatures, a view that failed to gain acceptance. In 1926, using the newly discovered x-ray techniques, Bragg and West⁴ investigated the structure and determined the model which is still accepted today.

THE BERYL STRUCTURE

As shown in figure 5-1, looking down the principal or *c*-axis, the structure consists of rings of silicon atoms, each surrounded by four oxygen atoms in tetrahedral arrangement, all of which, incidentally, are shown much reduced in size in order to make the structure readily visible. The atoms of aluminum and beryllium have also been reduced for the same reason. The rings, shown in a view at 90° to the basal plane view, are stacked one over the other and connected by bonds between alternating aluminum and beryllium atoms. This arrangement extends throughout the entire crystal. Figure 5-1 also shows that each aluminum atom is surrounded and bonded to six oxygen atoms while each beryllium atom is surrounded and bonded by four oxygen atoms. The abundance and uniformity of such bonds contributes to the great strength of the beryl structure and accounts for its resistance to chemical attack and such properties as hardness and toughness.

The sub-structure of silicon-oxygen tetrahedra is a very common one in the

CHEMICAL AND PHYSICAL PROPERTIES

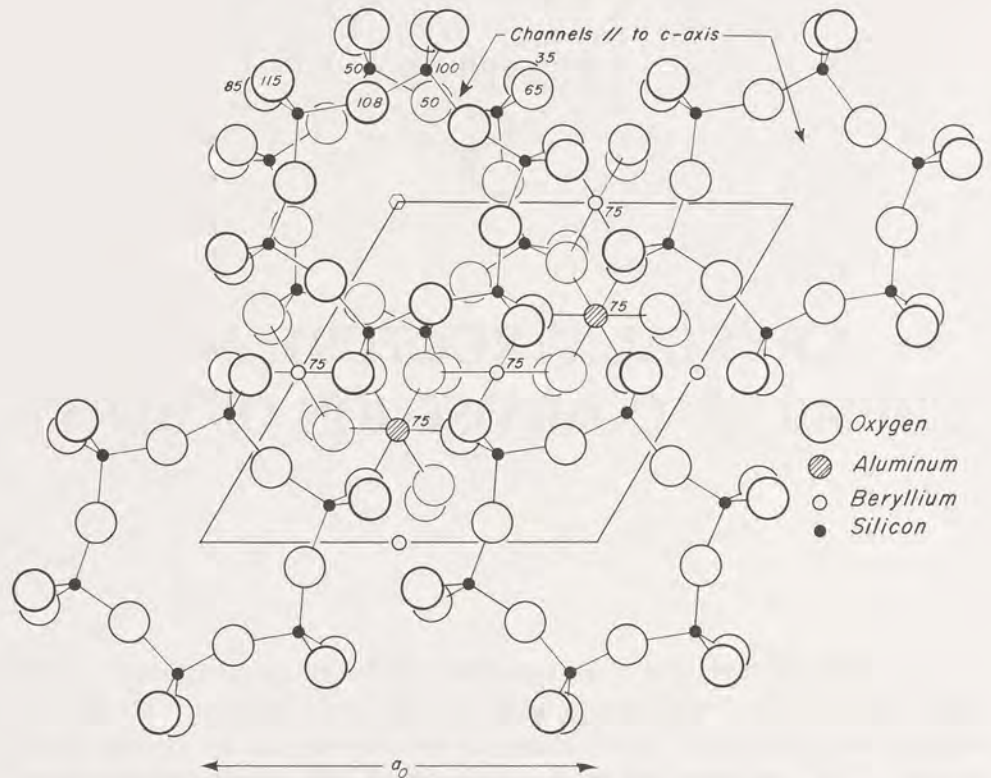

Fig. 5-1 Basal projection of the ideal beryl structure showing positions of the several ions, the basic cell, and the vertical distances of the ions in relation to the unit cell dimension c_0 in percents. After H. Strunz and C. Tennyson, *Mineralogische Tabellen*, 6th ed., Leipzig: Akademische Verlagsgesellschaft (1977).

so-called silicate minerals, by far the most abundant chemical class of minerals in the earth's crust. The linked silicon-oxygen tetrahedra take various forms, that in beryl being called *cyclosilicate*, because of forming rings. However, Beus⁵ (p. 86) suggested that it could also be called *tektosilicate* in view of the general uniformity of the structure, this term being used to describe a silicate structure in which the silicon-oxygen tetrahedra are more or less uniformly distributed throughout.

The striking feature of the structure, and one that has great significance in its chemical and physical properties, as well as in the shapes usually assumed by natural crystals (habits), is that the Si-O rings are aligned precisely over each other so that their openings form continuous channels parallel to the c -axis, as shown in the schematic drawing of figure 5-3. The vertical dashed lines pass through the centers of the channels. The distances between centers of the various atoms of the

Crystal Structure and Chemical Composition of Beryl

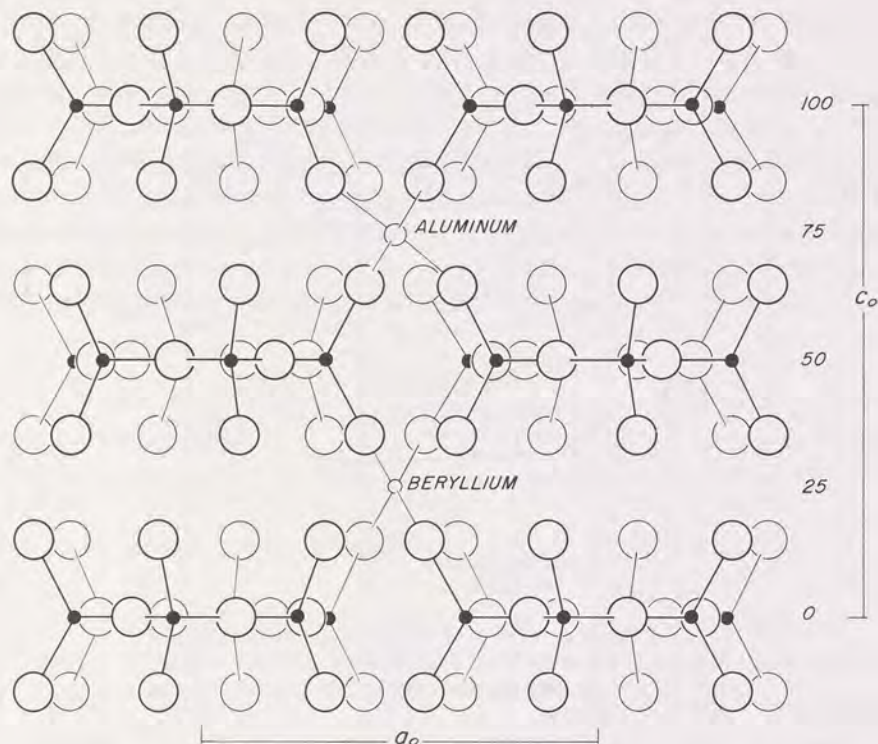

Fig. 5-2 Projection of the beryl structure on first order prism plane $10\bar{1}0$. This plane is oriented 90° to the basal plane of 0001 shown in figure 5-1. The numerals along the dimension c_0 correspond to those of figure 5-1. After H. Strunz and C. Tennyson, *Mineralogische Tabellen*, 6th ed., Leipzig: Akademische Verlagsgesellschaft (1977).

beryl structure were determined by Bragg and West⁴ (p. 713) as an outgrowth of their x-ray work on the structure of beryl.

SPACE GROUP AND SYMMETRY ELEMENTS

Bragg and West⁴ confirmed the work of Astbury and Yardley⁶ that beryl belongs to the most complete class of symmetry of the hexagonal system: holosymmetric, dihexagonal-bipyramidal, with space group D_{6h}^2 in the Schoenflies notation, or $P6/mcc$ in the Hermann-Mauguin notation. This means that if we had a completely developed beryl crystal, we would find that all of its faces are matched exactly by opposite faces, both along the sides of the crystal and along the ends. In addition to the usual six faces seen on by far most natural beryl crystals (hexagonal), another six faces may also be found, so that the sides of the crystal are

CHEMICAL AND PHYSICAL PROPERTIES

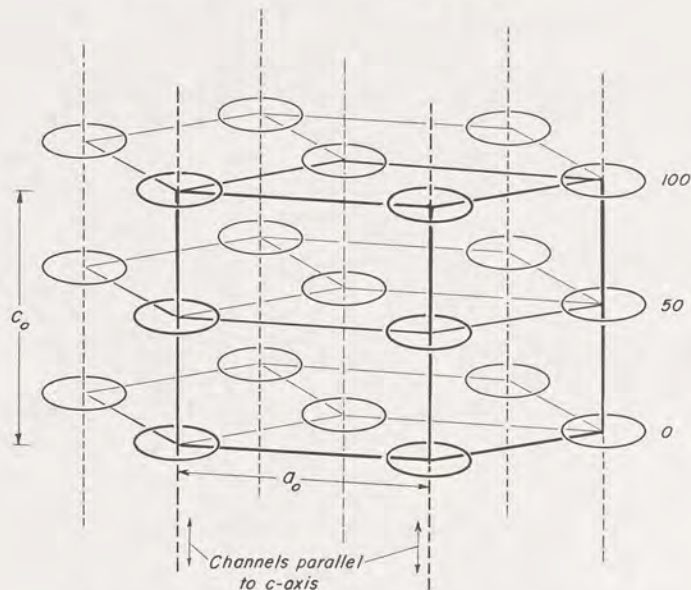

Fig. 5-3 Perspective view of the unit cell structure shown in detail in figures 5-1 and 5-2, showing the unit cell (dark outline) and the ring openings stacked above each other in the c -axis direction.

bounded by twelve altogether (dihexagonal). Finally, the ends of the fully developed crystal may show a series of inclined faces which form pyramids, and since these develop on both ends, the term describing such development is *bipyramidal*. The numerical and letter notations given above are a type of shorthand used to describe the elements of the symmetry in detailed, scientific writing and need not be understood any further for present purposes.

UNIT CELL AND AXIAL RATIO

Bragg and West determined the *unit cell*, that is, the smallest portion of the beryl crystal which contains all features of the crystal structure, geometrical and chemical. This was found to be two formula-units of $\text{Be}_3\text{Al}_2\text{Si}_6\text{O}_{18}$, that is, if the atoms in the unit cell are counted, they will total six berylliums, four aluminums, twelve silicons and thirty-six oxygens. The boundaries of the unit cell are shown schematically in figure 5-3 where the cell edges are indicated by dark outlines. The dimensions are shown by the continuous lines marked c_0 and a_0 , and as we shall see, these vary according to changes in chemical composition.

Before the beryl structure had been worked out, the proportions of the unit cell had been determined by measuring the angles made between faces on natural crys-

Crystal Structure and Chemical Composition of Beryl

tals. Such proportions, called the *axial ratio*, merely show relative lengths of c_0 and a_0 , and as can be seen in figure 5-2, they are nearly the same, that is 1:1, or put another way, the length of the unit cell is nearly equal to its width. In earlier periods, a much used ratio was that determined by Koksharov⁷ (vol. 1, p. 147) of $a:c = 1:0.49886$, usually rounded off to 1:0.499 as in Doelter⁸ (p. 584) and other compilations of crystallographic data. However, Bragg and West⁴ (p. 692) found unit cell dimensions of $c = 9.17 \pm 0.01 \text{ \AA}$ and $a = 9.21 \pm 0.01 \text{ \AA}$ for the two formula-unit cell mentioned above. They also reverse the ratio, according to modern practice, which therefore becomes $c:a = 1:0.9956$.

Table 5-1
BERYL CELL DIMENSIONS AND AXIAL RATIOS

c_0 (Å)	a_0 (Å)	$c:a$	References	Remarks
9.17 ± 0.01	9.21 ± 0.01	0.9956	4	Variety not stated
9.216	9.185	1.003	9	Synthetic emerald
9.170	9.207	0.996	9	Chivor emerald
9.189	9.188	1.000	10	W. Australia, pale green
9.183 ± 0.007	9.202 ± 0.012	0.9979	11	1.84% alkali metal content
9.209 ± 0.005	9.202 ± 0.012	1.0001	11	3.39% alkali metal content
9.227 ± 0.008	9.202 ± 0.012	1.0030	11	7.23% alkali metal content
9.20	9.21	0.999	12	Synthetic colorless beryl
9.20	9.30	0.989	12	Arizona blue beryl
9.21	9.15	1.006	13	W. Australia, light blue
9.17	9.19	0.998	13	W. Australia, cloudy white
9.21	9.20	1.001	13	W. Australia, light pink
9.231	9.216	1.001	14	Variety not known
9.1853 ± 0.001	9.2121 ± 0.001	0.997	15	Mt. Antero, pale blue
9.1856 ± 0.001	9.2006 ± 0.001	0.998	15	Saskatchewan, yellow
9.1892 ± 0.001	9.2545 ± 0.001	0.993	15	Saskatchewan, green
9.193 ± 0.002	9.212 ± 0.002	0.998	16	“Normal” beryl with H ₂ O but Be and Al unreplaced
9.249–9.212	9.216–9.219		16	2.4–3.0% Be, with Li totally or partly replacing Be; Al constant
9.200–9.224	9.248–9.267		16	Be and Al partly replaced
9.20–9.165	9.31–9.521		16	Al replaced, Be constant

CHEMICAL AND PHYSICAL PROPERTIES

CHANGES IN CELL DIMENSIONS

While the ideal formula for beryl is $\text{Be}_3\text{Al}_2\text{Si}_6\text{O}_{18}$, such a "pure" beryl is unknown in nature, all specimens analyzed chemically always showing more or less a content of other elements, which in the past have been called "impurities" but are now known to be more significant than the mere entrapments of foreign matter during crystal growth. Such ions (an atom or atom cluster bearing an electrical charge) are of two types, the first *substitutional*, the second, *channel ions*. Substitutional ions are elements that replace one of the ideal elements in the beryl structure because they happen to be of similar size and similar electrical charge. These substitutional ions will be described later. The channel ions are those trapped in the channel openings, previously noted in the rings of the beryl structure (figure 5-3), that are large enough even to accommodate the water molecule (H_2O).

Foreign ions in the beryl structure, especially substitutions for aluminum (Al) and beryllium (Be) have received much study, and more lately ions in the channels investigated. Frank-Kamenetskii and Sosedko¹¹ interpreted changes of composition versus changes in cell dimensions to mean that increasing alkali-metal ions (usually in the channels) leave the *a* dimension largely unaffected but cause an increase in the *c* dimension. The opposite view is taken by Schaller et al.¹² who concluded that "it is only the *a* direction [sic] that shifts with changes in the chemical composition, the *c* direction remaining constant in length."

Attempting to resolve the problem, Bakakin et al.¹⁶ (p. 130) examined the beryl structure in detail and concluded that when Al remained constant but Be was partly or wholly replaced by lithium (Li), "a deficit of beryllium . . . is thus accompanied by a marked growth of parameter *c* and by a simultaneous but one order smaller increase in parameter *a*." On the other hand, they also noted that in those beryls in which Be remained constant but Al increased, the *c* dimension changed scarcely at all, while *a* increased by one order more. It was also shown that when cesium (Cs) replaced Be, an increase in *c* occurred. In their view, the Cs ion, generally said to be the cause of changes in dimensions of the cell, cannot be responsible by itself, because it occupies sites only in the channels due to its large size. This prevents it from acting as a substitutional ion for one of the framework ions. However, it can change the cell dimensions indirectly by requiring a simultaneous replacement of Be by Li somewhere in the structure. Such a change can take place because the Li ion is small enough to substitute for Be, but its electrical charge is not the same and requires the Cs ion to be in the channel at the same time to neutralize the charge. The Cs ion, however, is too large to substitute for a framework ion, but can fit in the channel openings. Thus the substitution of the small Li ion for the small Be ion, coupled with the presence of the large Cs ion in a channel, produces the necessary physical "fit" as well as the necessary electrical charge neutrality. In sum, Bakakin et al. concluded that an increase in Cs

Crystal Structure and Chemical Composition of Beryl

and Li results in an increase in the *c* dimension, further remarking (p. 131) that changes in cell dimensions are due to replacements of Al and Be and not the mere presence of alkali ions.

Radcliffe and Campbell¹⁵ suggest that there are "two fundamentally different" types of beryl, one with the alkali ions in the structural framework and the other with alkalis in the channels. Their "C" type beryl is that in which the substitution occurs by larger ions taking the place of ions in the framework, resulting in "an expansion . . . in the direction of *c*." The second, or "A" type is that in which large ions lodge in the channels and after reaching 2.5 mol percent in quantity cause an expansion in the *a* direction. They also consider a third, combination type, or "A-C" beryl which "would involve an expansion in both directions."

CHEMICAL COMPOSITION

Early chemical analyses of beryl by Achard¹⁷ in 1779 and by Bergman¹⁸ in 1780 were only crude approximations reflecting the primitive state of analytical chemistry at the time. Because of the similar chemical behavior of beryllium and aluminum compounds, the oxides of both were counted together as "alumina." The fact that two distinct oxides were present was not discovered until 1798 when Vauquelin published his crucial analysis of emerald. Weeks¹⁹ (p. 250) described the discovery of the beryllium oxide as follows: "The identity of beryl and emerald was not suspected until the famous French mineralogist, the Abbe Haüy, made a careful study of their crystal forms and physical properties and was so struck by the similarity of the two minerals that he asked Vauquelin to analyze them chemically." Vauquelin had overlooked the new oxide in an earlier analysis but corrected himself in his analysis of 1798²⁰ when he was able to separate and distinguish beryllia, which he named *glucina* after its sweet taste. The element itself, not yet isolated, he named *glucinum*. These names remained in use in France for many years afterward, but elsewhere the terms beryllium oxide, or beryllia, and beryllium were adopted.

Not only did Vauquelin discover beryllium oxide during his analysis of "Peruvian" (Colombian) emerald, but, as his analysis showed, he found chromium, now known to be the cause of the beautiful green color typical of emeralds.

A later analysis of Siberian aquamarine by Gmelin confirmed the presence of beryllium oxide but found no lime (calcium oxide) which ordinarily is not a significant constituent¹⁹ (p. 251). However, an initial analysis of beryl in 1798 by Vauquelin showed the presence of lime, and, in 1800, when Vauquelin reanalyzed Colombian emerald he *again* reported lime as "carbonate" (see his analyses in Table 5-2).²¹ By the mid-19th century, numerous analyses had been published. Two typical results by Müller²² on beryl from Tirschenreuth fairly closely approach the "ideal" composition given in table 5-2, that is 66.7–67% SiO₂, 20.0–19.8% Al₂O₃,

CHEMICAL AND PHYSICAL PROPERTIES

Table 5-2
VAUQUELIN'S ANALYSES OF BERYLS

	<i>Beryl</i> (1798)	<i>Muzo</i> <i>Emerald</i> (1798)	<i>Emerald</i> (1800)	<i>Ideal</i>
Silica	69.00%	64.60%	64.50%	66.9% SiO ₂
Alumina	13.00	14.00	16.00	19.0% Al ₂ O ₃
Glucina	16.00	13.00	13.00	14.1% BeO
Lime	0.50	2.56	1.60	—
Iron oxide	1.00	—	—	—
Chromium oxide	—	3.50	3.25	—
Moisture, volatiles	—	2.00	2.00	—
Total	99.50%	99.66%	100.35%	100.0%

13.0–13.2% BeO, and 1.0–0.8% iron oxides, for totals respectively of 100.7% and 100.8%. Other early analyses are given in Dana²³ (pp. 407–8), Hintze²⁴ (pp. 1292–6), and Doelter⁸ (pp. 584–90). Modern compilations appear in Mellor²⁵ (pp. 803–8), Feklichev²⁶ (pp. 412–7), Deer, Howie, and Zussman²⁷ (pp. 258–61), and Beus⁵ (pp. 86–99).

Silica, Alumina and Beryllia

Silica (SiO₂)—Reported range 45.61 to 69.51%. Most figures are in the range 64.30 to 66.40%, although Schaller et al.¹² reported only 59.52%, “the lowest known in beryl.”

Alumina (Al₂O₃)—Reported range 9.9 to 38.86%; most figures are in the range 17.25 to 20.25%. Earlier analysts sometimes were unable to separate beryllia from alumina, thus accounting for some extraordinarily high values for Al₂O₃. Schaller et al.¹² also claim that their value of 10.63% is the “lowest of any known beryl.”

Beryllia (BeO)—Reported range 1.10 to an extreme instance of 27.31% but a better general range is 7.34 to 15.9%, with most values in the range 9.24 to 14.00%.

Water in Beryl

Water is commonly present in numerous voids in beryl crystals, some of which are large enough to see with the unassisted eye. In some crystals, the voids contain so much water that it can be seen to move when the crystal is tilted. In contrast, the water that occurs in the ring channels (see figures 5-1, 5-3) is invisibly trapped,

Crystal Structure and Chemical Composition of Beryl

and its presence, detected only at the elevated temperatures necessary for its release, caused much puzzlement to early analysts. As Deer, Howie, and Zussman²⁷ remark, "even gem quality beryls may contain appreciable amounts of H_2O^+ " (p. 258). Despite taking great care to select fragments free of inclusions, early analysts soon found that water and other volatiles almost invariably formed a substantial part of the analysis.

Water was first given serious consideration as a component of beryl by Penfield²⁸ in his classical analyses of alkali beryls published in 1884. He remarked that the water "cannot be called accidental, for it is always present in amounts varying from 1.50 to 2.50 percent," and he tabulated its progressive loss from beryl beginning with a "low red" to "white heat" and to the highest heat available to him in an air-blasted flame. Convinced that the water was integral to the composition, he proposed a formula for beryl incorporating water, a suggestion that has been adopted from time to time by other workers but which has failed to find universal acceptance. Recently, Ginzburg²⁹ heated beryls and found that water was slowly expelled at 800 to 900°C and that its removal did not affect the crystal structure.

Using infrared-spectroscopy methods, Wickersheim and Buchanan³⁰ studied water in beryl and suggested that single molecules exist in the channels. Their studies also suggested that alkali ions were present in some channels as well, and that a complex spectrum obtained on a pink beryl was due to hydroxyl (OH) groups substituting for oxygen. Nuclear magnetic resonance studies by Paré and Duclos³¹ confirmed the location and orientation of water molecules in the channels but showed that such molecules were free to rotate. However, Boutin et al.³² concluded that the water molecules do not rotate but rather oscillate. In a later paper, Wickersheim and Buchanan³³ enlarged on their previous findings and reaffirmed their conclusions that hydroxyl groups may substitute for oxygen in the silicate rings.

Sugitani et al.³⁴ found two types of water in the structure, the first as water molecules located in the spaces, 4.5 Å in diameter, within the channels, and the second as hydroxyl ions replacing oxygen in the rings. As shown in figure 5-4, the channel holes of 4.5 Å are spaced 4.59 Å apart in the *c*-axis direction. More recently, Wood and Nassau^{35,36} examined forty natural and ten synthetic beryls and found infrared absorption lines due to two types of water and carbon dioxide, all of which are located in the channel voids. Type I water occurs alone but Type II is associated with nearby alkali ions and is oriented as shown in figure 5-4. Bakakin and Belov³⁷ also discuss the role of water and concluded that the molecules fit in the centers of the rings while either sodium or cesium ions fit within the larger voids between the rings. Two kinds of water were identified by them, the first released at low temperature (350–600°C) and the second at a much higher temperature (over 900°C).

In this connection, Nassau and Wood³⁶ found that a Brazilian colorless beryl,

CHEMICAL AND PHYSICAL PROPERTIES

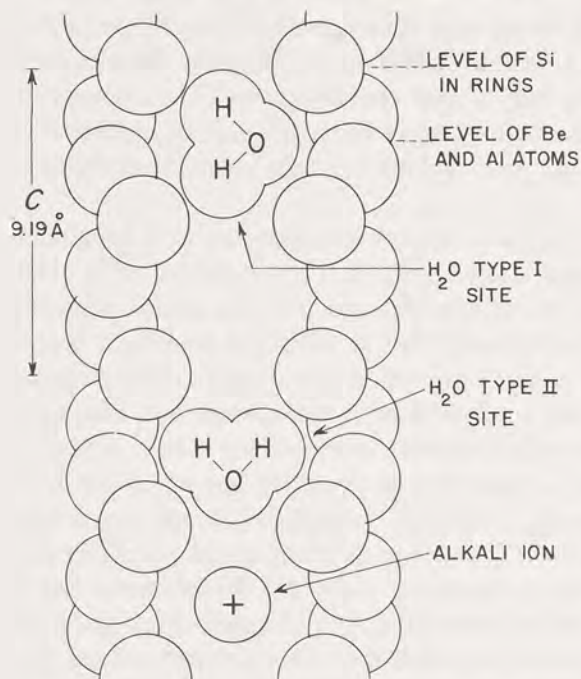

Fig. 5-4 Side view of a channel in beryl, only the oxygen atoms of the wall being shown, with possible positions and orientations of water and alkali ions. After Kurt Nassau, *Synthetic Emerald*, *Lapidary Journal* 30 (1976):196.

which displayed spectra of both Type I and Type II water, lost 1.6% by weight near 900°C while another colorless beryl from Brazil did not emit gases even at 1200°C, yet produced spectral absorptions indicating that some water remained in the structure. A temperature of 1350°C was required before water and CO₂ were released and the spectra indicated that none remained. An attempt to induce water to penetrate the channels of dehydrated beryl failed even after subjecting the specimen to hydrothermal treatment at 358°C and 8000 psi. Tests upon synthetic flux-melt beryl showed that water was absent, while in a hydrothermally grown specimen lacking alkalis, only spectra of Type I water were obtained. In a later series of experiments, Nassau and Wood³⁸ examined the remarkable anhydrous red beryl of Utah, which occurs in cavities in rhyolite, and inferred "an exceptionally high temperature of formation," which precluded the incorporation of water into the structure.

Numerous analyses show the common occurrence of channel water in beryl, with quantities ranging from less than 1 weight percent to over 4% but most determinations give less than 3%. Bakakin and Belov³⁷ (p. 487) point out that the

Crystal Structure and Chemical Composition of Beryl

percent of channel water is related to the number of sites in the channels which it can occupy. In one site, it forms a complex ion with a sodium ion and in another it serves to support a large cesium ion. Furthermore, it does not merely reside inertly in the channels but serves to electrically connect the alkali ions to the structure and to confer a more complete electronic neutrality. Kleeman³⁹ suggested that part of the silicon atoms in the rings may be replaced by hydrogens, but the majority view is that water is present only in the channels and that its presence or absence does not affect the integrity of the structure.

Alkalis in Beryl

Studying alkalis in beryls, Penfield²⁸ found that sodium was present in all seven test specimens, lithium in five, cesium in two, and calcium and magnesium in one each. Alkali metals later proved to be so common in beryl that virtually no natural specimen seems to be without a small to substantial quantity of one or more of them. Other elements in this class that commonly occur in beryl are potassium, magnesium, and rubidium, but they generally do not occur in the significant amounts characteristic of the others. In general, sodium is most often found, but in terms of total quantity in any given specimen it may be surpassed by cesium.

Numerous analyses of pegmatite beryls are given in Beus⁵ (Tables 39–41, pp. 86–8) under headings of “alkali-free,” “sodium,” and “sodium-lithium and lithium cesium” beryls. Expressed in oxides, his analyses show maximum alkali contents of $\text{Cs}_2\text{O} = 4.13\%$, $\text{Na}_2\text{O} = 2.74\%$, $\text{CaO} = 1.40\%$, $\text{Rb}_2\text{O} = 1.35\%$, $\text{Li}_2\text{O} = 1.23\%$, $\text{MgO} = 0.80\%$ and $\text{K}_2\text{O} = 0.27\%$. The largest total alkali oxide content is 7.23% in table 41 (analysis 38) for a pink beryl from the USSR. However, both the total alkali oxide and the maximum quantity of Cs_2O are now exceeded in the findings of Schaller et al.¹² in a remarkable blue beryl from Arizona. His determinations are as follows: $\text{Cs}_2\text{O} = 6.68\%$, $\text{Na}_2\text{O} = 1.16\%$, $\text{Li}_2\text{O} = 0.23\%$, $\text{K}_2\text{O} = 0.16\%$, and $\text{CaO} = 0.11\%$, total = 8.34%. Even more remarkable is the finding of Cs_2O alone of 11.3% found by Evans and Mrose⁴⁰ in a beryl from Antsirabe, Madagascar.

The following data are taken from chemical compositions tabulated by Feklichev,²⁶ Beus,⁵ and Deer, Howie, and Zussman²⁷ as representative of more recent analyses, but also from older compilations of Hintze²⁴ and Doelter.⁸

Cesium—From traces to the very large amount of 11.3% Cs_2O noted above; most analyses give less than 4%; Feklichev²⁶ found a maximum of 4.13%.

Sodium—Very commonly found; a maximum of 4.22% Na_2O in Feklichev;²⁶ Beus⁵ gives a maximum of 2.74%; most analyses range from less than 1% to about 2%.

Calcium—Common; maximum of 3.98% in Feklichev; most analyses give less than 1%.

CHEMICAL AND PHYSICAL PROPERTIES

Rubidium—Rare; Beus gives maximum of 1.35%; others about 0.02%.

Lithium—Common; numerous analyses give up to about 2% Li_2O (Doelter⁸); Feklichev reported a maximum of 1.39%, Beus gave a maximum of 1.23%; most analyses report less than 1%.

Magnesium—Common; maximum of 3.37% reported in Feklichev; most analyses give 1.50% MgO or less.

Potassium—Uncommon; usually in small amounts of K_2O , less than 0.50%; maximum reported of 7.82% in Hintze²⁴ is so far above other determinations that it probably is in error; Beus gives a maximum of 0.36%.

Barium—Very rarely reported as BaO ; quantities of 0.15 to 0.21%.

Strontium—Very rarely reported as SrO ; quantities of 0.01 to 0.06%.

Transition Elements in Beryl

The transition elements include iron, titanium, manganese, chromium, vanadium, scandium, cobalt, nickel, and copper, all of which have been found in beryl, but, aside from iron, mostly in small amounts. The following data are taken from Feklichev,²⁶ Beus,⁵ Deer, Howie, and Zussman,²⁷ Doelter,⁸ and others as indicated.

Iron (FeO)—Common, from traces to as much as 3.13% (Doelter), but this very high amount is far above recent determinations as recorded in Feklichev, who gives a maximum of 1.2%; Beus gives a maximum of 0.50%; Deer, Howie, and Zussman give a maximum of 1.50%.

Iron (Fe₂O₃)—Common, traces to 4.98% (Doelter), and in other earlier analyses in amounts considerably over 2%, but all are much over the amount of 1.72% recorded by Beus and the 0.96% in Deer, Howie, and Zussman. However, Feklichev gives a maximum of 2.83%. Recent analyses show Fe_2O_3 absent in many beryls, or present in amounts much less than 1%. This is a reasonable finding because the strong coloring typically induced by iron is lacking in most beryls.

Titanium (TiO₂)—Rarely reported in older analyses; uncommon in recent ones. Beus, for example gives only five analyses, maximum quantity 0.05%.

Manganese (MnO)—Rare; traces to 0.75% in Feklichev; Beus gives a maximum of 0.19%; most analyses show less than 0.20%.

Chromium (Cr₂O₃)—Despite its being known as the principal coloring ion in emerald, surprisingly few emerald analyses show any chromium at all, and some analyses of non-emerald beryls which report small quantities of chromium may be in error because even very small quantities seem sufficient to induce decided emerald color. Vauquelin found 3.50% and 3.25% chromium oxide in Muzo emeralds in 1798 and 1800 respectively, but such large quantities have not been found since. Doelter cited an analysis by Lévy⁴¹ who found only a trace of Cr_2O_3 in Muzo emerald and was reluctant to attribute its color to chromium. Leitmeier⁴² (pp. 309–10) recognized the difficulties in determining Cr and therefore described in

Crystal Structure and Chemical Composition of Beryl

detail his analytical procedure for determining this element in Habachtal emerald, which contained 0.12% Cr_2O_3 . He also assembled eleven other emerald analyses, including two of synthetics (in which Cr was not found) and four of Muzo specimens, of which one contained only a trace of Cr_2O_3 and another only 0.08%. Analyses of Emmaville, New South Wales, emerald, of another Habachtal emerald, and of three Uralian emeralds all failed to detect Cr.

An analysis of a "large quantity of emerald powder," presumably Muzo emerald, by Barriga Villalba⁴³ (pp. 117-9) yielded 0.26% Cr_2O_3 ; he noted that "the color of emerald is owing to the oxides of iron and chromium" and that "a series of analyses confirm that these metals always occur in the emerald of Muzo in the following proportions, iron, Fe_2O_3 —1.005%, chromium, Cr_2O_3 —0.26% . . . the proportions are more or less constant, but the concentration is variable." This view of a coloration due to the combined effect of iron and chromium is not shared by others. Beus⁵ (table 39) gives an analysis by Simpson⁴⁴ (p. 198) of Poona, West Australia emerald in which was found 0.23% Cr_2O_3 . Rogers and Sperisen⁴⁵ found 2.00% Cr_2O_3 in synthetic emerald and gave as a general range for emerald 0.12-0.25%.

The inconsistency of results of chromium analysis suggests that additional analyses are needed before reliable figures of Cr_2O_3 content in emerald can be established. Those analyses of emerald in which Cr was not detected may reflect more the difficulty of discriminating Cr_2O_3 from Fe_2O_3 than the absence of Cr.

Vanadium (V_2O_5)—Reported very rarely, from traces to 0.9% (Feklichev); Beus (table 39, footnote) gives only one determination at 0.09%. It has been suggested that some emeralds are colored in part by vanadium instead of or in combination with chromium, about which more will be said in Chapter 8.

Scandium (Sc_2O_3)—Very rarely reported except in the blue scandian analog of beryl called bazzite. Its ideal formula, $\text{Sc}_2\text{Be}_3\text{Si}_6\text{O}_{18}$, reflects entire substitution of aluminum by scandium but such has not been observed in natural specimens. Borovik^{46,47} examined numerous beryls spectroscopically and found that Sc appeared to accompany Cr in some specimens, and was present in quantities from nil in colorless beryls to as much as 0.03 weight percent in emerald. Neumann⁴⁸ investigated forty-seven beryls from Norway and found 10 to 1000 ppm (0.01%) Sc, noting that beryls from pegmatites containing the Sc-silicate thortveitite were most likely to contain this element. It is interesting to note that in Artini's original analysis of bazzite,⁴⁹ beryllium was not recognized and the mineral was called a silicate of scandium with rare elements. Huttenlocher, Hügi, and Nowacki⁵⁰ found about 3.0% Sc in bazzite, which quantity was reported by Feklichev.²⁶ Nowacki and Phan⁵¹ found $9.8\% \pm 0.3\%$ in bazzite, which amounts to $15.1 \pm 0.4\%$ Sc_2O_3 . Schaller et al.¹² found 0.10% Sc_2O_3 in Arizona blue beryl. In 1978, Chistyakova et al.^{51a} described bazzite from cavities in pegmatites in the Kentsk granite massif of Kazakhstan S.S.R. and found $\text{Sc}_2\text{O}_3 = 14.44\%$, $\text{Al}_2\text{O}_3 = 0.25\%$, $\text{Fe}_2\text{O}_3 =$

CHEMICAL AND PHYSICAL PROPERTIES

2.21%, FeO = 3.68%, and BeO = 12.90%. Stalder,^{51b} reported an electron microprobe analysis on bazzite from the Furka-Basistunnel in Switzerland as $\text{Sc}_2\text{O}_3 = 12.5 \pm 1.2$ wgt. % and Fe_2O_3 about 6%. In a study of numerous beryls from Switzerland, including eight bazzites, Hänni^{51c} found in the latter Sc_2O_3 to range from 9.9 to 12.6%, Al_2O_3 from 0.5 to 2.3%, FeO from 3.1 to 6.6% and Na_2O from 1.9 to 2.7%.

Cobalt, Nickel, Copper—Very rarely reported, and only in traces.

Other Elements in Beryl

The following small quantities of trace elements have been found in beryl: B_2O_3 to 0.39%; ClO_3 to 0.02%; Ga to 0.0044%; Nb_2O_5 to 1.75%; P_2O_5 to ca. 0.05% but as high as 3.60% (Feklichev and Razina⁵²); Ta_2O_5 to 0.72%. In traces or detected spectroscopically: Ag, As, Au, Bi, Cd, Ce, Dy, Er, Eu, Gd, Ge, Hf, Hg, Ho, In, Ir, La, Lu, Nd, Os, Pb, Pd, Pr, Pt, Re, Rh, Ru, Sb, Sn, S, Tb, Th, Tl, Tm, U, W, Y, Yb, Zn. See also the table of trace elements in beryl by Buchi⁵³ (p. 42–3).

Traces of noble gases have also been found in beryl. Helium was first discovered in a beryl from Acworth, New Hampshire by Strutt,⁵⁴ who argued that the helium was derived from decay of some radioactive element incorporated in the beryl during growth and which had entirely disappeared with time. However, Piutti⁵⁵ investigated the helium (He) content of numerous beryls and could not correlate content with age, nor did he find any consistency in He content even among beryls from the same deposit. Numerous investigations of helium and argon (Ar) in beryl were summarized by Beus⁵ (pp. 14–5, 99). He gives a general rule that helium accumulates in beryls with age, those from Precambrian pegmatites containing most, while those from Cenozoic bodies contain least. From numerous determinations published in the literature, the He content ranges from 0.02 to 17.20 mm³/gm of beryl. Most authorities agree that both He and Ar are radiogenic, possibly from the reaction $\text{Be}^9 + \text{gammas} + \text{neutrons} \rightarrow \text{Be}^8, \text{to He}^4$. Feklichev²⁶ (p. 418) suggests that noble gases may occupy the same sites in the channels as the water molecules.

SUBSTITUTIONS

As is true in other crystal structures, substitutions in beryl require that the substituting ions be of the same charge and approximately the same size. Some substitutions, however, are more complex, involving several differently charged ions, which, when taken together, confer the required electronic neutrality to the structure. The problem of substitution in beryls is discussed at length in Feklichev,²⁶ Beus,⁵ Schaller et al.,¹² and briefly in Deer, Howie, and Zussman,²⁷ Ginzburg,²⁹ Bakakin and Belov,³⁷ and Bakakin et al.¹⁶

Crystal Structure and Chemical Composition of Beryl

The structural ions in the ideal beryl are as follows:

Beryllium— Be^{2+} , 0.35 Å, located between silicate rings and bonded to four oxygens such that it lies in the center of an oxygen tetrahedron.

Aluminum— Al^{3+} , 0.51 Å, located between silicate rings, bonded to six oxygens such that it lies in the center of an oxygen octahedron.

Silicon— Si^{4+} , 0.42 Å, located in the silicate rings, bonded to four oxygens such that it lies in the center of an oxygen tetrahedron.

Oxygen— O^{2-} , 1.32 Å, located in the silicate rings where it surrounds the silicon ions and extends unabsorbed bonds to Be and Al.

All of the bonds in the structure are strong, especially those in the silicate rings in which Si-O form characteristic silicate building blocks which tend to discourage substitutions either for the oxygen or the silicon. Substitutions for beryllium and aluminum are more common and, as previously mentioned, the channels formed by the ring openings contain sites which accommodate water and hydroxyl molecules, gas molecules, and metal ions, particularly the large alkali ions.

Channel Ions

Geometrically, the channels in beryl crystal resemble strings of polygonal beads, the "beads" representing the larger openings between silicate rings and the narrow spaces between the beads, those openings in the planes containing the rings themselves (see figure 5-4). Easily accommodated are Cs^+ (1.67 Å), Rb^+ (1.47 Å), and K^+ (1.33 Å) in the larger openings and Na^+ (0.97 Å) within ring openings. According to Bakakin and Belov³⁷ (p. 485), all of these ions are "definitely within the channels" of the structure as are the water and hydroxyl molecules.

Cesium— Cs^+ , 1.67 Å. Too large to fit in any site except in the large spherical spaces between rings which are approximately 4.6 Å in diameter. Water commonly accompanies Cs, but because of the latter's size, water is effectively blocked from escape by the Cs ions except at elevated temperatures. Bakakin and Belov³⁷ (p. 489) note that only one Cs^+ can be accommodated per two formula units, with Cs^+ always being accompanied by Li^+ , which substitutes for Be^{+2} thus maintaining electronic neutrality. If there is no Li in the structure, there is no Cs.

Sodium— Na^+ , 0.94 Å. Too large to take the place of Al (0.51 Å) and therefore found only in channel sites where it forms a "formal ion" with water and hinders egress of water, which commonly accompanies it.³⁷ Na^+ may "exceptionally" occur also in the spaces in the ring planes.

Potassium— K^+ , 1.33 Å. Too large to fit except in channels where it lies in ring openings, like HOH groups, or sometimes in positions taken by Rb^{37} (p. 491).

Rubidium— Rb^+ , 1.48 Å. In channels only, where it lies "between HOH and three oxygens of a strongly distorted (ditrigonal) ring"³⁷ (p. 491).

CHEMICAL AND PHYSICAL PROPERTIES

Calcium— Ca^{2+} , 0.99 Å. Behaves like sodium.

Water— H_2O , ca. 3.7 Å (max.). Found in channels only, in two different orientations (Wood and Nassau³⁶).

Hydroxyl— OH^- , ca. 1.32 Å. In channels only.

Carbon Dioxide— CO_2 , a linear molecule ca. 5.0 Å long. Identified in channels by Wood and Nassau³⁶ (p. 782–4); they estimate it may form at least 0.1 wgt % in several tested specimens.

Iron— Fe^{2+} , Fe^{3+} in “relatively small amounts.”¹¹⁰

Substituting Structural Ions

Iron— Fe^{2+} , 0.74 Å, and Fe^{3+} , 0.64 Å. In octahedral sites normally occupied by Al (0.51 Å); also in the Be site as Fe^{3+} .¹¹⁰

Lithium— Li^+ , 0.68 Å. In tetrahedral sites normally occupied by Be (0.35 Å), sometimes in the octahedral site of Al, but only when there is a deficiency of Al, and very rarely in spaces between rings³⁷ (p. 490).

Magnesium— Mg^{2+} , 0.66 Å, for Al.

Scandium— Sc^{3+} , 0.732 Å, for Al.

Manganese— Mn^{2+} , 0.80 Å, for Al.

Chromium— Cr^{3+} , 0.63 Å, for Al.

Vanadium, Titanium, Cobalt, Nickel, Copper—Probably occur in octahedral sites normally occupied by Al.

Strontium and Barium— Sr^{2+} , 1.12 Å; Ba^{2+} , 1.34 Å. Rarely found in the beryl structure because “they cannot find convenient positions,” (Bakakin,³⁷ p. 488).

Displacements

Beryllium— Be^{2+} , 0.35 Å. May occupy Si^{4+} (0.42 Å) sites in the rings when there is a deficiency of Si, or may occupy an Al^{3+} (0.51 Å) site for the same reason, but “substitution for Al is preferred”³⁷ (p. 490).

Silicon— Si^{4+} , 0.42 Å. May be found in Be sites “if in excess.”³⁷

Aluminum— Al^{3+} , 0.51 Å. May substitute for Be or Si if in excess.

BERYL FORMULAS

The ideal formula, $\text{Be}_3\text{Al}_2\text{Si}_6\text{O}_{18}$, is seldom confirmed by analyses of natural beryls, and by far the greater number of determinations show a small but consistent content of alkali metals and water. Attempting to reflect the empirical rather than the theoretical, Ginzburg²⁹ proposed the following generalization:

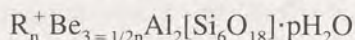

where: R^+ = alkali ion, $n = 0-1$, and $p = 0.2-0.8$. For the cesium-lithium beryl vorobeyevite he proposed:

Crystal Structure and Chemical Composition of Beryl

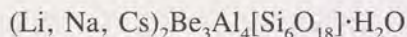

For the same variety, Bakakin and Belov³⁷ (p. 490) suggested an alternative formula as follows:

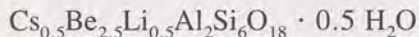

In an extended study of beryl compositions and isomorphous substitutions, as it pertains mainly to the introduction of alkali elements, Feklichev²⁶ proposed several formulas, of which the following is a generalized series-formula accommodating monovalent (singly charged) and divalent (doubly charged) ions:

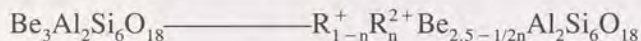

where: $\text{R}^+ = \text{Cs}^+, \text{Li}^+, \text{Rb}^+, \text{Na}^+, \text{K}^+$; $\text{R}^{2+} = \text{Ca}^{2+}, \text{Ba}^{2+}, \text{Sr}^{2+}$; and $n = 0-1$.

The above formula reflects the principal features of beryl chemistry, that is, the inverse quantitative relationship between alkalis and beryllium. Vlasov⁵⁶ (p. 98) considered this formula the most reflective of natural beryl compositions. Other suggested formulas may be found in Beus⁵ (p. 96) and Deer, Howie, and Zussman²⁷ (p. 258).

Additionally, Bakakin and Belov³⁷ (p. 493-5) list numerous "structural" formulas, grouped according to analyses of beryls from type-deposits, namely, from hydrothermal-pneumatolytic, pegmatitic, and late-pegmatitic. In these formulas, the structural ions are shown first, then channel ions, and lastly the water. A similar scheme, partitioning ions according to positions in the structure, is given in Bakakin et al.¹⁶ (p. 130).

Stemming from their study of an unusual blue beryl from Arizona, Schaller et al.¹² (p. 691) proposed the following beryl-series formulas with end-members shown below. Water is omitted.

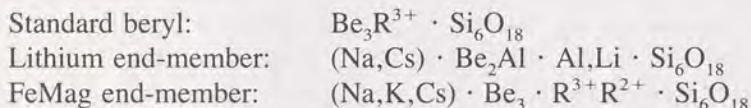

where: $\text{R}^{3+} = \text{Al}^{3+}, \text{Fe}^{3+}, \text{Cr}^{3+}, \text{Sc}^{3+}$; and $\text{R}^{2+} = \text{Fe}^{2+}, \text{Mn}^{2+}, \text{Mg}^{2+}$.

ALTERATIONS AND PSEUDOMORPHS OF BERYL

Once formed, beryl is highly but not invariably resistant to chemical attack. In some deposits, beryl crystals are found that have been partly to wholly dissolved by chemical reactions in a process called *alteration*. The new minerals derived from the constituents and released by the decomposition are called *alteration products*. The principal alteration product of beryl is kaolinite, a clay mineral, sometimes

CHEMICAL AND PHYSICAL PROPERTIES

accompanied by muscovite mica. In the vicinity of altered beryls may occur various beryllium minerals which may be present in such small crystals or earthy aggregates that they escape detection. The extensive literature on beryl alteration commenced in 1850 with an analysis of a kaolin derived from beryl by Damour.⁵⁷ Later, several analyses of altered beryls appeared in Hintze²⁴ (p. 597). The term "pseudosmaragd" was applied by Berzelius to a mineral substance resulting from alteration of a Swedish beryl which Berzelius regarded as a mixture of ordinary beryl and mica²⁴ (p. 1286). Döll⁵⁸ recorded a limonite pseudomorph of beryl and later a grayish- to celadon-green earthy material, containing pyrite and arsenopyrite, which appeared to be the alteration product of tourmaline and beryl in a Czechoslovakian pegmatite.⁵⁹

Vrba's studies of Czechoslovakian pegmatite minerals established bertrandite as an alteration product of beryl in a Pisek pegmatite⁶⁰ (pp. 194-201), while in another pegmatite at this locality he found numerous hexagonal cavities left by beryl crystals with the voids more or less filled with albite, bertrandite, and apatite, singly or together. Similar relict cavities were noted by Högbom⁶¹ in pegmatite at Moss, Norway, with fillings of straw-yellow or colorless small beryl crystals, irregularly oriented, associated with chlorite and muscovite. Machatschki⁶² found at Pisek a yellowish-green "beryl" crystal which consisted of about 30% unaltered beryl and the remainder a fine-grained aggregate of mostly yellowish muscovite and considerable bertrandite with some feldspar and quartz. He suggested that the mica had formed through liberation of silica and alumina from the beryl. Comparative analyses of the remnant beryl and an unaltered beryl from the same deposit showed essentially the same composition.

At times altered beryl crystals may be replaced by new minerals and yet retain their original crystal form. Such a process is called *pseudomorphism*, and the resulting pseudo-crystals called *pseudomorphs*. In 1932, Schaller⁶³ recorded the first bavenite pseudomorph after beryl from the original, tabular pink beryl crystal, bits of which remained in the mass in addition to euhedral crystals of bavenite in a central cavity. Phemister⁶⁴ described a beryl from Cornwall, England, that was partly replaced by chlorite, chlorite + bertrandite, and chlorite + quartz, the latter with or without bertrandite. He suggested that the first generation of beryl was followed by a second growth, plus the alteration products. Pseudomorphs of kaolinite after hexagonal prisms of beryl from Rio Grande do Norte, Brazil, some over 6 in (15 cm) long and about 4 in (10 cm) in diameter were analyzed by Kerr⁶⁵ who found 28.3% kaolinite and 71.7% beryl. Strand⁶⁶ found euclase formed from beryl in pegmatite at Iveland, Norway, and noted the association of bertrandite and a K-mica, all thought to be products of the beryl alteration.

Tennyson⁶⁷ discovered altered beryl in pegmatites at Tittling, Bavaria, as well as associated rare beryllium minerals milarite, bityite, and bavenite. Sosedko⁶⁸ described well-formed milarite crystals in a beryl pegmatite of the Kola Peninsula.



Fig. 1 Deeply etched green beryl from Riverside County, California; 138 x 43 mm (5.35 x 1.6 in). The basal face is deeply pitted, while etching has proceeded along basal cleavage cracks. William Larson Collection, Fallbrook, California.



Fig. 2 Doubly terminated crystal of very rare red beryl from Wah Wah Mountains, Utah; one of the largest and finest crystals found at the locality, measuring 26 mm (1 in) x 8 mm (0.35 in). John F. Barlow Collection, Appleton, Wisconsin.



Fig. 3 Chartreuse-colored terminated beryl crystal, almost completely transparent and flawless, showing large first-order prism faces, large basal face and several pyramidal forms. Diamantina district, Brazil; 45 x 36 mm (1.75 x 1.4 in). William Larson Collection, Fallbrook, California.

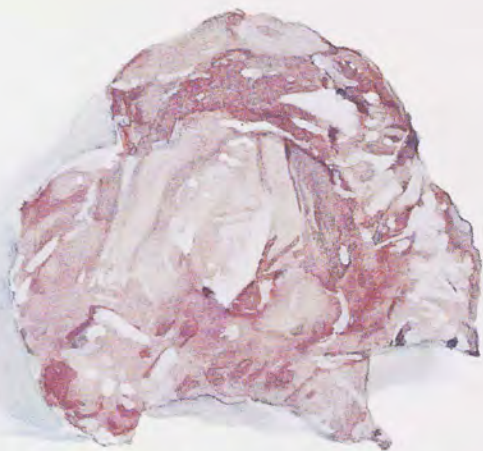

Fig. 4 Corroded mass of transparent morganite from Brazil, about 60 x 58 mm (2.3 x 2.25 in). William Larson Collection, Fallbrook, California.



Fig. 5 Emerald in mica schist matrix from Transvaal, Republic of South Africa; 90 x 75 mm (3.5 x 3 in). In the author's collection.



Fig. 6 Three transparent Brazilian beryl crystals: a pale blue aquamarine; a green beryl with etched prism faces and termination corroded into smooth, rounded surfaces; and a golden beryl partly corroded, especially along incipient basal cleavage planes. Central crystal is 77 x 24 mm (3 x 1 in). William Larson Collection, Fallbrook, California.

Fig. 7 Magnificent transparent aquamarine crystal from Adun Chilon, Transbaikalia, USSR; 123 x 33 mm (4.8 x 1.25 in). The crystal has been deeply corroded, so that all surfaces are covered with smooth etch marks and the terminations display numerous small peaks. William Larson Collection, Fallbrook, California.

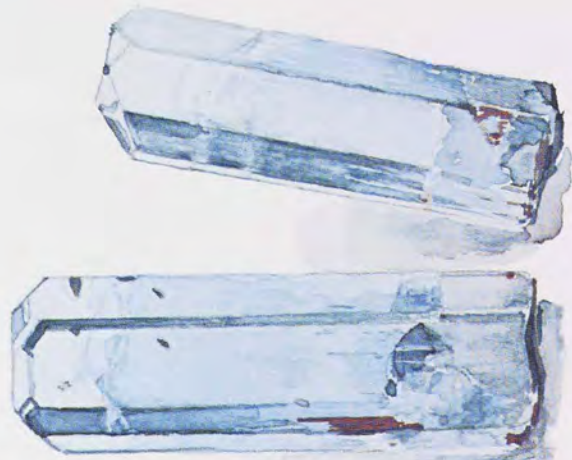

Fig. 8 Two exceptional, transparent terminated aquamarine crystals from the famous Kleine Spitzkopje locality in South West Africa; largest crystal is 54 x 19 mm (2.2 x 0.75 in). William Larson Collection, Fallbrook, California.

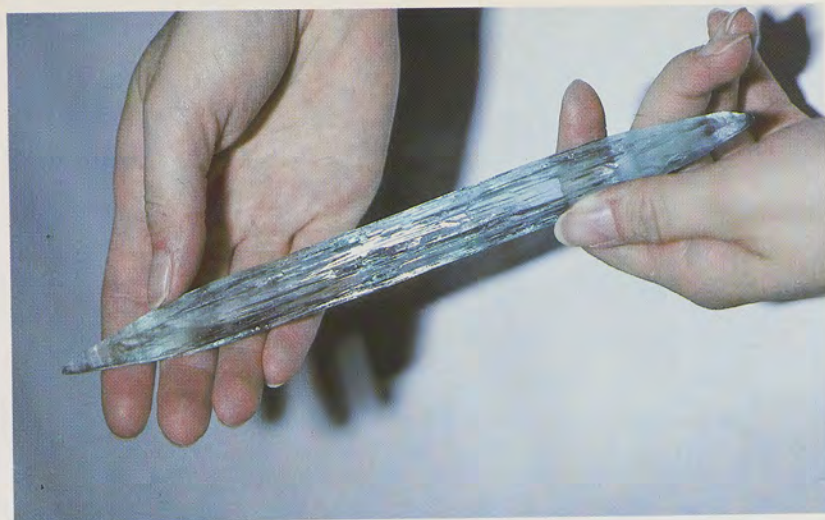

Fig. 9 Beautiful blue cigar-shaped aquamarine crystal from Minas Gerais, Brazil. Originally a larger crystal, it has naturally dissolved into the form shown here, with all surfaces covered by glistening etch figures. Julius & Miriam Zweibel Collection. *Photograph courtesy Wendell E. Wilson.*



Fig. 10 Large gems of pink morganite (left), 235 carats, from Brazil, and golden beryl (right), 134 carats, from Madagascar. In the collections of the National Museum of Natural History, Washington, D.C. *Courtesy Smithsonian Institution, Photo No. 77-14889.*



Fig. 11 Superb, doubly terminated morganite crystal from the White Queen Mine, Hiriart Hill, Pala, San Diego County, California; collection of David Wilber, Fallbrook, California. The crystal is bounded by broad faces of c {0001} with large faces of the first order prism and several pyramidal faces apparent. On cleavelandite matrix; crystal about 5 x 4.5 cm (2 x 1.75 in). *Courtesy Harold & Erica Van Pelt, Photographers, Los Angeles.*



Fig. 12 Superb morganite beryl in the Mineral Hall of the British Museum (Natural History), London. It was cut from Madagascar material and is possibly the finest example of this variety in existence. Weight, 598.70 carats; 51 x 51 mm at the girdle and 38 mm deep. Acquired in 1913. Photograph by Lee Boltin; courtesy British Museum (Natural History) and Peter G. Embrey.



Fig. 13 Cat's-eye aquamarine gem of 54.6 carats cut from Brazilian material; collections of the National Museum of Natural History, Washington, D.C. Courtesy Smithsonian Institution, Photo No. 79-420A.

Fig. 14 Transparent, almost colorless morganite crystal enclosing gem-quality green tourmaline crystals from Verdinho mine, near Itatiaia, Minas Gerais, Brazil. About 8 cm (3.2 in) wide, 4.5 cm (1.75 in) high and 2.5 cm (1 in) thick. David Eidahl Collection. Courtesy Harold & Erica Van Pelt, Photographers, Los Angeles.





Fig. 15 Greenish-golden beryl step-cut gem of 2054 carats (*left*); the largest of its kind, cut from Brazilian rough by the author. *At right*, a superb blue aquamarine step-cut gem, also Brazilian material; 911 carats. Both gems in the collections of the National Museum of Natural History, Washington, D.C. *Courtesy Smithsonian Institution, Photo No. 77-14443.*



Fig. 16 Emerald crystal with a pyrite crystal attached, from Muzo, Colombia; 2.5 cm (1 in) long. The emerald shows almost equal development of first and second order prisms. Julius & Miriam Zweibel Collection. *Photograph courtesy Wendell E. Wilson.*

Fig. 17 Fine blue transparent aquamarine crystal of 19 kg (42 lb), 59 x 38 cm (23 x 15 in) found in 1979 in Jaqueto, Bahia, Brazil; now owned by Hans Stern, Jewelers, Rio de Janeiro. All surfaces are completely etched. *Photograph courtesy Neil Letson.*





Fig. 18 Magnificent modern necklace of carefully matched and graduated step-cut emeralds and round diamond brilliants. Approximately 6 inches (15 cm) in diameter. *Courtesy Harry Winston, Inc., New York.*

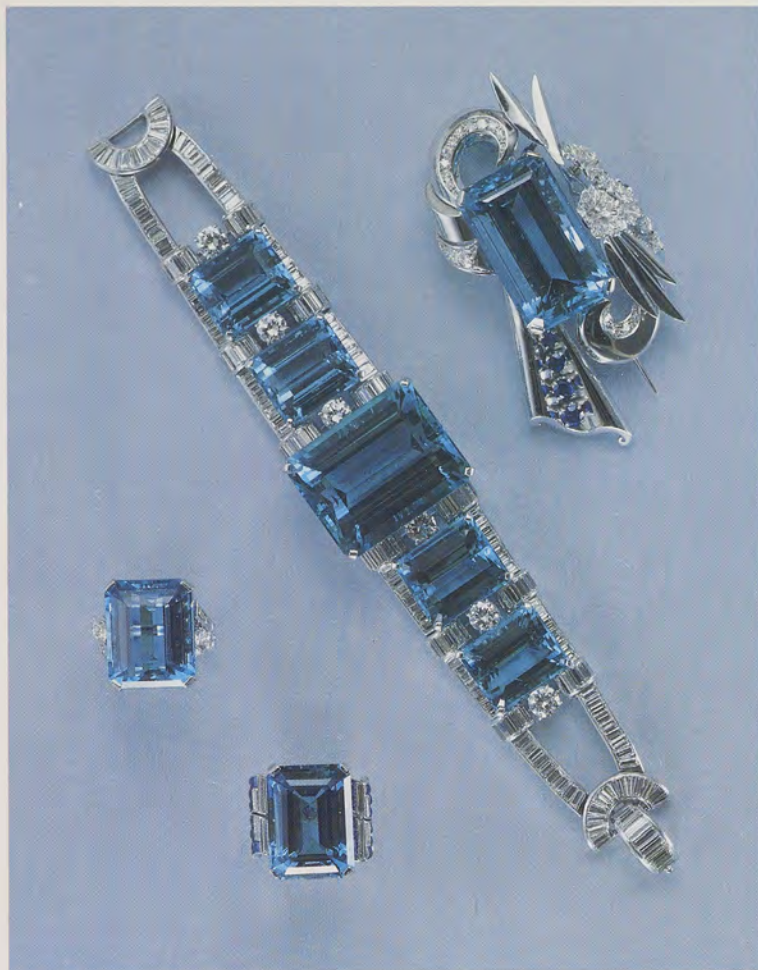

Fig. 19 The finest color grade in aquamarine gems is shown in these pieces of jewelry, auctioned at Christie's in New York City, June 11-12, 1980. *Top right:* a 70-carat step-cut gem in white gold with diamonds and sapphires, \$6,800 (Lot 275). *Center:* largest aquamarine is 84.68 carats, with four smaller gems; the bracelet is embellished with round and baguette diamonds, a Van Cleef & Arpels piece, \$41,000 (Lot 272). *Lower left:* a superb stone of 30.85 carats, with diamonds, set in a ring, \$6,800 (Lot 269). *Bottom left:* a 31.04-carat gem with diamonds, set in a ring, \$6,000 (Lot 271). *Courtesy Christie, Manson & Woods International, Inc., New York.*

Fig. 20 The Hooker emerald brooch set with a magnificent square-cut emerald of about 75 carats; now in the collections of the National Museum of Natural History, Washington, D.C. Reputedly, the stone once adorned the belt buckle of a Turkish Sultan. *Courtesy Smithsonian Institution, Photo No. 77-14194.*

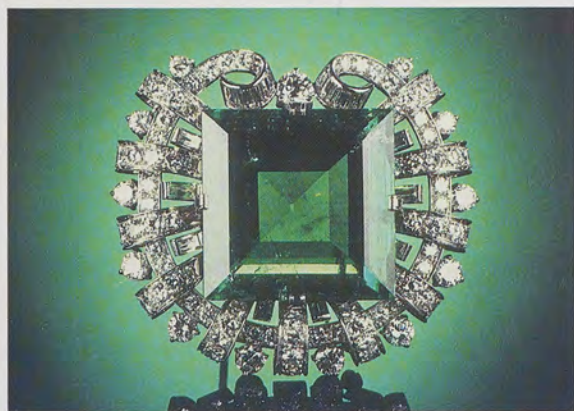



Fig. 21 The Barlowe carved emeralds in the collections of the National Museum of Natural History, Washington, D.C. These decorative objects were carved in India; the emerald at right was inlaid with gold and inset with small diamonds. *Courtesy Smithsonian Institution, Photo No. 77-10575.*

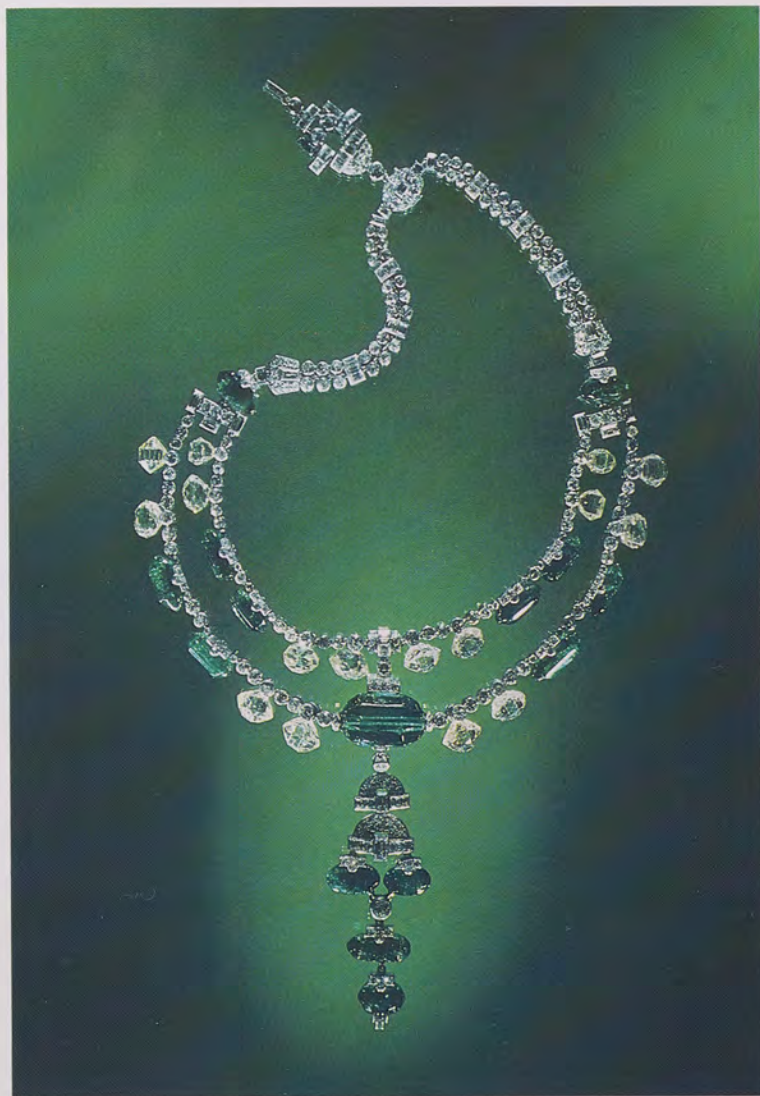

Fig. 22 Remarkable diamond and emerald necklace, dubbed "The Spanish Inquisition Necklace" from the era in which it was made. Now in the collections of the National Museum of Natural History, Washington, D.C. Astonishingly, the diamonds were bored through for suspension. The largest emerald weighs about 60 carats. *Courtesy Smithsonian Institution, Photo No. 77-10583.*



Fig. 23 Emerald jewelry recently sold at auction. *Top:* bracelet with diamonds and central carved emerald of 35 mm (1.3 in) diameter, made by Van Cleef & Arpels and Vacheron-Constantin; it fetched \$54,000 in June, 1980, in New York. *Left:* emerald and diamond bangle in white gold and platinum; \$22,000, June, 1980, in New York. *Bottom:* a spray of brilliant-cut emeralds and diamonds in gold by Tiffany, the emeralds totaling 16.98 carats; \$75,000, February, 1979, in New York. *Courtesy Christie, Manson & Woods International, Inc., New York.*



Fig. 24 Polished baroque emeralds, fashioned in India, were fastened into diamond-studded precious metal links to make this necklace; the largest is about 25 carats. Collections of the National Museum of Natural History, Washington, D.C. *Courtesy Smithsonian Institution, Photo No. 77-10588.*

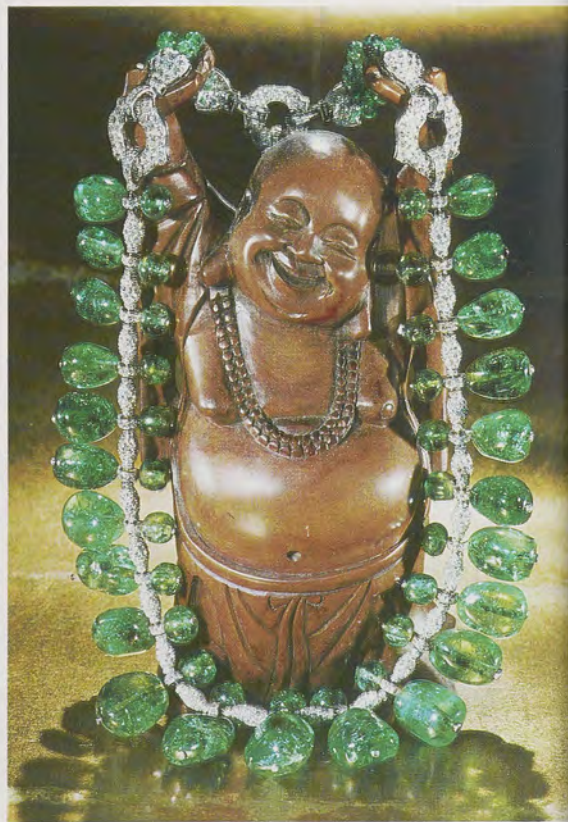

Crystal Structure and Chemical Composition of Beryl

Černý⁶⁹ found epididymite and milarite as alteration products of beryl in a desilicated pegmatite in western Moravia. Beus⁵ noted alteration of beryl and products thereof as bavenite (p. 56), bityite (p. 75), bertrandite (p. 112, commonly accompanied by euclase), beryllonite (p. 123, derived from dissolution of beryl), herderite (p. 126), and moraesite (p. 131, forming radiating fibrous masses and crusts in leached-out cavities in beryl crystals). According to Roering and Heckroodt,^{70,71} beryl alteration in the Dernberg pegmatite of South West Africa formed compact pseudomorphs consisting of glassy relicts of unaltered beryl cemented with cryptocrystalline aggregates of bertrandite and a mixed-layer clay mineral.

Gallagher and Hawkes⁷² reported chrysoberyl closely intergrown with beryl in the Miami district pegmatites of Rhodesia, as well as euclase in aggregates in massive iron-impregnated beryl in a cassiterite vein near Ankole, Uganda. They also mentioned the occurrence of hurlbutite and herderite but did not suggest that these were alteration products of beryl. However, they recorded bavenite, phenakite, and a beryllian margarite as alteration products from the Bikita district of Rhodesia.

Michele⁷³ found bavenite pseudomorphous after beryl in pegmatite near Domodossola, Italy, while Sinkankas⁷⁴ described hexagonal cavities left by beryl in blocky albite of the Rutherford No. 2 mine, Amelia, Virginia. These voids were filled with felted fibrous masses of bavenite, which also coated nearby fissures in the blocky albite. He also referenced small bertrandite crystals that had been found upon altered beryl in the dumps of this mine. A similar occurrence of bavenite in relict beryl cavities in pegmatite at Haddam, Connecticut, was recorded by Henderson.⁷⁵

In a non-pegmatite occurrence, Pavlova⁷⁶ noted phenakite and bertrandite formed from beryl in greisens and veins containing smoky quartz, muscovite, microcline, molybdenite, wolframite, and hematite, in addition to beryl. She suggested a reaction between beryl, silica, and K_2O leading to formation of phenakite and microcline, and another reaction between beryl, phenakite, silica, and K_2O resulting in formation of bertrandite and microcline.

In summary, the most abundant alteration product of beryl that has been reported is kaolinite (and other clay minerals), followed by muscovite, chlorite, margarite, and various beryllium minerals. Buchi⁵³ (p. 14) listed the following species "formed as a result of the hydrothermal alteration of beryl": chrysoberyl, faheyite, hamlinite, herderite, moraesite, wardite, quartz, albite, epistilbite, kaolinite, chlorite, muscovite, bavenite, bertrandite, euclase, phenakite, and sillimanite.

CHEMICAL DECOMPOSITION AND ANALYSIS OF BERYL

Although subject to chemical attacks in situ which may lead to partial or complete dissolution of its crystals, beryl is a remarkably resistant mineral once it attains ordinary environmental conditions. No acid, except hydrofluoric (HF), is

CHEMICAL AND PHYSICAL PROPERTIES

capable of dissolving beryl, and even HF is effective only if the mineral is finely crushed to expose as much surface area as possible. Even then, dissolution proceeds very slowly. Because of this slow rate of attack on beryl crystals, HF has been increasingly used by mineral specimen dealers to remove adhering silicate minerals, particularly clays, which often penetrate into cracks, crevices, and openings created by natural dissolution that are impossible to clean mechanically.

The earliest analytical procedures employed hot, strong solutions of ammonium carbonate or potassium hydroxide (Vauquelin, 1798), and later, potassium chloride (Berzelius, 1812). By the end of the 19th century, it had been found that beryl could be more readily attacked by HF if first heated to a high temperature to sinter the mineral and to partially drive off silica. A better method was found in grinding the beryl to powder, then mixing with a suitable flux, and strongly heating to produce either a sinter or a melt. Both were recrushed to facilitate further treatment (Parsons⁷⁷ pp. 3-4). Suitable fluxes are sodium and potassium carbonates, calcium fluoride, potassium fluoride, calcium oxide, and hydroxides of sodium or potassium. According to Parsons, "the fluorides possess the advantage in subsequent treatment, in the comparative ease of removal of the large excess of silica, but for other reasons have been seldom used." Furthermore, "under average conditions the caustic alkalies, preferably potassium hydroxide, give the most satisfactory results."

When potassium hydroxide is used, the general procedure is to crush the beryl, mix it with about its own weight of sodium or potassium hydroxide, and heat the mixture until thorough fusion results. The fused mass is then cooled, crushed, just covered with water, and strong sulfuric acid added followed by heating. This forms the water-soluble sulfates of beryllium, aluminum, iron, etc., which can be removed by leaching. Parsons's analytical procedures for beryl, regarded for many years as the authority, contain not only discussions of the various methods and evaluations of alternative methods, but also an extended bibliography and annotated analysis of beryl.

Charles H. Joy, who Parsons cites (pp. 90-2), described trials of twelve methods of decomposing beryl, including fusions with fluorides, oxides, and carbonates, attacks on finely ground beryl with acids, and passing chlorine over calcined beryl to obtain soluble chlorides of Fe, Al, and Be, but his preferred method was a fusion of beryl with two parts of potassium carbonate, followed by treatment with sulfuric acid.

Other agents for decomposing beryl have been used with success. Lemberg,⁷⁸ for example, developed a method for treating beryl with sodium silicate solution, while Copaux⁷⁹ described a fusion technique employing sodium silicofluoride. A somewhat similar method was used by Engle and Hopkins⁸⁰ and Illig et al.⁸¹ Zimmermann⁸² obtained a U. S. Patent on a process for decomposing beryl in gaseous

Crystal Structure and Chemical Composition of Beryl

HF between 100–900°C, with best results obtained at about 500–600°C, during which treatment fluorides of Be, Al, and Si were produced, with the Be-F readily soluble in water but the others not.

Sen Gupta⁸³ found that beryl was completely decomposed in a sodium fluoborate fusion at temperatures above 540°C. The melt was treated with hot water and sodium bicarbonate to precipitate fluorides of Fe and Al, while further treatment with boric acid and barium chloride produced a precipitate of barium fluoberyllate. Ferrer⁸⁴ suggested a fusion of beryl with potassium bifluoride to produce the initial decomposition. Morana and Simons⁸⁵ used sodium fluosilicate + sodium carbonate sintered with beryl to obtain the water-soluble compound sodium fluoberyllate. Several of the foregoing methods were developed for mass-production of beryllium compounds rather than for laboratory analyses of beryl.

Patkar and Varde⁸⁶ decomposed beryl by fusion with sodium fluoride, followed by treatment with sulfuric acid, then extraction in water and ethylenediamine tetraacetic acid (EDTA). Boiling the solution resulted in precipitation of beryllium ammonium phosphate. A detailed procedure for fusing beryl with potassium hydroxide and subsequent treatment with sulfuric acid to obtain soluble sulfates is described by Britton,⁸⁷ and a similar process by Buckeley.⁸⁸ Another fusion method, developed by James et al.,⁸⁹ used calcium oxide followed by attacking the melt with sulfuric acid; the beryllium is removed by precipitation with ammonium carbonate. Sawyer and Kjellgren⁹⁰ avoided fluxing with an alkali by melting powdered beryl alone, then quenching the melt with water to render the product more easily attacked by strong sulfuric acid. After sulfation, the several sulfates were removed by leaching.

A recent method for fusing beryl with anhydrous sodium carbonate with subsequent precipitation of beryllium ammonium phosphate was described by Huguet and Bamberger.⁹¹ A fusion of beryl with sodium oxide with elimination of silica is described by Huré et al.⁹² as well as the means for treating the product with ammonium acid phosphate to obtain beryllium ammonium phosphate. Brewer⁹³ described a method for determining beryllium in beryl by use of EDTA. A new volumetric method of directly precipitating a hydrous beryllium phosphate was devised by Sankar Das and Athavale.⁹⁴ Nadkarni et al.⁹⁵ separated beryllium phosphates from those of other metals by use of an ion-exchange resin.

CHEMICAL FIELD TESTS

Increasing interest in beryllium spurred development of tests designed to simply and conveniently identify beryl in the field. As early as 1867, Kenngott⁹⁶ noted that moistened powder of calcined South American emerald gave a distinctive alkaline reaction on litmus paper but that uncalcined beryl did not. A similar test was described by Stevens⁹⁷ and refined as a simple field test by Stevens and Carron.⁹⁸

CHEMICAL AND PHYSICAL PROPERTIES

This test merely requires crushing a sample in an agate mortar to form a thin aqueous slurry, then immersing the indicator paper; a reading of 6 or 7 is produced when beryl is present. However, this is merely a suggestive test, and others may be required to distinguish the suspected beryl from those minerals which may also give similar alkaline readings.

A test for beryl using the organic reagent morin, ($C_{15}H_{10}O_7 \cdot 2H_2O$) was devised by Zermatten⁹⁹ and depends for effectiveness upon production of a morin-Be complex which fluoresces clear yellow-green under UV. A blowpipe bead is made from powdered beryl and sodium carbonate, then cooled and crushed into a powder, and dissolved in dilute hydrochloric acid, to which is added a solution of morin (in methyl alcohol with some sodium hydroxide). The resulting liquid fluoresces. This method was selected by McVay¹⁰⁰ as the most promising quick field test but was modified by using either potassium bifluoride or potassium bisulfate as fluxing agents. Furthermore, the crushed beryl was sintered with one of these agents rather than melted, and the resulting frit crushed and digested with water to which a pellet of sodium hydroxide had been added to render the slurry alkaline, McVay having noted that an acidic solution failed to fluoresce. To the solution was added five to seven drops of morin (in acetone solution) and the liquid placed immediately under shortwave UV. A yellow-green fluorescence indicates that beryllium ions are present.

In another test that depends on fluorescence, Dressel and Ritchey¹⁰¹ recommended the following procedure. A small portion of beryl is crushed and fused with sodium carbonate to form a blowpipe bead, then cooled and crushed in water to which ten drops of quinalizarin-alcohol solution (either ethyl or methyl) are added. A purple or lilac color now appears, and when a drop of this solution is placed on a porcelain spot-test plate under shortwave UV, a pink to orange fluorescence signals the presence of beryllium ions.

A specific color-stain test designed to distinguish beryl from quartz and feldspar, especially when all minerals are in granular forms, was devised by Pickup.¹⁰² A finely ground sample of the ore is fused with sodium hydroxide, cooled, and digested in water. A sample of the solution is then mixed with an indicator solution of 0.02% quinalizarin and 1.0% solution of sodium hydroxide, made up freshly for each test. If beryllium is present, the test solution turns cornflower blue.

Rayner and Hall¹⁰³ devised another color test using the dye P-nitrobenzeneazo-orcinol. The beryl is crushed and fused with sodium hydroxide and then digested in water. Two drops of the dye solution are placed on filter paper, followed by one drop of 25% potassium cyanide solution. If a drop of the digested fusion liquid is now added to the center of the spot, a pink color appears which signifies the presence of beryllium. In a somewhat similar procedure, Jedwab¹⁰⁴ avoided fusion by first treating the beryl sample with sodium hydroxide solution followed by boiling

Crystal Structure and Chemical Composition of Beryl

in an alkaline solution of quinalizarin. This treatment selectively stains beryl an intense blue. The same method was adopted and refined by Ampian¹⁰⁵ and is described in detail in his paper. He explained how his method can be used to quantitatively estimate beryl in ores in which it occurs as small disseminated grains.

OTHER FIELD TESTS

The unique capability of beryllium to emit neutrons when bombarded by gamma radiation has been taken advantage of in detecting and assaying ores containing this element. A field detector, called the berylmeter, is a portable instrument which uses the isotope antimony-124 as the gamma radiation source. When placed over a granitic pegmatite outcrop, for example, the gamma rays emitted by the radioactive antimony strike atoms of beryllium in beryl (or other Be mineral) and cause emission of neutrons. A scintillometer within the instrument records the number of neutrons emitted in a given period of time. To be effective, the instrument must be placed closer than about 1.5 in (3.7 cm) to the sample. Since the count of neutrons is proportional to the amount of beryllium, it provides a quick and fairly accurate quantitative analysis.^{106,107,108}

A simple test which depends for its effectiveness on beryl having a slightly higher specific gravity than either quartz or feldspar, the species most often accompanying beryl and confused with it, involves placing small, clean samples of the minerals in a test tube filled with a heavy liquid that is lower in specific gravity at the top than at the bottom. Beryl will sink along this "diffusion column" to a lower point than either feldspar or quartz, and thus enable it to be picked out from the others. The preferred liquid is bromoform (specific gravity = 2.90), which has the additional advantage of being so close to beryl in refractive index that a small clear piece seems to disappear from view when placed in it, while both quartz and feldspar, even when fully clear, are still distinguishable.

To prepare the test, have at hand known fragments of beryl, quartz, and feldspar as "check" specimens, each not over 1/4 in (4 mm) or so in diameter. Fill a small, narrow test tube with bromoform until it is about three-quarters full. (Acetylene tetrabromide may also be used, but bromoform is preferred.) Add the three sample fragments which all will float on the surface of the liquid. Now, drop by drop, very delicately add benzene, a much lighter fluid which will diffuse downward into the bromoform and lower the specific gravity of the mixture. The test tube should be propped up at a slight angle from the vertical and should not be shaken or disturbed during diffusion. As diffusion takes place, the known beryl fragment will settle to the lowest point, the feldspar and quartz considerably above. Carefully slide in the unknown sample, suspected of being beryl, and let it settle. If it is beryl, it will come to rest alongside the known beryl test piece. If it remains near the top or sinks below the beryl, it must be some other mineral.

CHEMICAL AND PHYSICAL PROPERTIES

A similar test for gemstones is to be found in any standard book on gem testing, but Booyesen¹⁰⁹ described the above method for field use for beryl. He also noted that with bromoform one may distinguish topaz (sinks rapidly to the bottom), amblygonite and spodumene (also sinks), and petalite (floats).

Literature Cited

- Romé de l'Isle, J. B. L. 1783. *Cristallographie, ou Description des Formes . . . du Regne Minéral*. 2nd ed. 4 vols. Paris: L'Imprimerie de Monsieur.
- Häuy, R. J. 1822. *Traité de Cristallographie*. 2 vols. Paris: Bachelier et Huzard.
- Wiik, F. J. 1887. Mineralogische und petrographische Mittheilungen. *Zeitschrift für Kristallographie und Mineralogie* (Leipzig) 12; 515-7.
- Bragg, W. L., and West, J. 1926. The structure of beryl, $\text{Be}_3\text{Al}_2\text{Si}_6\text{O}_{18}$. *Proceedings of the Royal Society of London A*-111, pp. 691-714.
- Beus, A. A. 1966. *Geochemistry of Beryllium and Genetic Types of Beryllium Deposits*. Edited by L. R. Page, translated by F. Lachman. San Francisco: W. H. Freeman, 401 pp.
- Astbury and Yardley 1924. *Philosophical Transactions of the Royal Society of London A* 224:221; cited in Bragg and West, above.
- Koksharov, N. I. 1853-91. *Materialien zur Mineralogie Russlands*. Vol. 1. St. Petersburg: Carl Kray, pp. 147 ff.
- Doelter, C. 1917. *Handbuch der Mineralchemie*. Vol. 2, part 2. Dresden and Leipzig: Theodor Steinkopff, pp. 584-99.
- Schiebold, E. 1935. Vergleichende Untersuchungen an natürlichen und synthetischen Smaragdkristallen. *Zeitschrift für Kristallographie und Mineralogie* (Leipzig) Abt. A., vol. 92, pp. 435-73.
- Norrish, K. 1947. An x-ray study of West Australian beryl. *Journal and Proceedings of the Royal Society of Western Australia* 34: 1-16.
- Frank-Kamenetskii, V. A., and Sosedko, T. A. 1958. The nature of isomorphism in alkalic beryl. *Doklady Akademii Nauk SSSR, Earth Science Section* (New York) 118:193-5.
- Schaller, W. T.; Stevens, R. E.; and Jahns, R. H. 1962. An unusual beryl from Arizona. *American Mineralogist* 47:672-99.
- Grubb, P. L. C. 1964. On beryl from Western Australia. *Journal and Proceedings of the Royal Society of Western Australia* 47:51-3.
- Vorma, A.; Sahama, T. G.; and Haapala, I. 1965. Alkali position in the beryl structure. *Bulletin Commission Géologique du Finlande* 218:119-29.
- Radcliffe, D., and Campbell, F. A. 1966. Beryl from Birch Portage, Saskatchewan. *Canadian Mineralogist* 8:493-505.
- Bakakin, V. V.; Rylov, G. M.; and Belov, N. V. 1967. Correlation between the chemical composition and unit cell parameters of beryls. *Doklady Akademii Nauk SSSR, Earth Sciences Section*, (New York) 173:129-32.
- Achard, F. C. 1779. *Bestimmung der Bestandtheile einiger Edelgesteine*. Berlin: Arnold Wever. 128 pp.
- Bergman, T. 1784. *Physical and Chemical Essays*. Translated by E. Cullen. Dissertation 15 of the Earth of Gems. Vol. 2. London: J. Murray. pp. 75-119.
- Weeks, M. E. 1939. *Discovery of the Elements*. 4th rev. ed. Easton, Pa.: Journal of Chemical Education. 470 pp.
- Vauquelin, N. L. 1798. Analyse de l'aigue marine, ou béril; et découverte d'une terre nouvelle dans cette pierre. *Annales de Chimie* 26, 155-69.
- . 1800. Addition au mémoire précédent. *Journal des Mines* 7:97.
- Müller, H. 1853. Mineralanalysen. *Journal für Praktische Chemie* 58:180-85.
- Dana, E. S. 1900. *The System of Mineralogy*. 6th ed. New York: John Wiley. 1134, 75 pp.
- Hintze, C. 1897. *Handbuch der Mineralogie*. Vol. 2. Leipzig: Verlag von Veit & Comp. pp. 1271-96.
- Mellor, J. W. 1925. *A Comprehensive Treatise on Inorganic and Theoretical Chemistry*. Vol. 6. London: Longmans, Green and Co. pp. 802-8.
- Feklichev, V. G. 1963. Chemical composition of minerals of the beryl group, character of isomorphism, and position of principal isomorphous elements in the crystal structure. *Geochemistry* no. 4, 410-21.
- Deer, W. A., Howie, R. A., and Zussman, J. 1962. *Rock-Forming Minerals*. Vol. 1. London: Longmans. pp. 256-67.
- Penfield, S. L. 1884. On the occurrence of alkalis in beryl. *American Journal of Science* 28:25-32.
- Ginzburg, A. I. 1955. On the question of the composition of beryl. *Trudy Mineralogicheskogo Muzeya. Akademiya Nauk SSSR*. (Leningrad) 7:56.

Crystal Structure and Chemical Composition of Beryl

30. Wickersheim, K. A., and Buchanan, R. A. 1959. The near infrared spectrum of beryl. *American Mineralogist* 44:440-4.
31. Paré, X., and Duclos, P. 1964. Étude par résonance magnétique nucléaire de l'eau dans le béryl. *Bulletin de la Société Française de Minéralogie et Cristallographie* 87:429-33.
32. Boutin, H.; Prask, H.; and Safford, G. J. 1965. Low-frequency motions of H₂O molecules in beryl from neutron scattering data. *Journal of Chemical Physics* 42:1469-70.
33. Wickersheim, K. A., and Buchanan, R. A. 1965. Some remarks concerning the spectra of water and hydroxyl groups in beryl. *Journal of Chemical Physics* 42:1468-9.
34. Sugitani, Y.; Nagashima, K.; and Fujiwara, S. 1966. The NMR analysis of water of crystallization in beryl. *Bulletin of the Chemical Society of Japan* 39:672-4.
35. Wood, D. L., and Nassau, K. 1967. Infrared spectra of foreign molecules in beryl. *Journal of Chemical Physics* 47:2220-8.
36. ———. 1968. The characterization of beryl and emerald by visible and infrared spectroscopy. *American Mineralogist* 53:777-800.
37. Bakakin, V. V., and Belov, N. V. 1962. Crystal chemistry of beryl. *Geochemistry*, no. 5, pp. 484-500.
38. Nassau, K., and Wood, D. L. 1968. An examination of red beryl from Utah. *American Mineralogist* 53:801-6.
39. Kleeman, A. W. 1944. On the analysis of beryl from Boolcoomata, South Australia. *Transactions of the Royal Society of South Australia* 68:122-4.
40. Evans, H. T., and Mrose, M. E. 1966. Crystal chemical studies of cesium beryl. *Abstracts: Geological Society of America Meeting, 1966*, p. 63.
41. Lévy, B. 1857. Recherches sur la formation et la composition des émeraudes. *Compte Rendu de l'Académie des Sciences (Paris)* 45:877-81.
42. Leitmeier, H. 1937. Das Smaragdorkommen im Habachtal in Salzburg und seine Mineralien. *Tschermak's mineralogische und petrographische Mitteilungen (Vienna)* 49:245-368.
43. Otero Muñoz, G., and Barriga Villalba, A. M. (1948). *Esmeraldas de Colombia*. Bogota: Banco de Republica. 133 pp.
44. Simpson, E. S. 1948. *Minerals of Western Australia*. Vol. 1. Perth: Government Printer. pp. 195-207.
45. Rogers, A. F., and Sperisen, F. J. 1942. American synthetic emerald. *American Mineralogist* 27:762-8.
46. Borovik, S. A. 1941. On the content of germanium and other rare elements in topazes and beryls of the USSR. *Doklady Akademiyi Nauk SSSR (Leningrad)* 31:24-5.
47. ———. 1943. Content of Sc in beryls and some other minerals. *Doklady Akademiyi Nauk SSSR (Leningrad)* 40:125-7.
48. Neumann, H. 1961. The scandium content of some Norwegian minerals and the formation of thorveitite. *Norsk Geologisk Tidsskrift* 41:197-210.
49. Artini, E. 1915. Due minerali di Baveno contenenti terre rare: weibyite e bazzite. *Rendiconti della Reale Accademia dei Lincei (Rome)* ser. 5, vol. 24, pp. 313-9.
50. Huttenlocher, H.; Hügi, T.; and Nowacki, W. 1954. Röntgenographische und spektrographische Untersuchungen am Bazzit. *Schweizerische Mineralogische und Petrographische Mitteilungen* 34:501-4.
51. Nowacki, W., and Phan, K. D. 1964. Composition quantitative de la bazzite de Val Strem (Suisse) déterminée par la microsonde électronique de Castaing. *Bulletin de la Société Française de Minéralogie et de Cristallographie* 87:453.
- 51a. Chistyakova, M. B.; Moleva, V. A.; and Razmanova, Z. P. 1966. [The first find of bazzite in the U.S.S.R.]. *Doklady Akademiyi Nauk SSSR (Leningrad)* 169:1421-24.
- 51b. Stalder, H. A. 1978. Alte und neue Mineralfunde aus dem Wallis. *Schweizer Strahler (Bern)* vol. 4, no. 9, 374-84.
- 51c. Hänni, H. A. 1980. Mineralogische und mineralchemische Untersuchungen an Beryll aus alpinen Zerrklüften. *Inaugural Dissertation, University of Basel*, Basel. p. 69.
52. Feklichev, V. G., and Razina, L. S. 1964. [On phosphiferous beryl]. *Mineraly SSSR* 15:247-50.
53. Buchi, S. D. H. 1962. Studies on the natural history of beryl. Ph.D. dissertation, University of Michigan, Ann Arbor. 170 pp.
54. Strutt, R. 1908. [Helium in beryl]. *Le Radium* 5:202.
55. Piutti, A. 1913. L'elio nei minerali di glucino. *Atti della Reale Accademia de Lincei (Rome)* 22:140-5.
56. Vlasov, K. A., ed. 1966. *Geochemistry and Mineralogy of Rare Elements and Genetic Types of their Deposits*. Vol. 2. Jerusalem: Israel Program for Scientific Translations. pp. 67-169.
57. Damour, A. 1850. Notice et analysis sur un kaolin produit par la décomposition du béryl. *Bulletin de la Société Géologique de France* ser. 2, vol. 7, p. 224.
58. Döll, E. 1880. Notizen über Pseudomorphosen. *Zeitschrift für Kristallographie und Mineralogie (Leipzig)* 4:101.
59. ———. 1888. Ueber einen Riesenpegmatite bei Pisek. *Zeitschrift für Kristallographie und Mineralogie (Leipzig)* 13:629-30.
60. Vrba, C. 1889. Mineralogische Notizen: IV. *Zeitschrift für Kristallographie und Mineralogie (Leipzig)* 15: 194-212.

CHEMICAL AND PHYSICAL PROPERTIES

61. Högbom, A. G. 1897. Beryll als Neubildung in einer Pseudomorphose nach Beryll. *Zeitschrift für Kristallographie und Mineralogie* (Leipzig) 28:506.
62. Machatschki, F. 1926. Mineralogische Notizen. *Zeitschrift für Kristallographie und Mineralogie* (Leipzig) 63:457-65.
63. Schaller, W. T., and Fairchild, J. G. 1932. Bavenite, a beryllium mineral pseudomorphous after beryl, from California. *American Mineralogist* 17:409-22.
64. Phemister, J. 1940. Note on an occurrence of bertrandite and beryl at the South Crofty mine, Cornwall. *Mineralogical Magazine* (London) 25:573-8.
65. Kerr, P. F. 1946. Kaolinite after beryl from Alto do Giz, Brazil. *American Mineralogist* 31:435-42.
66. Strand, T. 1953. Euclase from Iveland, occurring as an alteration product of beryl. *Norsk Geologisk Tidsskrift* 31:1-5.
67. Tennyson, C. 1960. Berylliummineralien und ihre pegmatitische Paragenese in der Graniten von Titting/Bayerischer Wald. *Neues Jahrbuch für Mineralogie* (Stuttgart) Abh. 94, pp. 1253-65.
68. Sosedko, T. A. 1961. An occurrence of milarite on the Kola Peninsula. *Doklady Akademii Nauk SSSR, Earth Sciences Section* (New York) 131:643-6.
69. Černý, P. 1963. Epididymite and milarite—alteration products of beryl from Věžná, Czechoslovakia. *Mineralogical Magazine* (London) 33:450-7.
70. Roering, C., and Heckroodt, R. O. 1964. The alteration of beryl in the Dernberg pegmatite, Karabib, South West Africa. *Annual Report, Geological Survey of South Africa* 3:133-7.
71. Heckroodt, R. O., and Roering, C. 1965. A high-aluminous chlorite-swelling chlorite regular mixed-layer clay mineral. *Clay Minerals* 6:83-9.
72. Gallagher, M. J., and Hawkes, J. R. 1966. Beryllium minerals from Rhodesia and Uganda. *Geological Survey of Great Britain Bulletin* 25, pp. 59-75.
73. Michele, V. de. 1966. Sulla presenza del berillo a Baveno. *Atti, Società Italiana di Scienze Naturali* (Milan) 105:398-403.
74. Sinkankas, J. 1968. Classical mineral occurrences. Part 1. Geology and mineralogy of the Rutherford pegmatites, Amelia, Virginia. *American Mineralogist* 53:373-405.
75. Henderson, W. A. 1970. Bavenite from Connecticut. *Mineralogical Record* (Bowie, Md.) 1, no. 2, p. 71.
76. Pavlova, I. G. 1965. Formation of phenakite from beryl in potassium metasomatism. *Doklady Akademii Nauk SSSR* 162:147-50.
77. Parsons, C. L. 1909. *The Chemistry and Literature of Beryllium*. Easton, Pa.: Chemical Publishing Co. 180 pp.
78. Lemberg, J. T. 1892. Zur mikrochemischen Untersuchung einiger Minerale. *Zeitschrift der deutschen geologische Gesellschaft* 44:224-42.
79. Copaux, H. 1919. [Determination of Be in beryl]. *Compte Rendu de l'Academie des Sciences* (Paris) 168:610-2.
80. Engle, E. A., and Hopkins, B. S. 1924. Extraction of beryllium from beryl. *Engineering and Mining Journal Press* 118:49-50.
81. Illig, K.; Hosenfeld, M.; and Fischer, H. 1929. Decomposition of beryl and preparation of beryllium salts suitable for electrolysis. *Wissenschaftlichen Veröffentlichungen Siemens-Konzern* 8, no. 1, pp. 30-41.
82. Zimmermann, M. 1932. Decomposing beryl. U. S. Patent No. 1,851,476, March 29, 1932.
83. Sen Gupta, A. K. 1956. A new rapid method for the estimation of beryllium in beryl. *Science & Culture* (Calcutta) 21:687-8.
84. Ferrer, A. A. 1958. Rapid determination of beryllium in beryl. *Proceedings of the Second U. N. International Conference on the Peaceful Uses of Atomic Energy* (Geneva) Sessions E-6, E-7a, pp. 598-600.
85. Morana, S. J., and Simons, G. F. 1962. Beryllium extracted by the fluoride process. *Journal of Metals* 14:571-4.
86. Patkar, A. J., and Varde, M. S. 1964. Rapid determination of beryllium in beryl by homogeneous precipitation. *Indian Journal of Chemistry* 2:123-4.
87. Britton, H. T. S. 1922. The extraction of beryllium from beryl. *Journal Soc. Chem. Ind.* 41:349-52.
88. Buckeley, A. 1939. Decomposition of beryl with alkali sulfates. *Metall. u. Erz* 36:584-5.
89. James, C.; Fogg, H. C.; and Coughlin, E. D. 1931. Decomposition of beryl and the preparation of beryllium salts suitable for electrolysis. *Industrial and Engineering Chemistry* 23:318-20.
90. Sawyer, C. B., and Kjellgren, B. R. 1938. Newer developments in beryllium. *Industrial and Engineering Chemistry* 30:501-5.
91. Huguet, J. L., and Bamberger, C. L. 1958. Rapid determination of beryllium in beryl mineral. *Proceedings of the Second U. N. International Conference on the Peaceful Uses of Atomic Energy* (Geneva) Sessions E-6, E-7a, pp. 595-7.
92. Huré, J.; Kremer, M.; and Le Berquier, F. 1952. Rapid gravimetric determination of beryllium in beryl. *Analytica Chimica Acta* (Amsterdam) 7:37-41.
93. Brewer, P. I. 1952. The determination of beryllium in beryl by means of ethylenediamine tetraacetic acid. *Analyst* 77:539-41.
94. Sankar Das, M., and Athavale, V. T. 1955. A rapid volumetric method for the determination of beryllium in beryls and associated minerals. *Analytica Chimica Acta* (Amsterdam) 12:6-12.
95. Nadkarni, M. N.; Varde, M. S.; and Athavale,

Crystal Structure and Chemical Composition of Beryl

- V. T. 1957. The separation of beryllium from iron, aluminum and titanium by ion exchange, and its application to the analysis of beryl. *Analytica Chimica Acta* (Amsterdam) 16:421-5.
96. Kennigott, A. 1867. [Experiments on powdered emerald to determine alkaline reactions of residue]. *Neues Jahrbuch für Mineralogie*, p. 780.
97. Stevens, R. E. 1934. Studies on the alkalinity of some silicate minerals. *U. S. Geological Survey Professional Paper* 185-A. 13 pp.
98. Stevens, R. E., and Carron, M. K. 1948. Simple field test for distinguishing minerals by abrasion pH. *American Mineralogist* 33:31-49.
99. Zermatten, H. L. J. 1933. A reaction for beryllium in minerals and rocks. *Proceedings, Section of Science, Koninklijke Akademie van Wetenschappen te Amsterdam* 36:899-900.
100. McVay, T. N. 1960. Field test for beryllium minerals: the morin fluorescent method. *U. S. Bureau of Mines Reports of Investigation* 5620. 10 pp.
101. Dressel, W. M., and Ritchey, R. A. 1960. Field test for beryllium. *U. S. Bureau of Mines Information Circular* 7946. 5 pp.
102. Pickup, R. 1951. A chemical test for distinguishing beryl from quartz or felspar. *Colonial Geology and Mineral Resources* (London) 2:129-31.
103. Rayner, E. O., and Hall, L. R. 1955. The felspar-beryl-mica deposits of the Egebek area Broken Hill. *Annual Report, New South Wales Department of Mines for 1949*, pp. 73-9.
104. Jedwab, J. 1957. Coloration of the surface of beryl. *Bulletin de la Société Belge de Géologie*. 66:133-6.
105. Ampian, S. G. 1962. A preferential stain for beryl. *U. S. Bureau of Mines Reports of Investigation* 6016. 4 pp.
106. Milner, G. W. C., and Edwards, J. W. 1959. The determination of beryllium by the photoneutron method. *Atomic Energy Research Establishment Report R-2965* (Harwell) 21 pp.
107. Brownell, G. M. 1959. A beryllium detector for field exploration. *Economic Geology* 54:1103-14.
108. Bowie, S. H. U.; Bisby, H.; Burke, K. C., and Hale, F. H. 1960. Electronic instruments for detecting and assaying beryllium ores. *Bulletin of the Institution of Mining and Metallurgy*. (London) no. 641, pp. 345-59.
109. Booyesen, B. 1959. Pegmatites: hints to prospectors. *Geological Survey of South Africa Information Pamphlet* 6. 57 pp.
110. Rossman, G. R. 1981. Color in gems: the new techniques. *Gems & Gemology* 17:60-71.

CHAPTER

6

PHYSICAL PROPERTIES

BERYL is one of the most durable of all minerals. When released from its place of formation it persists virtually unchanged in the outcrops of its deposits or in the soils and gravels into which it is carried. In the stream gravels of Brazil, for example, large numbers of crystals have been found that retain traces of crystal faces despite prolonged chemical attack and abrasion with other stones. Such resistance is attributable to the crystalline structure and the strength of the bonds which retain the atoms in position.

FRACTURE AND CLEAVAGE

Although brittle, beryl is considerably tougher than either quartz or topaz, minerals with which beryl is commonly found in alluvial deposits. Fracture surfaces are usually brilliant, smooth, and conchoidally curved like freshly broken glass. To the trained eye, the brilliance of the fresh fracture surfaces as compared to those of quartz (which tends to present a somewhat greasy luster) helps to identify this mineral. In crystals containing numerous inclusions, usually parallel to the prism faces and *c*-axis, the fracture surfaces across the prisms tend to be fine-granular in texture and somewhat oily in luster. Fractures parallel to prism faces, on the other hand, seem to glitter in numerous long striplike reflections from the surfaces of the exposed inclusion cavities.

Unlike ordinary fracture, *cleavage* in mineralogy is used to designate a special kind of rupture: that caused by planes of weakness in the crystal structure itself, perhaps best seen in crystals of mica which can be easily split into many extremely

Physical Properties

thin sheets. Because of its compact structure, beryl can be cleaved with some measure of certainty only between the rings shown in figure 5-2. Such a cleavage, generally indistinct and interrupted, is therefore parallel to the basal plane and has been recognized since antiquity. Tagore¹ (vol. 1, p. 412) remarked, for example, that "the Emerald can be cloven at right angles to its axis" and that "advantage of this is taken by the Indians, in whose ornaments flat stones of large size are often seen, -simply on this account." Here Tagore refers to the partly developed basal cleavages which are so prominent a feature in many large Colombian emerald crystals. But they also occur in the Egyptian crystals and led to their use in beads. The development of basal cleavages in large emeralds also led to the employment of the flat sections in the typical engraved plaques of Mogul jewelry.

Basal cleavage is observed more commonly in emeralds from schist-type deposits where long, prismatic crystals are broken up by movements of the enclosing rock. (See color figure 5, emerald crystals from South Africa.) Similar segmented crystals, broken and displaced for the same reason, are commonly found in pegmatites. In contrast, crystals found in pockets or vugs seldom display cleavages and therefore provide the most perfect specimens. In addition to emerald, beryls in which several color phases occur within the same crystal, such as aquamarine and morganite, commonly display cleavages due to strains set up between them because of slightly differing cell dimensions in the two varieties.

The basal cleavage may be prominent due to splitting along plate-like inclusions grown parallel to the basal (terminal) plane, as is the case in the "brown" beryl of Brazil whose body color is actually aquamarine but whose obvious brown color is imparted by numerous minute plates of ilmenite. When cut as cabochons with their bases parallel to the basal plane, a semi-metallic luster and a six-legged star results. Other beryl crystals may also display a similar reflectance from this plane due either to solid inclusions, sometimes of hematite, or to very thin cavities containing gas or liquid.

Another cleavage plane, parallel to the prism faces of $m\{10\bar{1}0\}$ * was described by Lane,² who found it to be more common than previously supposed. He described it as "distinct," and "about as good as that of nephelite." In this connection, Lehmann³ plunged heated beryls into cold water to study fracture patterns and found that many imperfect cracks developed parallel to the basal plane and many others appeared parallel to the prism faces. Similar fracture-cleavage patterns commonly occur in the beryl crystals "frozen" in pegmatites and tend to break up the crystals into large numbers of closely interlocked cuboid fragments. Reflections from these surfaces sometimes impart a pearly luster, especially on the basal plane.

A common belief among emerald miners in Colombia is that basal cracks

*See Chapter 9 for an explanation of the Bravais-Miller notation for crystal faces.

CHEMICAL AND PHYSICAL PROPERTIES

develop soon after crystals are taken from the ground. Pogue,⁴ for example, stated that "the flaws or internal cracks . . . are not always present in the freshly mined stones, but if not they almost invariably develop soon after the specimen is removed from the enclosing rock, a result presumably caused by the strained condition of crystallization." Olden,⁵ on the other hand, was firmly of the opinion that there was no basis in fact for such spontaneous decrepitation. There seems to be no reason to assume that any abrupt change in either temperature or pressure conditions occurs when these emeralds are mined, inasmuch as they are found near the surface and in many cases not even solidly enclosed in rock. The most likely explanation is that previously developed cracks were merely filled with water which rendered the crystals seemingly crack-free at the moment of exhumation but allowed these cracks to become visible when the water evaporated.

HARDNESS

The classical hardness assigned to beryl on the Mohs scale is 7.5–8. Auerbach⁶ tested beryl and other minerals by indenting the specimens with a diamond point, and he reported the load in kilograms per mm². For beryl this proved to be 588 kg/mm². Lebedeva⁷ also tested indentation hardness of thirty beryl specimens and found values between 933 and 1,410 kg/mm², equivalent to 6.8 to 8.0 on the Mohs scale. Crystals containing alkalis appeared less hard as alkali content increased. The hardness of prism faces was substantially higher than that measured on the basal plane, and, as was expected, clear crystals proved to be harder than turbid ones. Indentation hardness was also determined by Tzchorn⁸ and by Gallagher,⁹ the latter finding on eight specimens of beryl an average Vickers hardness number, in kg/mm², of about 1,300. The range fell between Vhn $1,190 \pm 80$ and $1,450 \pm 70$. Again, the hardness of prism faces exceeded that of basal faces.

As a means of discriminating beryl from quartz, especially in granitic pegmatites where these two species commonly grow side by side, hardness is of little value, quartz at H 7 on the Mohs scale being so close to beryl that no test would be convincing.

ELASTICITY AND COMPRESSIBILITY

Thin sections of beryl have been tested for resistance to deflection and twisting, and the necessary loads determined. Results are conveniently summarized in Hintze¹⁰ (vol. 2, p. 1277) and in Mellor¹¹ (vol. 6, p. 805). Early tests were conducted by Voigt,¹² Auerbach,¹³ and Madelung and Fuchs,¹⁴ using apparatus and methods described in Tutton¹⁵ (vol. 2, pp. 1334–64).

Voigt found the coefficient of elasticity to differ according to the crystallographic direction. For directions of 0°, 45°, and 90° to the *c*-axis, the coefficients were 21,650, 17,960, and 23,120 kg/mm² respectively and the modulus of torsion, parallel and perpendicular to the *c*-axis, were 6,666 and 8,830 kg/mm² respectively.

Physical Properties

He found the coefficient of compressibility to be seventy times smaller than water.

Bridgman¹⁶ noted that beryl has a negative temperature coefficient of linear compressibility parallel to the *c*-axis, while the cubic compressibility is 5.33×10^{-7} for gem-quality beryls from Mursinka, Urals and from Topsham, Maine. This value is considerably less than the 5.7×10^{-7} obtained by Madelung and Fuchs¹⁴ for a Brazilian beryl and Voigt's value of 7.4×10^{-7} obtained on a Siberian beryl. Birch¹⁷ determined elastic constants on beryl and found the modulus of elasticity, in 10^{11} dynes/cm², to be 21.8 in the direction parallel to the *c*-axis and 21.9 for the direction at right angles to it.

THERMAL EXPANSION

Fizeau¹⁸ devised an extremely sensitive apparatus for measuring thermal linear expansion of crystals, and for beryl he found that a contraction occurred along the *c*-axis with a rise in temperature while an expansion occurred along the lateral axes. The amount of change is extremely small, at 40°C the coefficient of expansion being only -0.0000106 for *c* and $+0.00000137$ for the lateral axial directions. Benoit¹⁹ determined similar results on beryl. Geller and Insley²⁰ plotted thermal expansions for beryls in microns/meter versus temperature. They showed that, on two specimens, the expansion along the lateral axial directions was on the order of 125 microns/meter from 25–100°C, while for several other beryls, the expansion along the *c*-axis was considerably less in the same temperature range. Two of these specimens actually contracted slightly in this direction until a temperature of 60°C was reached for one, and a little over 100°C for the other. Other data appear in Hintze¹⁰ and Mellor,¹¹ the latter providing numerous references to the literature.

In addition to discussing the apparatus and methods for measurement of thermal expansivities, Tutton¹⁵ (vol. 2, p. 1329) also provided a comparative table of coefficients of thermal expansion for a number of minerals. From this table it can be seen that in terms of minimum linear expansion, beryl ranks behind only diamond and ahead of topaz and corundum. However, corundum displays less difference between its expansions along the *c*- and *a*-axes directions than does beryl. The extremely minute changes in dimensions experienced by diamond and corundum explain why these gems can be safely left in their jewelry mountings while undergoing repair involving strong heat. In contrast, the linear coefficient of expansion along the *c*-axis in quartz is almost five times as much as in beryl and along the lateral axes, almost fifteen times; thus the danger of heat-breakage in quartz is much greater than in beryl, and vastly greater than in diamond or corundum.

THERMAL CONDUCTIVITY

The conduction of heat in beryl is not uniform and, as may be expected, it is related to crystallographic directions. This was demonstrated by Jannettaz,²¹ who found that if conductivity along the *c*-axis is taken as unity, conductivity along the

CHEMICAL AND PHYSICAL PROPERTIES

lateral axes is 0.90 (later modified by him to 0.92).²² A recent study of thermal conductivity in beryl showed that with increasing temperature, a slight but increasing thermal conductivity occurs.²³

A convenient table of recently established thermal conductivities appeared in *Handbook of Chemistry and Physics*²⁴ (p. E-5), in which they are stated in terms of BTU versus time and area. The conductivity of beryl along the *c*-axis is shown to be about one-fourth greater than along the lateral axes. Conductivity along *c* increases slightly with rise in temperature, but in the lateral directions, it remains constant from 100° to 300°F.

Tutton¹⁵ (vol. 2, pp. 1297–1301) not only explained the apparatus and methods for measuring conductivities, but also (pp. 1292–7) showed how the rates of conduction along several crystallographic directions could be visually demonstrated. A thin plate of the mineral is coated with wax and a hot metal point touched to its center, upon which the heat radiating outward melts the wax. In the case of beryl, the melt figure is nearly circular on a plate cut across the *c*-axis but elliptical on a plate cut parallel to that axis, with elongation of the ellipse along *c*.

SPECIFIC HEAT

Specific heat is the ratio of how much heat can be stored in a substance compared to water at the standard temperature 15°C. Several researchers have measured the specific heat of beryl. Öberg²⁵ found an average of 0.1979, while Joly²⁶ found 0.2066 for a transparent crystal and 0.2127 for a translucent crystal, the latter presumably containing water in its inclusions and therefore capable of absorbing more heat.

THERMAL DESTRUCTION

In a detailed study of optical properties of beryl, Böse²⁷ tested fifteen crystals to determine decrepitation ('Zerfall') temperature. As may be expected, aquamarine crystals of greatest internal perfection and freedom from inclusions withstood the highest temperatures, one specimen reaching 1200°C before cracking. However, the majority of aquamarines began to crack at 1000°C. Rose beryls were less able to withstand heating; one specimen from Rincon, California, shattered between 800–840°C, while another from Madagascar cracked at about 900°C.

Relatively poor resistance was noted in emeralds, no doubt due to the presence of inclusions. A dark emerald from Leysdorp, South Africa, for example, cracked at under 700°C, while another from the same deposit resisted a somewhat higher temperature. A Uralian emerald withstood cracking up to a little over 800°C. Weighings of specimens between tests showed steady losses, probably due to loss of channel water.

Physical Properties

MELTING POINTS AND MELTS

Subjecting a thin splinter of beryl to the mineralogist's blowpipe flame results in no more than slight rounding of the sharp edges. Accordingly, in the fusibility scale which begins with stibnite (no. 1) and ends with quartz (no. 7), whose melting point is over 1,700°C, beryl is given a position between 5 and 5.5. Brun²⁸ determined a melting point for beryl from Limoges, France, of between 1410° and 1430°C. Miller and Mercer²⁹ found that in heating beryl, a sinter formed first at about 1300°C, with small quantities of liquid developing at 1460°C and major melting taking place at about 1475°C. However, a clear melt could not be obtained until the temperature exceeded 1600°C. Beryl decomposed between 1475° and 1600°C and it was established that phenakite, chrysoberyl, and beryllium oxide had transiently formed. They concluded that phenakite + liquid formed at onset of beryl melting, then, as temperature increased, the phenakite decomposed and chrysoberyl + liquid formed, the latter decomposing in turn to beryllium oxide + liquid before finally melting into a clear liquid. These results are consistent with the fact that three strong structural bonds must be broken during melting, namely, those between Si-O, Al-O, and Be-O.

Riebling and Duke³⁰ attempted to prepare homogeneous beryl glass by melting pure BeO, Al₂O₃, and SiO₂ but without success, obtaining two-phase liquids whose boundaries were detectable in electron micrographs of the cooled melts. Munson³¹ attempted to melt beryl under high pressures and found that between 15 and 50 kilobars, the decomposition products were silica, phenakite, and chrysoberyl. He claimed to have obtained clear beryl glass when a melt in excess of 2000°C was quenched at a pressure somewhat over 45.5 kbars, but quenching at lower temperatures resulted in the formation of crystalline silica with minor amounts of phenakite and chrysoberyl. At lower temperatures and pressures, some partial recrystallization of beryl took place from the melt.

The above results, coupled with the difficulties in the experimental procedures, strongly suggest that all so-called "beryl" glasses claimed in years past to have been manufactured from melted beryl are actually mixtures of the components named, that is, quartz, phenakite, chrysoberyl, and possibly beryllium oxide. This also explains why the Verneuil flame-fusion process which works so well in the synthesis of corundums, spinels, and other minerals, has not been used for beryl. These matters are discussed at greater length in Chapter 11.

ELECTRICAL AND MAGNETIC PROPERTIES

Beryl is a non-conductor of electricity. Its dielectric constant (resistance to the passage of current) was found by Curie³² to be 6.24 parallel to the *c*-axis and 7.58 in the direction perpendicular to that. Fellingner³³ determined corresponding values of 6.076 and 7.023, while Takubo³⁴ obtained 5.67 and 6.17–6.18.

CHEMICAL AND PHYSICAL PROPERTIES

An electrical charge developed by heating (pyroelectricity) is best known in tourmaline, but Hankel³⁵ claims it occurs in beryl, although very weakly. He discovered positive charges on basal planes of Russian beryl crystals and negative charges on prism faces, but the results were not consistent, especially in the case of Elba beryls, which acquired positive charges on some areas of the prism faces instead of the expected negative charges. These crystals presented no external features to which this anomalous behavior could be attributed.

The movement of a beryl crystal suspended by a thread between the poles of a magnet was studied by Knoblauch.³⁶ Plücker³⁷ found beryl to be paramagnetic negative, with the *c*-axis direction corresponding to the direction of least magnetic induction. Voigt and Kinoshuto³⁸ investigated the magnetic susceptibility of beryl and confirmed its paramagnetic nature.

Maser activity, or "microwave amplification by stimulated emission of radiation," has been obtained in emerald and is due to the presence of the Cr³⁺ ion.³⁹

DENSITY AND SPECIFIC GRAVITY

By extrapolation of Fizeau's tables of coefficients of thermal expansion, Panebianco⁴⁰ concluded that beryl would attain maximum density at a temperature of -4.7°C. Bragg and West⁴¹ calculated the density of ideal beryl as 2.661, while Norrish⁴² (p. 10) calculated the figure to be 2.64 and Radcliffe and Campbell⁴³ cited a figure of 2.62.

Specific gravities, calculated as ratios of given weights of beryl to equal weights of water under standard conditions, range generally between 2.6-2.8 as given in Hintze¹⁰ (p. 1272), 2.6-2.7 in Doelter⁴⁴ (p. 593) and 2.6-2.9 in Mellor¹¹ (p. 805). Doelter (p. 597) reproduced a table of specific gravities for thirty beryls as determined by Piutti⁴⁵ which shows a range of 2.628-2.886. Another list for twenty-five beryls appeared in Böse²⁷ (p. 502), giving a range of 2.660-2.877, with the lowest values for aquamarines and yellow beryls, moderate to high values for emeralds, and the highest of all to pink beryls.

The progressive increase in specific gravity with increase in alkali content is shown by Ford⁴⁶ and by Lacroix and Rengade.⁴⁷ A convenient plot of specific gravity against alkali content for numerous beryls appeared in Deer, Howie, and Zussman⁴⁸ (vol. 1, p. 262) and shows a steady rise from 2.66 for alkali-free beryl to about 2.77 for beryls containing about 28 mol % of alkalis. Lacroix⁴⁹ determined specific gravities on numerous Madagascar beryls and found the range to be 2.707-2.910, and noted that differences in value can be obtained from different parts of the same crystal. In general, those beryls obtained from muscovite-rich pegmatites are lower in specific gravity than those obtained from the lithium-bearing bodies.

In regard to gem beryls, especially in cut form, Webster⁵⁰ (pp. 85-102) pro-

Physical Properties

Table 6-1
SPECIFIC GRAVITIES OF BERYLS

Theoretical values, pure $\text{Be}_3\text{Al}_2\text{Si}_6\text{O}_{18}$	2.62 to 2.661
Maximum reported range	2.628 to 2.910
Aquamarine range	2.628 to 2.730
Emerald range	2.670 to 2.780
Alkali beryl range	ca. 2.800 to 2.910

vides values for specific gravity in the broad range of 2.68–2.90, with the following sub-ranges: aquamarine, 2.68–2.73, with an exceptional value of 2.80 for Maxixe blue beryl from Brazil; emerald, 2.69–2.78, measured on thirteen specimens from as many different localities; pink and white beryls, 2.80–2.90, with an exceptionally low value of 2.71 for one specimen. Böse²⁷ gave eight emerald values from 2.703 to 2.759. Vogel⁵¹ examined thirteen emeralds from Columbia, Brazil, Urals, Habachtal, and Leysdorp and found values between 2.670 and 2.746, with the lowest for emeralds from Bom Jesus Dos Meiras, Brazil, and highest for emerald of Habachtal, Austria. However, an even higher value for a Habachtal emerald, namely 2.780, was determined by Jakob.⁵²

Numerous emerald specimens from world-wide localities were also examined by Gübelin⁵³ (p. 114), who found a general range of 2.67 to 2.78, with the lowest values of 2.67–2.70 for Brazilian specimens and 2.69–2.71 for Colombian emeralds, while the highest value of 2.75–2.78 occurred in Pakistan emeralds. Barriga Villalba⁵⁴ found values for Colombian emeralds to be 2.5664 for a “slightly green” specimen to 2.6890 for a “pure” dark green emerald; a specimen with numerous filamental inclusions, or “very jardin,” gave 2.6769.

The estimation of specific gravities of various minerals in the field by “hefting” or feeling the weight of a specimen in the hands is not useful in distinguishing beryl from its common and very similar associate quartz (specific gravity, 2.65), but is useful in the case of topaz, which at 3.54 is decidedly heavier. Methods for determining specific gravity are given in almost all standard mineralogical and gemological texts, such as Webster.⁵⁰ A method of distinguishing small fragments of beryl from similar-looking quartz, feldspar, topaz, etc., by use of a “diffusion column” in a heavy liquid was explained at the end of Chapter 5.

Literature Cited:

1. Tagore, S. M. 1879. *Mani-Mála, or a Treatise on Gems*. 2 vols. Calcutta: Stanhope Press. 1046 pp.
2. Lane, A. C. 1918. Prismatic cleavage in beryl. *American Mineralogist* 3:47.
3. Lehmann, J. 1886. Contractionsrisse an Krystallen. *Zeitschrift für Kristallographie und Mineralogie* (Leipzig) 11:608–12.
4. Pogue, J. E. 1916. The emerald in Spanish America. *Pan-American Union Bulletin No. 43*, pp. 706–20.
5. Olden, C. 1911. Emeralds: their mode of occurrence and methods of mining and extraction in Colombia. *Transactions of the Institute of Mining and Metallurgy* (London) 21:194–209.

CHEMICAL AND PHYSICAL PROPERTIES

6. Auerbach, F. 1896. Die Härtescala in absolutem Masse. *Annalen der Physik und Chemie* (Leipzig) ser. 3, vol. 58, pp. 257–80.
7. Lebedeva, S. I. 1963. [Microhardness of beryl crystals]. *Trudy Instituta Mineralogii, Geokhimii i Kristalloghimi Redkikh Elementov* (Moscow) no. 18, p. 107–15.
8. Tzchorn, G. 1963. Zur Mineralogie der Topasgänge der Scherlberge (Östtransbaikalien). *Geologie* (Berlin) 12:283–311.
9. Gallagher, M. J. 1966. Micro-indentation hardness of beryl. *Geological Survey of Great Britain Bulletin* 25, pp. 96–7.
10. Hintze, C. 1897. *Handbuch der Mineralogie*. Vol. 2. Leipzig: Verlag von Veit & Comp.
11. Mellor, J. W. 1925. *A Comprehensive Treatise on Inorganic and Theoretical Chemistry*. Vol. 6. London: Longmans, Green and Co.
12. Voigt, J. H. 1887. Bestimmung der Elasticitäts-Constanten von Beryll und Bergkrystall. *Neues Jahrbuch für Mineralogie* (Stuttgart) Beilage-Bd. 5 p. 84.
13. Auerbach, F. 1896. Bestimmung einiger hoher Elasticitätsmoduln. *Annalen der Physik und Chemie* (Leipzig) ser. 3, vol. 58, pp. 381–90.
14. Madelung, E., and Fuchs, R. 1921. Kompressibilitätsmessungen an festen Körpern. *Annalen der Physik und Chemie* (Leipzig) ser. 4, vol. 65, pp. 289–309.
15. Tutton, A. E. H. 1922. *Crystallography and Practical Crystal Measurement*. Vol. 2. London: Macmillan and Co.
16. Bridgman, P. W. 1928. Linear compressibility of thirteen natural crystals. *American Journal of Science* 15:287–96.
17. Birch, F. 1950. A simple technique for the study of elasticity of crystals. *American Mineralogist* 35:644–50.
18. Fizeau, H. 1866. Mémoire sur la dilatation des corps solides par chaleur. *Compte Rendu de l'Académie des Sciences* (Paris) 62:1101–1106, 1133–48.
19. Benoît, J. R. 1888. Nouvelles études et mesures de dilatations par la méthode de M. Fizeau. *Travaux et Mémoires du Bureau International des Poids et Mesures* (Paris) 6:1–193.
20. Geller, R. F., and Insley, H. 1932. Thermal expansion of some silicates of elements in group II of the periodic system. *U.S. National Bureau of Standards Journal of Research*, vol. 9, RP 456, pp. 35–46.
21. Jannettaz, E. 1873. *Sur la Propagation de la Chaleur dans les Corps Cristallisés*. Paris: Gauthier-Villars. 82 pp.
22. ———. 1892. Note sur la propagation de la chaleur dans les corps cristallisés. *Bulletin de la Société Française de Minéralogie et Cristallographie* 15:133–44.
23. Knapp, W. J. 1943. Thermal conductivity of non-metallic single crystals. *Journal of the American Ceramic Society* 26:48–55.
24. *Handbook of Chemistry and Physics*. 1971. 51st ed. Cleveland: Chemical Rubber Co.
25. Öberg, P. E. W. 1885. Bidrag till kännedom af några mineraliers specifika värme. *Ofversigt af Kongl. Vetenskaps-Akademiens Förhandlingar* (Stockholm) no. 8, pp. 43–64.
26. Joly, J. 1889. Die spezifische Wärme der Mineralien. *Zeitschrift für Kristallographie und Mineralogie* (Leipzig) 15:523.
27. Böse, R. 1936. Optische und spektrographische Untersuchungen an Beryllen, insbesondere bei höheren Temperaturen. *Neues Jahrbuch für Mineralogie* Abt. A, Beilage-Bd. 70, pp. 467–570.
28. Brun, A. 1902. [Melting point of beryl]. *Archives des Sciences Physiques et Naturelles* (Geneva) 12:352.
29. Miller, R. P., and Mercer, R. A. 1965. The high-temperature behaviour of beryl melts and glasses. *Mineralogical Magazine* (London) 35:250–76.
30. Riebling, E. F., and Duke, D. A. 1967. BeO · Al₂O₃ · SiO₂ system: structural relationships of crystalline, glassy, and molten beryl. *Journal of Material Sciences* 2:33–9.
31. Munson, R. A. 1967. High-temperature behavior of beryl and beryl melts at high pressure. *Journal of the American Ceramic Society* 50:669–70.
32. Curie, J. 1889. Recherches sur le pouvoir inducteur spécifique et la conductibilité des corps cristallisés. *Annales de Chimie et de Physique* 17:385–434; 18:203–69.
33. Fellinger, R. 1919. Über die Dielektrizitätskonstante einiger natürlicher und synthetischer Edelsteine. *Annalen der Physik*, (Leipzig) ser. 4, vol. 60, pp. 181–95.
34. Takubo, J. 1941. Versuche über die Dielektrizitätskonstanten einiger Mineralien und über das elektrische Verhalten derselben bei Erhitzung. *Memoirs of the College of Science, Kyoto Imperial University*, ser. B, vol. 16, no. 2, pp. 95–154.
35. Hankel, W. G. 1878. Über die thermoelektrischen Eigenschaften des Kalkspathes, des Berylls, des Idocrases und des Apophyllits. *Abhandlungen der königlich-sächsischen Gesellschaft der Wissenschaften, mathematisch-physische Klasse, Leipzig* 11:201–71.
36. Knoblauch, H. 1851. Ueber das Verhalten krystallisirter Körper zwischen elektrischen Polen. *Annalen der Physik und Chemie* (Leipzig) 83: 289–99.
37. Plücker, J. 1859. On the magnetic induction of crystals. *Philosophical Transactions of the Royal Society of London*, 1858, no. 148, pp. 543–87.
38. Voigt, W., and Kinoshuto, S. 1910. Bestimmung absoluter Werte von Magnetisierungszahlen, insbe-

Physical Properties

- sondere für Krystalle. *Zeitschrift für Kristallographie und Mineralogie* (Leipzig) 47:81-3.
39. Goodwin, F. E. 1961. Maser action in emerald. *Journal of Applied Physics* 32:1624-25.
40. Panebianco, H. 1909. [The maximum density of beryl]. *Revista de Mineralogia e Cristallografia Italiana* (Padua) 38:3-11.
41. Bragg, W. L., and West, J. 1926. The structure of beryl, $\text{Be}_3\text{Al}_2\text{Si}_6\text{O}_{18}$. *Proceedings of the Royal Society of London A*-111, pp. 691-714.
42. Norrish, K. 1947. An x-ray study of West Australian beryl. *Journal and Proceedings of the Royal Society of New South Wales* 34:1-16.
43. Radcliffe, D., and Campbell, F. A. 1966. Beryl from Birch Portage, Saskatchewan. *Canadian Mineralogist* 8:493-505.
44. Doelter, C. 1917. *Handbuch der Mineralchemie*. Vol. 2, pt 2. Dresden und Leipzig: Theodor Steinkopff. pp. 584-99.
45. Piutti, A. 1913. [Helium in beryl]. *Le Radium* 10:165-8.
46. Ford, W. E. 1910. The effect of the presence of alkalies in beryl on its optical properties. *American Journal of Science*, 30:128-30.
47. Lacroix, A., and Rengade 1911. Sur les propriétés optiques des béryls roses de Madagascar. *Bulletin de la Société Française de Minéralogie et Cristallographie*, 34:123-5.
48. Deer, W. A., Howie, R. A., and Zussman, J. 1962. *Rock-Forming Minerals*. Vol. 1. London: Longmans. pp. 256-67.
49. Lacroix, A. 1912. Sur la continuité de la variation des propriétés physiques des béryls de Madagascar, en relation avec leur composition chimique. *Bulletin de la Société Française de Minéralogie et Cristallographie* 35:200-8.
50. Webster, R. 1975. *Gems*. 3rd ed. London: Butterworths. pp. 83-105.
51. Vogel, P. 1934. Optische Untersuchungen am Smaragd und einigen anderen durch Chrom gefärbten Mineralien. *Neues Jahrbuch für Mineralogie*. 68:401-38.
52. Jakob, J. 1938. Drei Analysen von Beryll. *Schweizerische mineralogische und petrographische Mitteilungen* 18:607-9.
53. Gübelin, E. J. 1968. Gemmologische Beobachtungen am neuer Smaragd aus Pakistan. *Der Aufschluss* (Heidelberg) Sonderheft 18, pp. 111-16.
54. Otero Muñoz, G., and Barriga Villalba, A. M. 1948. *Esmeraldas de Colombia*. Bogota: Banco de la Republica. 133 pp.

CHAPTER

7

OPTICAL PROPERTIES

LUSTER

On smooth crystal faces and freshly broken surfaces, the luster of beryl is glassy. Compared to other minerals, it resembles the luster of quartz but is somewhat brighter, more like that of freshly broken glass without the slightly "waxy" luster that some fractured quartz displays.

CHATOYANCY AND ASTERISM

The sharp, silky line, or *chatoyancy*, seen in cat's-eye gems, notably chrysoberyls, is sometimes seen in beryls, but very rarely is it as distinctly defined. If several such streaks cross, the effect is called *asterism*, best known in star sapphires and rubies. Asterism in beryls is extremely rare. Both effects are due to extremely fine elongated inclusions, which may be crystals of a foreign mineral or merely voids, as is most commonly the case in cat's-eye beryls. The reflection of light from the inclusions gives rise to the optical effects, and the explanation for them is given in Goldschmidt and Brauns¹ who investigated chatoyant minerals, including a Brazilian cat's-eye beryl.

Most beryls displaying chatoyancy do so only weakly because the inclusions are neither as narrow nor as strongly reflective as they often are in chrysoberyl and corundum. Furthermore, in those beryls in which the effect is noted, especially in rather pale bluish or greenish aquamarines, other kinds of inclusions are also commonly present, which serve to scatter or absorb light and mute the display of chatoyancy. The finest cat's-eyes were cut from a rich golden beryl from Madagascar,² but occasionally a good blue aquamarine cat's-eye appears from Brazil.

Optical Properties

Some years ago a few morganite crystals of pale pink color were found in Brazil from which poor cat's-eyes could be cut but only in large cabochons because the reflective tubes within were large and widely spaced. Chatoyancy in emerald is extremely rare, Henderson³ recording a 4.56 carat gem in the Roebling collection in the U. S. National Museum of Natural History as being one of the very few known to exist.

While ordinary chatoyancy in beryl is due to inclusions lying parallel to the *c*-axis, the few examples of asterism that have been recorded are due to three sets of inclusions, crossing mutually at angles of 60°, and lying in the plane at right angles to the *c*-axis. The earliest reliable record that could be found on such a gem is that in Greg and Lettsom⁴ (p. 127), who described a star aquamarine gem cut from Mourne Mountains, Ireland, material "exhibiting decided opalescence, and showing a six-rayed star like some varieties of corundum." The whereabouts of this gem is unknown.

Henderson,³ in remarking on possible asterism in emerald, noted the specimen in the Townshend collection in the Victoria and Albert Museum (see figure 4-21), but since this specimen only contains narrow zones of dark inclusions which cross like spokes in a wheel, it is called a "fixed star," unlike the shimmering stars in stones in which the star is caused by reflections from numerous fibrous inclusions. Similar "fixed" inclusions have been noted in the so-called *trapiche* emeralds of Colombia, which will be described in Chapter 9. An editor's footnote in Henderson's article noted that "a ten-year investigation by the G. I. A. [Gemological Institute of America] has failed to reveal any verification of the previous occurrence of either true chatoyancy or epiasterism (asterism by reflected light) in an emerald."

When the elongated inclusions in beryl crystals are abundant, they may contribute to a "fiber optics" effect, that is, permit light to pass readily between the inclusions by repeated reflection from their surfaces along the *c*-axis direction. Thus, if a section cut across the *c*-axis direction is taken from a crystal and both surfaces polished, it can be placed over newsprint and the print, as if by magic, will appear on the upper surface of the polished section. This effect in beryl was noted as early as 1837 by Babinet,⁵ who remarked on haloes and rainbow effects observed when a pinpoint of light was passed through such a section.

Asterism of another kind has been noted in aquamarine and is due to multiple reflections from a series of minute spangles of a foreign mineral within the beryl (see figure 10-3). Such spangles form upon the basal faces of the growing crystal and take up preferred orientations in respect to the beryl host. Such preferred orientation, or *epitaxy*, results in the edges of the spangles reflecting light in six-legged streaks, producing distinct but rather weak star phenomena. An aquamarine of this kind was recently found in Brazil and described by Rutland⁶ and Eppler,⁷ the latter identifying the inclusions as extremely thin platelets of the iron-titanium mineral ilmenite. From the top of cabochon-cut gems, or looking down the *c*-axis,

CHEMICAL AND PHYSICAL PROPERTIES

such gems appear bronze-brown in color, but when viewed from the side, it can be seen that the inclusions occur only in very thin layers within a typical greenish-blue aquamarine host.

A remarkable star aquamarine owned by B. W. Anderson of England owes its star to inclusions somewhat similar to those described by Eppler.⁸ In this instance, the inclusion is the sulfide mineral known as pyrrhotite, which forms six-sided flake-like crystals epitaxially oriented on the basal planes along with some chalcopyrite. The beryl itself is greenish, the star perfect but of weak intensity. Similar inclusions on basal planes include bright orange-red flakes of hematite, but these seem to provide only a beautiful orangy submetallic shimmer across the tops of cabochons, with no star.

REFRACTION OF LIGHT

Because of its crystal structure, light rays passing through beryl are doubly refracted in all directions except that parallel to the c -axis, along which direction only single refraction occurs (see figure 7-1). By convention, the index measured parallel to c is taken as the "ordinary" or "omega" (ω) index, and in beryl it is

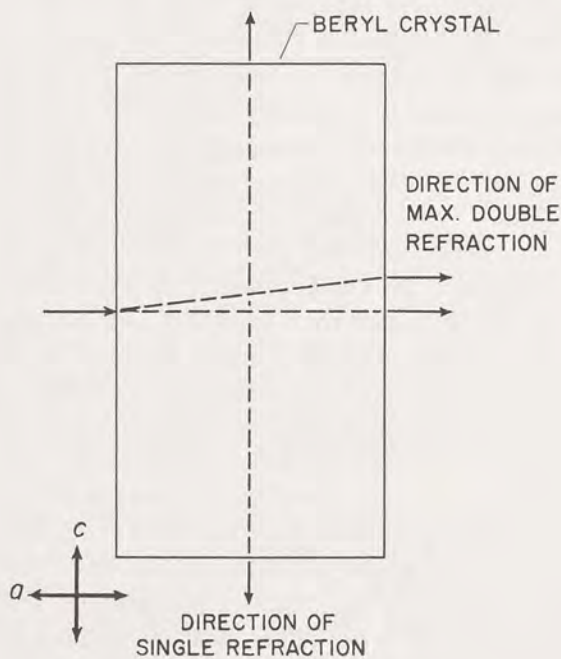

Fig. 7-1 Behavior of light passing through a beryl crystal, showing directions of single refraction and maximum double refraction.

Optical Properties

Table 7-1
REFRACTIVE INDEXES OF SOME
COMMON GEMSTONES

[Water]	1.334
Opal	1.435 to 1.46
Quartz	1.544 to 1.553
Beryl	1.56 to 1.59
Topaz	1.61 to 1.638
Spinel	1.715
Corundum	1.76 to 1.779
Diamond	2.418

invariably larger than the "extraordinary" or "epsilon" (e) index measured at right angles to the c -axis. Because of this consistent relationship, the optical sign is negative ($-$). As measurements are taken at increasing angles from the c -axis direction, the light rays split into two polarized components, diverging in value until the maximum difference is noted in the direction perpendicular to the c -axis. This difference is the double refraction or birefringence, designated "d" or "delta," or merely "difference."

From the standpoint of the jeweler interested in potential brilliancy of cut gems, the refractive index of beryl, upon which brilliancy much depends, is relatively low compared to other standard gemstones as shown in table 7-1.

Despite the low refractive index, beryl can be cut into very satisfactory gems of considerable brilliance, providing the lapidary takes care to shape the rough into proper proportions and cut the facets at the correct angles as explained in Chapter 12.

REFRACTIVE INDEX RANGES

Table 7-2 shows ranges for Na-light (5390 Å) compiled from the literature. As can be seen, there are three groups selected according to generally accepted color varieties. The first group includes the aquamarines and other pale-colored beryls as blue, green-blue, blue-green, yellow-green, yellow, and brownish-yellow. Some of the specimens in this group are listed as "colorless" by their investigators but are probably not alkali goshenites, which would ordinarily have higher values. On the other hand, a number of Madagascar alkali beryls investigated by Duparc et al. and Lacroix are described as blue in various shades, sometimes fairly dark, or combining blue and rose in the same crystal. Despite the blue colors, which would ordinarily be associated with lower refractive indices, they are alkali beryls and hence provide higher indices. The steady rise of refractive indices with increasing alkali content is shown in figure 7-2.

Table 7-2
BERYL REFRACTIVE INDEX RANGES, Na Light (5390 Å)

Beryl Variety	o-ray	e-ray	Birefringence	No. of Samples	Reference
Aquamarine, other pale varieties	1.57015-1.58234	1.56561-1.57592	0.00590-0.00693	5	9
	1.5691-1.5754	1.5644-1.5700	0.0046-0.0057	8	10
	1.56715-1.57924	1.56301-1.57371	0.00414-0.00553	11	11
Emerald	1.5705-1.5893	1.5656-1.5827	0.0049-0.0067	12	12
	1.57325-1.5908	1.56793-1.5839	0.00532-0.00701	10	11
	1.5712-1.5905	1.5663-1.5975	0.0049-0.007	9	13,14
	1.602	1.592	0.010	1	42
Rose, other alkali beryls	1.5825-1.5977	1.5761-1.5894	0.0064-0.0083	3	15
	1.58455-1.59824	1.57835-1.59014	0.00620-0.00810	4	16
	1.5977-1.5977	1.5894-1.5903	0.0074-0.0083	2	17
	1.5782-1.5899	1.5725-1.5921	0.0057-0.0086	7	18,19
	1.5974	1.5890	0.0084	1	20
	1.5860-1.5971	1.5795-1.5894	0.0065-0.0083	4	21
	1.5865-1.6021	1.5791-1.5953	0.0065-0.0069	5	22
1.5772-1.6011	1.5717-1.59195	0.00549-0.00830	5	11	
GENERALIZED RANGES					
Aquamarine, other pale varieties	1.567-1.582	1.563-1.576	0.004-0.007		From table above
Emerald ^a	1.570-1.591(1.602)	1.566-1.597(1.592)	0.005-0.007(0.010)		From table above
Rose, other alkali beryls	1.577-1.602	1.572-1.595	0.007-0.008		From table above
All varieties	1.569-1.598	1.565-1.590	0.004-0.008		23
All varieties	1.578-1.592	1.571-1.585	0.007-0.007		23 ^b
All varieties	1.568-1.602	1.564-1.595	0.004-0.008		24

^aThe extraordinarily high values shown in parentheses were determined on a Zambian emerald by Bank⁴² and are apparently the highest hitherto known of natural emeralds.

^bFrom graph on p. 262, showing steady rise in values from pure beryl to that containing ca. 28% alkali.

Optical Properties

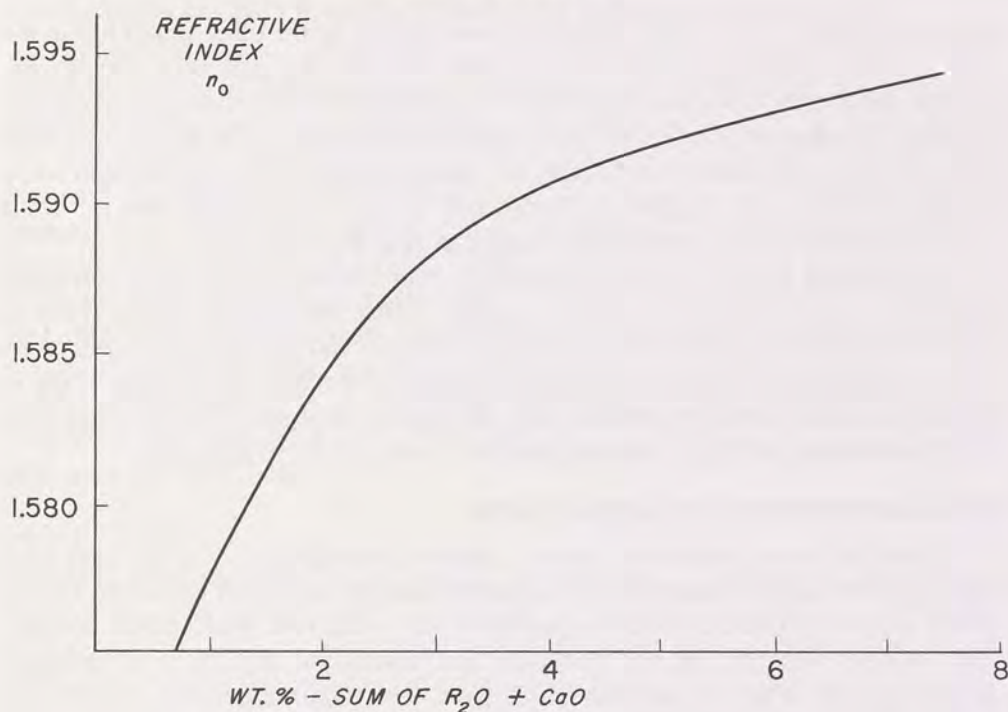

Fig. 7-2 Rise in refractive index (ordinary or omega ray) with rise in content of alkalis (R_2O) and calcium oxide (CaO), the alkalis being sodium-lithium and sodium-lithium-cesium. From a graph of P. Černý and F. C. Hawthorne, Refractive indices versus alkali contents in beryl, *Canadian Mineralogist* 14 (1976):491-7.

Bazzite, the scandian analog of beryl, occurs only in very small prismatic crystals and little optical information has been published on it. According to Stalder,^{8a} the indexes for a specimen from the Furka-Basistunnel, Switzerland, are $o = 1.625 \pm 0.002$ and $e = 1.605 \pm 0.002$.

INFLUENCE OF COMPOSITION ON REFRACTIVE INDEXES

In an attempt to establish a correlation between color and refractive indexes and thus indirectly obtain some measure of BeO content of beryls, J. W. Adams, in Page et al.²⁵ (p. 48-51), determined the ordinary index (only) on more than 130 Black Hills pegmatite beryls using oil immersion methods, error ± 0.003 . This study depended on the fact that most aquamarine-type beryls were richer in BeO than those in the alkali group, in which considerable beryllium had been replaced. It was found that when the values were plotted against color, most white, colorless, or very faintly colored beryls fell into two distinct groups, those of higher value

CHEMICAL AND PHYSICAL PROPERTIES

lying in the range 1.58-1.592, while the lower values of the other group fell in the range 1.570-1.575. Adams (p. 51) noted that "white, very pale blue, blue-green, or pink beryl may be expected to have a high index of refraction and to contain less than 12 percent BeO. Green, yellow-green, golden-yellow, or pale brown beryl generally has a low index of refraction and contains more BeO." It was also noted that the amount of BeO generally diminished in beryls from those near the walls of beryl-bearing deposits (pegmatites) to those near the cores.

In a similar study, Pavlova²⁶ made more than 100 determinations of refractive indexes on beryls taken from quartz-tungsten veins penetrating various types of rocks. The direct correlation between alkali content and higher indexes was confirmed. It was also found that the lowest values occurred in beryls from veins in granite, an acidic rock environment, and the highest occurred in beryls taken from veins penetrating porphyry and amphibolite, a basic rock environment.

REFRACTIVE INDEXES AND COLOR

From the above discussion, several cautious generalizations can be made concerning color and its relationship to refractive indexes inasmuch as certain typical colors suggest certain chemical compositions. As a rule, rose, pink, peach, apricot, and colorless varieties are rich in alkalis and possess the highest of all indexes. However, some white or colorless beryls have been found to possess low indexes, which seems to place them in the aquamarine group. It is possible in some of these instances that the beryl was so faintly colored, especially in small fragments, that it was declared colorless.

The typical grass-green hue of emerald is generally accompanied by medium-value indexes but some analyses of emerald show considerable amounts of alkali, particularly sodium, which may account for indexes above those found in the aquamarine group. Bank⁴² found an extraordinarily high refractive index in a Zambian emerald and also a high Fe content, to which he attributed the elevated values noted.

The most common colors in beryl are tints of blue-green or green-blue, followed by yellow-green, greenish-yellow, yellow, and brownish-yellow varieties. They are seldom strongly tinted. Pure blue beryls may either fall in the aquamarine group or in the alkali-rich group. For example, the fine blue crystals from Madagascar described by Lacroix, Duparc, and others may display all the characteristics of rose beryls or other alkali-rich varieties, namely, substantial alkali content, high refractive indexes, and high specific gravity. As noted before, some of the Madagascar crystals were found with blue and rose in the same specimen. Differences in refractive indexes in color-zoned crystals have been noted by Böse¹¹ (p. 499), who found $o = 1.57514$ and $e = 1.56962$ in a faintly colored portion of a Chivor, Colombia, emerald crystal, but the higher values of $o = 1.57517$ and $e = 1.56963$ in the dark-colored portion.

VARIATION OF REFRACTIVE INDEXES WITH WAVELENGTH

Refractive indexes of beryl in various wavelengths of light have been determined by a number of investigators. The green light of the solar spectrum was employed by Heusser²⁷ (pp. 468–9) and by Descloizeaux²⁸ (vol. 1, p. 366), and for five wavelengths by Schrauf⁹ (pp. 116–20). Offret²⁹ (p. 561) used six wavelengths from red (Li, 6706 Å) to blue (Cd, 4799 Å), and noted at 20°C a corresponding smooth rise in values for a colorless beryl from $o = 1.570980$ to $o = 1.580448$ and $e = 1.566050$ to $e = 1.57248$. Vogel¹² (p. 402) conducted a similar study on emeralds, using wavelengths B (6870 Å), C (6560 Å), D (5890 Å), E (5270 Å), and F (4860 Å). Again a smooth rise in refractive indexes was found as wavelengths decreased. A similar trend was found by Brun,³⁰ who measured indexes of a Tsilaisina, Madagascar beryl in ultraviolet wavelengths, finding for Hg (4358 Å) $o = 1.5934$ and $e = 1.5867$ and for Hg (3131 Å) $o = 1.6156$ and $e = 1.6075$, birefringence 0.0067–0.0081.

DISPERSION

The difference in refracting power as measured by differences in refractive indexes between the red and blue portions of the visible spectrum is called the *dispersion*. Dispersion is responsible for the flashes of pure spectral colors that are so characteristic of otherwise colorless diamond gems. Cut specimens act like miniature prisms and “spread” the white light falling upon them into its colored components. Compared to diamond’s dispersion of 0.058, that of beryl is very low, only about 0.0090–0.0100. It is for this reason that no art of the lapidary can induce in a beryl gem the fine display characteristic of diamond and which gemologists call the “fire.” Table 7-3 shows not only refractive indexes and birefringences determined by Vogel¹² (pp. 409–10), but also the measured dispersion of a large number of emeralds from various deposits.

REFRACTIVE INDEXES AND TEMPERATURE

Offret²⁹ found that both the o and e indexes of beryl rose smoothly with increasing temperature for wavelengths in the red, yellow, green, and blue regions. For example, in yellow light (Na, 5888 Å), the indexes of a clean colorless beryl measured $o = 1.574232$ and $e = 1.569230$ at 0°C, but at 300°C they measured $o = 1.578108$ and $e = 1.572772$, or +0.003876 for the o -ray and +0.003876 for the e -ray. Schmidt and Baier³¹ found on heating beryl from 0° – 1100°C a slight but apparently permanent increase in birefringence.

OPTICAL ANOMALIES

Beryl possesses one principal axis (c) of symmetry which coincides with the single optic axis, hence beryl is optically *uniaxial*. However, almost from the first, investigations of thin sections of beryl in polarized light found that some crystals

CHEMICAL AND PHYSICAL PROPERTIES

Table 7-3
DISPERSION IN EMERALD

Source	Ray	C					Dispersion	Birefringence
		B (6870 Å)	(6560 Å) Red- Orange	D (5890 Å) Yellow	E (5270 Å) Green	F (4860 Å) Blue		
Austria	<i>o</i>	1.5859	1.5868	1.5893	1.5925	1.5954	0.0095	0.0065–0.0069
	<i>e</i>	1.5794	1.5803	1.5827	1.5856	1.5885	0.0091	
Urals	<i>o</i>	1.5846	1.5856	1.5881	1.5915	1.5946	0.0100	0.0063–0.0066
	<i>e</i>	1.5783	1.5790	1.5815	1.5845	1.5880	0.0097	
	<i>o</i>	1.5846	1.5856	1.5886	1.5920	1.5948	0.0102	
	<i>e</i>	1.5780	1.5789	1.5819	1.5854	1.5881	0.0101	
Leysdorp	<i>o</i>	1.5814	1.5823	1.5850	1.5884	1.5914	0.0100	0.0062–0.0068
	<i>e</i>	1.5752	1.5760	1.5787	1.5820	1.5846	0.0094	
Colombia	<i>o</i>	1.5703	1.5715	1.5739	1.5771	1.5796	0.0093	0.0054–0.0053
	<i>e</i>	1.5649	1.5662	1.5685	1.5717	1.5743	0.0094	
	<i>o</i>	1.5757	1.5766	1.5794	1.5827	1.5854	0.0097	
	<i>e</i>	1.5697	1.5706	1.5732	1.5764	1.5792	0.0095	
	<i>o</i>	1.5713	1.5722	1.5750	1.5781	1.5808	0.0095	
	<i>e</i>	1.5658	1.5668	1.6695	1.5723	1.5754	0.0096	
Bom Jesus dos Meiras	<i>o</i>	1.5730	1.5738	1.5762	1.5797	1.5825	0.0095	0.0055–0.0058
	<i>e</i>	1.5675	1.5683	1.5706	1.5739	1.5767	0.0092	
	<i>o</i>	1.5696	1.5704	1.5730	1.5760	1.5787	0.0091	
	<i>e</i>	1.5645	1.5653	1.5676	1.5708	1.5734	0.0089	
	<i>o</i>	1.5677	1.5686	1.5712	1.5742	1.5772	0.0095	
	<i>e</i>	1.5628	1.5637	1.5663	1.5693	1.5720	0.0092	
	<i>o</i>	1.5696	1.5708	1.5733	1.5768	1.5796	0.0100	
	<i>e</i>	1.5643	1.5653	1.5679	1.5714	1.5739	0.0096	
	<i>o</i>	1.5668	1.5678	1.5705	1.5738	1.5764	0.0096	
	<i>e</i>	1.5620	1.5630	1.5656	1.5689	1.5714	0.0094	

Source: Vogel,¹² pp. 409-10.

display features typical of biaxial minerals, or those in which two optical axes are present. In still other specimens it was found that biaxiality occurred only in certain areas, and while the morphology of beryl clearly places it in the hexagonal system, these anomalous biaxial phenomena suggested that some beryl crystals are orthorhombic.

Early references to this problem appear in Hintze³² (pp. 1274–5), commencing with observations by Babinet in 1837 (*Poggendorf's Annalen* 1837, vol. 4, p. 126). Mallard³³ examined some specimens displaying biaxial features and

Optical Properties

declared them to be orthorhombic. Brewster³⁴ discovered numerous acicular inclusions parallel to the *c*-axis in an Indian beryl, each surrounded by strain figures, suggesting that these inclusions caused the normal uniaxial optical figure to disappear. Bücking³⁵ showed that the angle between the two anomalous biaxes seen in some beryls could be changed and the plane in which they lay altered by applying pressure to the specimen. He suggested that the peculiar effects were due to the presence of numerous liquid inclusions. The effects of pressure on the optical properties of a Nerchinsk, Siberia, beryl were also studied by Pockels.³⁶

According to Wiik,³⁷ the anomalous optical behavior in beryl may be due to dimorphism: beryl may be hexagonal at higher temperatures of formation but change to an orthorhombic structure at lower temperatures, with subsequent development of the biaxiality inherent in orthorhombic crystals.

In examining an Ilmen Mountains beryl, Karnozhitsky³⁸ related anomalous optical behavior to changes in crystal form during growth and attributed such behavior to stresses developed as a result of changes in chemical composition during formation. An investigation by Kohlmann¹⁰ (p. 179) found similar evidence: a section of beryl cut parallel to the prism face $m(10\bar{1}0)$ displayed normal uniaxial behavior while one cut parallel to $c(0001)$ revealed a normal uniaxial figure in the large core zone but weak biaxial figures along the periphery. Böse¹¹ (pp. 469–10) found similar phenomena in several beryl crystals he examined. Duparc et al.¹⁸ (p. 380) found biaxial figures in a number of rose beryls and aquamarines from Madagascar and measured the angle between emergent optical axes (2E), obtaining values of $4^{\circ}54'$ (rose beryl) and $9^{\circ}44'$, $10^{\circ}12'$, $5^{\circ}23'$, and $8^{\circ}42'$ for four aquamarines. Ikornikova³⁹ (p. 536) concluded from examination of beryls from Sherlova Gora, Transbaikalia, that beryl may actually be orthorhombic and that the angle made between the optical axes within the crystal (2V) may be as much as 17° , and that biaxial portions of crystals are pseudo-hexagonal cyclic twins.

In a recent study of the problem, Sahama⁴⁰ stated that "in beryl the biaxial optics is so common that such an anomaly can be regarded for the mineral a characteristic rule rather than an occasional exception. . . . This is true especially for clear beryl crystals usually grown in more or less open vugs and often showing well developed crystals." Sahama found negative optic axial angles of 2V to range from nil to 18° – 20° and that the bisectrix of this angle was always parallel to the *c*-axis.

In a series of drawings, Sahama showed how beryl crystals grew as aggregates of sub-individuals (figure 9-25) and where biaxiality occurred in cores, sectors, and laminae in the crystals. The development of biaxiality is attributed to internal strains set up during crystal growth. In an interesting experiment, he also demonstrated how such strains could be relieved by drilling out small cylindrical sections from biaxial areas. Upon losing the strains, "the optical anomaly disappears and the

CHEMICAL AND PHYSICAL PROPERTIES

optical symmetry becomes normal for the hexagonal unstrained crystal." Therefore, he concluded, "the polygonal texture of beryl represents a strain pattern, not caused by twinning of orthorhombic or other units of lower symmetry."

In this connection, Foord and Mills⁴¹ studied anomalous biaxiality in several minerals, including beryl, by tracing changes in chemical composition across crystal sections in an attempt to discover if a consistent correlation existed between such changes and development of biaxiality. No such consistency could be found, although in some instances changes in composition, especially when abrupt, were believed to contribute to internal strains causing biaxiality. In sum, they believed that "the anomalous optical properties are . . . due to strain induced by chemical substitutions and/or defects occurring during crystal growth, by rapid temperature or pressure quenches, or by mechanical deformation."

Literature Cited

1. Goldschmidt, V., and Brauns, R. 1911. Über Lichtkreise und Lichtknoten an Kristallkugeln. *Neues Jahrbuch für Mineralogie* (Stuttgart) Beilage-Bd. 31, pp. 220-42.
2. Sinkankas, J. 1955. Some freaks and rarities among gemstones. *Gems & Gemology* 8:197-99.
3. Henderson, E. P. 1945. Cat's-eye emerald. *Gems & Gemology* 5:222.
4. Greg, R. P., and Lettsom, W. G. 1858. *Manual of the Mineralogy of Great Britain and Ireland*. London: John Van Voorst. 483 pp.
5. Babinet 1837. Beiträge zur meteorologischen Optik. *Annalen der Physik und Chemie* (Leipzig) 41:128-44.
6. Rutland, E. H. 1956. An unusual brown beryl. *The Gemmologist* (London) 25, no. 304, pp. 191-2.
7. Eppler, W. F. 1958. Notes on asterism in corundum . . . chatoyancy in beryl. *Journal of Gemology* (London) 6:195-212.
8. ———. 1960. An unusual star-beryl. *Journal of Gemology* (London) 7:183-91.
- 8a. Stalder, H. A. 1978. Alte und neue Mineralfunde aus dem Wallis. *Schweitzer Strahler* (Bern) vol. 4, no. 9, pp. 374-84.
9. Schrauf, A. 1860. Bestimmung der optischen Constanten krystallisierter Körper. *Sitzungsberichte der Kaiserlichen Akademie der Wissenschaften, Mathematisch-Naturwissenschaftliche Classe*, 42:107-120.
10. Kohlmann, H. 1908. Beiträge zur Kenntniss der brasilianischen Berylls. *Neues Jahrbuch für Mineralogie* (Stuttgart) Beilage-Bd. 25, pp. 135-81.
11. Böse, R. 1936. Optische und spektrographische Untersuchungen an Beryllen, insbesondere bei höheren Temperaturen. *Neues Jahrbuch für Mineralogie* (Stuttgart) Beilage-Bd. 70, pp. 467-570.
12. Vogel, P. 1934. Optische Untersuchungen am Smaragd und einigen anderen durch Chrom gefärbten Mineralien. *Neues Jahrbuch für Mineralogie* (Stuttgart) 68:401-38.
13. Gübelin, E. J. 1958. Emeralds from Sandawana. *Journal of Gemology* (London) 6:340-54.
14. Gübelin, E. J. 1968. Gemmologische Beobachtungen am neue Smaragd aus Pakistan. *Der Aufschluss* (Heidelberg) Sonderheft 18, pp. 111-16.
15. Lacroix, A. 1908. Les minéraux des filons de pegmatite à tourmaline lithique de Madagascar. *Bulletin de la Société Française de Minéralogie et Cristallographie* 31:218-47.
16. Ford, W. E. 1910. The effect of the presence of alkalis in beryl upon its optical properties. *American Journal of Science* 30:128-30.
17. Lacroix, A. 1910. Nouvelles observations sur les minéraux des pegmatites de Madagascar. *Bulletin de la Société Française de Minéralogie et Cristallographie* 33:37-50.
18. Duparc, L.; Wunder, M.; and Sabot, R. 1910. Les minéraux des pegmatites des environs d'Antsirabe à Madagascar. *Mémoires de la Société de Physique et d'Histoire Naturelle de Genève* 36, fasc. 3, pp. 281-410.
19. ———. 1910. Contribution à la connaissance des minéraux et des pegmatites de Madagascar. Note sur le béryl de divers gisements situés dans le environs d'Antsirabe. *Bulletin de la Société Française de Minéralogie et Cristallographie* 33:53-67.
20. ———. 1911. Contribution à la connaissance des minéraux des pegmatites (deuxième note). *Bulletin de la Société Française de Minéralogie et Cristallographie* 34:131-8.
21. Lacroix, A., and Rengade 1911. Sur les propriétés optiques des béryls roses de Madagascar. *Bulletin de la Société Française de Minéralogie et Cristallographie* 34:123-5.
22. Lacroix, A. 1912. Sur la continuité de la variation

Optical Properties

- des propriétés physiques des béryls de Madagascar, en relation avec leur composition chimique. *Bulletin de la Société Française de Minéralogie et Cristallographie* 35:200-8.
23. Deer, W. A.; Howie, R. A.; and Zussman, J. 1962. *Rock-Forming Minerals*. Vol. 1, London: Longmans. pp. 256-67.
 24. Winchell, A. N., and Winchell, H. 1951. *Elements of Optical Mineralogy*. Part 2. 4th ed. New York: John Wiley. 551 pp.
 25. Page, L. R., et al. 1953. Pegmatite investigations 1942-1945 Black Hills. *U. S. Geological Survey Professional Paper* 247. 228 pp.
 26. Pavlova, I. G. 1965. Dependence of the refractive indices of beryl on composition and mode of genesis. *Doklady Akademii Nauk SSSR, Earth Sciences Section* (New York) 150:109-12.
 27. Heusser, J. C. 1852. Untersuchung über die Brechung des farbigen Lichts in einigen krystallinischen Medien. *Annalen der Physik und Chemie* (Leipzig) 87:454-70.
 28. Descloizeaux, A. 1862. *Manuel de Minéralogie*. Vol. 1. Paris: Dunod. 572 pp.
 29. Offret, A. 1890. De la variation, sous l'influence de la chaleur, des indices de réfraction de quelques espèces minérales, dans l'étendue du spectre visible. *Bulletin de la Société Française de Minéralogie et Cristallographie* 13:405-697; 14 (1891):329.
 30. Brun, A. 1931. Note sur les indices de réfraction pour l'ultra-violet du zircon et du béryl. *Bulletin de la Société Française de Minéralogie et Cristallographie* 54:189-90.
 31. Schmidt, W., and Baier, E. 1928. Versuche über die Kinetik der Änderung optischer Eigenschaften mit der Temperatur. *Zeitschrift für Kristallographie und Mineralogie* (Leipzig) 68:477-502.
 32. Hintze, C. 1897. *Handbuch der Mineralogie*. Vol. 2. Leipzig: Verlag von Veit & Comp. 1841 pp.
 33. Mallard, E. 1876. Explication des phénomènes optiques anormaux, que présentent un grand nombre des substances cristallisées. *Annales des Mines* 10:60-196.
 34. Brewster, D. 1861. On the pressure cavities in topaz, beryl and diamond, and their bearing on geological theories. *Transactions of the Royal Society of Edinburgh* 23:39-44.
 35. Bücking, H. 1883. Über den Einfluss messbaren Drucks auf doppelbrechende Mineralien. *Zeitschrift für Kristallographie und Mineralogie* (Leipzig) 7:555.
 36. Pockels, F. 1892. Über die Änderung des optischen Verhaltens von Alaun und Beryll durch einseitigen Druck. *Neues Jahrbuch für Mineralogie* (Stuttgart) Beilage-Bd. 8, pp. 217-68.
 37. Wiik, F. J. 1887. Mineralogische und petrographische Mitteilungen. *Zeitschrift für Kristallographie und Mineralogie* (Leipzig) 12:515-7.
 38. Karnozhitsky, A. 1891. Ueber die optische Anomalie des Berylls. *Zeitschrift für Kristallographie und Mineralogie* (Leipzig) 19:209-19.
 39. Ikornikova, N. Y. 1939. [Crystallographic investigation of beryl crystals from Sherlova Mountain]. *Mémoires de la Société Russe de Minéralogie* (St. Petersburg) ser. 2, vol. 68, p. 536.
 40. Sahama, T. G. 1966. Polygonal growth of beryl. *Comptes Rendus de la Société Géologique de Finlande* no. 38, pp. 31-45.
 41. Foord, E. E., and Mills, B. A. 1978. Biaxiality in 'isometric' and 'dimetric' crystals. *American Mineralogist* 63:316-25.
 42. Bank, H. 1980. Sehr hochlichtbrechender Smaragd aus Sambia. *Zeitschrift der deutschen gemmologischen Gesellschaft* 29, no. 1/2, p. 101-3.

CHAPTER

8

COLOR AND LUMINESCENCE

ALTHOUGH the use of dyes and pigments has been known for thousands of years, until very recently no satisfactory theory was available to explain how such agents received white light and mysteriously transformed it into colored light. Boyle¹ believed that the coloring matter in gemstones was absorbed by the mineral while it was still in a state of solution, or absorbed by any mineral which had "a Texture open enough to be penetrable by Mineral Fumes." He thus stated the "dye" principle, that is, coloring agents are finely divided particles that impart their color to some host, whether it be a bolt of fabric, the vehicle of an artist's paint, or a mineral. However, none of this explains why the particles themselves are colored, a matter which will be pursued in this chapter.

As shown in Chapter 5, the beryl crystal, like crystals of other minerals, consists of atoms regularly spaced in a characteristic pattern and composition. Each atomic nucleus is surrounded by a swarm of electrons which are more or less bound to the parent nucleus so that they can only move slightly. In a particular class of elements, the "transition elements," certain electrons can move appreciably when met by radiations such as ordinary light. When colorless or "white" light strikes a crystal in which one or more of these elements is present, it sets up a vibration of some of the electrons which then absorb part of the energy of light and transform it into heat. The absorption is selective; that is, only some portions of the light are affected. The net result is that the light that does escape is colored, the nature of the color depending on what parts of the visible light spectrum were absorbed by the vibrating electron field. The escaping parts pass to the eye, are detected, and interpreted by the brain as some "color."

DICHROISM

As described in the previous chapter, light passing through a beryl crystal is divided into two rays, the ordinary ray *o* and the extraordinary ray *e*. Both rays not only provide different refractive indexes, but they are also polarized in respect to each other. In colored beryls, among other colored doubly refracting minerals, each ray bears its own hue or a distinct tint of the same hue. This is the effect known as *dichroism*, or literally, "two-coloring." The differences in hue may be readily detected by use of the gemological dichroscope, a small tubular instrument which contains two side by side rectangles or "windows" of polaroid film, each turned 90° to the other in respect to polarity. The function of the polaroid film is to suppress the color of one ray and allow the color of the other ray to pass through. A small magnifying lens in the tube enlarges the window images and enables easy comparison of the hues.

When held against a cut gem or rough specimen of beryl and rotated, different colors will appear in the windows at some point during the rotation. However, if the specimen is viewed in the direction of the *c*-axis, along which the light rays do not divide, the same color appears in both windows. Elsewhere, the incoming light ray is split into two polarized rays and each can be examined at leisure, the tube of dichroscope being turned until the maximum contrast is obtained. Such contrasts naturally depend on the intensity of the color to begin with, but even in weakly colored specimens it is often possible to see distinct differences in the hues. (In addition to its usefulness in gem identification, the dichroscope is also helpful to the lapidary in selecting the best way to cut a gem of the finest color.)

Table 8-1 lists the apparent colors of beryls, showing the dichroic hues and the intensities that may be expected.

In the following sections the ions responsible for production of color in beryls will be identified. In general, there is significant correlation between color and composition, and, as will be seen some validity can be given to the use of colors as varietal designations in beryl and as clues to chemical composition.

COLOR ZONING

Many beryl crystals are uniformly colored for the most part, but others are zoned in various patterns reflecting changes in chemical composition during growth. In emerald, for example, the most common type of zoning occurs as a lighter-hued or even colorless core that is enveloped by outer zones of darker color. As shown in the examples in figure 8-1, several zones may develop, and even more complex patterns may occur. Striking examples of color zoning in emerald crystals are shown in a color plate in Klein² and in Barriga Villalba.³

Colorless cores are responsible for the generally pale hue of North Carolina emeralds. Brazilian beryl deposits also furnish many crystals which are aquamarine at the base and colorless to pink at the top, indicating progressive incorporation of

CHEMICAL AND PHYSICAL PROPERTIES

Table 8-1
DICHROIC COLORS IN BERYL

<i>Apparent Color</i>	<i>Dichroic Colors</i>		<i>Intensity</i>
Green (emerald)	Yellowish green	Bluish green	Weak to distinct
Green (other than emerald)	Colorless or slightly yellowish	Bluish green	Weak to distinct
Green	Colorless	Very pale green	Weak
Green (Maxixe type) ^a	Green	Yellow	Distinct
Greenish blue	Colorless	Pale bluish green	Distinct
Greenish blue	Pale yellowish green	Pale bluish green	Distinct
Blue	Very pale yellow	Blue	Distinct
Blue	Colorless	Blue	Distinct to strong
Blue ^b	Blue	Colorless	Strong
Blue (Maxixe type) ^a	Blue	Colorless	Strong
Blue (Maxixe type) ^a	Blue	Pale pink	Strong
Yellow	Yellowish green	Pale bluish green	Very weak
Yellow	Greenish yellow	Yellow	Distinct
Yellow	Pale yellow	Lighter yellow	Weak
Pink (morganite)	Yellowish pink	Pink	Weak to distinct
Pink (morganite)	Pale pink	Pale bluish pink	Weak to distinct
Red (Utah)	Yellowish red	Purplish red	Distinct
Violet ^c	Colorless	Violet	Distinct

^aK. Nassau, Examination of Maxixe-type blue and green beryl, *Gems & Gemology* 14:131.

^bB. W. Anderson, *Gem Testing*, 8th ed. (London: Butterworths, 1971), p. 235, Madagascar material.

^cR. Webster, *Gems*, 3rd ed. (London: Butterworths, 1975), pp. 815-16.

Other information from personal observation and from other authorities.

alkali elements in their composition. Some recent finds of morganite display outer zones of pink material and inner zones of blue or grayish beryl, sometimes in striking contrast. Another type of zoning in aquamarines is shown in the top crystal in figure 8-2, in which numerous narrow color zones appear parallel to the basal plane. This type of zoning is perhaps most characteristic of certain beryls from the famous Adun Chilon deposits in the Transbaikal region of the USSR. Such zones may be various tints of blue, green, or even yellow.

EMERALD COLOR

The first clue to the cause of color in emerald came in 1798 when Vauquelin⁴ made his landmark analysis and found chromium. From his discovery it was con-

Color and Luminescence

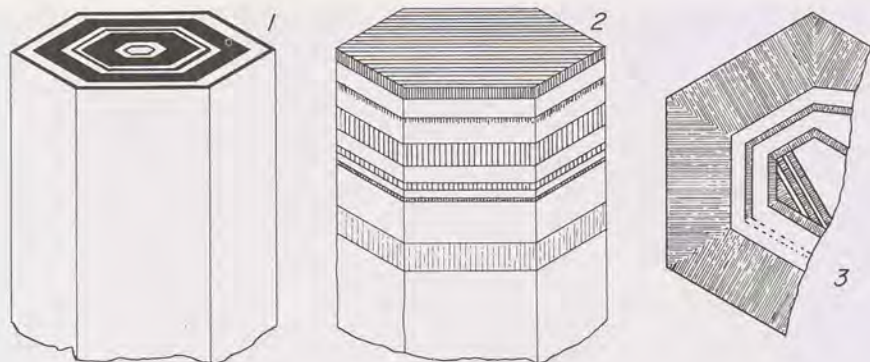

Fig. 8-1 Types of color-zoning in Leysdorp emerald crystals, after J. M. LeGrange, "The Barbara Beryls," *Transactions of the Geological Society of South Africa* 32 (1929). 1. Zones of colorless or faintly pink alternating with green zones. 2. Less commonly, zones of varying intensity green parallel to the basal pinacoid. 3. Mixed zoning, perhaps due to further growth of emerald upon a fragment of an earlier crystal in which zones were parallel to the *c*-axis, as in type 1.

cluded that this element was responsible for the green color, but differences of opinion arose among other chemists. For example, Lévy⁵ found only a trace of chromium in an analysis of Muzo emerald, and he believed that the color was due not to chromium but to some organic compound from the black calcite that accompanied the emerald. However, Wöhler and Rose⁶ showed that the green color did not disappear with strong heating as would have happened had the color been due to an organic compound. They reiterated the view that the color was due to chromium. Furthermore, to demonstrate the coloring influence of chromium, they prepared a series of glass melts "doped" with a chromium salt and obtained, upon cooling, glasses colored by greens similar to those observed in emerald. Jannettaz⁷ took the step of heating a sample of emerald-bearing black schist from the Egyptian mines and found no traces of any carbon compound that could have supported Lévy's contention.

Using a spectroscope to detect typical absorption lines in light rays passed through emerald, in 1912 Moir⁸ found "hair lines" of absorptions at wavelengths of 6805 Å and 6795 Å, and he concluded that "the almost unique spectra of emerald and ruby are due to chromium oxide which has been compelled to vibrate in an abnormal or constrained manner, leading to the production of narrow absorption bands in the spectrum." He also concluded that "the constraining substance . . . in the case of emerald is beryllium oxide."⁹

A few years later, Wild and Klemm,¹⁰ examining emeralds from several deposits, found vanadium as well as chromium lines in the spectrum of emerald from the Urals, thus suggesting for the first time that the vanadium ion could also be

CHEMICAL AND PHYSICAL PROPERTIES

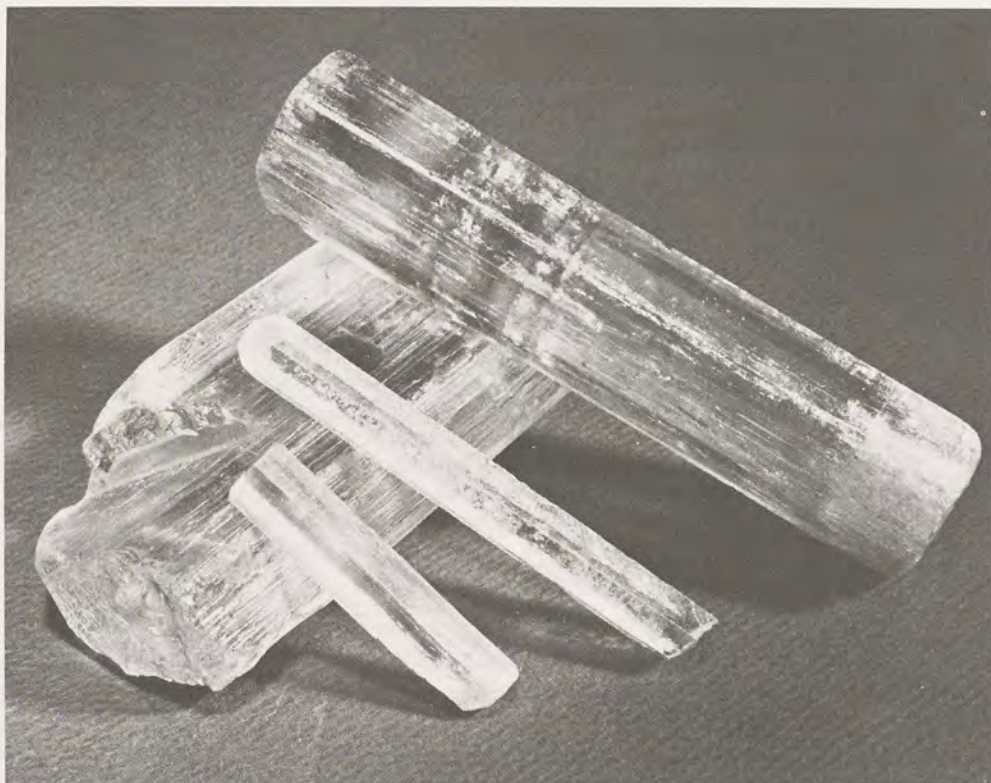

Fig. 8-2 Aquamarine crystals. Top: Terminated, slightly worn simple hexagonal prism with narrow bands of color parallel to the basal plane, from the Nerchinsk region, Transbaikalia, USSR; about 11.5 cm (4½ in) long. The other crystals are from Minas Gerais, Brazil.

responsible, in part, for the color of this beryl variety. The presence of vanadium was confirmed spectroscopically by Fersman,¹¹ but it was found only in dark-colored specimens. Fersman also noted that the serpentine associated with the Uralian emeralds contained 0.23% Cr_2O_3 and that there appeared to be a correlation between the intensity of color and increasing content of chromium oxide in the matrix of emerald. A similar correlation was suggested by Klemm,¹² who expressed his conviction that Cr replaced Al in the beryl structure.

In 1934, Vogel¹³ published results of an intensive study of absorptions in emerald and other minerals colored by chromium, using polished prisms manufactured from transparent emerald, and prepared curves of absorption versus various wavelengths of light. At the same time he investigated absorptions produced by vanadium in synthetic "green sapphire" corundum, manufactured by the I. G. Farbenindustrie in Germany, and in an alexandrite-type synthetic spinel also doped with vanadium. When the absorption curves produced by Cr and V are compared

Color and Luminescence

(figure 8-3), it can be seen why Vogel concluded that vanadium behaved like chromium in inducing green color.

In a somewhat similar investigation, Kolbe¹⁴ studied color in minerals caused by manganese, chromium, and iron, and in examining two emeralds (from an unspecified source) found maximum absorption at 6200 Å and 6160 Å, and at 6160 Å for a specimen from Habachtal, Austria, all consistent with Vogel's findings. Absorption curves were also prepared for emerald by Grum-Grzhimailo,¹⁵ who investigated the wavelength region of 440–6600 Å and noted that increasing amounts of Cr caused maximum absorption shifts from 5350 Å to 6300 Å and minimum absorption shifts from 4800 Å to 5500 Å. He suggested that pleiochromism, or the difference in colors observed along differing directions in the emerald crystal, was caused by deformation of electron orbits around Cr atoms.

A table of absorptions for emeralds from various deposits, including synthetic emeralds made by I. G. Farbenindustrie and Professor Nacken, was published in 1948 by Wild and Biegel.¹⁶ This data, among other information, is incorporated in

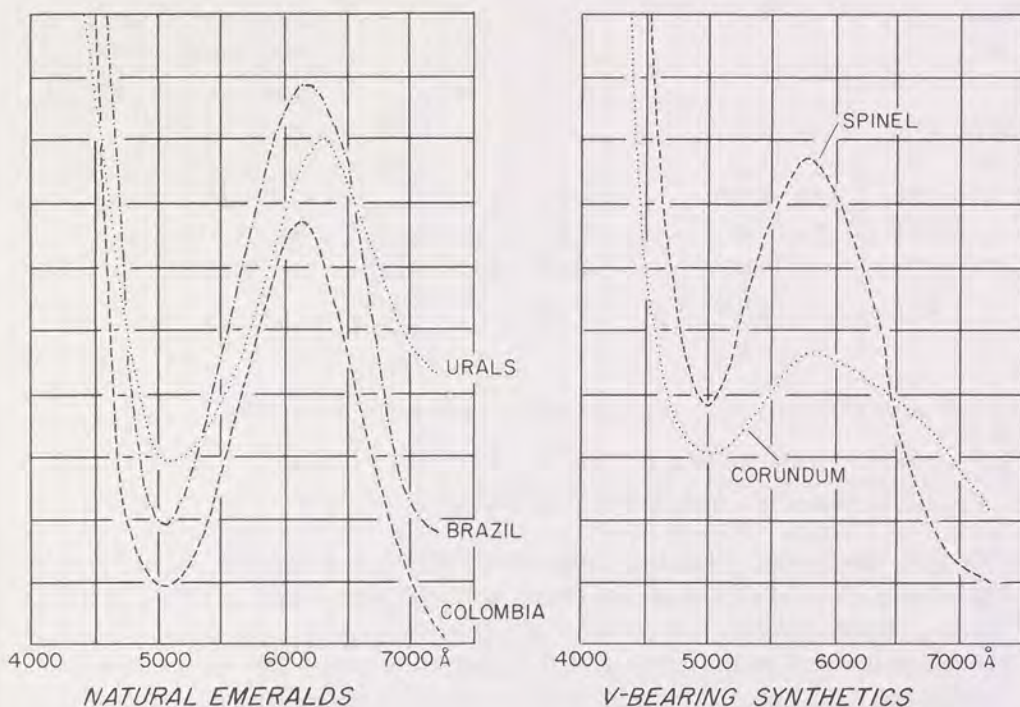

Fig. 8-3 Absorption curves of light from about 4500–7500 Å in natural emeralds and vanadium-bearing synthetics, the latter showing the coincidence of the curves with those produced by chromium. After graphs by P. Vogel in *Optische Untersuchungen am Smaragd und einigen anderen Chrom gefärbten Mineralien*, *Neues Jahrbuch für Mineralogie* 68 (1934):401–438.

CHEMICAL AND PHYSICAL PROPERTIES

Table 8-2
ABSORPTION SPECTRA IN EMERALD (Å)

Anderson ^a Webster ^b		Chivor		Chivor		Muzo		Urals		Brazil (Ferros)	
Unstated Color		Medium Green		Light Green		Medium Green		Dark Green		Yellow/ Green	
Unstated Ray		<i>e</i>	<i>o</i>	<i>e</i>	<i>o</i>	<i>e</i>	<i>o</i>	<i>e</i>	<i>o</i>	<i>e</i>	<i>o</i>
6835 st	6830 st	6820 st	6820 wk	—	6830 st	6830 wk	—	6820 st	6820 wk-m	6830 st	—
6806 st	6800 st	—	—	—	—	—	—	—	—	—	—
—	—	6740 m	6740 wk	—	—	—	—	—	—	—	—
6620 wk	—	6620 m	6620 wk	—	6640 wk	6640 wk	—	6640 m	6640 wk	6630 wk	—
6460 wk	—	—	—	—	6400- 6500 m, h	6400- 6500 wk	—	6450- 6500 m-st	6450- 6500 wk	6450- 6500 v wk	— h
6370 st	6370 st	—	—	—	—	—	6380 wk	—	—	—	—
—	6250- 5800	6300 wk	6300 st	—	6300 v wk	—	—	6320 wk	6320 v wk	—	—
4774	4775 4725	—	5940- 6100 h	—	6000 ^d vv wk	—	6000 ^d wk, h	—	6000 ^d wk	—	5800- 6300 v wk

Principal source: G. O. Wild and H. Biegel, *Lichtabsorption am Smaragd*, *Achat* 1 (1948) no. 1/2, pp. 16-17.

^aB. W. Anderson, *Gem Testing*, 8th ed. (London: Butterworths, 1971), p. 156.

^bR. Webster, *Gems*, 3rd ed. (London: Butterworths, 1975), p. 98.

h = hazy, m = medium, st = strong, v = very, wk = weak.

table 8-2. The general range runs from about 5800 Å to about 6890 Å, and it is the suppression of wavelengths in this range, corresponding to the "warm" colors of yellow, orange, and red, that results in the green and violet portion of the spectrum being emphasized in the gems and the interpretation by the human eye that a "green" color of "cool" character is being viewed. Differences in color absorption also appear according to crystallographic direction. For example, in an "igmerald" synthetic manufactured by I. G. Farbenindustrie, the range for the extraordinary *e*-ray was found to be somewhat lower in wavelength than that for the ordinary *o*-ray.

Color and Luminescence

Table 8-2 (continued)
ABSORPTION SPECTRA IN EMERALD (Å)

Unknown Source		Unknown Source		I. G. Farben		I. G. Farben ^c		Nacken	
Dark Green		Dark Green		Unstated Color		Yellow Core, Green Rim		Blue-Green	
<i>e</i>	<i>o</i>	<i>e</i>	<i>o</i>	<i>e</i>	<i>o</i>	<i>e</i>	<i>o</i>	<i>e</i>	<i>o</i>
6890 st	6850 wk	—	—	—	—	—	—	—	—
—	—	6820 st	6820 wk	6820 st	6820 wk	—	6830 sharp	6820 wk	—
6630 m	—	6620 m	—	6620 m, h	—	—	—	6620 m	—
6450 m-st	—	6450 st, h	—	6450 st	6450 m-wk	6450 sharp	6450- 6500 h, wk-m	6450- 6500 st, h	—
6380 v wk	6380 m	—	6380 m sharp	6380 wk	—	—	6380 sharp	—	6380 sharp
—	—	6330 wk	—	6330 wk	—	—	—	—	—
—	5850- 6150 wk	—	6000 ^d	5950 & 6080 m	5900- 6100 wk, h	6000 ^d st	6000 ^d st	—	—

^cplate cut normal to *c*-axis.

^dabsorption center.

h = hazy, m = medium, st = strong, v = very, wk = weak.

In an attempt to determine directly the influence of foreign ions on the color of beryl, Ristic and Eichoff¹⁷ grew synthetic beryl crystals "doped" with small amounts of foreign ions and studied the crystals spectrophotometrically. They concluded that the color of emerald was certainly caused by chromium, and found that neither scandium nor vanadium produced any color. However, the role of vanadium in inducing color in emerald was affirmed in recent investigations by Wood and Nassau,¹⁸ who examined specimens from Bahia, Brazil, and found that despite their color being similar to that of ordinary emeralds, Cr was present in only 3 ppm and vanadium was present in substantial amounts, probably as V³⁺ ions occupying octahedral Al³⁺ sites in the structure. As reported in Linares et al.,¹⁹ Wood and Nassau noted that beryl crystals grown in lithium vanadate or vanadium oxide flux

CHEMICAL AND PHYSICAL PROPERTIES

are colorless, and suggested that in both these fluxes the vanadium is V^{5+} (pentavalent), while in the beryl structure, only the V^{3+} (trivalent) ion can be accommodated, presumably in the site occupied by Al^{3+} . Wood and Nassau also showed that the spectral absorptions of ordinary emerald and the vanadian Bahia emerald are approximately similar¹⁹ (p. 789) and account for similarity in final color. Some differences are noticeable, however, especially the absence in vanadian emeralds of the sharp Cr-absorption peaks located at 4760 Å, 6800 Å, and 6830 Å found in ordinary emeralds.

In 1970, Nassau and Jackson²⁰ confirmed the presence of both Cr and V in the trapiche emeralds of Muzo. X-ray fluorescence analyses indicated 0.10% Cr and 0.12% V in clear material. In a study of the V^{3+} ion in silicate and oxide minerals, Schmetzer²¹ stated that in minerals such as beryl in which both Cr^{3+} and V^{3+} were coloring ions, the absorption curves due to each coincided for the most part, the net effect being an intensification of the green color beyond that caused by Cr^{3+} alone.

The establishment of vanadium as a coloring ion in emerald led to a lively controversy as to whether or not vanadian emerald-like beryls should be called emerald, in spite of the fact that, as Wood and Nassau¹⁸ pointed out, numerous emeralds are known which contain both chromium and vanadium. They suggested that if Cr is present to about 0.1% or more, the beryl could retain its classic name, and that another name be given to those in which V is the primary coloring ion.

The extensive study of causes of color in beryls by Schmetzer et al.²² (p. 25 ff.) noted the general coincidence of absorption curves for two groups of emerald-colored beryls, the "Cr emeralds," containing Cr and Fe, and the "V emeralds," containing V, Fe, and some Cr. They further noted that they could find only forty spectral studies of emeralds and suggested that this is insufficient evidence to establish any firm conclusions concerning cause of color. Until many more analyses are performed, the relative abundances of Cr and V, perhaps as coupled with Fe, cannot be established, although it seems clear that if both Cr and V are coloring ions, both Cr emeralds and V emeralds are equally deserving of the name. It would be interesting, for example, to analyze numerous specimens of Egyptian emeralds to determine relative abundances of these elements. If vanadium is found in them, then such beryls would qualify as "emeralds" on the basis of priority naming.

Absorption spectra for emerald are conveniently presented in Webster²³ (pp. 98, 668, 820) and more recently in Schmetzer et al.²² (pp. 25-9), the latter containing numerous references to the literature on beryl color. For gemological examinations with the hand spectroscope the data in Webster are perhaps more useful. He noted (p. 98) that distinct differences may be observed according to the direction in the crystal examined, or if only the *o*-ray or both *o*- and *e*-rays are being examined. Commonly, the *o*-ray shows only two narrow absorption bands in the red

Color and Luminescence

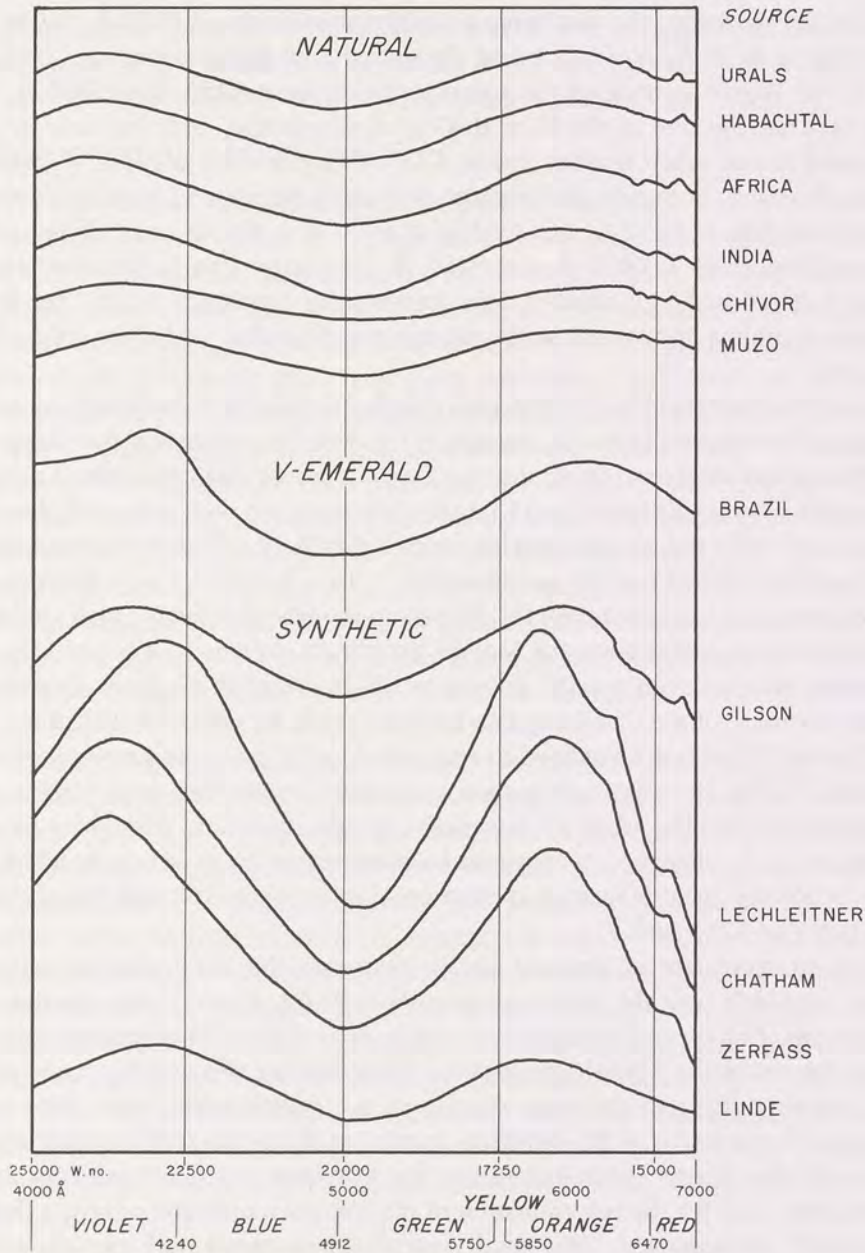

Fig. 8-4 Emerald absorption curves for natural specimens, a natural vanadium emerald, and several synthetics. The strong transmission in the blue-green region is readily apparent. Based on curves of K. Schmetzer et al., Über die mineralart Beryll, ihre Farben und Absorptionsspektren, *Zeitschrift der deutschen gemmologischen Gesellschaft* 23 (1974):5-39.

CHEMICAL AND PHYSICAL PROPERTIES

portion of the spectrum, the first being a doublet at 6830 Å and 6800 Å, the second a sharp line at 6370 Å. A weak, broad absorption with vague boundaries obscures much of the yellow portion of the spectrum from about 6250 Å to 5800 Å, and "there is a narrow line in the blue at 4775 Å which may only be seen in very chrome-rich stones when another line at 4725 Å may also be noticed." When the *e*-ray is observed, however, the doublet previously mentioned appears stronger, especially the line at 6830 Å, but the line at 6370 Å is absent and its place taken by two diffuse lines at 6620 Å and 6460 Å. The latter line is bordered on the shortwave or red end by "characteristic transparency patches," while "the broad absorption region is now nearer to the red and much weaker, and there are no lines in the blue."

Absorption coefficients for both rays in emerald have been calculated by Wood and Nassau¹⁸ in relation to weight percent of Cr, with the suggestion that these may be applied to any sample to determine the approximate Cr quantity without destructive analysis. Barriga Villalba³ (p. 115) noted in connection with color of Colombian emeralds that while the specific gravity varies but little, it seems to "depend on the color," and he reported specific gravities ranging from 2.5664 for very pale material to 2.6890 for first-class, pure emerald. However, in view of the very small quantities of Cr involved in substitution for ions in the crystal structure, it is unlikely that measurable differences in specific gravity would be found in all cases. Correlation between emerald color and density has not been made by other investigators.

That the Cr ion is not confined to emerald alone is shown by the work of Wild and Biegel.²⁴ The Brazilian beryls they investigated resembled aquamarines generally, but with the blue-green tint suggestive of emerald color. When heat-treated, the color scarcely changed, as it would be expected to do in beryls in which the principal coloring agent is iron. A spectroscopic examination showed that the color was in part due to Cr and V.

In hand specimens of emerald and in cut gems, the differences of color depending on which way the light rays pass through the crystal may sometimes be quite obvious. In a typical hexagonal crystal, provided it is transparent enough, one will see the decidedly blueish-green color when looking through the sides of the prism (corresponding to the *e*-ray direction) and a yellowish-green color when looking down the prism in the direction parallel to the prism faces (corresponding to the *o*-ray direction). These differences are less easy to see in cut gems unless they are large, and for the determination of the two colors the gemologist's dichroscope usually is employed. This small instrument examines each ray separately, showing their colors in small, side-by-side windows which make the comparison easy.

In terms of cut gems, usually fashioned as step-cuts, the shape of natural crystals encourages the lapidary to cut the gem so that the table facet is parallel to

Color and Luminescence

the prism faces. Thus the color seen in such a gem is largely the blueish-green prized by most connoisseurs of emeralds above the yellowish-green that would appear if the gem were cut with the table perpendicular to the *c*-axis.

COLOR FILTERS FOR EMERALD

As mentioned earlier, the light that passes through the emerald contains all wavelengths, not just green or blue-green. Other wavelengths, in the yellow, orange, and red ranges are suppressed but far from eliminated. In fact, so much red still passes that a clever optical filtering device was devised many years ago to take advantage of this phenomenon and serve as an additional means of testing emeralds, particularly to distinguish them from glass imitations. Such filters are designed to absorb green but pass red, and thus make an emerald look red when viewed through the filter whereas many imitations appear some dull color, vastly different in appearance from emerald. An early filter was devised by Wild,²⁵ but the "Chelsea filter," named after the gemological laboratory in London where it was devised by Anderson²⁶ and Payne, has proven to be the most satisfactory. As described by Popley,²⁷ "it consists of two gelatine filters, one transmitting light from 5400–7200 Å and the other 3600–5800 Å, and in addition a narrow band in the deep red. These are cemented together and the combined effect of the two filters is to transmit two bands of light, one a yellow-green (5500–5800 Å) and the other red (6850–7650 Å)."

In use, the filter permits light of these two bands to reach the eye, giving the impression of some brownish hue if both red and green are transmitted at once, as would be the case in glass imitations. However, in emerald, the balance is upset, and the eye receives the impression that the stone is red. Webster²³ (p. 646) noted the effectiveness of the filter for dark-colored emeralds from Colombia or the Urals, the effect being more pronounced the darker the hue, but cautioned that in South African and Indian emeralds the change to red does not take place. For this reason, and also for the fact that some other non-beryl gemstones may also appear red in the filter (Webster,²³ table 9, p. 817), discretion must be employed in its use. Webster notes that the Chelsea filter may be useful in indicating synthetic emeralds since their color is due entirely to chromium and they consequently show a remarkable ruby-red upon viewing through the filter. Another filter for emerald was developed by F. Vandrey of Göttingen and described by Gliszczynski,²⁸ but it is rarely used.

AQUAMARINE, YELLOW BERYL AND GOSHENITE

The color traditionally associated with aquamarine, or "water of the sea," is sea-green or pale green with decided tinges of blue. Apparently pure blue aquamarines were very rare in antiquity, and there seems little doubt that the finest of

CHEMICAL AND PHYSICAL PROPERTIES

their kind have been found only in modern times. Infinite gradations in tone occur between pale green and pale blue varieties, some specimens being so pale in hue that they seem colorless until laid upon a piece of white paper. Numerous beryls verge on greenish yellow, usually weak in tint, but may pass by insensible degrees into pure yellow. Some rare specimens are yellow-green, or chartreuse, sometimes of medium intensity and very attractive. It has been found that this color variety is susceptible to color change if heat-treated, turning to a beautiful pure blue. A remarkable blue aquamarine, known as Maxixe-type beryl, occurs in several deposits in Brazil and furnishes the darkest of all pure-blue aquamarines. However, as will be discussed below, the color seems to be induced by natural radiation and is easily lost by exposure to sunlight or heat.

The name goshenite was given originally to very light-colored beryls found near Goshen, Massachusetts, which contained alkalis. Today the name signifies any colorless beryl and includes not only alkali types but also those that belong among the aquamarines because of their chemical composition and properties.

In 1934, Klang²⁹ published absorption curves for aquamarine-group beryls, including some yellow and green specimens, and concluded that Fe^{2+} and Fe^{3+} were responsible for the color. Jayaraman³⁰ investigated blue, green, greenish blue, yellowish green, and colorless beryls from Nellore, India, and came to the same conclusion, noting further that the intensity of color seemed proportional to the content of Fe^{3+} in blue beryls and to Fe^{2+} in green beryls. Borovik³¹ found that scandium (Sc), the element causing the blue color in bazzite (the scandian analogue of beryl), was present in appreciable quantities only in colored beryls and suggested that it may be the coloring ion in some blue aquamarines. However, Mukherjee³² examined beryls for Sc and found only extremely small amounts in a few Indian specimens and concluded that this element was not involved in their coloration, a conclusion also reached by Ristic and Eichhoff.¹⁷

The role of iron in coloring members of the aquamarine group was studied by Wood and Nassau,¹⁸ whose findings are summarized in table 8-3. Iron as a cause of color in beryl has also been investigated by Goldman, et al,^{18a} who conclude that Fe^{2+} occurs in channel sites and is much more powerful in causing color (blue) than the Fe^{2+} in octahedral sites. They also attribute yellow to Fe^{3+} and note also that when both ions are present in beryls, the resultant color depends on the proportions of each, thus explaining the gamut of hues that may be observed from pure blue to various shades of blue-green, green, yellow-green, and yellow (see also Rossman⁹⁵).

Webster²³ (pp. 101, 820) discussed spectroscopic examination of aquamarines and noted that the absorption spectrum "is not very pronounced," there being a "somewhat broad band in the violet at 4270 Å and a feeble diffuse band in the blue-violet at 4560 Å." Furthermore, "the extraordinary ray, which can be isolated

Color and Luminescence

Table 8-3
FIVE TYPES OF IRON IN BERYL

<i>Optical Characteristic</i>	<i>Possible Assignment</i>	<i>Observed Coloration</i>
8100 Å, <i>o</i> -ray, broad band, single component	Fe ²⁺ in octahedral Al site	none
8100 Å, <i>e</i> -ray, broad band, more than one component	Fe ²⁺ in channel site A	none
6200 Å, <i>e</i> -ray, broad band, single component	Fe ²⁺ in channel site B	blue
4000 Å, <i>o</i> and <i>e</i> edge absorption	Fe ³⁺ in octahedral Al site	yellow
3740 Å, <i>o</i> ; 4650 Å, <i>o</i> and <i>e</i> , narrow bands	Fe ³⁺ in tetrahedral Si site	none

Source: Wood and Nassau,¹⁸ p. 797.

by the use of a polaroid disc, shows these bands more strongly, and, in such conditions, there may be detected a narrow and delicate absorption line in the middle green at 5370 Å . . . seen in natural greenish aquamarines, and in yellow and colourless beryls, but is not seen in the heat treated blue aquamarines.”

From absorption studies of typical aquamarines, Schmetzer et al.²² also concluded that the bluish and sea-green hues are caused mainly by divalent and trivalent iron, but found that other transition elements were also present, some contributing color. In the case of divalent manganese (Mn²⁺), this ion occupies the same octahedral sites that Fe³⁺ does, but apparently it contributes nothing to color. Analyses of aquamarines revealed that, in addition to iron, yellow beryl contained some Mn, green beryl contained some Cr and Mn, and blue beryl contained some V, Cr, and Mn.

The spectra of yellow, green, and blue beryls show two principal color-causing components, a broad absorption band in the red-yellow region, possibly due to charge transfers between Fe²⁺ in tetrahedral sites and Fe³⁺ in octahedral sites, and a strong absorption toward the blue-violet. If the latter is present alone, the resultant color is yellow; if the first absorption band is present alone, the color is blue; if both bands are present, the color may range through an infinite number of shades between yellow and blue, including the various greens caused by their blending. In some yellow Brazilian beryls titanium is present as Ti³⁺ and occupies octahedral sites in the structure.

As observed through the dichroscope, differences in color noted along the *o*-ray and *e*-ray directions are weak but distinct. In blue aquamarines, the color is generally blue and very pale blue; in greenish specimens, green and paler green; and in yellow beryls, yellow and very pale yellow.

CHEMICAL AND PHYSICAL PROPERTIES

MAXIXE-TYPE BERYLS

In 1917, splendid dark blue beryls were found in the Maxixe mine, Piauh region, Minas Gerais, Brazil, and at once aroused a lively demand until it was found that stones faded when exposed to light.^{33,34,35} In about 1970 blue and green crystals of similar material came upon the market and were examined by Nassau and Wood.^{36,37,38} It is not known if this new material is from the same locality in Brazil, but it behaved like the original Maxixe mine beryl in respect to loss of color. Early work on the original Maxixe beryls gave refractive indexes of $o = 1.5920$ (cobalt blue) and $e = 1.58442$ (colorless), specific gravity = 2.805, while another source³³ gave 2.797 for the specific gravity and a composition in which the following minor constituents were present: Fe_2O_3 , 0.03%; MgO , 0.25%; CaO , 0.22%; CuO , trace; Li_2O , 0.98%; Na_2O , 1.28%; Cs_2O , 2.80%; and B_2O_3 , 0.39%, with ignition loss of 2.20%.³⁵

According to Nassau and Wood³⁶ (pp. 1052–3) after examining beryl from ca. 1973, “none of the color-causing transition elements . . . [is] present in amounts large enough to explain a blue color except in the green rough, where it is clear from the spectrum . . . that the Fe present provides only the yellow component.” They also dismissed the possible role of the alkali elements as Li, Na, K, and Cs as well as Sc in causing color, noting their amounts are “not unusual in beryls and cannot account for the color either.”

The most probable cause of color in both the blue and green varieties is a color center, or a defect in the structure, usually of the type where an atom is missing and the vacancy occupied by an electron. The electron is free to vibrate and, in so doing, is capable of absorbing certain wavelengths of light, with the result that the remaining wavelengths reach the observer's eye and give the sensation of color. Such a color center is commonly produced by irradiation and often easily destroyed by light and heat. These centers in the new beryl have been found by Andersson,³⁹ who used a microwave irradiation technique (electron paramagnetic resonance) to establish that “the colour arises from different impurity ions which have lost one electron, probably by irradiation, to form CO_3 colour centres in the Maxixe-type beryl and NO_3 colour centres in the [original] Maxixe beryl.”

The new rough fades in light, bleaching quickly to a pale yellowish hue if heat-treated. The absorptions for the o - and e -rays of both the old and new materials were compared by Nassau and Wood³⁶ (p. 1034) to ordinary blue and green aquamarine. In two new specimens and one of the original find, all blue in color, a uniform absorption appeared throughout much of the visible spectrum for the e -ray, which therefore appeared colorless in one window of the dichroscope, while for the o -ray, maximum absorption occurred in the yellow-orange-red region, with the result that much blue was transmitted and this color was seen in the other window of the dichroscope.

Color and Luminescence

Table 8-4
NARROW BAND ABSORPTIONS, MAXIXE-TYPE BERYLS

Original Material (blue)	New Material (blue and green)
5560 Å	5560 Å
5830	5720
5960	5870
6070	6040
6170	6240
6300	6420
6560	6880
7010	

Source: Nassau and Wood,³⁶ p. 1036.

The green material from the new source displayed similar absorptions, but with the important difference that intense absorption due to Fe^{3+} suppressed passage of blue light and gave better transmission in the green, thus imparting this hue to the *o*-ray. The *e*-ray, instead of being colorless, was pale yellow. Table 8-4 taken from Nassau and Wood's article, gives narrow-band wavelengths of the old and new Maxixe-type specimens.

Maxixe-type beryl was also examined by Schmetzer, et al.²² (pp. 23-4) who also suggested that the color was due to activation of a color center through irradiation.

COLOR FILTERS FOR AQUAMARINES

Upon the suggestion of G. O. Wild, a filter for distinguishing aquamarine from similarly colored synthetic spinels was devised by F. Vandrey, described by Gliszczynski.⁴⁰ Blue synthetic spinels absorb in the yellow of the spectrum but transmit red, while aquamarines absorb in the red but transmit green. Thus with the Vandrey filter, which transmits green and red, a synthetic spinel appears entirely red but an aquamarine appears a more or less intense emerald green. Some limitations on the use of this filter were pointed out in a subsequent article.⁴¹ Under the Chelsea filter, aquamarines appear a distinctive green²³ (p. 817).

HELIODOR

Heliodor, or literally "sun-gilded," is a name originally applied to fine golden beryl from a pegmatite deposit near Rössing, South West Africa, by the Kolonialgesellschaft für Deutsch-Sudwestafrika sometime before 1914 in order to gain pub-

CHEMICAL AND PHYSICAL PROPERTIES

licity for the new discovery. Much acclaim resulted as the "new" gemstone, set in jewelry designed by the noted artist Lucas von Cranach, was presented to Kaiser Wilhelm II and his wife. Claims were made that the gemstone was unique, and several properties were set forth which were said to distinguish it from ordinary yellow beryls, among them a perceptible blue phosphorescence when irradiated with cathode rays, an "opalescence," a weak green fluorescence, and alexandrite-like color change between daylight and artificial light (yellow to a decided greenish tinge), and a weak radioactivity. All of these claims were investigated by Eppler,⁴² who systematically demolished them. Today, the name has no special significance, other than to afford an alternate for the names yellow or golden beryl.

PINK (MORGANITE) AND ORANGE BERYLS

The cause of color in pink and orange beryls has not been investigated thoroughly, most authorities assuming that the color in pink beryls is due to manganese. Cobalt and cesium have been virtually ruled out as coloring agents in natural beryl. In 1955, Ristic and Eichoff¹⁷ induced rose color in synthetic beryl through addition of small amounts of cobalt, but when absorption curves for this material and natural rose beryl were compared, the great dissimilarities convinced them that cobalt could not be the cause of the rose color in natural material. They also synthesized a cesium (Cs) beryl, using about the same amount of Cs as is found in natural specimens, but could not induce any color, again concluding that this ion was not responsible for the pink color in natural material. So far as is known, no one has attempted to "dope" synthetic beryl to see if a pink color results.

Several speculations about the role of alkali ions, notably lithium and cesium, in the coloration of beryls appear in Schmetzer et al.²² (p. 29), who also provided absorption curves for several rose beryls and two orangey ("apricot" or "salmon") beryls from Brazil. Wood and Nassau¹⁸ analyzed numerous pink beryls and found that manganese was one element common to all, and suggested that the cause of color could be Mn^{2+} and Mn^{3+} substitutions for Al in an octahedral site or for either Be or Si in a tetrahedral site. However, after examining the spectra produced by rose beryls, they concluded that only Mn^{2+} was involved. Absorptions were given for the *o*-ray at 4950 Å and 5400 Å, and for the *e*-ray at 3550 Å and 5550 Å. Schmetzer et al.²² compared Wood's and Nassau's results to their own and concluded that Mn^{2+} may be responsible for the color in rose or pink beryls but that much work needed to be done to be certain.

In the orangey beryls, which appeared in the 1960's from Brazil, sometimes likened to the color of apricot or salmon, Schmetzer et al. found Mn, V, Fe, and some Cr, with absorption in the blue region and almost uniform transmission in wavelengths toward yellow and red. Bleaching or heat treatment of these curious beryls results in a final pink color that seems permanent, but no explanation of the disappearance of the yellow component of the orange hue has been offered.

Color and Luminescence

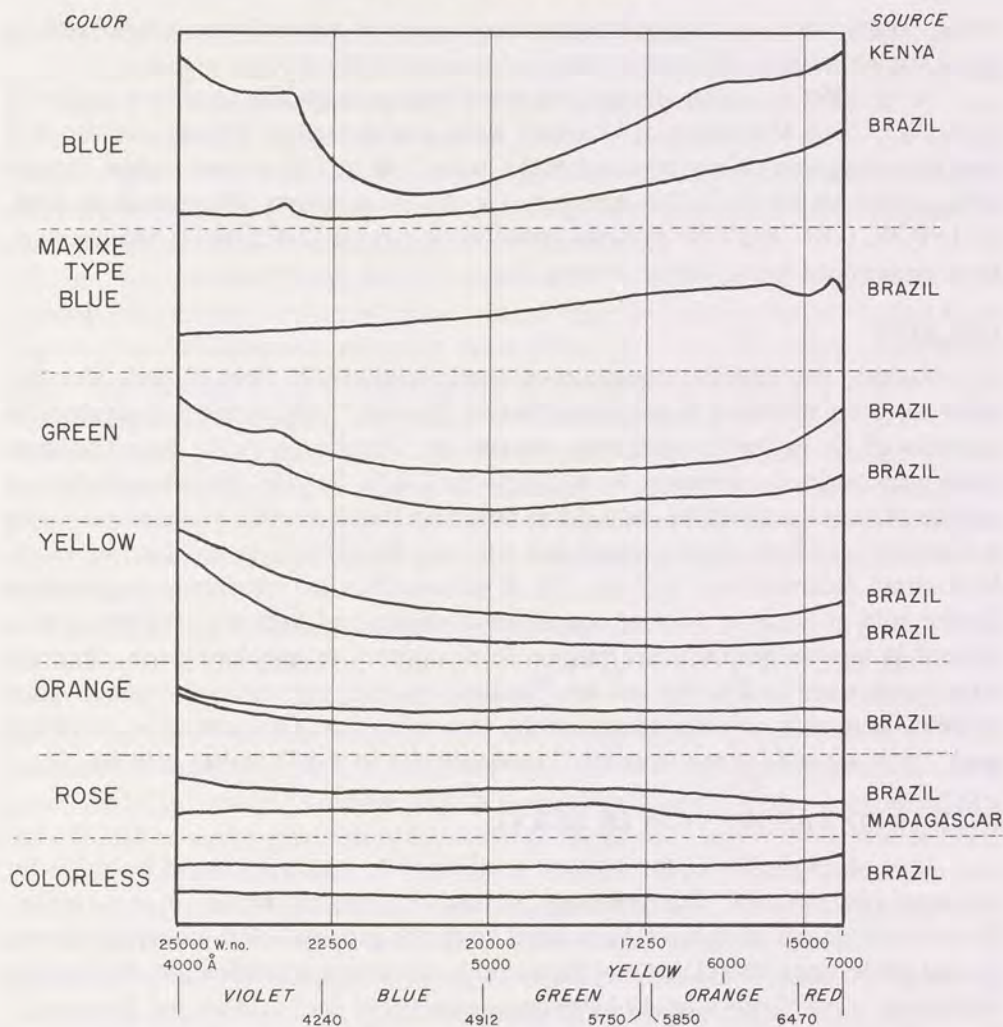

Fig. 8-5 Generalized absorption curves for beryls showing differential transmission of light in the visible spectrum. The flatness of the curves reflects the generally pale coloration of beryls but compare to the darker hues observed in emerald (see figure 8-4). Based on curves of K. Schmetzer et al. *Über die mineralart Beryll, ihre Farben und Absorptionsspektren, Zeitschrift der deutschen gemmologischen Gesellschaft* 23 (1974):5-39.

RED BERYL OR "BIXBITE"

Early in this century, a true red beryl was found in minute crystals in rhyolite cavities in Utah's Thomas Range. In 1912, Eppler⁴³ (p. 253) called it "bixbit," apparently named after Maynard Bixby, a well-known mineral collector of Utah who had found the material and distributed specimens to collections throughout the

CHEMICAL AND PHYSICAL PROPERTIES

world. The name is unfortunately sometimes confused with bixbyite, a valid species name for an entirely different mineral, also named after Bixby.

In the 1960's, similar, larger, and sometimes gem-quality crystals were found in the Wah Wah Mountains of Utah and were investigated by Nassau and Wood.⁴⁴ Spectral absorption studies revealed peaks in the 0.48 to 0.55 micron region, "probably caused by Mn^{2+} ." The spectrum for the *o*-ray shows absorptions at 0.48, 0.51, 0.78, 0.81, and 0.84 microns, and for the *e*-ray at 0.425 and 0.545 microns, such absorptions being "quite intense."

BAZZITE

Bazzite, the scandian analogue of beryl, is generally light to dark blue. Its color has been attributed to scandium (Sc) by Borovik,⁴⁵ who noted that appreciable amounts of Sc in beryls other than bazzite are found only in the blue varieties, some aquamarines containing from 0.02% to 0.03% Sc. He also showed that an intense blue color could be induced in colorless beryl powder by admixture with a colorless scandium oxide powder and allowing the mixture to rest for two years. In contrast, Schmetzer et al.²² (pp. 32-3) claimed that no satisfactory explanation for the role of Sc as a coloring ion in beryl exists, and further noted that iron is present in natural bazzites and cannot be discounted as a coloring ion. Bazzites were synthesized by Frondel and Ito,⁴⁶ but the crystals were extremely small. They made no comment on color except in the case of an Sc-Cr bazzite, whose crystals were "pale emerald green in color," probably due to the Cr rather than the Sc.

INFRARED ABSORPTION IN BERYL

Absorption studies in the infrared portion of the spectrum are of no value for ordinary spectroscopic examinations because the eye cannot see in this region. However, infrared rays have been used with the purpose of discovering further optical properties of beryl that may be useful in laboratory identification of minerals, including beryl. Such studies have been conducted by Matossi and Bronder,⁴⁷ Omori,⁴⁸ Saksena,⁴⁹ Vincent-Geisse and Lecomte,⁵⁰ Plyusnina,⁵¹ and Wood and Nassau.⁵² Absorptions in the infrared and other regions of the spectrum, as well as fluorescence and Zeeman effect in emerald were studied by Wood,⁵³ while Flanigen et al.⁵⁴ studied the infrared spectrum of Linde hydrothermal and flux-grown emeralds, suggesting as a result of their studies that it may be possible to distinguish flux-grown emeralds, which lack water, from those grown hydrothermally. The Raman effect in beryls was studied by Nisi,⁵⁵ Kopcewicz,⁵⁶ and Michalke.⁵⁷

COLOR CHANGES INDUCED BY HEAT

Altering the color of gemstones by heating them is a practice of long-standing whose beginnings are lost in the mists of time. In India, for example, the natives

Color and Luminescence

in certain of the agate-producing areas heat-treated ordinary agates and chalcedonies to produce bright red carnelian. In Southeast Asia, the practice of heat-treating brownish and reddish zircon crystals to colorless, golden and even vivid blue apparently is very old. Much less is known in the case of beryls, except that by the Middle Ages it was established that emerald could be intensely heated, losing its color while hot, but resuming it upon cooling. The systematic heat-treatment of other beryls seems to be a relatively recent innovation.

In 1893, Doelter⁵⁸ published his *Edelsteinkunde* and included for the first time considerable scientific information on color changes induced in beryls through heat-treatment in oxidizing and reducing atmospheres (p. 106). For many years thereafter, he concerned himself with experiments in heat-treatment and irradiation of minerals, publishing numerous articles and several books on the subject. In his *Edelsteinkunde*, for example, he mentioned that he could readily change yellow beryls to blue by heating in an oxygen atmosphere, and that he could change the yellow component in greenish-blue beryls to blue, thus converting them to a pure blue hue. However, such beryls (but not emeralds), if heated to bright red, lost their color entirely.

In 1888, Joly⁵⁹ reported that at a temperature of 357°C yellow and green beryls became completely colorless. Hermann⁶⁰ found that heating beryls in oxygen to about 700°C for two hours caused common yellowish-gray beryl to lose all color but had no effect on the color of emerald. In illuminating gas, rich in CO and therefore reducing in effect, a beryl previously heated in oxygen turned to deep gray, while an emerald seemed to pale somewhat, leading to the conclusion that the color in common greenish and yellowish beryls was caused by oxides of iron.

In the same year, Doelter⁶¹ published results of irradiation/heat-treatment experiments and noted that emerald from Habachtal, Austria, did not lose color even when heated to a white heat, ca. 1200°C. Other experiments by Doelter^{62,63,64} confirmed that greenish and yellowish beryls could be changed to blue by heating in an oxygen atmosphere and could be decolorized by prolonged, strong heating. Additional confirmation of these results was given in 1923 by Wild and Liesegang,⁶⁵ In 1927, Kurbatov and Kargin⁶⁶ heated pale green beryl from Sherlova Mountain, Transbaikalia, and noted commencement of color change from greenish to blue at about 400°C, with the change completed at the end of one hour at 425°C, or in only one-half hour at 450°C. They concluded that iron, shown to be present in an analysis, was the element involved in the production of color.

Further results are contained in Wild,⁶⁷ wherein greenish beryl, heated to 420°C changed to blue, yellow beryl heated to 400°C changed to "light blue-white," and a "brownish beryl" heated to 400°C changed to pink. This last specimen, unfortunately, was not further identified and may have been an alkali variety. Jayaraman³⁰ treated Nellore, India, beryls and found that upon subjecting greenish, greenish-

CHEMICAL AND PHYSICAL PROPERTIES

blue, and greenish-yellow beryls to 500°C for five hours, all changed to blue. However, these blues, as well as other colorless beryls, did not change hue with further heating. In his opinion, the blue color was caused by Fe_2O_3 , while the green was due to FeO .

In 1941, Gavrusovich and Sarapulov⁶⁸ heated blue and green beryls, noting that below 600°C they tended to become paler, but to a very variable extent, and confirmed Doelter's conclusion that aquamarines lose color while emeralds do not. They found that beryls heated between 800–1200°C lost their transparency, ultimately becoming opaque white and resembling porcelain.

In 1952, Frondel⁶⁹ conducted heat-treatment experiments on a variety of beryls and found that emeralds did not change color up to 1025°C, the red beryl of Utah also remaining unchanged at this temperature, but morganite, stable in color up to 400°C, began to bleach at 440°C in a ten-hour period, then rapidly decolorized at 495°C. A pure, golden-brown beryl without a trace of green became completely colorless when heated many hours at 250°C, with the bleaching rate dependent upon the temperature, bleaching proceeding fairly quickly at 275–300°C. Greenish-yellow, olive-brown, and yellowish-green specimens heated in the range of 250–280°C lost their yellow component and resulted in final hues of green, which then turned to blue when the specimens were heated over 280–300°C. Apparently, claimed Frondel, all greenish beryl turns blue, the latter color first appearing in the range 280–300°C, with the rate of change increasing with rising temperature. Over 400°C the change takes place in a matter of minutes. However, if insufficiently heated, such material may retain a greenish-blue cast.

As had been found before, Frondel found that the final intensity of blue after heat-treatment depends on the intensity of the starting color, the deeper hues producing a darker blue. In this connection, the best blue was obtained from beryls of dark oil-green or olive-green color, while pale greenish stones provided only weak blues. The blue color obtained by such treatment is stable up to 1025°C, as is the blue found in some untreated stones. In summary, the optimum treatment range is 400–450°C, which is high enough to produce quick results but not so high that cracking and turbidity become problems.

At very high temperatures, beryls first acquire milkiess, then become opaque white and porcelain-like in texture and appearance, accompanied by a distinct prismatic cleavage. Curiously, when overheated beryls that contain cleavage cracks, but retain sufficient translucency are cut as cabochons, oriented with the bases across the *c*-axis, a six-rayed star appears

Srinivasan⁷⁰ heat-treated Nellore, India, beryls and found that blue specimens became paler when heated up to 1100°C in 100°C increments, each held for about three hours. Greenish-tinged areas began to disappear at about 200°C to form brown-

Color and Luminescence

ish patches, although those portions which were blue to begin with did not change. From 500°C to 700°C, the blue became paler and the brownish hue intensified, and at 700°C, the blue lightened with commencement of turbidity. The brownish patches remained up to 900°C, while by the time 1100°C had been reached, the specimen as a whole developed a dark gray-blue color interspersed with brown streaks. At 1450°C the specimen fused into an ash-colored porous mass. Nellore beryl contains iron and analyses showed a significant increase in Fe^{3+} in green and greenish-yellow samples previously heated to 500°C.

A study of heat changes in beryls conducted by Wirsching and reported by Schmetzer et al.²² showed that blue remained unaltered, while green turned to blue and yellow turned to green. Experiments on changing color of emerald were also conducted but the changes, if present at all, were insignificant. On the other hand, it was shown that morganites could be decolorized by heating. In a later work by the same authors⁷¹ on color changes in beryl, it was found that iron-free yellowish specimens changed to colorless after heating in air at 500°C for three hours, while iron-containing blue, blue-green, green, yellow-green, and yellow samples turned to blue under the same conditions. Both Cr and V emeralds failed to change color, or perhaps became somewhat darker with development of black flecks, but blue-green beryls containing Fe and V remained the same color, or, if originally green, changed to blue-green. Morganite, whose coloring ion was attributed to manganese, changed to colorless, while the orange variety changed to rose or colorless. Maxixe-type specimens, selected on the basis of typical absorptions in the red region of the spectrum, were also tested but with somewhat anomalous results. For example, blue specimens, possibly already irradiated, turned to colorless or rose, but another blue specimen remained blue. A rose beryl, presumably a normal morganite except for the absorption in the red typical of Maxixe beryls, also remained rose after heating. Heating trials were also conducted on colorless varieties but without inducing any color.

HEAT-TREATMENT METHODS

As noted in Chapter 6, beryls are remarkably low in coefficients of thermal expansion, which means that flawless pieces can be subjected to considerable heat without fear of cracking. Nevertheless, precautions must be taken to prevent abrupt changes in temperature. The methods of applying heat range from those that are extremely crude to some that are quite refined, such as heating in electronically controlled ovens programmed to gradually raise and lower temperatures over set periods of time. The choice of specimens is equally important, those with obvious inclusions being likely to fracture as the inclusion contents expand, or those with fractures merely enlarging along them until the stones fall apart. It has been found

CHEMICAL AND PHYSICAL PROPERTIES

best to treat cut gems because these can be examined to insure that none of these defects are present. The greatest danger is always impatience to see results and opening the oven before the contents have reached room temperature.

Among crude methods, Frondel⁶⁹ noted the practice in Brazil of embedding the stones in ordinary bread dough and baking in an oven. Another simple method involves placing the stone in a test tube, stoppering the open end with cotton, and then heating over a gas flame until the color change takes place. Bastos⁷² stated that "about 90% of the green and pink beryls [of Brazil] are heat treated," and that the test-tube method with alcohol flame is most commonly used, it taking about 5 to 30 minutes to remove the green tinge from an aquamarine, "according to the place where the stones came from." He emphasized that the stones must be flawless. This treatment was also used to convert salmon-hued morganites to pure pink, but as I found out for myself, it is only necessary to place them in direct sunlight over a period of about a week to more safely accomplish the same result.

COLOR CHANGES INDUCED BY IRRADIATION

The discovery of x-rays by Roentgen in 1895, followed the next year by the discovery of radioactive emissions from a uranium compound by Becquerel, prompted experiments to see what would happen to gemstones if they were subjected to such radiations. It was soon found that color changes could be induced in a number of gemstones, including beryls.

An early experiment involving the effects of radium irradiation of beryl took place in 1906 when Miethel⁷³ subjected Colombian emerald to barium-radium bromide and noted that the color became paler after several days and finally reached a very pale hue. The absorption spectrum was unchanged, but the bands were weaker. Heating the specimen to 250°C brought no change. Doelter^{61,62,63,64} used x-rays and gamma-rays from radioactive sources and found that, in general, x-rays did not substantially affect the color of emerald even when coupled with heat treatments. Lind and Bardwell⁷⁴ found that neither natural nor synthetic emerald experienced any change in color under alpha radiation, but a synthetic emerald exposed for a long period showed a faint green phosphorescence when heated to 200°C. Pough and Rogers⁷⁵ tested numerous gemstones under x-rays and also found that emerald was unaffected. However, electron bombardment did induce a grayish-green hue, according to a later paper by Pough.⁷⁶

Schmetzer et al.⁷¹ found neither Cr nor V emeralds affected by x-rays, gamma rays, and electron bombardment, but they noted in some specimens a slight darkening with development of black specks upon post-irradiation heat-treatment. A reversal of the procedure brought the same results; that is, heating caused the slight changes that were observed, while the radiation produced no further changes.

In beryls colored by iron ions, more and varied changes were experienced,

Color and Luminescence

Doelter found, for example, that x-rays tended to "purify" blue and yellow colors while gamma rays tended to intensify them. As cited in Schmetzer et al.²² (p. 21), in 1935 Andreev irradiated a brownish-orange beryl with gamma rays but found no change. Pough and Rogers⁷⁵ noted as a rule that blue aquamarines assumed light to medium green colors after irradiation with x-rays, while a colorless beryl turned pale brown; continuous irradiation of about 16 to 50 hours was necessary, however, to effect these changes. No fluorescence or phosphorescence was noted and, upon heating, the stones returned to former hues. Similar irradiation results were obtained by Mukherjee,³² namely, pale blue material turned greenish and a colorless specimen turned weak brown. Pough⁷⁶ induced unstable yellow in blue, pale blue, and colorless beryls by electron bombardment.

The irradiation/heat treatments described by Schmetzer et al.⁷¹ (pp. 84-5) show that blue-greenish-yellowish iron-bearing beryls assume greenish to yellowish hues after x-ray and gamma-ray irradiation and electron bombardment, while some colorless specimens remained unchanged or turned pale yellow. When heat-treatment followed irradiation, all colored samples stabilized on a blue color. When the procedure was reversed, that is, heated first, colored specimens turned blue and, after irradiation, turned to green or yellow. Colorless specimens either remained colorless or assumed a yellowish tinge. For beryls containing Fe + Cr and originally blue-green or green, heating produced green to yellow-green which turned blue-green after irradiation. Reversing the process caused the blue-green colors to change to green and ultimately to yellow-green after irradiation.

Schmetzer et al.⁷¹ also tested Maxixe beryls which changed under irradiation from blue to blue-green, rose to blue, or colorless to blue. One blue sample retained its blue color and may have been irradiated to begin with. After heat-treatment, all turned to rose or colorless, except for one blue-green specimen that turned completely blue after irradiation. The reversal of the process, however, brought some surprises, in that the already-irradiated blue beryl turned colorless or rose when heated, but when irradiated became blue again. Another blue sample which remained blue after heat-treatment also remained blue after irradiation. A rose sample and a colorless sample retained their hues after heat-treatment but turned blue after irradiation.

Maxixe-type beryls were also irradiated by Nassau⁷⁷ using gammas from a cobalt-60 source. He found that about 50% of possible blue color was achieved after a dose of 46.2 megarads in 2.75 days. Close to 100% color saturation would require about 27 days of irradiation at this level, but a "dose" of 200 megarads gave a color close to saturation. His results show that color intensification is an exponential function in respect to time and that a dose of 200 megarads over a period of 12 days provided about as much color as desired. The effect of temperature on irradiation-induced color is extremely rapid at higher temperatures and much

CHEMICAL AND PHYSICAL PROPERTIES

less at the lower temperatures. For example, at 125°C held for 3 hours, the color intensity diminished to about 70% of its former value, while at 200°C it resulted in virtually complete color loss after a two-hour period. An excellent summary of color in minerals and gems was provided by Nassau⁷⁸ and includes discussion of beryl varieties.

SUMMARY OF COLOR CHANGES

Emerald—Coloring ions Cr, also Cr + V; stable to very high temperature; unaffected by irradiation.

Aquamarine—Coloring ions, various Fe; blue, blue-green, yellow-green; remain blue or change to blue after heat-treatment; may bleach at very high temperature; tend to reassume original greenish-yellowish hues after irradiation.

Yellow Beryl—Coloring ion Fe; usually to blue after heat-treatment; return to greenish-yellow or yellow after irradiation.

Yellow Beryl—Without Fe; colorless after heat-treatment; yellowish after irradiation.

Green Beryl—Colored mainly with Fe but with some Cr; blue-green to green hues, the green tending to become blue-green after heat-treatment; become greenish to yellowish-green after irradiation; presence of Cr prevents entire removal of green.

Blue Maxixe-Type Beryl—Color caused by color center but Fe may contribute; occurs in various blue, rose, yellow, green hues, also colorless; colorless to rose after heat-treatment, also colors tend to fade more or less rapidly in light; blue returns after irradiation but other colors may turn blue-green, the greenish component perhaps due to Fe.

Rose Beryl (Morganite)—Color may be caused by Mn; colorless after heat-treatment; yellow to yellow-orange after irradiation.

Rose Beryl (Morganite), Maxixe-Type—Remains rose after heat-treatment; turns blue after irradiation.

Red Beryl, Utah-Type—Coloring ion Mn; stable to very high temperature; probably stable after irradiation.

Orange Beryl—Coloring ion Mn; rose to colorless after heat-treatment; fades with exposure to light, rapidly in direct sunlight, stabilizing usually on pink; yellow to yellow-orange after irradiation.

Colorless (Goshenite)—Without Fe; unchanged by heat-treatment or irradiation.

Colorless (Goshenite) Maxixe-Type—Contains a color center; colorless after heat-treatment; turns blue after irradiation.

Colorless (Goshenite)—Contains Mn; unchanged by heat-treatment; tends toward yellow-orange after irradiation.

LUMINESCENCE

Luminescence, or the emission of light without the application of strong heating, has been reported a number of times in beryl, but the luminescence was remarkable neither for its strength, its color, nor consistent appearance. The kind produced by rubbing one hard stone against another, or triboluminescence, has been reported only once in beryl.⁷⁹ More common is fluorescence which depends on the use of one radiation, usually ultraviolet light (invisible), to excite a response that may be visible. Other types of luminescence will be discussed below.

Sohnke⁸⁰ observed fluorescence in beryl, but tests by Schincaglia⁸¹ failed to confirm its presence. Kunz and Baskerville⁸² generally found beryls inert to UV light except in three specimens from Haddam Neck, Connecticut. In his description of rose beryls from Madagascar, Kunz⁸³ found that under x-ray excitation "the new beryl assumed a brilliant cerise color under a tube of moderately low vacuum with about twelve or fifteen amperes through the tube," and when the current was increased, "the brilliancy of the stone increased accordingly." He also found that under the mercury light (UV) the beryl became pale lilac. Engelhardt⁸⁴ (p. 26) noted strong pale green fluorescence under UV in a beryl from an unstated source in North America and a weak pale green response in beryl from Langenbielau, Silesia, and from Miass in the Urals.

Newberry and Lupton⁸⁵ exposed a beryl to radium rays but produced only a feeble bluish-white fluorescence and then only on the basal planes. Similar use of radium rays by Lind and Bardwell⁷⁴ on natural and synthetic emeralds failed to evoke responses or to cause color changes, but one synthetic crystal exposed to 150 m.c. of emanation for ten days showed a faint green glow at 200°C. An aquamarine failed either to change color or exhibit fluorescence after a prolonged irradiation with radium rays.

Experiments conducted by De Ment⁸⁶ (p. 433) elicited the comment that "at most . . . this mineral fluoresces weakly," and he noted that the natural color would interfere with the detection of a fluorescent color. In shortwave UV (2537 Å), he discovered fluorescence in various shades of green, occasionally of deep hue. Alexander⁸⁷ tested beryls under x-rays but found no response in aquamarine, emerald, and other varieties, except in morganite, in which there was a "dull to bright" fluorescence. Lisle⁸⁸ described fluorescence in New Hampshire beryls as "a lovely dark blue under the purple-x bulb" and noted blue fluorescence on golden beryl where it was fractured. Some beryl from Weeks quarry, East Wakefield, New Hampshire, was found to fluoresce a faint peach color under longwave UV (3658 Å) by De Ment⁸⁹ and a weak yellow to "flesh" glow in a cesium beryl from Newry, Maine.

Millson and Millson⁹⁰ (p. 432) irradiated many minerals under shortwave UV to determine persistence of phosphorescence. A goshenite from San Piero, Elba,

CHEMICAL AND PHYSICAL PROPERTIES

produced a bluish-white glow for about 152 hours, while a morganite from the Gillette quarry, Haddam Neck, Connecticut, glowed pink for about 296 hours. These results are unusual, phosphorescence in beryl having been only rarely reported and never for such long durations.

Cathodoluminescence, or light produced by irradiation with cathode rays, was found in beryl by Saksena and Pant.⁹¹ Luminescence occurred in the red region between 6150 Å and 6500 Å, with the maximum between 6300 Å and 6500 Å. Prolonged irradiation resulted in weakening of luminescence in the red region and the production of two bands of medium intensity at 5600–5800 Å and 4350–4900 Å, and also a weak band near 5400 Å.

Lieber⁹² (p. 50) tested emeralds under longwave UV and found very weak fluorescence or none at all in specimens from most localities. However, emerald from Chivor, Colombia, displayed a very weak red glow, while synthetic emeralds all fluoresced dark red. No response under UV was noted for aquamarine or morganite. Gleason⁹³ noted weak yellow, pale green, and pink fluorescence in beryls.

Infrared luminescence, invisible to the human eye and detectable only with special laboratory instrumentation, has been investigated in a large number of minerals, including beryl, by Barnes,⁹⁴ who noted that "beryl in cloudy or opaque specimens generally gives no luminescence, but relatively clear pieces of most emerald and some aquamarine show strong infrared luminescence." He listed emeralds from eleven deposits which produced strong response in the infrared (p. 102) and altogether tested 215 emerald and aquamarine specimens from thirty-two localities. In these, he found that 20% of specimens from thirty localities responded in the infrared but only 3% of the test specimens from ten localities produced visible light (p. 115).

It seems clear that luminescence in beryls is far from being an important property and many more specimens need to be tested before some consistent behavioral patterns emerge. Beryl specimens taken from pegmatites are especially subject to errors of interpretation because of the well-known tendency for thin films of fluorescent opal to coat fracture surfaces within these bodies. Fluorescent organic materials may also enter the outcrops of such bodies and penetrate deeply into them, not to mention those strongly fluorescent compounds that are present in modern detergents used to clean specimens.

Literature Cited

1. Boyle, R. 1672. *An Essay About the Origine and Virtues of Gems*. London: William Godbid. 185 pp.
2. Klein, F. 1941. *Smaragde unter dem Urwald*. Berlin: Oswald Arnold Verlag. 285 pp.
3. Otero Muñoz, G., and Barriga Villalba, A. M. 1948. *Esmeraldas de Colombia*. Bogota: Banco de la Republica. 133 pp.
4. Vauquelin, N. L. 1798. Analyse de l'aigue marine, ou béril; et découverte d'une terre nouvelle dans cette pierre. *Annales de Chimie*. ser. 1, vol. 26, pp. 155–69.

Color and Luminescence

5. Lévy, B. 1857. Recherches sur la formation et la composition des émeraudes. *Compte Rendu de l'Académie des Sciences* (Paris) 45:877-81.
6. Wöhler, F., and Rose, G. 1864. Sur la nature colorante des émeraudes. *Compte Rendu de l'Académie des Sciences* (Paris) 58:1180.
7. Jannettaz, E. 1892. Note sur la calcaire noir renferment les émeraudes de Muso (Nouvelle-Grenade). *Bulletin de la Société Française de Minéralogie et Cristallographie* 15:131-3.
8. Moir, J. 1912. Notes on the spectra of the precious emerald and other gem stones. *Transactions of the Royal Society of South Africa* 2:273.
9. ———. 1918. Spectrum-phenomena in chromium compounds. *Transactions of the Royal Society of South Africa* 7:129-30.
10. Wild, G. O., and Klemm, R. 1926. Mitteilungen über spektroskopische Untersuchungen an Mineralien. Smaragd. *Zentralblatt für Mineralogie* (Stuttgart) 1926, Abt. A, no. 1, pp. 21-2.
11. Fersman, A. E. 1926. [On the nature of color in emerald]. *Doklady Akademiyi Nauk SSSR* (Leningrad) pp. 24-5.
12. Klemm, R. 1927. Über die Färbung einigen Mineralien durch Chrom. *Zentralblatt für Mineralogie* (Stuttgart) 1927, Abt. A, pp. 267-78.
13. Vogel, P. 1934. Optische Untersuchungen am Smaragd und einigen anderen Chrom gefärbten Mineralien. *Neues Jahrbuch für Mineralogie* (Stuttgart) 68:401-38.
14. Kolbe, E. 1935. Über die Färbung von Mineralien durch Mangan, Chrom und Eisen. *Neues Jahrbuch für Mineralogie*, Abt. A, Beilage-Bd. 69, pp. 183-254.
15. Grum-Grzhimailo, S. V. 1940. [On the coloration of minerals caused by chromium]. *Trudy Instituta Kristallografii* (Moscow) 2:73-86.
16. Wild, G. O., and Biegel, H. 1948. Lichtabsorption am Smaragd. *Achat* 1, no. 1/2, pp. 16-7.
17. Ristic, S., and Eichhoff, H. J. 1955. Les spectres d'absorption et réflexion de quelques variétés de béryls synthétiques et naturels. *Congrès Groupement l'Avancement des Méthodes d'Analyse Spectrographiques des Produits Métallurgiques* 18:385-411.
18. Wood, D. L., and Nassau, K. 1968. The characterization of beryl and emerald by visible and infrared absorption spectroscopy. *American Mineralogist* 53:777-800.
- 18a. Goldman, D. S., Rossman, G. R. and Parkin, K. M. 1978. Channel constituents in beryl. *Physics and Chemistry of Minerals* (Springer Verlag) 3:225-35.
19. Linares, R. C.; Ballman, A. A.; and Van Uitert, L. G. 1962. Growth of beryl single crystals for microwave applications. *Journal of Applied Physics* 33:3209-10.
20. Nassau, K., and Jackson, K. A. 1970. Trapiche emeralds from Chivor and Muzo, Colombia. *American Mineralogist* 55:416-27; correction, 55:1808-9.
21. Schmetzer, K. A. 1978. *Vanadium III als Farbstoffträger bei natürlichen Silikaten und Oxiden*. Inaugural Dissertation, Ruprecht-Karl-University, Heidelberg. 277 pp.
22. Schmetzer, K.; Berdesinski, W.; and Bank, H. 1974. Über die Mineralart Beryll und Absorptionsspektren. *Zeitschrift der deutschen gemmologischen Gesellschaft* 23, no. 1, pp. 5-39.
23. Webster, R. 1979. *Gems*. 3rd ed. London: Newnes-Butterworths. 931 pp.
24. Wild, G. O., and Biegel, K. H. 1948. Smaragd—oder nicht? *Achat* 1, no. 10, pp. 173-4.
25. Wild, G. O. 1934. The emerald filter loupe. *The Gemmologist* (London) 4:29-30.
26. Anderson, B. W. 1934. Colour-filters. *The Gemmologist* (London) 4:58-9.
27. Popley, A. R. 1934. A useful colour-filter. *The Gemmologist* (London) 4:57.
28. Gliszczynski, S. von. 1949. Kristallviolettefilter als Spezialprüfer für Smaragde. *Achat* 2, no. 1, pp. 13-4.
29. Klang, H. 1934. Beiträge zur Kenntnis der Absorption und Lichtbrechung von Aquamarin und einigen gelben und grünen Beryllen. *Neues Jahrbuch für Mineralogie*, Beilage-Bd. 69, Abt. A, pp. 93-116.
30. Jayaraman, N. 1940-41. A chemical study of the Nellore beryl and the cause of its colouration. *Journal of the Indian Institute of Science* 23 A:30-5.
31. Borovik, S. A. 1943. [Content of Sc in beryls and some other minerals]. *Doklady Akademiyi Nauk SSSR* (Leningrad) 40:125-7.
32. Mukherjee, B. 1951. Colour of beryl. *Nature* (London) 167:602.
33. Wild, G. O. 1933. [Note]. *Zentralblatt für Mineralogie*, Abt. A., pp. 38-9.
34. Schlossmacher, K., and Klang, H. 1935. Der Maxixeberyll. I. *Zentralblatt für Mineralogie*, Abt. A, pp. 37-44.
35. Roebbling, W., and Tromnau, H. W. 1935. Der Maxixeberyll. II. *Zentralblatt für Mineralogie*, Abt. A, pp. 134-9.
36. Nassau, K., and Wood, D. L. 1973. The nature of the new Maxixe-type beryl. *Lapidary Journal* 27:1032-58.
37. ———. 1973. Examination of Maxixe-type blue and green beryl. *Gems & Gemology* 14:130-33.
38. ———. 1973. Examination of Maxixe-type blue and green beryl. *Journal of Gemmology* (London) 13:296-301.
39. Andersson, L. O. 1979. The difference between Maxixe beryl and Maxixe-type beryl: an electron paramagnetic resonance investigation. *Journal of Gemmology* (London) 16:313-7.
40. Gliszczynski, S. von. 1948. Über ein Farbfilter als Hilfsmittel zur sofortigen Unterscheidung von

CHEMICAL AND PHYSICAL PROPERTIES

- Aquamarinen und aquamarinefarbenen synthetischen Spinellen. *Achat* 1, no. 12, pp. 260-1.
41. ———. 1949. Das Verhalten der "Ferrera"-Steine unter den Vandrey'schen Prüffiltern für Aquamarine und Smaragde. *Achat* 2, no. 2, pp. 61-2.
 42. Eppler, A. 1920. Der Heliodor. *Die Umschau* (Frankfurt a. M.) 24:497-500; also in *Scientific American Monthly*, March 1921.
 43. ———. 1912. *Die Schmuck- und Edelsteine*. Stuttgart: P. Kraus. 464 pp.
 44. Nassau, K., and Wood, D. L. 1968. An examination of red beryl from Utah. *American Mineralogist* 53:801-6.
 45. Borovik, S. 1946. [Laboratory experiments on the introduction of Sc into crystal lattice of beryl]. *Doklady Akademiyi Nauk SSSR* (Leningrad) 53:65-6.
 46. Frondel, C., and Ito, J. 1968. Synthesis of the scandium analogue of beryl. *American Mineralogist* 53:943-53.
 47. Matossi, F., and Bronder, O. 1938. Das ultrarote Absorptionsspektrum einiger Silikate. *Zeitschrift für Physik* 3:1-17.
 48. Omori, K. 1961. Infrared absorption spectra of some essential minerals. *Science Reports, Tohoku University* (Sendai) ser. 3, vol. 7, pp. 101-30; (1964) vol. 9, pp. 65-97.
 49. Saksena, B. D. 1961. Infra-red absorption studies of some silicate structures. *Transactions of the Faraday Society* (London) 57:242-55.
 50. Vincent-Geisse, J., and Lecomte, J. 1963. Application, à un cristal de béryl, d'une nouvelle méthode d'étude par réflexion. *Zeitschrift für Physik* 173:149-58.
 51. Plyusnina, I. L. 1964. Infrared absorption spectra of beryllium minerals. *Geochemistry* 1, no. 2, pp. 13-21.
 52. Wood, D. L., and Nassau, K. 1967. Infrared spectra of foreign molecules in beryl. *Journal of Chemical Physics* 47:2220-28.
 53. Wood, D. L. 1965. Absorption, fluorescence, and Zeeman effect in emerald. *Journal of Chemical Physics* 42:3404-10.
 54. Flanigen, E. M., et al. 1967. Characteristics of synthetic emeralds. *American Mineralogist* 52:744-72.
 55. Nisi, H. 1929. Raman effect in some crystals. *Proceedings of the Japan Academy* (Tokyo) 5:407-10.
 56. Kopcewicz, T. 1937. Effect of temperature on the Raman frequencies of crystals of topaz, beryl, and calcite. *Journal Phys. Radium*, 8:6-10.
 57. Michalke, H. 1938. Quantitative Untersuchungen der Polarization der Raman-Linien von Kristallen. *Zeitschrift für Physik* 108:748-70.
 58. Doelter, C. 1893. *Edelsteinkunde*. Leipzig: Veit & Comp. 260 pp.
 59. Joly, J. 1891. Zerstörung der Farbe in Beryll. *Zeitschrift für Kristallographie und Mineralogie* (Leipzig) 19:484.
 60. Hermann, W. 1908. Über die Einwirkung oxydierender und reduzierender Gase auf die Färbung einiger Minerale. *Zeitschrift für anorganische und allgemeine Chemie* (Leipzig) 60:369-404.
 61. Doelter, C. 1908. Über die Einwirkung von Radium- und Röntgenstrahlen auf die Farben der Edelsteine. *Sitzungsberichte der Kaiserliche Akademie der Wissenschaften, mathematisch-naturwissenschaftliche Classe, Wien*, vol. 117, Abt. 1, pp. 819-44.
 62. ———. 1910. *Das Radium and die Farben*. Dresden: Steinkopff. 133 pp.
 63. ———. 1915. *Die Farben der Mineralien insbesondere der Edelsteine*. Braunschweig: Friedrich Vieweg & Sohn. 96 pp.
 64. ———. 1920. Über die Farben der Mineralien. *Naturwissenschaften* 8:21-7.
 65. Wild, G. O., and Liesegang, R. E. 1923. Über die Farbe des Amethystes und die des Berylls. *Zentralblatt für Mineralogie* 24:737-40.
 66. Kurbatov, J., and Kargin, W. 1927. Über die Verwandlung der grünen Färbung des Berylls in eine Bläuliche. *Zentralblatt für Mineralogie, Abt. A*, pp. 361-2.
 67. Wild, G. O. 1932. The treatment of gem stones by heat. *Rocks & Minerals* (Peekskill, N.Y.) 7, no. 1, pp. 9-13.
 68. Gavrusovich, B. A., and Sarapulov, T. J. 1941. [On the change of color and optical properties of beryls on heating]. *Doklady Akademiyi Nauk SSSR* (Leningrad) 31:775-8.
 69. Frondel, C. 1952. Effect of heat on the colour of beryl. *Gemmologist* (London) 21:197-200.
 70. Srinivasan, N. R. 1957. A study on the change in the colour of beryl on heating. *Current Science* (Bangalore) no. 12, pp. 388-9.
 71. Schmetzer, K.; Berdesinski, W.; and Bank, H. 1975. Farbveränderung von Edelsteinen der Beryllgruppe. *Zeitschrift der deutschen gemmologischen Gesellschaft* 24, no. 2, pp. 81-7.
 72. Bastos, F. M. 1963. Heat-treatment of gems. *Lapidary Journal* 17:842-4.
 73. Miethe, A. 1906. Über die Färbung von Edelsteinen durch Radium. *Annalen der Physik* (Leipzig) ser. 4, vol. 19, pp. 633-8.
 74. Lind, S. C., and Bardwell, D. C. 1923. The coloring and thermophosphorescence produced in transparent minerals and gems by radium irradiation. *Journal of the Franklin Institute* (Philadelphia) 196:375-90; also in *American Mineralogist* 8(1923):171-80, with correction in 9 (1924):35.
 75. Pough, F. H., and Rogers, T. H. 1947. Experiments in x-ray irradiation of gem stones. *American Mineralogist* 32:31-43.
 76. Pough, F. H. 1957. The coloration of gemstones

Color and Luminescence

- by electron bombardment. *Zeitschrift der deutschen gesellschaft für Edelsteinkunde, Schlossmacher Festschrift*, pp. 71-8.
77. Nassau, K. 1974. The effects of gamma rays on the color of beryl, smoky quartz, amethyst and topaz. *Lapidary Journal* 28:20-40.
78. ———. 1975. The origins of color in minerals and gems. *Lapidary Journal* 29:920-28 (part 1), 1060-70 (part 2), 1250-58 (part 3).
79. Vernadsky, W. 1912. [Triboluminescence of beryl]. *Neues Jahrbuch für Mineralogie* 1:381.
80. Sohnke, L. 1899. [Fluorescence of beryl]. *Zeitschrift für Kristallographie und Mineralogie* (Leipzig) 30:619.
81. Schincaglia, J. 1901. Untersuchungen über Fluoreszenz in festen Körpern. *Zeitschrift für Kristallographie und Mineralogie* (Leipzig) 34:311-2.
82. Kunz, G. F., and Baskerville, C. 1903. The action of radium, actinium, Roentgen rays and ultra-violet light on minerals and gems. *Science* n.s. 18:769-83.
83. Kunz, G. F. 1911. Morganite, a rose-colored beryl. *American Journal of Science* 31:81-2.
84. Engelhardt, E. 1912. *Lumineszenzerscheinungen der Mineralien in ultravioletten Licht*. Inaugural Dissertation, Jena University, Weida i. Th.: Thomas & Hubert 39:3 pp.
85. Newberry, E., and Lupton, H. 1918. Radio-activity and the coloration of minerals. *Manchester Literary and Philosophical Society Memoirs* 62:1-15.
86. De Ment, J. 1945. *Fluorochemistry*. Brooklyn: Chemical Publishing Company. 796 pp.
87. Alexander, A. E. 1946. X-ray fluorescence in gemstones. *The Gemmologist* (London) 15, no. 177, p. 49.
88. Lisle, T. O. 1947. Beryl hunting in New Hampshire. *Rocks & Minerals* (Peekskill, N.Y.) 22:1018-22.
89. De Ment, J. 1949. *Handbook of Fluorescent Gems and Minerals*. Portland, Ore.: Mineralogist Publishing Co. 68 pp.
90. Millson, H. E., and Millson, H. E., Jr. 1950. Observations on exceptional duration of mineral phosphorescence. *Journal of the Optical Society of America* 40:430-5.
91. Saksena, B. D., and Pant, L. M. 1955. Cathodoluminescence spectra of beryl. *Journal of Scientific & Industrial Research* 14 B:246-7.
92. Lieber, W. 1957. Die Fluoreszenz von Mineralien. *Der Aufschluss* (Heidelberg) Sonderheft 5. 62 pp.
93. Gleason, S. 1960. *Ultraviolet Guide to Minerals*. Princeton: Van Nostrand. 244 pp.
94. Barnes, D. F. 1958. Infrared luminescence of minerals. *U.S. Geological Survey Bulletin* 1052-C, pp. 71-157.
95. Rossman, G. R. 1981. Color in gems: the new techniques. *Gems & Gemology* 17:60-71.

CHAPTER

9

CRYSTALLOGRAPHY

ORIGINS OF CRYSTALLOGRAPHY

The distinctive shape of beryl crystals seems to have been known to some contemporaries of Pliny,¹ or at least by the first part of the first century of the Christian era. Yet despite the considerable knowledge of mathematics and geometry possessed by scientists of that time, it seems that the general view of crystals was that the glistening planes upon them were freaks of nature having no special significance.

As Burke² pointed out in his study of the origins of crystallography, no formal treatise on the subject appeared until Romé de Lisle³ published his first essay on crystallography in 1772. Beryl was included, as shown in an engraved plate illustrating the simplest habit of its crystals, a hexagonal prism terminated by end-planes (see figure 2-13). As mentioned in an earlier chapter, "beryl" crystals were depicted in Aldrovandi's mineralogical treatise of 1648,⁴ but from their shapes they are unrecognizable as beryls and several seem to be quartz rather than beryl. In a much enlarged and improved crystallographic work, Romé de Lisle⁵ clearly distinguished the green sapphire or "oriental emerald" from the true emerald and also recognized that the latter and aquamarine belonged to the same mineral species. His plates depict idealized crystals which are described in geometrical terms in the text. An important innovation was the provision of several angles, given in degrees, that could be found by measuring adjoining faces on suitable crystals.

More information on beryl crystals appeared in 1801 when Haüy published his *Traité de Minéralogie*,⁶ in which he included a plate devoted to the shapes of beryl

Crystallography

crystals, showing upon them for the first time specific letters used to designate the several face-forms, or form symbols, a practice that was adopted by other mineralogists and persists today. His symbol for the hexagonal prism, a geometric form commonly seen on beryl crystals, was M, for example, and this letter, now used in italic lower case, is still applied to these faces on many drawings of beryl crystals. Other forms of beryl were also recognized and allotted form letters, and angles between faces were listed as well.

The invention by W. H. Wollaston in 1809 of the reflecting goniometer for measuring angles between faces enabled much more accurate values to be obtained and led to more certain identification of faces and the recognition of new forms. Phillips,⁷ for example, measured many crystals of all mineral species available to him and in 1823 published seven form letters for beryl. In 1837, J. D. Dana⁸ published his first edition of *The System of Mineralogy*, giving for beryl only six form letters. Both authors also provided interfacial angles but failed to agree on a standard set of form letters.

With rising interest in the external geometry (morphological crystallography), the relatively few forms for beryl crystals rapidly increased until no less than forty-three were listed in the 6th edition of Dana's treatise,⁹ which first appeared in 1892. Not long after, in 1913, Goldschmidt published his monumental atlas of crystal forms¹⁰ in which fifty-nine forms for beryl were given (vol. 1, pp. 182-3). By this time the conventional alphabet had been exhausted and recourse was had to Greek and Gothic letters to supply the necessary variety of symbols. The list was subsequently increased, as will be seen later in this chapter.

AXES AND SYMMETRY

Since crystals are solid objects, the system of coordinates devised by the French mathematician René Descartes (1596-1650)—thus called cartesian coordinates—was adopted for the description of the faces of crystals and their relationships to one another. The basis of the system is the use of three imaginary lines or axes which meet at a common point, representing the three dimensions of space. Thus, in a simple case, such as describing the space taken by a room in a house, one axis is vertical and would intersect the ceiling and floor while two lateral axes would intersect each of two walls. In practice, a house-builder uses such axes to set up the framework, utilizing a plumb-bob to be sure the vertical structural members are truly perpendicular to the earth's surface and a level to insure the horizontal orientation of floors and ceilings. For most crystals, only three such axes need be used, but in the case of minerals in the hexagonal system, including beryl, three instead of two lateral axes are more convenient, as shown in the first drawing of figure 9-1. These three axes reflect the placement or *symmetry* of the atoms in the beryl structure as depicted in figure 5-1. The latter figure shows only one cell of the

CHEMICAL AND PHYSICAL PROPERTIES

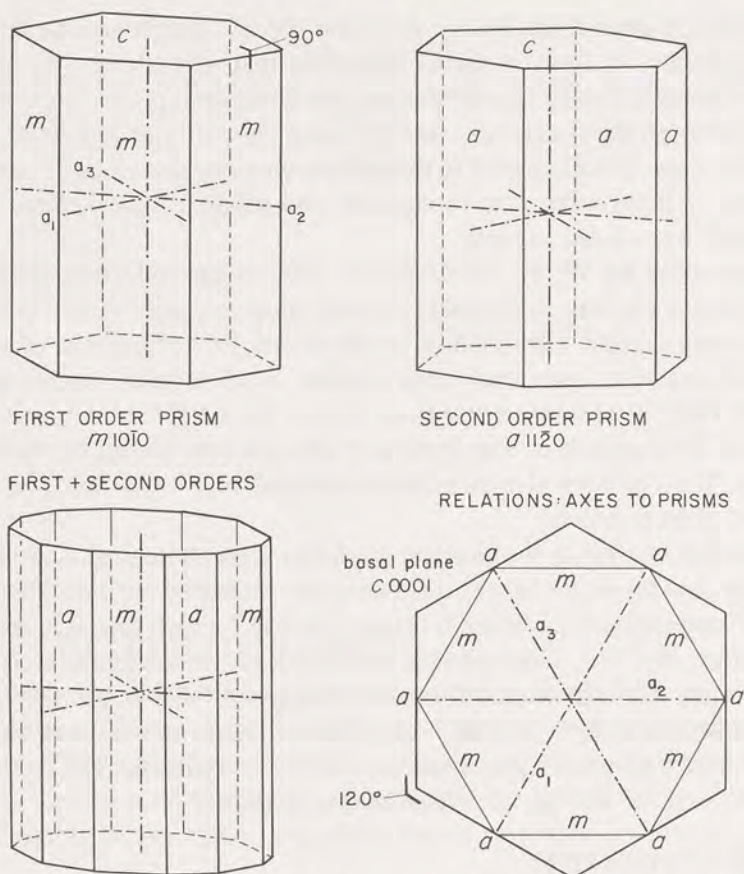

Fig. 9-1 Fundamental prism forms of beryl. The first order prism is most often found in crystals of common beryl, aquamarine, golden beryl, and emerald, the latter often displaying only m and c . The combination of the two, namely $m + a$, is frequently observed in emerald crystals and also in some aquamarine and golden beryl crystals.

structure, but when such cells are snugly fitted together, as occurs in actual crystals, the geometrical object known as the *hexagonal prism*, seen in figure 5-3, is created.

As with the walls in the room of a house, the bounding planes of developed beryl crystals, or *faces*, can all be related geometrically to the crystallographic axes as shown in figure 9-1. The principal or c -axis is that which passes vertically through the crystal and is parallel to the side or prism faces. The lateral axes pass at right angles through the sides of the crystal and are oriented 60° to each other. They are labeled a_1 , a_2 , and a_3 . The plane containing these axes is at right angles to the principal or c -axis.

In addition to their usefulness in geometrically describing orientations of crystal

Crystallography

faces, the crystallographic axes are conveniently referred to when describing certain physical properties. Thus, as noted in Chapter 7, light passing parallel to the *c*-axis is singly refracted, while that passing through the crystal elsewhere is doubly refracted. Colors also appear differently according to axial direction, and similar differences are noted in other properties according to direction. All such differences are a consequence of the fact that the atoms within the crystal are not randomly arranged but follow the patterns shown in figures 5-1 and 5-2.

Before passing on to a discussion of symmetry, it should be mentioned that crystallographers now place all crystals in six divisions according to the number of axes, their relative lengths, and their inclination to each other. These systems are the isometric or cubic, tetragonal, orthorhombic, monoclinic, triclinic, and hexagonal, the last of concern here. All are described and explained in any standard textbook of mineralogy.

The regularity of atomic arrangement in beryl, or symmetry, is expressed in descriptive terms and symbols. Because the elements of the symmetry are as complete as possible within the hexagonal system, beryl is classed as *normal*, *holosymmetric*, or *holohedral*, the last term referring to the complete symmetry in the patterns of faces. A more modern and more descriptive term for the symmetry is *dihexagonal bipyramidal*. The word *dihexagonal* means that faces can occur in pairs both along the sides of the prism and upon the pyramidal faces, as may be seen in the drawings of beryl crystals in figures 9-2 through 9-5. The term *bipyramidal* refers to the fact that whatever kind of face appears upon one pyramidal termination can also appear on the other. A rarely used term is *dihexagonal equatorial*, equatorial referring to the balanced placement of faces in respect to an imaginary plane, or "equator," passed horizontally through the crystal.

The features or *elements of symmetry* for beryl are shown in figure 9-2. The *c*-axis is the principal axis of symmetry and is six-fold, that is, the crystal can be rotated in six increments of 60°, each time exposing the same kind of atomic arrangement (and faces, if such are present). The lateral or two-fold axes, operate the same way, but now only two positions are possible in one full rotation in which the same atomic arrangement appears. Lastly, the crystal can be bisected by a series of imaginary *planes of symmetry*, of which there are six parallel to the *c*-axis and one parallel to the *a*-axes as shown in figure 9-2. These are also called "mirror" planes of symmetry because the structure and faces (if present) on one side of the plane are faithfully reproduced in the other.

Symmetry notations of two types are used by crystallographers as a kind of shorthand to describe the elements of beryl symmetry:

C = a center of symmetry

6/*m* = 1 six-fold axis of symmetry at right angles to a plane of symmetry

CHEMICAL AND PHYSICAL PROPERTIES

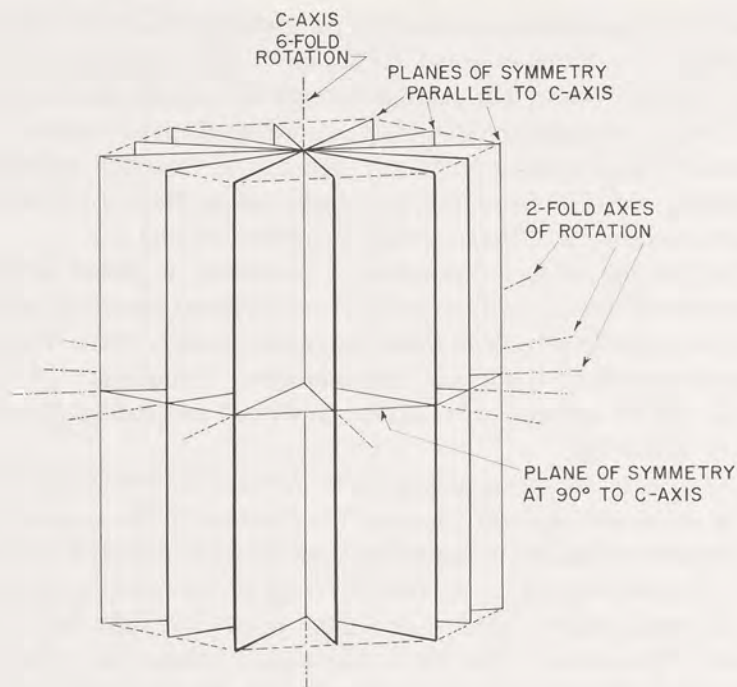

Fig. 9-2 Orientation of symmetry planes and axes in beryl crystals, showing their relationships to the first order hexagonal prism (indicated in dashed outlines).

$1 A_6 = 1$ axis of six-fold symmetry

$6 A_2 = 6$ axes of two-fold symmetry

$7 P = 7$ planes of symmetry

$2/m =$ a two-fold axis of symmetry with planes for each of the lateral axes

$2/m =$ the same, for each of the planes that can be passed between those above.

These notations are read as follows: C , $1A_6$, $6A_2$, $7P$, and $6/m$, $2/m$, $2/m$.

FACES AND FORMS

In crystallography, the word *face* means the natural flat plane occurring on crystals which have had the opportunity to grow without interference, usually within a cavity in rock. The word *form* is used for the collection of all possible faces of a specific type that can occur on a crystal. Thus, on the beryl crystals drawn in figure 9-3, the form letter *m* designates the faces of the commonest hexagonal prism

Crystallography

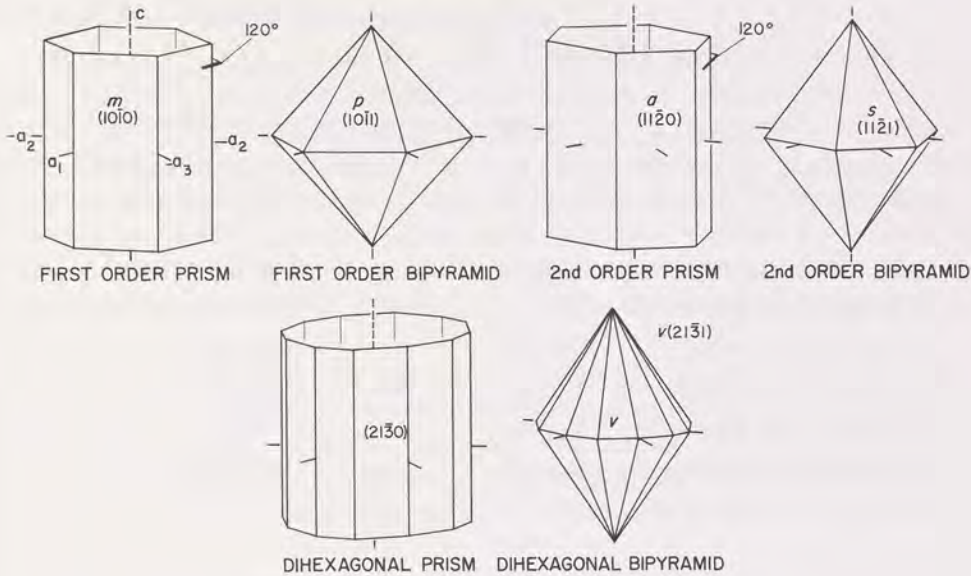

Fig. 9-3 Prism and bipyramidal forms of beryl.

which has six and only six faces, all alike in respect to their placement to the axes, and as noted before, all exposing the identical atomic arrangement. The other very common form of beryl crystals is *c*, shown in figure 9-4, which refers to faces that cut the *c*-axis at right angles and terminate the crystal in many specimens. There can only be two *c*-faces, as in *doubly-terminated* crystals, but in nature, one seldom finds both because most crystals grow from matrix and only one end is developed.

Where a single face is involved, the numerical symbols used to describe it are enclosed in parentheses (), as in figures 9-3 and 9-4. (An explanation of the Bravais-Miller numerical symbols occurs on subsequent pages.) However, when a form is being discussed, these numerals are enclosed in braces { }.

Compared to some other minerals, beryl forms are few in number; only seven types are known, as indicated in Table 9-1.

These forms are shown in figure 9-3 and various combinations of these faces in figure 9-4. Other combinations appear in drawings elsewhere in this chapter and in Part III, locality descriptions. Several of the drawings show "dipyramid" as an alternative term to "bipyramid," but each means the same.

More will be said about these forms later in this chapter, but for the moment we must turn to an explanation of the numerals enclosed in braces, the so-called *Bravais-Miller symbols*.

CHEMICAL AND PHYSICAL PROPERTIES

Table 9-1
BERYL CRYSTAL FORMS

Name	Form Letter	Number of Possible Faces	Remarks
Pinacoid	<i>c</i>	2	Also called basal pinacoid; very common
First order prism	<i>m</i>	6	Commonest face
Second order prism	<i>a</i>	6	Uncommon
Dihexagonal prism	Various	12	Uncommon
First order bipyramid	Various	12	Common
Second order bipyramid	Various	12	Common
Dihexagonal bipyramid	Various	24	Uncommon to rare

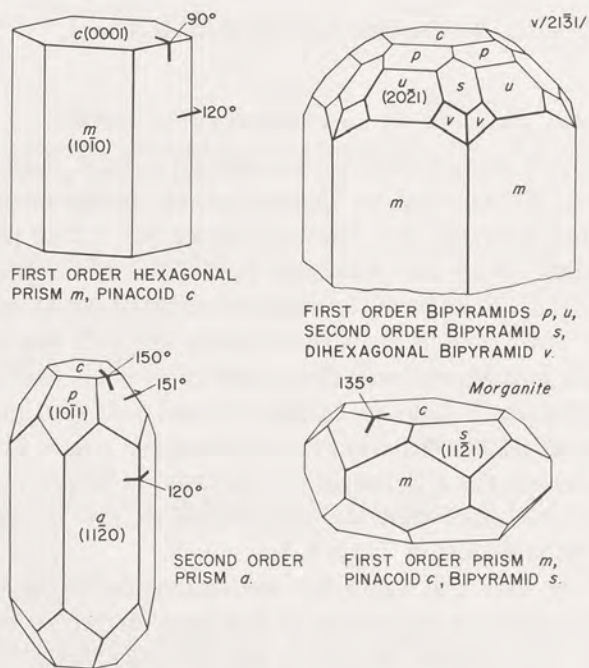

Fig. 9-4 The most common forms found on beryl crystals. The form at the top left is typical of emerald; that at the bottom right is typical of alkali beryls. The two others are common in aquamarines.

Crystallography

Bravais-Miller Indexes and Symbols

Because form letters alone are merely convenient labels and have no mathematical meaning, it was necessary to devise a means of indicating the position of any face by reference to the axes. The English crystallographer W. H. Miller (1801–1880), devised the method now used almost exclusively. It uses a symbol comprised of numerical indexes to show inclinations of faces to the crystal axes. Where three axes were involved, three index numbers comprised the symbol, but in the hexagonal system, it was more convenient to employ four index numbers, as originally suggested by A. Bravais (1811–1863), the French physicist and crystallographer.

In practice, the four-digit symbol gives intercepts on axes a_1 , a_2 , a_3 , and c respectively. For example, as shown in figure 9-4, the pinacoid c is symbolized by $\{0001\}$ which means that its plane does not intersect any of the three lateral axes but does intersect the c -axis. This is apparent in the symbol itself where three zeros are given for the three lateral axes and a "1" for the last position, reserved for the c -axis.

The very common large prism face m on beryl crystals is symbolized by use of $\{10\bar{1}0\}$, as shown in figures 9-3 and 9-4. The first "1" means that it intersects axis a_1 , the next "0" that it does not intersect axis a_2 , the next "1" again shows intersection, this time of axis a_3 , while the last "0" means it does not intersect the c -axis. Reference to the drawing in figure 9-3 shows that this face is parallel to both the a_2 and c axes, hence cannot intersect them as signified by use of zeroes in the Bravais-Miller symbol. The bar placed over any digit in the symbol indicates that the intercept takes place at the negative portion of the axis.

More complicated are symbols which contain numbers larger than unity, as in the case of the face $\{11\bar{2}1\}$ which happens to be a bipyramidal face. The a_1 and a_2 axes are both intercepted by this face at equal distances from the center of the axial cross (shown in figure 9-1), but the index "2" signifies that the a_3 axis is cut at a distance of only *one-half* that of the other two intercepts, the numerators in these symbols being left out for reasons which need not be explained here. Finally, the face also intersects the c -axis, as signified by the last "1" in the symbol. As will be seen in the tables of forms, even higher number indexes are used, in each case signifying only the denominator of a fraction, e.g., $3 = \frac{1}{3}$, $4 = \frac{1}{4}$, etc. With some practice, the student of crystallography is able to visualize the inclination of faces upon crystals merely by referring to the symbol and remembering which of the indexes refers to which axis.

Pinacoid, $c\{0001\}$

This form includes the two "end" faces on beryl crystals, shown at the top and bottom of beryl crystal drawings. They are at right angles to the c -axis and

CHEMICAL AND PHYSICAL PROPERTIES

also at right angles to all prism faces. Pinacoidal faces are almost always present on natural beryl crystals. On emeralds, for example, they are commonly the only other faces seen besides the faces of the hexagonal first order prism. However, in situations where a crystal has grown completely enveloped in matrix, such as in the large, coarse common beryl crystals found in granitic pegmatites or the much smaller emerald crystals enclosed in mica schist, the pinacoids may only be crudely developed and often are absent, their places being taken by irregular, somewhat rounded terminations without recognizable faces.

Surface quality of these faces ranges from rough to glassy smooth, and it is exceptionally fine on aquamarine crystals grown in cavities. Broad glassy pinacoidal faces are a prominent feature of many morganite crystals or other alkali beryls, especially those of tabular habit, like the example shown in figure 9-4. Sometimes they are the only glassy faces present on morganites and provide a striking contrast to the faces of other forms, which may be more or less severely etched.

A characteristic feature of the pinacoid face, especially in naturally etched specimens, is the presence of small tapered depressions, like miniature trumpets with hexagonal outlines as shown in figure 9-6. Another feature is the presence of growth hillocks that reflect the hexagonal symmetry and thus are bounded by the angles and edges of the hexagon (see figure 9-24). Both features are reliable clues to this face, and in the case of completely corroded crystals, the presence of hexagonal pits confirms the direction of the *c*-axis.

In aquamarine, golden beryl, and other light-colored varieties, pinacoidal faces are absent altogether in badly corroded crystals and their place may be taken by

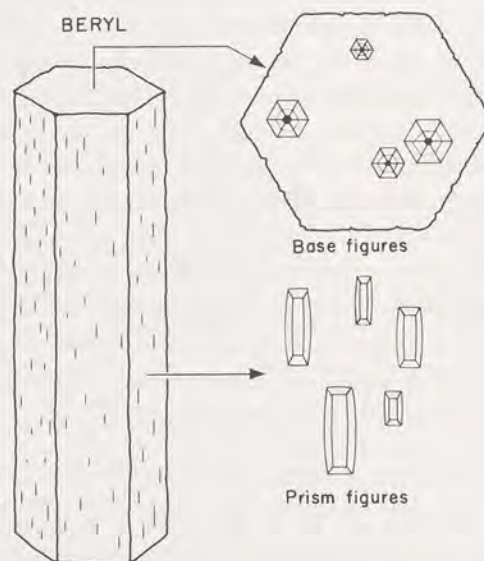

Fig. 9-5 Etching figures on beryl showing development of six-fold symmetry in the markings on the basal plane $c(0001)$ and elongated, boat-like markings on the faces of prism $m\{10\bar{1}0\}$.

Crystallography

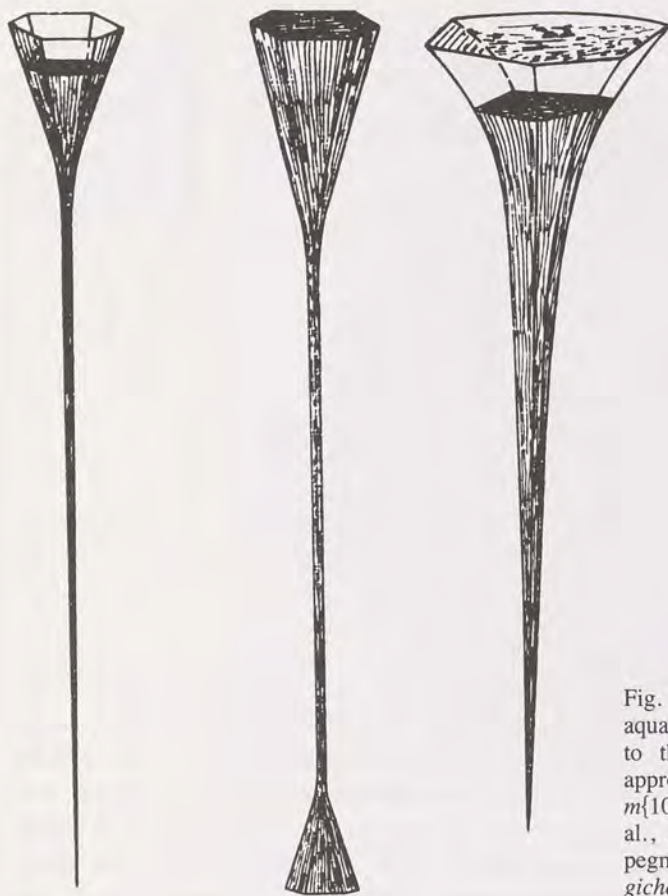

Fig. 9-6 Corrosion tubes in Ukrainian aquamarine crystals elongated parallel to the c -axis and lined with faces approximating the first order prism $m\{10\bar{1}0\}$. From Z. B. Bartoshinskii et al., Accessory beryl from chambered pegmatites of the Ukraine, *Mineralogicheskii Sbornik* 4 (1969):390.

either a tapered termination imparting a cigar-like aspect, as shown in figure 9-7, or a series of corrosion channels oriented parallel to the c -axis. These channels are sometimes so numerous that the ends of some crystals resemble stiff brushes. Where corrosion has been less severe, much of the pinacoidal face remains but is dotted with numerous pits, each marking the end of a hollow corrosion channel or a place deep within the crystal where growth was arrested due to an inclusion. In some crystals, such inclusions are subsequently covered by later growth and may appear as more or less sharply defined planes or "ghosts" within the crystals.

The pinacoidal plane may also be recognized by using the gemologist's dichroscope on specimens where the color is sufficiently intense to be noticeable in the windows of the instrument. If the rough is rotated to a position where the colors in both windows are the same, this coincides with the direction of the c -axis, and one is hence looking down upon the plane of the pinacoid.

CHEMICAL AND PHYSICAL PROPERTIES



Fig. 9-7 Beryl crystal with tapered and etched termination, showing overdevelopment of alternate faces of the prism $m\{10\bar{1}0\}$.

First Order Prism, $m\{10\bar{1}0\}$

The first order prism is by far the most common form, often being present and well developed when faces of the pinacoid are absent. In common beryl, aquamarine, golden beryl, and greenish beryl, the six faces of this prism are usually elongated and resemble narrow rectangles as in the crystal shown in figure 9-8. They are somewhat less developed in emeralds, and are poorly developed or sometimes absent in alkali beryls such as morganites and colorless varieties. The edges of the tabular crystals typical of alkali beryls may display only pyramidal faces (see figure 9-14).

The quality of m faces varies considerably with respect to geometric flatness and luster. For example, in crystals "frozen" in pegmatite matrix, they may be fairly smooth but curved and tapered, generally because of the tendency of these crystals to increase in diameter as they grow larger. Sometimes diameter changes are abrupt, in which case the prism faces show "steps." In contrast, crystals grown in cavities tend to be very uniform in diameter throughout their length, although exceptions have been noted.

A common surface feature is a host of narrow striations parallel to the c -axis, some of which appear to be growth features, as in schist-type emeralds, but most of which are due to etching. When magnified, these markings are often canoe-shaped (see figure 9-5) and are visual evidence of the two-fold symmetry of the exposed atomic structure. These striations may be sparse in number or so abundant that all traces of the original m -faces have disappeared, although such crystals still

Crystallography



Fig. 9-8 Transparent, terminated aquamarine crystal with books of mica, from Brazil; height ca. 15 cm (5 $\frac{7}{8}$ in). The largest faces are $m\{10\bar{1}0\}$, lightly etched, with broad faces of a second order bipyramid and traces of a second order dihexagonal bipyramid. *Courtesy National Museum of Natural History, Washington, D.C.*

usually preserve their hexagonal cross-section. In extreme cases, corrosion proceeds so far that the crystals become nearly circular in cross-section. The destruction of prism faces through chemical attack seems most extensive in alkali beryls, is common in golden beryls, and is least common in aquamarines.

Second Order Prism, $a\{11\bar{2}0\}$

Faces of the second order prism usually occur as narrow strips truncating squarely the edges where two faces of the first order prism meet. Geometrically, it is identical to the first order prism but is far rarer. To my recollection, I have never seen a beryl crystal on which this prism appeared alone. If both prisms were

CHEMICAL AND PHYSICAL PROPERTIES

present and equally developed, crystals would display twelve prism faces, but even this is rarely seen except on some emerald crystals of North Carolina, occasionally on Chivor emeralds, and sometimes on Brazilian aquamarines. Faces of this prism are more susceptible to chemical corrosion and for that reason they are usually more deeply etched than neighboring faces belonging to the first order.

Dihexagonal Prisms, various letters, general form symbol $hk\bar{i}0$

The symbol $hk\bar{i}0$ reflects the fact that there are a number of these forms, each with its faces assuming different angular inclinations to the three lateral axes, for which the general indexes h , k , and i , are conventionally used by crystallographers. The dihexagonal prisms thus far identified upon natural beryl crystals appear below in the table which, like similar tables to follow, represents the most complete collection of data available in print.

Dihexagonal prisms usually appear as very thin pairs of strips beveling the edges of the first order prism. If this form were fully developed, it would consist of twelve prism faces, hence the use of the term *dihexagonal* or "twice six." On the whole, these forms are rare and their faces, when they do appear, do not necessarily appear on all of the six edges of the first order prism, much to the confusion of the examiner of the crystal. At other times, they may bevel the edges of the second order prism as well and further add confusion. Unlike the typically rough faces of the second order prism, these tend to be glassy smooth. They occur

Table 9-2
DIHEXAGONAL PRISMS

Form Letter	Bravais-Miller Symbol	Reference
i	$2\bar{1}30$	9,10
—	$2\bar{1}40$	11
—	$3\bar{2}50$	11
E	$4\bar{1}50$	12
—	$4\bar{3}70$	13
ϵ	$5\bar{1}60$	9,10
—	$5\bar{2}70$	13
—	$5\bar{4}90$	13
—	$6\bar{1}50$	14
—	$6\bar{1}70$	13
—	$9.1.\bar{1}0.0$	15
ζ	$13.1.\bar{1}4.0$	9,10
—	$15.1.\bar{1}6.0$	15
—	$19.1.\bar{2}0.0$	15
—	$30.1.\bar{3}1.0$	15

Crystallography

on aquamarine crystals from Brazil, rarely on Colombian emeralds, and, as illustrated in figure 9-9, have been noted on aquamarine crystals from the Mack mine, Rincon, San Diego Co., California.

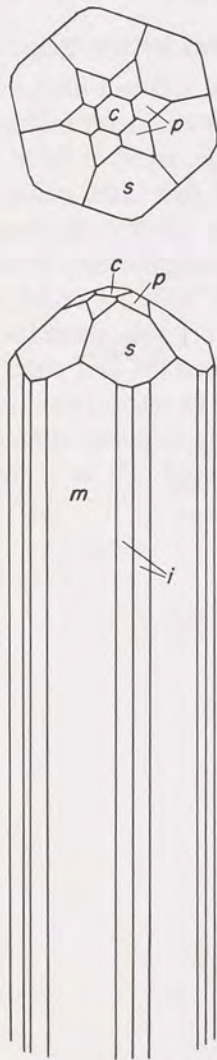

Fig. 9-9 Transparent green prism of aquamarine from Mack mine, Rincon, San Diego Co., California. The crystal is 60×4 mm and displays faces of $c\{0001\}$, $m\{10\bar{1}0\}$, $s\{11\bar{2}1\}$, $p\{1011\}$, and narrow faces of the dihexagonal prism $i\{21\bar{3}0\}$. After W. E. Ford, Some interesting beryl crystals and their associations, *American Journal of Science* 22 (1906):217-23.

CHEMICAL AND PHYSICAL PROPERTIES

The angle between face-pairs of this prism varies, depending on which di-hexagonal prism is present, but in any case they cannot meet at 120° , which is the angle between pairs of the first order prism, nor at 150° , the angle made between one face of the first order prism and an adjoining second order prism face.

First Order Bipyramids, various letters, general symbol $h0\bar{h}l$

The symbol means that the first and third indexes are variable but always of the same value while the last index is also variable. The use of prefix "bi" signifies that in doubly terminated crystals, faces of these forms could appear at both ends. Because they lie opposite to the first order prism faces, as in figure 9-10 (faces u and p), they are called *first order* bipyramidal faces. These are closed forms, complete in themselves. If fully developed, they would consist of two hexagonal pyramids placed base to base, and with a total of twelve faces, each a triangle, as shown in figure 9-3. In emerald crystals, these faces appear most commonly as thin strips truncating the edges between the first order prism faces and the pinacoid. In other varieties, they may appear as rather broad faces as shown in figures 9-10 and 9-11, and several may be present at once, often imparting to the terminations the appearance of one-half of a faceted ball as in figure 9-10. On most crystals they tend to be brilliantly smooth.

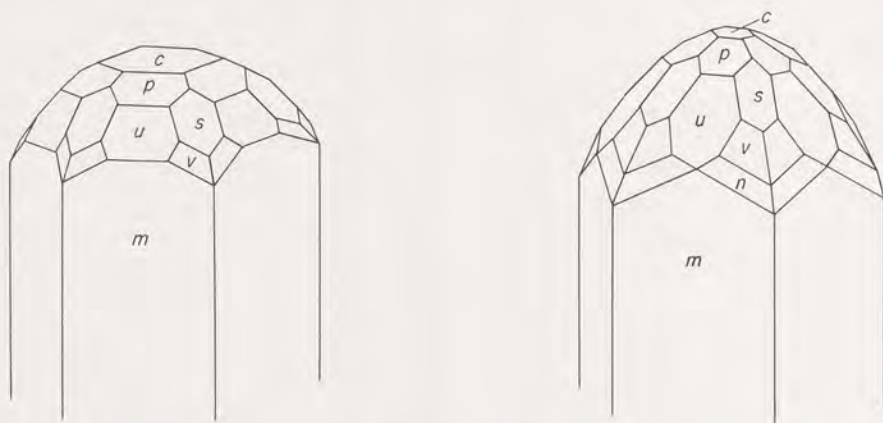

Fig. 9-10 Increasingly complex combination of forms on terminations of beryl crystals: $m\{10\bar{1}0\}$, $a\{11\bar{2}0\}$, $c\{0001\}$, $p\{10\bar{1}1\}$, $u\{20\bar{2}1\}$, $o\{11\bar{2}2\}$, $d\{33\bar{6}4\}$, $s\{11\bar{2}1\}$, $v\{21\bar{3}1\}$, $n\{31\bar{4}1\}$. Elba specimens after A. Schrauf, *Atlas der Krystall-Formen* (Vienna, 1877) and V. Goldschmidt, *Atlas der Krystallformen*, vol. 1 (Heidelberg, 1913).

Crystallography

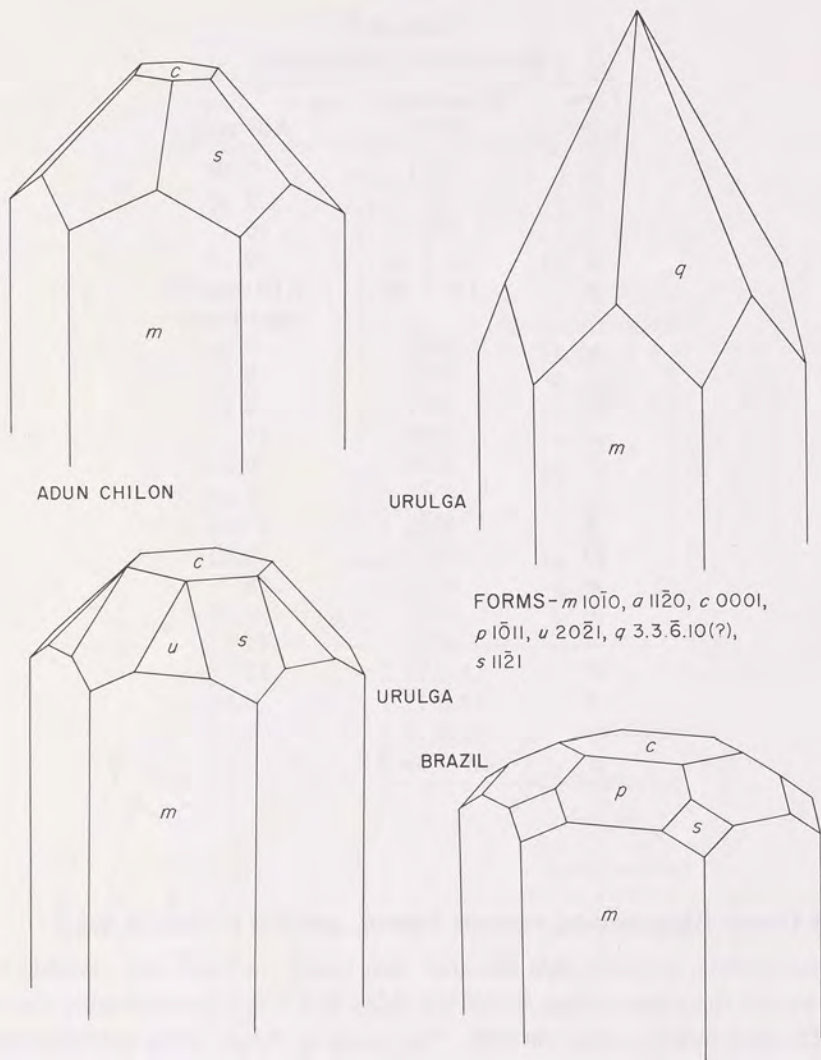

Fig. 9-11 Pyramidal forms of beryl crystals. The forms *p* and *s* are very common on morganite crystals. The crystals labeled Adun Chilon and Urulga (River) are from Transbaikalia, USSR. After N. Koksharov, *Materialien zur Mineralogie Russlands*, atlas (St. Petersburg, 1853).

CHEMICAL AND PHYSICAL PROPERTIES

Table 9-3
FIRST ORDER BIPYRAMIDS

<i>Form Letter</i>	<i>Bravais-Miller Symbol</i>	<i>Reference</i>
<i>p</i>	$10\bar{1}1$	9,10
π	$10\bar{1}2$	9,10
—	$10\bar{1}3$	16
ψ	$1.0.\bar{1}.12$	9,10
ρ	$1.0.\bar{1}.14$	9,10 (assigns other letter)
<i>u</i>	$20\bar{2}1$	9,10
τ	$20\bar{2}5$	9,10
<i>v</i>	$20\bar{3}1$	9,10
—	$30\bar{3}1$	75
<i>r</i>	$30\bar{3}2$	9,10
<i>t</i>	$40\bar{4}1$	9,10
<i>N</i>	$40\bar{4}5$	17,10
Ω	$50\bar{5}1$	9,10
ϵ	$60\bar{6}5$	18
λ	$70\bar{7}2$	9,10
—	$80\bar{8}1$	75
<i>Y</i>	$11.0.\bar{1}\bar{1}.2$	12
<i>T</i>	$12.0.\bar{1}\bar{2}.1$	9,10
<i>x</i>	$15.0.\bar{1}\bar{5}.2$	9,10
<i>e</i>	$39.0.\bar{3}\bar{9}.2$	9,10

Second Order Bipyramids, various letters, general symbol $h.h.2\bar{h}.l$

The symbol indicates that the first two index numbers are variable but both are always of the same value, while the third index is exactly double the value of these. The last index is also variable. The faces of these forms appear opposite the second order prism faces *a*, as shown in figure 9-12 where face *s* is opposite face *a* although separated from it by several intervening faces. On aquamarine crystals they commonly truncate the edges of first order bipyramids but are seldom as large as the latter. Second order bipyramids are rarely found on emerald crystals and then are very small in size. However, on morganite and other alkali beryl crystals, usually those of tabular habit, as shown in figures 9-4, 9-13, and 9-14, they grow very large, particularly as faces of $s\{11\bar{2}1\}$. The latter often resemble lozenges in shape and are usually deeply etched, the surfaces resembling coarse sandpaper. In contrast, the same surfaces on aquamarine crystals are ordinarily glassy though much smaller.

Crystallography

Table 9-4
SECOND ORDER BIPYRAMIDS

Form Letter	Bravais-Miller Symbol	Reference
<i>s</i>	$11\bar{2}1$	9,10
<i>o</i>	$11\bar{2}2$	9,10
σ	$11\bar{2}3$	9,10
ξ	$11\bar{2}4$	18
μ	$11\bar{2}6$	17,10
—	$1.1.\bar{2}.10$	16 (uncertain)
ω	$1.1.\bar{2}.12$	19,10
<i>D</i>	$22\bar{4}3$	9,10
<i>f</i>	$33\bar{6}1$	9,10
<i>d</i>	$33\bar{6}4$	9,10
—	$33\bar{6}5$	16
<i>O</i>	$33\bar{6}8$	12,10
<i>q</i>	$3.3.\bar{6}.10$	9,10
—	$44\bar{8}9$	16
δ	$5.5.\bar{10}.7$	9,10
ϕ	$6.6.\bar{12}.1$	9,10

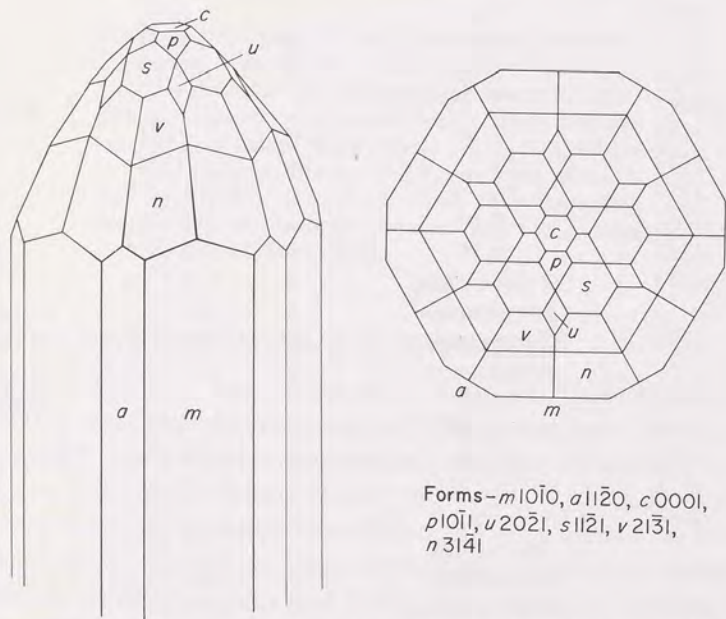

Fig. 9-12 Drawing of forms on a 10 × 30 mm ($\frac{3}{8}$ × $\frac{1}{4}$ in) crystal of pale aquamarine found near Hiddenite, North Carolina. After W. E. Hidden, Notes on North Carolina minerals, *American Journal of Science* 24 (1882):372-4.

CHEMICAL AND PHYSICAL PROPERTIES

Dihexagonal Bipyramids, various letters, general symbol $hk\bar{l}$

As shown by the symbol, all the numerical values of the indexes are variable. The faces of dihexagonal bipyramids may be regarded as extensions of dihexagonal prisms, but they seldom occur in conjunction with the latter. They are most common as pairs of small faces on the terminals of aquamarine and other light colored varieties of beryl, usually belonging to the forms $v\{2\bar{1}\bar{3}1\}$ or $n\{3\bar{1}\bar{4}1\}$, as shown in figures 9-4, 9-10, and 9-12. They are very rarely seen on emerald crystals, but as narrow faces they are common on tabular morganite crystals where they frequently outline the edges of the lozenge-shaped faces of prism m and the bipyramid $s\{1\bar{1}\bar{2}1\}$ (see figures 9-13 and 9-14). On morganite they are rough in texture, but on aquamarine crystals they are usually glassy.

Table 9-5
DIHEXAGONAL BIPYRAMIDS

Form Letter	Bravais-Miller Symbol	Reference	Form Letter	Bravais-Miller Symbol	Reference
y	$1\bar{3}\bar{4}1$	20	—	$5\bar{4}99$	16
v	$2\bar{1}\bar{3}1$	9,10	—	$6\bar{1}\bar{5}1$	14
—	$2\bar{1}\bar{3}\bar{2}$	21	W	$6\bar{1}\bar{7}1$	12,10
Δ	$2\bar{1}\bar{3}\bar{3}$	9,10	—	$6.5.\bar{1}\bar{1}.5$	22 (on etching prominence)
—	$2\bar{2}\bar{4}1$	75	w	$7\bar{1}\bar{8}1$	9,10
n	$3\bar{1}\bar{4}1$	9,10	γ	$7\bar{1}\bar{8}\bar{4}$	9,10
—	$3\bar{1}\bar{4}\bar{3}$	75	L	$7.4.\bar{1}\bar{1}.6$	15
—	$3\bar{2}\bar{5}\bar{5}$	16	—	$8\bar{1}\bar{9}1$	16
k	$4\bar{2}\bar{6}1$	9,10	V	$8.2.\bar{1}\bar{0}.3$	12,10
z	$4\bar{2}\bar{6}\bar{3}$	9,10	ϕ	$8.7.\bar{1}\bar{5}.6$	23,10
—	$4\bar{3}\bar{7}\bar{3}$	22 (on etching prominence)	A	$8.7.\bar{1}\bar{5}.7$	10 (labeled <i>chi</i>)
—	$4\bar{3}\bar{7}\bar{4}$	22 (on etching prominence)	Ψ	$9.7.\bar{1}\bar{6}.8$	10 (labeled <i>psi</i>)
ν	$5\bar{1}\bar{6}1$	14,10	χ	$9.7.\bar{1}\bar{6}.9$	10,22 (suggests same as 5495)
g	$5\bar{1}\bar{6}\bar{5}$	9,10	β	$11.1.\bar{1}\bar{2}.1$	9,10
N	$5\bar{2}\bar{7}\bar{2}$	12,10	l	$11.2.\bar{1}\bar{3}.2$	9,10
H	$5\bar{2}\bar{7}\bar{4}$	15	—	$11.25.\bar{3}\bar{6}.25$	18
B	$5\bar{4}\bar{9}\bar{4}$	9,10 (doubtful), 22 (on etching prominence)	y	$13.1.\bar{1}\bar{4}.1$	9,10
—	$5\bar{4}\bar{9}\bar{5}$	22 (on etching prominence, suggested equivalence to <i>chi</i> 9.7. $\bar{1}\bar{6}.9$)	λ	$15.1.\bar{1}\bar{6}.1$	18,10
			σ	$16.8.\bar{2}\bar{4}.1$	9,10
			h	$19.1.\bar{2}\bar{0}.1$	9,10
			—	$25.11.\bar{3}\bar{6}.25$	18
			x	$26.24.\bar{5}\bar{0}.5$	10
			X	$36.24.\bar{6}\bar{0}.5$	9,10 (doubtful)
			—	$275.121.\bar{3}\bar{9}\bar{6}.360$	18

Crystallography

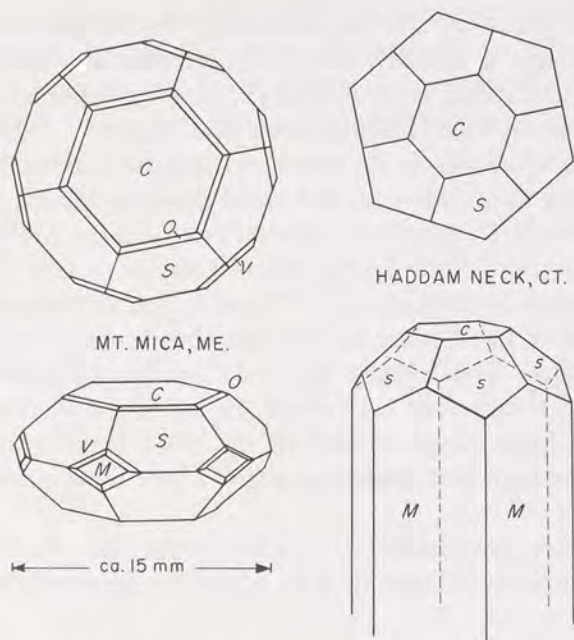

Fig. 9-13 Beryl crystals from Maine and Connecticut. The Mount Mica crystal is colorless and about 15 mm (5/8 in) in diameter. The Haddam Neck specimen is pale pink and shows forms typical of beryl crystals from that locality; size ranges from several cm to over 10 cm (4 in) in diameter. Forms $c\{0001\}$, $m\{10\bar{1}0\}$, $s\{11\bar{2}1\}$, $\alpha\{1122\}$, $v\{21\bar{3}1\}$. After W. E. Ford, Some interesting beryl crystals and their associations, *American Journal of Science* 22 (1906):217-23.

FREQUENCY AND PREDOMINANCE OF FORMS

By far the predominant form in emerald is the prism $m\{10\bar{1}0\}$, followed by the pinacoid $c\{0001\}$. The second order prism $a\{11\bar{2}0\}$ is common only in cavity emeralds. Leitmeier²⁴ compared the occurrences of forms on crystals from Muzo, Colombia; Bom Jesus Dos Meiras, Brazil; the Urals; Habachtal, Austria; and a synthetic emerald. Cavity emeralds from Muzo and Bom Jesus Dos Meiras developed numerous forms, thirteen on Muzo crystals and fourteen on those from Bom Jesus Dos Meiras. In contrast, only four forms were recognized on Uralian crystals, namely, the usual m and c faces plus uncommon faces of a and the second order bipyramid $s\{11\bar{2}1\}$. In the case of the Habachtal emeralds, Leitmeier noted the almost complete absence of any faces save those of the common hexagonal prism m . Only 5% of these crystals exhibited pinacoidal faces, and even fewer showed

CHEMICAL AND PHYSICAL PROPERTIES

both faces of the pinacoid, and he noted that "by far most crystals terminate irregularly." Among the more complexly faced emerald crystals are those from cavities in the North Carolina deposits near Hiddenite, several remarkable examples being described and depicted by Hidden and Washington.²⁵

The influence of alkalis on the beryl crystal habit commonly manifests itself as a flattening along the c -axis such that the crystals are tabular to short prismatic as shown in figures 9-13 and 9-14. Several from United States localities were described and depicted by Ford,²⁶ while other examples, notably from Madagascar, were similarly treated by Duparc et al.^{27,28} and Lacroix.²⁹ In general, alkali beryl crystals are simple in habit when of large size but become increasingly complex with diminishing size. Broad glassy faces of c are the rule, plus development of large faces of $s\{11\bar{2}1\}$ and other bipyramids. Except in the short prismatic crystals, where m faces are large though usually etched, alkali beryl crystals assume a discoidal aspect, sometimes with knife-like edges where bipyramidal faces meet and obliterate m faces.

For aquamarines, greenish beryls, golden beryls, and others in this group, the principal faces are those of m and of c , which are generally the only faces of

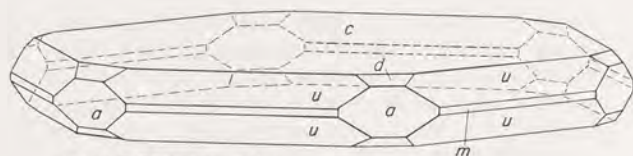

MAHARITRA, rose color

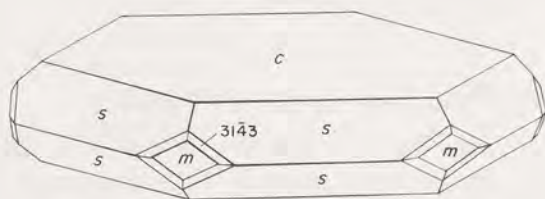

AMPATSIKAHITRA

Fig. 9-14 Alkali beryl crystals from Madagascar. At the top a flattened example from Maharitra of rose color, showing forms $c\{0001\}$, $a\{11\bar{2}1\}$, $u\{20\bar{2}1\}$, $m\{10\bar{1}0\}$, $d\{3\bar{3}64\}$. At the bottom another flattened crystal from Ampatsikahitra showing large $c\{0001\}$, s , m , and small faces of the dihexagonal bipyramid 3143. Top figure after L. Duparc et al., *Les Minéraux des Pegmatites d'Antsirabe à Madagascar, Mémoires de la Société de Physique et d'Histoire Naturelle de Genève* 36 (1910):281-410; bottom figure after A. Lacroix, *Minéralogie de Madagascar*, vol. 3 (1923).

Crystallography

importance on large crystals. Small crystals are often complexly terminated by numerous pyramidal forms which grow at the expense of *c* faces, the latter often being very small in size relative to the others. The general habit of this group is short to very long prismatic, with ratios of width to length of from 1:1 to as much as 1:24 (see figure 9-17).



Fig. 9-15 Crystals from Urulga River, Transbaikalia and Mursinka in the Urals, USSR. The very steep dihedral bipyramids *k* and *n* are rarely found except as rough areas along edges of terminations. After N. Koksharov, *Materialien zur Mineralogie Russlands*, atlas (St. Petersburg: 1853).

CHEMICAL AND PHYSICAL PROPERTIES

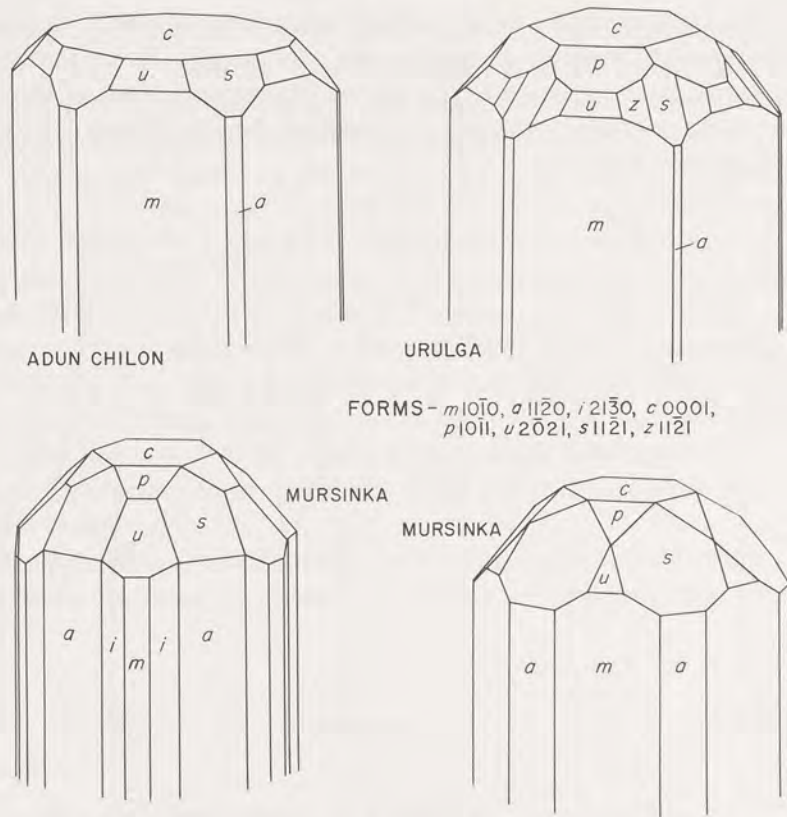
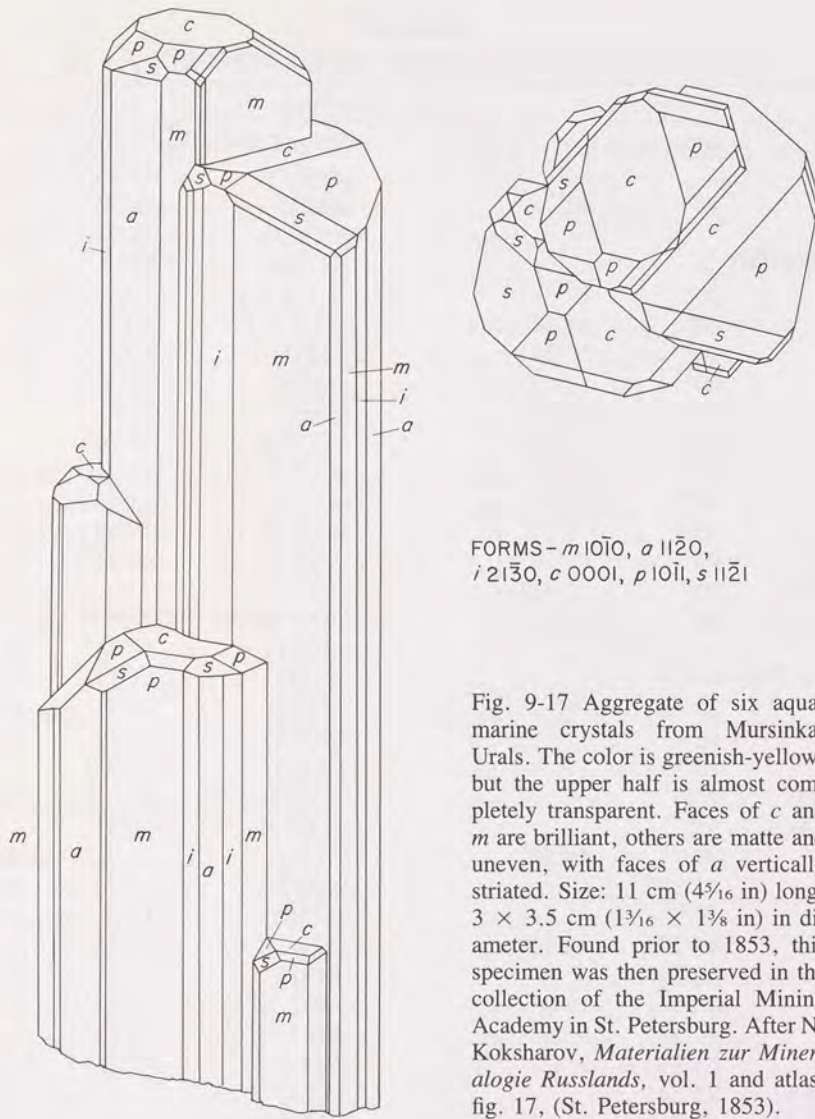

Fig. 9-16 Various combinations of forms on beryl crystals, the two upper specimens from Adun Chilon and the Urulga River, Transbaikalia, the lower two from Mursinka in the Urals, USSR. After N. Koksharov, *Materialien zur Mineralogie Russlands*, atlas (St. Petersburg, 1853).

INTERFACIAL ANGLES

Tables 9-6 and 9-7 provide interfacial angles compiled from the literature and arranged by forms, and determined by use of the angle-measuring instrument known as the *optical* (reflecting) *goniometer*. In most cases, the smallest crystals, usually those with the flattest and most brilliantly reflective faces, were used. Table 9-6 lists angles between the two commonest forms, the pinacoid $c\{0001\}$ and the first order prism $m\{10\bar{1}0\}$ since faces of these forms are most consistently present and yield excellent reference planes from which to measure the angles of other faces. Table 9-7 gives angles between other form faces but excludes those made with c or m .

Crystallography



FORMS - $m 10\bar{1}0$, $a 11\bar{2}0$,
 $i 21\bar{3}0$, $c 0001$, $p 10\bar{1}1$, $s 11\bar{2}1$

Fig. 9-17 Aggregate of six aquamarine crystals from Mursinka, Urals. The color is greenish-yellow, but the upper half is almost completely transparent. Faces of c and m are brilliant, others are matte and uneven, with faces of a vertically striated. Size: 11 cm ($4\frac{5}{16}$ in) long, 3×3.5 cm ($1\frac{3}{16} \times 1\frac{3}{8}$ in) in diameter. Found prior to 1853, this specimen was then preserved in the collection of the Imperial Mining Academy in St. Petersburg. After N. Koksharov, *Materialien zur Mineralogie Russlands*, vol. 1 and atlas, fig. 17, (St. Petersburg, 1853).

The angles are *supplementary angles*, or those obtained by subtracting the *interior angles* from 180° , as is the practice in measurements made upon the reflecting goniometer. For example, the angle made by any pair of faces of m is 120° , but the supplementary angle given in the table is $180^\circ - 120^\circ = 60^\circ$. If a contact goniometer is used, it will simultaneously provide the interior angle of 120° and the supplementary angle of 60° .

CTA

CHEMICAL AND PHYSICAL PROPERTIES

Table 9-6
INTERFACIAL ANGLES FOR $c(0001)$ and $m(10\bar{1}0)$

<i>Face</i>	<i>c</i>	<i>m</i>	<i>Face</i>	<i>c</i>	<i>m</i>
$a(11\bar{2}0)$	90°	30°	Second Order Bipyramids		
$c(0001)$	—	90°	$s(11\bar{2}1)$	44°56'	52°17'
$m(10\bar{1}0)$	90°	60°	$o(11\bar{2}2)$	26°30'	
Dihexagonal Prisms			$\sigma(1123)$	18°24'	
$i(21\bar{3}0)$	90°	19°6'	$\zeta(11\bar{2}4)$	14°0'	
$(31\bar{4}0)$	90°	13°54'	$(1.1.\bar{2}.10)$	5°42'	
$(32\bar{5}0)$	90°	23°25'	$\omega(1.1.\bar{2}.12)$	4°45'	
$E(41\bar{5}0)$	90°	10°53'	$f(3\bar{3}61)$	71°31'	
$(43\bar{7}0)$	90°	25°17'	$d(3\bar{3}64)$	36°48'	
$\epsilon(51\bar{6}0)$	90°	8°57'	$(3\bar{3}65)$	31°5'	
$(52\bar{7}0)$	90°	16°6'	$O(3\bar{3}68)$	20°26'	
$(54\bar{9}0)$	90°	26°20'	$q(3.3.\bar{6}.10)$	17° ca.	
$(61\bar{5}0)$	90°	8°57'	(4489)	23°55' ca.	
$(61\bar{7}0)$	90°	7°29'	$\delta(5.5.\bar{1}0.7)$	36°48'	
$(13.1.\bar{1}4.0)$	90°	3°40'	$\phi(6.6.\bar{1}2.1)$	80°31'	
$(19.1.\bar{2}0.0)$	90°	5°41'	Dihexagonal Bipyramids		
First Order Bipyramids			$v(21\bar{3}1)$	56°44'	37°49'
$p(10\bar{1}1)$	29°56'	75°33'	$n(31\bar{4}1)$	64°17'	29°0'
$\pi(10\bar{1}2)$	16°4'		$z(42\bar{6}3)$	45°27' ca.	47°32' ca.
$(10\bar{1}3)$	10°52'		$v(51\bar{6}1)$	72°19'	20°22'
$\psi(1.0.\bar{1}.12)$	2°45'		$g(51\bar{6}5)$	70°9'	
$\rho(1.0.\bar{1}.14)$	2°21'		$N(52\bar{7}2)$	61° ca.	32° ca.
$u(20\bar{2}1)$	49°2'	40°58'	$H(52\bar{7}4)$	41°57'	
$\pi(20\bar{2}5)$	12°58'		$(61\bar{5}1)$		19°26'
$\nu(30\bar{3}1)$	59°56'		$W(61\bar{7}1)$	75°10' ca.	16°37'
$r(30\bar{3}2)$	40°50'	49°10'	$w(71\bar{8}1)$	77°3'	14°30'
$t(40\bar{4}1)$	66°32'		$L(7.4.\bar{1}1.6)$	42°35'	
$\Omega(50\bar{5}1)$	70°51'	19°9'	(8191)		12°51'
$(60\bar{6}5)$	34°39'	55°21'	$V(8.2.\bar{1}0.3)$	60°24'	
$\lambda(70\bar{7}2)$	63°37'	26°27'	$\psi(9.7.\bar{1}6.8)$	48°45'	
$Y(11.0.\bar{1}1.2)$	72°34'		$\beta(11.1.\bar{1}2.1)$	81°26'	9°34'
$T(12.0.\bar{1}2.1)$	81°46'		$l(11.2.\bar{1}3.2)$		17°55'
$x(15.0.\bar{1}5.2)$	76°58'	11°1'	$y(13.1.\bar{1}4.1)$		8°11'
$e(39.0.\bar{3}9.2)$	84°55'		$(15.1.\bar{1}6.1)$		7°20'
			$h(19.1.\bar{2}0.1)$		5°41'
			$(25.11.\bar{3}6.25)$	26°21'	
			$(275.121.\bar{3}96.360)$	29°21'	

Crystallography

Table 9-7
INTERFACIAL ANGLES OTHER THAN $c(0001)$ and $m(10\bar{1}0)$

Between	Angle	Between	Angle
Second Order Prism		Second Order Bipyramids, cont.	
$a(11\bar{2}0):p(10\bar{1}1)$	64°23'	$(32\bar{5}5):(23\bar{5}5)$	5°54'
$a(11\bar{2}0):s(11\bar{2}1)$	45°9'	$d(33\bar{6}4):a(11\bar{2}0)$	53°17'
$a(11\bar{2}0):d(33\bar{6}4)$	53°17'	$d(33\bar{6}4):d'$	34°52'
		$d(33\bar{6}4):u(20\bar{2}1)$	25°
Dihexagonal Prisms		Dihexagonal Bipyramids	
$(1.14.\bar{1}3.0):(\bar{1}.13.\bar{1}4.0)$	52°40'	$(1.19.\bar{2}0.1):(1.20.\bar{1}9.1)$	54°41'
$(13.1.\bar{1}4.0):(\bar{1}.13.\bar{1}4.0)$	7°20'	$v(21\bar{3}1):v(12\bar{3}1)$	18°11'
$(13.1.\bar{1}4.0):i(21\bar{3}0)$	15°26'	$v(21\bar{3}1):v(31\bar{2}1)$	31°46'
$i(21\bar{3}0):i'$	38°13'	$\Delta(21\bar{3}3):\Delta(31\bar{2}3)$	17°3'
		$\Delta(21\bar{3}3):\Delta(12\bar{3}3)$	9°49'
First Order Bipyramids		$n(31\bar{4}1):n(13\bar{4}1)$	28°56'
$p(10\bar{1}1):a(11\bar{2}0)$	64°23'	$n(31\bar{4}1):n(31\bar{4}1)$	29°
$p(10\bar{1}1):p(01\bar{1}1)$	28°54'	$n(31\bar{4}1):n(41\bar{3}1)$	25°
$p(10\bar{1}1):s(11\bar{2}1)$	23°16'	$n(31\bar{4}1):s(11\bar{2}1)$	23°17'
$p(10\bar{1}1):(32\bar{5}5)$	11°30'	$(32\bar{5}5):p(10\bar{1}1)$	11°30'
$p(10\bar{1}1):(54\bar{9}9)$	12°49'	$k(42\bar{6}1):k(24\bar{6}1)$	20°41'
$\pi(10\bar{1}2):II'$	15°54'	$k(42\bar{6}1):k(62\bar{4}1)$	36°14'
$u(20\bar{2}1):u'$	44°22'	$z(42\bar{6}3):z(24\bar{6}3)$	15°29'
$v(20\bar{2}1):(33\bar{6}4)$	25°	$z(42\bar{6}3):z(62\bar{4}3)$	26°59'
$\pi(20\bar{2}5):T'$	12°53'	$z(42\bar{6}3):s(11\bar{2}1)$	8° ca.
$r(30\bar{3}2):r'$	38°10'	$(54\bar{9}9):(45\bar{9}9)$	3°16'
$x(15.0.\bar{1}5.2):x(0.15.\bar{1}5.2)$	58°18'	$(54\bar{9}9):p(10\bar{1}1)$	12°49'
		$w(71\bar{8}1):w(17\bar{8}1)$	45°34'
Second Order Bipyramids		$w(71\bar{8}1):w(81\bar{7}1)$	12°50'
$s(11\bar{2}1):s'$	41°22'	$\gamma(71\bar{8}4):\gamma(81\bar{7}4)$	9°41'
$s(11\bar{2}1):a(11\bar{2}0)$	45°9'	$\gamma(71\bar{8}4):\gamma(17\bar{8}4)$	34°1'
$s(11\bar{2}1):p(10\bar{1}1)$	23°16'	$\rho(8.7.\bar{1}5.6):s(11\bar{2}1)$	39°31'
$s(11\bar{2}1):n(31\bar{4}1)$	23°17'	$\chi(8.7.\bar{1}5.7):\chi(7.8.\bar{1}5.7)$	3°17'
$s(11\bar{2}1):z(42\bar{6}3)$	8° ca.	$\chi(8.7.\bar{1}5.7):s(11\bar{2}1)$	2°33'
$s(11\bar{2}1):\delta(5.5.\bar{1}0.7)$	9°27'	$\beta(11.1.\bar{1}2.1):\beta(12.1.\bar{1}1.1)$	8°31'
$s(11\bar{2}1):\rho(8.7.\bar{1}5.6)$	39°31'	$\beta(11.1.\bar{1}2.1):\beta(1.11.\bar{1}2.1)$	50°46'
$s(11\bar{2}1):\chi(8.7.\bar{1}5.7)$	2°33'	$(15.1.\bar{1}6.1):s(11\bar{2}1)$	44°57'
$s(11\bar{2}1):(15.1.\bar{1}6.1)$	44°57'	$h(19.1.\bar{2}0.1):h(1.19.\bar{2}0.1)$	5°4'
$o(11\bar{2}2):o'$	25°48'	$h(19.1.\bar{2}0.1):h(19.1.\bar{2}0.1)$	10°10'
$\sigma(11\bar{2}3):\sigma'$	18°9'	$(25.11.\bar{3}6.25):(11.25.\bar{3}6.25)$	14°55'
$\omega(1.1.\bar{2}.12):\omega'$	4°45'	$(25.11.\bar{3}6.25):(36.11.\bar{2}5.25)$	20°21'

CHEMICAL AND PHYSICAL PROPERTIES

TWINNING

Twins in beryl are so rare that mineralogists are reluctant to accord them an unquestioned status. Vrba¹⁸ described twins from Pisek, Czechoslovakia, consisting of two prismatic individuals diverging at an angle of $84^{\circ}55'$, twinning plane $(5.5.\bar{1}0.8)$, sharing a pair of common $m(10\bar{1}0)$ planes. Parsons³⁰ believed that twinning on plane $(11\bar{2}2)$ occurred in beryl crystals of the pegmatite locality in Lyndoch Township, Renfrew Co., Ontario. Two new twins were found by Pehrman³¹ in a number of crystals from Uuksu, Carelia, Finland. These were described as interpenetrant, crossing at an angle of $47^{\circ} \pm 2^{\circ}$ between the c -axes and twinned on plane $n(31\bar{4}1)$; the other twin was found on specimens from near Lemnäs, Kimito, Finland, also interpenetrant and twinned on plane $s(11\bar{2}1)$.

TRAPICHE EMERALDS

The Spanish word *trapiche*, normally applied to cog-wheels used to crush sugar cane, came also to be applied to emerald crystals in which inclusions form a six-spoked pattern when the crystals are observed in sections across the c -axis. Even earlier, the Spanish name *gemelo* had been applied to these curious crystals in the belief that they were twins. Such crystals are seldom over 25 mm (1 in) long and usually less than 10 mm ($\frac{1}{2}$ in) wide. The unique features are a central slender hexagonal core from which radiate narrow bands of inclusions, whitish or translucent in color. The sectors between the "spokes" may be filled with clear emerald (figure 9-18). Some crystals are fully developed prisms of $m\{10\bar{1}0\}$, usually without good terminations, while others are incompletely filled between the rays so that these protrude noticeably and reinforce the resemblance to a cog wheel. These crystals have been found only in the Colombian deposits and no similar growths of emerald or other beryls elsewhere have been reported.

The earliest notice of trapiche emeralds was taken by Bertrand³² in 1879, who found some among a lot of Muzo emeralds and remarked on the strange habit. They were again noticed by Codazzi,³³ who likened them to cyclic twins of aragonite. In 1916 Pogue³⁴ depicted a trapiche crystal (p. 719) and noted that this specimen and others like it had been found recently at Muzo and that the "carbonaceous impurities [are] disposed along crystallographic lines so as to form a six-rayed star pattern." In another paper³⁵ he also stated that "one specimen was examined optically and proved to be of the same orientation throughout; it therefore does not represent a twinned crystal as suggested by Lleras Codazzi." Furthermore, "its re-entrant angles are presumably the effect of solution and the disposition of the carbonaceous inclusions, the expression of crystallizing forces, as shown also, for example, in chialstolite."

Bernauer³⁶ made the first thorough examination of these crystals in about 1925,

Crystallography

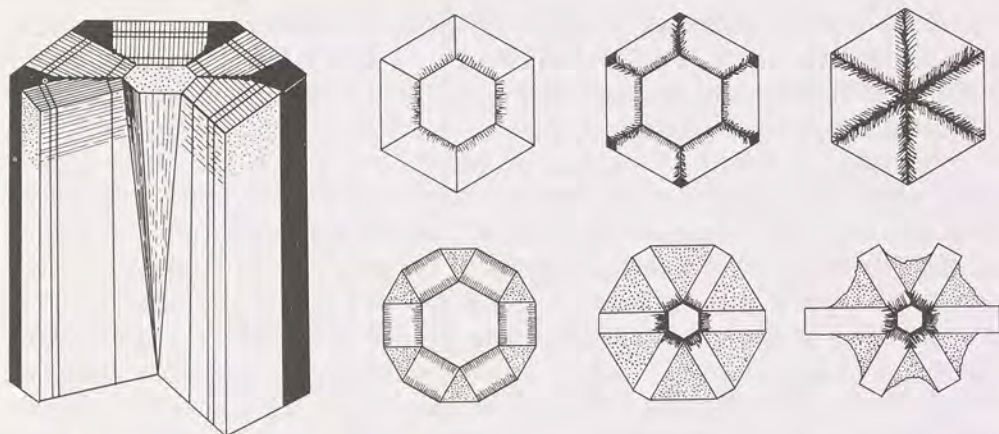

Fig. 9-18 Zones of inclusions in the trapiche emeralds of Colombia. The large sectioned crystal shows zones of inclusions arranged normal to the faces of the tapering hexagonal core as well as several zones of inclusions parallel to faces of the first order prism $m\{10\bar{1}0\}$. After F. Bernauer, Die sogenannten Smaragddrillinge von Muzo, *Neues Jahrbuch für Mineralogie Abt.A, Beilage-Bd. 54* (1926):205–42. The smaller drawings are after K. Nassau and K. A. Jackson, Trapiche emeralds from Chivor [*recte* Peña Blanca] and Muzo, Colombia, *American Mineralogist* 55 (1970):416–27. *Top*: Three crystals with central cores surrounded by trapezoidal segments, with the last two figures representing specimens in which the core tapers. *Bottom*: Three crystals with clear central cores and radiating “spokes” of clear emerald; the triangular regions between the spokes are filled with more or less opaque albite-emerald.

having at his disposal about forty roughly prismatic crystals up to 25 mm (1 in) long and up to 30 mm (1¼ in) in diameter. Sketches showed the internal arrangement of inclusions, some surrounding a central core, but others having grown without a core. Typically the inclusions taper longitudinally (parallel to the c -axis). His analysis of the inclusion material showed that it departed considerably from the typical emerald analysis by containing far too much Al_2O_3 . Bulk specific gravity was found to be 2.680–2.701, but the figure was considered inaccurate because of the inclusions, some of which were carbonaceous. Clear splinters, however, provided values of 2.699–2.709, while the specific gravity of a plate cut completely across a crystal and containing a central core was found to be 2.648–2.691. When heated to redness, no loss of weight could be found.

Bernauer also described a cleavage that was almost perfect along the pinacoid $c\{0001\}$, with pearly luster, and a less good cleavage parallel to $m\{10\bar{1}0\}$, the latter cutting through the inclusions. Cores were rich in inclusions of calcite, dolomite, pyrite, mica, small greenish biotite-like scales, kaolin, and carbonaceous matter, the last apparently responsible for imparting a very dark shade to those areas of emerald in which it was present. The dichroism was the same as in ordinary emerald, but weaker, while refractive indexes were found of $o = 1.5690$ – 1.5696 , e

CHEMICAL AND PHYSICAL PROPERTIES

= 1.5626–1.5640, difference = 0.0064–0.0056. On plates cut parallel to the c -axis, he obtained $o = 1.5687$ – 1.5679 , $e = 1.5622$ – 1.5623 , difference = 0.0065–0.0056. Bernauer concluded that the sectorial structure was due to repulsion of impurities by slowly growing crystals.

According to Scheibe,³⁷ trapiches at Muzo occur only in the rock adjoining that in which gem emeralds occur, namely, a dark, carbonaceous shale of the Viletta Formation of Lower Cretaceous age, which is altered in places by veins containing the trapiche emeralds as a kind of "contact" mineral. Around 1926, the crystals were found especially in the Banco Amarillo just west of Tambre Boliche, 100 m (110 yd) south of the mine buildings. More recently, trapiches were examined by MacKague³⁸ and Chaudhari,³⁹ who examined numerous small crystals averaging about 8 mm ($\frac{1}{3}$ in) long and 4 mm ($\frac{3}{16}$ in) wide. These had cores of "very pale green colour . . . non-pleiochroic . . . decidedly of poor quality." However, good quality emerald occurred in the sectors between the inclusion rays, each sector more or less completely separated from the prism faces of the core by a clay-like matrix which contained quartz.

The most recent study of trapiches is from the hands of Nassau and Jackson,^{40,41} who described crystals thought to be from Chivor but which later turned out to be from the Peña Blanca mine near Muzo. They noted that "these have the clear center and are distinct from the specimens from Muzo itself, which have a dark center." According to Tripp and Hernandez,⁴² the trapiches were found by a farmer in 1963 on land that is now part of the Peña Blanca property. The crystals examined by Nassau and Jackson were generally 12 mm ($\frac{1}{2}$ in) long and 10 mm ($\frac{3}{8}$ in) wide, although Tripp and Hernandez noted a crystal of 20 mm ($\frac{3}{4}$ in) in diameter that was cut for the sake of its gem-quality core. The largest crystal seen by them was 115 × 50 mm ($4\frac{5}{8}$ × 2 in) and weighed 167 carats.

Nassau and Jackson found that all trapiche crystals were untwinned and contained white, feathery inclusions consisting of albite and beryl. The Muzo crystals were characterized by carbonaceous inclusions that sometimes outlined the core and the segments. The inclusions were even found within the segments and in the core, at times so abundantly as to make the core seem black. When heated to redness in air, the black cores changed to green "with traces of orange-brown, presumably due to loss of the carbonaceous content." A spectrochemical analysis showed the core to contain appreciably higher Fe, Ti, and Ca than elsewhere in the specimen.

ETCH FIGURES

Like other mineral crystals grown from solution, those of beryl may be found in every condition, from those with glistening, exceptionally smooth surfaces to those which have lost every trace of original crystal faces due to dissolution. The marks made by dissolution reflect the internal symmetry and have been the object

Crystallography

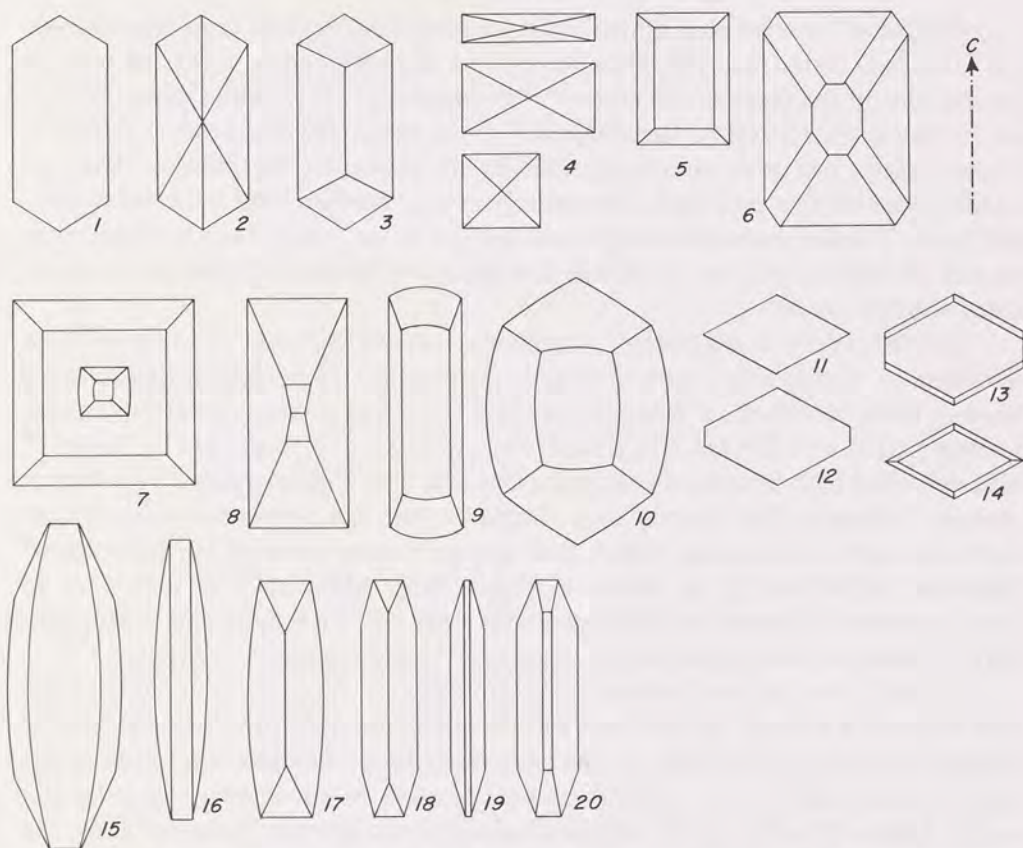

Fig. 9-19 Etch figures on faces of $m\{10\bar{1}0\}$. No. 1-3, Elba (Traube). No. 4, Brazil (Kohlmann) and Muzo emerald (Honest); similar pits but with rounded outlines on emerald from Hiddenite, N.C. (Honest). No. 5-10, Brazil (Kohlmann). No. 11-14, Miask (Honest); similar found by Traube on Elba crystals; such lozenges may also occur oriented parallel to c -axis. No. 15, Mursinka (Honest). No. 16-18, Topsham, Maine (Honest). No. 19-20, aquamarine, Mt. Antero, Co. (Honest). H. Traube, Ueber die Aetzfiguren einiger Minerale, *Neues Jahrbuch für Mineralogie*, Beilage-Bd. 10 (1895-6):454-69. H. Kohlmann, Beiträge zur Kenntnis des brasilianischen Berylls, *Neues Jahrbuch für Mineralogie*, Beilage-Bd. 25 (1907):135-81. A. P. Honest, On the etching figures of beryl, *American Journal of Science* 43 (1917):223-36.

of much study since their significance was realized. In 1887, Wiik⁴³ published studies of Uralian beryl crystals, noting that some faces were relatively untouched by solvents, while others were extensively pitted. The characteristic, approximately rectangular pits noted on the faces of the prism $m\{10\bar{1}0\}$ were goniometrically measured and the conclusion drawn that the beryl "molecule" consisted of three rhombic "part-molecules."

CHEMICAL AND PHYSICAL PROPERTIES

Petersson⁴⁴ studied etch figures on six wine-yellow crystals from Mursinka in the Urals and found many rhomboidal pits on the same prism faces, as well as similar pits on the faces of the second order bipyramid $s\{11\bar{2}1\}$ and triangular pits on the first order bipyramid faces of $p\{10\bar{1}1\}$, the last so abundant that at times the original plane had been completely obliterated. However, the pinacoid faces of $c\{0001\}$ bore but few pits, each a completely symmetrical inverted six-sided pyramidal form. Tubular inclusions were found parallel to the c -axis, each terminating in an etch pit and leading him to believe that the tubes themselves were greatly elongated solution cavities.

In 1888, Penfield and Sperry⁴⁵ described a severely corroded beryl crystal from Willimantic, Connecticut, with terminations consisting of pyramidal prominences bearing faces identified as belonging to $v\{21\bar{3}1\}$, a steep dihexagonal bipyramid, and to $m\{10\bar{1}0\}$, $a\{11\bar{2}0\}$, $k\{42\bar{6}1\}$, $f\{33\bar{6}1\}$ and, rarely, $p\{10\bar{1}1\}$, and $n\{31\bar{4}1\}$. Penfield⁴⁶ also described etch figures on pale green and blue aquamarine crystals from Mount Antero, Colorado. The crystals were simple in form but sometimes severely corroded on their terminations, which bore the very steep faces of the dihexagonal bipyramid $X\{36.24.\bar{6}0.5\}$ as shown in Figure 9-21. Many such crystals were so badly corroded that only sliver-like remnants were left. Etch figures on a Mursinsk beryl, similar to those described by Petersson,⁴⁴ were examined by Arzruni.²²

Traube⁴⁷ was the first to etch beryls artificially for the purpose of studying the pits made by a solvent, in this case, molten potassium hydroxide. He was able to develop regular six-sided pits on the pinacoidal faces, bounded by forms in the zone between $c\{0001\}$ and $m\{10\bar{1}0\}$, as well as more or less regular triangular pits on the faces of the first order bipyramid $p\{10\bar{1}1\}$, curved pits elongated along the horizontal axial direction on faces of the second order bipyramid $s\{11\bar{2}1\}$, and rectangular to curved pits on faces of the first order prism $m\{10\bar{1}0\}$ elongated along the c -axis direction. These pits became complex and diverse in form when ammonium bifluoride was used as the etchant.

Kohlmann's work on Brazilian beryls¹² contains a valuable review of the literature of etching as well as minute descriptions of etch marks found on natural specimens. Characteristic rectangular pits, some with bulged outlines, were found on $m\{10\bar{1}0\}$, and numerous canoe-shaped pits were found on the second order prism $a\{11\bar{2}0\}$, with the long dimension parallel to the c -axis. Triangular pits were found on $p\{10\bar{1}1\}$ of only one crystal, but similar triangular depressions were more abundant on the second order bipyramid $s\{11\bar{2}1\}$. As in previous findings, etch pits on pinacoidal faces were hexagonal in outline. Kohlmann also noted hexagonal tubes, oriented parallel to the c -axis, and others of irregular cross-section oriented in random directions.

Honess⁴⁸ produced etch figures on beryls by immersing them in molten sodium hydroxide and found that only fifteen seconds were required to obtain satisfactory

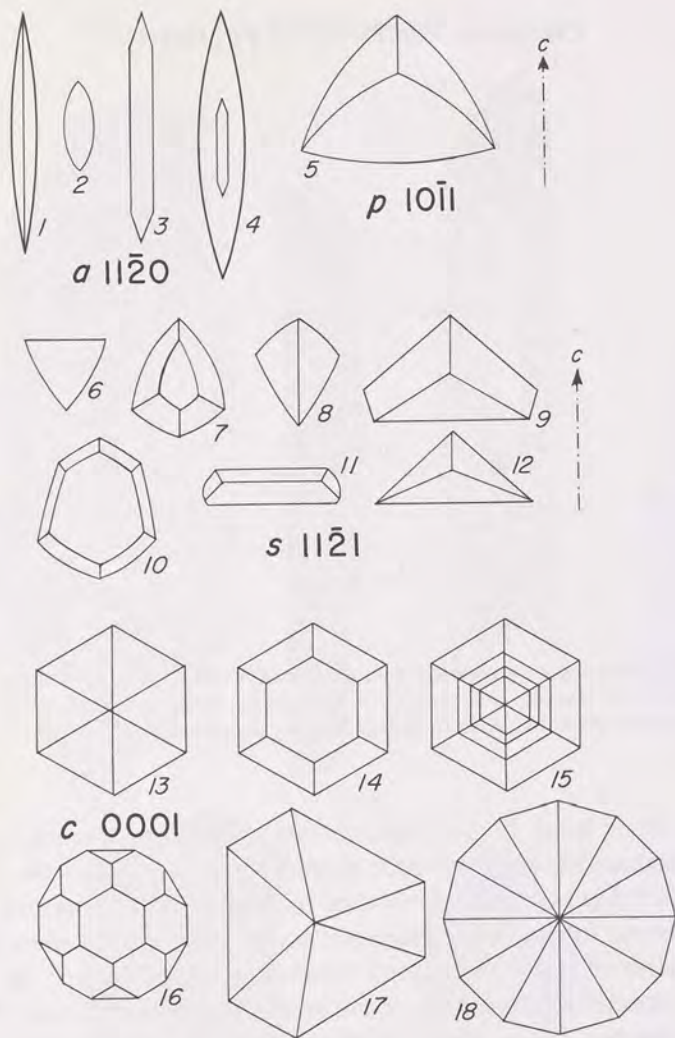

Fig. 9-20 Etch figures on other faces of beryl crystals. No. 1, emerald, Hiddenite, N.C. (Hones). No. 2-4, Brazil (Kohlmann). No. 5, Topsham, Maine (Hones). No. 6, 7, and 10, Brazil (Kohlmann). No. 8, Muzo emerald, No. 9, 11, and 12, Topsham, Maine (Hones). No. 13, Brazil aquamarine and North Carolina emerald (Kohlmann, Traube). No. 14, emerald, North Carolina (Hones), but a common pit on many beryl crystals. No. 15, trumpet-shaped pit which may extend via a narrow tube far into the crystal (see figure 9-5). No. 16, Brazil (Kohlmann). No. 17, emerald, North Carolina (Hones). No. 18, Topsham, Maine (Hones). A. P. Hones, On the etching figures of beryl, *American Journal of Science* 43 (1917):223-36. H. Kohlmann, Beiträge zur Kenntnis des brasilianischen Berylls, *Neues Jahrbuch für Mineralogie*, Beilage-Bd. 25 (1907):135-81. H. Traube, Ueber die Aetzfiguren einiger Minerale, *Neues Jahrbuch für Mineralogie*, Beilage-Bd. 10 (1895-6):454-69.

CHEMICAL AND PHYSICAL PROPERTIES



Fig. 9-21 A very steep dihexagonal bipyramid with the form $X 36.24.\overline{60}.5$. Observed on very small splinter-like crystals. Described by S. L. Penfield, Some observations on the beryllium minerals from Mt. Antero, Colorado, *American Journal of Science* 40 (1980):488-91.

results. On the other hand, boiling hydrofluoric acid, used "for an hour or more . . . failed to produce the slightest trace of etch figures or any of the forms." He also obtained etch figures using potassium hydroxide and a mixture of the two hydroxides, different figures being produced on the same crystal in each case.

Recent studies of beryl etch figures include those of Ernst⁴⁹ and Zedlitz.⁵⁰ Zedlitz studied especially gem-quality aquamarines from Minas Gerais, Brazil, upon which he found narrow, canoe-shaped figures on $m\{10\bar{1}0\}$ oriented *across* the *c*-axis direction in addition to those described by others which lie parallel to this axis. Feklichev⁵¹ discussed etch figures on beryl and their morphologies according to the symmetrical relationships to the crystal structure.

With caution, one may use table 9-8 to aid in identifying faces and directions in beryl crystals. (See figures 9-19 and 9-20.)

SURFACE GROWTH FEATURES

Whereas etch figures are caused by dissolution, other markings, generally in the form of very shallow raised areas or *hillocks* reflect the processes by which crystals gather the components necessary for growth. These markings are usually difficult to see except under magnification and strong side-lighting. Early studies on beryl growth figures by Griffin^{52,53} emphasized the important role played by

Crystallography



Fig. 9-22 Severely corroded aquamarine crystals from pegmatites of the Ukraine, USSR. From Z. B. Bartoshinskii et al. Accessory Beryl from Chambered Pegmatites of the Ukraine, *Mineralogicheskii Sbornik*, 4 (1969):382-97.

CHEMICAL AND PHYSICAL PROPERTIES

Table 9-8
BERYL ETCH MARKS RELATED TO STRUCTURE

<i>Shape</i>	<i>Symmetry</i>	<i>Face</i>
Rectangular, short to long	Two-fold symmetry	<i>m</i> prism
Rectangular, sides bulged	Two-fold symmetry	<i>m</i> prism
Canoe- or cigar-shaped	Two-fold symmetry	<i>a</i> prism
Approximately triangular	Approximately three-fold symmetry	Pyramidal
Hexagonal	Six-fold symmetry	Pinacoids only



Fig. 9-23 A completely etched mass of morganite from Brazil measuring approximately $16 \times 12 \times 12$ cm ($6\frac{5}{16} \times 4\frac{3}{4} \times 4\frac{3}{4}$ in). The orientation is with the *c*-axis vertical; there are numerous hexagonal "trumpet" etch pits on both ends of this axis. *Jeff Kurtzeman photo.*

Crystallography

spiral or screw dislocations in growth, especially on $m\{10\bar{1}0\}$ prism faces. Seager⁵⁴ noted that growth layers on beryl spread rapidly in the direction of the c -axis but only slowly in the horizontal directions. Grigoriev⁵⁵ also describes spiral growth in beryl, among other minerals. Spiral growths appear on both the faces of the first order prism and on the pinacoid faces. In the former they are elongated parallel to the c -axis, and in the latter, they form nearly circular spirals, the inner portions of which are hexagonal in outline, tending to become curved away from the point of generation. Growth spirals may be located on other faces also, and in many beryl crystals, especially those of considerable size and smooth faces, they may be thick enough to radically affect their flatness. If such crystals are also etched, the points of spiral generation, which represent weaker places in the crystal, are more rapidly subject to chemical attack and become the focal points for etch pit development.

Another surface feature which appears to be especially common on aquamarine crystals from the Adun Chilon locality in Transbaikalia is a series of striations parallel to the c -axis on faces of the first order prism $m\{10\bar{1}0\}$ (see figure 8-2). These mainly appear to be oscillatory combinations of adjacent m -faces and may reflect an internal mosaic growth of numerous more or less parallel individual crystals. The striations are never as sharply defined nor so regularly repeated as those observed on the prism faces of tourmaline crystals. In some crystals, similar markings are due to numerous elongated etch pits.

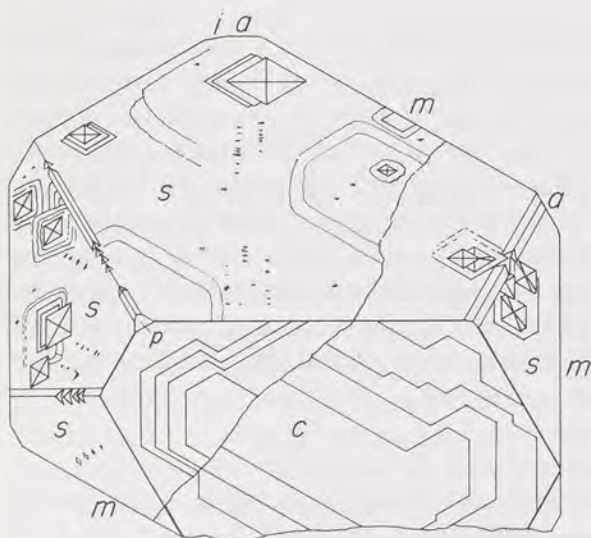

Fig. 9-24 Growth accessories on the terminal of a transparent greenish-blue aquamarine crystal from Spitzkopje, South West Africa; $20 \times 24 \times 87$ mm (ca. $1\frac{3}{16} \times 1 \times 3\frac{1}{2}$ in). Forms: $c\{0001\}$, $m\{10\bar{1}0\}$, $s\{11\bar{2}1\}$, $a\{11\bar{2}0\}$, $p\{10\bar{1}1\}$, and $i\{21\bar{3}0\}$. The large hexagonal markings on c are spiral growth plateaus; the diamond-shaped accessories are hillocks. After a drawing of H. Himmel and H. Schmidt-Zittel, *Wachstumsaccessorien am Beryll*, *Neues Jahrbuch für Mineralogie*, Abh. 55 (1927):118-25.

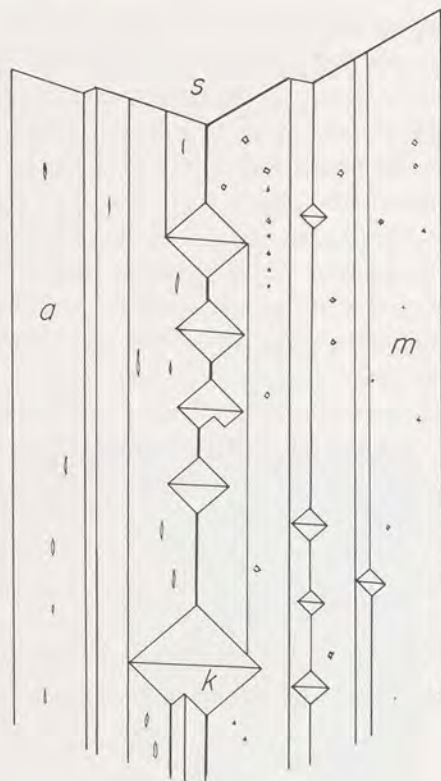

Fig. 9-25 Growth accessories along the edge between prisms $a\{11\bar{2}0\}$, and $m\{10\bar{1}0\}$, showing indentations of small faces of form $k\{4261\}$. Note that faces of a display different pits from those found on faces of m . From a drawing of H. Himmel and H. Schmidt-Zittel, Wachstumsakzessorien am Beryll, *Neues Jahrbuch für Mineralogie*, Abh. 55 (1927):118–25.

POLYGONAL TEXTURES

Anomalous optical properties in beryl, already discussed in Chapter 7, have been attributed by several investigators to strains set up within the crystal caused by changes in chemical composition within parts of the crystal. Sahama⁵⁶ studied gemmy Brazilian beryl crystals and found intricate polygonal textures within them, showing that the crystals were far from homogeneous. According to his investigations, growth is complicated by development of growth hillocks, as shown in figure 9-26, which “are not to be found only on the present outer faces of the crystal but must have been formed at all stages of the crystal growth.” However, he maintained that all such crystals examined by him were single crystals and not mosaics formed of numerous slightly misaligned individuals, and neither were they twins of lower symmetry individuals.

“SHELL” CRYSTALS

A peculiarity of some beryl crystals grown within pegmatite is their partial development, generally in zones close to the faces of the prism m , such that their

Crystallography

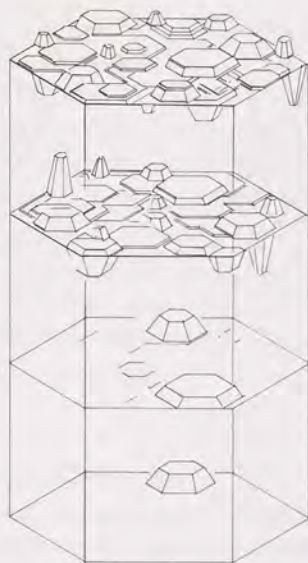

Fig. 9-26 A sketch showing how a single crystal of beryl may be composed of many sub-individuals. After a drawing by T. G. Sahama, Polygonal growth of beryl, *Comptes Rendus de la Société géologique de Finlande* 38 (1966):31-45.

interiors are filled with other pegmatite minerals, not with beryl. These have been called "shell," "stuffed," "cored," or "hollow" crystals. In 1938, Shaub⁵⁷ described such crystals from a New England pegmatite, noting in them a tendency toward tapered growth. He depicted cross sections showing the intergrowth with other minerals, which he believed to have occurred as a process of simultaneous development rather than later replacement of parts of the crystals. Much more complexly intergrown examples from a pegmatite of Paraiba, Brazil, were described and illustrated by Johnston.⁵⁸ These crystals contained within their cores large inclusions of feldspar, quartz, and tourmaline. Crookshank⁵⁹ noted similar crystals from pegmatites from Rajputana, India, and identified the same included species as found by Johnston but also remarked that they bore no regular crystallographic relationship to the host beryls. He suggested that these minerals entered core spaces after the beryls had been corroded. In another place, however, he noted what seemed to be a graphic intergrowth between beryl and albite, somewhat like one described by Shaub, which suggested a true crystallographic relationship. Such a relationship had already been advanced by Högbom⁶⁰ in 1899 as occurring in a specimen of microcline-perthite in which numerous beryl crystals were oriented with their *c*-axes at right angles to the feldspar basal cleavage plane.

Page et al.⁶¹ noted in connection with Black Hills pegmatites that "where sheet

CHEMICAL AND PHYSICAL PROPERTIES

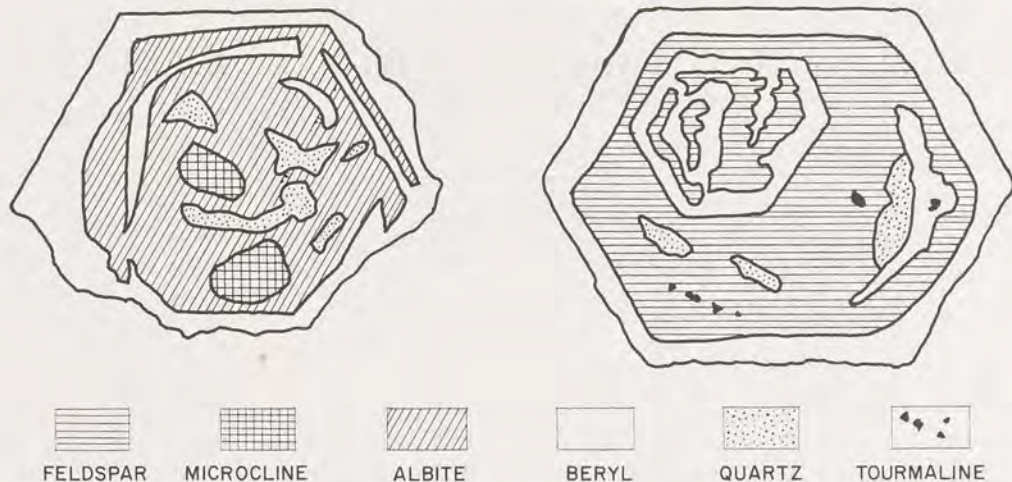

Fig. 9-27 Cross-sections of "stuffed," "skeletal," or "shell" crystals of beryl containing abundant inclusions of other minerals of the pegmatite. *Left:* From A. A. Beus, *Geochemistry of Beryllium and Genetic Types of Beryllium Deposits* (San Francisco: W. H. Freeman, 1966), p. 81. *Right:* A specimen from Cruzeiro, Municipio de Picui, Paraiba, Brazil, from W. D. Johnston, Jr., Beryllium- and tantalum-bearing pegmatites of Paraiba and Rio Grande do Norte, northeastern Brazil, *Departamento Nacional da Produccão Mineral, Divisào de Fomento da Produccão Mineral, Mineral Boletim 72* (Rio de Janeiro, 1945):31.

mica is present the beryl is dominantly of the skeletal crystal of 'shell' type," showing in their figure (p. 45) several crystals containing inclusions of one or more of the minerals plagioclase, tourmaline, quartz, muscovite, and apatite. Such shell crystals in the Helen Beryl pegmatite in that region were also noted by Staatz et al.⁶² (p. 161), who remarked that "much of the beryl in the wall zone is anhedral, but skeletal euhedral crystals are common . . . and consist of shells of beryl bounded by sharply defined crystal faces but having irregular boundaries on the inside which include aggregates of albite, quartz, muscovite, perthite, and tourmaline." Similar "hollow" crystals were reported from pegmatites of the Ajmer-Merwara, India, region by Mathur et al.,⁶³ wherein were found quartz, feldspar, tourmaline, and apatite. In one remarkable crystal, they found a core of quartz surrounded by beryl, and then another layer of quartz, all enclosed by the outermost beryl crystal.

Grigoriev⁵⁵ (p. 84-5) suggested that shell crystals grew initially along the side from which nutrient solutions flowed, thus nourishing only part of the crystal and causing it to develop as a prismatic *m* individual bounded only by several faces of that prism. In time, however, these partly developed walls curved around to complete the shell but entrapped the foreign minerals. Such partly developed crystals

Crystallography

may contain inclusions from the root extending well into the core of the upper part, or they may contain inclusions completely trapped by the beryl such that their presence is unknown unless the crystal is broken open.

As a rule, "shell" beryl crystals do not occur in cavities, although some skeletal crystals have been found from time to time in Brazilian pegmatite cavities. One such crystal that I examined is an aquamarine grown over a base of colorless beryl, which contained in its upper surface a deep depression filled with quartz and bertrandite crystals. It may represent a crystal that at some stage in its growth received a coating on the *c*-face such that only the edges of the face were exposed to nutrients, or whose interior was alkali beryl more easily corroded than the outer shell of ordinary aquamarine-type beryl.

DEFORMED CRYSTALS

External stresses placed upon already formed beryl crystals solidly enclosed in pegmatite may cause them to curve due to development of numerous fractures parallel to the basal plane. Some crystals may be offset in a series of segments, but all seem to be cemented firmly together with additional beryl material. However, in schist-type emerald deposits, what were once long prisms are commonly broken up into strings of short segments with the spaces between ranging in size from very thin openings filled with quartz or other minerals from the enclosing rock, to gaps which may be many millimeters across and filled with the schist itself.

RECORD-SIZE CRYSTALS

A summary of giant crystals in pegmatite bodies, including beryl, appeared in a 1953 study made by Jahns.⁶⁴ Gedney and Berman⁶⁵ described "star-like" groups of enormous beryl crystals from the Bumpus quarry, Maine, several of which were 4 feet (120 cm) in diameter, and one measured in place, though not fully exposed, was 14 feet (4.2 m) long. Page et al.⁶¹ mention a crystal of 18 feet (5.4 m) long in the Bob Ingersoll quarry, Black Hills, and noted that "the largest mass of beryl, 61 tons in weight," was mined from another pegmatite on the Bob Ingersoll property.

The Muiâne pegmatite quarry at Alto Ligonha, Mozambique, once exposed a giant crystal of sky blue color which measured about 8 feet (2.4 m) in diameter.⁶⁶ Saint Ours⁶⁷ reported that a crystal measuring 13 meters (39 ft) long and from 1.5 to 2 meters (4.5 to 6 ft) in diameter was found in Pegmatite A4 of the Malakialina field of Madagascar. Knorring⁶⁸ remarked on the very large crystals from Alto Ligonha, Mozambique, and noted that "blue and pink beryls are often found together, forming large aggregates . . . some 200 tons of beryl have been mined from a single mass at Namivo mine."

CHEMICAL AND PHYSICAL PROPERTIES

X-RAY DATA ON BERYL

X-rays are commonly used to identify beryl by taking advantage of the fact that when crushed beryl powder is irradiated by x-rays within a specially designed camera, the photographic film will register narrow lines representing reflections of the x-rays from planes within the crystal structure. These *powder* or *diffraction patterns* are so distinctive for each mineral that an unknown species, including beryl, can be readily identified by reference to a standard file of photographic negatives or numerical data which locate the lines and are conveniently published in the form of numbered file cards. The principles of x-ray diffraction are briefly given in C. S. Hurlbut, *Dana's Manual of Mineralogy*, 19th ed. (New York: John Wiley & Sons, 1977) and more extensively in L. Azaroff, *Elements of X-ray Crystallography* (New York: McGraw Hill Book Co., 1968), and also in M. J. Buerger, *X-ray Crystallography* (New York: Wiley-Interscience, 1942).

Table 9-9 lists major reflection lines for beryl, averaging the findings from a number of sources as given at the foot of the table. The letter "I" represents intensity of the reflection, or if the line is represented as a readout on a graph connected to the x-ray apparatus, this would be equal to the height of the peak, assuming 100 to be the maximum intensity. The second column gives d , the spacing in angstrom units (\AA) between the crystal planes indicated in the third column. It is to be noted that only three index numbers are used, these being sufficient to describe the location of these planes in the crystal structure.

Table 9-9
BERYL X-RAY DIFFRACTION DATA
Cu k-alpha Radiation

I	$d \text{ \AA}$	hkl	I	$d \text{ \AA}$	hkl	I	$d \text{ \AA}$	hkl
82	8.12	100	15	2.15	311	6	1.563	215, 702
39	4.62	110, 002	6	2.05	114	10	1.531	330, 006
35	3.94	200, 102	30	1.99	312, 204	10	1.511	413, 404
77	3.17	112	9	1.82	320, 402	10	1.45	332
33	3.02	210, 202	10	1.79	304, 313	10	1.45	116
87	2.87	211	12	1.737	304, 410	16	1.433	510, 422
32	2.53	212	9	1.71	411, 322	5	1.368	512, 216
9	2.30	220, 302	9	1.624	412, 224	11	1.276	520, 602
7	2.19	310	14	1.59	500, 314	12	1.261	415, 521, 424
			9	1.571	323			

Sources: Joint Committee on Powder Diffraction Standards, Card No. 9-430; Norrish,⁶⁹ p. 9; Radcliffe and Campbell,⁷⁰ p. 499; Vlasov and Kutukova,⁷¹ p. 115; Omori,⁷² p. 119; Barriga Villalba,⁷³ p. 38-9; Basta and Zaki,⁷⁴ p. 18.

Crystallography

Literature Cited

1. Bostock, J., and Riley, H. T. 1855-7. *The Natural History of Pliny*. Vol. 6. London: Henry G. Bohn. 529 pp.; See Book 37, ch. 18.
2. Burke, J. G. 1966. *Origins of the Science of Crystals*. Berkeley & Los Angeles: University of California Press. 198 pp.
3. Romé de Lisle, J. B. L. de. 1772. *Essai de Cristallographie*. Paris: Didot. 427 pp.
4. Aldrovandi, U. 1648. *Musaeum Metallicum*. Bologna 979 pp.
5. Romé de Lisle, J. B. L. de. 1783. *Cristallographie*. 4 vols. Paris: Imprimerie de Monsieur.
6. Haüy, R. J. 1801. *Traité de Minéralogie*. 5 vols. Paris: Delance.
7. Phillips, W. 1823. *An Elementary Introduction to the Knowledge of Mineralogy*. 3rd ed. London: W. Phillips. 406 pp.
8. Dana, J. D. 1837. *A System of Mineralogy*. New Haven: Durrie & Peck. 452, 119 pp.
9. Dana, E. S. 1892. *The System of Mineralogy of James Dwight Dana*. 6th ed. New York: John Wiley & Sons. 1134, 75 pp.
10. Goldschmidt, V. 1913. *Atlas der Krystallformen*. Vol. 1. Heidelberg: Carl Winter.
11. Pagliani, G., and Martinenghi, M. 1941. Il filone pegmatitico di Montescheno in Val Antron (Osola). *Periodico di Mineralogia* (Rome) 12:49-78.
12. Kohlmann, H. 1907. Beiträge zur Kenntniss der brasilianischen Berylls. *Neues Jahrbuch für Mineralogie* (Stuttgart) Beilage-Bd. 25, pp. 135-81.
13. Roos, G. 1951. Morphologische Untersuchungen an Datolith, Beryll und Adular. *Bulletin de la Société Fribourgeoise des Sciences Naturelles* 40:30-64.
14. Busz, K. 1890. Beryll von St. Piero, Elba. *Zeitschrift für Kristallographie und Mineralogie* (Leipzig) 17:552.
15. Himmel, H., and Schmidt-Zittel, H. 1927. Wachstumsakzessorien am Beryll. *Neues Jahrbuch für Mineralogie*, Abh. 55:118-25.
16. Millosevich, F. 1911. Forme nuove del berillo elbano. *Atti della Reale Accademia (Nazionale) dei Lincei, Rendiconti* (Rome) 20:138-44.
17. Jeremeyev, P. 1895. Ueber Berylle vom mürsinskschen Bezirk im Ural. *Zeitschrift für Kristallographie und Mineralogie* (Leipzig) 24:502.
18. Vrba, C. 1895. Mineralogische Notizen. VI. *Zeitschrift für Kristallographie und Mineralogie* (Leipzig) 24:104-23.
19. Hidden, W. E. 1886. Recent discovery of emeralds and hiddenite in North Carolina. *American Journal of Science* 32:483-4.
20. ———. 1881. North Carolina minerals and localities. *American Journal of Science* 22:21-5.
21. Rath, G. von. 1887. Notes on minerals from North Carolina. *American Journal of Science* 33:159-60.
22. Arzruni, A. 1894. Ein Bergkristall mit rhomboedrischer Ausbildung. *Zapiski Imperatorskago (S. Peterburgskogo) Mineralogicheskogo Obshchestva* (St. Petersburg), ser. 2, vol. 31, pp. 155-60.
23. Hintze, C. 1897. *Handbuch der Mineralogie*. Vol. 2: *Silicate und Titanate*. Leipzig: Veit & Comp. 1841 pp.
24. Leitmeier, H. 1937. Das Smaragdorkommen im Habachtal in Salzburg und seine Mineralien. *Tschermak's mineralogische und petrographische mitteilungen* 49:245-368.
25. Hidden, W. E., and Washington, H. S. 1887. Contributions to mineralogy. *American Journal of Science* 33:501-7.
26. Ford, W. E. 1906. Some interesting beryl crystals and their associations. *American Journal of Science* 22:217-23.
27. Duparc, L.; Wunder, M.; and Sabot, R. 1910. Contribution à la connaissance des minéraux et des pegmatites de Madagascar. Note sur le béryll . . . d'Antsirabe. *Bulletin de la Société Française de Minéralogie et Cristallographie* 33:53-7.
28. ———. 1911. Contribution à la connaissance des minéraux des pegmatites (deuxième note). *Bulletin de la Société Française de Minéralogie et Cristallographie* 34:131-8.
29. Lacroix, A. 1910. Nouvelles observations sur les minéraux des pegmatites de Madagascar. *Bulletin de la Société Française de Minéralogie et Cristallographie* 33:37-50.
30. Parsons, A. L. 1932. Twinned beryl from Lyndoch Township, Renfrew County, Ontario. *University of Toronto Studies, Geological Series* 32:23-4.
31. Pehrman, G. 1953. Zwei neue Zwillingsgesetze bei Beryll. *Neues Jahrbuch für Mineralogie*, Monatshefte Jg. 1953, p. 154.
32. Bertrand, E. 1879. [Muzo trapiche emeralds]. *Bulletin de la Société Française de Minéralogie et Cristallographie* 2:31.
33. Codazzi, R. L. 1915. *Contribucion al Estudio de los Minerales de Colombia*. Bogota: Imprenta de la Cruzada. 7 pp.
34. Pogue, J. E. 1916. The emerald in Spanish America. *Bulletin of the Pan-American Union* (Washington, D.C.) 43:706-20.
35. ———. 1916. The emerald deposits of Muzo, Colombia. *Transactions of the American Institute of Mining and Metallurgical Engineers* 55:910-34.
36. Bernauer, F. 1926. Die sogenannten Smaragddrillinge von Muzo und ihre optischen Anomalien. *Neues Jahrbuch für Mineralogie*, Abt. A, Beilage-Bd. 54, pp. 205-42.
37. Scheibe, R. 1926. Die Smaragdlagerstätte von

CHEMICAL AND PHYSICAL PROPERTIES

- Muzo (Kolumbien) und ihre nähere Umgebung. In O. Stutzer, Beiträge zur Geologie und Mineralogie von Kolumbien, IV. *Neues Jahrbuch für Mineralogie*, Vol. 54, Abt. B, pp. 419-47.
38. McKague, H. L. 1964. Trapiche emeralds from Colombia. *Gems & Gemology* 11:210-3.
 39. Chaudhari, M. W. 1969. An unusual emerald. *Schweizerische mineralogische und petrographische Mitteilungen* 49:569-75.
 40. Nassau, K., and Jackson, K. A. 1970. Trapiche emeralds from Chivor and Muzo, Columbia. *American Mineralogist* 55:416-27; correction, 55:1808-9.
 41. ———. 1970. Trapiche emeralds from Chivor and Muzo, Colombia: nature and origin. *Lapidary Journal* 24:82, 84-6.
 42. Tripp, E. J., and Hernandez, L. H. 1970. The complete trapiche emerald picture. *Lapidary Journal* 24:96-104.
 43. Wiik, F. J. 1887. Mineralogische und petrographische Mitteilungen. *Zeitschrift für Kristallographie und Mineralogie* (Leipzig) 12:515-7.
 44. Petersson, G. W. 1891. Natürliche Lösungserscheinungen an Beryll. *Zeitschrift für Kristallographie und Mineralogie* (Leipzig) 19:98-100.
 45. Penfield, S. L., and Sperry, E. S. 1888. Mineralogical notes. *American Journal of Science* 36:317-31.
 46. Penfield, S. L. 1890. Some observations on the beryllium minerals from Mt. Antero, Colorado. *American Journal of Science* 40:488-91.
 47. Traube, H. 1895-6. Ueber die Aetzfiguren einiger Minerale. *Neues Jahrbuch für Mineralogie Beilage-Bd. 10*, pp. 454-69.
 48. Honess, A. P. 1917. On the etching figures of beryl. *American Journal of Science* 43:223-6.
 49. Ernst, V. E. 1926. Über echte Ätzhugel und Lösungskörperformen am brasilianischer Beryll. *Zeitschrift für Kristallographie und Mineralogie* (Leipzig) 63:153-6.
 50. Zedlitz, O. 1941. Goniometrische Untersuchungen der Lösungs- und Ätzerscheinungen an einem Beryllkristall von Minas Geraes, Brasilien. *Neues Jahrbuch für Mineralogie*, Abt. A., pp. 98-108.
 51. Feklichev, V. G. 1964. *Berill: Morfologiya, Sostav i Struktura Kristallov*. Moscow: Izdatelstvo Nauka. 126 pp.
 52. Griffin, L. J. 1951. Microscopic studies on beryl crystals. II. Dislocations and growth of (1010) prism faces. *Philosophical Magazine* (London) 42:1337-52.
 53. ———. 1952. Microscopic studies on beryl crystals. III. Movement of dislocations. *Philosophical Magazine* (London) 43:826-47.
 54. Seager, A. F. 1952. The surface structure of crystals. *Mineralogical Magazine* (London) 30, no. 220, pp. 1-25.
 55. Grigoriev, D. P. 1961. *Ontogeny of Minerals* Jerusalem: Program for Scientific Translations. 250 pp.
 56. Sahama, T. G. 1966. Polygonal growth of beryl. *Comptes Rendus de la Société Géologique de Finlande* 38:31-45.
 57. Shaub, B. M. 1937. Contemporaneous crystallization of beryl and albite vs. replacement. *American Mineralogist* 22:1045-51.
 58. Johnston, W. D. 1945. Beryllium- and tantalum-bearing pegmatites of Paraíba and Rio Grande do Norte, northeastern Brazil. *Brasil Departamento Nacional Produção Mineral. Div. Fomento Produção Mineral Boletim* 72 (Rio de Janeiro), 85 pp.
 59. Crookshank, H. 1948. Minerals of the Rajputana pegmatites. *Transactions of the Mining, Geological and Metallurgical Institute of India* (Calcutta) 42:105-89.
 60. Högbom, A. G. 1899. Ueber einige Mineralverwachsungen. *Zeitschrift für Kristallographie und Mineralogie* (Leipzig) 31:314-5.
 61. Page, L. R., et al. 1953. Pegmatite investigations 1942-1945 Black Hills, South Dakota. *U.S. Geological Survey Professional Paper* 247. 228 pp.
 62. Staatz, M. H., et al. 1963. Exploration for beryl at the Helen Beryl, Elkhorn, and Tin Mountain pegmatites, Custer County, South Dakota. *U.S. Geological Survey Professional Paper* 297-C, pp. 129-97.
 63. Mathur, S. M., et al. 1955. The beryl quarries of Lohagal, Ajmer-Merwara. *Records of the Geological Survey of India* (Calcutta) 84:405-14.
 64. Jahns, R. H. 1953. The genesis of pegmatites. I. The origin and occurrence of giant crystals. *American Mineralogist* 38:563-98.
 65. Gedney, E. K., and Berman, H. 1929. Huge beryl crystals at Albany, Maine. *Rocks & Minerals* (Peekskill, N.Y.) 4:78-80.
 66. Mitchell K. 1959. The largest beryl crystal? *The Gemmologist* (London) 28, no. 341, p. 228.
 67. Saint Ours, J. de. 1960. Étude générale des pegmatites. *Republique Malgache Rapport Annuel du Service Géologique* (Tananarive), pp. 73-87.
 68. Knorring, O. 1962. Pegmatite and related investigations. In *University of Leeds, Research Institute of African Geology, 6th Annual Report, Session 1960-61*, pp. 7-13.
 69. Norrish, H. 1947. An x-ray study of West Australian beryl. *Journal of the Royal Society of Western Australia* 34:1-16.
 70. Radcliffe, D., and Campbell, F. A. 1966. Beryl from Birch Portage, Saskatchewan. *Canadian Mineralogist* 8:493-505.
 71. Vlasov, K. A., and Kutukova, E. I. 1960. [Em-

Crystallography

- erald Mines]. Moscow: Izdatelstvo Akademii Nauk SSSR. 249 pp.
72. Omori, K. 1961. Infrared absorption spectra of some essential minerals. *Science Reports of the Tohoku University* (Sendai), ser. 3, vol. 7, no. 1, pp. 101-30.
73. Barriga Villalba, A. M. 1953. Estructura de las esmeraldas de Muzo. *Revistas, Academia Colombiana Ciencias Exactes Físicas y Naturales* (Bogotá) 9, no. 33/34, pp. 37-43.
74. Basta, E. Z., and Zaki, M. 1961. Geology and mineralisation of Wadi Sikeit area, South-Eastern Desert. *Journal of Geology of the United Arab Republic*, 5:1-38.
75. Lacroix, A. 1922-23. *Minéralogie de Madagascar*. 3 vols. Paris: Augustin Challamel. Vol. 1, pp. 552, 554.

CHAPTER

10

INCLUSIONS

WHILE beryl crystals are remarkable for their lack of entrapped minerals and other types of inclusions, they are by no means free of them. Such inclusions encompass solids, liquids, and gases, but also various kinds of cavities which may or may not be filled with liquid and/or solid particles.

Gemologists are obviously interested in inclusions because too many of them can make otherwise good gem material worthless. But they are of interest for other reasons, too. Certain inclusions, especially in emerald, are distinctive and sometimes can even serve to identify the particular deposit from which they came. In the case of emeralds synthesized by the high-temperature flux-melt process, the inclusions are considerably different from those found in natural emeralds because water is never present in the cavities. Inclusions also provide evidence as to the geochemical environment in which the beryl crystals grew. Finally, some inclusions greatly enhance the value of certain gem beryls, such as in the cat's-eye types where the regular array of extremely fine tubes permits the cutting of handsome and valuable gems. Another example is star beryl, in which appear numerous minute plate-like inclusions deposited upon the basal planes of growing beryl crystals and subsequently covered over by additional beryl growth. Reflections from these inclusions provide interesting if not particularly handsome gems.

HISTORICAL NOTES

The inner imperfections of emerald must have been known to the ancient Egyptians from the moment their lapidaries began fashioning them into gems. Pliny

Inclusions

was aware of them and used the terms "filaments" and "salt-like grains" to describe in remarkably accurate fashion several typical emerald inclusions. Albertus Magnus¹ (d. 1280) stated that in beryl "water can be seen moving inside it," and also that "the better kind [from India] is said to be paler and to have more drops of water that can be seen" (p. 76). To this statement, Dorothy Wyckoff, the translator, adds "Albert had probably seen such a specimen, since this point is not in anyone else's description of beryl."

Frequent references to inclusions in emeralds and other beryls appear in the writings of authors subsequent to Albertus Magnus, but the first significant conclusions drawn from their presence in crystals came only in the early part of the last century when Humphrey Davy (1778–1829), the famous English chemist, extracted the fluid from cavities in rock crystal and found it to be nearly pure water. David Brewster, a noted contemporary of Davy's, devoted much study to inclusions and identified liquid-gas inclusions in beryl and other minerals.² Henry Clifton Sorby³ (1826–1908) remarked that Brewster, unable to find similar liquids in crystals formed through heat or sublimation, concluded that "the result [is] highly favourable to the supposition of the aqueous origin of all minerals in which cavities containing water had been discovered" (p. 453). According to Roedder,⁴ (p. 43) Brewster had discovered liquid carbon dioxide which mixed completely with water at high temperature but separated from it at low temperature in such a manner that the two liquids could be seen distinctly separated in the same cavity along with gaseous carbon dioxide.

In 1860, Söchting⁵ reported the following minerals included in beryls: chlorite and black tourmaline in Habachtal emerald; brown mica and quartz in Urals emerald; columbite in beryl from Haddam Neck, Connecticut; hematite, garnet, goethite, and arsenolite in Elba beryls; fluorite and arsenopyrite in beryls of the Adun Chilon; and yellow topaz in a beryl from Minas Gerais, Brazil. In 1869, Sorby and Butler⁶ described the "most striking" inclusions in emeralds as being "numbers of fluid-cavities containing two fluids and a vacuity . . . some of the specimens that we have examined are so full of fluid-cavities that they are only partially transparent." (This feature is found in nearly all emeralds regardless of source.) They also noted that the cavities contained only one liquid "which does not sensibly expand when warmed . . . in all probability this is a strong saline aqueous solution, since the cavities enclose cubic crystals."

A few years later, Isaac Lea⁷ (1792–1886) examined emerald and aquamarine and found similar inclusions, noting that "so far as I have been able to examine fine specimens of Emerald, it is rare to see one without cavities." He also found cubic crystals in the cavities and a similar crystal in a beryl from Unionville, Pennsylvania. Toward the close of the 19th century, Tilden⁸ identified gases driven from heated beryl as comprising 6.7 volume parts, of which 6 were carbon dioxide.

CHEMICAL AND PHYSICAL PROPERTIES

Type inclusions were classified by Vogelsang and Geissler⁹ in 1869. They recognized two distinct categories, the first being those inclusions which formed at the same time as their host crystal, which they called *primary*, and those that formed afterwards, called *secondary*. As will be shown below, these classifications have been expanded and better defined. Lehmann¹⁰ described fissures in beryl, which occurred more frequently along the basal cleavage plane than in other directions, and also fissures of irregular form which were more or less parallel to the faces of the prism $m\{10\bar{1}0\}$. Laemmlein¹¹ described fissures as well as the secondary inclusions contained within them, showing for beryls several types of basal cracks "healed" with additional but incomplete growth of beryl and a fissure parallel to an m -face which was largely refilled with beryl but retained numerous fine tubes parallel to the c -axis.

From the standpoint of the geologist interested in the conditions under which crystals formed, an impressive quantity of literature has been published as reflected in the extensive bibliography in Deicha.¹² However, from the gemological point of view, inclusions merited only scattered notice until the systematic treatment provided by H. Michel of Vienna in his *Pocket-Book for Jewellers*,¹³ published in 1929. Detailed descriptions of typical inclusions in emeralds and beryls were provided along with photomicrographs, among the first of their kind. The stimulus for such study arose from the increasing number of synthetic gems making their appearance on the market and the consequent need for reliable methods for their distinction. Eduard J. Gübelin of Switzerland, generally regarded as today's foremost authority on the subject of gemstone inclusions, credits Michel for calling the attention of gemologists to their importance. In 1948, Gübelin published an important paper on the diagnostic significance of inclusions.¹⁴ This was followed in 1953 by a monograph on the subject,¹⁵ which was in turn superseded in 1973 by a lavishly illustrated treatise.¹⁶ All of Gübelin's works have become standard authorities.

According to Gübelin¹⁶ (p. 37), inclusions may be divided among those that were present before the host crystal formed (the *protogenetic* types), those that formed contemporaneously (the *syngenetic*), and lastly, those which developed afterwards (the *epigenetic* inclusions). All three are known to occur in beryls and will be discussed in the sections below.

PROTOGENETIC INCLUSIONS

Protogenetic inclusions are minerals which formed before the beryl and were enveloped by the beryl crystal as it grew. They commonly include pegmatite and greisen species such as quartz, albite, and mica and are generally found in the bases of the crystals at the point of attachment to cavity walls. As previously noted, some common beryl crystals in pegmatites, completely enveloped by other minerals, may

Inclusions

have very large inclusions of quartz, feldspars, mica, black tourmaline, and apatite, forming coarsely granular masses within "shell" or "cored" crystals of beryl (see figure 9-27). In pegmatite cavities, alkali beryls, usually among the last species to form, may sometimes be found enclosing prisms of gemmy colored tourmaline as well as platelets of cleavelandite and other pocket species.

In long prismatic aquamarine and golden beryl crystals, small bits of mineral matter may fall upon the growing $c\{0001\}$ faces and may not be enclosed, the beryl crystal growing so rapidly in the direction of the c -axis that a miniature "well" is formed, the walls of which extend upward, sometimes to relatively enormous distances, without becoming bridged over by growth across the c -axis direction as shown in figure 10-1. It is likely that such bridging-over is prevented by the rapidity of growth, because once such a tube begins, it is extremely difficult for nutrient matter to circulate within the tube and cause the walls to grow toward each other. Similar tubular inclusions, possibly in slower-growing crystals, do bridge over. These may be recognized by the particle of foreign mineral at their bottoms and a gradual inward-curving closure of the walls until the entire inclusion resembles a greatly elongated rain-drop.

Gaps upon the basal plane of the growing beryl crystal can also be initiated by liquid droplets, which may take the form of flattened discs or very small spheres as shown in figure 10-3. The former tend to be closed over, but the latter tend to perpetuate the gaps formed by them, resulting in the very common extremely fine

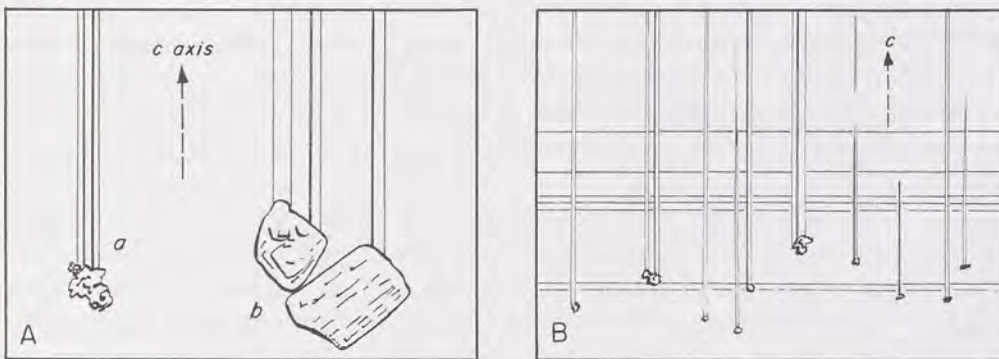

Fig. 10-1 Typical inclusions in beryls. A: Solid inclusions giving rise to face-lined tubes parallel to the c -axis; irregular mass at (a) probably a clay mineral, small crystals at (b), possibly of quartz. B: Similar tubular inclusions passing through color zones, the latter parallel to the basal plane $c\{0001\}$; some tubes persist, some are interrupted, and others taper to a closure in the "spike" or "nailhead" inclusions. From V. G. Feklichev, *Berill: morfologiya, sostav i struktura kristallov*. (Moscow: Izdatelstvo Nauka, 1964) and E. Gübelin, *Internal World of Gemstones: Documents from Space and Time* (Zurich: ABC Edition, 1973).

CHEMICAL AND PHYSICAL PROPERTIES

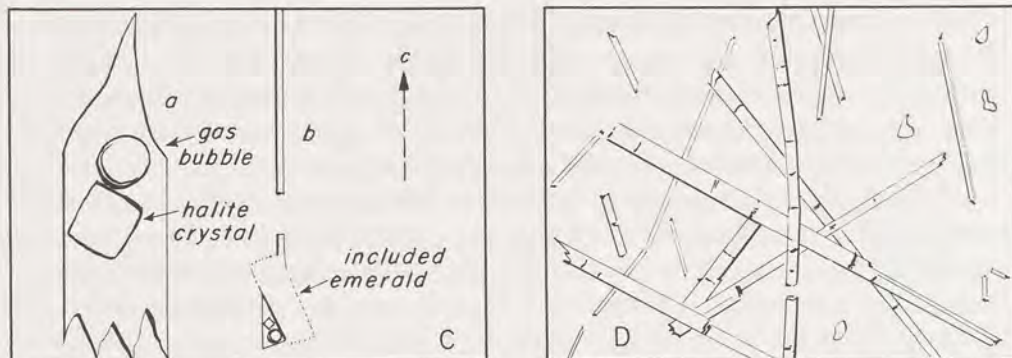

Fig. 10-2 Typical inclusions in beryl. C: Characteristic inclusions in Colombian emerald; jagged liquid-filled cavities at (a) contain a gas bubble and halite crystal while at (b) an inclusion of a small emerald crystal forms a three-phase inclusion as well as an axial tube, the latter interrupted, possibly by later growth. D: Actinolite inclusions in Uralian emerald; these are randomly scattered in the crystal. From V. G. Feklichev, *Berill: morfologiya, sostav i struktura kristallov*. (Moscow: Izdatelstvo Nauka, 1964) and E. Gübelin, *Internal World of Gemstones: Documents from Space and Time* (Zurich: ABC Edition, 1973).

tubular inclusions or "silk" that can be seen parallel to the *c*-axis in so many beryl crystals.

Protogenetic inclusions are especially common in emeralds grown within mica schists, as in the Egyptian, Uralian, and Rhodesian deposits. They are made up of such species as micas, actinolite, quartz, and black tourmaline, among others.



Fig. 10-3 Typical inclusions in beryl. E: Extremely thin plate-like dendrites of ilmenite (black) and hematite (orange) grown upon the basal plane $c\{0001\}$ of aquamarine from Brazil. F: Extremely thin voids resembling flattened bubbles forming planes of inclusions parallel to the basal plane $c\{0001\}$; as in E, some are epitaxial; all are so thin that vivid colors arise from those which interfere with light. From V. G. Feklichev, *Berill: morfologiya, sostav i struktura kristallov*. (Moscow: Izdatelstvo Nauka, 1964) and E. Gübelin, *Internal World of Gemstones: Documents from Space and Time* (Zurich: ABC Edition, 1973).

Inclusions

Despite growing within such rock, the emerald crystals manage to thrust aside the majority of minerals and remain reasonably free of them.

SYNGENETIC INCLUSIONS

Typical syngenetic inclusions in beryls are mentioned by Gübelin,¹⁶ p. 51-2 and include calcite rhombs in Muzo emerald, pyrite and pyrrhotite crystals in emerald, and quartz in aquamarine and emerald. Halite crystals are common in emerald as shown in figure 10-2; it is assumed that in this case the nutrient solution was saturated in sodium-chlorine ions which crystallized into halite with a drop in temperature.

Epitaxial growths are another kind of inclusion found in beryl crystals. The term *epitaxy* refers to minerals growing upon others in such a manner that the orientation of the epitaxial mineral is governed by the crystal structure of the host. Thus certain aquamarine crystals of Brazil contain thin platelets of ilmenite and hematite which assume parallel positions on the basal faces of the host, become entrapped, and are finally completely covered by the beryl. Because of their common orientation, such beryl crystals can be polished as cabochons with their bases parallel to the $c\{0001\}$ plane, and the reflections from the inclusions give rise to asterism or a "star."

SYNGENETIC LIQUID INCLUSIONS

As mentioned before, by far the commonest inclusion in all beryls is liquid, sometimes two liquids, sometimes also gas, and occasionally small crystals grown within the liquids. Gübelin¹⁶ (pp. 69-70) noted that the "normal" filling is usually water, dissolved salts, traces of heavy elements, and carbon dioxide gas, the last mixed with water vapor. Among the elements detected were Na, Ca, K, Mg, Cl, and F, as well as carbonate, carbonic acid, and sulfate ions. The cavity fillings in emeralds, for example, are saline, sometimes so saturated with salts that minute crystals of halite, sylvite, and anhydrite precipitates can be observed under high magnification. In a recent study of cavity contents in Colombian emerald, Touray and Poirot¹⁷ confirmed the presence of a saline solution, gas, halite crystals, and an unidentified mineral in the host crystal which seemed to encourage the formation of elongated inclusions trailing from the mineral particles.

Liquid inclusions can be further classified according to whether they are primary or secondary, the first being those droplets which adhere to the host beryl during growth and are subsequently trapped, and the secondary being those liquids which intrude into fractures and fissures which arise from later rupture of the host crystal. Primary liquid inclusions often appear to have no crystallographic relationship to the host and thus occur in random shapes and orientations. Commonly they form swarms which may be so dense that the crystal appears milky. In emeralds, they often resemble mossy growths, resulting in the descriptive terms of "garden"

CHEMICAL AND PHYSICAL PROPERTIES

or the French "jardin" emeralds. Under high magnification the cavities are often jagged or "sawtoothed" in profile and are filled with liquid, sometimes also a gas bubble, and as is common in Colombian emeralds, one or two minute halite crystals.

The numerous tubular inclusions that parallel the c -axis that were mentioned before, range in size from stubby cylinders to extremely long hair-like openings, usually also filled with liquid-gas and sometimes a few very small crystals of a foreign mineral. Unlike the irregular cavities mentioned above under emerald, these tend to be bounded on their sides by crystal faces and hence have been called "negative" crystals. They tend to perpetuate themselves and for this reason may sometimes be traced unbroken throughout a long prism of beryl.

Some beryl crystals display sharp zones of clear material interspersed with zones containing large numbers of the tubular inclusions mentioned. In aquamarines, for example, numerous inclusions of this sort may be present in the lower portion but abruptly disappear near the top. Other crystals may be found in which this zoning is reversed, that is, the crystal is essentially free of inclusions near its base but contains them near the termination. This pattern seems more common in golden beryls than in aquamarines. Striking and differently colored zones of inclusions are a particular feature of the beautiful beryl prisms from the Adun Chilon deposits of Transbaikalia, USSR, but examples may be found in many other deposits too.

The cause of this zoning may be due to changes in the velocity of crystal growth. Probably a faster-growing individual tends to entrap rather than thrust aside impurities that fall upon the $c\{0001\}$ face, while the reverse applies to a slower-growing crystal. Because inclusions represent greater exposed area, subsequent corrosion of the crystal may manifest itself in deep pitting of the $c\{0001\}$ face and the development of striations on the sides of the prism due to attack on tubular inclusions close to the surface.

As we have seen, minute spherical droplets or bits of foreign mineral which fall upon the c -faces of growing beryl crystals can cause tubular development. In contrast, some droplets of fluid are discoidal in shape and, when numerous, cause a decided pearly luster on these faces. The disc-shaped droplets are so broad that the nutrient solution is able to flow over them and cause the growing crystal to completely enclose them as shown in figure 10-3.

Secondary liquid inclusions cause some of the most interesting optical displays within beryl crystals. Some seem like very thin diaphanous veils entrapped within the clear material, others like spatters of rain that fell upon glass and formed random dispersal patterns. Such inclusions generally represent former fracture openings in the host crystal, possibly due to internal stresses resulting from changes in chemical composition, or perhaps due to thermal or physical shock. In any case, the cracks were accessible to the external nutrient solution, which carried in additional beryl material and deposited it to fill the cracks. As pointed out by Laemmlein,¹¹ cracks

Inclusions

in beryl crystals may occur more or less parallel to cleavage planes $c\{0001\}$ and $m\{10\bar{1}0\}$, which then "heal" with introduction of additional material but leave traces in the form of numerous liquid-gas cavities. A particular manifestation of such planar cracks is the so-called "fingerprint" pattern, representing a more or less circular original crack opening. Typically, the narrower portions of these cracks contain more inclusions than the wider parts, because it is more difficult for the solution to reach into them and deposit beryl during the "healing" process.

EPIGENETIC INCLUSIONS

According to Gübelin,¹⁶ (p. 88) only ilmenite and hematite are considered epigenetic, that is, formed after the beryl host by a process of crystallizing within the beryl (exsolution). A similar process is thought to account for the silk-like crystals of rutile in star ruby and sapphire, and indeed the natural stones have been duplicated in the laboratory by a process of melting and slow cooling, upon which the deliberately added impurities capable of forming rutile exsolve to provide synthetic star gem material. However, in nature, where virtually all beryls grow in liquid and at much lower temperatures than those that must prevail for ruby and sapphire, it seems doubtful that beryl crystals could accommodate considerable amounts of either ilmenite or rutile impurities during growth, much less allow them to form crystals within the structure afterward. In view of the fact that both ilmenite and hematite occur in well-defined bands in beryl crystals instead of being uniformly distributed throughout, as would be likely in a process of exsolution, it is considered that they are syngenetic in origin, that is, they grow epitaxially upon faces of the beryl host crystal and later become enclosed by additional beryl growth.

SOLID INCLUSIONS

Table 10-1, Mineral Inclusions in Beryl, has been compiled from many sources, but it must be far from complete considering how difficult it can be to positively identify extremely small inclusions of minerals. For this reason, some entries are accompanied by a question mark, indicating an identification of doubtful validity. Many identifications have been made visually under magnification, still the common practice, and it is only lately that identifications based on chemical composition have been possible on extremely small samples by use of the electron microprobe, an instrument that can focus a beam of electrons on an extremely small area to produce x-rays characteristic of certain elements. Quantitative as well as qualitative data may be obtained with the instrument that are often sufficient to identify the mineral. A brief discussion of the technique and its applicability to the study of inclusions in gemstones appears in Gübelin¹⁶ (pp. 23-4). Graziani and others^{39,40,41,42} used the microprobe to conduct their examinations of beryl inclusions.

CTA

CHEMICAL AND PHYSICAL PROPERTIES

Table 10-1
MINERAL INCLUSIONS IN BERYL

<i>Mineral</i>	<i>Description</i>	<i>Locality</i>	<i>References</i>
Actinolite	Rodlike crystals in emerald	Urals; Habachtal	5, 16, 18, 19
Albite	Bladed crystals in pink beryl	Haddam Neck	20
Albite	In emerald	Chivor; Gachala	16
Albite	In trapiche emerald	Muzo	16
Apatite	In aquamarine	—	16, 21
Apatite	In aquamarine	Brazil	39, 40, 42
Apatite	In emerald	Habachtal	16
Arsenolite (?)	In beryl	Elba	5
Beryl	In beryl	Sondalo, Italy	22
Beryl	In aquamarine	Brazil	42
Biotite	In emerald	Urals; Habachtal; Transvaal; Goiaz	16, 23, 24, 25
Biotite	In beryl	Uuksu, Finland	26
Biotite	In aquamarine	India	16
Byssolite	In emerald	Bom Jesus d. Meiras	18
Bitiyte (?)	Oriented plates in beryl	Brazil	27
Calcite	Rhombs in emerald	Muzo	16
Calcite	In V-emerald	Salininha, Bahia	41
Calcite	In emerald	Transvaal; Urals	18, 28
Calcite	In beryl	—	29
Carbon (?)	In trapiche emerald	Muzo	16
Chlorapatite	In emerald	India	16
Chlorite	In emerald	Habachtal	5
Chlorite	In beryl	Graz, Austria	30
Chromite	In emerald	—	16
Columbite	In beryl	Haddam Neck	5
Columbite-tantalite	In aquamarine	Pakistan (?)	43
Corundum	In aquamarine	Brazil	39, 40, 41, 42
Dolomite	In emerald	Goiaz, Brazil	16, 25
Epidote	In emerald	Habachtal	16
Epidote	In beryl	—	16, 21
Epidote	In aquamarine	Brazil	39, 40, 42
Feldspar	In beryl	Elba	5
Feldspar	In V-emerald	Salininha, Bahia	41
Feldspar	In emerald	Sandawana	16
Fluorapatite	In aquamarine	Brazil	42
Fluorite	In beryl	Adun Chilon; Uuksu, Finland	5, 26
Fluorite	In pink beryl	Wodgina, W. Australia	31

Inclusions

Table 10-1 (continued)
MINERAL INCLUSIONS IN BERYL

Mineral	Description	Locality	References
Fuchsite	In emerald	Ajmer-Merwara	16
Fuchsite	In aquamarine	Brazil	42
Garnet	In pink beryl	Haddam Neck	20
Garnet	In beryl	Elba	5
Garnet	In aquamarine	Pakistan (?)	43
Garnet	In emerald	Sandawana	16
Goethite	In beryl	Elba	5
Halite	In emerald	Colombia	15, 16, 17
Halite	In beryl	—	16, 32
Hematite	In emerald	Habachtal; Sandawana	16, 18
Hematite	In green beryl	Elba	5
Hematite	In aquamarine	Brazil	42
Hematite	In beryl	Brazil	16
Ilmenite	In beryl, on $c\{0001\}$	Minas Gerais	33
Ilmenite	In aquamarine	Brazil	42
Ilmenite	In beryl	Brazil; Madagascar	16
Kaolin	In beryl	Sondalo	22
Lepidocrocite	In aquamarine	Brazil	42
Magnetite	Crystals in beryl	Lonedo, Italy	34
Magnetite	In aquamarine	Brazil	40
Mica	Plates in emerald	Urals; Transvaal	16, 28
Molybdenite	Flakes in emerald	Transvaal	16
Muscovite	In beryl	Sondalo; Uuksu, Finland	22, 26
Muscovite	In pale blue beryl	Brazil	27
Parisite	In emerald, pink crystals	Muzo	15, 16, 35
Pentlandite	In emerald	—	36
Petalite	In beryl	—	29
Phlogopite	In emerald	Urals	19
Phlogopite	In V-emerald	Salininha, Bahia	41
Phlogopite	In pale blue beryl	Brazil	27
Phlogopite	In aquamarine	—	36
Pollucite (?)	In beryl	Elba	37
Pyrite	Euhedrons in emerald	Chivor	16
Pyrite	In emerald	Leysdorp	38
Pyrite	In beryl	Lonedo, Italy	34
Pyrite	In beryl	—	21
Pyrite	In aquamarine	Brazil	39
Pyrrhotite	In emerald	—	16

CTA

CHEMICAL AND PHYSICAL PROPERTIES

Table 10-1 (continued)
MINERAL INCLUSIONS IN BERYL

<i>Mineral</i>	<i>Description</i>	<i>Locality</i>	<i>References</i>
Pyrrhotite	In green beryl	—	21
Pyrrhotite	In aquamarine	Brazil	39
Quartz	In emerald	Chivor; Urals	5, 16
Quartz	In aquamarine	Brazil; W. Australia	21, 31, 39, 40, 42
Rutile	In emerald	Habachtal; Goiaz, Brazil	23, 25
Talc	In emerald	Urals; Goiaz, Brazil	16, 19, 25
Talc	In V-emerald	Salininha, Bahia	41
Titanite	In emerald	Habachtal	16
Topaz (?)	In beryl	Minas Gerais	5
Tourmaline	In emerald	Habachtal; Urals	5, 16, 23, 24
Tourmaline	In pink beryl	Haddam Neck	19
Tremolite	Acicular crystals in emerald	Habachtal; Sandawana	16

Literature Cited

- Wyckoff, D. 1967. *Albertus Magnus Book of Minerals*. Oxford: Clarendon Press. 309 pp.
- Brewster, D. 1824. On the existence of two new fluids in the cavities of minerals, etc. *Transactions of the Royal Society of Edinburgh* 10:1-41; abstract in *Edinburgh Philosophical Journal* 9 (1823):94-107.
- Sorby, H. C. 1858. On the microscopical structure of crystals. *Quarterly Journal of the Geological Society of London* 14:453-500.
- Roedder, E. 1962. Ancient fluids in crystals. *Scientific American* 207, no. 4, pp. 38-47.
- Söchting, E. 1860. *Die Einschlüsse von Mineralien*. Freiberg, Germany: J. G. Engelhardt. 357 pp.
- Sorby, H. C., and Butler, P. J. 1869. On the structure of rubies, sapphires, diamonds, and some other minerals. *Proceedings of the Royal Society of London* 17:291-302.
- Lea, I. 1876. Further notes on "inclusions" in gems. *Proceedings of the Academy of Natural Sciences of Philadelphia* 28:98-107.
- Tilden, W. A. 1896. On the gases in crystalline rocks and minerals. *Proceedings of the Royal Society of London* 60:453.
- Vogelsang, H., and Geissler, H. 1869. Über die Natur der Flüssigkeitseinschlüsse in gewissen Mineralien. *Annalen der Physik und Chemie* (Leipzig) 137:56-75.
- Lehmann, J. 1886. Contractionsrisse an Krystallen. *Zeitschrift für Kristallographie und Mineralogie* (Leipzig) 11:608-12.
- Laemmlein, G. 1929. Sekundäre Flüssigkeitseinschlüsse in Mineralien. *Zeitschrift für Kristallographie und Mineralogie* (Leipzig) 71:237-56.
- Deicha, G. 1955. *Les Lacunes des Cristaux et Leurs Inclusions Fluides*. Paris: Masson. 126 pp.
- Michel, H. 1929. *The Pocket-Book for Jewellers*. New York & Vienna: Herz. 2 parts, looseleaf.
- Gübelin, E. J. 1948. Die diagnostische Bedeutung der Einschlüsse in Edelsteinen. *Schweizerische mineralogische und petrographische Mitteilungen* 28, no. 1, pp. 146-56.
- . 1953. *Inclusions as a Means of Gemstone Identification*. Los Angeles: Gemological Institute of America. 220 pp.
- . 1973. *Internal World of Gemstones*. Zurich: ABC Edition. 234 pp.
- Touray, J. C., and Poirot, J. P. 1968. Observations sur les inclusions fluides primaires de l'émeraude, etc. *Compte Rendu de l'Academie des Sciences* (Paris), ser. D, vol. 266, no. 4, pp. 305-8.
- Roulet, B. 1955. Methoden zur Fundortbestimmung bei Smaragden. *Zeitschrift der deutsche Gesellschaft für Edelsteinkunde* no. 11, pp. 3-11; no. 12, pp. 8-16.
- Vlasov, K. A., and Kutukova, E. I. 1960. [Em-

Inclusions

- erald Mines]. Moscow: Akademiya Nauk SSSR. 252 pp.
20. Bowman, H. L. 1902. On an occurrence of minerals at Haddam Neck, Connecticut, U.S.A. *Mineralogical Magazine* (London) 13, no. 60, pp. 97-121.
 21. Eppler, W. F. 1960. An unusual star-beryl. *Journal of Gemmology* (London) 7:183-91.
 22. Brugnatelli, L. 1902. Beryll und andere Mineralien der Pegmatite von Sondalo im Veltlin. *Zeitschrift für Kristallographie und Mineralogie* (Leipzig) 36:97-101.
 23. Leitmeier, H. 1937. Das Smaragdorkommen im Habachtal in Salzburg und seine Mineralien. *Tschermak's mineralogische und petrographische Mitteilungen* (Vienna) 49:245-368.
 24. Bölsche, R. 1954. Das Smaragdorkommen im Habachtal. *Der Aufschluss* (Heidelberg) 5, no. 6, pp. 106-12.
 25. Leinz, V., and Leonardos, O. H. 1936. Notas sobre las esmeraldas da fazenda das Lages, Itaberahy, Goyaz. *Avulso Servicio de Fomento da Produção Mineral* (Rio de Janeiro), no. 13. 14 pp.
 26. Kranck, E. H. 1929. A beryl-bearing pegmatite from Uuksu in Carelia (Finland). *Comptes Rendu de la Société Géologique de Finlande*. 8 pp.
 27. Strunz, H., Tennyson, C., and Uebel, P. J. 1970. Cordierit. *Der Aufschluss* (Heidelberg) 21, no. 1, pp. 2-22.
 28. Böse, R. 1936. Optische und spektrographische Untersuchungen an Beryllen, etc. *Neues Jahrbuch für Mineralogie* (Stuttgart) Beilage-Bd. 70, pp. 467-570.
 29. Eppler, W. F. 1961. Growth marks in emerald. *Journal of Gemmology* (London) 8:72-7.
 30. Angel, F. 1933. Spodumen und Beryll aus dem Pegmatiten von St. Radegund bei Graz. *Tschermak's mineralogische und petrographische Mitteilungen* 43:441-6.
 31. Grubb, P. L. C. 1964. On beryl from Western Australia. *Journal of the Royal Society of Western Australia* 47:51-3.
 32. Eppler, W. F. 1962. Three-phase inclusions in emerald, aquamarine and topaz. *Journal of Gemmology* (London) 8:245-50.
 33. ———. 1958. Notes on asterism in corundum, rose quartz and almandine garnet and chatoyancy in beryl. *Journal of Gemmology* (London) 6:195-212.
 34. Panebianco, R. 1888. Ueber Beryllkristalle von Lonedo. *Zeitschrift für Kristallographie und Mineralogie* (Leipzig) 14:513-4.
 35. Santos Munsuri, A. 1968. *La Esmeralda*. Madrid: Instituto Gemologico Espanol. 121 pp.
 36. Gübelin, E. 1969. On the nature of mineral inclusions in gemstones. *Journal of Gemmology* (London) 11:149-92.
 37. Strüver, G. 1887. Sopra un cristallo di berillo dell'Elba con inclusione interessante. *Rendiconti R. Accademia (Nazionale) de Lincei* (Rome) 3:461-3.
 38. Van Eeden, O. R., et al. 1939. The mineral deposits of the Murchison Range, east of Leysdorp. *Memoirs of the Geological Survey, Union of South Africa* (Pretoria) 36. 163 pp.
 39. Graziani, G., and Guidi, G. 1979. Mineralogical study of a star-beryl and its inclusions. *Neues Jahrbuch für Mineralogie, Monatshefte*, Jg. 1979, no. 2, pp. 86-92.
 40. Graziani, G., and Giulio, V. Di. 1979. Growth of an aquamarine crystal from Brazil. *Neues Jahrbuch für Mineralogie, Monatshefte*, Jg. 1979, no. 3, pp. 101-8.
 41. Graziani, G., and Lucchesi, S. 1979. Einschlüsse und Genese eines Vanadiumberylls von Salininha, Bahia, Brasilien. *Zeitschrift der deutschen gemmologischen Gesellschaft* 28, no. 3, pp. 134-45.
 42. Graziani, G., and Giulio, V. Di. 1979. *Neues Jahrbuch für Mineralogie*, 137, no. 3, pp. 198-207.
 43. Bank, H. 1980. Seltene Aquamarinparagenese mit Granat und Einschlüssen von Columbit-Tantalit. *Zeitschrift der deutschen gemmologischen Gesellschaft* 29, no. 1/2, pp. 92-3.

CHAPTER

II

ARTIFICIAL AND SYNTHETIC BERYLS

THE zeal of the miner in uncovering valuable gemstones is matched by the zeal of the imitator of gems. Imitation gems have been used since antiquity, but most of them were made from glass or sometimes from other stones which could be skillfully disguised to give them the appearance of valuable gemstones. It is only since the last century, when chemical composition of minerals became known, that serious attempts have been made to duplicate natural stones through the process of *synthesis*, that is, to produce substances that in every essential were identical to their natural counterparts.

GLASS AND OTHER IMITATIONS

The use of green glass to make artificial emeralds began soon after glass itself was discovered. According to Lucas¹ (p. 116), the exact date that glass-making began in Egypt is uncertain, but he mentioned a "large green ball bead," inscribed with the name of Amenophis I, as certainly dating its manufacture to at least the beginning of the 18th Dynasty, or about 1600 B.C.

The use of glass to imitate emerald and other beryls continued without interruption into modern times, glass makers learning how to skillfully incorporate swarms of bubbles in green paste to simulate the natural inclusions of emerald. Numerous examples of antique pastes are to be found in every major collection of engraved gems and jewelry. Marcus Seneca (54 B.C.–39 A.D.) wrote in his *Epistles* (ep. 90, 33), that Democritus of Thrace (ca. 5th century B.C.) was famous for his glass imitations of emerald or the discovery of an emerald imitation^{2,3} (vol. 1, p. 124; p. 81). Feldhaus⁴ told of the troubles experienced with imitations of emerald in the jewelry trade of the 16th century in Nuremberg, while Leonardus Camillus,⁵

Artificial and Synthetic Beryls

who lived about 1500 A.D., stated, "I have often seen *Emeralds*, far from bad ones, at least for Use, made out of these stones," here referring to glass pastes. But he also noted that the scratch test for hardness, commonly used to distinguish glass from natural gems, did not work for emerald because emerald scratched with about the same ease as glass. This statement seems to indicate that Leonardus did not have a genuine emerald at hand for comparison because all beryls are considerably harder than any of the glasses that were manufactured in Leonardus' time.

Imitation of emerald and other precious stones reached a peak of perfection during the Renaissance. Benvenuto Cellini (1500–1571), the eminent Florentine goldsmith, boasted about his skill in detecting frauds⁶ (pp. 26–7), but he also said that imitations were made not only of solid pieces of glass but from several pieces of material cemented together. For example, "I mind me also of having seen rubies and emeralds made double, like red and green crystals, stuck together, the stone being in two pieces, and their usual name is 'doppie' or doublets." Unfortunately, Cellini did not make clear whether the pieces were all of glass or part-glass, or perhaps two parts of genuine gem material. Further on, "emeralds and sapphires are also manufactured out of single stones, and this so cleverly that they are often difficult to tell, and however wonderfully they are counterfeited in colour they are so soft, that any good jeweller with the average amount of brains, can easily spot them."

Another ancient technique of imitation involved dyeing rock crystal. The technique probably stemmed from the practice of "oiling" rough crystals with some suitable fluid to fill in the natural cracks and thus both enhance the color and give an impression of flawlessness, albeit temporarily. This practice continues today. Pliny⁷ (vol. 6, p. 463) was familiar with this method of artificial coloration of gemstones to imitate the emerald, but gave no details. However, details are to be found in an ancient papyrus manuscript of Thebes⁸ (p. 184 ff.) which told how rock crystal and even beryl can be heated and then plunged into a bath containing copper salts, especially the bright green acetate of copper or verdigris. The hot stones cracked and upon cooling drew the pigment within the recesses. Indigo, used with a kind of resin, produced an aquamarine color. Much the same practice was still employed in 1879 in India when Tagore wrote his *Mani-Mala*⁹ (vol. 1, p. 414) wherein he stated that heated quartz was plunged into a bath of verdigris dissolved in turpentine. King¹⁰ (p. 52) mentioned that Indians used a bath saturated with an oxide of copper and described another deception in which "the Indians paint the back of every coloured gem they set, so as to improve the fainter tinted; for which reason they never mount them in their jewellery without a backing."

The use of backings to heighten color began much before the Renaissance, and by Cellini's time had become a standard practice. For example, Cellini⁶ (p. 28) gave an alloy for making a "green foil," consisting of 10 carats of fine copper, 6

CHEMICAL AND PHYSICAL PROPERTIES

of silver, and one of gold. A simple, highly polished gold or silver foil "mirror" could be cleverly set beneath the gem in its mounting to reflect such light as passed through the gem. If the foil mirror were also enameled in a suitable color, the color would be transmitted through the gem to counteract any natural paleness or to even impart a color that the stone (or glass) did not have to begin with.

From the middle of the 15th century, or almost with the inception of printing, formulations for colored glasses imitative of gems abound and are even common in manuscripts before that time. One of the most popular books on glass-making was *De Arte Vitrayia* by the Italian chemist, Antonio Neri, first published in 1592 and repeatedly thereafter. In an English translation of 1662¹¹ (p. 128-31), several recipes are given for making "emeralds." Formulas of this sort were repeated and modified with the passage of time, with several more modern ones appearing in Barbot¹² (pp. 533-6). All of them involve use of a fundamental, essentially colorless glass or paste, also called "Strass," presumably after its inventor, to which was added coloring agents such as green oxide of copper, chrome oxide, copper acetate, and iron oxide, for making "emeralds." An antimony glass to which was added cobalt oxide produced "aquamarine."

In later periods when the use of glass containers became common, the green kind were often cut by unscrupulous lapidaries into "emerald" gems and foisted off on unsuspecting buyers. Tagore⁹ (vol. 1, p. 414) noted that the natives of Ceylon, a country famed since antiquity for supplies of natural gemstones, "are known to collect the thick bottoms of wine-bottles, out of which they cut very good Emeralds which they sell to the sailors." This deception was not confined to the wily Singhalese by any means, for he further noted that at Brighton, England, "Emeralds are made of similar stuff," and the local lapidaries "purposely throw away the broken bottles into the sea, where, through attrition of the shingle, they become transformed into natural pebbles and thus bring to the clever artists great profit."

Other subterfuges, in addition to those mentioned above, were employed to "improve" cut emeralds. For example, flawed gems were impregnated with an emerald-dyed wax or varnish to fill in the crevices. In some instances, an entire gem was coated with a colored varnish or lacquer, or in the case of emeralds set in rings, a varnish applied only to the back where it could escape detection for a time. Another trick, also depending on inaccessibility, used a dyed wax to impregnate the inside surface of bead holes.

COMPOSITE GEMS

Composite gems, or assembled stones, also known as doublets and triplets according to the number of pieces used, were well-known by Cellini's time, as noted above. The principle behind all of them is to enhance color and/or durability. For example, in a simple type of doublet, a bright green glass base could be used

Artificial and Synthetic Beryls

to impart the necessary hue while the top could be made from a much harder natural gemstone to resist abrasion. In a triplet, two pieces of genuine pale-colored aquamarine could be cemented together with a central layer of vividly colored resin. Such a stone not only would be as resistant to wear as natural solid beryl, but would also produce the same refractive index if subjected to this gemological test, although it would have to be a careless gemologist to avoid detecting the composite structure. A very large number of composite gems have appeared on the market from time to time and are described in detail in standard gemological treatises, Webster's¹³ (pp. 135–46) being one of the most useful.

SYNTHETIC GEMSTONES RESEMBLING BERYLS

Synthetic gemstones are exact re-creations of their natural counterparts, possessing essentially the same crystalline structure and exhibiting the same physical and chemical properties. The earliest commercial success in synthesis came with Auguste Verneuil's 1891 discovery of the flame-fusion process for creating corundum gems in various colors, the first attempts being made to produce synthetic ruby. In brief, the process calls for dropping aluminum oxide powder, suitably contaminated with a coloring agent, through the intensely hot flame of an oxygen-hydrogen blowpipe and collecting the molten droplets upon a clay pedestal, upon which they crystallize. Experimentation soon enlarged the gamut of colors, including excellent replicas of the colors of various beryls.

Somewhat later, an almost equally hard synthetic spinel was manufactured which also could be produced in a large variety of colors, some of which resembled natural beryls. Fortunately, both synthetic corundum and spinel are easily distinguished from beryl when gemologically tested.

The success of the Verneuil process naturally led to attempts to produce synthetic emeralds, but unlike the corundum which gratifyingly crystallized once its droplets had fallen onto the clay pedestal, beryl merely decomposed and the resulting glassy mixture was not this mineral at all. All attempts to create emerald by this means failed, and, as Verneuil¹⁴ himself noted in 1911, no proof was advanced to show that emeralds had been produced by the direct melting process. Despite later claims to the contrary, this statement holds good today.

On the other hand, other approaches to the synthesis of beryl succeeded, as will be described in subsequent sections of this chapter. First, a chronology of events is provided in the section below. Certain developments have been checked against the excellent historical summary of emerald synthesis by Nassau.¹⁵

CHRONOLOGY OF BERYL SYNTHESIS

1848—Jacques Joseph Ebelman (1814–1852), French chemist, produced small prismatic crystals of emerald by adding emerald powder to boric acid flux.¹⁶

1888—Paul Gabriel Hautefeuille (1836–1902) and Adolphe Jean Edmé Perrey,

CHEMICAL AND PHYSICAL PROPERTIES

- French chemists, grew prismatic emerald crystals in molten lithium molybdate or lithium vanadate, to which were added oxides of Be, Al, and Si.^{17,18,19}
- 1894—Hermann Traube (1860–1913), German mineralogist, grew small prisms of beryl by heating a gel approximating the composition of beryl with water.²⁰
- 1911 (?)—M. Jaeger and H. Espig of I. G. Farbenindustrie, Germany, began experiments on flux-fusion emeralds,¹⁵ (p. 198), but the results were not publicized until considerably later.^{21,22}
- 1912—Richard Nacken (1884–1912), German chemist, supposedly grew hydrothermal emerald crystals, but this is now refuted¹⁵ (p. 199); instead, they were grown in a flux-fusion bath over beryl nuclei.²³
- 1926—J. F. Riera obtained British Patent 271,316 (Oct. 4) for synthetic aquamarine produced in lithium carbonate, lithium hydroxide, boric acid, and sodium borate fluxes, to which were added oxides of Si, Be, Al, and cobalt nitrate for color.²⁴
- 1928—Nacken flux-fusion emerald described as hydrothermal by Van Praagh.²⁵
- 1930—Carroll F. Chatham (1914–), California chemist, made colorless flux-fusion(?) beryl crystals.²⁶
- 1934—Emerald crystals, under the trade name "Igmerald," were sold in small quantities from Espig's production in Germany²⁷; they were described by Schiebold,²⁸ Jaeger and Espig,²⁹ Eppler,³⁰ Anderson,³¹ and Foshag.³²
- 1935—A. Amstutz and A. Borloz³³ grew minute emerald crystals in BeF flux, to which were added SiO₂, Al₂O₃, and a trace of Cr.
- 1935—C. S. Hitchen repeated Hautefeuille and Perrey process to produce emerald crystals in lithium molybdate flux, adding 0.5% Cr₂O₃ for color.³⁴
- 1935—C. F. Chatham grew his first emerald crystal at California Institute of Technology, Pasadena, weight ca. 1 carat.²⁶
- 1938—C. F. Chatham wrote, "I produced a few flawless synthetic emeralds of excellent Muzo color as early as 1938, but of very tiny size;"³⁵ early crystals examined by Rogers and Sperisen,²⁶ Anderson and Payne,³⁶ and Gübelin and Shipley.³⁷
- 1949–1952—Chatham production stabilized at 50,000 carats/year (less than 10% gem quality)³⁸; 60,000 carats/year in 1951 (crystals averaged 40 carats each, 10% fine gem quality).³⁹ Chatham stated, "I might add that the largest cut stone, practically clear and of good color, so far produced was a little over 4 carats."³⁵
- 1950—Pierre Gilson, French ceramicist, began emerald synthesis studies¹⁵ (p. 490).
- 1953—Chatham delivered 1014-carat single synthetic emerald crystal to Smithsonian Institution, Washington, D.C., and another only slightly less in weight to the Mineralogical Museum, Harvard University. These crystals took two years to grow (various press releases).

Artificial and Synthetic Beryls

- 1957—J. Wyart and S. Šćavnicar grew minute beryl crystals hydrothermally.⁴⁰
- 1957—W. Van Valkenburg and E. Weir grew small hydrothermal emeralds.⁴¹
- 1960—Johann Lechleitner of Innsbruck, Austria, hydrothermally coated precut aquamarines with synthetic emerald, producing the "Emerita" or "Symerald" gems.^{42,43,44}
- 1960, 1962—M. Kunitomi and H. Saito obtain Japan Patents 60-13,908 and 62-16,567 for hydrothermal emerald synthesis methods¹⁵ (p. 200).
- 1961—W. F. Eppler, German mineralogist, produced small emerald crystals in lithium molybdate flux.⁴⁵
- 1961—Linde Division, Union Carbide Corp., commenced research on hydrothermal growth of emerald¹⁵ (p. 472).
- 1962—R. C. Linares, A. A. Ballman, and L. G. Van Uitert grew emerald crystals in various fluxes, primarily in vanadium pentoxide.⁴⁶
- 1962—R. A. Lefever, A. B. Chase, and L. E. Sobon grew small emerald crystals in various fluxes; best results in molybdenum oxide.⁴⁷
- 1963—A. L. Gentile, D. M. Cripe, and F. H. Andres announced growth of flame-fusion emerald boules from powder of Si, Be, Al, and Cr oxides.⁴⁸
- 1963—Walter Zerfass of Idar-Oberstein, Germany, produced hydrothermal emerald crystals,⁴⁹ but these are now recognized as flux-grown¹⁵ (p. 199).
- 1963—Pierre Gilson produced commercial quantities of flux-grown emerald crystals.^{15,50}
- 1964—C. M. Cobb, J. A. Adamski, and E. B. Wallis grew beryl and emerald crystals in vanadium pentoxide flux to which were added oxides of Si, Al, Be, and Cr.⁵¹
- 1964—Patents on hydrothermal synthesis methods for emerald applied for by staff members of Linde Division, Union Carbide Corp.¹⁵ (p. 472); described by Flanigen et al.,⁵² Pough,^{53,54} and Flanigen, et al.⁵⁵
- 1965—E. N. Emelyanova et al. grew hydrothermal beryl crystals in various hues by adding compounds of V, Mn, Co, and Ni to solutions.⁵⁶
- 1965—D. Ganguli and P. Saha grew beryl from melts of quartz, alumina, and beryllium oxide.⁵⁷
- 1965—W. Wilson and H. Hall, U. S. Naval Ordnance Laboratory, White Oaks, MD, claimed production of small beryl and emerald crystals from melts of beryl powder (or equivalent) under high pressure^{58,59}; perhaps glasses¹⁵ (p. 202).
- 1967—S. Motoo, et al. grew emerald in lithium oxide-molybdenum oxide flux¹⁵ (p. 200).
- 1968—C. Frondel and J. Ito hydrothermally synthesized bazzite.⁶⁰
- 1969—W. B. Wilson and H. B. Hall, granted U.S. Patent 3,473,935 for high-pressure melt synthesis of beryl.

CHEMICAL AND PHYSICAL PROPERTIES

- 1971—M. Kunitomi and Y. Arino obtain Japan Patents 71-25,499 and 71-25,500 for flux-fusion and hydrothermal syntheses of emeralds¹⁵ (p. 200).
- 1972—M. Ushio and Y. Sumiyoshi grew emeralds in vanadium pentoxide flux¹⁵ (p. 200).
- 1972—K. Kojima and Y. Arino obtain Japan Patent 72-27,639 for flux-fusion growth of emerald using vanadium pentoxide and lithium and molybdenum oxides¹⁵ (p. 200).
- 1972—D. Ganguli grew very small emerald crystals from a gel at high temperature¹⁵ (p. 200).
- 1973—C. Sakamoto obtained Japan patent 72-73,278 for flux-fusion emerald using alkali-molybdenum flux¹⁵ (p. 200).
- 1974—H. Takubo, S. Kume, and M. Koizumi synthesized emerald in gel at high pressure¹⁵ (p. 200).
- 1975—T. Matsuo and S. Marusato obtained Japan patent 75-39,697 for flux-fusion emerald in lithium oxide-molybdenum oxide flux¹⁵ (p. 200).

SIMPLE FUSION SYNTHESIS

Despite failures to synthesize beryl by melting beryl powder or melting equivalent ingredients such as silica, alumina, and beryllia, a recent attempt was made by Gentile et al.,⁴⁸ who claimed to have been successful. They reported growing two boules from a powder consisting of 16 gm BeO, 18 gm Al₂O₃, 67 gm SiO₂, and 0.5 gm Cr₂O₃. Both boules were found to be coated with an aluminum silicate compound, identified as mullite, which in itself showed that considerable alumina and silica had left the boule, thus destroying the calculated proportions needed to produce beryl. No crystal faces were found on the boules and no cleavages detected. The material was identified by x-ray diffraction and petrographic methods, the latter revealing biaxial figures in thin sections. Refractive indexes were $o = 1.561-1.562$, and $e = 1.566-1.567$.

Later attempts to repeat simple fusion synthesis met with failure and produced only glass-like mixtures. Apparently beryl refuses to recrystallize as beryl when melted at atmospheric pressures. Miller and Mercer⁶¹ produced beryl melts at atmospheric pressure and found that beryl decomposed in stages during melting. Sintering commenced at ca. 1300°C, small quantities of liquid were detected at 1460°C, and clear liquid developed only above 1600°C. Examinations at different stages showed that "phenakite, chrysoberyl, and BeO has transient existence," and that "after 6 hours at 1490°C BeO was the only crystalline phase," the last also disappearing when the melt became entirely fluid above 1600°C. Slow cooling of the melts reversed the sequence, commencing with formation of BeO, then BeO + chrysoberyl, next the appearance of phenakite + chrysoberyl, and lastly, below 1400°C, the appearance of mullite and low-cristobalite. Furthermore, "all attempts

Artificial and Synthetic Beryls

to crystallize beryl from a melt or a glass of its own composition have been unsuccessful." On the other hand, some beryl was found in certain devitrified glasses which differed in proportions from the ideal, and this was offered as a tentative explanation for the possible presence of beryl in the boules made by Gentile, et al.⁴⁸

Riebling and Duke⁶² attempted to make homogeneous beryl glass by melting the appropriate oxides in correct proportions, but they found only a two-phase liquid, the boundaries of which could be detected in electron photomicrographs. Munson⁶³ also melted beryl under pressures between 15 and 50 kilobars, but the solid consisted of phases of silica, phenakite, and chrysoberyl. However, a beryl glass was claimed to have been produced when the melt was taken over 2000°C and then quenched at a pressure of somewhat over 45.5 kb. Quenching at lower temperature resulted in appearance of crystalline silica with minor amounts of phenakite and chrysoberyl. At lower pressures and temperatures, some partial recrystallization of beryl took place in the melt.

In a similar process, Wilson⁵⁸ claimed synthesis of emerald in a high-pressure press using stoichiometric proportions of the necessary oxides plus some Cr₂O₃, all encapsulated in a platinum cylinder. Heat was obtained by passing a current through a carbon sleeve surrounding the capsule. Clear masses of material were obtained at 10 kb and above and at about 1800°C. According to Wilson, "x-rays indicate that the crystals are single crystals," and "the density . . . was determined to be 2.715 ± 0.005." On the basis of these results, U.S. Patent 3,473,935 was granted to W. B. Wilson and H. B. Hall on 21 October 1969.

In view of the conflicting results obtained by several investigators working essentially with the same materials and under similar conditions of temperature and pressure, serious doubt exists that beryl can be synthesized by direct fusion or that even a homogeneous beryl glass can be made. Nassau¹⁵ (p. 202), examined a sample of Wilson's material and found it to be isotropic, a property consistent with a glass but not crystalline beryl, and further noted that "the grinding used to prepare the specimen for his x-ray diffraction may well have permitted recrystallization and so given him the appearance of crystallinity."

FLUX-FUSION SYNTHESIS

Basically, flux-fusion synthesis involves providing a suitable melt to which are added ingredients capable of recombining to form beryl. In theory it is simple, but in practice the method is beset by difficulties.

The earliest flux-fusion experiments by Ebelman¹⁶ used molten boric acid as the flux, to which he added the necessary beryl-forming components, plus chromium oxide for color. Hautefeuille and Perrey^{17,18,19} used molten lithium molybdate, keeping the flux at ca. 800°C for two weeks. Aside from crystals of a lithium compound,

CHEMICAL AND PHYSICAL PROPERTIES

they found numerous small prisms of beryl displaying faces of $c\{0001\}$ and a hexagonal prism. Addition of an oxide of chromium imparted a typical emerald color. In other experiments they added iron oxide to obtain greenish-yellow crystals. Later researches settled on a ratio of five quantities of lithium vanadate flux to one quantity of beryl equivalent, keeping the flux molten for eighty days.

Hautefeuille and Perrey observed that the beryl components did not dissolve in the flux but rather combined with the flux to form a complex phase which could be seen in the cooled melt as soft, hexagonal rods. The beryl slowly nucleated and grew at the expense of these complexes between 650°C and 800°C, beyond which temperature phenakite formed instead of beryl. They found it necessary to raise the melt to 650°C for 24 to 48 hours to form the complex phase and a small number of beryl nuclei, after which the temperature was slowly raised to 800°C to accelerate growth.

Traube's synthesis²⁰ employed a melt of boric acid in a platinum crucible to which were added sodium silicate and sulfates of beryllium and aluminum. The melt was sustained at 1700°C for three days.

The first flux-fusion process which promised a supply of commercial emeralds was that conducted by Jaeger and Espig in the laboratories of the I. G. Farbenindustrie at Bitterfeld, Germany, during 1924 to 1942. The name "Igemerald" was adopted to reflect the igneous origin of the emeralds. Details of the process were first revealed by Wilke²¹ in 1956 and amplified by Espig²² himself in 1960. The essentials are as follows. A platinum vessel containing molten lithium molybdate flux is supplied with beryllia (BeO) and alumina (Al₂O₃), which, being heavier than the flux, sink to the bottom. Pieces of silica in the form of quartz (SiO₂) are floated on the top of the melt and slowly diffuse silica into the flux. Simultaneously, the beryllia and alumina also dissolve and react with the flux itself to form complex oxides which, through diffusion and convection, pass to the top of the melt where they meet and interact with the silica. So long as the three additives interact, emerald crystals form. The choice of lithium molybdate flux was governed by the fact that beryl is less soluble in it than the oxides used for its synthesis. Thus beryl tends to grow while the oxides slowly dissolve to provide the necessary nourishment within a weak but constantly saturated environment.

In previous experimentation it was found that if the ingredients were allowed to distribute themselves uniformly throughout the flux, serious oversaturation occurred with the result that a myriad of very small crystals formed instead of the desired few large ones. Oversaturation was prevented by physically separating the components, that is, keeping the beryllium and aluminum oxides at the bottom of the vessel and the quartz at the top. While this scheme worked well, it resulted in emerald crystals nucleating on the quartz, whereupon they developed numerous inclusions and tended to fracture when removed.

Artificial and Synthetic Beryls

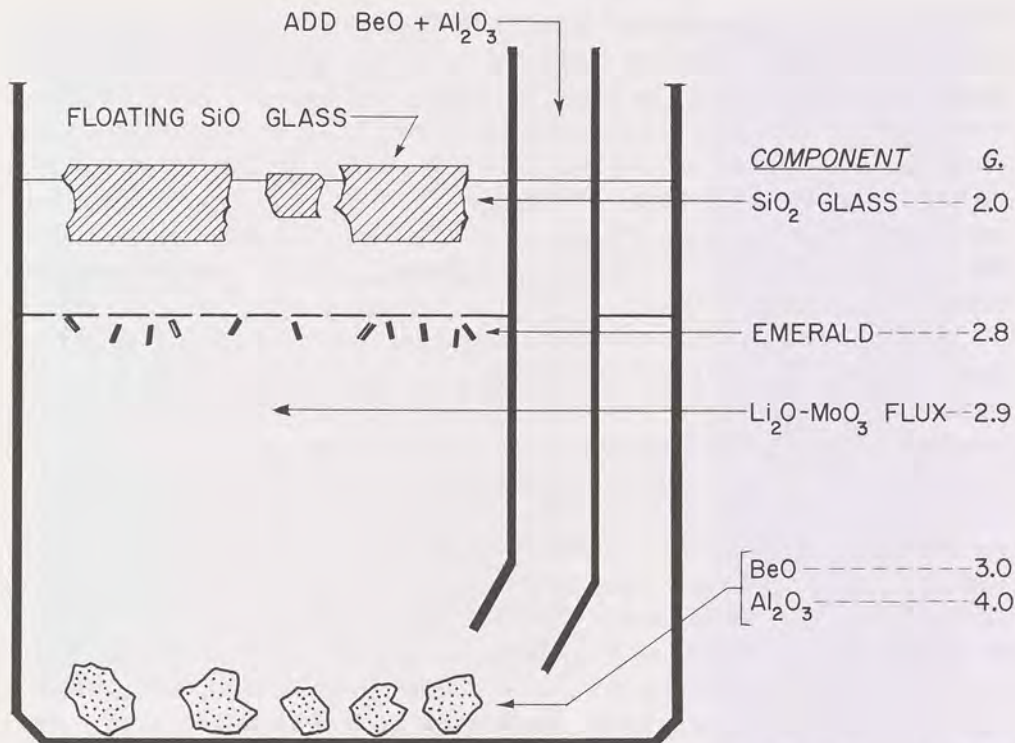

Fig. 11-1 Schematic drawing of the apparatus used by Espig at I. G. Farben to grow emeralds using a flux of lithium and molybdenum oxides. Based on a drawing in K. Nassau, Synthetic emerald: the confusing history and the current technologies, *Journal of Crystal Growth* 35 (1976):211-222.

To insure isolated growth of the crystals, it was found advantageous to place a platinum screen across the vessel such that it depressed the beryl seeds below the surface and provided a place against which they could float, as shown in figure 11-1. A vertical platinum tube was inserted in the bath to permit addition of Be and Al oxides as needed, but all of the quartz required for a run was supplied at the beginning. After two to four weeks, the crystals were taken out and defective places sawed off, after which they were reintroduced in the bath for further growth. Crystals of substantial size required a process time of several months, while crystals about 2 cm ($\frac{3}{4}$ in) long required over a year.

Espig²² also remarked that the crystals were sharp and glassy if the melt contained enough oxides, but if these were deficient the crystals began to dissolve with formation of pyramidal faces, rounded edges, and development of etch marks. On the other hand, if allowed to grow too fast, acicular crystals formed upon the basal planes. Growth began in the range 640–750°C, with the optimum rate achieved at

CHEMICAL AND PHYSICAL PROPERTIES

770–800°C. New nuclei appeared between 800°C and 850°C, and at 900°C emerald ceased to form, the existing crystals began to dissolve, and other non-beryl phases appeared instead. As noted by Espig, all of the procedures demanded the closest attention to detail in order to achieve successful results. In the final stages of mass-production, a growth period of twenty days was settled upon with the melt held at $800 \pm 10^\circ\text{C}$. The oxides were replenished every two days, with the result that the seeds increased in weight by 20% after each run. When prismatic seeds were used, the growth rate improved. Eventually twelve furnaces were in operation to produce crystals up to 1 cm ($\frac{3}{8}$ in) long.

The properties of the new synthetic were described by Schiebold,²⁸ Jaeger and Espig,²⁹ Eppler,³⁰ Anderson,³¹ and Foshag,³² reflecting both the interest and the concern that the appearance of these crystals aroused in the gem world. The crystals were generally simple in habit with the first order hexagonal prism $m\{10\bar{1}0\}$ predominating and slightly modified by the second order prism $a\{11\bar{2}0\}$. The crystals terminated with large faces of the pinacoid $c\{0001\}$. Occasionally very small pyramidal faces developed. The color was excellent green with distinct yellow-green and blue-green dichroism. Refractive indexes were $o = 1.559$, $e = 1.566$, birefringence -0.007 ; specific gravity was 2.651.²⁹ Slightly different values were found by Eppler³⁰ as $o = 1.5644$, $e = 1.5606$, -0.0038 , S. G. = 2.662; Anderson³¹ found unusually strong dichroism and $o = 1.5660$, $e = 1.5647$, -0.0013 , the last figure considered to be "abnormally low," and S. G. = 2.66; Foshag³² determined a strong dichroism, $o = 1.563-6$, $e = 1.560$, and S. G. = 2.65.

The possibility that these emeralds might be confused with natural gems led to close examination of differences that could be used in their discrimination. For example, Anderson³¹ gave the following features: (a) abnormally low birefringence, specific gravity, and refractive indexes, (b) presence of strong absorption bands in the visible spectrum at 6060 Å and 5940 Å, (c) characteristic internal features such as banding and curved, crack-like markings, (d) anomalous double refraction, and (e) unusually strong dichroism. The strong absorption bands are in addition to those expected at 6828, 6795, 6740, 6620, 6460, and 6295 Å.

Eppler³⁰ particularly drew attention to the inclusions, pointing out the absence of the usual micas, cavities, fluids, and "coaly" inclusions so often seen in natural emeralds. He also noted the irregular webs and veils of inclusions, some forming networks reminiscent of the cracks in aged oil paintings, that were features of the Igmerald. These inclusions appeared to contain liquid with gas bubbles. In this regard, Foshag³² noted elongated rod-like cavities alighted in rows or "combs," reticulated networks of veil-type inclusions, and a turbidity due to "dirt." He also discovered minute crystals which he could not identify but which were later described by Eppler³⁰ as phenakite.

Nacken emerald crystals, long claimed to be hydrothermal, are now shown to

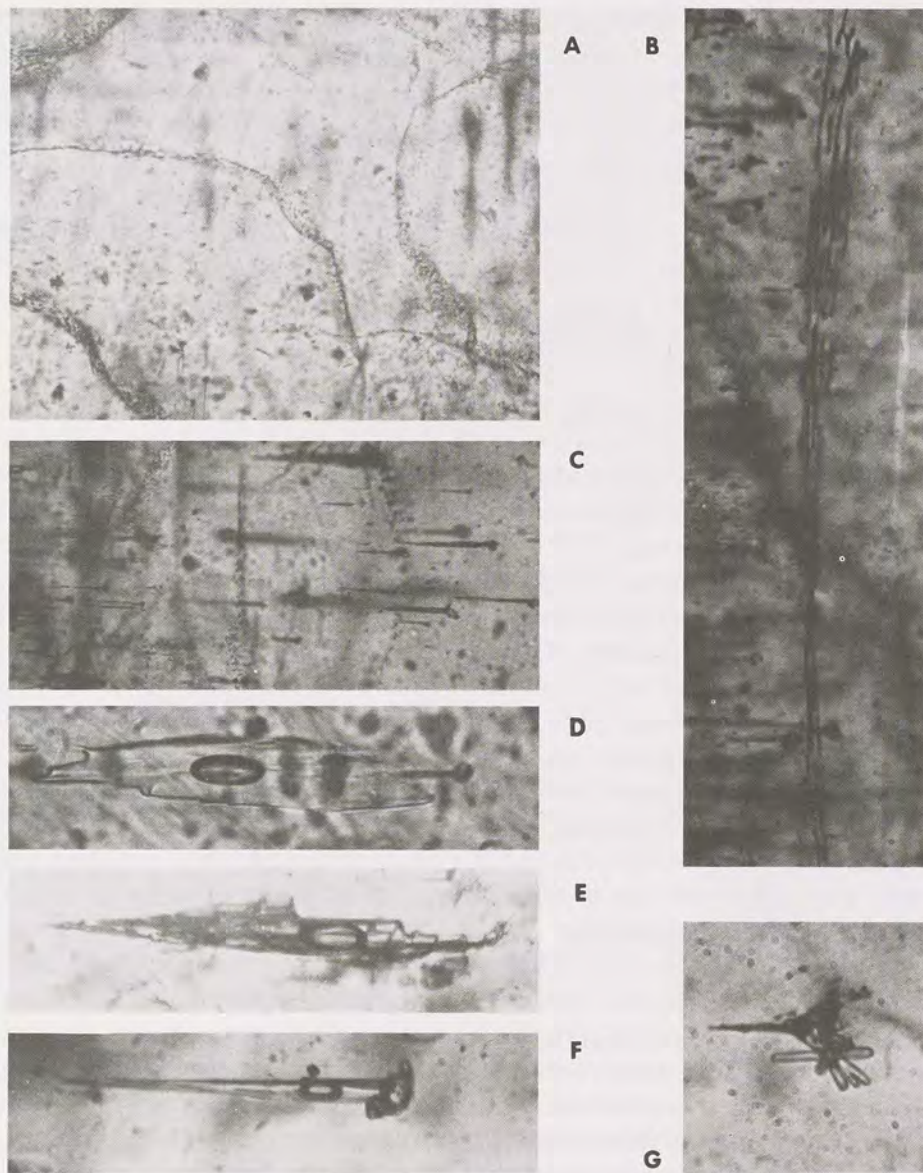

Fig. 11-2 Inclusions in Nacken synthetic emeralds as observed by Dr. Kurt Nassau: A and B: Wispy or veil-like inclusions, some in long sheets. C: "Nailhead" inclusions, growing from a solid included crystal (see also F). D and E: Two-phase inclusions resembling the gas-liquid inclusions of hydrothermal emeralds but in this case consisting of solids. F: Like E and D but commencing at a solid inclusion. G: Cluster of small prismatic crystals, probably phenakite. *Courtesy Dr. Kurt Nassau, Gems Made by Man* (Radnor, Pa.: Chilton, 1980), Fig. 11-7.

CHEMICAL AND PHYSICAL PROPERTIES

be flux-grown.^{15,23} Hydrothermal growth was erroneously ascribed due to misreading of reports of Nacken researches made in the post-World War II period. Nassau¹⁵ obtained authentic Nacken crystals from the British Museum (Natural History), where they had been sent for preservation, and found them to be "colorless natural beryl fragments, showing typical inclusions, covered with a layer of flux-grown emerald." Furthermore, "flux-grown Nacken emeralds have been examined by many investigators . . . but no one appears to have actually seen any hydrothermal Nacken emeralds." Thus it seems that Nacken, in order to avoid the difficulties in obtaining synthetic seed emerald crystals in a melt, took the simple step of using readily available natural beryl for this purpose.

Chatham Emeralds

The next attempt at flux-fusion synthesis of emerald, which has proved to be a commercial success, was conducted by Carroll F. Chatham of San Francisco, after much preliminary experimentation. He began synthesis experiments while still in high school and as early as 1930 grew his first synthetic beryl.²⁶ The first synthetic emerald crystal was grown in 1935. By 1938 he had solved the most important problems associated with his process and began marketing his production through Francis J. Sperisen, a lapidary of San Francisco who advertised Chatham single crystals for sale at \$1.00 each for those up to 1/2 carat and small cut gems of about 2 mm (1/16 in) or somewhat larger at \$2.50 per stone and up. By 1948 crystals of fine Muzo color were grown large enough and sufficiently free from flaws and inclusions to cut into gems of over 1 carat. By 1952, one faceted gem of a little more than 4 carats was recorded.³⁵

Sometime after 1946 Chatham built a production facility and increased output to reach a steady annual rate of 60,000 carats of all grades of saleable crystals, a production level maintained today.^{64,65} In 1950, Chatham contracted to deliver all his production to Crystals S.A., a Swiss firm, managed by Dan E. Mayers, but not excluding F. J. Sperisen who had marketed his earliest production. In 1960, the Chatham Research Laboratories of San Francisco sold its production to Anglomex, Inc. of New York City, who in turn sold crystals to concerns operated by Ipekajian, Inc., and its wholly owned subsidiary Cultured Gem Stones, Inc., of New York.⁶⁶ In 1970, Chatham established his own marketing company under the name of Chatham Created Gems, Inc. and "kept his production capacity constant for the last ten years so as not to saturate the market"¹⁵ (p. 488).

Chatham noted that about twelve months are required to grow the crystals.⁶⁵ These are produced in various sizes, the largest commonly being about 30 mm (1 1/4 in) in diameter, although much larger individuals can be grown upon demand as evidenced by the two crystals exceeding 1,000 carats, mentioned in the chronology above. Much of the production of small-crystal druses is sold to retail establishments

Artificial and Synthetic Beryls



Fig. 11-3 Carroll Chatham (seated) with his sons Tom (left) and John (right) in the laboratory of his synthetic emerald plant in San Francisco. *Courtesy Dr. Kurt Nassau.*

throughout the world and, when attractively formed they are set "as is" in rings, pendants, and other items of jewelry. The larger single crystals from which faceted gems are cut are sold in lots of 1,000 carats minimum but never to private parties. The recent practice of the company is to send rough to Idar-Oberstein, Germany, for cutting and return of the gems to San Francisco for marketing. The gems range in size from several millimeters or smaller, or *melée*, to those of several carats or more weight, the maximum size ordinarily not exceeding 11 carats. In 1979 the crystal druses sold for \$15.00/carat and the cut gems for about \$300/carat and up.

CHEMICAL AND PHYSICAL PROPERTIES

Crystal forms and properties of Chatham emeralds were described by Rogers and Sperisen,²⁶ who noted that the crystals are primarily bounded by faces of the first and second order prisms $m\{10\bar{1}0\}$, and $a\{11\bar{2}0\}$, combined with the pinacoid $c\{0001\}$. Seldom, and then only on very small crystals, do small faces of hexagonal bipyramids occur. All faces are bright, which adds much to the appearance of crystal clusters. The color is rich emerald-green, but some zoning is noted when crystals are cut through. The usual dichroic colors (yellow-green and blue-green) are apparent. Refractive indexes are $o = 1.578$, $e = 1.573$, birefringence 0.005. However, considerably different values were found in later studies. For example, Gübelin and Shipley³⁷ and Flanigen et al.⁵⁵ found $o = 1.562$ – 1.564 , $e = 1.559$ – 1.561 , -0.003 , while Switzer⁶⁷ determined $o = 1.562$, $e = 1.559$. The values now generally agreed upon are the latter. Specific gravity is given as 2.667,²⁶ 2.497–2.702,⁵⁵ and 2.65.⁴⁹

Chemical analysis of early specimens indicated the presence of iron, calcium, magnesium, potassium, and sodium; when expressed as oxides, the total came to 0.14%.²⁶ A spectral analysis also showed lines for chromium, magnesium, titanium, calcium, and sodium. Gübelin and Shipley³⁷ found absorption bands at 6295, 6460, 6620, 6740, 6795, and 6828 Å, and two more at 5940 and 6060 Å. The entire spectrum was more intense than that noted in natural emeralds. Double refraction and patchy extinction under crossed polaroids were also noted, as well as weak dichroism. Switzer⁶⁷ found deep red fluorescence under 3600 Å and 3500 Å ultraviolet. Wood and Nassau⁶⁸ examined specimens in infrared spectroscopy but could find no lines for water, despite the water content claimed in the analysis of Rogers and Sperisen,²⁶ and they concluded that the Chatham emerald was grown in an anhydrous flux. Sunagawa^{69,70} studied surface microstructures on Chatham synthetic emeralds and found some differences among them.

Inclusions also received their share of attention. Rogers and Sperisen²⁶ reported clusters of unidentified dark red, equant isotropic crystals as well as curved sheets, wisps, and veils of liquid-gas inclusions. Wispy inclusions were reported by Gübelin and Shipley.³⁷ Swarms of solid particles, wispy and feathery inclusions, systems of almost parallel rod-like inclusions, and crystals of low relief and sharp hexagonal outlines suggesting beryl were noted by Switzer.⁶⁷ Eppler⁷¹ examined both "Igemerald" and Chatham emeralds and found phenakite in both, mostly as groups of rounded crystals but sometimes as single stubby to elongated hexagonal prisms.

Eppler Emeralds

W. F. Eppler of Germany grew emerald crystals up to 2 mm ($\frac{1}{16}$ in) in lithium molybdate flux during runs of from fourteen to seventy days. He also produced phenakite crystals which he believed to be characteristic inclusions in flux-fusion emeralds.⁴⁵ He found that the growth rate was rapid at first and the oxide compo-

Artificial and Synthetic Beryls

nents were quickly used up, with the result that in seven to ten days the crystals had attained a size of ca. 250 microns. The growth rate dropped dramatically thereafter, and in order to grow crystals to 0.5–2 mm long it was necessary to maintain the melt for a month or more.

In another experiment, Eppler used crushed beryl as a feed in lieu of oxides. It dissolved completely after three days but resulted in the formation of a multitude of hexagonal platelets of tridymite. However, when the melt was sustained, small crystals of emerald began to grow after several weeks time. In general, his emerald crystals grew to the proportion of 2.64 length and 1.00 for diameter. Zoning appeared to be correlated to additions of feed material, suggesting that greatest uniformity would be achieved by continuous addition of small amounts of feed material.

Linares et al. Emeralds

The flux-fusion process developed by Linares, Ballman, and Van Uiter^{46,72} is essentially the same as that employed by Espig. A considerable number of fluxes were tried, among them lithium molybdate, lithium tungstate, lead molybdate, lead tungstate, and vanadium pentoxide, the last being considered the most promising. When lead molybdate and tungstate fluxes were used, beryl could be grown at temperatures up to 1200°C, but when using the vanadium pentoxide flux, the most convenient temperature was near 1050°C. However, in his later report, Linares⁷² had settled upon a flux of lead oxide plus vanadium oxide in various ratios, using oxide powders or clear natural beryl crystals as feed material with chromium oxide added for color. Ingredients were melted in a platinum crucible at 1100–1250°C for 4 hours and then slowly cooled to allow crystallization of emerald, which occurred upon spontaneously formed nuclei. A "typical run" contained 50 gm of beryl components and 200 gm of flux, cooled from 1250°C to 900°C at the rate of 1°C/hour. This furnished crystals of 5 cubic mm. A temperature gradient method of growing the crystals was also described.

Linares found ultraviolet and visible light spectra to be essentially the same as in natural emeralds, but infrared measurements showed lack of water absorption bands. No red fluorescence due to chromium was observed in UV and "it is believed that there is considerable incorporation of vanadium into the emerald which then interacts with the chromium to quench its fluorescence." Linares noted "large areas of flux inclusions" which, in the case of vanadium-based fluxes, were reddish to yellowish in color and "occur as interconnected sheets."

Lefever et al. Emeralds

Small crystals were grown by the flux-fusion method by Lefever, Chase, and Sobon,⁴⁷ who obtained best results by using a flux of approximately 1.2 gm BeO,

CHEMICAL AND PHYSICAL PROPERTIES

3.2 gm Al_2O_3 , 10.6 gm Li_2SiO_3 , 0.4 gm Cr_2O_3 , and 75.0 gm of MoO_3 . As can be seen, the required silica was provided from the lithium silicate compound. Without seeding, numerous emerald crystals formed spontaneously but averaged only about 1 mm long, but with seeds, deposits of 0.8 mm on basal faces and 0.4 mm on prism faces were obtainable in two days. The principal secondary product was chrysoberyl (BeAl_2O_4). Its appearance was accelerated when melts were heated in excess of 975°C and it formed at the expense of emerald.

Zerfass Emeralds

According to Nassau¹⁵ (p. 199), the Zerfass emeralds, once thought to be hydrothermal,⁶⁸ have now been shown to be flux-fusion products. They were produced for a brief period in Idar-Oberstein by one of Espig's co-workers who worked for Zerfass after Espig's departure from the I. G. Farbenindustrie. Both Nassau and Flanigen, et al.⁵⁵ concur that the I. G. Farbenindustrie process was the one being used. Properties were described by Gübelin,⁴⁹ but because of the extremely limited production, all are now decided rarities and the practicing gemologist is unlikely to encounter any specimens. Refractive indexes are $o = 1.562$, $e = 1.558$, birefringence 0.003–0.004, specific gravity = 2.66. In long- and shortwave UV a red glow appears. Zoned growth lines were noted and phenakite was identified as an inclusion.

Gilson Emeralds

Outstanding success in producing flux-fusion emerald crystals rewarded the efforts of Pierre Gilson, French ceramist, to develop a commercially viable enterprise. These are now made in the plant of Établissements Pierre Gilson in Campagne-lez-Wardrecques near St. Omer in the Pas-de-Calais of France. The first commercial output was placed on the market in 1963.⁵⁰ Continuing refinements in the process resulted in a better product and increased quantities of cut gems and small-crystal groups. In 1977 a recent visitor to the plant quoted Gilson as saying that he then commanded 95% of the world market in synthetic emeralds.⁷³

Although details of the process have not been revealed, several qualified observers have recorded their impressions and speculations on how it works.^{73,74} The highly mechanized cutting of the stones has also been described.⁵³ By 1971, Gilson had adopted the use of two types of seed plates, the first being slices of natural beryl sawn parallel to the c -axis and at right angles to faces of the first order prism $m\{10\bar{1}0\}$, with the plates about $55 \times 30 \times 2$ mm ($2\frac{3}{16} \times 1\frac{1}{4} \times \frac{1}{16}$ in) in size. These are fastened to racks with thin wires, as shown in figures 11-6 and 11-7, and then immersed in the flux. In about one year's time, each plate grows to about $60 \times 40 \times 15$ mm ($2\frac{3}{8} \times 1\frac{5}{8} \times \frac{5}{8}$ in), or, assuming a specific gravity of 2.70, to a weight of about 500 carats.⁵¹ As emerald is accumulated, each plate assumes the

Artificial and Synthetic Beryls



Fig. 11-4 Dr. Pierre Gilson in his laboratory in France. Courtesy Dr. Kurt Nassau.

cross-section of an irregular octagon bounded by two broad faces of the second order prism $a\{11\bar{2}0\}$ and smaller faces of $m\{10\bar{1}0\}$. This orientation of seed plate was chosen because of the faster growth rate that occurs on faces of $a\{11\bar{2}0\}$, which are relatively rare in natural crystals because they have been grown out of existence. Each immersion rack is fitted with five seed plates which are laterally spaced so that when growth is stopped the crystals almost touch each other⁷⁵ (cover photo). According to Diehl,⁷³ about 100 crystals were being produced each year, but not all were completely satisfactory, and the discards were returned to the flux baths as feed material.

In the second type of seed, cut across the c -axis as shown in figure 11-7, the orientation exploits the rapid growth of beryl in the c -axis direction, as is typically the case in natural emerald crystals. Each crystal grows to about 4 cm ($1\frac{5}{8}$ in) in diameter and about 20 mm ($1\frac{3}{16}$ in) thick.

The flux, which Gilson calls his "lava," is probably a lithium molybdate,

CHEMICAL AND PHYSICAL PROPERTIES

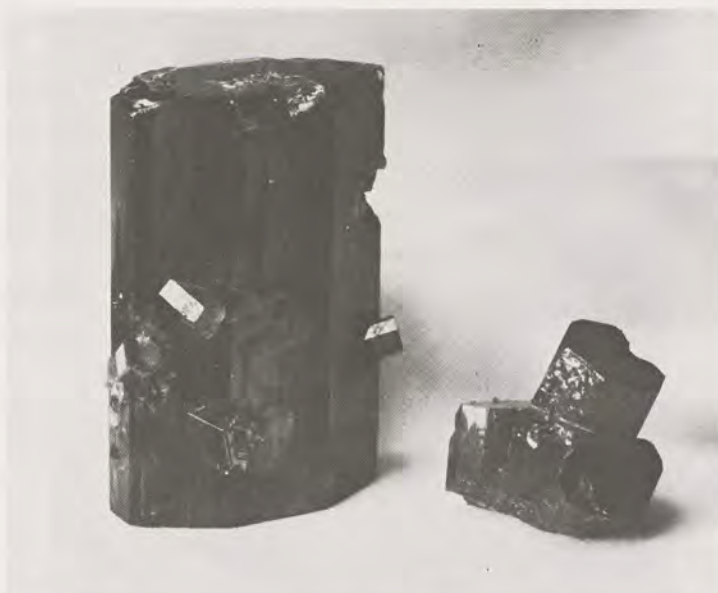

Fig. 11-5 Gilson emerald single crystal and cluster after ten months' growth. The large crystal measures about 63 mm (2½ in) tall and 37 × 12.5 mm (1½ × ½ in) in cross-section; several spontaneously seeded crystals are attached. The cluster crystals show development of second order prisms. *Courtesy Labratoire Gilson.*

either LiMoO_4 or $\text{Li}_2\text{Mo}_2\text{O}_7$, which has been identified as inclusion material in the emeralds.⁷³ Each tank, as well as the racks and suspending wires previously mentioned, is probably fabricated from platinum or some alloy of platinum group metals. The tank charge is 23 kg of flux. Diehl⁷³ was of the opinion that the process uses feed beryl directly and does not depend on indirect formation of beryl through additions of beryllia, silica, and alumina as do other flux-melt methods. Diehl supposed the tanks to be heated in such a way that slightly higher temperatures were maintained at the top of the molten flux to insure dissolution of added beryl and slightly lower temperatures maintained where crystallization took place. He also stated that the temperature in the growing region was increased by 30°C for a short period every 24 hours to dissolve away any small crystals which may have spontaneously formed on the plates. The small crystals dissolved rapidly but the large plates suffered very little loss.

More recent information on the tanks suggests that they are essentially like that shown in figure 11-7, that is, diffusion of nutrient is *lateral* instead of vertical as one would otherwise expect. When asked if the scheme shown in the drawing was a fair representation of the actual tank, the Gilson laboratory replied affirma-

Artificial and Synthetic Beryls

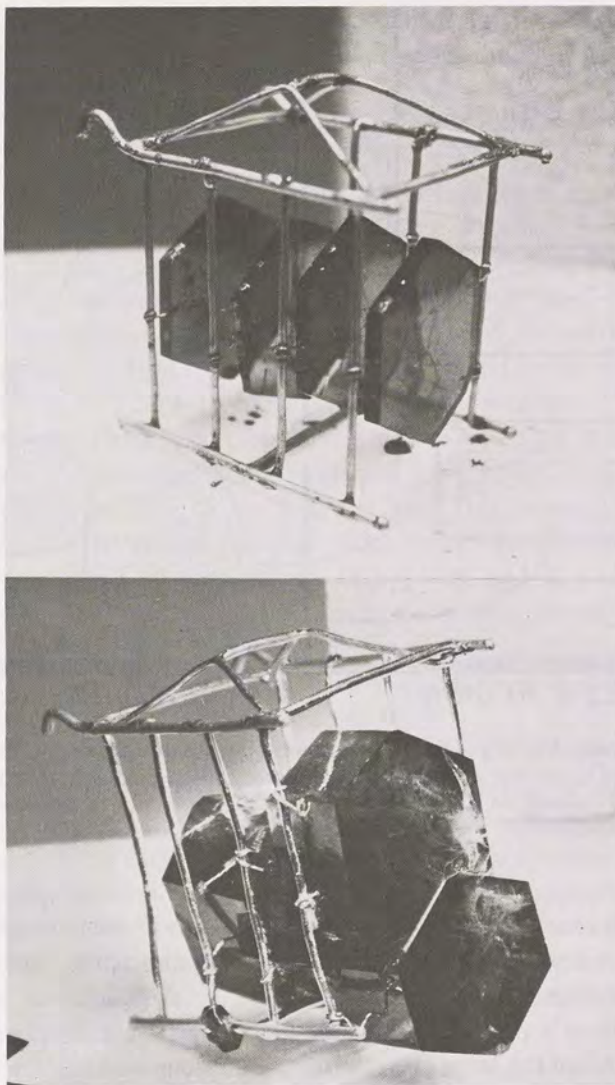

Fig. 11-6 Gilson synthetic emerald crystals. Top: Basal section seed plates after two months' growth. Bottom: After ten months' growth. *Courtesy Labratoire Gilson.*

tively. By 1977, according to Diehl, control of growth was so refined that the latest crystals shown to him were "completely eye-clear" of inclusions and in samples examined under a microscope at $200\times$, they were "absolutely inclusion-free."

Gilson also produces small clusters of glistening emerald crystals of about five

CHEMICAL AND PHYSICAL PROPERTIES

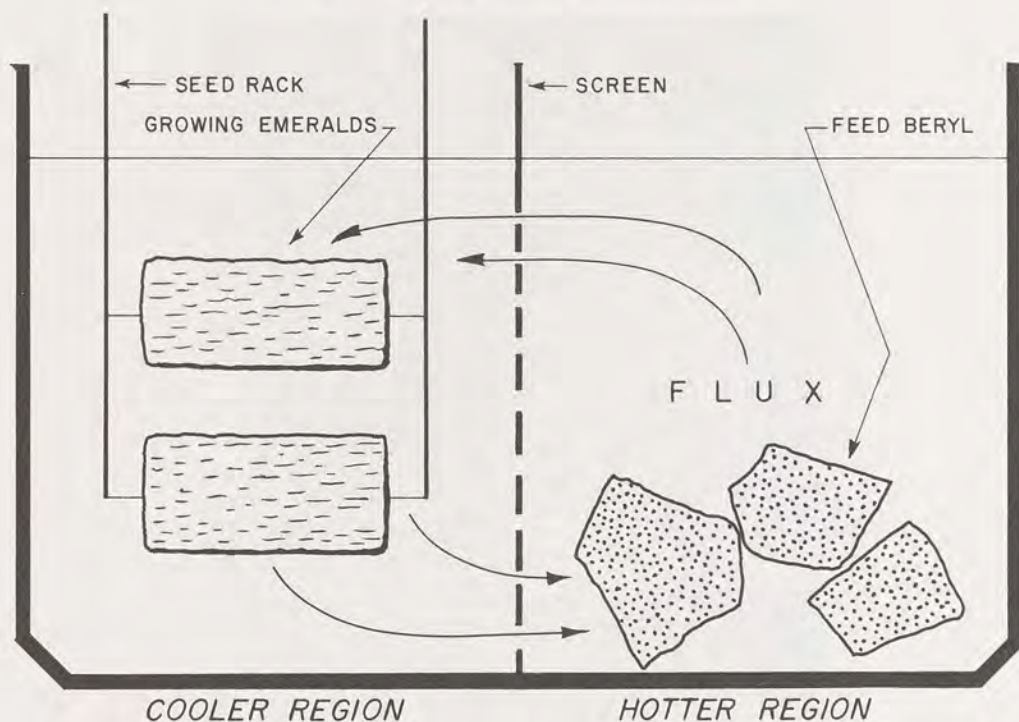

Fig. 11-7 Schematic drawing of the apparatus used by Gilson to grow emeralds in flux. Feed beryl is dissolved in the flux and is transported to the seeds which enlarge at the rate of about 1 mm per month. Based on a drawing in K. Nassau, *Synthetics in the Seventies*, *Lapidary Journal* 34 (1980):58.

to ten individuals, each from 4 to 8 mm ($\frac{3}{16}$ to $\frac{1}{4}$ in) in diameter, but these appear to be spontaneous crystallizations upon tips of platinum wires. They are, however, seldom clear and take about six months to grow.⁷³

None of Gilson's production of emerald is sold, save for the crystal clusters just mentioned. All of the large crystals are cut in-plant via a remarkable assemblage of automatic lapidary devices. For example, mass-faceting machines using diamond-impregnated metal laps and drums greatly speed the production of standard shapes, including such styles as round and oval brilliants and marquises. Five standard sizes of cut gems are offered in round brilliants, oval brilliants, marquises, and the usual step-cut as shown in figure 11-8. The gems are classified into three quality grades according to color, freedom from flaws, and size. A company brochure issued in about 1968 advised that "Gilson Created Emeralds are obtainable weighing up to ten carats each" and that prices vary "between 80 and 300 Dollars

Artificial and Synthetic Beryls

per carat, depending on quality, weight, size and life [brilliance?] of each stone.” However, it is apparent from Diehl’s comments that much larger and very clean gems can now be supplied.

The property data, as supplied by the company itself, are refractive index, 1.558–1.575; birefringence, 0.003–0.005; dispersion, 0.14; specific gravity 2.65–2.70. A red color is observed under the Chelsea filter. Early Gilson stones were tested by Webster,⁵⁰ who found $o = 1.562$, $e = 1.559$, -0.003 , S. G. = 2.65, and a dull red glow under the Chelsea filter. Under longwave UV he noted a mustard-yellow glow, and under shortwave, an orange hue. Flanigen et al.⁵⁵ examined two color-types, described as yellow-green and blue-green, and gave for the first $o = 1.564$, $e = 1.561$, -0.003 , S. G. = 2.65; for the second they gave $o = 1.562$ – 1.564 , $e = 1.559$ – 1.561 , -0.003 , S. G. = 2.65.

Fryer⁷⁶ examined older specimens and a newer type that lacked fluorescence under longwave UV. An older stone furnished $o = 1.569$, $e = 1.564 \pm 0.001$, birefringence -0.005 , and S. G. = 2.65 ± 0.001 . This stone glowed orange-red under longwave UV. In contrast, another older stone, fluorescing red, gave $o = 1.567$ – 1.568 , $e = 1.562$, birefringence 0.005–0.006, and S. G. = 2.65 ± 0.01 . Distinct from these were results obtained on newer stones, namely, $o = 1.579$, $e = 1.571$, -0.008 , S. G. = 2.68–2.69. These particular stones lacked fluorescence under UV, possibly due to the presence of iron, and they were found to be opaque to x-rays, which also suggests the presence of iron.

Inclusions in early Gilson emeralds are typical for the process. They take such forms as numerous veils and wisps of minute bubble-like or elongated bubble cavities, many containing flux, and numerous minute euhedrons of phenakite.⁵⁵ Using Bragg-reflex x-ray studies, Diehl⁷³ investigated thin sections cut parallel to the pinacoidal plane from slice-grown crystals and found numerous growth striae resulting from inner strains, possibly caused by the periodic interruptions to growth or to slight changes in chemical composition when growth tanks were recharged. His photographs showed differences between these emeralds and a natural beryl slice of the same crystallographic orientation.

Numerous other flux-fusion attempts to grow emeralds are mentioned in the chronological table earlier in this chapter, but none resulted in commercial production.

HYDROTHERMAL SYNTHESIS

Hydrothermal methods of synthesis depend on the fact that many minerals can be dissolved in appreciable quantities in hot water under high pressure. Fundamentally, the apparatus consists of a pressure vessel in which nutrient is supplied along with water and the whole sealed and then heated. Slight differences in temperature

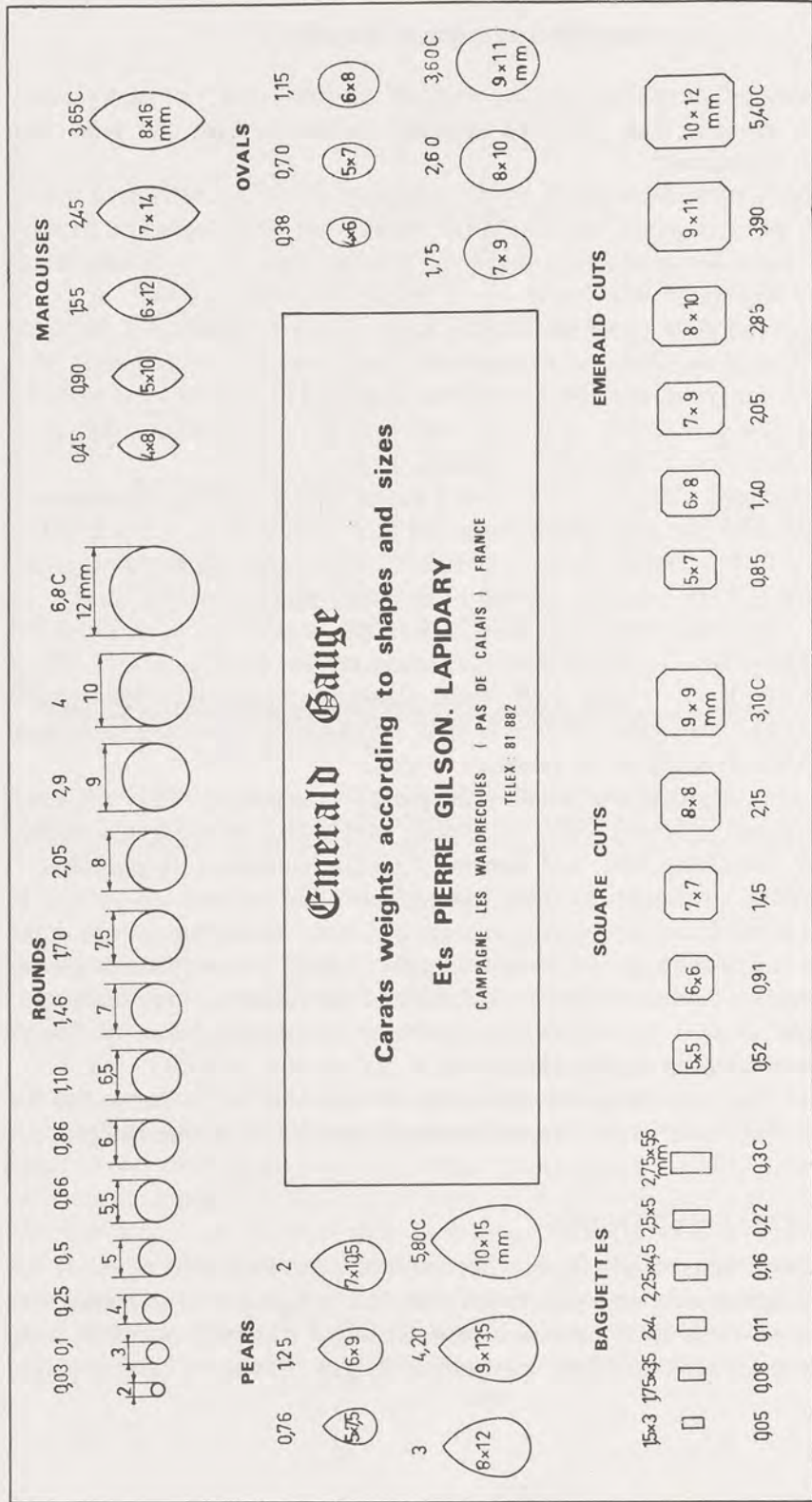
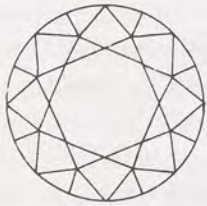

Fig. 11-8 Cutting styles employed for synthetic emeralds produced by Pierre Gilson, showing the various sizes and weights of finished gems. Courtesy Etabl. Pierre Gilson, Campagne Les Wardreques, France.

Fig. 11-8 (continued)

STEP CUTS



ABOVE : 32 facets

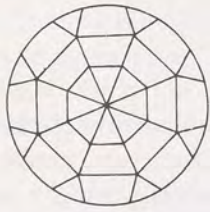

UNDER : 32 facets



FACE

MARQUISES

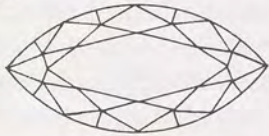

ABOVE : 32 facets



UNDER : 34 facets

PEARS



ABOVE : 32 facets

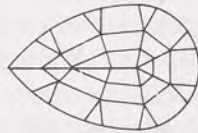

UNDER : 33 facets

OVALS

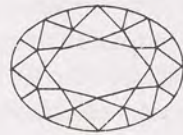

ABOVE : 32 facets

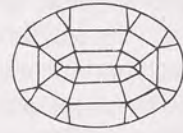

UNDER : 32 facets

BAGUETTES

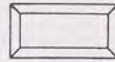

ABOVE : 5 facets

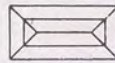

UNDER : 8 facets

SQUARE CUTS

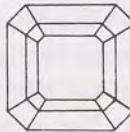

ABOVE : 16 facets

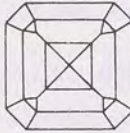

UNDER : 20 facets

EMERALD CUTS

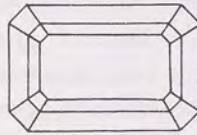

ABOVE : 16 facets

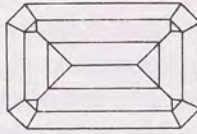

UNDER : 20 facets

CHEMICAL AND PHYSICAL PROPERTIES

are maintained at opposite ends of the growth chamber, the hotter end dissolving the nutrient and the cooler end causing seeds to take on additional growth. Typical apparatus and procedures are discussed by Ballman and Laudise in Gilman.⁷⁷

Richard Nacken, best known for his hydrothermal synthesis of quartz, was credited for hydrothermal growth of emerald, but, as previously mentioned, it now seems that these were actually grown in the flux-fusion process. In 1957, Wyart and Šćavnicar⁴⁰ produced numerous very small beryl crystals by introducing appropriate amounts of silica, alumina, and beryllium carbonate with water into a stainless steel pressure vessel and raising the temperature to between 400°C and 600°C, developing pressures between 400 and 1500 bars during "runs" of from 4 to 10 hours. At 400°C a fine white beryl powder was synthesized, while at 600°C colorless transparent hexagonal prisms were made, these being bounded by faces of $m\{10\bar{1}0\}$ and $c\{0001\}$. At higher temperatures, some phenakite and chrysoberyl formed. A faint green tinge was imparted to the beryl crystals by addition of a chromium compound, but the position of the Cr ion in the beryl structure could not be determined. In the same year, Van Valkenburg and Weir⁴¹ also synthesized beryl crystals using a similar method.

Lechleitner Emerald-Coated Beryl

In 1960, a sensation was created in the gem world when Johann Lechleitner, working in Innsbruck, Austria, succeeded in hydrothermally depositing emerald on faceted seeds of beryl which needed only to be polished to finish them.⁴² Such stones were given the name "Emerita." No details of his work have been published, although Gübelin⁴³ mentioned that a weak alkaline solution, containing dissolved nutrients of silica, alumina, and beryllium oxide, was used as the fill for the pressure vessel. The vessel was heated to between 300°C and 400°C to obtain an internal pressure of 1,000 bars. In early stones, the emerald layer was not over 0.5 mm thick and was found to have grown in crystallographic continuity with the underlying beryl. Some of the crystal forms taken by the emerald were of considerable complexity and beauty.⁴³ Later experimentation produced "sandwich" type stones consisting of beryl-emerald slices further overgrown by emerald to intensify color, and even fully synthetic emeralds.^{43,55,79,80}

On the whole, the coated stones were satisfactory in terms of color, although careless polishing could remove much of the thin emerald layer. Holmes and Crowningshield⁴² determined refractive indexes of $o = 1.581$, $e = 1.575$, birefringence 0.006; Gübelin⁴⁴ found $o = 1.578-1.590$, $e = 1.571-1.583$, -0.007 . On a specimen dated to 1962, Flanigen et al.⁵⁵ found $o = 1.582-1.586$, $e = 1.577-1.580$, $-0.005-0.006$; but another darker colored specimen dated to 1964 gave $o = 1.586-1.597$, $e = 1.580-1.587$, $-0.006-0.010$; a "fully synthetic" specimen of 1962 vintage gave $o = 1.577$, $e = 1.571-1.572$, $-0.005-0.006$; and a "fully

Artificial and Synthetic Beryls

synthetic beryl-emerald composite'' dated to 1964 gave $o = 1.567$ – 1.573 , $e = 1.562$ – 1.567 , -0.005 – 0.006 . Values found by Eppler⁷⁹ for the emerald overgrowth were $o = 1.581$, $e = 1.575$, and -0.006 ; for the "sandwich" type they were $o = 1.570$, $e = 1.566$, and -0.004 ; while for the full synthetic type the values were $o = 1.574$, $e = 1.569$, and -0.005 .

A more recent study giving considerably different values appeared in Bank.⁸⁰ He examined seven stones and found $o = 1.583$ – 1.605 , $e = 1.577$ – 1.599 , and birefringence -0.005 – 0.009 . Surprisingly, Bank also found one coated "beryl" that was actually emerald grown over a core of topaz.⁸¹ Specific gravities recorded for the Lechleitner stones are 2.649–2.707, the less dense containing numerous core inclusions;⁴² 2.676–2.713;⁴³ and 2.676–2.713.⁴⁴ Other values are 2.67–2.69 for a full synthetic and the same for a full synthetic beryl-emerald composite,⁵⁵ 2.695 for an emerald overgrowth,⁸⁰ and 2.678 for a sandwich stone⁷⁹ (see also new property determinations by Schmetzer, et al.⁸⁴).

Holmes and Crowningshield⁴² found the absorption spectrum of early Lechleitner stones to be about the same as that observed in other emeralds, but it lacked two lines in the blue because of the thinness of the coating. Reddish fluorescence was apparent under longwave UV but was less intense than that of Chatham synthetic. Gübelin⁴³ sent a blue aquamarine and a golden beryl of rich yellow color to Lechleitner for overcoating and afterwards found not the slightest difference in the emerald hues as compared to colorless overcoated beryls. Absorptions in the visible spectrum were distinct and strong according to Gübelin,⁴⁴ typical bands occurring at 6835, 6806, 6620, and 6370 Å. Red fluorescence was noted under longwave UV, but was less strong than noted in other synthetic emeralds. Eppler⁷⁹ found that the coated stones glowed greenish under both 2540 Å and 3650 Å UV, but the full synthetic glowed only a weak dark red under the same wavelengths.

Lechleitner stones are readily identified because of the coatings and sandwich construction, which encourage the formation of minute cracks and inclusions of euclase and phenakite along the junctions. Also characteristic are core inclusions typical of natural aquamarine. According to Gübelin,⁴³ Lechleitner had succeeded in introducing gold in his hydrothermal solution and caused deposition of minute octahedral crystals of this metal along with the emerald layers.

Linde Hydrothermal Synthesis

In 1961, E. M. Flanigen and others began research on hydrothermal synthetic emerald at the Tonawanda Research Laboratory, Linde Division, Union Carbide Corp. Although excellent emeralds were produced, the process eventually proved to be too costly to sustain itself commercially. Compared to flux-fusion emeralds, which can now be grown without interruption, the use of pressurized vessels in hydrothermal synthesis requires frequent and costly shut-downs to cool the vessels,

CHEMICAL AND PHYSICAL PROPERTIES

open them, extract the contents, add new nutrients, reseal, etc. Other economical factors influencing the decision to abandon the operation were discussed by Nassau¹⁵ (pp. 472, 488).

The best description of the Linde process is given by Nassau.¹⁵ Essentially, the pressure vessel was filled to 62% capacity with water that has been mineralized by addition of alkali halides or ammonium halides to form a neutral to alkalic environment to which could be added coloring compounds of iron, nickel, or neodymium. However, for growing emeralds, an acidic fill was required because "acidic conditions were essential to prevent the chromium from precipitating." The seed wafers were cut into slices of several millimeters thickness from natural aquamarine beryl crystals and suspended from small platinum wire loops within a stout wire frame, the latter assembly then being lowered into the vessel in vertical position. To prevent nucleation elsewhere and to confine new growth to the wafers, it was necessary to separate the nutrients by placing the crushed quartz at the top of the growing chamber and the alumina (gibbsite) and beryllium hydroxide at the bottom. Chromium was supplied by addition of hydrous chromium chloride ($\text{CrCl}_2 \cdot 6\text{H}_2\text{O}$). Linde emeralds were grown containing 0.2–1.2% Cr but "for gem purposes 0.2–0.4% Cr seems to result in the most aesthetically pleasing color"⁵⁵ (p. 747).

The growth vessel was lined with chemically nonreactive gold. When the contents were in place, it was carefully sealed and heated to 500–600°C, upon which the water expanded to fill the chamber completely and created internal pressures of 10,000 to 20,000 psi. Heat was supplied in such a manner that the bottom temperature was about 10° to 25°C higher than the top, thus assuring a convection current which allowed the dissolved nutrients to circulate over the seed wafers. These grew as much as 0.33 mm/day, later improved by use of a stronger acid medium to 0.8 mm/day.

After growth was established on aquamarine seed plates, these were removed and sawn through their central planes to eliminate the aquamarine and to provide two synthetic emerald plates for further growth. Up to three runs were required to obtain crystals thick enough for gems, "usually a 6 mm thickness was produced on a 12 × 12 mm seed plate."

The Linde emeralds were marketed from 1965 to 1975, although actual production ceased in 1970 due to an accumulating stock of unsold products. The company marketed cut emeralds in a "Quintessa" line of jewelry, "a procedure which was somewhat at odds with established jewelry trade practices," and which perhaps caused sales to be less than that needed to keep the enterprise alive.

It is a pity that no attempt was made to sell the emerald crystal plates themselves because they are fascinating objects in their own right, being squarish to rectangular wafers, up to 6 cm ($2\frac{3}{8}$ in) long and about 15 mm ($\frac{3}{16}$ in) wide,

Artificial and Synthetic Beryls

covered with glittering narrow facets and growth hillocks (figure 11-9). They are richly colored and transparent. By viewing on edge, one can clearly see the narrow central core of aquamarine. Nassau¹⁵ (p. 468) records one such wafer of $50 \times 22 \times 6$ mm ($2 \times \frac{7}{8} \times \frac{1}{4}$ in) which weighed 61.5 carats. According to Pough,^{53,54} the seed plates were cut parallel to a pyramidal face to take advantage of the faster growth rate possible in that direction.

According to Flanigen et al.^{52,55} the properties are as follows: refractive indexes, $o = 1.571-1.578$, $e = 1.566-1.572$; birefringence, 0.005-0.006; specific gravity = 2.67-2.69 for a Cr content of 0.3-1.2%. Eppler⁸² found $o = 1.569$, $e = 1.563$, -0.006 , and S.G. = 2.67, comparing this data to B. W. Anderson's previous findings of $o = 1.574$, $e = 1.568$, -0.006 , and S.G. = 2.69. Galia⁸³ recently tested twelve Linde gems and found $o = 1.569-1.576$, $e = 1.563-1.570$, birefringence $-0.003-0.006$, and S.G. (three stones) = 2.67 ± 0.01 .

In color, the Linde emeralds resemble the blue-green of Urals or Chivor crystals rather than the yellow-green of Muzo stones. The blue-green, yellow-green dichroism is distinct. A bright red fluorescence appears under 3650 Å and 2537 Å UV, and bright red under the Chelsea filter for stones containing 0.7% Cr.^{53,54,55} Galia⁸³ observed red fluorescence under UV, comparable to that noted in Chatham emerald, somewhat stronger fluorescence under longwave, and also an intense red

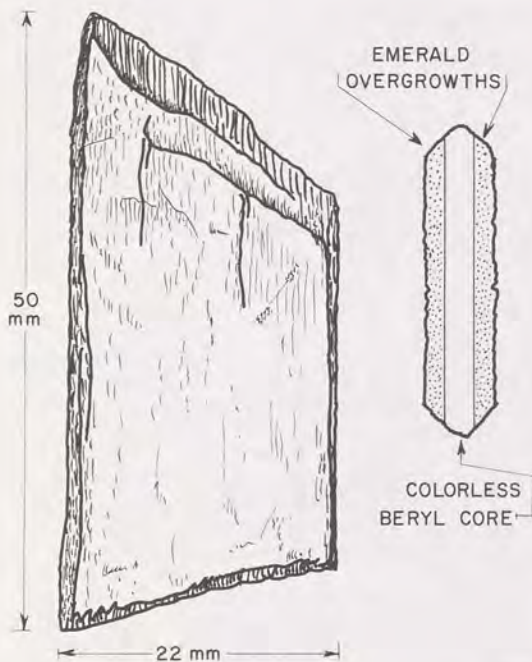

Fig. 11-9 Linde hydrothermal emerald. Left: Sketch of a tabular crystal removed from the autoclave. Right: Cross-section, showing emerald overgrowth upon a thin seed section of colorless beryl. After a photograph by Kurt Nassau, from *Synthetic emerald: the confusing history and the current technology*, *Lapidary Journal* 30 (1976):468.

Table 11-1
PROPERTIES OF SYNTHETIC EMERALDS

Name	Type	Refractive Index		Birefringence	Specific Gravity	Chelsea Filter	Shortwave UV	Longwave UV
		n_o (ω)	n_e (ϵ)					
Chatham	Flux	1.578	1.573	0.005	2.65	Bright dull-red	Bright red	Deep red
		1.562-1.564	1.559-1.561	0.003	2.65	Glowing red	Dull blueish red	Strong red
		1.563	1.560	0.003	—	—	—	—
		1.562	1.559	0.003	—	—	—	—
Gilson	Flux	1.562	1.558	0.003-0.004	2.65	Glowing red	Weak olive	Olive
		1.564	1.561	0.003	2.65	—	Yellow-olive	Yellow-orange-olive
"Igmerald"	Flux	1.562	1.559	0.003	2.65	Dull red	Orange	Mustard
		1.569±0.001	1.564±0.001	0.005	2.65±0.01	—	—	Orange-red
		1.567-1.568	1.562	0.005-0.006	2.65±0.01	—	—	Red
		1.579	1.571	0.008	2.68-2.69	—	—	None
		1.563-1.566	1.560	0.003-0.006	2.65	—	—	—
		1.559	1.566	0.007	2.651	—	—	—
Lechleitner	Hydrothermal	1.5644	1.5606	0.0038	2.662	—	—	—
		1.5660	1.5647	0.0013	2.66	—	—	—
		1.562	1.559	0.003	2.65	Glowing red	Strong brick-red	Strong red
		1.581	1.575	0.006	2.649-2.707	—	—	Reddish
		1.578-1.590	1.571-1.583	0.007	2.676-2.713	—	—	Red
		1.582-1.586	1.577-1.580	0.005-0.006	—	—	—	—
		1.586-1.597	1.580-1.587	0.006-0.010	—	—	—	—
		1.577	1.571-1.572	0.005-0.006	2.67-2.69	Red	Pale red	Pale red
		1.567-1.573	1.562-1.567	0.005-0.006	2.67-2.69	Red	None	None
		1.581	1.575	0.006	2.695	Bright red	Bright red	Bright red
Linare	Flux	1.570	1.566	0.004	2.678	—	—	—
		1.574	1.569	0.005	—	—	—	Weak red
Linde	Flux	1.583-1.605	1.577-1.599	0.005-0.009	—	—	—	—
		—	—	—	—	—	—	None
Zerfass	Flux	1.564	1.561	0.003	2.66	Dull red or none	Dull red or none	Dull red or none
		1.564-1.572	1.561-1.563	0.003-0.005	—	—	—	—
		1.564-1.570	1.561-1.564	0.003-0.006	—	—	—	—
		1.571-1.578	1.566-1.572	0.005-0.006	2.67-2.69	Bright red	Bright red	Bright red
Zerfass	Flux	1.571-1.578	1.566-1.572	0.005-0.006	2.67-2.69	Bright red	Bright red	Bright red
		1.569	1.563	0.006	2.67	—	—	—
		1.574	1.568	0.006	2.69	Intense red	Red	Stronger red
Zerfass	Flux	1.569-1.576	1.563-1.570	0.003-0.006	—	—	—	—
		1.562	1.558	0.003-0.004	2.66	Bright red	Red	Red

Artificial and Synthetic Beryls

under the Chelsea filter. Inclusions are characteristically minute liquid-gas cavity types forming elongated swarms resembling brush strokes, and irregular two-phase inclusions and spike-like cavities tapering from small phenakite crystals, the latter sometimes appearing as long-prismatic, colorless, transparent crystals.^{54,55,83}

Emelyanova et al. Syntheses

By 1965 Emelyanova and co-workers⁵⁶ had completed numerous experiments on hydrothermal synthesis of single beryl crystals containing vanadium, manganese, cobalt, and nickel. These were grown in water solutions containing boric acid (H_3BO_3) and sodium borate ($Na_2B_4O_7$), retained under pressure in vessels of 90–190 cubic cm capacity at temperatures of 400–600°C and pressures of 200–2,000 atmospheres. Spontaneously seeded crystals of 1.0–1.5 mm were obtained, while use of natural beryl seed plates cut either across or parallel to the *c*-axis resulted in accumulation of beryl from 1.0–1.5 mm thickness. Introduction of vanadium produced green, manganese provided only a grayish-green, and nickel imparted pale green to the crystals. In contrast, cobalt resulted in pinkish-brown crystals.

Bazzite Synthesis

Frondel and Ito⁶⁰ grew the scandian analogue of beryl, $Be_3Sc_2Si_6O_{18}$, and other phases in which iron, chromium, vanadium, manganese, and gadolinium were present in addition to scandium. All crystals were microscopic in size, and it was possible only in a few instances to obtain refractive index values, namely, a mean index of 1.59 for synthetic bazzite, while a synthetic corresponding to $Be_3(Sc_{1.5}Cr_{0.5})Si_6O_{18}$ gave values of $o = 1.606$, $e = 1.586$, birefringence 0.020, and $Be_3(ScCr)Si_6O_{18}$ gave $o = 1.610$, $e = 1.592$, -0.018 .

PROPERTIES OF SYNTHETIC EMERALDS

Table 11-1, compiled from the data appearing in this chapter, summarizes the properties of synthetic emeralds.

Literature Cited

1. Lucas, A. 1934. *Ancient Egyptian Materials and Industries*. 2nd ed. London: Edward Arnold & Co. 447 pp.
2. Beckmann, J. 1846. *A History of Inventions*. 2 vols. London: Henry G. Bohn.
3. Ball, S. H. 1950. *A Roman Book on Precious Stones*. Los Angeles: Gemological Institute of America. 338 pp.
4. Feldhaus, F. M. 1954. Imitation emerald problems in the 16th century. *The Gemmologist* (London) 23:174–6.
5. Leonardus Camillus. 1750. *The Mirror of Stones*. London: Printed for J. Freeman. 240 pp.
6. Ashbee, C. R. 1898. *The Treatises of Benvenuto Cellini on Goldsmithing and Sculpture*. London: Edward Arnold. 164 pp.
7. Bostock, J., and Riley, H. T. 1857. *The Natural History of Pliny*. vol. 6. London: Henry G. Bohn. 414–5.
8. Lagercrantz, O. 1913. *Papyrus Graecus Holmiensis*. Uppsala: A.-B. Akademiska Bokhandeln. 247 pp.

CTA

CHEMICAL AND PHYSICAL PROPERTIES

9. Tagore, S. M. 1879. *Mani-Málá, or a Treatise on Gems*. 2 vols. Calcutta: Stanhope Press.
10. King, C. W. 1867. *The Natural History of Gems or Decorative Stones*. London: Bell & Daldy. 377 pp.
11. Neri, A. 1662. *The Art of Glass*. London: Printed by A. W. for Octavian Pulleyn. 362 pp.
12. Barbot, C. 1858. *Traité Complet de Pierres Précieuses*. Paris: Lacroix et Baudry. 567 pp.
13. Webster, R. 1978. *Practical Gemmology*. 6th ed. New York: Arco Publishing. 209 pp.
14. Verneuil, A. 1911. Reconstructed synthetic emeralds and pearls. *The Keystone* (New York), May 1911, p. 855.
15. Nassau, K. 1976. Synthetic emerald: the confusing history and the current technology. *Lapidary Journal* 30:196, 468, 488.
16. Ebelman, J. J. 1848. Sur une nouvelle méthode pour obtenir des combinaisons cristallisées par la voie sèche, etc. *Annales de Chimie et de Physique* 22:213-44.
17. Hautefeuille, P., and Perrey, A. 1888. Sur la reproduction de la phenacite et de l'émeraude. *Compte Rendu de l'Academie des Sciences* (Paris) 106:1800-2.
18. ———. 1890. Sur la cristallisation de l'alumine et de la glucine. *Bulletin de la Société Française de Minéralogie et de Cristallographie* 13:147-9.
19. ———. 1893. Ueber Berylliumsilicate. *Zeitschrift für Kristallographie und Mineralogie* (Leipzig) 21:306.
20. Traube, H. 1894. Ueber die künstliche Darstellung des Berylls. *Neues Jahrbuch für Mineralogie* (Stuttgart) Beilage-Bd. 1:275-6.
21. Wilke, K. T. 1956. Die Entwicklung der Kristallzüchtung seit 1945. *Fortschritte der Mineralogie* (Stuttgart) 34:85-150.
22. Espig, H. 1960. Die Synthese des Smaragds. *Chem. Technik*, 12:327-31.
23. Nassau, K. 1978. Did Professor Nacken ever grow hydrothermal emerald? *The Journal of Gemmology* (London) 16, no. 1, pp. 36-49.
24. Riera, J. F. 1926. Synthetic aquamarines. British Patent 271,316, London, October 4, 1926.
25. Van Praagh, G. 1946. Synthetic emeralds. *Chemical Products* 10:10-11.
26. Rogers, A. F., and Sperisen, F. J. 1942. American synthetic emerald. *American Mineralogist* 27:762-8.
27. Espig, H. 1935. Der synthetische Smaragd. *Zeitschrift für Kristallographie und Mineralogie* (Leipzig) 92:387-91.
28. Schiebold, E. 1935. Vergleichende Untersuchungen an natürlichen und synthetischen Smaragdkristallen. *Zeitschrift für Kristallographie und Mineralogie* (Leipzig) Abt. A, vol. 92, pp. 435-73.
29. Jaeger, M., and Espig, H. 1935. Der synthetische Smaragd. *Deutsche Goldschmiede-Zeitung* 38:347-9.
30. Eppler, W. F. 1935. Der synthetische Smaragd. *Deutsche Goldschmiede-Zeitung* 38:144-6.
31. Anderson, B. W. 1935. Igemerald—the German synthetic emerald. *The Gemmologist* (London) 4:295-300.
32. Foshag, W. F. 1938. The synthetic emerald. *Jewelers Circular-Keystone* 104:73.
33. Amstutz, A., and Borloz, A. 1935. Note préliminaire sur la synthèse de l'émeraude. *Compte Rendu des Scéances de la Société de Physique et d'Histoire Naturelle de Genève* 52:39-41.
34. Hitchen, C. S. 1935. Synthetic emeralds. *Mining Magazine* (London) 53:219-20.
35. Alexander, A. E. 1952. Four carat synthetic emerald. *The Gemmologist* (London) 21:176.
36. Anderson, B. W., and Payne, C. J. 1938. Identification of synthetic emerald. *The Gemmologist* (London) 7:407-10.
37. Gübelin, E. J., and Shipley, R. M. 1941. The synthetic emerald. *Gems & Gemology* 3:146-50.
38. Foshag, W. F. et al. 1950. Gem stones. Chapter in *U. S. Bureau of Mines Minerals Yearbook for 1949*. 10 pp.
39. ———. 1951. Gem stones. Chapter in *U. S. Bureau of Mines Minerals Yearbook for 1950*. 9 pp.
40. Wyart, J., and Šćavnicar, S. 1957. Synthèse hydrothermale du béryl. *Bulletin de la Société Française de Minéralogie et de Cristallographie* 80:395-6.
41. Van Walkenburgh, W., and Weir, E. 1957. Beryl studies $3\text{BeO} \cdot \text{Al}_2\text{O}_3 \cdot 6\text{SiO}_2$. *Bulletin of the Geological Society of America* 68:1808.
42. Holmes, R. J., and Crowningshield, C. R. 1960. A new emerald substitute. *Gems & Gemology* 10:11-12.
43. Gübelin, E. J. 1960. More light on beryls and rubies with synthetic overgrowth. *Gems & Gemology* 10:105-13.
44. ———. 1961. Hydrothermal rubies and emerald-coated beryl. *Journal of Gemmology* (London) 8:49-63.
45. Eppler, W. F. 1961. Synthetic emerald. *Journal of Gemmology* (London) 8:88-95.
46. Linares, R. C.; Ballman, A. A.; and Van Uitert, L. G. 1962. Growth of beryl single crystals for microwave applications. *Journal of Applied Physics* 33:3209-10.
47. Lefever, R. A.; Chase, A. B.; and Sobon, L. E. 1962. Synthetic emerald. *American Mineralogist* 47:1450-3.
48. Gentile, A. L.; Cripe, D. M.; and Andres, F. H. 1963. Flame fusion synthesis of emerald. *American Mineralogist* 48:940-4.
49. Gübelin, E. J. 1964. Two new synthetic emeralds. *Gems & Gemology* 11:139-48.
50. Webster, R. 1964. The French synthetic emerald. *Journal of Gemmology* (London) 9:191-6.
51. Cobb, C. M.; Adamski, J. A.; and Wallis, E. B.

Artificial and Synthetic Beryls

1964. Investigation of growth of electromagnetic single crystals. *Final Report, American Science and Engineering, Inc., Contract A. F. 19(628)-3878, Project No. 5621, Task No. 562101*, December 26, 1964. 110 pp.
52. Flanigen, E. M., et al. 1965. New hydrothermal emerald. *Gems & Gemology* 11:259-64.
53. Pough, F. H. 1965. A new synthetic emerald. *Lapidary Journal* 19:664-9.
54. ———. 1965. A new hydrothermal synthetic emerald. *Journal of Gemmology* (London) 9:426-33.
55. Flanigen, E. M., et al. 1967. Characteristics of synthetic emeralds. *American Mineralogist* 52:744-72.
56. Emelyanova, E. N., et al. 1965. Artificial beryl containing V, Mn, Co, and Ni. *Soviet Physics-Crystallography*, (New York) 10, no. 1, pp. 46-49.
57. Ganguli, D., and Saha, P. 1965. Preliminary investigations in the high-silica region of the system $\text{BeO-Al}_2\text{O}_3\text{-SiO}_2$. *Transactions of the Indian Ceramic Society* 24:134-6.
58. Wilson, W. 1965. Synthesis of beryl under high pressure and temperature. *Journal of Applied Physics* 36:268-70.
59. Wilson, W., and Hall, H. 1965. Two-minute emeralds. *Lapidary Journal* 9:714-5.
60. Frondel, C., and Ito, J. 1968. Synthesis of the scandium analogue of beryl. *American Mineralogist* 53:943-53.
61. Miller, R. P., and Mercer, R. A. 1965. The high-temperature behaviour of beryl melts and glasses. *Mineralogical Magazine* (London) 35:250-76.
62. Riebling, E. F., and Duke, D. A. 1967. $\text{BeO-Al}_2\text{O}_3\text{-SiO}_2$ system: structural relationships of crystalline, glassy, and molten beryl. *Journal of Material Science* 2:33-9.
63. Munson, R. A. 1967. High-temperature behavior of beryl and beryl melts at high pressure. *Journal of the American Ceramic Society* 50:669-70.
64. Chatham, T. Personal communication, May 3, 1979.
65. Cahn, J. P. 1957. The man who grows emeralds. *True Magazine*, October, p. 58.
66. Agreement in "cultured" emeralds case. 1960. *The Gemmologist* (London) 29:116.
67. Switzer, G. 1946. Improvements in quality in synthetic emerald. *Gems & Gemology* 5:305-7.
68. Wood, D. L., and Nassau, K. 1967. Infrared spectra of foreign molecules in beryl. *Journal of Chemical Physics* 47:2220-8.
69. Sunagawa, I. 1964. A distinction between natural and synthetic emeralds. *American Mineralogist* 49:785-92.
70. ———. 1967. Surface microstructures of crystals grown from molten salts. *Journal of Crystal Growth* 1:102-9.
71. Eppler, W. F. 1958. Synthetischer Smaragd. *Deutsche Goldschmiede-Zeitung* 56:193-7, 249-51, 327-29, 381-85.
72. Linares, R. C. 1967. Growth of beryl from molten salt solutions. *American Mineralogist* 52:1554-9.
73. Diehl, R. 1977. Neues zum Thema "Synthetischer Smaragd": Besuch bei Pierre Gilson. *Zeitschrift der deutschen gemmologischen Gesellschaft*, 26, no. 2, pp. 61-75.
74. Pough, F. H. 1971. French synthetic emeralds. *Lapidary Journal* 24:1322-27.
75. Hervo, P. 1968. Automation and diamonds speed the cutting of cultured emeralds. *Industrial Diamond Review* (London) 28, no. 331, pp. 248-51.
76. Fryer, C. W. 1970. New non-fluorescent high-property synthetic emeralds. *Gems & Gemology* 8:106-11.
77. Gilman, J. J., Ed. 1963. *The Art and Science of Growing Crystals*. New York: John Wiley. 493 pp.
78. [deleted; see reference 43]
79. Eppler, W. F. 1968. Another Lechleitner-made synthetic emerald. *Journal of Gemmology* (London) 11:120-4.
80. Bank, H. 1976. Mit synthetischen Smaragd überzogene natürliche farblose Berylle. *Zeitschrift der deutschen gemmologischen Gesellschaft* 25, no. 2, pp. 107-8.
81. ———. 1976. Mit synthetischem Smaragd überzogener farbloser Topas von Lechleitner. *Zeitschrift der deutschen gemmologischen Gesellschaft* 25, no. 2, pp. 109-10.
82. Eppler, W. F. 1967. Der synthetische Smaragd von Linde. *Zeitschrift der deutschen Gesellschaft für Edelsteinkunde, Schlossmacher Festschrift* 61:58-66.
83. Galia, W. 1972. Diagnostische Merkmale synthetischer Smaragde von Linde. *Zeitschrift der deutschen gemmologischen Gesellschaft* 21, no. 2, pp. 112-7.
84. Schmetzer, K., Bank, H., and Stähle, V. 1981. The chromium content of Lechleitner synthetic emerald overgrowth. *Gems & Gemology* 17:98-100.

CHAPTER

12

CUTTING AND POLISHING BERYL

In its clear to translucent forms, beryl is peculiarly suited to the ministrations of the lapidary. Though not as hard as diamond, ruby, and sapphire, it is still sufficiently hard that gems cut from it withstand much abuse and retain their luster for decades. In respect to color, the rare and beautiful emerald has placed it among the few gemstones that are considered truly precious, while the lovely limpidity of aquamarines, golden beryls, and morganites permit the fashioning of faceted gems which need take second place to few others. Furthermore, beryl possesses no easy cleavage, nor undue sensitivity to the ravages of light, which may cause color changes, and otherwise presents no problems to the lapidary intent on shaping it into an object of beauty. In a word, it is hard, tough, and durable; it is a delight to the artisan and a delight to the beholder of the finished product.

HISTORICAL REVIEW

By at least 3,500 B.C. the Egyptians were already familiar with the processes for cutting and polishing stones of all kinds. According to Lucas¹ (pp. 63-73), they had developed an impressive array of tools for stone working, ranging from those used for shaping great architectural masses to the delicate drills for boring beads. They had learned how to employ metal blades fed with grit to saw through the hardest of stones, and they also knew how to engrave fine lines on gemstones, such as those seen upon scarabs and other engraved gems. Whether the Egyptians learned these arts from some other civilization or developed them largely within the confines of their own country is not known and perhaps never will be. In any event, much the same techniques eventually developed or spread throughout the civilized world.

Cutting and Polishing Beryl

By the first century A.D., the arts of the lapidary were well established. Egyptian, Roman, Greek, Near-Eastern, and other cultures employed engraved gems, cabochon gems, small carvings, and other objects made from a large variety of stones and gemstones, including the emerald and other beryls. From the Middle Ages into the Renaissance, the *cabochon* style of cutting prevailed, that is, most gems meant for ornament were shaped into approximately hemispherical forms, the flattened base being set into the mounting and the curved part bulging above.

At some time during the Middle Ages it was discovered that transparent gemstones could be cut with flat surfaces or *facets* in lieu of the curved surface of the standard cabochon. Gems of this sort can still be seen ornamenting various religious and ceremonial objects, cups, caskets, and even book covers manufactured during this period. Eventually some unsung lapidary conceived the idea of cutting transparent gems with a series of facets upon the bottom of the stone as well as the top, those below acting like mirrors to reflect light back up through the stone to achieve the effect of *brilliance*.

Upon the invention of the self-reflecting facet cut, it became obvious that the best effects could be achieved in gemstones of perfect clarity, among which are the aquamarine and other beryls, which yield crystals of large size and gratifying freedom from flaws. Emeralds were also faceted, despite the fact that numerous flaws and inclusions impeded and scattered light. Nevertheless, if such imperfections were not too abundant, a beautiful glow of color could be achieved by employing the facet cut for this gemstone.

Because no metal available to the ancients was capable of making the slightest impression on hard gemstones, including beryls, these stones had to be abraded in an indirect fashion. For example, the Egyptians used copper and iron lapidary tools, supplied with a powdered abrasive much harder than beryl. The soft metals merely dragged the abrasives along and allowed the much harder particles to do the actual cutting. Indeed it is obvious from the evidence supplied by Lucas that this method was used almost exclusively for sawing, drilling, and shaping. For soft stones, such as alabaster and marble, ordinary sand sufficed, but for beryl it was discovered that a rock known as emery, supplied from the Greek island of Naxos and from several places in Asia Minor, was effective. Much later this rock was analyzed and found to contain large amounts of corundum, a mineral much harder than beryl, thus explaining its effectiveness. Emery was well known to Theophrastus² (p. 115) as early as 346 B.C., and he referred to it as the abrasive *par excellence* for engraving gems.

Powdered diamond, a vastly harder abrasive, may have also been in use but there is no concrete evidence available to that effect. This topic was explored by King³ (pp. 26-7), who cited Pliny to justify his claim that diamond was used for engraving gems during the latter's lifetime, or during the early decades of the Christian era. King was of the opinion that splinters of diamond were imbedded in

CHEMICAL AND PHYSICAL PROPERTIES

iron tools for the purpose of engraving the very fine lines and grooves seen in engraved gems of this period.

Despite the availability of diamond after Pliny's time, the much cheaper emery or other powdered forms of corundum continued to be the agent of choice for the sawing and shaping of beryls and other gemstones (except the diamond) into modern times. Boetius de Boodt⁴ (pp. 74-85), writing in the 17th century, described the methods then in use and noted that all hard gemstones, except the diamond, were shaped on rotating tin laps and polished on tin laps charged with tripoli, a kind of very fine-grained quartz. He also mentioned diamond, but only in connection with its use for engraving.

Several hundred years later, Reinhard Blum⁵ (pp. 66-81) wrote an excellent treatise on gemstones in which he gave descriptions of the lapidary's tools and abrasive and polishing agents, little of which differed materially from those described by Boetius de Boodt. Blum, for example, noted that emerald crystals were sawed by thin metal discs supplied with a slurry of emery powder suspended in oil. Roughing-out of gem shapes was accomplished on copper laps using the same abrasive. Tin, a softer metal, was used for polishing; the polishing agent was a watery slurry of either tripoli, pumice (a fine volcanic ash), or "tin ash," better known today as tin oxide.

For some unexplained reason, aquamarines were treated differently from emerald. The roughing-out of aquamarine was done on lead instead of copper laps, and polishing was accomplished on lead with tripoli. Modern experience shows that there is no perceptible difference in the lapidary behavior of emerald as compared to the other beryls. What works on one, works for all.

The concept that correct proportions and inclinations of facets on transparent gems could provide maximum brilliance was unknown to de Boodt. Even Blum gave only two geometrical rules to be followed in making faceted gems. He said the top or *crown* should be one-third of the total depth and the bottom part, or *pavilion*, should be two-thirds, but if the gemstone was weakly colored, the crown should be one-fourth the depth and the pavilion three-fourths. No scientific reason was given for these proportions, and it seems that they were arrived at by a hit-or-miss method developed through many years of cutting experience.

Poorly proportioned stones, or those cut too shallowly to reflect light from the back facets, could always be backed with a reflective metal foil, a practice which originated at least as early as the Renaissance. Today foil-backs are never used except for cheap glass stones. Instead, the lapidary attempts to obtain the maximum realizable brilliance by using the correct back facet angles and proportions.

LAPIDARY FEATURES OF BERYL

As can be seen in table 12-1, in which gemstones are arranged according to increasing hardness, beryl is neither very hard nor very high in refractive index,

Cutting and Polishing Beryl

Table 12-1
COMMON GEMSTONE PROPERTIES COMPARED

<i>Mineral</i>	<i>Hardness</i>	<i>Refractive Index Range</i>	<i>Remarks</i>
Feldspars	6.0-6.5	1.52-1.589	Brittle, cleave easily
Quartz	7.0	1.544-1.553	Good toughness, no cleavage
Beryl	7.0-8.0	1.560-1.638	Tough, no cleavage
Topaz	7.5-8.0	1.61-1.638	Hard, perfect but not easily developed cleavage
Tourmalines	6.0-6.5	1.616-1.64	Good toughness, no cleavage
Peridot	6.0-6.5	1.654-1.689	Easily chipped
Garnets	6.5-7.5	1.66-1.89	Tough, no cleavage
Spodumene	6.0-8.0	1.660-1.678	Perfect cleavage, sometimes troublesome in cutting
Spinel	7.5-8.0	1.715-1.729	Tough, no cleavage
Chrysoberyl	8.5	1.745-1.76	Very tough, no cleavage
Corundum	9.0	1.760-1.779	Very tough, no cleavage
Diamond	10.0	2.418	Extremely hard and tough despite perfect cleavage

Source: J. Sinkankas, *Gemstone & Mineral Data Book*⁶ (p. 184-5, 303-7).

which is a measure of the brilliancy which can be realized in a finished, correctly proportioned gem. Nevertheless, as explained above, there are compensations, and both emerald and its relatives remain highly prized gemstones.

The relatively uniform structure of the beryl crystal results in nearly uniform physical properties, as is evident from the moment the gem cutter begins to work the rough. The rough may be sawed, ground, and polished in any direction, and such cleavages as exist are so difficultly produced that they may be ignored. Finally, the small thermal expansion permits rough to be heated safely whenever the pre-formed gems are to be cemented to the dopsticks by which they are to be held during further shaping and smoothing. In sum, all of the above properties make beryl one of the lapidary's most favored gemstones.

SELECTION OF ROUGH ACCORDING TO COLOR

For the most part, it is easy to choose suitable aquamarine, golden beryl, and morganite rough because the crystals are often smooth-faced, permitting an unobstructed view of the interiors. Even in color-zoned crystals, the zones are seldom so pronounced that special treatment is necessary.

Usually the only requirement in choosing an orientation for the finished gem

CHEMICAL AND PHYSICAL PROPERTIES

is to select the better of the two colors that may be observed through the windows of a dichroscope. (Sometimes this choice is readily apparent without the use of a dichroscope.) As discussed in Chapter 8, in some aquamarines and golden beryls there may be decided differences in color according to crystallographic direction. That is, the color observed when looking through the sides of the crystal prism (parallel to the lateral axes) may be different than the color observed when looking down the length of the crystal (parallel to the *c*-axis). In the case of aquamarines, one of these colors may be stronger in tint than the other, or display a more desirable shade of blue, which many people prefer to a greenish-blue or yellowish-blue. In golden beryls, the differences generally involve shades of lighter or darker yellow, or sometimes a yellow which may be tinged with green as compared to a purer yellow seen in the other crystallographic direction. Once the desirable direction is established, the rough is shaped in such a manner that this direction passes up through the finished gem, through the top of a cabochon or through the large table facet of a faceted gem.

A more difficult choice of color direction faces the lapidary called upon to cut emerald because many crystals which appear to be colored uniformly are actually more or less strongly color-zoned. Unfortunately, the zone of color almost always appears upon the outer parts of the crystal, or exactly in those places which would be cut away in the normal course of shaping. Zoned crystals are common among the emeralds of North Carolina and Chivor and are less common in those of Muzo. Some Chivor crystals have been found which contain several alternating zones of colored and uncolored material that were not at all easy to detect during a cursory examination. Several examples are shown in the color plane in Klein's book on the Chivor emerald deposits⁷ (p. 64) and in figure 8-1.

In most instances, zoning can be detected easily by examining the fractured base of crystals. It is here that the differences in color are most apparent. However, in difficult cases, the only safe method is to examine the crystal in a suitable immersion fluid, as will be explained below.

A prudent rule to follow in purchasing emerald rough is to suspect color zoning whenever relatively flawless crystals of good size, which seemingly should command a good price, are offered cheaply. They may be color-zoned in a thin, intensely colored layer adjacent to the prism faces, which surely would vanish at the moment of cutting, with the result that a colorless or at best feebly colored gem would be obtained.

IMMERSION FLUIDS FOR INSPECTING ROUGH

The testing of gem rough in an immersion fluid is based on the same optical principle that is at work when a piece of clear ice seems to disappear when placed in a glass of water. In both instances, the refractive index of the liquid and the solid

Cutting and Polishing Beryl

match so closely that light passing through the fluid is prevented from being reflected from the surfaces of the solid. When a suitable liquid is chosen for immersion of beryl, the effect can be startling, to say the least, the crystals or fragments seemingly vanishing from view the moment they are plunged into the liquid. If the beryl is colorless, it may become almost invisible, but at the same time, any inclusions inside the stone become clearly visible, and if the stone is rolled from side to side, color zoning also becomes apparent.

The liquid of choice for beryl immersion is bromoform, also called tribromoethane, CHBr_3 , a colorless, pleasant-smelling liquid with a specific gravity of 2.89 at 20°C and a refractive index of 1.598 at 20°C. The refractive index is so close to that of beryl that the vanishing effect noted above is very conspicuous. To inspect rough, pour sufficient liquid in a colorless glass beaker, but never plastic, and lower the rough into the fluid with tweezers. Because the specific gravity of the fluid is slightly above that of beryl, the beryl will just barely float. For very large pieces of rough, where complete immersion is impractical because of the large amount of fluid required, it is often enough to brush a bit of fluid over surfaces of the stone, thus, in effect, providing an instant "polish" and allowing a view inside. Immersion treatments are strongly recommended for buyers of expensive beryl rough, because flaws, inclusions, and color zoning are easily detected.

Bromoform is not ordinarily available in drugstores, but it may be obtained on special order or ordered directly from chemical supply houses. It is also available from suppliers of gemological instruments and accessories such as the Gemmological Institute of America in Santa Monica, California, or the Gemmological Association of Great Britain in London.

Instead of bromoform, almost any liquid reasonably close in refractive index to beryl will do. Lists of such fluids can be found in Sinkankas's *Gemstone & Mineral Data Book*⁶ (pp. 331–5) and in gemological identification texts. Several organic oils may be used, although these by no means are cheap: anise oil (R.I. 1.54–1.56), cassia oil (1.58–1.60), cinnamon oil (1.59–1.60), and wintergreen oil (1.54). Lacking any of these, good results may still be obtained with such common colorless liquids as the "flushing oils" used in automobile repair shops, kerosene, turpentine, and the colorless mineral oils sold in drugstores.

INCLUSIONS IN CUT GEMS

Any inclusion impedes and scatters light. A large number of them, as is found in the "jardin" emeralds, in which the inclusions resemble mossy growths, scatter light so completely that the reflections from back facets seem more like a green glow than anything else. As the number of inclusions diminish, the back facet reflections appear more sharply defined; in stones that contain no inclusions, the reflections are entirely crisp and clear. A small number of inclusions can be accom-

CHEMICAL AND PHYSICAL PROPERTIES

modated in gems cut in brilliant style where their effect is lost amid the general dazzle provided by the multitudinous reflections from the many small facets used in this style of cutting. The worst case occurs in the severely formal step-cuts, which employ very few facets cut rigidly parallel to each other. Even the smallest inclusion is re-reflected until it becomes quite obvious, and if it is located near the bottom of the stone, it makes the gem seem cracked entirely across. If, as in the case of emeralds, some inclusions cannot be avoided, then the lapidary must be careful to place the worst of them along the outer edges of the gem and a little distance below the crown facets.

In the case of aquamarines, golden beryls, and morganites, hardly any inclusions or other flaws are tolerated. Most lapidaries prefer to cut away any included parts of the rough and accept a smaller-sized but flawless finished stone.

CHATOYANT BERYLS

Chatoyant or cat's-eye beryls are cut from crystals which contain large numbers of very fine tube-like cavities aligned parallel to the *c*-axis. It is axiomatic that the more slender and numerous the tubes, the sharper and more brilliant the "eye" becomes in the finished gem. It is very rare, however, that a cat's-eye beryl is cut to match the quality of the eyes found in chrysoberyl cat's-eyes or even in star rubies and sapphires. Mostly the tubes in beryl are relatively coarse and the eye less perfectly developed.

Most eye beryls are cut as fairly high cabochons from bluish Brazilian aquamarine. These are very rarely intensely colored and most of them appear quite pale. Even more rare are golden beryl cat's-eyes, but some of extremely high quality have been cut from a curious, greenish corroded beryl once found in Madagascar. A large gem from this locality is in the collections of the Natural History Museum in Washington, D.C. Rarest of all are cat's-eyes of emerald, extremely few of these ever having been recorded. For practical purposes they are nonexistent.

To cut a cat's-eye beryl, it is necessary to orient the rough so that the tubes are parallel to the flat bottom of the cabochon. Furthermore, if the cabochon is elliptical in outline, the tubes must also run at right angles to the long axis of the ellipse. In the finished gem this will result in the streak of light or "eye" running over the top of the cabochon from one narrow end of the ellipse to the other. If for any reason these rules are ignored, the eye will be offset to one side, the amount depending on the amount of error in the original orientation. The eye is narrower and more brilliant when the stone is sharply curved on top, and for this reason the curvature is adjusted by the lapidary so that the height is from one-third to one-half the width of the stone.

A special case of chatoyancy is the star stone, in which several streaks of light from as many separate sets of inclusions cross over atop the finished gem to form

Cutting and Polishing Beryl

a star. In beryl, such stars have never been observed where they are due to tubular inclusions, but they have been seen where the inclusions of a foreign mineral, such as ilmenite and hematite, orient themselves upon basal planes in the growing crystal in fixed geometrical positions. This orientation is called *epitaxy* (already discussed in Chapter 10). It can provide weak stars but these are poorly reflective and never as sharp as those seen in star rubies and sapphires. Strictly speaking, they are not chatoyant stars at all but rather spangly reflections which more properly could be called a special case of *aventurescence*, or the reflection from a host of small disk-like platelets of a foreign mineral arranged in parallel planes.

The cutting of the star stones mentioned above is somewhat difficult due to the broadness of the inclusions, which form weak areas in the beryl. Care must be taken during grinding to prevent such places from chipping away and leaving deep pits which then require much sanding to remove. The procedure for orienting and cutting these stones was explained in detail by Leiper.⁸ An excellent polish was obtained with a mixture of chrome oxide and Linde-A alumina powder on leather. A 20-carat gem cut by Leiper is now in the Natural History Museum, Washington, D.C.

LAPIDARY TREATMENT FOR CABOCHONS

For explanation of the steps required in processing beryl cabochons and carvings, the reader is referred to standard texts as Sinkankas⁹ and Quick and Leiper.¹⁰ In general, all rough is sawn with very thin diamond-charged steel or bronze blades whose edges run in an oily or watery coolant. The stones are then marked for shaping and are ground on coarse and fine silicon carbide or diamond-charged wheels using water as a coolant. Further surface smoothing is done on coarse and fine flexible abrasive cloth, also supplied with water. Lastly, the gems are polished. Several types of polishers may be used, including wood, leather, hard felt, and plastic, the softer buffs usually being supplied with polishing powders such as Linde-A, chrome oxide, tin oxide, or cerium oxide suspended in a water slurry. More rapid results are sometimes possible with use of diamond powder paste on the harder buffs made from wood, plastic, or leather. Because of the strong green color of chrome oxide, this agent is seldom used because it may disfigure the stone if it enters cracks.

For cabochon emeralds, especially those in which numerous inclusions appear, the lapidary may seal the openings to such inclusions with epoxy resin just prior to commencing polishing. This step prevents powders from entering the stone. If polishing powders enter unprotected crevices, they can be removed only with considerable difficulty. Cabochon emeralds may also be incised with a series of melon-like ridges to add attractiveness and help disguise flaws. These grooves are cut on very small abrasive wheels and smoothed with equally small sanding wheels which

CHEMICAL AND PHYSICAL PROPERTIES

may be made from leather, wood, plastic, or even rubber, followed by another set of wheels supplied with a suitable polishing agent. In general, emerald cabochons are cut "high," that is, the height nearly equals the width of the stone.

A popular method of utilizing beryls too flawed for other purposes is to tumble the fragments in barrels with water and a suitable abrasive. The process is carried on for a long period of time or until all edges and surfaces are worn smooth. After this step, which may take weeks, the stones are removed and carefully washed, then placed in another barrel with a suitable polishing agent to obtain a beautiful glass-like finish. Such tumbled gems or "baroques" are much used in all kinds of jewelry in which an unsophisticated or even barbaric air is desired.

BERYL CARVINGS

Beryl is readily carved using small diamond wheels to saw away unwanted parts and to further shape the carvings. Small abrasive wheels made from silicon carbide are also used for shaping, and loose silicon carbide grit applied to wood, plastic, or leather wheels is used for sanding the surfaces to a satisfactory degree of smoothness prior to polishing. The same polishing wheels, although of a smaller size as needed to fit into small recesses, and the same polishing agents as were used for making cabochons are also employed. However, because of the generally pale colors in which beryls occur, carvings in this mineral do not stand out as well as those executed in darker gemstones or those that are only translucent. For this reason, beryl carvings are far from common. Indeed, one may see hundreds of small objects carved from quartz varieties, jades, serpentines, etc., for every one carving of beryl.

FACETED GEMS

In a tradition of at least three centuries duration, the emerald has been cut in a severely simple style which has become known as the "emerald cut," that is, into a rectangular gem covered with elongated strip-like facets. This cut is also known as the step cut. To protect the corners and to provide places where the gem may be seized by the prongs of the mounting, the corners are usually also cut off in a series of very narrow steps, thus conferring to the gems an octagonal outline. This style of cutting is also much used for other beryl gems such as aquamarines, golden beryls, and morganites, although many of these are also cut in brilliant style, that is, in circular or elliptical shapes, covered with a multitude of small, more or less triangular facets. Other styles may take a circular or elliptical outline with the facets cut as a series of small steps, cleverly adjusted to provide uniform coverage of the entire surface. Still other styles include the "mixed cut" wherein one part of the gem is faceted as a brilliant and the other in steps.

The popularity of the step cut for beryls may be due in part to the fact that the

Cutting and Polishing Beryl

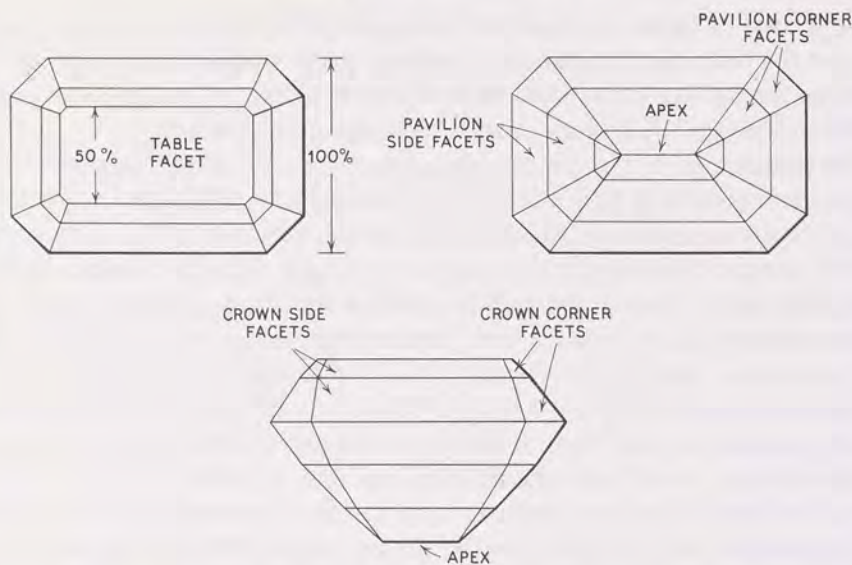

Fig. 12-1 Typical proportions of the step or emerald cut. Additional facets may be added to the crown and pavilion, especially on larger stones.

usual prismatic shape of the crystals lends itself readily to this form of cutting with minimum loss of material. Certainly this consideration also affects the selection of the step cut for the cutting of emeralds. However, as previously noted, the presence of unavoidable flaws or inclusions requires employment of brilliant cuts whereby the flaws are made less conspicuous. It is probably for this reason that so many of the large aquamarines of early Russian vintage are found faceted in brilliant style because these gems were seldom entirely free of flaws.

While the step cut is popular for large and flawless beryl gems, it is also a severe test of the lapidary's skill because all of the long and narrow facets placed upon the crown and pavilion must be exactly parallel. If they are not, the reflections from them become wedge-shaped, as is immediately apparent as the stone is slowly turned to change the pattern of reflections. Some older hand-cut gems show slight but noticeable errors, but fewer of the modern ones do because they are usually cut with the aid of accurate faceting machines.

Proportions and Angles of Faceted Gems

The cross-section of a faceted gem resembles a reflecting prism in which the light that falls through the top of the gem is reflected back from inner facets to return to the eye, resulting in the effect known as brilliance. The angle made by

CHEMICAL AND PHYSICAL PROPERTIES

the bottom pair of facets is crucial to brilliance. If the angle is incorrect, the light passes out the bottom of the stone and a dark spot is seen by the viewer instead of the desired mirror-like reflections. Only a narrow range of bottom-facet angles is available to the lapidary to maximize reflections and brilliance.

The measure of this angle has been the subject of numerous optical studies aimed at tracing paths of light within a gem and calculating the angles whereby the paths can be diverted upward. Much depends on the refractive index of the gemstone itself, the general rule being that gemstones of higher refractive index, capable of bending light more sharply, produce the greatest brilliance, while those gemstones of lower refractive index produce less. Furthermore, in the case of higher refractive index gemstones, inner reflections can result from shallower bottom angles, thus allowing these gems to be cut less deeply. This becomes apparent when two brilliant gems of the same size and style of cutting are compared, one being a diamond and the other a beryl. It will be seen that the diamond is cut to less depth while the beryl had to be cut to greater depth in order to insure upward reflection of light.

An intensive study of ideal proportions and angles for faceted gems was conducted by Maier,¹¹ who provided a table of angles for various gemstones. For the emerald (refractive index 1.5838), the recommended angle for pavilion facets is 39°9'18" and for the crown facets 30°47'37". Eppler¹² provided another set of angles, based on his own calculations, as shown in table 12-2.

Eppler had sample gems cut to these specifications and claimed them to be

Table 12-2
W. F. EPPLER'S BERYL PROPORTIONS AND ANGLES

<i>Variety</i>	<i>Rose Beryl (Morganite)</i>	<i>Emerald</i>	<i>Aquamarine</i>
<i>Refractive index</i>	<i>o = 1.594 e = 1.586</i>	<i>o = 1.582 e = 1.575</i>	<i>o = 1.571 e = 1.566</i>
Pavilion depth	40.6% of diameter	41.1%	41.5%
Crown depth	27.9	28.1	28.2
Total depth	68.5	69.2	69.7
Total depth + 2% for girdle thickness	70.5	71.2	71.7
Table facet width	59.9	57.0	54.1
Pavilion angle	39.1°	39.4°	39.7°
Crown angle	54.3°	52.6°	50.8°

Source: Eppler,¹² pp. 26-30.

Cutting and Polishing Beryl

Table 12-3
CURRENT RECOMMENDED PROPORTIONS AND
ANGLES FOR CUTTING BERYL

Pavilion depth: about 2/3 of diameter

Crown depth: about 1/3 of diameter

Authority	Pavilion Main Facet Angle	Crown Main Facet Angle
Willems ¹³	42°	45 °
Quick and Leiper ¹⁰	43°	42°
Sinkankas ⁹	43°	40°-50°
Schlagel ¹⁴	41°	37°
Hoffman ¹⁵	43°	42°
Vargas and Vargas ¹⁶	43°	42°

eminently satisfactory. But his specifications required cutting the crown so high that it appeared awkward when placed in mountings, and they departed so radically from the traditional proportions that no one adopted them. The proportions and angles given in table 12-3 remain those generally in use.

In a radical departure from normal practice, Barriga Villalba and Barriga Del Diestro¹⁷ (pp. 55-68) proposed a style of cutting for the emerald which is claimed to afford maximum brilliancy. The principle behind the cut is making the pavilion of the gem approximate the curve of a parabola, with the focal point near the bottom of the gem (figure 12-2). The cross-section shows main crown facets inclined at angles of 38° to the plane of the girdle and five step facets on the pavilion inclined to this plane at angles of 62°, 55°, 47°, 36°, and 15°. In effect, the pavilion approximates the shape of a cabochon and, as one may expect, provides about the same reflectivity as may be seen in any transparent cabochon when it is turned over and viewed from the back. In such cabochons, and also in the cut proposed, light is reflected from a peripheral band but scarcely any from the center, which therefore appears dark. The theory is attractive, but only if the light were to originate at the focal point of the parabola, which of course it does not.

Deviations from Recommended Angles and Proportions

Excluding the emerald, most beryl gems are too pallid to be attractive unless cut in sizes of at least 10 carats and preferably about 15 carats. However, when cut to ideal proportions and angles, the pavilions extend so far down that severe prob-

CHEMICAL AND PHYSICAL PROPERTIES

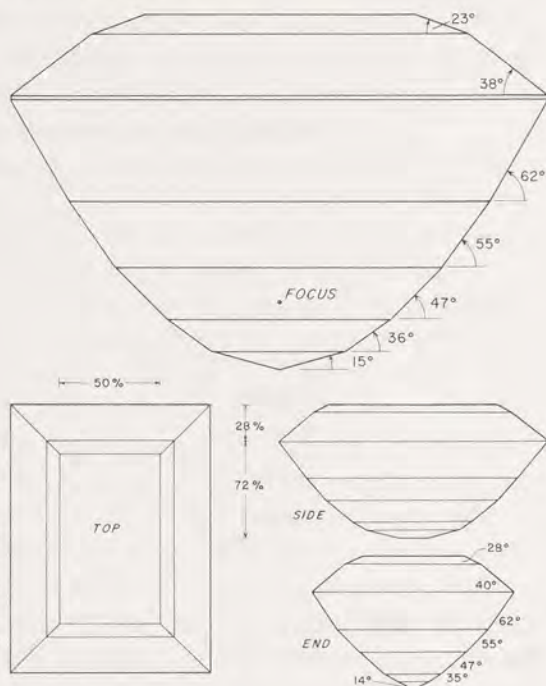

Fig. 12-2 Angles and proportions of cut emeralds advocated by A. M. Barriga Villalba and A. M. Barriga del Diestro in *La Esmeralda de Colombia* (Bogota: Colegio Mayor de Nuestra Señora del Rosario, 1973). The pavilion facets closely approximate the curvature of a parabola, the focus of which is shown in the top figure. Slightly different angles are shown in a similar cut below.

lems arise in mounting them in jewelry. To prevent the bottom of the pavilion from rubbing the skin of the finger in the case of rings, the gem would have to be mounted so high that it tends to topple over or snag on clothing. For this reason, it is customary among lapidaries cutting stones for the jewelry trade to make them somewhat shallower than is theoretically desirable. The result is that considerable light escapes through the bottoms of the gems, creating a dark patch or "hole."

POLISHING LAPS AND AGENTS

Faceting of beryls is a simple because the predictable properties of the gemstone cause no difficulties at any stage. The gems may be given their preliminary or "preform" shape on an ordinary water-fed silicon carbide grinding wheel, or they may be preformed on the dopstick against a diamond-charged metal lap on a faceting machine. The facets are cut on diamond, usually finishing the cuts with the finest-grain diamond lap available. The laps used for polishing may be pure tin, which is the preferred lap, or an alloy of tin-typemetal, typemetal alone, or plastic. Sharper facets are possible on the metal laps and these should be used in preference to plastic laps. The polishing agents include Linde-A alumina powder, the agent preferred by most cutters, applied to a tin lap, and tin oxide, chrome oxide, and rare earth oxides, the last agents working best on the plastic laps.

Cutting and Polishing Beryl

Literature Cited

1. Lucas, A. 1934. *Ancient Egyptian Materials and Industries*. 2nd ed. London: Edward Arnold & Co. 447 pp.
2. Eichholz, D. E. 1965. *Theophrastus De Lapidibus*. Oxford: Clarendon Press. 141 pp.
3. King, C. W. 1865. *The Natural History, Ancient and Modern, of Precious Stones and Gems, and of the Precious Metals*. London: Bell and Daldy. 442 pp.
4. Boodt, A. B. de. 1647. *Gemmarum et Lapidum Historia*. 3rd ed. Leiden: Joannis Maire. 576 pp.
5. Blum, R. 1832. *Taschenbuch der Edelsteinkunde*. Stuttgart: C. Hoffmann. 356 pp.
6. Sinkankas, J. 1972. *Gemstone & Mineral Data Book*. New York: Winchester Press. 352 pp.
7. Klein, F. 1941. *Smaragde unter dem Urwald*. Berlin: Oswald Arnold Verlag. 285 pp.
8. Leiper, H. 1958. How to cut star beryl. *Lapidary Journal* 12:250-4.
9. Sinkankas, J. 1962. *Gem Cutting, A Lapidary's Manual*. 2nd ed. Princeton: Van Nostrand Co. 297 pp.
10. Quick, L., and Leiper, H. 1977. *Gemcraft, How to Cut and Polish Gemstones*. 2nd ed., revised by P. D. Kraus. Radnor, Pa.: Chilton Book Co. 195 pp.
11. Maier, W. 1949. *Brillanten und Perlen*. Stuttgart: E. Schweizerbart'sche Verlagsbuchhandlung. 188 pp.
12. Eppler, W. F. 1938. Die Brillanz durchsichtiger Edelsteine. *Fortschritte der Mineralogie* (Stuttgart) 32. 40 pp.
13. Willems, J. D. 1948. *Gem Cutting*. Peoria, Ill.: Charles A. Bennett. 224 pp.
14. Parsons, C. J. 1966. Charles Schlagel's facet angles. *Gems and Minerals* (Mentone, Ca.) no. 342, pp. 27-9.
15. Hoffman, D. L. 1968. *Comprehensive Faceting Instructions*. Spokane, Wash.: Aurora Lapidary Books. 94 pp.
16. Vargas, G., and Vargas, M. 1969. *Faceting for Amateurs*. Thermal, Ca.: privately published. 330 pp.
17. Barriga Villalba, A. M., and Barriga Del Diestro, A. M. 1973. *La Esmeralda de Colombia, Descripción y Propiedades*. Bogota: Colegio Mayor de Nuestra Señora del Rosario. 100 pp.

CHAPTER

13

BERYL DEPOSITS

BERYLLIUM is one of the rarer elements in the earth's crust. Estimates of its quantity have been made by Goldschmidt¹ (pp. 206–13) and more recently by Beus² (pp. 310–22). According to Mason⁴ (p. 45), on the average 2.8 grams of beryllium occur per ton of crystal rock, with a little less than one-third of the total concentrated in diabase and about two-thirds in granitic rocks. Among the forty known beryllium minerals, the element itself has been extracted largely from beryl, the most common beryllium species. Furthermore, almost all minable beryl occurs in coarse-grained rocks known as *granitic pegmatites*, in which beryl is sometimes so abundant that bodies of this rock can be mined profitably for the beryl alone.

In addition to a concentration in granitic pegmatites, beryl occurs in substantial to minor quantities in other types of deposits. These are listed according to their genetic type in table 13-1, showing the diversity of the deposits as well as their interrelationships. Beryllium is primarily associated with igneous rocks, and as may be expected, its principal mineral follows the same association, appearing in the rare rhyolite rock occurrences in Utah but more commonly in deposits that originate from granitic magmas or their offshoots. With all of these deposits the role of water is evident, serving primarily as the solvent of mineral matter when occurring in a heated environment, and as the agent largely responsible for the deposition of beryl and other durable minerals in occurrences derived from the weathering of in-place deposits (eluvial and alluvial deposits). The thirteen basic types of beryl deposits listed in table 13-1 are discussed in detail.

Beryl Deposits

VOLCANIC

Red Beryl in Rhyolite

Dark raspberry-red, tabular to short prismatic crystals of beryl occur in unique deposits in two areas in Utah and in one place in New Mexico. The host rocks in all cases are light-colored rhyolite with the crystals formed in small gas cavities (vesicles), in clays derived from alteration of the rock, and in porous phases of the rhyolite. A search of the beryl literature failed to record occurrences of this type elsewhere in the world, thus they are apparently unique to the Western United States. The absence of water as determined by analyses suggests that the crystals grew at high temperatures, possibly from gas-transported (pneumatolytic) material. Some of the larger and clearer crystals from the Wah Wah Mountains deposit have been cut into very attractive faceted gems which resemble rubies, but they are seldom cuttable over a carat or two in weight. (See Part 3, Beryl Localities, for further details on this and other deposits.)

EARLY MAGMATIC

Beryl Disseminations in Granite

In the upper portions of large, upthrust masses of granite (plutons), a coarse-grained texture is sometimes encountered with considerable pore space. Apparently such openings enable beryl and other minerals to be transported, through the agency of water trapped in the granite, more or less uniformly throughout some areas, forming disseminated deposits. The crystals tend to grow as slender individuals in clusters or in masses radiating from a common center. Because they do not grow in cavities, they are seldom well formed. Deposits of this type are rare and of no commercial significance. They have been identified in Idaho and Utah.

Miarolitic and Schlieren Beryl Deposits

The word *miarolitic* comes from *miarolo*, a term used by Italian quarrymen at Baveno, Italy, to describe a kind of coarse-grained granite in which occur irregular cavities lined with crystals. Bazzite, the scandian analog of beryl, was first found in the Baveno quarries. The German term *Schlieren*, or, literally, "streaks," has been adopted into English to designate lens-like portions of a rock mass that contain minerals crystallized to a much larger size than found in the enclosing rock. Miarolitic cavities are often lined with similar coarse-grained rock, the large grains then forming fine crystals in the openings. If cavities are found in schlieren, they too will be lined with equally good crystals.

Both types of deposits are strictly of local occurrence and are usually small and irregular in form. Furthermore, they show indistinct contacts with the enclosing rock from which they are derived. The term, *syngenetic*, meaning "formed at the same time," has also been applied to them. In most examples, the cavities are

Table 13-1
GENETIC TYPES OF BERYL DEPOSITS AND BERYLS

<i>Genetic Classification</i>	<i>Deposit Type</i>	<i>Hydrothermal Activity</i>	<i>Crystal Habit</i>	<i>Colors</i>
Volcanic	Gas cavities in rhyolite	Absent	Tabular to short prismatic; euhedral	Pink to dark raspberry red
Early Magmatic	Disseminated in granite	Slight	Long to very long prismatic; interlocked and in radiate groups; anhedral	Very pale blueish, greenish, or nearly colorless
	Miarolitic, pegmatitic schlieren in granite	Localized, slight	Short to long prismatic, often striated; slight to severe etching and corrosion	Pale blue, blue green, greenish, yellowish
Late Magmatic	Granitic pegmatites simple, unzoned	Significant	Short prismatic, poor terminations	Pale greenish, blueish, yellowish, white
	Granitic pegmatites, simple, zoned	Significant	Short prismatic, poor terminations	Same
	Granitic pegmatites, complex, zoned, replaced mucovite-albite and albite	Extensive in inner zones, fracture fillings	Short to medium prismatic, conical, intergrown; fluted faces	Greenish, yellowish, white
	Granitic pegmatites, complex, zoned, replaced spodumene-albite and lepidolite-albite	Extensive in inner zones, fracture fillings	Short prismatic to tabular; also irregular and corroded masses (morganite)	Pink, yellowish, colorless, white
Metamorphic-Hydrothermal	Schist type (exomorphic)	Transfer of Be to host rocks	Poorly formed, short to long prismatic, commonly untruncated	Blueish, greenish, green (emerald)
Hydrothermal	Greisens	Intense, local, along fractures	Prismatic; poorly developed when enclosed; fine, euhedral in cavities	Pale blue, greenish, yellowish, and combined color zones
	Carbonate veins and tactite bodies	Extensive along fractures	Short prismatic, commonly fine	Colorless, very pale blueish, greenish; also fine green (emerald)
	Alpine clefts	Extensive along fractures	Short to long prismatic to acicular	Colorless, pale blue, greenish; rarely emerald
Sedimentary	Eluvial	Decomposition of deposit	As in the deposit	As in the deposit
	Alluvial	Transported by water	As in the deposit, more or less worn	As in the deposit

Sources: Beus;² Vlasov;³ Buchi;⁵ Cameron.⁶

Table 13-1 (continued)
GENETIC TYPES OF BERYL DEPOSITS AND BERYLS

<i>Composition</i>	<i>Associated Species</i>	<i>Localities</i>	<i>Remarks</i>
Water absent	Quartz, topaz	Thomas Mts., Wah Wah Mts., Utah	Crystals from several mm to ca. 10 mm; small clear areas (Wah Wah Mts.)
Alkali-free; some Fe	Quartz, feldspars, micas	Sawtooth Mts., Idaho	Some clear areas in crystals
Alkali-free; some Fe	Microcline, micas, quartz, albite; also phenakite, topaz, tin and tungsten species; bazzite	Mt. Antero, Colorado; Mongolia; Transbaikalia, U.S.S.R.	Often splendid crystals, some of gem quality
Alkali-free; some Fe	Quartz, microcline, muscovite, garnet	Colorado	Sometimes abundant and then providing ore
Alkali-poor; some Na may be present	Quartz, microcline (sometimes amazonite), topaz, muscovite, biotite; rarely fergusonite and other Ta-Nb species; allanite, xenotime, monazite	Widely distributed; amazonite-type in Ilmen Mts., U.S.S.R.; rare earth type Barringer Hill, Tex.; Iveland, Norway	Ore beryl; sometimes fine crystals in vugs
Na ₂ O ca. 0.5%; gas-liquid inclusions abundant	Microcline, quartz, muscovite, albite, schorl, Fe and Mn phosphates; also triphylite, columbite-tantalite, phenakite, chrysoberyl, other Be species	N.E. Brazil; India; Argentina	Ore beryl; small clear areas in large crystals; rarely fine crystals in vugs
Na and Li, also Cs and Li; Cs greater than 1.0%; Mn often present	Albite, quartz, muscovite, elbaite, spessartine; also lithophilite, amblygonite, columbite-tantalite, microlite, spodumene, pollucite, lepidolite, petalite, beryllonite, other Be species	Harding mine, New Mex., San Diego, Co., Calif.; Minas Gerais, Brazil; Madagascar	Fine crystals in vugs and central cavities (morganite)
Aquamarine type; also emerald (Cr)	Quartz, fluorite, apatite, Mg-silicates, micas, sometimes chrysoberyl	Petaca district, New Mex. (aquamarine); emerald: Ural Mts.; Egypt; South Africa	Grading from pale hues, to fine green as in emerald; schist type deposits now important for emerald prod'n.
Alkali-free, some Fe	Quartz, micas, feldspars, also Sn and W species; apatite, fluorite	Transbaikalia, U.S.S.R.	Fine clear crystals in vugs
Some Fe, Na; Cr in emerald	Emerald: albite, Fe-carbonate, pyrite, parisite, quartz. Tactite: calcite, quartz, calc-silicates, scheelite, magnetite, fluorite, garnet	Colombia (emerald); Kazakhstan, U.S.S.R.	Classic emerald deposits in Colombia
Some Fe, Na; rarely some Cr	Quartz, feldspars, schorl, monazite, bazzite	European Alps; Hiddenite, North Carolina	Rarely with emerald (North Carolina)
—	Durable species of original deposit	Minas Gerais, Brazil; Transbaikalia, U.S.S.R.	Crystals usually in fine condition
—	Durable species of original deposit	Minas Gerais, Brazil; Ceylon	Water-rolled crystals, sometimes with no crystal faces left

CHEMICAL AND PHYSICAL PROPERTIES

surrounded by zones containing the regular intergrowth of feldspar-quartz known as *graphic granite*, but this type of rock is not confined to these deposits and is found in other types as well. Characteristically, the grain size rapidly increases as the central portion of the body or the cavity (if one is present) is reached. In cavities, the same minerals as form the walls are present, except now as well-formed crystals, usually of microcline or orthoclase feldspar and quartz, sometimes micas, occasionally the thin-bladed variety of albite feldspar known as cleavelandite, topaz, and rarely beryl or other rare element minerals. Because of growing in such openings, all of the minerals, including the beryl, may be sharply crystallized and often completely transparent.

Since these deposits may not exceed a few decimeters or a meter or two across (less than 12 in to ca. 6 ft), they seldom produce significant quantities of economically important minerals aside from crystal specimens for collectors and occasionally gemstones. Deposits of this type are common in some areas of New Hampshire (although beryl is rarely found here) and Colorado, but the best-known and the most productive deposits for beryl specimens and gem material occur in Transbaikalia in the southern Asiatic portion of the U.S.S.R. and in the Ural Mountains of Siberia. Extremely large cavities have been found in miarolitic bodies of Volhynia, Ukraine. Several types of these deposits and their minerals have been described in detail by Beus² (pp. 171 ff.).

Fine crystals of blue aquamarine also occur in small cavities in the granite of the summit of Mt. Antero associated with smoky quartz crystals and the rare beryllium mineral phenakite, which forms small, colorless and inconspicuous crystals in the cavities. In the Volhynian bodies, Beus noted microcline-orthoclase, cleavelandite, colorless and smoky quartz, zinnwaldite, muscovite, lepidolite, schorl and elbaite tourmaline, topaz in several colors, and beryls in various shades of greenish-blue, green, olive-green, blue, golden, pink, and colorless. The beryl crystals in such cavities, often very sharply formed, and highly transparent, may provide important quantities of gem material. However, etching and corrosion sometimes occur, as is notable in the Mt. Antero deposits, and the original crystals may be reduced to masses of slivers which resemble glittering darning needles. None of the crystals tend to be large, ranging from very small up to about 25 cm (10 in) long and 3 to 4 cm (1¼ to 1⅝ in) in diameter. Most crystals, unfortunately, are broken from their matrix points of attachment by natural forces, but occasionally a fine specimen is found with crystals upright on the base rock.

LATE MAGMATIC

Granitic Pegmatites

The principal sources of beryl crystals are bodies of coarse-grained rock that contain essentially the same minerals as are found in granite, namely, feldspar,

Beryl Deposits

quartz and mica, often accompanied by smaller amounts of black tourmaline and rare-element minerals. The size of the grains, or individual crystals, ranges from a millimeter to as much as several meters across, depending on the size of the body and other factors. The dimensions of the bodies range from only several centimeters in thickness and several meters long to those that may be a hundred meters thick and several kilometers long. The name given to them, *pegmatite*, refers to the unusually large grain size and will be used frequently in this chapter and in the descriptions of beryl occurrences in Part 3.

Pegmatites occur in granites and in the rocks which adjoin granite masses, often as intrusions along fractures. Because they are derived from and associated with granites, they are found in many areas of the world, large numbers outcropping in such places as Brazil, United States, Siberia, Madagascar, and India, to name a few. Historically, pegmatites were first exploited for pottery feldspar and mica, the latter once called "Muscovy glass" in Europe because of its origin in Russian pegmatites. In modern times, they have also proved to be valuable sources of rare elements such as tantalum and niobium, in addition to beryllium. Gemstones derived from the weathering of pegmatites have been collected from stream gravels in Brazil since the 16th century, but it is only in the past century that the bodies themselves have been systematically mined for gemstones, mineral specimens, and rare element minerals.

Accurate geological and mineralogical knowledge of pegmatites is also a recent development, as pointed out by Fersman⁷ (vol. 1, p. 11). Studies now show that many pegmatite bodies formed in distinct stages, as reflected in the mineralization of zones within them, apparent in figures 13-1 and 13-2. For example, the outermost zone, adjacent to the enclosing country rock, is generally fine-grained and mineralogically uninteresting. However, as successive waves of mineralization took place, increasingly larger crystals grew in intermediate zones, and the largest of all in the cores. In the vast majority of bodies, the mineralization is simple; that is, only the basic constituents of feldspar, quartz, and mica are present, with perhaps a little tourmaline, garnet, and beryl. However, other bodies are more complex. They were formed during successive waves of mineralization, often with the introduction of new elements which formed their own distinctive mineral species, or recombined with previously present elements to form additional species. Thus, the complex pegmatites, with their varied minerals, are of greatest interest to geologists, mineralogists, mineral and gemstone collectors, and miners seeking rare element ores.

It sometimes happens that the mineral matter intruded during pegmatite formation fails to completely fill the space available, with the result that openings or vugs, also called "pockets," are left. Because the minerals lining such openings grew without interference, they provide the finest of all crystals, often beautifully

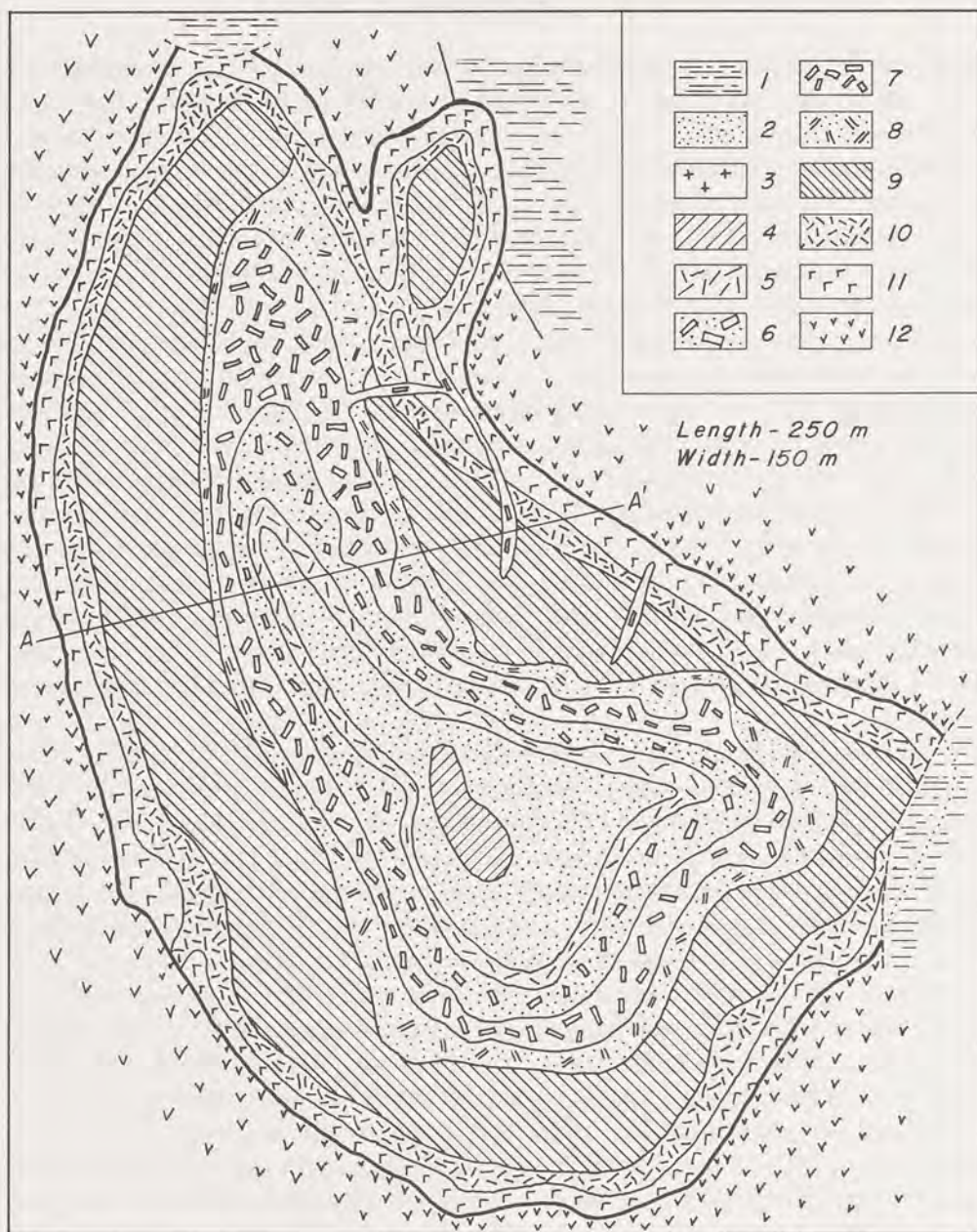

Fig. 13-1 Plan of a complex granitic pegmatite (Mongolian Altai) showing numerous zones. (1) overburden, (2) blocky quartz, (3) lepidolite (visible near top of figure 13-2), (4) blocky microcline, (5) platy albite (cleavelandite), (6) quartz-spodumene, (7) cleavelandite-spodumene, (8) zone of quartz-muscovite pods, (9) blocky microcline, (10) fine-grained albite pods, (11) graphic quartz-microcline, (12) enclosing gabbro. Pink alkali beryl (vorobeyevite) occurs in (3) and (5), greenish or greenish-yellow beryl in (6), (7), and (10). After N. A. Solodov, Distribution of alkali metals and beryllium in the minerals of a zoned pegmatite in the Mongolian Altai, *Geochemistry* 8 (1960): 874-85.

Beryl Deposits

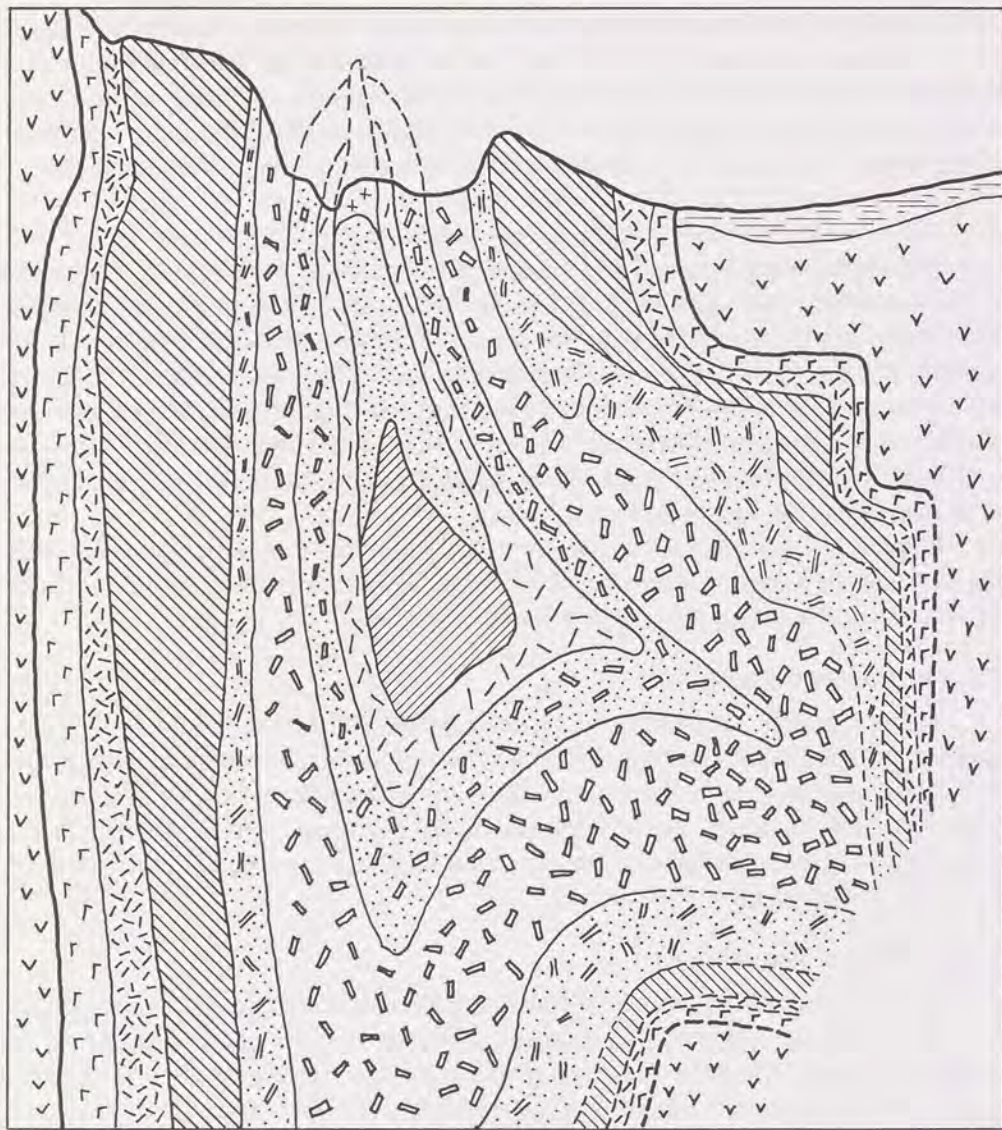

Fig. 13-2 Cross-section along A-A' of the pegmatite body shown in figure 13-1.

formed, transparent, and colorful. It is from such pockets that gem specimens of tourmaline, quartz, topaz, and beryl are taken, not to mention a considerable variety of other minerals that are eagerly sought after by collectors.

One of the classic works describing the wonderful pocket minerals obtainable from pegmatites, including gem beryls, is that of Lacroix,⁸ who treats in detail the

CHEMICAL AND PHYSICAL PROPERTIES

gem-bearing pegmatites of Madagascar. A summary of the most important features of the internal structures of granitic pegmatites is provided by Cameron et al.⁶ who studied a large number of pegmatite bodies, especially those occurring in the United States. The geochemistry of pegmatites was treated by Jedwab⁹ and Beus,² the latter being especially valuable for remarks on the internal structures and mineralizations of pegmatites in the U.S.S.R.

For the student of pegmatites, a very complete survey of the subject as well as a large bibliography appear in Schneiderhöhn's classic work of 1961.¹⁰ An excellent summary also appears in Booyesen,¹¹ a paper written to present essential knowledge in a simple manner for the benefit of prospectors. Although written for South Africans, the information is universally applicable. More recently, Sinkankas¹² provided a simplified explanation of the features of pegmatites for prospectors, placing emphasis on how these could be recognized in the field. Hurlbut's *Minerals and Man*¹³ (ch. 5), provides an excellent popular summary of the attractive minerals and gemstones that are found in pegmatites.

In table 13-1, pegmatites appear in the Late Magmatic classification, reflecting the fact that they formed after emplacement and solidification of granitic magmas. They consist of the four basic types described below.

Simple, Unzoned Pegmatites

These pegmatites are simple in mineralogy, basically containing only feldspar, quartz, and mica with small quantities of other minerals which may include beryl. The latter, if it occurs in them, tends to form uncomplicated hexagonal prisms, often minutely fractured, and seldom providing any clear areas large enough for gemstones. On the other hand, if the beryl is sufficiently abundant, it may be mined as an ore of beryllium.

Simple, Zoned Pegmatites

As mentioned above, successive waves of mineralization produce zones within pegmatites characterized by differences in mineralization and increasing grain size toward the cores. Chemical reactions produce a larger variety of mineral species, several of which may be economically important.

Simple, zoned pegmatites range in size from mere stringers of several centimeters thick to enormous bodies that may be extremely large. In Maine, for example, pegmatites of this kind, quarried for the sake of pottery feldspar, are often so wide that trucks can be driven into excavations that are entirely within pegmatite. In addition to large crystals of feldspar, such deposits have also provided the world's supply of sheet mica, ore beryl, and tantalum-niobium ores, among others. In respect to beryl, however, most of its crystals are enclosed by other pegmatite minerals such as feldspar and quartz, and only rarely are they found free-standing

Beryl Deposits

in pockets. As a result of being solidly enclosed, they are usually shattered internally and seldom yield either good gem material or mineral specimens.

In a few instances, where pockets are found, excellent specimens of colorless and smoky quartz crystals, topaz crystals, and beryl crystals have been recovered. Non-gem beryl crystals, or those "frozen" in the pegmatite may be as much as a meter (3 ft) in diameter and two meters (6 ft) long.

A simplified diagram of zoning in such bodies is shown in figure 13-3. It is based on a large pegmatite body in Brazil and shows how certain of the pegmatite minerals occupy characteristic positions in the body. The body itself has been intruded into an amphibole schist and much of the original deposit has been eroded away leaving the quartz core, upraised, the portion of the body most resistant to weathering. Typical mineral zones here and in other pegmatites of this type include a fine-grained outermost contact zone, next inward a zone of graphic granite as shown in figures 13-1 and 13-2, medium-grained feldspar-quartz rock, an inter-

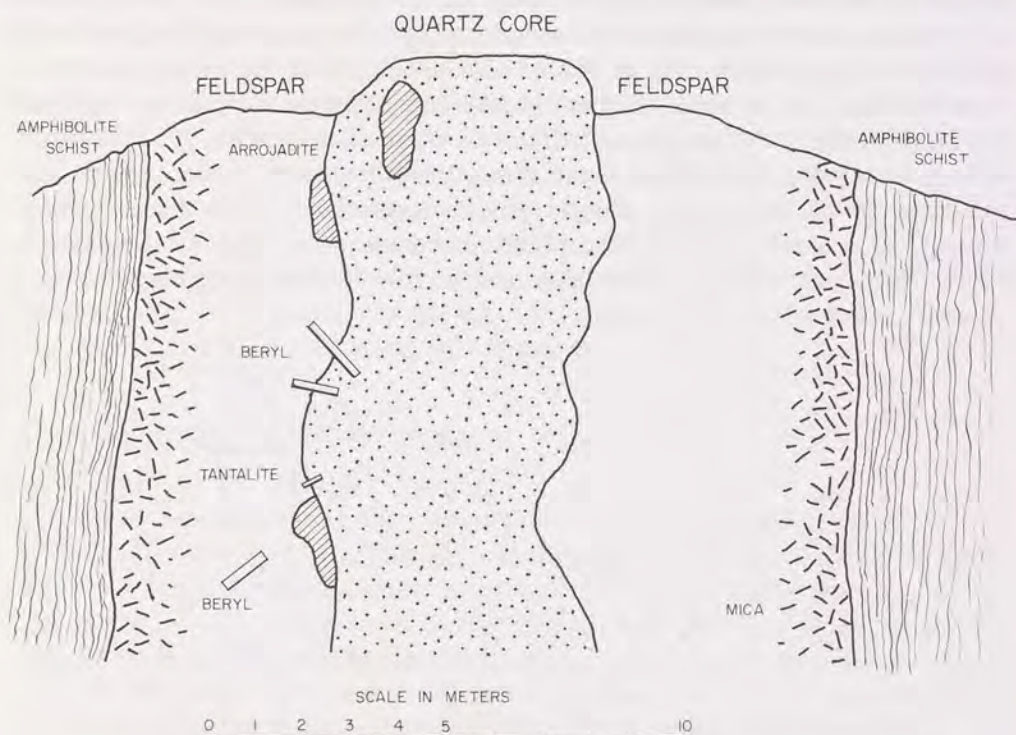

Fig. 13-3 Cross-section of a beryl-bearing granitic pegmatite, Alto da Serra Branca, Paraíba, Brazil. After S. C. De Almeida et al., Pegmatitos com berilo, tantalita e cassiterita da Paraíba e Rio Grande do Norte, *Mineração e Metalurgia* 7 (Rio de Janeiro, 1943):120.

CHEMICAL AND PHYSICAL PROPERTIES

mediate zone of giant feldspar crystals with quartz filling spaces between them, and lastly a central zone or core of massive quartz. Small to large beryl crystals usually occur between the core and the giant feldspar crystal zone just outward from it. There are many deviations from this simplified zoning pattern, but in general it holds good for most of the bodies that have been explored in depth and width.

Most of the beryl is a low-alkali variety, forming crude hexagonal prisms of short to long prismatic habit, seldom well-terminated, and ranging in size from several centimeters in diameter to the giants mentioned above. The colors include pale blue, greenish blue, pale green, yellow, and brownish, with greenish yellow perhaps the most common. For the most part, these hues are so weak that the crystals appear almost colorless and sometimes are mistaken for the ordinary massive quartz which usually accompanies them.

Complex, Zoned and Replaced Bodies

The term *replaced* refers to portions of an original pegmatite body that have been dissolved during late chemical activity and the space reoccupied by new suites of minerals, often of increased variety and complexity. A general feature is the appearance of an inner zone of bladed albite feldspar of the variety known as cleavelandite. This is deposited upon the blocky feldspar-quartz unit and therefore lies between the latter and the core. In addition to cleavelandite, typical species include tourmaline (schorl), iron and manganese phosphates, columbite-tantalite, and other rare-element species. Beryl crystals, commonly of tapered habit (sodium-bearing) and composed of several individual crystals grown together as shown in figure 13-4, occur mainly in the cleavelandite unit. Cavities containing excellent

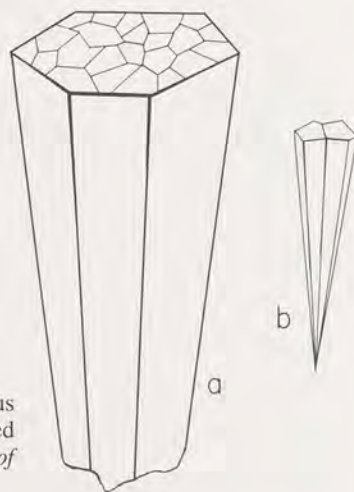

Fig. 13-4 Composite crystal of sodium beryl showing (a) numerous individuals in typical tapered habit and (b) single crystals detached from a large composite crystal. After A. A. Beus, *Geochemistry of Beryllium* (San Francisco: W. H. Freeman, 1966), p. 80.

Beryl Deposits

crystals of beryl and other minerals may occur along the margins of this unit and the quartz core unit.

Additional mineralogical complexity occurs in such bodies where the replacement includes introduction of lithium in the form of the lithium aluminum silicate known as spodumene and the lithium-bearing mica known as lepidolite. Units containing these species occur in inner zones, the lepidolite as masses of fine scaly crystals and the spodumene as lath-like crystals which may or may not protrude into the quartz core. In rare instances, the spodumene crystals may be found in pockets where they are characteristically translucent to transparent, sometimes of fine gem quality and lilac in color (kunzite).

Beryl found within these units is alkali-rich, generally white, colorless, pink, or peach, and may be grown within small vuggy openings in the albite-lepidolite units or take the form of well-shaped tabular to short prismatic crystals within larger openings. A common occurrence of these alkali-rich beryl varieties is as crystals perched on a matrix of white, bladed cleavelandite crystals, sometimes with topaz, colored tourmaline, small crystals of lepidolite, also quartz, and other minerals. Specimens of this kind are highly prized by mineral collectors. As a rule, these beryl crystals rarely exceed several centimeters in diameter, but in some bodies they have been found as tabular to short prismatic crystals as large as 25 cm (10 in) in diameter. In spodumene-albite units these crystals may be pale blue, rarely medium blue, or pale green, colorless, white, or sometimes overgrown with pink zones. In lepidolite-rich units, they tend to be mostly pink to peach or apricot color.

In addition to gem spodumene and beryl, these pegmatites commonly yield gem tourmaline, topaz, and a number of rare species that are the delight of the mineral collector. Pegmatites of this type are common in New England, California, Madagascar, the Ural Mountains, and Brazil.

METAMORPHIC-HYDROTHERMAL

Schist Type Beryl Deposits

These deposits receive their name from the fact that beryl crystals, often of the emerald variety, occur solidly imbedded in dark mica schist rocks, from which they must be painstakingly extracted and cleaned of close-adhering mica scales. The schists and associated rocks in which these crystals are found are the product of a chemical interaction between granitic rocks on one side and basic (silica-poor) rocks on the other, such that the materials necessary for the formation of beryl appear to be derived from granitic pegmatites but are transferred through the sides of such bodies into the adjoining basic rocks. This is the process known as *exometamorphism*, or changes induced in an original rock by introduction of outside constituents. The beryl constituents transferred from the granitic pegmatites, or

CHEMICAL AND PHYSICAL PROPERTIES

from the granite bodies themselves, recrystallize in the schists and thus are said to be exomorphic. Much of this beryl resembles the ordinary type found in the pegmatite bodies, but because the schist rocks are formed partly at the expense of the nearby basic rocks, which sometimes contain chromium, small amounts of this element may be incorporated in the beryl crystal structure and impart the typical rich green hue of emerald.

The usually narrow pegmatite veins present in the contact zone between granitic rocks and basic rocks have two names: Beus² (pp.236-44) calls them "granitic pegmatites of the crossing line" while others refer to them as "desilicated pegmatites," or pegmatites which have been deprived of silica by virtue of the chemical interchange of constituents.

Classic occurrences of schist-type beryl include the emerald deposits in Egypt, Africa, and Austria. The deposits that have been most extensively studied, however, are those in the Ural Mountains, U.S.S.R., which were first discovered in 1831 when emerald crystals were found in outcrop debris. Fersman¹⁴ studied these deposits and in 1929 published his conclusions as to their origin. A more recent study is that of Vlasov and Kutukova,¹⁵ published in 1960. Schneiderhöhn¹⁰ (pp. 123-7) also provides a good summary of these deposits in the Urals.

The general features of the Uralian deposits are swarms of narrow pegmatitic veins and veinlets associated with metamorphosed basic rocks such as amphibole schists, amphibolites, diorites, and serpentinites, the latter further altered in part to talc, chlorite, actinolite, or tremolite schists. The complexity of rock types is well shown in the cross-section shown in figure 13-5. The zones in which these sheet-like bodies occur may be tens of meters across and many hundreds of meters in length along the outcrops. The pegmatite veins usually contain plagioclase feldspar with quartz, sometimes with beryl and other minerals, with the beryl crystals generally being white, pale greenish, or pale yellow in color.

Although some emerald is found in these veins, it occurs more commonly in the schistose rocks adjacent to the pegmatite veins where it formed through the chemical interactions mentioned above. The crystals are usually small in size, rarely over several centimeters in length, although some have been found in the Uralian mines that weighed several kilograms.

In addition to emerald, the schist type deposit is host to the classic alexandrite variety of chrysoberyl, prized by gem connoisseurs for its color-change in cut gems and by mineral collectors for its beautiful twin crystals. As may be expected from the metamorphic origin of both emerald and alexandrite in these deposits, internal cracks and inclusions are numerous, and most of the material found is unsuitable for gem purposes.

Schist type emerald deposits are by far the most numerous sources of these gemstones, although in terms of size and quality of crystals they are overshadowed

Beryl Deposits

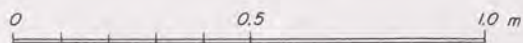
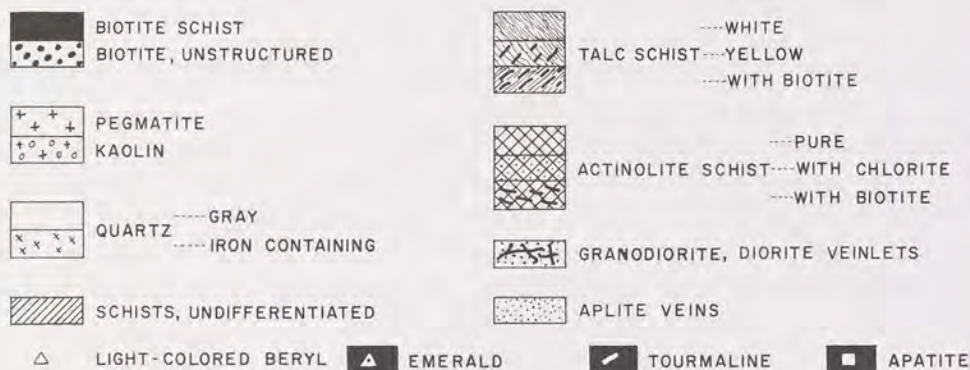

Fig. 13-5 Detailed west to east cross-section of a portion of the emerald series rocks in the emerald deposits on the east flank of the Ural Mountains, U.S.S.R. After a drawing in A. E. Fersman, *Geochemische Migration der Elemente*, Abhandlungen zur praktischen Geologie und Bergwirtschaftslehre 18 (Halle, 1929).

by the Colombian hydrothermal deposits. Many regions are known in which granitic rocks lie adjacent to basic rocks, and it is probable that as these contacts are more fully explored, other schist type emerald deposits will be found.

HYDROTHERMAL

Greisens

The old miners' term, *greisen*, refers to granitic rocks which have been altered along fractures into masses of granular quartz and mica, and often with accessory species as topaz, tourmaline, fluorite, rutile, wolframite and cassiterite, the latter

CHEMICAL AND PHYSICAL PROPERTIES

two species providing ores of tungsten and tin respectively. Beryl occurs in some greisen deposits, commonly in sub-prismatic granular aggregates but at other times as fine crystals in openings in the bodies. Greisens are believed to form by exhalations of gas (*pneumatolysis*) or seepages of heated, mineral-bearing waters from deep-seated igneous rock sources during a process known as *hydrothermal alteration*. The latter is believed to be the more important of the two processes mentioned. Fractures in the host granites provide access to the solutions, and consequently alteration is most complete nearest the original openings, diminishing outward until unaltered granite is met. At times so much granite is removed by the solutions that cavities lined with crystals appear in thicker portions of the bodies (see figure 13-6). Typical minerals found in these openings are quartz, muscovite mica, lithium

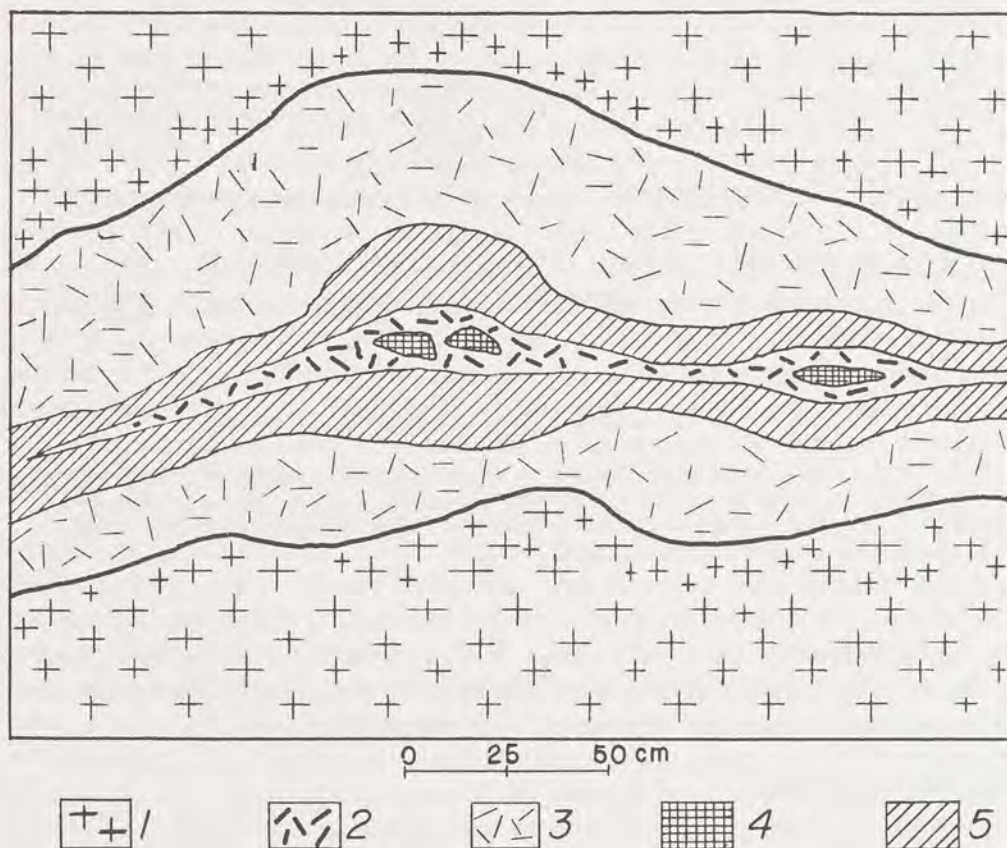

Fig. 13-6 Typical cross-section of a greisen deposit of Sherlovaya Gora, Transbaikalia, USSR. (1) slightly greisenized granite-porphry, (2) beryl crystals in quartz, (3) muscovite-quartz greisen, (4) cavities containing beryl crystals, (5) quartz with topaz, or quartz greisen. After A. A. Beus, *Geochemistry of Beryllium* (San Francisco: W. H. Freeman, 1966), p. 269.

Beryl Deposits

micas, topaz, tourmaline, cassiterite, wolframite, fluorite, apatite, and sometimes beryl. A famous and mineralogically important greisen deposit is that of the Sherlovaya Gora (mountain) in eastern Transbaikalia, U.S.S.R., described in detail by Beus² (pp. 263–80). Beryl crystals from these cavities are magnificent and have received worldwide distribution to collections.

Carbonate Veins and Tactite Bodies

Hydrothermal activity also deposits beryl, among other minerals, along fractures in the carbonate (calcite-rich) rocks of the famous deposits of Colombia, noted for centuries for their production of the world's finest emerald crystals. Details on these deposits are furnished in the section on Colombia in Part 3, and for the moment it is sufficient to say that they are unique. Minerals associated with emerald are calcite and dolomite, derived from the enclosing carbonate rocks, but also albite feldspar, pyrite, quartz, and rarely, parisite, most of the latter species being more typical of granitic sources than the sedimentary rocks in which the veins are emplaced. It is believed that these species have been formed from materials dissolved in hot water issuing from some distant and as yet unrecognized igneous source.

Minor and completely unimportant deposits of beryl occur in *tactites* or *skarns*, names given to bodies of silicate rocks formed by hydrothermal and pneumatolytic activity at the contacts of siliceous rock bodies and carbonate rock bodies. Generally, beryl crystals formed in these bodies are very small and colorless, or nearly so, and provide neither gem rough, mineral specimens, nor ore.

Alpine Clefts

In the alpine regions of Europe, splendid mineral crystals, including some beryl, occur in openings along fractures in rock masses that have been folded and distorted by movements of the earth's crust. The rock crystals from such cavities, or *clefts*, as they are called, have been known since Roman times. From the beginning of known history in these regions, mountaineer-collectors, or as they are known today, Strahlers, have climbed the mountains after snows have disappeared to find clefts exposed by weathering and dig out their treasures. The formation of such clefts is due to hydrothermal activity, the heated water dissolving minerals from various points along the network of cracks and depositing them in places where openings existed or were enlarged by dissolution of the country rock.

Typically, clefts occur in gneisses, a fine-grained metamorphic rock formed mostly from compressed and altered sediments. They are characteristically streaked by light-colored minerals such as feldspar and quartz which more or less correspond to beds in the original sediments that were also rich in these constituents. Unlike carbonate rocks, which are readily dissolved by heated water, gneisses are composed mainly of silicate minerals and are only slowly attacked. For this reason, cavities along the fracture systems are by no means abundant but tend to be narrow

CHEMICAL AND PHYSICAL PROPERTIES



Fig. 13-7 View of an excavated pocket in an emerald-aquamarine vein at the Sharps mine, close to Hiddenite School, Alexander Co., North Carolina. The country rock is unaltered gneiss.

and persistent, and only in a few places are they large enough to permit crystals to grow unimpeded and develop terminations.

A large variety of minerals has been found in alpine clefts, and their occurrences and associations in Switzerland are provided in considerable detail by P. Niggli et al.¹⁶ and for the alpine regions of Italy by De Michele.¹⁷ In some of the clefts small, long-prismatic aquamarine and other light-colored beryls have been found, also bazzite, the rare scandian analog of beryl, which forms very small acicular blue crystals. While emerald has not been reported in European alpine clefts, according to Sinkankas,¹⁸ it appears that the emerald crystals found near Hiddenite, North Carolina (see Part 3, U.S.A) are an alpine cleft occurrence.

SEDIMENTARY DEPOSITS

Important quantities of ore and gem beryl have been found in *eluvial* and *alluvial* sedimentary deposits. The term *eluvial* refers to deposits formed by the decay of deposit outcrops with little or no movement of the minerals from their place of origin, while *alluvial* refers to deposits of clay, sand, and gravel containing

Beryl Deposits

decay products that have been moved by rainfalls to considerable distances from their places of origin.

Eluvial deposits are usually obvious to the trained eye of the prospector because he can detect sharp, glassy crystals or unabraded pieces of rock resting in the soil or in the surface debris, suggesting that their source is underneath or only a short distance away. By far most deposits of beryl have been found merely by examining decayed outcrops (eluvium) and digging beneath the litter to find the original body. Eluvial deposits are characteristic of arid regions where rainfall is insufficient to wash away the evidences of decay, as in northeastern Brazil, southwestern United States, and South West Africa. They are also characteristic of high-altitude regions, such as the Alps, where rocks loosened by cycles of alternate freezing and thawing form slopes covered with rubble where the presence of valuable minerals can be readily detected. A number of eluvial deposits yielding large quantities of beryl are described in Part 3.

Alluvial deposits are less easy to detect because the heavier and more durable minerals tend to settle to the bottom in beds of sand and gravel, and casual inspection is insufficient to show that they exist. However, they have been found in a number of regions in the world, often as a result of searching gravel beds for gold, as in Brazil, or found in valleys below outcrops of deposits where their presence was suspected. Classic alluvial deposits of beryl and other gemstones are widespread over the island of Ceylon, where they have been mined for centuries, also in Brazil, where many hundreds of pegmatite bodies have been completely decayed and their constituents washed into stream and river gravels. Depending on the distance traveled by such outcrop materials, and the violence of the streams that bore them along, alluvial beryl crystals may be only slightly rounded along their edges or completely smoothed so that no traces of crystal faces remain. Because of the pounding that such crystals receive during their movement, the pebbles that finally result tend to be solid and free of fractures and flaws, hence of gem quality in the case of beryls, topazes, tourmalines, and other gemstones.

Literature Cited

1. Goldschmidt, V. 1954. *Geochemistry*. Edited by Alex Muir. Oxford: Clarendon Press. 730 pp.
2. Beus, A. A. 1966. *Geochemistry of Beryllium*. Edited by L. R. Page, translated by F. Lachman. San Francisco: W. H. Freeman. 401 pp.
3. Vlasov, K. A., Ed. 1966. *Geochemistry and Mineralogy of Rare Elements and Genetic Types of Their Deposits*. Vol. 2: *Mineralogy of the Rare Elements*. Translated by Z. Lerman. Jerusalem: Israel Program for Scientific Translations. pp. 67-169.
4. Mason, B. 1966. *Principles of Geochemistry*. 3rd ed. New York: John Wiley & Sons. 329 pp.
5. Buchi, S. 1962. *Studies on the Natural History of Beryl*. Ph.D. dissertation, University of Michigan, Ann Arbor. 170 pp.
6. Cameron, E. N. et al. 1949. *Internal Structure of Granitic Pegmatites*. *Economic Geology Publishing Company Monograph No. 2*. Urbana, Ill.: Economic Geology Publishing Co. 115 pp.
7. Fersman, A. E. 1961. *Les Pegmatites*. 3 vols. Louvain: Librairie Universitaire Uystpruyst (739 pp);

BERYL LOCALITIES

- original Russian ed. publ. in Leningrad, 1931.
8. Lacroix, A. 1922-23. *Minéralogie de Madagascar*. 3 vols. Paris: Augustin Challamel. 624, 694, 450 pp.
 9. Jedwab, J. 1953. Étude des Oligo-Eléments dans les Minéraux des Pegmatites. Doctoral dissertation, Free University of Brussels, Belgium. 158 pp.
 10. Schneiderhöhn, H. 1961. *Die Erzlagerstätten der Erde*. Vol. 2: *Die Pegmatite*. Stuttgart: Gustav Fischer Verlag. 720 pp.
 11. Booyesen, B. 1959. Pegmatites: Hints to Prospectors. *Geological Survey of South Africa Pamphlet No. 6*. 57 pp.
 12. Sinkankas, J. 1970. *Prospecting for Gemstones and Minerals*. New York: Van Nostrand Reinhold Co. 397 pp.
 13. Hurlbut, C. S. 1968. *Minerals and Man*. New York: Random House. 304 pp.
 14. Fersman, A. E. 1929. *Geochemische Migration der Elemente: III. Smaragdgruben im Uralgebirge*. Abhandlungen zur praktischen Geologie und Bergwirtschaftslehre, vol. 18. Halle (Saale): Wilhelm Knapp. pp. 74-116.
 15. Vlasov, K. A. and Kutukova, E. 1960. [*Emerald Mines*]. Moscow: Izdatelstvo Akademiya Nauk SSSR. 252 pp.
 16. Niggli, P. et al. 1940. *Die Mineralien der Schweizeralpen*. 2 vols. Basel: B. Wepf & Co. 661 pp.
 17. De Michele, V. 1974. *Guida Mineralogica d'Italia*. 2 vols. Novara: Instituto Geografico De Agostini. 216, 192 pp.
 18. Sinkankas, J. 1976. *Gemstones of North America*. 2 vols. New York: Van Nostrand Reinhold Co. 675, 494 pp.

PART



BERYL LOCALITIES

*Of all green things which bounteous earth supplies
Nothing in greenness with the Emerald vies
Twelve kinds it gives, sent from the Cythia clime,
The Bactrian mountain, and old Nilus' slime.*

C. W. KING, *Antique Gems*

JERRY L. BOGALDIER

1944 - 1945
1946 - 1947
1948 - 1949
1950 - 1951
1952 - 1953
1954 - 1955
1956 - 1957
1958 - 1959
1960 - 1961
1962 - 1963
1964 - 1965
1966 - 1967
1968 - 1969
1970 - 1971
1972 - 1973
1974 - 1975
1976 - 1977
1978 - 1979
1980 - 1981
1982 - 1983
1984 - 1985
1986 - 1987
1988 - 1989
1990 - 1991
1992 - 1993
1994 - 1995
1996 - 1997
1998 - 1999
2000 - 2001
2002 - 2003
2004 - 2005
2006 - 2007
2008 - 2009
2010 - 2011
2012 - 2013
2014 - 2015
2016 - 2017
2018 - 2019
2020 - 2021
2022 - 2023
2024 - 2025

CHAPTER

14

WORLD SOURCES OF ORE AND GEM BERYL

Chapter 14, which comprises the entire Part III of this volume, contains descriptions of sources of ore, specimen, and gem beryl, arranged alphabetically by country. Within each country, insofar as possible, the sources are arranged from northeast to southwest. The greatest detail has been furnished for countries for which locality information is difficult to obtain or in which deposits of major importance occur. A list of references follows each country, and sometimes references are given for individual states or provinces.

AFGHANISTAN

Complex granitic pegmatites in Nuristan region (figure 14-1) recently furnished beautiful crystals of colored tourmaline; colorless, greenish, pink, and purple spodumene; and various colored beryls. According to Bariand and Poullen,¹ archeological excavations in Badakhshan indicate early Greek settlement of the region, and the unearthing of "perfect crystals and gems of Beryl" suggest that these deposits were known many centuries ago. They also mention an occurrence of emerald, possibly in carbonate-skarn, in Pandjshir Valley, but do not give further details.

Geologists of the USSR conducted the first scientific explorations of the pegmatites of Noor and Paich valleys E of Kunar River, and NE of the town of Jalalabad.² Much beryl was found, including gem aquamarines of a beautiful, intense blue at Gur-Salak in Kunar Province. However,

the splendid tourmalines and spodumenes come from pegmatites which lie along the Alingar River valley in Laghman Province. These are complex bodies of substantial size emplaced in the Nilaw plutonic intrusion.³ Three mines visited by Bariand and Poullen are at Nilaw and Mawi, N and NE of Dahane Pyar, and Korgal NNW of Nuristan, approximately 80 km (50 mi) N of Jalalabad. All are reached by foot trail only. Both the tourmalines and spodumenes are outstanding, but the latter are unique for their size and perfection. Single spodumene crystals of about 1 m (3 ft) in length have been found, and a clear green prism of 60 cm (24 in) is now in the Sorbonne collection in Paris. The beryls are less important, with gem aquamarines and morganites "found mainly in the Laghman district, where they occur with the basal pinacoid characteristically well-developed . . . and loose crystals and crystals on matrix

BERYL LOCALITIES

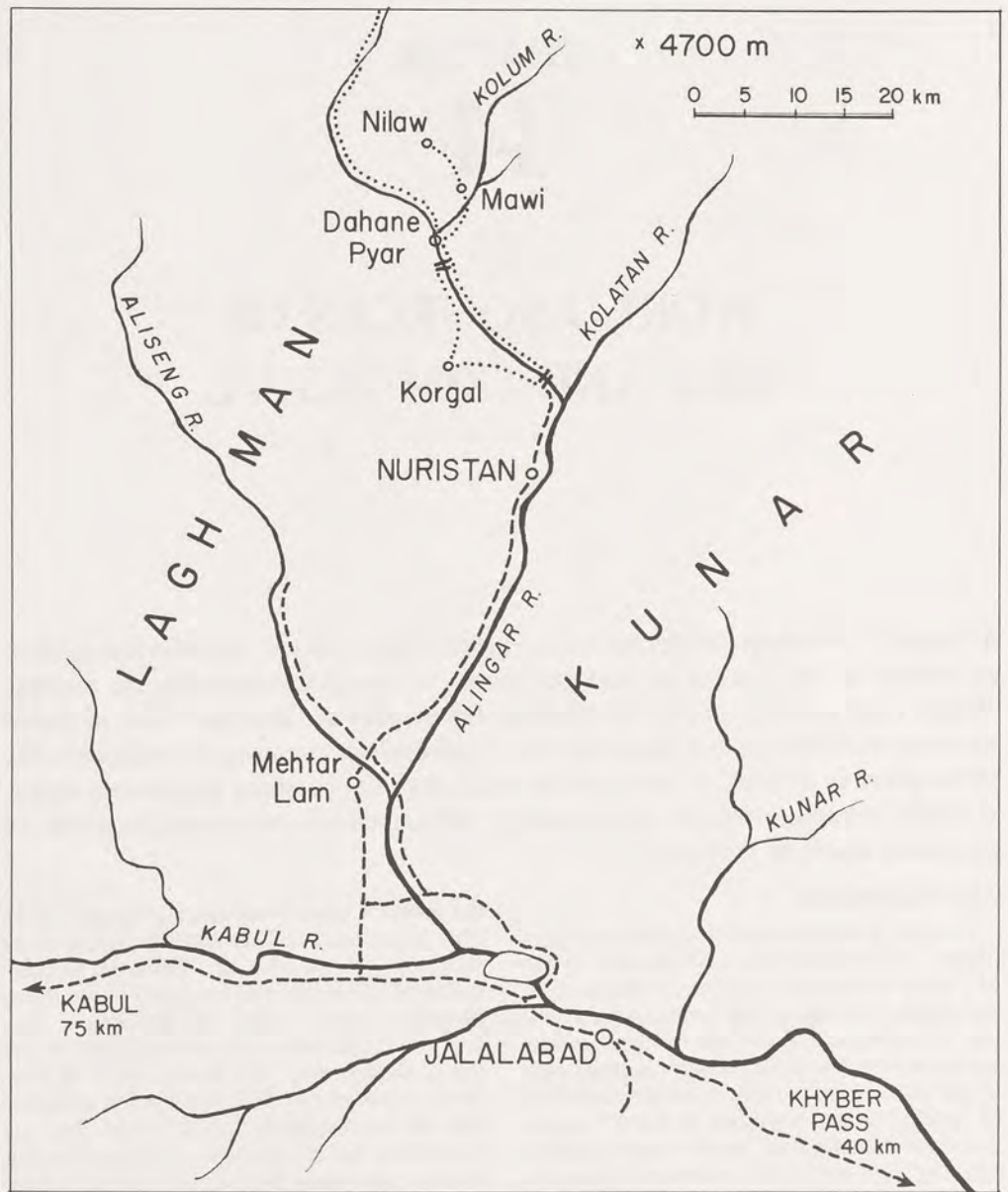

Fig. 14-1 Map of the Nuristan pegmatite region of northeastern Afghanistan. After P. Bariand and J. F. Poullen, "The pegmatites of Laghman, Nuristan, Afghanistan," *The Mineralogical Record* 9 (1978):303.

World Sources of Ore and Gem Beryl / Argentina

have been recovered¹¹ (p. 307). Morganites are pink to brownish-pink and reach 6 cm (2.3 in) in diameter.

1. Bariand, P., and Poullen, J. F. 1978. The pegmatites of Laghman, Nuristan, Afghanistan. *The Mineralogical Record* 9:301-8.
2. Rossovskij, L. N., Chmyrev, V. M., and Salakh, A. S. 1976. Aphanitic dikes with spodumene among lithium pegmatites; conditions of formation. *Doklady Akademii Nauk SSSR (Leningrad)* 226:1418-21.
3. Fuchs, G., Matura, A., and Scherman, O. 1974. Vorbericht über geologische und lagerstättenkundliche Untersuchungen in Nurestan, Afghanistan. *Verhandlungen geologische Bundesanstalt Österreich (Vienna)* 1:9-23.

ALGERIA

The "emerald" from marble near confluence of Oued-Bouman and Oued-Harrach reported by Ville¹ is green Mg-tourmaline.²

1. Ville, L. 1855. Notice sur les gîtes d'émeraude de la haute vallée de l'Harrach. *Compte Rendu de l'Académie des Sciences (Paris)* 41:698-701.
2. Lacroix, A. 1893. *Minéralogie de la France et des ses Colonies*. 5 vols. Paris: Librairie Polytechnique. Vol. 1, p. 109.

ANGOLA

Common beryl has been found in granitic pegmatites mined for mica in Luanda Province;^{1,2} a 14-cm (5.5 in) diameter crystal was found in Mussac-Saca mica mine, 22 km (14 mi) E of Sassa.

1. Murdock, T. G. 1954. The mica deposits and industry of Angola. *U.S. Bureau of Mines Mineral Trade Notes*, Special Supplement to No. 42. 38 pp.
2. Bebiano, J. B. 1946. Jazigos de mica de Angola. *Ministry of Colonies, Memórias, Serie de Geologia Economica*, Lisbon, p. 11-45.

ANTARCTICA

Blueish-green, common beryl crystals 2-4.5 cm (0.5-2 in) in quartz veins are found near Commonwealth Bay, Adelie Land.¹

1. Mawson, D. 1913. Antarctic mineral possibilities. *The Mining Journal (London)* 101:522-3.

ARGENTINA

Ore beryl is a common and commercially important accessory in many granitic pegmatites of Catamarca, La Rioja, San Juan, Cordoba, and San Luis provinces.^{1,2} In Sierra San Luis, tabular bodies reach 300 m (330 yd) long³ and contain greenish-white, yellowish, blueish, and, rarely,

medium blue or reddish crystals of simple hexagonal form.¹ Translucent to opaque crystals are the rule, although partly transparent blue crystals were mined from the Santa Ana deposit, San Luis Province, and gem-quality blue and yellow crystals to 8 cm (3 in) were reported from Acjiras, Rio Quarto, Cordoba Province, where they were found in digging a well. Some common beryl crystals were very large, a giant of 1 × 4 m (3 × 12 ft) was taken from a deposit at Cerro Blanco, 9 km (5.6 mi) E of Tanti, Dept. Punilla, Cordoba Province.

Beryl also occurs in deposits considered by Ahlfeld and Angelelli¹ (p. 201) to be intermediate between granitic pegmatites and hypothermal quartz veins; these typically contain feldspar, biotite, tourmaline, beryl, fluorite, and pyrite at Los Piquillines, El Valle, and Santa Barbara mines near San Martin, San Luis Province. Veins of the San Antonio mine in Catamarca Province are similar, containing mainly quartz, with smaller amounts of wolframite, beryl, tourmaline, pyrite, chalcopryrite, columbite, and molybdenite¹ (pp. 39-40). A similar suite occurs in Esteban mine, Dept. Calamuchita, Cordoba Province.

From 1935 to 1942, Argentina produced 5,429 tons of beryl;⁴ from 1943 to 1956, 8,715 tons averaging 12% BeO;⁵ record year was 1954 when 1,990 tons were mined.

Salta Province

Common beryl occurs at La Poma and Cafayete.⁵

Catamarca Province

Many pegmatites occur near Taco and Ipizca on E slope of Sierra Ancasti in mica schist; some facetable aquamarine is reported. Many pegmatites outcrop on Sierra de Ambato, E of Cerro el Peinado, some of which are noted for gem aquamarine, but production is limited due to difficult access. Also from the Dept. de Ambato at P. Blancas and La Puerta, Huaycama, Los Varelos, La Callada, Colpes. Dept. Ancasti at Ipizca, Ancastilla, La Majada, Anquincila. Dept. Antofagasta in mountains around Ratones. Dept. Capital at La Aguada, Choya, Quadrant 4. Dept. El Alto at Valle Viejo, Santa Cruz, Portesuelo. Dept. Fray M. Esquiú at San Jose, Pomancillo. Dept. La Paz at Ramblones, El Jumial. Dept. Paclin at La Merced. Dept. Poman at Burruyacu, Rincón. Dept. Tinogasta at Los Morteros, Anillacu.⁵

BERYL LOCALITIES

La Rioja Province

Dept. Castro Barros: Pasaje Los Altos district, specifically San Rafael.⁵

San Juan Province

Valle Fertil, Usno de la Huerta, Quebrada del Corral, Quebrado del Corral Grande, Cerro de los Chavez y Gomez, Quebrado del Durazno, Lomas Blancas de la Huerta. Dept. Chavez: La Huerta, Quebrada de la Tunas.⁵

Cordoba Province

Catalano⁵ noted that 261 mines and 472 claims were opened or staked for mica or beryl in departments of Santa Maria, Punilla, Calamuchita, San Javier, Pocho, Rio Cuarto, and Minas. Olsacher⁶ mentioned promising bodies in the area between La Mudana, La Tablada, and Chancani. Alta Gracia district contains three important pegmatite groups: one near Falda de Carmen, ca. 10 km (6.2 mi) N of Alta Gracia, the second in Potrero de Garay, ca. 20 km (12.5 mi) SW of Alta Gracia, and the third near Bosque Alegre ca. 12 km (7.5 mi) NW of Alta Gracia. Several of these bodies were described by Herrera.⁷

Las Tapias mine, Dept. San Javier, 12 km (7.5 mi) NE of Villa Dolores, is famous for production of greenish-yellow or greenish, sometimes pale blue or white beryl crystals and masses up to 80 cm (31 in) diameter. Associates are quartz, muscovite, spodumene, and other species. Las Tapias was worked most intensively during 1939-45, producing 2,402 tons of ore beryl during 1941-45.

Dept. Punilla: principal beryl pegmatites are in districts of Rosario, San Antonio, and San Roque; mines include "6 de Enero" 14 km (8.9 mi) W of Carlos Paz; El Gaucho in Rosario district near km 762 on Cordoba-Salsacate road; Domingo F. Sarmiento in Rosario ca. 8 km (5 mi) W of Cosquin; El Criollo, 7 km (4.2 mi) W of Villa Tanti (noted for abundance of phosphate minerals).^{1,8} Nearby is a body noted for large topaz crystals¹ (p. 228). Important beryl deposits, some with complex mineralization, are located in the Departamento Calamuchita, especially on the E slope of the Sierra de Comechingones.⁹ Other beryl deposits are in the Dept. Calamuchita at La Magdalena mine about 200 m (240 yd) N of Cerro Redondo in the Santa Rosa district; La Felicidad 1.5 km (0.94 mi) S of Cerro Blanco (noted for

fine quartz crystals in vugs); and the Angel and Buena Suerte mines in Alvarez canyon.

San Luis Province

Many beryl-bearing pegmatites occur on the E slope of Sierra de San Luis, which range begins at the city of San Luis and extends about 150 km (94 mi) NE to Sierra de los Comechingones; some contain commercial quantities of ore beryl.¹⁰ Important beryl mines are centered on Rodríguez Saa, La Toma, and Cancarán; also in areas around Quines, San Martín, Paso Grande, Las Palomas, San Luis, La Puerta, Carolina, Santo Domingo, Tilisarao, and Paso del Rey.⁵

In the Dept. Pringles, 100 tons of beryl were mined from Santa Ana pegmatite deposit on the rim of Arroya de la Viboras located about 50 km (31 mi) from the town of 4 de Junio. Other beryl mines are located at Mina Ranquel, Los Aleros (noted for translucent-transparent blue crystals), Cacique, Cachuleta, and Las Palomas near La Carolina. Beryl pegmatites occur in the mountains NE of Rosario Mountains, at Durazno and Totoral NW of El Trapiche, also at the Olga mine 45 km (28 mi) SE of Merlo, in Quebrada Zapalla S of Quines, and near Riojita.^{10,11}

In the Dept. Junín, beryl is mined in Amanda mine, 36 km (22.5 mi) NW of Santa Rosa and in the Salvador group, 20 km (12.5 mi) NNW of the town of San Salvador.

1. Ahlfeld, F., and Angelelli, V. 1948. *Las especies minerales de la Republica Argentina. Instituto Geologia y Minería Publ. No. 458.* Jujuy: Universidad Nacional de Tucuman, 304 pp.
2. Angelelli, V. 1961. El berilo en la República Argentina. *Argentina Comisión Nacional Energía Atómica Informe* 60. 48 pp.
3. Herrera, A. O. 1963. Las pegmatitas de la Sierra San Luis. *Revista de la Asociación Geológica Argentina* (Buenos Aires) 18, no. 1-2, pp. 43-71.
4. Pegmatitas portadoras de berilo. 1954. *Industria Minera*, 12, no. 149, pp. 35-41.
5. Catalano, L. R. 1964. Boro-berilio-litio: una nueva fuente natural de energía. *Estudios de Geología y Minería Económica Serie Argentina*, Buenos Aires, no. 3, beryl: 32 pp.
6. Olsacher, J. 1960. Descripción geológica de la hoja 20h Los Gigantes (Provincia de Córdoba). *Anales Dirección Nacional de Geología y Minería*, 12, (Buenos Aires). 48 pp.
7. Herrera, A. O. 1961. Estructura interna de las pegmatitas micacíferas de Alta Gracia, Córdoba. *Revista de la Asociación Geológica Argentina* 16, no. 1-2, pp. 15-34.
8. Hurlbut, C. S., and Aristarain, L. F. 1969. Berilo de Piedras Coloradas, Provincia de San Luis, Republica

World Sources of Ore and Gem Beryl / Australia

Argentina. *Revista de la Asociación Geológica Argentina* 24, no. 2, pp. 99–104.

9. Rigal, R. 1938. Las minas de colombita y tantalita y el descubrimiento de minerales de uranio en la Cañada de Alvarez, Departamento Calamuchita, Cordoba. *Boletín Dirección de Minas y Geología*, no. 45. 29 pp.
10. Pastore, F., and Gonzalez, R. R. L. 1954. Descripción geológica de la Hoja 23g, San Francisco (San Luis). *Boletín Dirección Nacional de Geología y Minería*, no. 80. 63 pp.
11. Sesana, F. L. 1957. Sobre una fenacita de San Luis. *Revista de la Asociación Geológica Argentina* 12, pp. 197–206.

AUSTRALIA

Aside from a little emerald and aquamarine, major production has been ore beryl. Between 1939–1964, the total ore beryl production was 4,076 long tons, 3,605 of which came from Western Australia. With market demands satisfied, there has been very little production since then.¹

Queensland

In Co. Tate, District Cook, large aquamarine crystals were found with cassiterite at O'Brien's Creek, also "Nine Mile," and Lancewood tin mines 48 km (30 mi) S of Fossilbrook, which is about 155 km (110 mi) SW of Cairns City. Beryl occurs on Quartz Hill, Elizabeth Creek, about 209 km (130 mi) SW of Cairns.² Some aquamarine and common beryl is found in alluvial gold/tin deposits, notably at Brooklands Station, Chillagoe, Co. Lynd, 140 km (75 mi) WSW of Cairns, and at Heberton, Co. Cardwell, 70 km (43 mi) SSW of Cairns.^{2,3} Common beryl is found at Ingola Tunnel, Kangaroo Hills field, North Kennedy district, Co. Wairuna, 62 km (39 mi) SSW of Ingham city. White beryl occurs at Yellow Waterholes, Leichhardt district, Co. Clermont, 368 km (229 mi) WNW of Rockhampton city. Beryl reported from Gympie Road and Lagoon Creek, Caboolture, Moreton district, Co. Canning, 49 km (30 mi) N of Brisbane.²

Some gem aquamarine is found in alluvial tin deposits at several places in Darling Downs district, Co. Bentinck; associates may include diamond, sapphire, spinel, zircon, garnet, tourmaline, topaz, amethyst, and quartz. Specific localities are Hunt's, Quart Pot, Sugarloaf, Lode, Arbouin's, Cannon, Kettle Swamp Creeks, Severn River, and Dolcoath Creek.

Ore beryl is found in pegmatites of the Mica Creek–Galah Creek area, Mount Isa field in NW

Queensland, where pegmatites outcrop in metamorphic rocks along the east margin of the Sybella granite SW of Mount Isa. Crystals up to 1 m (3 ft) have been found. The largest producer has been the Big Beryl mine, Mica Creek.^{4,5,6,7} Beryl is also reported in the molybdenite ore of the Mount Carbine wolframite mine.

1. Kalix, Z., Fraser, L. M., and Rawson, R. I. 1966. Australian mineral industry: production and trade, 1842–1964. *Department of National Development, Bureau of Mineral Resources, Geology & Geophysics Bulletin* 81. 473 pp.
2. Dunstan, B. 1913. *Queensland Mineral Index and Guide*. Queensland Geological Survey Publication 241. Brisbane: Queensland Geological Survey. 1014 pp.
3. Barrie, J., and Kalix, Z. 1959. *Gemstones*. Dept. of National Development, Bur. of Min. Res., Geology & Geophysics Summary Report 42. 42 pp.
4. Australia Department of National Development. 1948. Mineral resources of Australia: Beryllium. *Bureau of Min. Res., Geol. & Geophys. Summary Report*. 18.
5. Brooks, J. H., and Shipway, C. H. 1960. Mica Creek pegmatites, Mount Isa, north-western Queensland. *Queensland Government Mining Journal* 61:511–22.
6. Brooks, J. H. 1963. Galah Creek beryl pegmatites, Mt. Isa mineral field, north-western Queensland. *Queensland Government Mining Journal* 64:371–80.
7. Newman, E. G. 1962. *Beryllium Resources of the British Commonwealth, 1962*. Vol. 1. London: British Commonwealth Geological Liaison Office. 22 pp.

New South Wales

Scattered occurrences in mountain ranges paralleling the E coast, otherwise only ore beryl in Broken Hill district in the W.

Waterworn prismatic crystals, some of gem aquamarine, in cassiterite gravels of the "tin belt" extend S from Co. Bentinck in South Queensland to around Tenterfield, Co. Clive, ca. 113 km (70 mi) NW of Grafton, and also farther S into Emmaville district in Co. Gough, ca. 500 km (310 mi) ENE of Sydney. Around Emmaville, gravels yielded waterworn crystals of quartz, sapphire, topaz, and beryl, the last only slightly worn and of yellowish color. These minerals were derived from weathered cassiterite-bearing greisen veins in the Torington granite.¹ At Heffernan's Lease, ML 52, 5 km (3 mi) W of Torington, a vein of feldspar, biotite, wolframite and beryl yielded some good gem crystals of the last, gems of which were placed in the Australian Museum.² Another source stated that the museum possesses a yellowish-green faceted gem of 73 carats from Heffernan's. Details on the mineralogy of the deposits appear in Lawrence and Markham.³ Ac-

BERYL LOCALITIES

ording to Anderson, Torington beryl crystals measured up to 6×5 cm (2.3×2 in); forms *c* and *m* only.⁴ They were found in soft micaceous vug-fillings associated with feldspar, mica, wolframite, topaz and quartz. Larger crystals contained dark inclusions and others were of "beautiful colour and transparency."⁴ In 1908, or perhaps somewhat later, Mr. Percy Marks, a Sydney jeweler, obtained a quantity of the better crystals and exhibited them at the 1910 Paris Exposition. The most common color was blueish-green, but some were nearly colorless, and many were striated and etched. Average $R. I. o = 1.5685$, $e = 1.5640$, diff. 0.0045.⁴

EMMAVILLE EMERALD. The district is still remembered for emeralds found at The Glen, formerly known as De Milhou's Reef or Cleary's Lode, 9 km (5.5 mi) NNE of Emmaville and discovered during prospecting for cassiterite. This was the first *in situ* Australian emerald deposit found, although other "emeralds" found before were later shown to be merely green beryls.^{5,6} In 1890, D. A. Porter reported emeralds from an old shaft dump at the locality. In 1891 the newly formed Emerald Proprietary Company sank a shaft of 15 m (50 ft) to follow outcrop indications. At this depth, with the emeraldiferous "shoot" pitching slightly NE and requiring a short tunnel at the 10 m (33 ft) level to intercept, David reported no emeralds.⁶ According to Barrie and Kalix emeralds occurred as small crystal concentrations solidly imbedded in a quartzose vein with cassiterite, topaz, fluorite, arsenopyrite and quartz.⁷ Pittman noted that the emeralds were found "intercrystallized with topaz, frequently penetrating crystals of fluor spar, as delicate prisms" or, "embedded in kaolinized felspathic rock, occasionally quite surrounded by massive mispickel, rarely encrusted with crystal of tin-stone, and in one case traversing plates of mica."⁸ In 1890, the discovery year, 2,225 carats were sent to London as a trial shipment and some of the gems were sold for £4.00 per carat. In 1891, 25,000 carats were mined, followed by a like quantity in 1892, but it was reported that "the hardness of the matrix . . . is still a source of difficulty, as it is almost impossible to break down the rock without injuring and frequently destroying the emeralds."⁸ In 1894, the mine was inoperative; after further unsuccessful explorations in depth, all work ceased in 1898. In 1908, mining was revived and 1,000 carats of stones

valued £1,600–1,700 were obtained and sent off to Europe. In 1909, "the largest cut stone weighed 6 carats";⁹ some 50 stones in another parcel were said to be of "fair quality" but the general color was pale.¹⁰ Barrie and Kalix gave a total production of 53,225 carats.⁷ The largest crystal may be that described by David as about 23 carats and 32×11 mm (1.25×0.3 in) but marred by basal cracks.⁶ The largest cut gem reported in 1891 was $2\frac{1}{8}$ carats. In this period about 50 carats of cut gems were offered by the company for from £2/- to £2/2/- per carat for the lot. The largest rough crystal weighed 9 carats. The color was described by Pittman as "varying from the faint shades of green up to moderately bright emerald green, but never showing a very deep shade of green."⁸ He also noted uneven coloration: "in places colourless bands appeared . . . running at right angles to the axis."

Elsewhere, beryl was found in alluvium at Dundee, Co. Gough, 16 km (10 mi) NNE of Glen Innes; also at Elsmore mine, 19 km (12 mi) SSE of Inverell or 47 km (29 mi) WSW of Glen Innes where pale green or yellow hexagonal prisms occurred with cassiterite and quartz in vugs of pegmatite in granite. Some crystals at this location were acicular and not over 25 mm (1 in) long. The deposits lie on the NW side of McIntyre River.^{11,12} Waterworn beryl crystals, some said to be emerald, occurred in gravels of Cope's Creek; also at Tingha, Co. Hardinge, 19 km (12 mi) SSE of Inverell and in nearby Scrubby Gully. They occurred with quartz and feldspar at Ophir, Co. Wellington, 42 km (26 mi) NNW of Bathurst; a transparent yellow crystal of 15 mm (0.7 in) diameter was also reported.¹² Small opaque greenish crystals have been found in Shoalhaven River E of Bungonia or 32 km (20 mi) ESE of Goulburn, Co. Argyle.

In the capital territory, beryl occurs in gneissic dikes on Mt. Tennant summit and at Lanyon W of the mountain¹² as well as near Tharwa, a town about 31 km (19 mi) S of Canberra. An "Emerald" was reported found at Bald Hill, Tumberumba, Co. Selwyn, 112 km (70 mi) SW of Canberra; also at Kiandra, Co. Wallace, 88 km (55 mi) SSW of Canberra and some occur in granite at Cooma, Co. Beresford, 107 km (66 mi) S of Canberra.¹²

BROKEN HILL DISTRICT. An area in Co. Yancowinna and Co. Farnell, centered on the city. Most beryl pegmatites are found in Parish Dhoon

World Sources of Ore and Gem Beryl / Australia

WSW of Broken Hill.^{13,14} In Eurioiwrie district, 67 km (42 mi) N of Broken Hill, Parish Byjerkerno, Co. Farnell, massive white Cs-beryl with quartz and amblygonite occurs in the Trident mine, which yielded 2 tons of 10% BeO ore in 1956. Minor beryl is found in pegmatites at Skilbacks, 13 km (8 mi) NW of Broken Hill and in an area ca. 5 km (3 mi) N of the city. A pegmatite 1 km (0.5 mi) E of the racecourse produced some ore beryl. Beryl is found in pegmatites W and SW of Thompsons Tank, 42 km (26 mi) NNE of Broken Hill.¹⁵ Major ore beryl production from Egebek or Thackeringa field 40 km (25 mi) WSW of Broken Hill occurs in well-zoned complex bodies containing nigrine, monazite, zircon, columbite, manganotantalite, tantalite, davidite, etc.^{13,16} Much of the beryl was picked up from the outcrops. The Triple Chance mine, ML 25, that opened in 1946, produced 105.78 tons of glassy, flawed green, brown or blue-green prisms up to 120 cm (4 ft) long and 45 cm (18 in) wide from 1944 to mid-1959 with average BeO 12.6%. Small radiate groups of slender yellow crystals from this mine attracted mineral specimen collectors.¹⁶ From the Lady Beryl mine, ML 30, 4 km (2.5 mi) S of the Triple Chance, which is 600 m (660 yd) long and up to 73 m (80 yd) wide, 12 tons of crystals were taken, some projecting "like fenceposts" from the ground. The largest recorded crystal was 3 m (9.5 ft) long and about 1 m (3 ft) diameter. The beryl tended to be greenish, brownish-green, and "honey" brown, with BeO content 12.66%. Radiate sprays of small slender beryl crystals were also found as well as a peculiar red garnet "moulded on to tapered prismatic shells of yellow beryl on cores of albite and quartz."¹⁶ The Spar Ridge body, ML 34, is 3 km (2 mi) E of the Triple Chance and produced 0.80 ton of 12.5% BeO ore. Pearce's, or No. 2 prospect, located midway between Triple Chance and Spar Ridge, is 240 m (800 ft) long and up to 82 m (270 ft) wide; it yielded mostly small crystals although some up to 61 cm (2 ft) long were found.¹³ Nearby are: Baker's Prospect, 2 km (1.25 mi) N of Triple Chance; Egebek, ML 20 and ML 24, 3 km (1.25 mi) SSE of Triple Chance—the largest quarry in the district, but one with negligible beryl production; McKenzie's Prospect, 0.5 km (0.3 mi) NW of Triple Chance (small beryl crystals); ML 27, 0.8 km (0.5 mi) SE of Triple Chance (many small crystals);¹³ long narrow pegmatite containing large

brown crystals about 3 km (2 mi) N of Triple Chance.¹⁶

1. Ramdohr, P. 1969. Aus meinen mineralogisch-geologischen Reisen. Teil II., Australien. *Der Aufschluss* (Heidelberg) 20, no. 5, pp. 113–26.
2. Smith, G. 1926. A contribution to the mineralogy of N.S.W. Geological Survey of New South Wales Mineral Resources 34 (Sydney).
3. Lawrence, L. J., and Markham, N. L. 1963. The petrology and mineralogy of the pegmatite complex at Bismuth, Torrington, New South Wales. *Journal of the Geological Society of Australia* 10:343–64.
4. Anderson, C. 1920. Mineralogical notes, No. X. Beryl, Torrington, N. S. Wales. *Records of the Australian Museum* 13:1–13.
5. Clarke, W. B. 1860. *Researches in the Southern Gold Fields of New South Wales*. Sydney: Geological Survey New South Wales. 305 pp.; "Gems, metals and other minerals associated with gold alluvia," App. B., p. 271.
6. David, T. W. E. 1891. Report on the discovery of emeralds in the Vegetable Creek District. *Annual Report of the Department of Mines, N. S. Wales, for 1891* (Sydney) pp. 229–34, 284.
7. Barrie, J., and Kalix, Z. 1959. Gemstones. *Summary Report of the Australia Bureau of Mineral Resources, Geology & Geophysics* No. 43 (Canberra) 42 pp.
8. Pittman, E. F. 1901. *The Mineral Resources of New South Wales*. Sydney: Geological Survey of New South Wales. 487 pp.
9. Emeralds in New South Wales. 1910. *The Mining Journal* (London) 89:405.
10. Rose, G. 1960. Gemstones. Chapter in *The Mineral Industry of New South Wales*. Sydney: Geological Survey of New South Wales, Dept. of Mines. 20 pp.
11. *New South Wales Intercolonial and Philadelphia International Exhibition*. 1875. Mines and Mineral Statistics of New South Wales. Sydney: T. Richards. 252 pp.
12. Liversidge, M. A. 1888. *The Minerals of New South Wales*, 3rd ed. London: Trübner & Co. 326 pp.
13. Wynn, D. W. 1960. Recent developments in beryl mining in the Broken Hill district, New South Wales. *Annual Report of the Geological Survey of New South Wales, Department of Mines*, pp. 51–60.
14. Newman, E. G. 1962. Beryllium resources of the British Commonwealth, 1962. *British Commonwealth Liaison Office*, 1. London: 22 pp.
15. Rayner, E. O. 1960. Beryllium. *Geological Survey of New South Wales, Mineral Industry of New South Wales*. No. 6. 10 pp.
16. Johnson, J. E. 1956. Specimen minerals of the Egebek pegmatites, near Broken Hill. *The Australian Amateur Mineralogist* (Woodville West) 2:5–7.

Victoria

Stone cites vague references to "emerald" in Pilot Creek, Dargo River, Dry Creek and in Mansfield area.¹ Talent mentions "emerald" as "rare" in gold gravels of Daylesford, Upper Yarra River and Donnelly's Creek NE of Wallahalla.²

BERYL LOCALITIES

1. Stone, D. 1967. *Gemstones of Victoria*. Melbourne: The Jacaranda Press. 125 pp.
2. Talent, J. A. 1970. *Minerals, Rocks and Gems. A Handbook for Australia*. Milton, Queensland: The Jacaranda Press. 287 pp.

Tasmania

Colorless to blueish-green crystals reported on Flinders Island. At Mt. Cameron waterworn hexagonal prisms several cm in diameter of dull green color occur in cassiterite gravels. Crystals to 25.5 cm (10 in) long and 5 cm (2 in) diameter occur in pegmatite 450 m (500 yd) N of the Republic mine, Ben Lomond, 52 km (32 mi) SE of Launceston.¹ Promising ore beryl in tin-tungsten deposits of Moina district, N Tasmania.²

1. Petterd, W. F. 1894. A catalogue of the minerals known to occur in Tasmania, with notes on their distribution. *Royal Society of Tasmania, Papers and Proceedings for 1893* (Hobart), pp. 1-72.
2. Newman, E. G. 1962. *Beryllium Resources of the British Commonwealth, 1962*. Vol. 1. London: British Commonwealth Geological Liaison Office. 22 pp.

New Zealand

Pale blue 7 × 3 mm (0.5 × 0.02 in) crystals reported in quartz vein cutting granite between Canaan depression and S shoulder of Mt. Pisgah, Pikipiruna Range, Nelson, S. Island.¹ Also common beryl near Charleston, Nelson; at Dusky Sound and on N side Paterson Inlet on E coast of Stewart Island.²

1. Watters, W. A. 1963. Zoned blue beryl from the Canaan area, Pikipiruna Range, Nelson. *New Zealand Journal of Geology and Geophysics* 6:715-17.
2. Morgan, P. G. 1927. Minerals and mineral substances of New Zealand. *New Zealand Survey Branch, Department of Scientific and Industrial Research Bulletin*, n.s. 32 (Wellington).

Northern Territory

Common beryl occurs in many pegmatites of Macdonnell Ranges which run E-W just N of Alice Springs. In commercial mica pegmatites of Harts Range, Plenty River region centered on Harts Range Mica Depot, located 129 km (80 mi) NE of Alice Springs, here a "mica belt" extends over 97 km (60 mi) and 3-13 km (2-8 mi) wide with granitic pegmatites intruded into schists and gneisses of the Irindina and Brady formations; beryl crystals occur in wall and intermediate zones.¹ However, beryl was abundant only in the Disputed mine on E slope of Mt. Palmer, 8 km (5 mi) S of the depot. An early miner's tale claimed that enormous crystals of black tourma-

line and beryl were found in a large vug called the "Jewellery Cave," in which aggregates of beryl-tourmaline reached 120-150 cm (4-5 ft) diameter. Joklik noted that a cave-in sealed this chamber, to which access is now lost.¹ The Disputed mine was also noted for abundant prismatic beryl inclusions in mica, with the *c*-axes of the beryl "generally parallel to some crystallographic direction of the muscovite."¹ Walters found fine vug crystals of black tourmaline, one of 3.6 kg (8 lb) with quartz and muscovite in dumps of a mica pegmatite located about 16 km (10 mi) S of Harts Range.² He also found beautiful greenish, golden, or bluish beryl crystals, with some clear facetable areas. Hodge-Smith mentioned a "beautiful crystal some 8 cm in diameter and 17 cm in length . . . in the main of gem quality."³ Joklik stated "by far the best specimens of the field occur in the Disputed mine, which contains both blueish green (aquamarine) and yellow beryl" but noted that "both varieties are extensively fractured."¹

Elsewhere in the area common beryl in: Spotted Tiger mine, 6 km (4 mi) SSW of the depot; Eastern Chief mine, 9.6 km (6 mi) E of depot; Caruso mine on E slope Mt. Palmer 9.6 km (6 mi) S of depot; Princess Elizabeth mine at foot of Miller's Knob 14.5 km (9 mi) ENE of Plenty River Crossing in which tourmaline and beryl occur together in large microcline masses; Dinkum mine, 14.5 km (9 mi) NE of Plenty River Crossing; Kismet mine.^{1,4,5,6}

1. Joklik, G. F. 1955. The geology and mica-fields of the Harts Range, Central Australia. *Australia Department of National Development, Bureau of Mineral Resources, Geology and Geophysics Bulletin* 26 (Canberra) 226 pp.
2. Walters, D. R. 1957. Mineral showcase: tourmaline from the Harts Ranges, Northern Territory. *The Australian Amateur Mineralogist* (Woodville West) 3:43.
3. Hodge-Smith, T. 1932. Geological and mineralogical observations in Central Australia. *Records of the Australian Museum* 18:415-42.
4. Australia Department of National Development, 1948. Mineral Resources of Australia, Beryllium. *Bureau of Mineral Resources, Geology and Geophysics, Summary Report* 18 (Canberra).
5. Newman, E. G. 1962. *Beryllium Resources of the British Commonwealth, 1962*. Vol. 1. London: British Commonwealth Liaison Office. 22 pp.
6. Buchester, K. J. 1965. *The Australian Gemhunter's Guide*. Sydney: Ure Smith. 215 pp.

South Australia

Common beryl in small crystals occurs in granitic pegmatites near Granite Downs Station, Ev-

World Sources of Ore and Gem Beryl / Australia

erard Ranges, 300 km (186 mi) NNW of Oodnadatta in NW corner of the state but difficulties of transport and the small size of crystals make the deposits uneconomical.^{1,2} Far more important deposits are beryl-bearing pegmatites, intruding schists, gneisses, and amphibolites along the flanks of Boolcoomata granite pluton about 20 km (12 mi) N of Olary, the latter located ca. 340 km (210 mi) NNE of Adelaide. Forbes³ located 40 bodies on a sketch map and showed swarms of pegmatites in the following places near the Bimbowrie Homestead: around Triangle and Bimba hills 11 km (7 mi) NNE of Bimbowrie Homestead (10 localities); in Wiperaminga Hill area 28 km (17.5 mi) ENE of the homestead (16 localities); S of Binberrie Hill 15 km (9.5 mi) ESE of the homestead (10 localities); S and SSE of the homestead (14 localities), the last being plotted and described in greater detail by Forbes in another paper.⁴ Sources W of Boolcoomata around Wiperaminga Hill are also described by Forbes.⁵

In general, Olary beryl crystals reach 12.5 cm (5 in) in diameter and 30–180 cm (1–6 ft) in length but are too clouded and flawed for gems.⁶ By contrast, most bodies contain crystals not over 10 cm (2.5 in) in diameter and correspondingly long. Until 1957, the district yielded 61.5 tons of ore beryl.⁴ Specimens of blueish-green and yellowish-green beryls were analyzed by Kleeman.⁷

Good cuttable aquamarines and more deeply colored beryls were found in pegmatites near Williamstown, 38 km (24 mi) ENE of Adelaide. Mawson reported an occurrence of slender emerald crystals, only 3 mm diameter, from aplitic tourmaline-bearing granite on the S bank of South Para River, SE of Williamstown,⁶ an area originally prospected for emerald in 1900.⁸ A pegmatite swarm, some bodies containing beryl, lies between Gumeracha, 30 km (19 mi) ENE of Adelaide, and Williamstown and has been described by Winton⁹ and Dickinson.^{10,11}

1. Wegener, C. F. 1949. *South Australia Mines Department Mining Review* (Adelaide) 90:160–2.
2. Newman, E. G. 1962. *Beryllium Resources of the British Commonwealth, 1962*, vol. 1. London: British Commonwealth Geological Liaison Office. 22 pp.
3. Forbes, B. G. 1958. Beryl in the Olary Province. *South Australia Mines Department Mining Review* 109:25–30.
4. ———. 1959. Beryl deposits in South Australia. *South Australia Mines Dept. Mining Review* 108:8–12.
5. ———. 1959. Beryl occurrences—west of Boolcoomata Homestead. *South Australia Mines Dept. Mining Review* 108:13–15.
6. Mawson, D. 1955. Gem-bearing gravels at Barossa. *The Australian Amateur Mineralogist* (Woodville West) 1:113–5.
7. Kleeman, A. W. 1944. On the analysis of beryl from Boolcoomata, South Australia. *Transactions of the Royal Society of South Australia* (Adelaide) 68:122–4.
8. Australia Department of National Development. 1948. Mineral resources of Australia, Beryllium. *Bureau of Mineral Resources, Geology and Geophysics Summary Report* 18 (Canberra).
9. Winton, L. J. 1935. *South Australia Mines Department Mining Review* 60:43.
10. Dickinson, S. B. 1943. *South Australia Mines Dept. Mining Review* 76:80–1.
11. ———. 1945. *South Australia Mines Dept. Mining Review* 80:100–2.

Western Australia

This area is the principal source in Australia of the ore beryl. 1010.24 long tons were produced up until the end of 1947,¹ 267 long tons in 1959, and 181.6 long tons in 1960.² Numerous beryl-bearing pegmatites occur over much of the western portions with notable concentrations in Port Hedland, Wodgina district. State mineralogy, including pegmatite minerals, is treated in detail in Simpson's monumental work with beryl discussed, particularly in vol. I, pp. 195–207.

In Kimberley Division, Kimberley Gold Field, minor ore beryl occurs in Kathleen Valley, and at Mt. Dockrell, and W. Kimberley.^{2,4} In the north west division the Port Hedland, Wodgina district is a field lying S of Port Hedland and covering an estimated 15,000 square miles in which many complex pegmatites occur containing such rare-element species as stibiotantalite, tapiolite, ixiolite, manganomossite, ilmenorutile, struverite, nigrine, etc. Accessories also include lepidolite, muscovite, tourmaline, beryl, topaz, spodumene, amblygonite, lithiophilite, petalite, etc.¹ Several beryl-bearing bodies are W of Marble Bar or ca. 140 km (85 mi) SE of Port Hedland. Tom Malloy's claim, 4.8 km (3 mi) SW of Wallyreena Station produced 7 tons of beryl. At Tabba Tabba, on ML 312, 64 km (40 mi) SE of Port Hedland, were found milk white to colorless crystals several cm in diameter.³ One of the Tabba Tabba bodies is 700 m (775 yds) long and 15–60 m (16.7–66 yd) wide and provided niobotantalates, beryl, microlite and simpsonite. Other bodies in this group contained lepidolite and cassiterite with beryl, or manganocolumbite

1. Wegener, C. F. 1949. *South Australia Mines Department Mining Review* (Adelaide) 90:160–2.
2. Newman, E. G. 1962. *Beryllium Resources of the British Commonwealth, 1962*, vol. 1. London: British Commonwealth Geological Liaison Office. 22 pp.
3. Forbes, B. G. 1958. Beryl in the Olary Province. *South Australia Mines Department Mining Review* 109:25–30.
4. ———. 1959. Beryl deposits in South Australia. *South Australia Mines Dept. Mining Review* 108:8–12.

BERYL LOCALITIES

with beryl.¹ Float beryl occurs at Kangan and at McPhee's Range at Pilgangoora. Barrie and Kalix reported 8.7 carats of emerald were cut from crystals from McPhee's Hill.⁵ At Strelley, 48 km (30 mi) SE of Port Hedland, many pegmatites in amphibolitic rocks were found, one body being 700 m (775 yd) long and 30–200 m (33–220 yd) wide and containing some beryl.¹ According to Simpson, beryl is "plentiful" in a large body 6.4 km (4 mi) E of Mt. Francisco, with accessory manganocolumbite. The beryls are pale green and from 5–45 cm (2–18 in) long and 20 cm (8 in) diameter; forms are *c* and *m*, some with small $s\{11\bar{2}1\}$.³ Beryl occurs also in detritus at this locality and from nearby tantalum pegmatites.² Up to the end of 1945 the Mt. Francisco area produced 46 tons of ore beryl in well-formed pale green crystals.¹

The Wodgina locality (21°25'S, 118°30'E) or about 113 km (70 mi) S of Port Hedland, is world-famous among mineral collectors. By the end of 1947 a pegmatite body 610 m (2,000 ft) outcrop length and averaging 15 m (50 ft) wide yielded 710 tons of ore beryl. Sullivan noted that by 1948 workings had been extended to a depth of 30 m (33 yd).¹ Enclosing rocks are Precambrian Warrawoona-series banded quartzites, schists, metabasalts and amphibolites. In addition to common beryl, the Cs-variety was also found along with tantalite, apatite, spessartine and smoky quartz. Simpson noted that ML 86 at Wodgina produced white Cs-beryl in formless masses to 9 kg (20 lb) which was transparent in outer layers.³ He also remarked on very small hexagonal prisms of emerald that were found on a plain about 3 km (2 mi) NW of the Wodgina Tantalite mine. Some colorless topaz (?) was reported from the Stannum mine, ML 79, but may have been beryl. Cs-beryls from Wodgina were analyzed by Simpson who found in a white specimen $G=2.72$, $o=1.581$, $e=1.575$; a gray beryl gave $G=2.79$, $o=1.588$, $e=1.582$.³

Beryl has been mined in the Ashburton district.²

The Yinnietharra pegmatite field is located within a north-pointing bend of Gascoyne River, ca. 240 km (150 mi) E of Carnarvon city. By 1945 this field had produced 76.7 tons of ore beryl and in 1960 another 95.65 tons, much of it from detritus.^{1,2} According to Johnson, who lists mine tonnages, claims, and prospects, the largest producers were MC 392H and 393H on a pegmatite body 760 m (2,500 ft) long and 180

m (600 ft) wide.⁶ Simpson mentions milk-white to pale green prism, not of gem quality, from the right bank of Morrissey Creek, SW of Morrissey Hill on MC 39H; the crystals were 30 cm (12 in) in diameter and about the same in length.³ Bowley provides three analyses of Yinnietharra beryl and the following data: for a pale green gem aquamarine, $G=2.73$, $o=1.5825$; a white beryl, $G=2.73$, $o=1.5825$; clear grayish beryl, $G=2.72$, $o=1.5820$.⁷

POONA EMERALD. Poona (27°10'S, 117°25'E) in Murchison Gold Field, lies ca. 64 km (40 mi) NW of town of Cue, the latter ca. 355 km (220 mi) NE of Geraldton. A pegmatite field here is roughly 6.4 km (4 mi) \times 3.2 km (2 mi) in size and oriented along a NW–SE line; it contains numerous granitic pegmatites intruded into Archaean greenstones surrounded and invaded by granites. The greenstones include amphibolites, hornblende and chlorite schists, and the latter are penetrated by epidiorites, dolerite, and serpentine dikes. Along contacts with pegmatites the hornblende schist is commonly altered to biotite schist to a thickness of about 60 cm (2 ft). The pegmatites range from 30 cm (1 ft) to about 9 m (30 ft) in width and consist mainly of albite, quartz and microcline, the quartz sometimes forming cores in the larger bodies. Associates are biotite, muscovite, lepidolite, zinnwaldite(?), topaz, tourmaline, fluorite, cassiterite, manganocolumbite and monazite. In general, the larger bodies with cassiterite do not contain beryl, but in ML 45 cloudy green beryl was plentiful, the crystals attaining 9 cm (3.5 in) in diameter, although most were under 2.5 cm (1 in). Branching from such bodies were much smaller pegmatitic veins and offshoots seldom more than 15 cm (6 in) wide and of no great length. These passed in places into discontinuous strings of small lenses of feldspar, quartz or beryl, accompanied by isolated crystals of beryl within the flanking biotite schists. It is the latter beryl that provides emerald, but crystals in this rock range from almost milk-white in all degrees of diaphaneity to weak to strong emerald color.

The Poona emerald crystals are commonly well-developed hexagonal prisms, sometimes striated and exhibiting forms *c*, *m* and rarely $s\{11\bar{2}1\}$. Only the small crystals were of gem quality. Simpson's analysis found 0.23% Cr_2O_3 , very small amounts of Fe, Mn, and Mg, and a substantial quantity of alkali, i.e., 0.48% Na_2O . $G=2.69$, $o=1.578$, $e=1.573$.^{3,8}

World Sources of Ore and Gem Beryl / Australia

The Poona field was first prospected for cassiterite in 1909 and the first emerald found by Paddy Ryan. A. Montgomery, State Mining Engineer, independently found emerald a few months after Ryan.⁹ In 1912, H. P. Woodward, Assistant Government Geologist, examined the field and in 1914 published a report with a map.¹⁰ He found several good crystals and had the best cut in Sydney, obtaining 9 faceted gems weighing from 0.7 to 2.6 carats and some cabochons from 6 to 18 carats. In 1912, J. Pearl, a Perth jeweler, formed a syndicate which proceeded to spend £1,000 opening one of the prospects to a depth of 15 m (50 ft), obtaining "many thousands of carats of emeralds, though of such mediocre quality as to be commercially valueless."³ However, two fine crystals among the lot furnished a 5-carats gem sold to the Montana Sapphire Syndicate for £100 and later resold for £170; the second stone was cut into five "very choice" gems, the largest of 1.25 carats. In 1914, the Montana Sapphire Syndicate prepared to spend £5,000 to develop the property, but World War I intervened and put a stop to these plans.³

The field remained dormant until 1927 when Star Emerald Syndicate, Ltd., Lewis Marks, engineer and manager, acquired five leases and commenced mining. During that year 5,500 carats of rough were sent to London, one parcel containing a 40-carat crystal. One of the better crystals sold in the U.S.A. for \$750.¹¹ The latter statistics differ from those produced by Simpson that cover Poona emerald production in carats and value from 1927 until cessation of mining in 1930.³

According to contemporary accounts, Star Syndicate acquired ML 79 in 1927, recovering 4,700 carats with 8 men at work.¹² In the same year a shaft was sunk to 46 m (150 ft), and at 24 m (79 ft) emeralds were found. Adjoining ground was exploited by Transvaal Financial Trust.¹³ By 1928, the Star Syndicate shaft on ML 79 had reached 52 m (171 ft).¹⁵ In 1936, the old workings were reopened and shoots of emerald-bearing biotite schist were encountered at a depth of 50 m (165 ft). In regard to size and quality of crystals, "the finest stone seen from this field [by Simpson] was obtained by H. Mandestam in 1928"³ and was a prism of 20 × 6 × 4 mm imbedded in a small quartz veinlet in biotite schist. Furthermore, "it was of a deep rich green colour, perfectly transparent and possessing very few flaws."³ Elsewhere on the Poona field, ore beryl in the amount of 24.53 tons, all from eluvial deposits, was obtained during 1944–1945, with an opinion expressed that direct production from pegmatites probably would be unprofitable.⁶

Elsewhere in Western Australia, beryl float was reported at a point 64 km (40 mi) S of Mt. Magnet and at Dalgara, 72 km (45 mi) NE of Yalgoo.^{2,3} The Coodardy pegmatite field, located ENE of Cue, includes a cassiterite pegmatite carrying a little beryl in translucent, faint green prisms of small size.³ Beryl pegmatites occur in the Basin, an area 4 km (2.5 mi) N of Melville in Yalgoo Gold Field, Murchison. Several emerald deposits are known here although most beryl found is the common variety. The field is characterized by lit-par-lit intrusions in gneissic granite and amphibolite of scores of veins of microcline-quartz pegmatite. Beryl occurs in twelve bodies as formless masses to 18–23 kg (40–50 lb) and well-formed prisms from 25 × 5 cm (10 × 2 in) long and up to 40 cm (16 in) diameter, as in ML 26. In this last lease, masses of rich blue beryl were found on the S side of Ridge "S" of the Basin; the beryl occurs with topaz. In this area were also prismatic crystals of beryl of small size, 2–20 mm in diameter, ranging from white to true emerald color, but none were considered suitable for gems. "The best emeralds are in the biotite schist, as they are at Poona,"³ according to Simpson, who also noted color zoning in several crystals. One had an almost colorless outer zone; another had emerald on the exterior but almost colorless material within. A vein several km N of the Basin also contained emeralds of poor quality but usually well formed; larger

Table 14-1
POONA EMERALD PRODUCTION, 1927–1930

Year	Leases Held	Area (acres)	Carats	Value in £
1927	14	296	200 (cut)	421
1928	21	452	17,564 (rough)	910
1929	15	296	609 (rough)	278
1930	7	139	3,750 (rough)	?

BERYL LOCALITIES

crystals were 5 cm (2 in) in diameter but only translucent at best and pale in color. Many crystals displayed 12 to 18 prism faces with broad $m\{10\bar{1}0\}$, much narrower $i\{21\bar{3}0\}$, or rarely $a\{1120\}$ faces. Simpson states that: "Beautiful specimens have been obtained here of long, semi-transparent, green crystals (up to 80×5 mm) penetrating vitreous quartz or large cleavage masses of milk white cleavelandite."¹³ In addition he provides an analysis of Cs-Rb beryl from Melville and the following data for it: $G = 2.74$, $o = 1.584$, $e = 1.5785$.

Beryl occurs in a quartz vein carrying molybdenite, feldspar and mica at Mt. Singleton, 280 km (170 mi) SE of Geraldton in S end of Yalgoo Gold Field.³

Ore beryl occurs in pegmatites of Perth-Mundaring region NE and SE of Perth. Small crystals can be found on the W side of Chittering Valley, just S of Mooliabene Hill, S. Bindoon, ca. 70 km (43 mi) NNE of Perth. At Toodyay, 77 km (48 mi) NE of Perth, small crystals occur on the E end of Deepdale Estate. In Jimperding Valley, 88 km (55 mi) NE of Perth, small crystals in pegmatite occur about 1.6 km (1 mi) above the junction of the valley with Swan River valley. Float beryl occurs in Grass Valley, 80 km (50 mi) ENE of Perth. At Mundaring, 45 km (28 mi) SE of Perth, small amounts of ore beryl were mined.² The latter occurs also in pegmatite on the right bank of Darkan River, 8 km (5 mi) NE of Mt. Dale.³

In the south west division of the state a field of granitic pegmatites containing cassiterite and/or beryl lies SE of Bunbury. Minor occurrences are at Yabberup and W of Kirup. Beryl pegmatites may be found on MC 85H just SW of railroad station of Mullalyup. At Greenbushes, 80 km (50 mi) SSE of Bunbury beryl is found in cassiterite-bearing veins such as in Cornwall mine on S side of the town. At Balingup, 64 km (40 mi) SE of Bunbury, on the Ferndale Estate, large quantities of common beryl in crystals up to 63 kg (170 lb) were found in two large pegmatites.³ In 1933, Lord Rayleigh determined helium content from a sample of this deposit.¹⁵ The field yielded 10 tons of ore beryl by the end of 1944.⁴

There are several pegmatite fields in the central division of the state, particularly in the Coolgardie Gold Field. Scahill's feldspar quarry or the General Craig mine, ML 80, an opening on a large microcline body, lies about 20 km (13 mi)

S of Coolgardie at Londonderry and is famous for its complex mineralization and abundance of the rare mineral petalite, here found in gem quality. Beryl is present in small amounts along with lepidolite, zinnwaldite, pucherite, eastonite, muscovite and albite.^{3,16} Light blue and white zoned crystals occur in Mt. Marion pegmatite E of Londonderry. A zoned crystal gave property data as follows: light blue core, $o = 1.586$, $e = 1.577$; cloudy white margin, $o = 1.588$, $e = 1.576$.¹⁷ Tomich mentions a spodumene pegmatite due S of Kalgoorlie on Hampton Plains that contains beryl crystals to 5 cm (2 in) diameter.¹⁸ According to Hunt, in an area ca. 1.6 km (1 mi) S of Spargoville in the Coolgardie Gold Field, a microcline pegmatite was mined for columbite-tantalite but also contained marketable quantities of ore beryl. In the same location were also found some gemmy aquamarine crystals of greenish hue up to 7.5 cm (3 in) long and white beryl crystals associated with quartz.¹⁹

A small amount of lithium beryl was recovered from spodumene pegmatite at Cattlin Creek, 2 km (1.3 mi) from Ravensthorpe, Phillips River Gold Field, or about 265 km (165 mi) NE of Albany. Associated species included elbaite, spodumene, quartz, micas and amblygonite.^{3,20} Beryl occurs in pegmatite near Bellinger Lakes, Eucla Division, N of Cape Paisley.³

1. Australia Department of National Development. 1948. Mineral resources of Australia. Beryllium. *Bureau of Mineral Resources, Geology and Geophysics Summary Report 18* (Canberra).
2. Newman, E. G. 1962. *Beryllium Resources of the British Commonwealth, 1962*. Vol. 1. London: British Commonwealth Geological Liaison Office. 1. 22 pp.
3. Simpson, E. S. 1948-1952. *Minerals of Western Australia*. 3 vols. Perth: Government Printer. Beryl in vol. 1, pp. 195-207; incidental notices in vol. 3.
4. Western Australia Government Mineralogist. 1945. *The Mineral Resources of Western Australia*. 5th ed. Perth. 27 pp.
5. Barrie, J., and Kalix, Z. 1959. Gemstones. *Australia Bureau of Mineral Resources, Geology and Geophysics Summary Report 43*. 42 pp.
6. Johnson, W. 1951. The beryl resources of the Yinetharra area, Lyons district, northwest land division of W. Australia. *Annual Report of the Geological Survey of Western Australia for 1948, 1951* (Perth) pp. 12-17.
7. Bowley, H. 1948. Beryl. *Annual Report of the Government Mineralogist, Analyst & Chemist, Western Australia for 1945*, pp. 17-18.
8. Simpson, E. S. 1925. The occurrence of common and precious beryl at Poona. *Annual Progress Report, Geological Survey, Department of Mines, Western Australia for 1925*, p. 177.

World Sources of Ore and Gem Beryl / Austria

9. Discovery of emeralds in Western Australia. 1913. *Mining Journal* (London) 100:304.
10. Woodward, H. P. 1914. A geological reconnaissance of a portion of the Murchison Gold Field. Geological Survey of Western Australia Bulletin 57.
11. Emeralds from Australia. 1927. *The Jeweler's Circular* 157.
12. Discovery of emeralds. 1927. *Mining Journal* 157:286, 310.
13. Western Australia. 1927. *The Mining Journal* 158:802.
14. Star Emerald Syndicate, Ltd. 1928. *The Mining Journal* 160:41.
15. Rayleigh, Lord. 1933. Beryllium and helium I. The helium contained in beryls of varied geological age. *Proceedings of the Royal Society of London A* 142:370-81.
16. Le Mesurier, C. R. 1944. Minerals occurring in a felspar deposit, Londonderry, and in vicinity of Tantait Hill. *Annual Report of the Government Mineralogist & Analyst, Western Australia, for 1941 & 1942*, App. II., p. 18.
17. Grubb, P. L. C. 1964. On beryl from Western Australia. *Journal of the Royal Society of Western Australia* (Perth) 47:51-3.
18. Tomich, S. A. 1956. Report on a spodumene-bearing pegmatite on Hampton Plains location 53, south of Kalgoorlie, Western Australia. *Geological Survey of Western Australia, Annual Progress Report for 1953*, pp. 11-2.
19. Hunty, L. E. de la. 1954. Report on pegmatite at Spargoville, Coolgardie, G. F. *Geological Survey of Western Australia, Annual Report for 1951*, pp. 35-6.
20. Sofoulis, J. 1955. Report on Cattlin Creek spodumene pegmatite, Ravensthorpe, Phillips River Gold Field, Western Australia. *Geological Survey of Western Australia, Annual Progress Report for 1952*, pp. 45-8.

AUSTRIA

Lower Austria

Beryl crystals in pegmatite veins at Marbach, NW of Krems.¹

Upper Austria

Crystals in alluvial pegmatite blocks in fields of Zissingdorf near Freidstadt N of Linz.^{2,3}

Styria

Spodumene-beryl pegmatite in Wildbachgraben, 3 km past the village of Wildbach;⁴ in granitic pegmatites at Kreuzberg near Köflach; in the Packwinkel at Stampf; at Gössnitzberg;^{5,6} in pegmatites around St. Radegund near Graz.⁷

Carinthia

Grube Peter pegmatite mine near St. Leonhard, Saualpe was mined for muscovite and contains beryl, apatite, xenotime, monazite and zircon.^{1,8,9}

Pegmatitic phases of granite near Villach contain beryl, fluorite, apatite, tourmaline and arsenopyrite.⁸ Minor beryl, with several rare-element species, occurs in a large feldspar quarry above Edling, close to Spittal An der Drau; many granitic pegmatites are in the area.^{10,11}

Salzburg

All beryl occurrences are confined to the N slopes of Hohe Tauern mountain range, which lies E-W ca. 80 km S of Salzburg. Near Rauris beryl occurs in veins under the "Keestrachter".¹² Near Badgastein aquamarine occurs with quartz and calcite in biotite granite; at Bockstein on Rathauserberg, small pale blue crystals, sometimes dark blue or greenish occur;¹ Similar crystals occur in Fuschertal in massive quartz with blue lazulite.¹³ On Kreuzkogel good green crystals occur in quartz veins. On the N side of Goldberg-Gruppe mountains in Nassfelde and in Amertal and Anlaufthal other beryls occur.¹

References to aquamarine crystals in pegmatite schlieren or in aplite bands within the central gneiss region are numerous;^{1,13,14,15} the zone of occurrences is narrow and straight, running from Abichalpe in Untersulzbachtal through Untersulzbachtal ridge, and across Habach Valley, the Habachtal ridge, the downslope partly into Hollersbachtal. The crystals are small and generally frozen in quartz-feldspar. Colors range from pale blue to medium blue.

HABACHTAL EMERALD. Habachtal is one of the oldest known and most famous deposits, and may have been known to the Celts and the Romans. The Romans are said to have sent prospecting teams into the Alps where they discovered emerald in the alluvium of the lower Habachtal.^{16,17,18,19,20} The emerald site was called "Mountain of Green Jewels" by the natives, and there is evidence suggesting that the Archbishop of Salzburg caused the deposit to be worked sometime in the Middle Ages. A mining chronicle of 1727 mentioned the deposit as belonging to the Duchy of Bavaria, which controlled the region at the time.

According to Gübelin (p. 342),¹⁷ Empress Maria Theresa (1717-80) owned an inkwell the size of man's fist sculptured from a Habachtal emerald. This may have been the emerald unguent jar, sculptured by Dionysio Miseroni in about 1642 from what is certainly a Colombian crystal, that is now in the treasury in Vienna.

BERYL LOCALITIES

Very large emerald crystals from this locality seem to be unheard of, Eberl suggesting that the largest may be a crystal fragment in the Hofmuseum in Vienna that measures only 3.5 cm long and 2×3 cm wide, "which because of its size, far exceeds those found hitherto"²⁰ (p. 17).

Mineralogical-geological descriptions of the deposit appeared in the 18th century with the first accurate account published in the early 1800s. In 1862, the Viennese jeweler Samuel Goldschmidt (1810–1871) obtained rights to the deposit, and in 1863 he commissioned the mining official M. V. Lipold to investigate. From then on the mine was worked by Goldschmidt in a systematic and profitable manner, using a number of tunnels to follow the emerald-bearing schist, which by now was recognized as the true matrix of the emerald. A contemporary praised Goldschmidt's campaign and stated that "he found, among others, a large

and beautiful emerald that weighed 42 carats after cutting and today is among the English crown jewels"²⁰ (p. 19). Upon Goldschmidt's death in 1871, his son-in-law, a Mr. Brandeis, inherited the rights, but having no interest in mining, he allowed the workings to fall into ruin. Shortly thereafter, the mineral collector-guide of Bramberg, Alois Wurnitsch, succeeded in interesting an English company, "Limited Forster," to work the mine profitably with about 20 to 30 men.

Following this period, another English concern, Emerald Mines, Ltd., secured rights for 1896–1913. Despite a statement that up to 1905 the mines "were being worked by a few hands by some London diamond cutters, but in a somewhat dilatory fashion," it was also shown that such "dilatory" work managed to produce "no less than 68,000 carats . . . turned out by six miners in less than four months, notwithstanding



Fig. 14-2 *Left*: view of the Habachtal emerald mine area, taken from the west slope of the valley and showing the steep, rugged terrain. The black arrow marks the mine itself. Below the small snow patches is the area of debris exploited by collectors seeking emeralds, as shown in the righthand photograph. *Courtesy Dr. Heinz Weininger, Leoben, Austria.*

World Sources of Ore and Gem Beryl / Austria

the antiquated mining methods employed."²¹ Eberl stated that 32,000 carats of impure and 7,000 carats of good stones were sent back to London in 1903, the English then sending the rough to India from whence they returned to the market as "Indian emeralds" (p. 20).²⁰ Mining by this last concern ceased in 1913.

During World War I and for some years after, the deposit was worked sporadically by several small firms but with poor results.^{20,22} In 1932, the property was auctioned off at a low price to the newly-organized Schaffhausener Smaragd AG of Zürich, who worked the mine with great energy, driving a gallery of 120 m (110 yd) and accomplishing other profitable improvements. It was said that one crystal found by them realized 20,000 gold kroner. World War II again put a stop to mining temporarily, but it was shortly resumed by the Germans until they were dispossessed after the war and the property was assigned to the Salzburg Government. The latter leased the mine to Colonel Hans Zieger, who, with several assistants, worked it in modest but profitable fashion for several years up to his death.¹⁷ Very little formal mining has been done since, save for occasional clandestine operations. In this connection, Dohmen gave an amusing account of how an ambitious and knowledgeable local group managed to work the mine secretly in the middle of a particularly severe winter. After driving a tunnel many meters through an enormous snow drift, they met the rock tunnel exactly as planned and proceeded to extract many fine specimens. These were sold, *sub rosa*, for months afterward at good prices.²³ In the same reference, Dohmen states that smaller churches in the region own altar ornaments decorated with emeralds from the deposit. Bölsche notes that many Salzburg families, particularly those in the Pinzgau, own traditional jewelry set with local emeralds and with smoky and clear quartz from the Hohe Tauern.²⁴ Further details on the history of the deposit, its owners, operators, and productions, as well as much local color, are to be found in Eberl's work.²⁰

The deposit is located on the side of Legbach ravine, about 2100 m (6800 ft) above sea level, just below the Legbach Scharte (gap) on the crest of a ridge known as the Habachkamm as shown in figure 14-3. The Legbach ravine drops W into the main Habachtal (valley); the latter then descends N to join the valley of the Salzach River

at the hamlet of Habach. The nearest town is Bramberg on the Salzach, about 70 km (44 mi) SW of the city of Salzburg. The mine is reached via foot trail to the site of the former Alpenrose shelter (destroyed by avalanche in 1970) and from there via an increasingly steep trail that zig-zags to the mine.

Leitmeier provides the most extended and detailed scientific account of the emerald deposit and its minerals.¹⁴ Studies of minerals are also given by Bölsche^{15,24,29} and others.^{30,31} The deposit lies along the contact between the Central Gneiss of the Hohe Tauern and amphibolitic rocks as shown in figure 14-4. A zone is present at the contact representing reaction and injection rocks; these are exposed just below the gap in the ridge and consist of footwall amphibolite, aplite veins, biotite layers, talc, and talc-biotite layers, tremolite-actinolite schists, chlorite schists, and quartz, grading into injection gneisses and thence into the normal Central Gneiss which forms the hanging wall. Similar rocks, probably of the same complex, outcrop on the other side of the ridge E of Hollersbachtal where some good emeralds were also found 50 m (55 yd) below the gap during an unusually snow-free summer.³² The rock units in the tunnels are somewhat less complex and comprise an aplite zone, biotite schist, discontinuous tremolite schist, talc schist, and amphibolite.

Emeralds and beryls occur primarily in biotite schists, as verified by Leitmeier's comment that his "many years [of] investigations have shown that emerald-beryl crystals occur principally in biotite-schists and also in talc-tremolite-actinolite schists, but in these last three, only in the immediate vicinity of biotite-schist" (p. 322).¹⁴ On the whole, the Habachtal deposit is remarkably similar to an emerald deposit of the same type in the Urals.

Associates of emerald and beryl include biotite, oellacherite (a Ba-mica), tourmaline, quartz, talc, dolomite, pyrite, galena, and more recently bertrandite, chrysoberyl and a remarkable facet-grade phenakite have been found.^{30,31} The beryl is mostly of the emerald variety, but even crystals of other hues such as white, gray, and dirty greenish, which are often varicolored in the same crystal, show traces of typical emerald color. Clear crystals of emerald, and clear patches of emerald hue in other crystals are usually only about 3 mm across and uncommonly 6 mm.²⁴ The crystal mor-

BERYL LOCALITIES

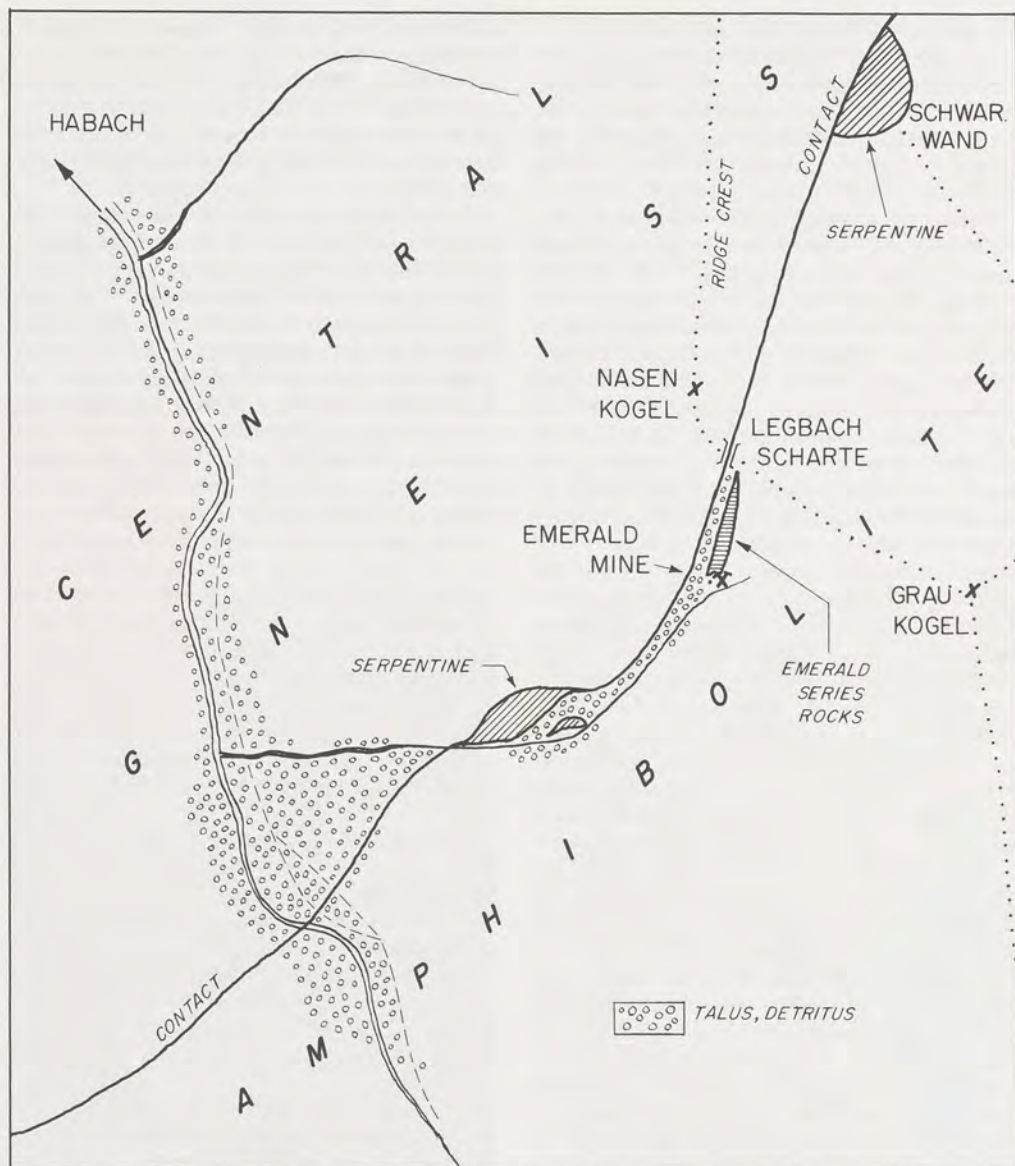

Fig. 14-3 Upper part of Habachtal showing broad geological relationships. Based on a map of H. Leitmeier, Das Smaragdorkommen im Habachtal in Salzburg und seine Mineralien, *Tschermak's Mineralogische und Petrographische Mitteilungen* 49 (1937):245-68 (Fig. 4).

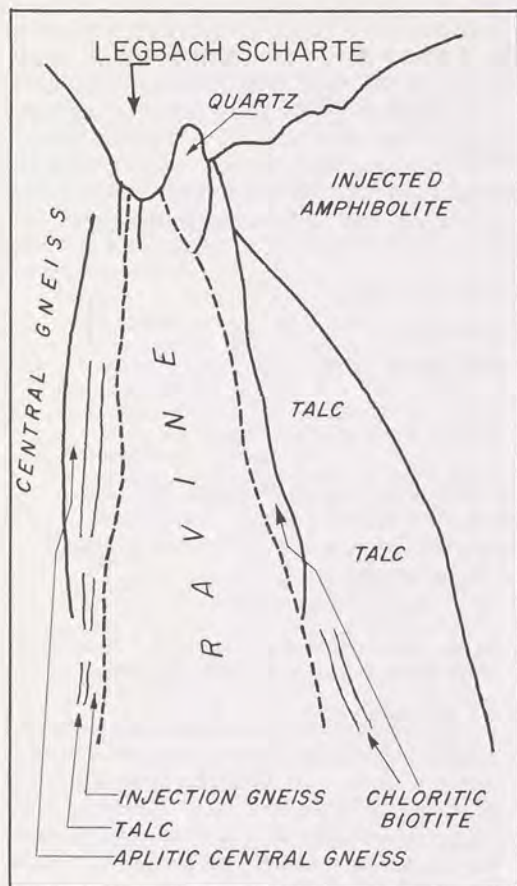

Fig. 14-4 Rock outcrops below Legbach Gap near the Habachtal emerald mine. Based on a sketch map of H. Leitmeier, *Das Smaragd-vorkommen im Habachtal in Salzburg und seine Mineralien, Tschermak's Mineralogische und Petrographische Mitteilungen* 49 (1937):268 (Fig. 7).

phology is extremely simple, only the first-order prism m and base c being present, with the latter well-developed on only about 5% of the crystals. Prism faces are usually sharp, but at times opposite pairs are overdeveloped giving a flattened aspect. Sizes are extremely variable; Leitmeier claimed that he had never seen a crystal less than 1 mm long, even during microscopic examinations of matrix, while the largest crystal seen by him was an opaque greenish prism 12×2 cm (8.75×0.8 in).¹⁴ However, the average size is only 5–25 mm (0.25–1 in) long.

During an extended study of Habachtal emeralds, Gübelin¹⁶ tested eleven cut gems ranging in weight from 0.26 carats to 15.35 carats to determine physical and optical properties. He found that the specific gravity ranged from 2.7203 to

2.7670 with an average value of 2.7415. Refractive indices ranged between extremes of $o=1.58514$ – 1.5970 and $e=1.5781$ – 1.5901 , the averages being $o=1.59075$ and $e=1.5837$, with differences ranging from 0.0069 to 0.00708, average 0.00702. The dichroism was typically yellowish-green and blue-green. Absorptions in the spectrum were normal for wavelengths of 6830, 6800, 6620, 6460, 6370 and the band 6300–5800 Å and very strong for all lines in only one specimen. Under the Chelsea filter, the stones assumed a red or pink color while under the Stokes fluorescent filter, the colors ranged from distinct red to strong red. All stones were inert under 3650 Å ultraviolet radiation and under 2537 Å UV only one stone displayed a weak red fluorescence. This is in contrast with the findings of Leitmeier¹⁴ who

BERYL LOCALITIES

Table 14-2
LEITMEIER'S CHEMICAL ANALYSIS AND PROPERTIES OF HABACHTAL EMERALD¹⁴

	<i>Percent</i>	<i>Specific Gravities</i>
SiO ₂	63.54	1. 2.764, white, translucent
Al ₂ O ₃	17.25	2. 2.758, pale yellowish-green, translucent
BeO	13.07	3. 2.749, pale green, translucent, very small biotite inclusions
Fe ₂ O ₃	0.71	4. 2.735, clean, green
Cr ₂ O ₃	0.12	5. 2.732, green gem, some inclusions
CaO	0.78	6. 2.704, green, nearly clean
MgO	0.84	7. 2.703, dark green gem, nearly clean
Na ₂ O	1.42	
K ₂ O	0.14	
H ₂ O	2.97	
Total	100.84	R.I. (Na) for 6. above: $\sigma = 1.5790$, $e = 1.5740$, diff. -0.005 ; for 7. above: 1.5819 , 1.5769 , diff. -0.005 . Dichroism in pale crystals, $\sigma =$ yellow-green, $e =$ blueish-green; in darker crystals, green and blue-green.

indicated that all specimens tested by him fluoresced a weak green under ultraviolet light.

Habachtal emerald crystals are noted for a ready cleavage along basal planes. The appearance of such cracks soon after removal from the rock led to the erroneous conclusion that "drying out" caused such cracks. Various means were adopted to "season" the gems, such as treating with oil or keeping the stones in darkness. However, Leitmeier was firmly of the opinion that such cracks were always present and merely became visible when entrapped water evaporated.¹⁴ Inclusions are abundant in most crystals, being predominantly small flakes, booklets of brown to pale green, or even colorless biotite. These are followed in abundance by dark green tremolite in fine needles or sometimes platelets. Other inclusions include tourmaline, apatite, epidote, sphene, rutile, and gas and gas-liquid, the latter typically forming veils, feathers, and cloudy areas. When such are particularly dense, crystals appear whitened.

The green color is attributed to chromium, as shown by the analysis 0.12% Cr₂O₃ in table 14-2. Another determination gave 0.16% for a very dark green specimen. A spectroscopic search for vanadium found only a suggestion of a V-line. Bölsche studied distribution of color in crystals²⁸ and noted that color seems not to be influenced

by the nature of the enclosing rock.²⁴ In terms of color quality, the green hue is considered excellent.^{16,17}

At present the Habachtal mine is not being operated. The workings consist of tunnels at several levels, with the lower levels inaccessible because of slumping.²⁸ As described by Weisbach, however, who devoted nearly an entire monograph to the deposit, its workings, and history, the dumps and eluvial material below the deposit continue to attract collectors.³³ Outside the main deposit, small but good emerald crystals have been found in biotite schist next to a serpentine mass farther down the Legbach ravine and near the Habach brook.

Tyrol

Acicular aquamarine crystals in divergent groups of simple hexagonal prisms, 3-40 mm long, occur in vugs in gneiss containing aplitic schlieren in the Zillertal Alps; associates are adularia, albite, pericline, quartz, rutile and carbonates. Localities include Kraxentrager, Feldkopf, Plattenkopf, Melkerscharte, Kleine Mörchner, Lapenspitz and Rosswand. In the W part of these alps, beryl occurs in granite at Pfitscher Joch in 2 cm long crystals, 2-3 mm thick, translucent pale blue, whitish or greenish in color. At Rat-schluges it may occur with tourmaline in granitic

World Sources of Ore and Gem Beryl / Bolivia

rock.¹ Pale blue crystals occur on Troieralpe between the Prägraten and Teferegen valleys. Emeralds reported from Grauenwand occur as prisms in quartz and mica schist similar to finds at Habachtal except that the mica schist is composed of larger plates of mica. The schists pass into talc schists which carry only small emeralds and pyrite. The locality is given as just S of the Habachtal deposit and separated from it by the Tauern mountain chain.¹

1. Zepharovich, V. von. 1859–1893. *Mineralogisches Lexicon für das Kaiserthum Österreich*. 3 vols. Vienna: Wilhelm Braumüller I (1859) 627 pp.; II (1873) 436 pp.; III (1893) 478 pp.
2. Neminar, E. 1875. Ein neuer Fundort von Beryll. *Tschermak's mineralogische und petrographische Mitteilungen* (Vienna) p. 208.
3. Scharizer, R. 1880. Vorkommen von Mikroklin, Razumowskin und Beryll im Gebiete von Freistadt in Oberösterreich. *Jahrbuch der K.-Königl. Geologischen Reichsanstalt* (Vienna) 30:593–608 (beryl pp. 598–9).
4. Höller, H. 1959. Ein Spodumen-Beryll-Pegmatit . . . im Wildbachgraben. *Mitteilungsblatt, Abt. für Mineralogie am Landesmuseum Joanneum* (Vienna) 1:19.
5. Tornquist, A. 1930. Alpine Berylliumerzlagerstätten. *Metall und Erz* 27:177–9, 362–5.
6. Krajicek, E. 1956. Ein neues Beryllvorkommen von der Pack. *Carinthia, Mitteilungen des Naturhistorischen Landesmuseums für Kärnten* (Klagenfurt) Sonderheft 2, 20:93–4.
7. Angel, F. 1933. Spodumen und Beryll aus dem Pegmatiten von St. Radegund bei Graz. *Tschermak's mineralogische und petrographische Mitteilungen* 43: pp. 441–6.
8. Meixner, H. 1956. Die Uranmineralvorkommen Österreichs. *Atompraxis* 2:233–9.
9. Thommen, E. 1967. Mineralogische Exkursionen im Gebiet der Saualpe (Kärnten). *Der Aufschluss* (Heidelberg) 18:240–2.
10. Meixner, H. 1951. Zur erzmikroskopischen Unterscheidung der Tantalit-Tapiolith-Phasen. *Neues Jahrbuch für Mineralogie* (Stuttgart) Monatsheft pp. 204–18.
11. Angel, F., and Meixner, H. 1953. "Die Pegmatite bei Spittal an der Drau" in Gesteine, Erz- und Mineralagerstätten Kärntens. *Carinthia, Mitteilungen des Naturhistorischen Landesmuseums für Kärnten* 2:165–8.
12. Berwerth, F., and Wachter, F. 1899. Mineralogisches und Geologisches aus der Umgebung des Sonnblick. Vol. 1: Die Minerale der Rauris. *Sonnblick-Vereines, Jahresbericht für 1898*, pp. 12–39; beryl p. 19.
13. Haberlandt, H. 1936. Einige interessante Mineralfunde aus der Hohen Tauern. *Tschermak's min. u. petr. Mitt.* 47:393–7.
14. Leitmeier, H. 1937. Das Smaragd-vorkommen in Habachtal in Salzburg und seine Mineralien. *Tschermak's min. u. petr. Mitt.* 49:245–368 (beryl pp. 303–32).
15. Bölsche, R. 1959. Neues aus dem Habachtal. *Der Aufschluss* 10:84–7.
16. Gübelin, E. J. 1956. Emerald from Habachtal. *Journal of Gemmology* 7:342–61.
17. ———. 1956. The emerald from Habachtal. *Gems & Gemology* 8:295–309.
18. Bauer, M. 1904. *Precious Stones*. Translated by L. J. Spencer. London: Charles Griffin & Co. 627 pp.
19. Ball, S. H. 1931. Historical notes on gem mining. *Economic Geology* (Lancaster, Pa.) 26:681–738.
20. Eberl, R. 1972. *Smaragde—Segen und Fluch*. Vienna: private publ., 105 pp.
21. Thompson, A. 1906. Emerald mines of Austria. *The Mining Journal* 78:857.
22. Kunz, G. F. 1929. Precious Stones. Chapter in *The Mineral Industry, During 1928* Vol. 37. New York: McGraw-Hill Book Co. pp. 512–37.
23. Dohmen, H. 1969. Der Stein aus der Höhe kam. *Das Edle* (Birkenfeld) 8:7–9.
24. Bölsche, R. 1955. Das Smaragd-vorkommen im Habachtal. *Der Aufschluss* 6:158–65.
25. ———. 1954. Das Smaragd-vorkommen im Habachtal. *Der Aufschluss* 5:106–12.
26. ———. 1957. Weitere Beobachtungen am Habachtal-Smaragd. *Der Aufschluss* 8:145–9.
27. ———. 1957. Neue Beobachtungen am Habachtal-Smaragd. *Zeitschrift der deutschen Gesellschaft für Edelsteinkunde, Schlossmacher Festschrift* (Idar-Oberstein) pp. 18–23.
28. ———. 1958. Der Beryll vom Habachtal. *Der Aufschluss* 9:117–9.
29. ———. 1962. Ein beachtenswertes Smaragd-Kristall-Aggregat (Neues aus dem Habachtal, II). *Zeitschrift der deutschen Gesellschaft für Edelsteinkunde* 38:20–6.
30. Niedermayr, G., and Kontrus, K. 1973. Neue Funde von Phenakit, Bertrandit und Chrysoberyll aus Salzburg, Österreich, und über die Verbreitung von Be-Mineralfundstellen in den Ostalpen. *Annalen der naturhistorische Museum zu Wien* 77:7–13.
31. Niedermayr, G. 1978. Phenakit in Edelsteinqualität aus dem Habachtal, Salzburg (Österreich). *Zeitschrift der deutschen gemmologischen Gesellschaft* (Idar-Oberstein) 27:205–7.
32. Weiss, L. 1936. Neue Mineralfunde aus dem Habachtal. *Tschermak's min. u. petr. Mitt.* 48:289–91.
33. Weisbach, K. 1971. *Smaragde, such sie selbst*. Salzburg: Verlag das Bergland Buch. 192 pp.

BOLIVIA

At Chacapa, Cordillera Real, granitic pegmatites contain bottle-green crystals to 5 cm (2 in) long, superficially altered to muscovite.¹ Emerald has long been rumored to exist in Bolivia according to *The Mining Journal*, which in 1844 referred to "emerald mines of Illimani" located on the river of the same name near the shores of Lake Titicaca in "Upper Peru."² A Mr. Page of the London firm of Rundell & Bridge was sent to Bolivia to buy and operate gold mines and the

BERYL LOCALITIES

emerald mine. While the gold mining was reported as profitable, the "emeralds" were of "inferior" character. Two decades later, the same journal extolled the virtues and future of Bolivia and mentioned an "emerald" mine that was once worked in the Province of Pacages.³ No other source mentions emeralds or even beryls in this region.

1. Ahlfeld, F., and Muñoz Reyes, J. 1943. *Los Minerales de Bolivia*. 2nd ed. La Paz: Dirección General de Minas y Petróleo. 267 pp.
2. Gold and emerald mines of Upper Peru. 1844. *The Mining Journal* 14:146.
3. Bolivia and its resources. 1864. *The Mining Journal* 34:358.

BRAZIL

Localities where beryl is found are confined to a series of highlands more or less parallel to the coastline of E Brazil, in a region that is maturely weathered, low in elevation, and heavily vegetated, except in the NE corner where aridity prevails. Granitic pegmatites of all types are abundant and widespread, many so deeply weathered that their feldspars have been altered to clays and the more durable constituents, including gemstones, have been released to the soil. Basement rocks in which the pegmatites are intruded are largely metamorphics of the Precambrian Shield and are associated with numerous granitic plutons (fig. 14-5).

History

Beryl occupies a unique place in the annals of Brazilian mining, for rumors of inland deposits of emerald encouraged expeditions of explorers to penetrate the wild interior in search of this valuable gemstone during the early colonial period. Eschwege, generally considered one of the most authoritative writers on early Brazilian gem mining history, declared that such rumors spread after 1573 upon the return of Sebastião Fernando Tourinho from an expedition to the Rio Doce, Serra do Frio, and the valley of Rio Jequitinhonha.¹ Some years later a certain Marco de Azerado and Agostinho Barnalho pursued these rumors with another expedition and informed the King of Portugal of a discovery of emeralds. Unfortunately, there seems to be no historical data to support this claim. On the other hand, Souza cited a vague report that Francisco Bruza de Spinoza led an expedition to the Jequitinhonha River

valley as early as 1551,² and it is possible that it was this venture that brought back the first stones claimed to be "Brazilian emeralds." Certainly the later explorers mentioned by Eschwege could not have been the first to find these stones, because Conrad Gesner, in his *De Rerum Fossilium* of 1565 not only described "smaragdus Bresiliacus, cylindri specie," but also furnished a woodcut illustration (fig. 2-5) of a crystal.³ The latter is unmistakably tourmaline, not an emerald as claimed, which placed in print a misnomer that was to confuse many succeeding generations of mineralogists and gemologists. Eschwege mentioned several other expeditions in the 17th century that penetrated the interior and noted that all the "emeralds" brought back were green tourmalines that were readily mistaken for the far more precious stone.

By 1682 Paiva⁴ recorded that 128 oitavas (ca. 460 gm) of beryls and aquamarines had been sent to Portugal, showing that by that date gemstones were being regularly obtained from some inland source. Many more gemstones were found as a result of a flood of immigrants into the interior following discoveries of major deposits of alluvial gold in 1669 and alluvial diamonds in about 1727.

Despite the importance of gemstone finds during this early colonial period, the literature is curiously silent about the localities. The first useful information on them did not appear until 1812, when John Mawe (1764-1829), who later became an important London mineral and gem dealer, provided an account of his travels into the interior and a description of the gemstones that he saw there (fig. 14-6).⁵ He apparently established trade connections to Brazilian suppliers, because his later publications describe Brazilian gemstones more fully and also offer cut gems.

Toward the close of the 19th century, Brazil had become a world leader in the supply of mica, several rare-element minerals, and gemstones obtained from pegmatite deposits. Just prior to World War II, a sharply increased demand for mica, beryl, and piezoelectric quartz led to intensive prospecting of the interior and resulted in the find of many more gem-bearing pegmatites. By 1949, Diniz Gonsalves listed several hundred gemstone mines and prospects of record.⁶ Pecora et al. listed many mica mines, some of which also yielded gemstones,⁷ while Almeida Rolff described occurrences of aquamarines and emeralds.^{8,9} In the modern period a transition occurred



Fig. 14-5 Sketch map of Brazil showing extent of the Precambrian Shield (gneisses, schists, granites) and major associated granitic pegmatite regions. Based on a map in G. De Paiva, *Provincias pegmatíticas do Brasil, Divisão do Fomento da Produccão Mineral, Bol. 78* (Rio, 1946):22 (with additions).

CTA

BERYL LOCALITIES
TRAVELS
IN THE
INTERIOR OF BRAZIL,
PARTICULARLY IN THE
GOLD AND DIAMOND DISTRICTS
OF THAT COUNTRY,
BY AUTHORITY OF THE PRINCE REGENT OF PORTUGAL;
INCLUDING
A VOYAGE TO THE RIO DE LA PLATA,
AND AN HISTORICAL SKETCH OF THE REVOLUTION OF BUENOS AYRES.
ILLUSTRATED WITH ENGRAVINGS.

By JOHN MAWE,
AUTHOR OF "THE MINERALOGY OF DERBYSHIRE."

LONDON:
PRINTED FOR LONGMAN, HURST, REES, ORME, AND BROWN,
PATERNOSTER-ROW.

1812.

Fig. 14-6 Title page of John Mawe's account of his travels in Brazil, including descriptions of gem mines.

World Sources of Ore and Gem Beryl / Brazil

from mining gravel deposits for gemstones to mining pegmatites directly. While considerable gem-bearing gravels remain, the mining of pegmatite bodies produces mineral specimens that include splendid crystals of beryl.

The production of ore beryl and some statistics on emerald in Brazil are given in tables 14-3 and 14-4, but good statistics on the production of other varieties of beryl are unavailable.

Table 14-3
BRAZILIAN ORE BERYL
PRODUCTION AND EXPORTS
In Metric Tons

Year	Pro- duc- tion	Exported	Year	Pro- duc- tion	Exported
1936	—	4.5	1951	1,838	1,533
1938	—	203	1952	2,479	2,523
1939	—	276	1953	—	2,160
1940	1,472	1,472	1954	—	1,366
1941	1,793	1,703	1956	2,321	
1942	1,700	1,634	1957	1,452	
1943	2,027	2,027	1958	1,312	
1944	1,500	1,185	1959	2,927	
1945	—	510	1960	3,827	
1946	1,294	1,163	1961	3,503	
1947	900	1,026	1962	3,319	
1948	1,445	1,783	1963	2,170	
1949	2,275	3,078	1964	1,566	
1950	2,201	2,625	1965	1,227	
			1966	877	

Approximate production 49,000 metric tons. Exports mainly to U.S.A.

Compiled principally from U.S. Bureau of Mines *Mineral Trade Notes and Minerals Handbook*.

Table 14-4
RECENT BRAZILIAN EMERALD PRODUCTION⁸
In U.S. Dollars

Year	Value	Carnaíba Deposit Exports, 1968-1969
1965	\$105,000	Total rough \$767,494
1966	148,000	Total cut 138,073
1967	352,000 ^a	
1968	225,000	

^aEstimated; data from Almeida Rolff.⁸

Ceará

Beryl-bearing pegmatites occur in two districts where they intrude Precambrian schists intercalated with quartzites and marbles (fig. 14-5). The complex is, in places, metamorphosed to granitoid and gneissic rocks. Beryl occurs in prismatic crystals of which a small number contain blue or colorless gem material and are rarely over 1 kg (2.2 lb). Most ore beryl is white or tinged with green. Up to 1945 the total ore production was estimated at 700 metric tons. Locality data stems mainly from Johnston,^{10,11} but also from Ferraz,¹² Calmbach¹³ and Putzer.¹⁴

In the Cascavel-Cristais district pegmatite sources are: Jatobá and Angico mines 12 km (7 mi) WSW of Cascavel; Lago do Brito 20 km (13 mi) S of Cascavel; Banguê 10 km (6 mi) NW of Cristais; Serrinha No. 1 and No. 2 18 km (11 mi) NW of Cristais; Jucas No. 1 and No. 2 5 km (3 mi) NE of Joazeiro or 5 km (3 mi) NW of Cristais; Parelhas 3 km (2 mi) from Cristais; Mulungu 5 km (3 mi) SW of Cristais.

In the Quixeramobim-Cachoeira (Solonóple) district the pegmatite belt is ca. 15 km (9 mi) wide and extends 30 km (18.5 mi) from Solonóple to several km NW of Linhares village. Mines around Olha d'Água, 30 km (18.5 mi) SE of Quixeramobim, include Pai José, Rancho de Garrote, Manoel Lemos, Garrote. Many prospects exist between Linhares and Grossos villages. Grossos No. 2 SE of Carnáubinha town produced 25 metric tons of ore beryl. The Poço dos Cavalos body noted for spessartine garnet and topaz is several km NW of Cangati town or 20 km (12.5 mi) N of Solonóple. At Varzea Torta village, 17 km (11 mi) N of Solonóple, 180 metric tons were produced. Other pegmatite mines between here and Solonóple are Serra, Bom Jesus de Francisco Carneira, and Lapinha Soledade No. 1; to the SW of Solonóple are Belo Horizonte No. 2 and Logradouro.

Rio Grande do Norte

Large fields of beryl-bearing pegmatites extend S into neighboring Paraíba state. These were extensively exploited during World War II for beryl, tantalite, etc.^{15,16,17,18,20} The region is a dreary wasteland, sparsely populated, and on a low plateau called the Planalto de Borborema (fig. 14-7). Pegmatites resisted weathering better than the enclosing rocks and hence stand out like walls. Locally these are called "altos." Almeida Rolff

BERYL LOCALITIES



Fig. 14-7 Beryl pegmatite concentrations in the states of Rio Grande do Norte and Paraíba, northeastern Brazil.

and Johnston examined several hundreds of bodies,^{21,22} which Rolff classified as homogeneous, heterogeneous and mixed, the first type being simple in mineralogy, the others complex, zoned bodies.¹⁵ Heterogeneous bodies generally contain microcline, albite, and other plagioclases, mus-

covite, quartz, tourmaline, biotite and almandine, and it is from such bodies that beryl, tantalite, cassiterite and columbite have been obtained. Spodumene and sulfides were also noted by Putzer.¹⁸ Zoning is usually sharply defined and the bodies often contain extensive quartz cores,

World Sources of Ore and Gem Beryl / Brazil

sometimes with phases of fine rose color as in the Boqueirão body near Parelhas. Occasionally vugs are lined with fine crystals of quartz, gemmy beryl, and more rarely, tourmaline, spodumene, etc. Almeida Rolff lists about 80 mineral species that had been found in the Borborema pegmatites.²¹

Beryl prisms of simple form occur in intermediate zones and adjacent to cores but only rarely in cavities. The colors range from greenish-yellow to blue, white, green, yellow, and rarely, a fine blue. Some pale green aquamarine and golden beryl in crystals up to 10 × 5 cm (4 × 2 in) were found at Alto Feio (Paraíba) and in the Santa Luzia region (Paraíba).²⁴ Common beryl crystals may be deformed or fractured, and some contain core inclusions of feldspars, tourmaline, tantalite and other species. They occur in all sizes up to about 1 m (3 ft) long and 60 cm (2 ft) in diameter. A crystal of 69 metric tons was found in the Alto Boqueirão, near Parelhas and a 50–100 metric ton individual occurred in Alto Serra Branca (Paraíba).^{19,21} Other large crystals include one of 120 cm (4 ft) diameter from Mamões mine near Equador²⁵ and a pinkish crystal of 200 metric tons mined from the Serra Branca mine.²⁶ The BeO content of such beryls is typically 11–13%.²²

In 1944 there were 112 pegmatite mines in the state and 224 in adjacent Paraíba.²⁷ Northeast Brazil as a whole produced 1,700 metric tons of beryl in 1942, 2,000 metric tons in 1943, and 1,500 metric tons in 1945.^{27,28} From 1939 to 1944 about 8,000 metric tons were produced in the municipality of Picuí, Paraíba alone, and in 1944 660 metric tons, in 1951 462 metric tons, and in 1954 about 400 metric tons.^{18,19}

In SW Rio Grande do Norte beryl occurs around the towns of Apodi, Caraubas, Pau dos Ferros, and Fazenda Compasso^{12,13}; in the S-central area, near Oiticica 10 km (6.2 mi) SSE of Caico.¹² The most productive beryl pegmatites occur on the Borborema Plateau in an area about 100 km (62 mi) due W of Natal city that extends about 150 km (93 mi) in a broad belt SSW to Equador city. Concentrations of pegmatites to the S and SE of Acará are at the following principal mines: Marimbondo, Dinheiro, Xique-Xique, and Currais Nova. The Alto Dinheiro body is 2 km (1.2 mi) long and forms a wall-like outcrop 15–20 m (50–66 ft) tall and 4–20 m (13–66 ft) wide.^{14,18} E, SE and S of Parelhas are numerous mines such

as Maracujá, Pedra Branca, São Tome. Here the Boqueirão pegmatite contains rose quartz in the core and giant beryl crystals. Between Parelhas and Equador are many other mines, notably the Alto do Giz, famed for its golden yellow, partly gem-quality simpsonite,²⁹ and the Mamões body measuring 450 × 30 m (1500 × 100 ft) which produced 70 metric tons of ore beryl in 1942 alone.¹⁸

Paraíba

The extensive pegmatite field in Rio Grande do Norte crosses the border into Paraíba and continues SSW from about 20 km (12.5 mi) N of Picuí city to Joazeirinho town, or a distance of ca. 90 km (56 mi). Picuí is 150 km (93 mi) SW of Natal.²⁴ In the Picuí district important mines are Alto Urubú, Alto Damião, Tanquinhos, and Cruzeiro.^{18,30} Near Nova Palmeira and Passagens villages are Alto das Ovelhas, Alto Cachoeirinha, Alto Caieira, Alto Caetetus, and Alto Branco.^{18,28} The Pedra Lavrada village area contains: Alto Patrimonio, which produced 45 metric tons of ore beryl in 1940–42, including a little gem aquamarine;³¹ Alto Feio, which produced 110 metric tons of ore beryl during World War II, 200 metric tons in 1951,^{14,18} and 30 metric tons in 1941–44,³² and Onça. In the Pedra Pretas area, about 10 km (6.2 mi) N of Joazeirinho, the Serindozinho body produced 119 metric tons of ore beryl in 1955;¹⁸ other mines here are Alto Maravilho and Alto Serra Branca.^{26,32} Near the town of Junco do Serido, close to Equador, are the Cristais mine and others. Several are located near the towns of Santa Luzia and São Mamede.

Pernambuco

Franco noted two beryl occurrences in pegmatites at Altinho in large crystals,³³ where in 1951 50 metric tons of ore beryl were produced.¹⁴

Alagoas

Beryl has been noted in the municipality of Traipú¹² and at Pão de Ferros, Serido and Traique.¹³

Bahia

Numerous pegmatites occur in a belt paralleling the Atlantic coastline and extending over a distance of about 600 km (370 mi) from NNE to

BERYL LOCALITIES

SSW, then passing over the border into Minas Gerais.

Emerald in Bahia occurs in mica schist on the Fazenda São Thiago, situated on the left bank of the São Francisco River, about halfway between Xique-Xique and Remanso in the municipality of Pilão Arcado, near the town of Salininha.³⁴ This deposit was known for many years, but positive identification of the emerald was only made in 1962. Many small parties began mining that year, but "up to the present, only three pits are producing emeralds and inferior beryls. About 15 kilos [33 lb] of largely inferior crystals has yielded 100 grams of good emeralds."³⁴ This emerald was spectroscopically examined and contained Cr 0.0003, V 0.15% and numerous other elements in small quantities (U.S. Geological Survey Report, 65-WS-166, Sept. 16, 1965). Vanadium instead of chromium appears to be the coloring ion.

In the Campo Formoso district, the Carnaiba emerald deposits continued production into 1979. The city of Campo Formoso is 77 km (48 mi) N of Jacobina. The emerald deposits are located within an area of several kilometers diameter around the village of Carnaiba, the latter located 27 km (17 mi) SW of Campo Formoso or almost directly S about 9 km (5.6 mi) from the village of Brejão das Grotas.^{9,35} According to a geological map prepared by J. C. Griffon in 1967 and provided through the courtesy of D. B. Hoover, small bodies of "rocha verde," or green rock (chromite-bearing ultramafics) outcrop at several points around Carnaiba, and it is from these that the emeralds are obtained (see fig. 14-8). Pits and underground workings were sunk to at least 50 m (165 ft) in decomposed granitic rocks containing these bodies, which in the emerald-bearing portions consisted of vermiculite-biotite schists. In places the emeralds are accompanied by colorless, white, and pale-green beryls. The crystals are simple hexagonal prisms with poorly defined terminations, and many are fractured and filled with inclusions. The size range is from very small prisms to some as large as 120 × 45 mm (2.75 × 4.75 in). The general quality is poor but some good stones may be found. Cotton learned that four grades were sold, the best being of "good color, clean and very rare."³⁵ As of 1969, the Carnaiba "rush" was populated by about 6,000 persons including dependents and camp followers.^{8,36,37} Most of the stones were cut as cabo-

chons, and only a small quantity was faceted and sold in Brazil or to German and Dutch firms.

Elsewhere in the district, Almeida Rolff reported a recent (1969?) discovery of emerald about 2 km (1.2 mi) from Garimpo Velho at "the first place of discovery of the Carnaiba region."⁹ The host rock is vermiculite-biotite schist associated with Jacobina quartzites and closely associated pegmatite intrusions.

An interesting but commercially unimportant emerald occurrence is at Bom Jesus das Meiras in the Brumado district, the latter town located 365 km (228 mi) WSW of Salvador at the SE foot of Serra das Éguas. Emeralds were discovered in 1912 or 1913 upon the W slope in Pirajá valley at a point 16 km (10 mi) W of Brumado.³⁸ Just³⁹ and Bodenlos⁴⁰ gave descriptions of the deposit and its minerals. Early mining consisted of shallow pits in surface material followed upslope to the in-place source. The crystals occur in an altered dolomitic marble presumed to be Lower Paleozoic in age and capping the mountain in a layer at least 60 m (200 ft) thick. This itself overlies gneisses and schist of the Complexo Fundamental of Precambrian age. The marble is penetrated by sheets of talc and streaks of dark amphibolite and rhyolite that in some places make up about half the total volume. Emeralds are found in the talc sheets in geodes and drusy cavities, which also contain crystals of quartz and calcite. A few emerald crystals occur singly in the marble. Outer geode portions are quartz, the inner parts being usually crystalline calcite which sometimes fills all the space. The emeralds are found in the calcite associated with small tourmaline and topaz crystals. Commonly, a second generation of quartz crystals forms an inner lining and covers the species named. The presence of talc suggests hydrothermal activity emanating from some igneous rock source. Bodenlos⁴⁰ additionally identified chalcedony, opal and jasper in adjoining rocks, and in the druses, magnesite crystals, specular hematite, kyanite, beryl, and dolomite. The talc contains kyanite, tourmaline, phlogopite, and dolomite. Other species reported are rutile, monazite, xenotime, spodumene, albite, and lepidolite.^{41,42,43}

The emerald crystals are remarkable for their excellent crystallographic development and reach sizes of up to 10 cm (4 in) long and 13 mm (0.5 in) in diameter. Doubly-terminated individuals are common. Almost all show several pyramidal

World Sources of Ore and Gem Beryl / Brazil



Fig. 14-8 Sketch map of the Carnaiba emerald deposit region showing outcrops of the so-called "rocha verde" or green rock, consisting of basic magnesium-iron-rich minerals with chromite. Several small outcrops near Carnaiba village contain emeralds near the contact zones. Based on J. C. Griffon's geological map of part of the central Serra de Jacobina, Bahia, 1967.

forms and one crystal was noted with 18 pyramidal faces. First and second order prism faces of *m* and *a* are present. Michel noted the following forms on a 54 × 15 mm (2.2 × 0.7 in) crystal to which were attached minute crystals of topaz, tourmaline, and magnesite: *m*, *c*, *PI*, *p*, *u*, *s*, *o'* {1124}.⁴⁴ Siedel observed: {0001}, {1010}, {1120}, {2130}, {1012}, {1011}, {2021}, {5052}, {3031}, {1121}, {1124}, {2131}, {2136}, and {4261}, making these among the most form-rich emerald crystals known.⁴¹

Up to about 1925, only about 20 kg (44 lb) of crystals had been mined with very few dark enough to be of good gem quality, although they were entirely green and most badly flawed.³⁹ On

the other hand, Herman & Wussow stated that the crystals were characteristically yellowish in hue and "very clear and often completely free of flaws."⁴⁵ Several excellent individuals from here are in the Field Museum of Natural History in Chicago, one of 175 grams being 75 × 37 mm (3 × 1.5 in), another of 151 gm is 75 × 31 mm (3 × 1.25 in), and a third of 128 gm is 127 mm (5 in) long. Two of these are terminated with *c*{0001} and another by two sets of pyramids; "all are of rich emerald green and contain many transparent portions."⁴⁶ In summary, Bodenlos noted that "from all accounts, the emeralds . . . from the Pirajá deposit did not have so desirable a color as those found in Colombia, and it is said

BERYL LOCALITIES



Fig. 14-9 The so-called Grota Funda or "Deep Cavern" at Carnaíba, Bahia, one of the earliest emerald diggings consisting of numerous claims worked by various mining groups. *Courtesy of Walter E. Johansen, Morgan Hill, Calif., who took the picture in 1965.*

that they were inferior to those occurring near Vitória da Conquista . . . 120 kilometers south of Brumado.^{11,40}

According to Putzer some ore beryl was also mined near Brumado.¹⁴

In the Jacobina district, granitic pegmatites yielded ore beryl and some gem aquamarine.^{12,13} In the Andaraí (Andarahy) district, 310 km (190 mi) due W of Salvador, beryl is found at São João de Paraguaçu,^{12,13} and common beryl near Ituaçu (Ituassu) 320 km (198 mi) WSW of Salvador. Common beryl also occurs near the town of Poços, 260 km (162 mi) SW of Salvador.¹³

In Vitória da Conquista district, located 325 km (202 mi) SW of Salvador, ore beryl and gem aquamarine have long been obtained from pegmatites.^{12,13,14} Draper mentions an opencut emerald mine but gives no further details.³⁴ Beryl

pegmatites occur S of Veredinha village and at Itambé on Rio Pardo about 50 km (31 mi) SSE of Vitória da Conquista. Beryl was also mined around Porto Santa Cruz village on Rio Pardo, a place that is said to have a nearby emerald deposit.^{12,13} Calmbach reported a large, deep blue aquamarine crystal, 2 × 3 m (6.6 × 9.9 ft) found in Verruga or Verruga da Giboia, but the source is not further identified.¹³ The crystal contained only small clear portions suitable for gems. Another vague locality mentioned by Calmbach is Matta Escura.

Goiás

This area is noteworthy for occurrences of emerald only. The major deposit is in detritus from weathered mica schist in Serra das Lages, a range of hills 32 km (20 mi) SE of the capital city of

World Sources of Ore and Gem Beryl / Brazil

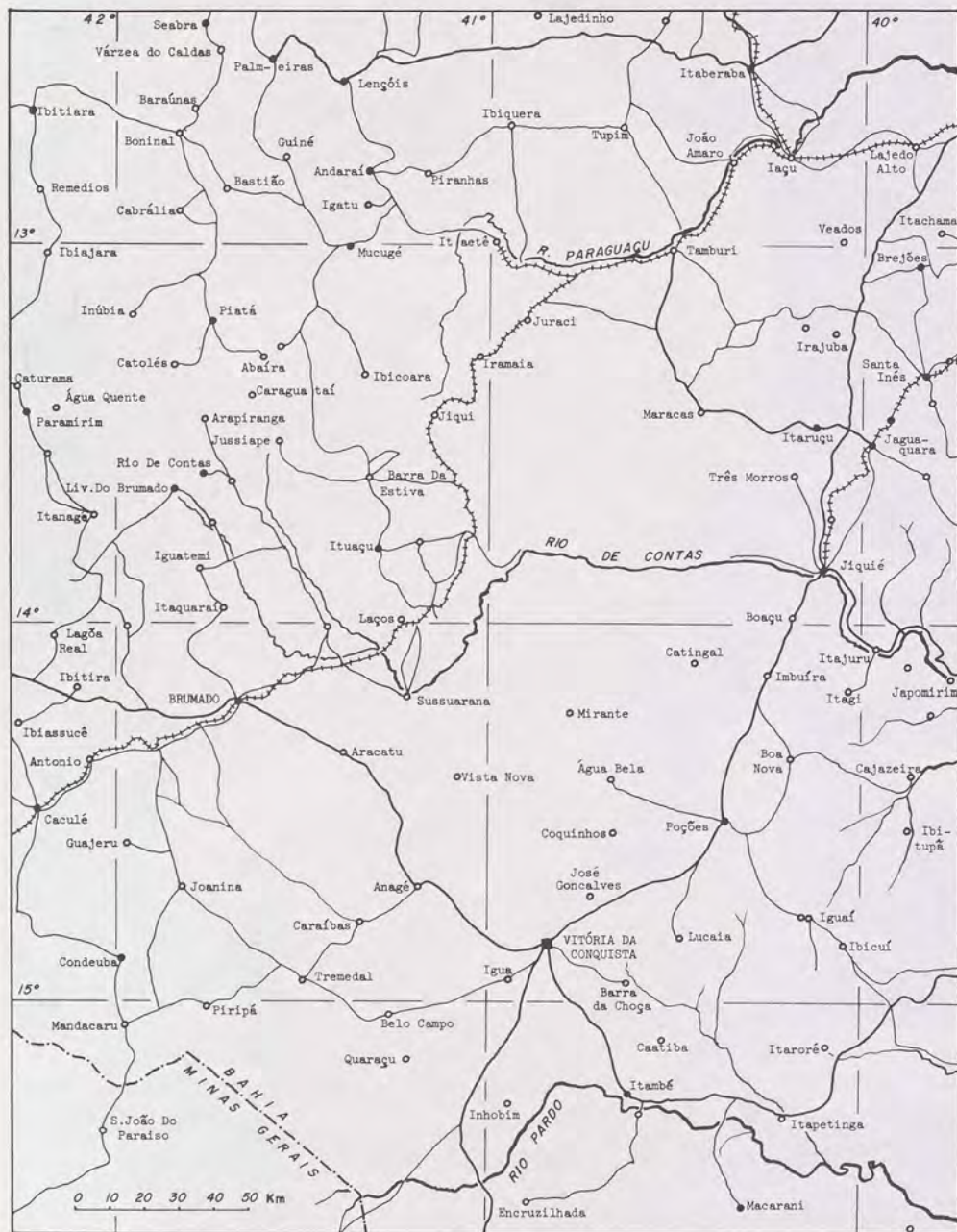

Fig. 14-10 Sketch map of the southeastern portion of the state of Bahia, Brazil showing some beryl localities mentioned in the text.



Fig. 14-11 A splendid, etched, blue aquamarine crystal weighing 19 kg (42 lb) found in Jaqueto, a small town located in the municipality of Miraja, state of Bahia, Brazil, in January 1979. The dimensions are 59×38 cm (23×15 in). The crystal was purchased by the jewelry and gem firm of H. Stern in Rio de Janeiro and was still in its possession, intact, in late 1980. *Courtesy of Hans Stern, Rio de Janeiro.*

World Sources of Ore and Gem Beryl / Brazil

Goiânia.⁴⁷ Calmbach gives the site as upon the Fazenda das Lages, left bank of Ribeirão do Bugre, a tributary of Rio Urubú, municipality Itaberai, Comarca Rio das Pedras.¹³ Almeida Rolff refers to this as the Itaberai locality and states that the emerald crystals occurred in decomposed rock and were recovered by washing.⁹ They are no more than 2–3 cm (0.75–1.2 in) long, of excellent color, but are few in number. Leinz and Leonardos state, however, that they are badly flawed and lack transparency, and that the deposit is similar to schist-type deposits elsewhere.⁴⁷ Emeralds were also found at Sarandy, municipality Itaberai, as 2–20 mm crystals in alluvium.¹³ Emeralds are also said to occur at Rio Capivari, 40 km (25 mi) from Pão Secco, and near Nova Aurora, 185 km (115 mi) SSE of Goiânia.^{12,13}

Minas Gerais (formerly "Geraes")

The name means "General Mines" in allusion to its past and present importance as a producer of minerals. It contains one of the world's largest pegmatite provinces (fig. 14-5), which extends from NNE to SSW over a distance of ca. 750 km (465 mi) and is ca. 250 km (155 mi) wide. The pegmatites are offshoots from numerous granitic intrusives in biotite schists, amphibole schists, quartzites, granitoid gneisses, and others of Precambrian age.^{7,49,50} Weathering is deep in country rocks and pegmatites so that the latter are often reduced to loosely coherent masses of kaolinized feldspars studded with masses of the more resistant minerals, including gemstones. The combination of abundant rainfall, warmth, and resulting weathering caused much concentration of pegmatite products in alluvial deposits throughout the state's watershed. Early recovery of valuable minerals was primarily from digging in such deposits or in the detritus "spills" on slopes. Because of monsoon conditions, especially in the south, mining is normally conducted during the dry season, which corresponds to the Brazilian winter with July the driest month. Most deposits are still worked by individual prospector-miners or *garimpeiros* working singly or in small teams. Their winnings are sold on the spot to visitors or taken to the larger cities such as Teófilo Otoni, Governador Valadares, or Conselheiro Pena.

According to Pecora et al., "the pegmatite mines of Minas Geraes produced some 7,200 metric tons of sheet mica . . . 530 tons of beryl, and 110 tons of tantalite and columbite. The estimated market value . . . is approximately [U.S.]

\$25,000,000 . . . nearly half of which is the value of the mica."⁷ Putzer provided data on the most productive ore beryl districts or mine groups for 1951:

Table 14-5
MINAS GERAIS ORE BERYL PRODUCTION 1951¹⁴

METRIC TONS	
Salina	387
Virgem De Lapa	300
Conselheiro Pena	148.3
Governador Valadares	127.2
Itinga	116.5
Aracuai	21
Galileia	20
Sabinopolis	6.7
Total	1,126.8

BRAZILIAN EXPORTS OF AQUAMARINE¹⁴
(Mainly Minas Gerais)

	kg		kg
1939	380.2	1944	72.8
1940	1,169	1945	107.1
1941	524.6	1946	93.7
1942	10.2	1947	14.9
1943	31.7	1948	9.9

In respect to gem beryls, Minas Gerais is the world's most important producer, surpassing all other countries both in terms of the largest production sustained over several centuries and in quality (with the notable exception of pink beryls, the finest of which stem from Madagascar). While the export figures in table 14-5 appear authentic, they are probably seriously understated, for the system of regulation and taxation in Brazil encourages movement of gemstones out of the country via illicit channels with the result that accurate estimates are impossible.

The prime Brazilian beryl is aquamarine, largely obtained from Minas Gerais, and ranging in color from pure blue of the finest and most valuable tint to various shades of blue-green and yellow-green. Excellent chartreuse, pale green, and golden beryl are also found, as well as pink and colorless beryls. Emerald has been found in two well-documented deposits in Minas Gerais, but some others mentioned are of doubtful authenticity.

World Sources of Ore and Gem Beryl / Brazil

via the steamer "Westerwald" to Hamburg, Germany. In Hamburg, the large wooden crate holding the crystal was given over to a firm of forwarders to trans-ship to Idar-Oberstein. After a few days delay in reaching Idar-Oberstein, Klein was shocked to find that the stone had not arrived. Backtracking to Hamburg, he found the crate, unidentified, in a corner of a freight warehouse where the custodian had put it hoping that a claimant would appear to take the parcel off his hands. This time Klein personally escorted the box to Idar-Oberstein. Here the firm of Bohrer-Borges, whose representative, Viktor Bohrer-Borges was with August Klein in Brazil and apparently supplied the funds for the purchase of the crystal, took possession of the crystal and offered it for sale at a price on one-half million marks. However, no museum or other institution bought the crystal, and it was broken up into pieces that were sold separately. According to Kunz, who gave the original purchase price as \$25,000, the crystal was estimated to yield 200,000 carats of finished gems.⁵⁴ Oakenfull gave the estimated value of the stone in Germany as £ 50,000.⁵⁶

Another large crystal, according to Oakenfull, was a well-formed prism of 195 kg (430 lb) found at Espera Feliz, 46 km (28 mi) S of Manhuacú, but it "had nothing but a cone [core?] worth cutting."⁵⁶ Calmbach mentions a good blue hexagonal prism of 5 m (16 ft) long and 1 m (3 ft) in diameter that was found at Lavra de Ferreira and weighed 3,000 kg (6,600 lb) but was completely opaque and unfit for gems.¹³ In the summer of 1942, an aquamarine crystal of 108 kg (222 lb) was found at Ariranho, Rio Bugre, 30 km (18.5 mi) NW of Governador Valadares; the owners were offered about U.S. \$40,000 for the stone.⁵⁸

Sometime in 1946, a 25.4 kg (56 lb) rough, hexagonal prism of aquamarine, measuring 28 cm (11 in) long and 25 cm (10 in) in diameter, was found near Resplendor, 30 km (18.5 mi) SE of Conselheiro Pena. A syndicate shipped the stone to New York in October, 1946, where it was insured for U.S. \$500,000 and claimed to bear a potential of \$2,500,000 in cut gems. Title to the stone was badly clouded by four claimants, including the owner of the land on which it was found, and the miners. In November, the stone, valued at \$1,000,000 was placed in the vaults of the Manufacturers Safe Deposit Company. Its subsequent fate seems to be unknown.

A splendid deep blue aquamarine crystal of 33.928 kg (74.5 lb) was found in 1954 or 1955 on a farm near Teófilo Otoni and was estimated as 60% cuttable. This was the specimen later to achieve fame among gem merchants as setting the top standard of color in aquamarine. It was named the Marta Rocha after Miss Brazil of the time.^{59,60}

Schupp described a broken section of an intensely dark blue-green crystal, 37 cm (12.5 in) long and 23 cm (9 in) in diameter, found in a "quartz deposit" in the Galvão area near Topazio village, 25 km (15.5 mi) NNE of Teófilo Otoni.⁶¹ Another large crystal was reported in the December, 1955, issue of the *Washington Post* from Minas Gerais that weighed 61 kg (134.5 lb) but no further details were provided. However, according to Froés Abreu it was found in gravel at Garajaú, near Governador Valadares, and was named the Lucia.⁶⁰ It was estimated to contain 25 kg (55 lb) of cuttable material. In 1964, another "bomba," the Brazilian colloquialism for an exceedingly fine stone of Marta Rocha quality, was applied to a deep blue to blue-green aquamarine, said to resemble fine tourmaline in color. This stone was found by garimpeiro Abelô Ferreira near Padre Paraiso (Água Vermelha) in the Pedroso alluvial mine, Rio Marambaia valley, 75 km (46 mi) N of Teófilo Otoni. It weighed 7 kg (15.5 lb) and measured 26 × 11 cm (10.25 × 4.3 in) and was nearly of cylindrical form due to equal development of first and second order prisms. H. Stern, jewelers of Rio de Janeiro, bought the stone and dubbed it the IV Centenario.

Aside from aquamarines and some large golden beryls that have been found from time to time, the gemmy pink or morganite variety, or sometimes a beautiful apricot color beryl, are found of exceptional size and crystallographic perfection. While they are much larger than the pink beryls of Madagascar, they are not as rich in color. Some crystals of morganite have been recently obtained that are nearly 30 cm (12 in) in diameter.

BERYL LOCALITIES. Despite the fact that beryl, tourmaline, topaz and other gemstones have been mined for centuries, there is no comprehensive text which deals adequately with the subject. Locality information had to be gleaned from numerous widely-scattered sources, ranging from formal geological reports, Brazilian and foreign, to informal accounts of visits. Brazilian geologist L. C. Ferraz was the first to prepare a useful summary of localities in his *Compendio dos Mi-*

BERYL LOCALITIES

neraes do Brasil, published in 1929.¹² This was followed in 1934 by von Freyberg's *Bodenschätze des Staates Minas Gerais*,⁵⁰ a work that is still very useful, and a popular treatment in 1938 by Calmbach entitled *Handbuch brasilianischer Edelsteine und ihrer Vorkommen*.¹³ These, plus other reports and accounts, were freely consulted in the preparation of the following section.

NORTHERN MINAS GERAIS—JEQUITINHONHA RIVER. This is a large region with beryl mostly won from gravels that occur in hundreds of creek and river valleys forming part of the Jequitinhonha watershed. The most important valley begins at Barra de Salinas village where the Rio Salinas flows S to join the Jequitinhonha at a point 165 km (100 mi) NW of Teófilo Otoni. From here, the Jequitinhonha flows E-NE, providing along its entire length gravels containing gemstones.

The so-called "Fortaleza" gem aquamarines, noted for clarity and fine blue color, occur in the main river and its many tributaries in the municipalities of Araçuaí (Arassuaí), Salinas, Fortaleza and Jequitinhonha. Richest finds are at lavras (washings) in Laranjeiras near the Fortaleza and Piedra Grande villages in municipality Jequitinhonha. Large Laranjeiras crystals include a fine aquamarine of 7.87 kg (17.35 lb) which sold at

a high price in 1935; another, fully clean crystal of ca. 12 kg (26.5 lb) was in the National Museum in Rio but was stolen in 1915. Some large cut gems include three of the finest known blue color of 1,285, 910 and 293 carats, cut by Oscar Machado company. The largest of these was presented to Franklin D. Roosevelt by the Brazilian Government upon the occasion of his presidential visit to Brazil.¹³ The gem is now in the Roosevelt Museum, Hyde Park, N.Y. Other excellent crystals were found at Estanzia Aldeia and Pedra Branca, municipality Fortaleza, sometime after 1920.¹³

Along the N bank of Jequitinhonha River between the Salinas and São Pedro rivers is Santa Rita village with lavras at Porteiras, Boqueirão, Farrancho (near Vigia), Brejo, Saltador, Pinguieira, Santo Antonio, Sitio and Comercinho do Bruno. Near Barra de Salinas at the mouth of Rio Salinas, the gravels are noted for fine colored tourmalines and rose beryls. Other sites include: Pedro de Frade, Itaporé, the towns of Itinga and Itaobim, São Roque, the town of São Pedro do Jequitinhonha. A short distance away are the famous Ilha Alegre deposits and Emparedado and Cajú, the last with interesting pyramidal crystals of beryl.

The Ilha Alegre deposits are noted for excep-

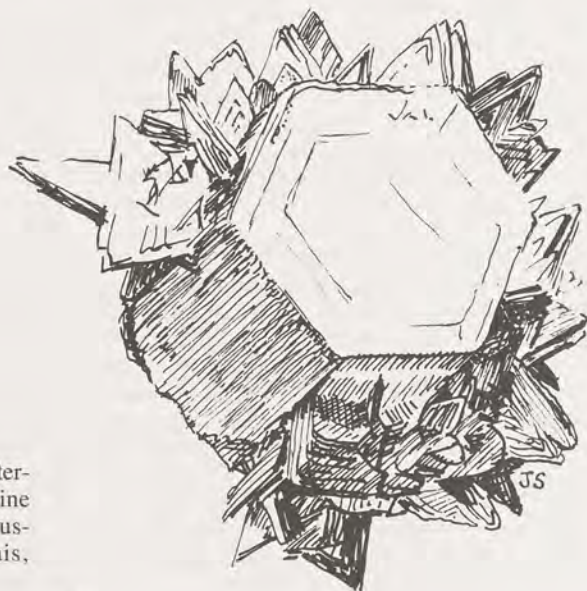

Fig. 14-13 Sketch in natural size of a terminated, very pale greenish aquamarine crystal partly enclosed by twinned muscovite crystals. Salinas, Minas Gerais, Brazil.

World Sources of Ore and Gem Beryl / Brazil

tional quality beryl crystals and are the richest of all sources in the valley.⁶² The site is near São Pedro de Jequitinhonha where alluvials occur blanketing low hills and a wide strip along the N bank of the Jequitinhonha River. About 1903, a farmer found blue crystals which he sold locally for trifling sums, but as digging brought up more stones, a "rush" took place which resulted in intensive exploitation. Not far away on the opposite bank at Farrancho, a similar deposit yielded a crystal 15 cm (6 in) long and 5 cm (2 in) in diameter. In general, the crystals are of light green color but also golden yellow. However, a crystal of 9 kg (19 lb) of fine blue was found which sold in 1905 for £ 450; another of 1 kg (2.2 lb) sold for £ 100 and still another of 6 kg (13 lb) sold for £ 15 per kg, according to Oakenfull.⁵⁶ He stated that "another splendid gem from Ilha Alegre . . . was recently sold for £ 45,000, and a Golden Beryl discovered at the same place weighed 180 grams." The literature also mentions "steel blue" aquamarines from this locality with distinctive etch marks and numerous hair-like tubes parallel to the *c*-axis.

Many alluvial deposits occur along the S bank of Rio Jequitinhonha and tributaries such as Rio São Miguel, especially around the towns of Joaima, 25 km (15.5 mi) S of Jequitinhonha and Girú S of Joaima. Others occur along Riberão São João, which enters R. Jequitinhonha at Itaobim, 145 km (90 mi) N of Teófilo Otoni; near São João Grande village 15 km (9.5 mi) S of Itaobim (especially productive); and in the valley of Rio Piauí (Piauí), which enters the Jequitinhonha River 25 km (15.5 mi) NE of Araçuaí or 135 km (83 mi) NNW of Teófilo Otoni.

MAXIXE BERYL LOCALITY. At the Maxixe mine in Piauí valley curious blue, gem quality alkali beryl crystals occurred along with pink tourmalines in gravel deposits. The crystals are deeply corroded with grooves and channels parallel to the *c*-axis. The most striking feature, however, was the strong dichroism in reverse of the normal pattern. That is, the direction parallel to *c*-axis shows a fine blue, but perpendicular to this direction is almost colorless, or *o* = cobalt blue, *e* = near colorless. On exposure for several days to sunlight or after gentle heating, the crystals faded to yellowish.⁶³ Similar beryls have been found recently elsewhere in Brazil and their behavior and its explanation described in Chapter 8.^{64,65}

Farther upstream along the S bank of Rio Jequitinhonha, the Rio Araçuaí enters about 10 km (6.2 mi) NE of the town of the same name. It branches a little to the S of the town into the Rio Gravatá, Rio Setubal and Ribeirão Sucuriú, all providing alluvial gemstones from the sides, floors, and beds as well as from neighboring hill tops. The area is broad, extending as far SW as Minas Novas town, 190 km (120 mi) NNW of Governador Valadares and SE to Padre Paraíso, a town 85 km (53 mi) N of Teófilo Otoni. The entire region is noted for beryl and tourmaline, found in many instances incident to tilling the soil.

TEÓFILO OTONI REGION. As early as 1811, a grass-green beryl of 7.5–10 kg (16.5–22 lb) was found in the headwaters of Rio São Mateus near Teófilo Otoni; possibly it is the first recorded find of beryl here.¹³ In terms of area, this region generally encloses the many branches of the Rio Mucuri, which flows SSE to leave the state at a point 135 km (83 mi) E of Teófilo Otoni. It also includes the adjacent watershed of Rio São Mateus, which follows a somewhat parallel course to the ESE. Thousands of pits have been sunk in alluvials and upon pegmatite outcrops since the first intensive prospection in 1908.

Many deposits occur along the N bank of the Mucuri River and stream valleys originating from flanks of Serra do Chifre (Pedra do Chifre) or about 50 km (31 mi) NNE of Teófilo Otoni. Others occur in streams from Serra das Esmeraldas such as Ribeirão Preto and tributary R. Marambaia; in pits along valleys at Corrego de Sant'Anna (Inferno), Murindú, Batatal, Toca, Veados, Sucanga, and Mandançaia. Along the river valley of Santa Cruz are mines at Lagôa, Espinho, and Pontaleta, all known for good heat-treatable beryls. Also in the area are mines of Jesue, Papamel (source of the 110.5 kg crystal previously described), Padre Paraíso, Mocaya, Quaresma, Pará, Pica Pão. Along the Pretinho and da Onça rivers are mines at Marcolino, Casiano, José Magro, Manoel Ferreira, Antonio Desidio and Felipe. The Ribeirão da Americaninha, between the towns of Padre Paraíso and Pavao, is dotted with pits along its length; on the left bank are Corregio Anastacio and right bank the Corregio Inveja.¹³

Near Padre Paraíso at Tres Barras village, about 90 km (55 mi) N of Teófilo Otoni, a large strike of alluvial aquamarine crystals of pale

World Sources of Ore and Gem Beryl / Brazil

lb) and others of remarkable pale blue-gray color with amethystine-pink zones parallel to the *c*-axis; one crystal had zones pink (outer), blue (intermediate) and colorless (core).

MINAS NOVAS, LUFÁ, CAPELINHA AREA. Widespread beryl-bearing pegmatites occur in valleys of the Itamarandiba, Fanado, Setubal, and Setubinha rivers as well as in the S portion of Rio Gravatá and an area around Lufa village.¹³ Numerous mica mines, some with beryl, are around Setubinha.⁷ Notable beryls and kunzites come from the following mines: Coqueiros, Costa D'Anta, Colanhão and Surubú.¹³

GOVERNADOR VALADARES AREA. Triangle-shaped area, the S point the city of Governador Valadares itself, thence extending NNW-NW to meet the region just described above. Gemstones come from alluvial gravels, but also from many pegmatite mines that are rich in mica, rare earth minerals, and sometimes contain large crystals of beryl, green spodumene, quartz, tourmaline, topaz, etc.^{7,68} Generally this area includes the watershed of Rio Suaçuí Grande, flowing SE to empty into Rio Doce 15 km (9 mi) E of Governador Valadares. Gem gravels occur along many tributaries draining slopes of Serra dos Correntes such as R. Água Boa, the Poia area, Cristais, R. do Bugré, Apaga Luz, Sant'Anna, São José da Saphira, Chonin, Coraci, Figueira, R. da Onça, also the Serra da Correia, Sotero, Ferreira, Ferreirinha, R. Cuiethe, Caratinga.¹³ Productive area around town of Peçanha. Some idea of the enormous number of pegmatites is given by Pecora et al. who noted 92 mica mines in three areas from Maranhão to Governador Valadares.⁷ Famous pegmatites include the Golconda, with aquamarine and morganite,^{69,70} the Faria, with large multicolored beryls, the Jacob, the Poaia, with aquamarine and morganite, the Marilac, which yielded ore beryl and some gem aquamarine, the Chia, Seca Bofe, and the large Cruzeiro pegmatite near Glucino village which yielded beryls.⁶⁸ Notable gem mines in the municipality of Santa Maria do Suaçuí are Corrego Preto, Campinho, Safirão, Moinho, Lava-Pés, Monjolo, Serpinha, and Mosquito (gem tourmalines as well as beryl).¹⁴ Beryl also occurs at Aricanga,⁶⁸ Uru-puca, and Seixta-Feira. In the municipality of Peçanha, deposits occur in the valley of Riberão Ramelhete.^{13,71}

CONSELHEIRO PENA AREA. This adjoins the Teófilo Otoni area to the N and the Governador Valadares area to the NW. The city of Consel-

heiro Pena is on Rio Doce, 60 km (37 mi) SE of Governador Valadares and 270 km (167 mi) NE of Belo Horizonte. Many pegmatites and alluvials are found in stream valleys draining S into Rio Doce from near Governador Valadares to the exit of Rio Doce from the state of Minas Gerais at a point near Aimores, the latter located 60 km (37 mi) SE of Conselheiro Pena. Pecora et al. recorded 66 pegmatite mines which furnished mica and some gemstones.⁷ Around São Sebastião de Laranjeiras, 25 km (15.5 mi) N of Conselheiro Pena, mica and morganite occur; about 15 km (9 mi) NNW of Laranjeiras is the famous Sapucaia pegmatite noted for fine beryl crystals and the curious brown beryl which owes its color to basal inclusions of roschelite and frondelite.^{72,73} This mine also provided excellent rose quartz crystals.⁶⁹ Around Galilea, 20 km (12.5 mi) NW of Conselheiro Pena, there are many mines such as Retiro (ore beryl) and Segredo (quartz, mica, beryl).⁶⁹ Beryls appear in mines on Barra do Cuieté, 15 km (9 mi) N of Conselheiro Pena; others are Boa Vista, Alegre, Batista, Pitorra, Corrego Frio, Pomaroli, Linópolis, Pedra Alta, Itatiaia (noted for fine tourmalines), Spodumen, Cascelho, Palmital, São Pedro de Agua Limpá, Baixio, Resplendor. Vague reports of fine beryls have referred to Serra dos Aimores on the border between Minas Gerais and Espírito Santo.

SERRO, SABINÓPOLIS, GUANHÃES AREA. These three towns are located 155 km (93 mi), 125 km (78 mi) and 105 km (65 mi) respectively W to WNW of Governador Valadares. Around them and to the S occur many alluvial and pegmatite deposits with beryl and other gemstones. Sabinópolis was formerly known as São Sebastião dos Correntes. In the valley of Rio Guanhões, 20 km (12.5 mi) SW of Guanhões occur the Gruta das Generosas, Conceição do Mato Dentro, and the Rio do Peixe valley, running S to near Ferros, the latter 125 km (78 mi) WSW of Governador Valadares. There are mines around Ferros, including Esmeraldas do Ferros, 20 km (12.5 mi) to SE, Fazenda Itáuininha, and in the Brejaúba village area, 15 km (9 mi) W of Ferros.¹³

ITABIRA AREA. The town of Itabira is 85 km (53 mi) ENE of Belo Horizonte. Beryl occurs in alluvials and pegmatites around Santa Maria de Itabira, 23 km (14 mi) NNE of Itabira, Barro Preto, 5 km (3 mi) SE; Chaves, Corrego da Lage, Cacunda, Barra D'Anta (emeralds reported), Funil, Morro Escuro, Matto, Paiol, São Marcos, Macuco, Antonio Dias and Fazenda Caxambú. In

BERYL LOCALITIES

the municipality of São Domingos, 100 km (62 mi) E of Belo Horizonte, deposits occur at São José de Lagôa, Mandú, and Ribeirão Cocais Pequenos.¹³

SOUTHERN MINAS GERAIS. There are many beryl-bearing pegmatites SW of Caratinga city, 95 km (59 mi) SW of Conselheiro Pena, and extending to about 300 km (185 mi) to Andrelandia, 170 km (110 mi) NW of Rio de Janeiro, but these are noted mostly for mica production and rare element species rather than beryls and gemstones. Bom Jesus do Galho area, 20 km (12.5 mi) W of Caratinga, contains 33 mica mines, some with beryl.⁷ The nearby Raul Soares area, 50 km (31 mi) SW of Caratinga, has 18 mica mines. The municipality of Manhuaçu, 65 km (40 mi) SSE of Caratinga, features gem aquamarine from Taquarana and along Rio Piranga.¹³ In the Abre Campo town area, 60 km (37 mi) SSW of Caratinga, 17 mica mines, some with beryl, may be found.⁷ Carangola area, 105 km (65 mi) S of Caratinga; Ispera Feliz; gem beryls at Faria Lemos 10 km (6 mi) S of Carangola; Serra Do Carapão; São João Do Rio Preto;¹³ in this general area, 125 mica mines.⁷ The São Francisco Gloria-Muriaé area, about 25 km (15.5 mi) WSW of Carangola, contains 40 mica mines.⁷ Gem beryls occur in Rio Muriaé and Rio Pomba, the latter 40 km (25 mi) S of Muriaé.^{13,74} The Bras Pires, Alta Rio Doce area, ca. 220 km (137 mi) N of Rio de Janeiro, contains 14 mica mines.⁷ Beryl occurs in the pegmatite mine Alto do Lino (Corrego do Chico Gomes) close to Abreus and NE of Alto Rio Doce.⁷⁵ São João Nepomuceno town area, 150 km (93 mi) NNE of Rio de Janeiro, contains some gem beryl.¹³ In this location and around Bicas town, 130 km (81 mi) N of Rio de Janeiro are about 50 mica mines.⁷ The mica mine at Pequeri village contains beryl.⁷⁷ Gem beryls may be found near Mar de Espanha town, 120 km (75 mi) NNE of Rio de Janeiro and in Serra do Pangarito.¹³ In the municipality of Andrelandia, 170 km (105 mi) NW of Rio de Janeiro; around Bom Jardim Do Turvo town; São Do Bocaina village, 23 km (14 mi) SE of Andrelandia, mica pegmatites with some beryl.⁷

EMERALD IN MINAS GERAIS. Schist-type deposits; crystals in decomposed schistose-granitic rocks containing pegmatitic phases; also crystals recovered from detritus. Calmbach vaguely referred to emeralds at São João de Gorotuba, Mu-

nicipio Grão Mogol, the latter town 270 km (166 mi) NW of Governador Valadares in an area principally noted for alluvial diamonds. Equally vague reports apply to emerald near Sabinópolis, Araçuaí and Guanhães, all in pegmatite areas noted for aquamarines, which, in greenish colors, may have been mislabeled "emerald."

True emerald was discovered in 1917, 1919, or 1920, on Fazenda Sossego near Sant'Anna dos Ferros, or Esmeraldas dos Ferros as currently shown on maps, in biotite schist in the Serra das Esmeraldas, about 20 km (12.5 mi) SE of Ferros or about 50 km (31 mi) NE of Itabira. According to Almeida Rolff the crystals are enclosed in biotite-vermiculite schist, the latter enclosing a pegmatite containing goshenite, clear greenish beryl and some emerald.⁸ Ferraz identified the emerald soon after it was found, and stated that "this is the first time that emeralds had been found in Minas Gerais," noting also that the matrix was pegmatite.¹² Da Cunha confirmed that emerald occurs in pegmatite cutting biotite schist.⁷⁸ In earlier days, the deposit yielded a crystal of 500 grams valued at 100 contos of reis, at that time about U.S. \$25,000, and "from the same place were several stones, already cut and polished, absolutely equal in color to the purest gems from Muzo."¹² Herman and Wussow stated "the most beautiful emeralds [from Brazil] came from St. Anna dos Ferros . . . they are mined by the Brazil Emerald and Diamond Mines Co." and noted that the crystals occurred in a pegmatite cutting gneiss.^{45,79}

In 1919 an emerald was found which weighed 2,200 carats, and this and others were exported to Germany.³⁴ H. V. Walter, British consul in Belo Horizonte, visited the mine in 1940 and reported it was being worked by hand in a series of pits. About 1920, W. F. Anderson and Emmet Carney exploited an emerald deposit at Brejaúba, a small village 15 km (9 mi) WNW of Ferros, with considerable profit until the deposit was exhausted.³⁴

Espírito Santo

From the region around Colatina city on Rio Doce, ca. 90 km (56 mi) NNW of the capital city of Vitória, Froes Abreu reported an excellent quality aquamarine crystal of 25.2 kg (55.5 lb) found in alluvium in Vila das Penhas district and valued at one million cruzeiros.⁶⁰ Other fine quality aquamarines were recently found in the same

World Sources of Ore and Gem Beryl / Brazil

area; some have been reported by Froes Abreu from around Leopoldina town, 30 km (18.5 mi) NW of Vitória; others appeared in Município Afonso Claudio, 85 km (53 mi) WNW of Vitória.¹³

In the S part of the state beryls and aquamarines occur in the Castelo area, which is 95 km (59 mi) SW of Vitória, and extends SSE to Cachoeira de Itapemirim and S to the border along Rio Itapoana; beryls and aquamarines also may be found in the municipality Rio Novo at Rodeio, at Pão Gigante, and along Rio Piuma.¹³ Millard described a large complex pegmatite at Mina de São Domingos, located about 23 km (14 mi) W of Muquit, that was originally opened for beryl but was mined principally for enormous topaz crystals, one of which measured 5 × 10 × 2 m (15.5 × 32 × 6.5 ft) and weighed 350 tons; other minerals included rose quartz and rock crystal.

Rio de Janeiro

As may be expected, the earliest recorded finds of beryls were made in this small coastline state whose settlement dates to the first colonization of Brazil by the Portuguese. Large crystals from pegmatite at Gamboa near Vallongo, Serra da Providencia, were found in 1814; the largest was 6.5 kg (14 lb) and fetched £ 1,500; another was 18 × 2.5 cm (7 × 1 in) and sold for £ 600.^{13,56} Within the city itself, Calmbach recorded beryl occurring at Avenida Atlantica, between Rua Otto Simon and Rua Rudolpho Dantas, and at Morro da Viuva, Meyer, and Praia das Virtudes.¹³

Leonardos gave these localities for beryl: Município de Itaboraí near Rio de Ouro Station, 45 km (28 mi) ENE of the city; Município Rio Bonito in various pegmatites at Duas Barras; around Capivari, 90 km (56 mi) ENE of the city; Município Glicério at Tira-Teima, 5 km (3.1 mi) S of Glicério (small crystals).⁷⁴ Much beryl was mined from Serra de Glicério, and one large crystal weighed hundreds of kg and was transparent gem material in part. In Valão do Barro, between Santa Maria Madalena and São Fidelis in Município S. M. Madalena, beryl occurs in crystals 20–30 cm (8–12 in) long. Some beryl occurs in Município Cantagalo, also in Vila Penteha district, and in Município Valença area. Calmbach mentioned sources at Petropolis, 45 km (28 mi) N of Rio de Janeiro, at Maricá, 40 km (25 mi) E on the coast, in Município Macaé (Macahé),

160 km (100 mi) ENE of Rio de Janeiro on the coast, and at Rio Ouro, Município São Gonçalo.

São Paulo

Very small amounts have been found in this state. Moraes describes beryl from this state but predicted that production would be small.⁸¹

Paraná

Oakenfull⁵¹ mentions that small quantities of gem aquamarine were recovered from alluvials of Rio Goaratuba (or Guaratuba).¹³

1. Eschwege, W. L. v. 1833. *Pluto Brasiliensis*. Berlin: G. Reimer. 622 pp. (Section 4: Diamanten und farbige Edelsteine, pp. 345–90).
2. Souza, A. J. A. de. 1943. Aspectos da economia da pedras preciosas. *Mineração et Metalurgia* (Rio de Janeiro) 7:257–62.
3. Gesner, C. 1565. *De Rerum Fossilium, Lapidum et Gemmarum*. Zurich. Ca. 298 ff.
4. Paiva, G. de. 1946. Províncias pegmatíticas da Brasil. *Brasil Departamento Nacional da Produção Mineral, Divisão Fomento da Produção Mineral, Boletim* 78 (Rio de Janeiro) pp. 13–21.
5. Mawe, J. 1812. *Travels in the Interior of Brazil*. London: Longman, Hurst, Rees, Orme, and Brown. 366 pp.
6. Diniz Gonsalves, A. 1949. *As Pedras Preciosas na Economia Nacional*. Rio de Janeiro: Grafica Olímpica Editora. 457 pp.
7. Pecora, W. T. et al. 1950. Mica deposits in Minas Gerais, Brazil. *U.S. Geological Survey Bulletin* 964-C: 205–305.
8. Almeida Rolff, P. A. M. 1968. The aquamarine-bearing regions of Brazil. *Lapidary Journal* 22:1044–49.
9. ———. 1970. The geologic environment for emerald in Brazil. *Lapidary Journal* 23:1488–90, 1492–1502.
10. Johnston, W. D. 1945. Beryl-tantalite pegmatites of northern Brazil. *Geological Society of America Bulletin* 56 New York 1015–70.
11. ———. 1945. Pegmatitos ambligonita-berilo-tantalíferos de Ceará, Nordeste do Brasil. *Departamento Nacional da Produção Mineral, Divisão Fomento da Produção Mineral Avulso* 66. 43 pp.
12. Ferraz, L. C. 1929. *Compendio dos Mineraes do Brasil em Forma de Dicionário*. Rio de Janeiro: Imprensa Nacional. 645 pp.
13. Calmbach, W. F. v. 1938. *Handbuch brasilianischer Edelsteine und ihrer Vorkommen*. Rio de Janeiro: N. Medawar. 220 pp.
14. Putzer, H. 1956. *Mineralmacht Brasiliens*. São Paulo: Deutsch-Brasilianische Handelskammer. 129 pp.
15. Almeida Rolff, P. A. M. 1945. Geologia da provincia tantaló-glucínifera da Borborema. *Brazil Dept. Nac. da Prod. Min., Div. Fomento da Prod. Min. Bol.* 73. 72 pp.
16. ———. 1943. Berilo e tantalita no Nordeste. *Mineração e Metalurgia* 7:289–90.
17. ———. 1945. Notas sobre a geologia do Nordeste. *Mineração e Metalurgia* 8:321–3.

BERYL LOCALITIES

18. Putzer, H. 1957. Die Scheelit-Beryll-Tantalit Provinz des Hochlandes der Borborema, Nordöst-Brasilien. *Zeitschrift für Erzbergbau und Metallhüttenwesen* 10:20-32.
19. Almeida Rolff, P. A. M. 1946. Reservas minerais do Município de Picui. *Brasil Dept. Nac. da Prod. Min., Div. Fomento da Prod. Min., Avulso* 73, 26 pp.
20. Schneiderhöhn, H. 1961. *Die Erzlagerstätten der Erde*. Vol. 2: *Die Pegmatite*. Stuttgart: Gustav Fischer. 721 pp.
21. Almeida Rolff, P. A. M. 1946. Minerais dos pegmatitos da Borborema. *Brasil Dept. Nac. da Prod. Min., Div. Fomento da Prod. Min. Bol.* 78, 76 pp.
22. Johnston, W. D. 1945. Os pegmatitos berilo-tantalífero da Paraíba e Rio Grande do Norte, no Nordeste do Brasil. *Brasil Dept. Nac. da Prod. Min., Div. Fomento da Prod. Min. Bol.* 72, 85 pp.
23. ———. 1945. Pegmatitas berilo-tantalíferos de Parelhas, Rio Grande do Norte. *Mineração e Metalurgia* 8:269-72.
24. Almeida, S. C. de; Johnston, W. D.; Scorza, E. P.; and Leonardos, O. H. 1943. Pegmatitos com berilo, tantalita e cassiterita da Paraíba e Rio Grande do Norte. *Mineração e Metalurgia* vol. 7, no. 39, pp. 115-26.
25. Almeida, S. C. de; Johnston, W. D.; Leonardos, O. H.; and Scorza, E. P. 1944. The beryl-tantalite-cassiterite pegmatites of Paraíba and Rio Grande do Norte, northeastern Brazil. *Economic Geology* (Lancaster, Pa.) 39:206-23.
26. Almeida Rolff, P. A. M. 1944. Ambligonita na Paraíba. *Mineração e Metalurgia* 8:149.
27. Erichsen, A. I. 1946. Relatório da Directoria 1944. *Brasil Dept. Nac. da Prod. Min., Div. Fomento da Prod. Min. Bol.* 77, 176 pp.
28. Oliveira, A. I. de. 1945. Relatório da Directoria 1943. *Brasil Dept. Nac. da Prod. Min., Div. Fomento da Prod. Min. Bol.* 75, 216 pp.
29. Pough, F. H. 1945. Simpsonite and the northern Brazilian pegmatite region. *Geological Society of America Bulletin* 56:505-14.
30. Catriu, L. 1944. Mina de berilo e columbita de Taquinhos, Paraíba. *Mineração e Metalurgia* 7:349-52.
31. Murdoch, J. 1955. Phosphate minerals of the Borborema pegmatites: I. Patrimônio. *American Mineralogist* 40:50-63.
32. Almeida, S. C. de. 1946. Tantalita e berilo em "Alto" Feio e Serra Branca. *Brasil Dept. Nac. da Prod. Min., Div. Fomento da Prod. Min. Avulso* 73, 27 pp.
33. Franco, R. R. 1949. Beryl at Altinho, Pernambuco. *Mineração e Metalurgia* 9:201-2.
34. Draper, T. 1963. A new source of emeralds in Brazil. *Gems & Gemology* 11:111-13, 24.
35. Cotton, W. L. 1970. A trip to the Carnaiba emerald mines of Brazil. *Lapidary Journal* 23:1360-62.
36. Pough, F. H. 1968. The Carnaiba emerald mine. *Lapidary Journal* 22:1162-64, 1166.
37. Selig, B. L. 1965. Carnaiba emerald mine. *Gems & Minerals Magazine* 331:22-4.
38. Ball, S. H. 1931. Historical notes on gem mining. *Economic Geology* 26:681-738.
39. Just, E. 1926. Emeralds at Bom Jesus dos Meiras, Bahia, Brazil. *Economic Geology* 21:808-10.
40. Bodenlos, A. J. 1954. Magnesite deposits in the Serra das Eguas, Brumado, Bahia, Brazil. *U.S. Geological Survey Bulletin* 975-C:87-170.
41. Siedel, P. 1914. Beiträge zur Kenntnis einiger Mineralien aus Villa do Bom Jesus dos Meiras, Brasilien. *Neues Jahrbuch für Mineralogie* (Stuttgart) Beilage Bd. 38:759-804.
42. Uhlig, J. 1915. Monazit vom Bom Jesus dos Meiras, Provinz Bahia, Brasilien. *Centralblatt für Mineralogie* . . . (Stuttgart) Abt. A:38-44.
43. Arlt, H., and Steinmetz, H. 1915. Über ein neues Mineralvorkommen aus Brasilien. *Zeitschrift für Kristallographie* . . . (Leipzig) 54:590-606.
44. Michel, H. 1927. Der brasilianischer Smaragd. *Centralblatt für Mineralogie* . . . Jg. 1927, Abt. A:218-20.
45. Herman, F., and Wussow, D. 1935. The emerald deposits of the world. *Mining Magazine* 53:20-25.
46. Farrington, O. C. 1934. The gem collection in Field Museum. *Gems & Gemology* 1:75-9.
47. Leinz, V., and Leonardos, O. H. 1936. Notas sobre as esmeraldas da Fazenda das Lages, Itaberahy, Goyaz, Brasil. *Servicio de Fomento da Produção Mineral Avulso* 13 (Rio de Janeiro) 14 pp.
48. ———. 1959. Notas sobre as esmeraldas da Fazenda das Lages, Itaberahy. *Gemologia* (Rio de Janeiro) 16:7-14.
49. Miller, B. L., and Singewald, J. T. 1919. *The Mineral Deposits of South America*. New York: McGraw-Hill Book Co. 598 pp.
50. Freyberg, B. v. 1934. *Die Bodenschätze des Staates Minas Gerais, Brasilien*. Stuttgart: E. Schweizerbart. 453 pp.
51. Oakenfull, J. C. 1913. *Brazil in 1912*. London: Robert Atkinson. 498 pp.
52. Klein, F. 1941. *Smaragde unter dem Urwald*. Berlin: Oswald Arnold. 285 pp.
53. Kunz, G. F. 1911. [On x-ray coloration of beryl]. *American Journal of Science* 31:45.
54. ———. 1911. Precious stones. Chapter in *The Mineral Industry during 1910*, Vol. 19. New York: McGraw-Hill Book Co. 27 pp.
- 55a. Dreber, O. 1912. Grosser Aquamarinkrystall aus Brasilien. *Centralblatt für Mineralogie* . . . etc., 1912, no. 11, p. 338.
- 55b. Becker, G. 1980. Personal communication, 26 August 1980.
56. Oakenfull, J. C. 1922. "Brazil" A Centenary of Independence, 1822-1922. Freiberg, I. B.: C. A. Wagner. 826 pp.
57. Hahn, M. 1955. Edelsteine und Perlen. In *Schmuck und Edelsteine* by E. Schondorff. Munich: Droemische Verlagsanstalt. 237 pp.
58. Ball, S. H. 1943. Gem stones. Chapter in *U.S. Bureau of Mines Minerals Yearbook 1942*, pp. 1509-20.
59. Bastos, F. M. 1964. A 15.4 pound Brazilian aquamarine. *Gems & Gemology* 11:239-41.
60. Fröes Abreu, S. 1965. *Recursos Minerais do Brasil. Minerais não Metálicos*. Vol. 1, 2nd ed. Instituto Brasileiro de Geografia e Estatística, Conselho Nacional de Geografia Publ. No. 20 (Rio de Janeiro), 505 pp.
61. Schupp, K. 1955. Vierunddreissig Kilo schwere Aquamarin. *Zeitschrift der deutsche Gesellschaft für Edelsteinkunde* (Idar-Oberstein) 11:23.
62. Fernandes, X. P. 1905. Aquamarines and tourmalines

World Sources of Ore and Gem Beryl / Bulgaria

- at Arassuahy in Minas Gerais. *Brazilian Engineering and Mining Review* (Rio de Janeiro) vol. 2, no. 3, p. 42.
63. Schlossmacher, K., and Klang, H. 1935. Der Maxiberyll I. *Zentralblatt für Mineralogie . . . Abt. A.*, pp. 37-44.
64. Roebing, W., and Tromnau, H. W. 1935. Maxibe Beryll II. *Zentralblatt für Mineralogie . . .*, pp. 134-39.
65. Nassau, K., and Wood, D. L. 1973. The nature of the new Maxibe-type beryl. *Lapidary Journal* 27:1032-38, *passim*, 1052-58.
66. Pough, F. H. 1968. The Tres Barras aquamarine mine. *Lapidary Journal* 22:1038-42.
67. ———. 1968. Aquamarines abundant in Brazil's new find. *Jewelers' Circular-Keystone* (Philadelphia) vol. 139, no. 3, pp. 30, 32, 52-3.
68. Guimares, D. 1948. Age determination of quartz veins and pegmatites of Brazil. *Economic Geology* 43:100-18.
69. Bank, H. 1970. Mineralfundstellen in der Umgebung von Governador Valadares in Minas Gerais, Brasilien. *Der Aufschluss* (Heidelberg) 21:47-54.
70. Pecora, W. T.; Switzer, G.; Barbosa, A. L.; and Myers, A. T. 1950. Structure and mineralogy of the Golconda pegmatite, Minas Gerais, Brazil. *American Mineralogist* 35:889-901.
71. Pecora, W. T., and Barbosa, A. L. M. 1945. Mica na Serra dos Laurenços, Peçanha, Minas Gerais. *Brasil Dept. Nac. da Prod. Min., Div. Fomento da Prod. Min. Avulso* 68, 42 pp.
72. Lindberg, M. L., and Pecora, W. T. 1955. Tavorite and barbosalite, two new phosphate minerals from Minas Gerais, Brazil. *American Mineralogist* 40:952-66.
73. Lindberg, M. L. 1958. The beryllium content of roscherte from the Sapucaia pegmatite mine, Minas Gerais, Brazil and from other localities. *American Mineralogist* 43:824-38.
74. Leonardos, O. H. 1936. Um jazida de beryllio, mica, columbita, annerodita e monazite, em Sabinópolis, Minas Gerais. *Mineração e Metalurgia* 1:15-16.
75. Almeida Rolff, P. A. M. 1953. O pegmatito tántalo glucinífero do Lino, Alto Rio Doce, Minas Gerais. *Escola Minas, Ouro Preto, Revista* 18:13-14.
76. Moraes, L. J. de. 1926. Nota sobre algumas jazidas de beryllio e mica do valle do Rio Doce, Estado de Minas Gerais. *Servico Geologico e Mineralogico do Brasil Boletim* 18 (Rio de Janeiro) pp. 21-32.
77. Klepper, M. R.; Larrabee, D. M.; and Barbosa, A. L. M. 1945. Mica, Lavra do Pequeri, Bicas, Minas Gerais. *Brasil Dept. Nac. da Prod. Min., Div. Fomento da Prod. Min. Avulso* 69, 37 pp.
78. Da Cunha, O. L. 1961. Esmeraldas da Fazenda do Sossêgo, Santana de Ferros, Minas Gerais, Brasil. *Gemologia* 28:9-14.
79. Bastos, F. M. 1965. Occurrences of emerald in Brazil. *Lapidary Journal* 19:450, 460-1.
80. Millard, W. J. 1944. Pegmatito com topazio de São Domingos, Muqui, Espírito Santo. *Mineração e Metalurgia* 7:159.
81. Moraes, L. J. de. 1944. Uma nova ocorrência de berilo no Estado de São Paulo. *Universidade São Paulo Faculdade de Filosofia, Ciências e Letras Boletim* 45, Geologia no. 1, pp. 3-14.

BULGARIA

Beryl occurs in granitic pegmatites, in the central Rhodope Mountains of S central Bulgaria, ca. 50 km (31.5 mi) S of Plovdiv.¹ Notable alteration product of beryl occur in several bodies at Smilovene, Koprivshtitsa district, as bavenite and bertrandite.² Beryl appears in pegmatite at Gaytanimovo.

EMERALD AT RILA. This is a little-known deposit, described by Petrusenko et al.,³ in which crystals occur in plagioclase pegmatites in a complex of greisen, amphibolite, and marble on flanks of the Peak of Damga, Urdini Lakes region, Rila Mountains. The principal body is about 20 m (24 yd) long and 2.5 m (2.7 yd) wide, intercalated between biotite gneisses and a sheet-like body of serpentized ultrabasic rock. Zoning in the body is distinct, with emerald occurring mainly in plagioclase (oligoclase) and phlogopite zones. Associates are common beryl, feldspars, amphibole, quartz, muscovite, garnet, apatite, zircon, allanite, columbite, rutile, epidote, magnetite, spinel(?), fuchsite, phengite(?), pyrite, chalcopyrite, molybdenite, bismuthinite, bismutite, calcite, guembelite and iron hydroxides. Emerald crystals are long-prismatic or in radial aggregates of slender prisms intimately associated with biotite. Forms: $m\{10\bar{1}0\}$, $c\{0001\}$, also $s\{11\bar{2}1\}$, $p\{10\bar{1}1\}$, $a\{1120\}$, and $i\{21\bar{3}0\}$. Size: 1 mm to 5-6 mm long and to 2.5 mm diameter. Some are partly dissolved and recrystallized; others are broken and recemented with plagioclase. R.I.: $o = 1.578 \pm 0.001$, $e = 1.573 \pm 0.001$; $G = 2.68$. Spectrography: Cr ca. 0.01%, Li ca. 0.1-0.01%, Cu ca. 0.01-0.001%, Fe ca. 0.01%, Ga ca. 0.001%. Inclusions are biotite, rutile and epidote.

In another area, a beryl-bearing pegmatite lies about 8 km (5 mi) from Vishcheritsa village, or about 60 km (37.5 mi) S of Velingrad. Characteristics are: crystals to 20 × 12 cm (8 × 4.7 in); forms m and c , rarely p ; mostly yellowish, sometimes typical aquamarine blue; R.I. $o = 1.574 \pm 0.001$, $e = 1.572 \pm 0.001$; $G = 2.65-2.64$. There are other beryl-bearing pegmatites in the vicinity. At Chepelare, ca. 50 km (31 mi) directly S of Plovdiv, beryl occurs in small simple crystals to 5 cm in pegmatite.

More remarkable is an occurrence at Akhryane, where granitic pegmatites are noted for euhedral beryl crystals, sometimes perfectly transparent and up to 3 cm (1.25 in) long, which occur in

BERYL LOCALITIES

Table 14-6
CHEMICAL ANALYSIS OF RILA EMERALD

Percent		Percent		Percent		Percent	
SiO ₂	63.63	Cr ₂ O ₃	0.0039	K ₂ O	0.007	Na ₂ O	0.90
Al ₂ O ₃	15.95	MgO	1.00	Rb ₂ O	0.002	H ₂ O-	1.16
BeO	13.10	CaO	1.53	Cs ₂ O	0.06	H ₂ O+	1.16
Fe ₂ O ₃	0.48	Ignition loss @ 900°C = 1.39%					
Trace elements: Mn, V, Cu, Co., Ni, Ga, Sn, Pb.							

Alkali Contents with R.I. and S.G.

Color	<i>o</i>	<i>e</i>	<i>G</i>	Na ₂ O	K ₂ O	Rb ₂ O	Cs ₂ O
Emerald green	1.577	1.572	2.69	0.91	0.12	0.033	0.077
Emerald green	1.580	1.577	2.69				
Green	1.581	1.577	2.69	0.90	0.07	0.020	0.055
Yellow	1.583	1.5789	2.70				
Pale yellow	1.579	1.574	2.71				

vugs. Forms are: *m* and *c*, sometimes also *p* and *s*, and more rarely, others. Associates are K-feldspar, quartz (colorless, smoky, amethystine), muscovite, albite, andalusite, cordierite, tourmaline, columbite and allanite. Chemical analyses of six beryls from Vishcheritsa and one from Smilovene appear in Kostov et al., p. 221.¹

1. Kostov, I.; Breskovska, V.; Mincheva-Stephanova, Y.; and Kirov, G. N. 1964. *Mineralite v Bulgariya* [Minerals of Bulgaria]. Sofia: Izdatelstvo Bulgarskata Akademiya Naukite. 540 pp. Beryl pp. 217-23.
2. Ivanov, I. M., and Arnaudov, V. 1964. [Hydrothermal mineralization of the pegmatites from Smilovene, Koprivshitsa district]. *Bulgarian Academy of Sciences, Geological Institute Bulletin* 13, pp. 71-80.
3. Petrusenko, S.; Arnaudov, V.; and Kostov, I. 1966. [Emerald pegmatite from the Urdini Lakes, Rila Mountains]. *Annuaire de l'Université de Sofia, Faculté de Géologie et Géographie* 59:247-68.

BURMA

Beryl gemstones are singularly lacking in the Mogok gem gravels and only an occasional aquamarine is found. Mason states that beryls occur in the Irrawaddy River gravels but gives no details, and there is no subsequent verification.¹ Chhibber mentions sea-green and blueish aquamarine from the famous Sakangyi pegmatite body located near mile 42 on Thabeitkyin-Mogok road.² This deposit is better known as a source of

enormous clear quartz crystals, large topaz crystals, and also colored tourmalines. Common beryl with wolframite occurs in quartz veins of the Yamethin district, near the summit of Byingyi Range on the border between Yamethin district and Loi Long States, Southern Shan States.²

1. Mason, F. 1850. *The Natural Productions of Burmah, or Notes on the Fauna, Flora, and Minerals*. 2 vols. Moulmain, Burma: Beryl vol. 1, p. 28.
2. Chhibber, H. L. 1934. *The Mineral Resources of Burma*. London: Macmillan and Co. 320 pp. Beryl pp. 21, 188, 196, 206.

CANADA

Newfoundland

Beryl occurs in pegmatite near Nutak Island, NE coast of Labrador, ca 455 km (285 mi) NNE of Goose Bay.¹ On Newfoundland it exists in pegmatite with tourmaline, zircon, uraninite, and magnetite along the highway S of Oxback Pond, Indian Head area, St. George's Bay.^{1,2,3} Common beryl crystals range to 20 mm (0.75 in) diameter in pegmatite on Western Head, Cinq Cerf Bay area.²

New Brunswick

Gloucester Co. Small green prisms up to 7.5 cm (3 in) long with molybdenite occur in granite

World Sources of Ore and Gem Beryl / Canada

NW of Pabineau Lake ca. 16 km (10 mi) SW of Bathurst.⁴

York Co. Small crystals with tourmaline and molybdenite in pegmatite stringers occur in granite 2.4 km (1.5 mi) W of Zealand Station and also in pegmatite nearby. Near the junction of Burnt Hill Brook, SW Miramichi River, beryl occurs in Burnt Hill Tungsten mine as pale green radiating prisms to 5 cm (2 in) long, associated with wolframite, cassiterite, quartz, topaz, apatite, fluorite, zinnwaldite and sulfides.⁵

Nova Scotia

Lunenburg Co. Beryl occurs in a small complex pegmatite ca. 4.8 km (3 mi) W of New Ross by road and a little S of the road.⁶ This body was compared in mineralogical complexity to that of Branchville, Connecticut by Schneiderhöhn.⁷ It contains amblygonite, apatite, cassiterite, niobite, fluorite, hematite, huebnerite, lepidolite, magnetite, monazite, scheelite, topaz, tourmaline,

wolframite, zinnwaldite, also molybdenite, bismutite and several sulfides.

Queens Co. Beryl is found in pegmatites in a 27 km (17 mi) wide belt of coastline from Sandy Cove to Western Head, including Port Mouton, Mouton Island, Hunt's Point, Wharf, and Somerville Beach (in boulders). The bodies are intruded in granite near contacts with quartzites and schists. Port Mouton is 113 km (77 mi) SW of Halifax. All of the beryl is the common variety and no prisms exceed about 8 cm (3 in) long.^{1,2,3}

Shelburne Co. Pale green crystals of small size appear with molybdenite and tourmaline in a quartz vein 0.8 km (0.5 mi) E of a point 4.8 km (3 mi) by road N of Jordan Falls.^{1,2,3}

Quebec

Beryl is reported in pegmatites at several points in Drucourt and Johan Beetz townships along SE coast about N of the midpoint of Anticosti Island: Quetachou Bay, mouth of Watshishou River.^{1,3}

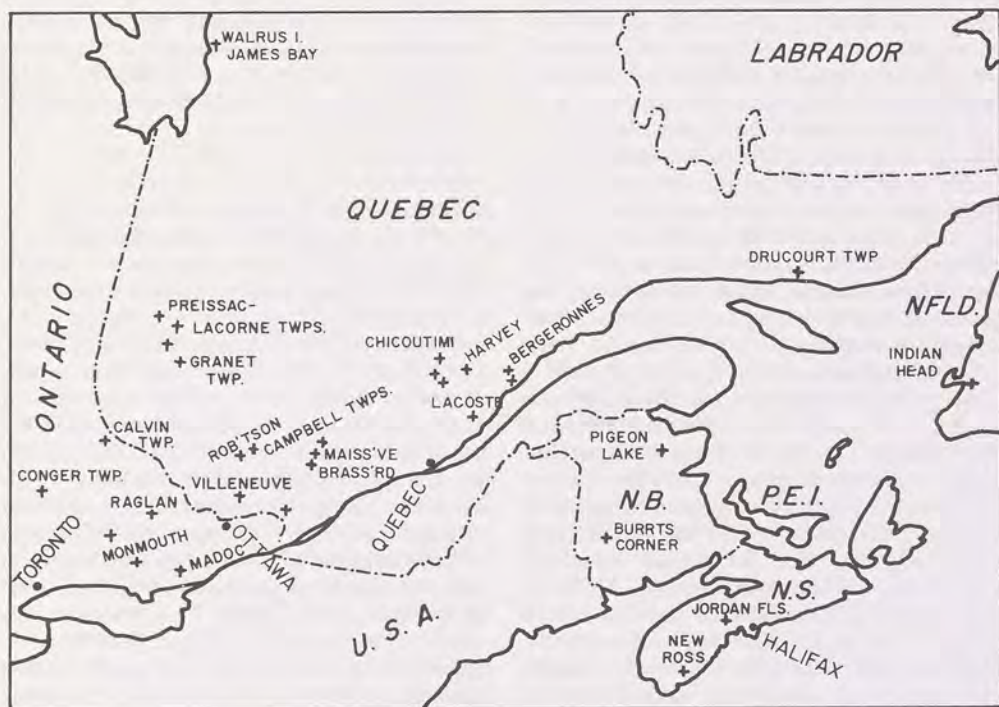

Fig. 14-15 Sketch map of Eastern Canada showing some beryl deposits. From Canada Geological Survey Map 1045A-M2, 1958.

BERYL LOCALITIES

Saguenay district: crystals to 7.6 cm (3 in) in McGie Mica mine, Bergeronnes Twp., Block G., N of Point Aux Sauvages.^{6,8}

Chicoutimi Co. Beryl exists on dumps of Lac Xavier Mica mine, Harvey Twp. Greenish masses occur with mica, cleavelandite, topaz and amazonite on Lot 13, Range V., Taché Twp.⁶ but Sabina places it on W shore of Lac à la Mère.⁸ In Kenogami Twp., it is found in pegmatite stringers on Lot 1, Range II.^{1,3,6}

Charlevoix Co. Beryl may be found in the following locations: in mica pegmatite at Lac Pied des Monts, Lacoste Twp., ca. 27 km (17 mi) NW of La Malbaie⁸; at James Bay on Walrus Island; on the W shore near the center of Sept-Milles Island; at Rupert Bay as yellow crystals to 2 cm; with molybdenite in pegmatites on Harricanaw River shores about 80 km (50 mi) SW of Ft. Rupert.⁹

Abitibi-East Co. Beryl occurs in pegmatites bordering Preissac-Lacorne granite batholith in an area about 64 km (40 mi) ENE of Noranda. It is most abundant in bodies penetrating the batholithic rocks with crystals of pale green, blue-green, and pale blue to 7.6 cm (3 in) diameter.¹⁰ Some bodies contain tantalite and spodumene.¹¹ In the Height-of-Land mine, Preissac Twp., beryl and phenakite occur with molybdenite and bismuthinite on Lot 22, Range X., about 1.6 km (1 mi) N of Preissac village. The crystals are bright green and yellow, partly translucent, to 7.6 cm (3 in) diameter.^{1,6,8} In Lacorne Twp. about 100 kg (220 lb) of beryl were once recovered per month from Lacorne Molybdenite mine; some were deep blue or green, as compound crystals and masses to 30 cm (12 in) diameter.^{1,8,10} Beryl occurs in pegmatite on Lot 1, Range I, and Lot 2, Range II. The Massberyl Co., Ltd., held rights to Lots 7, 8, Range VII, 10-12, and the S half of 13, also to Lots 16-19, Range VIII, with explorations in 1954 showing at least 17 bodies containing an estimated 3.84% beryl in crystals to 15 cm (6 in) in diameter. Valor Mine, Ltd., held rights to the N half of Lots 24-30, Range VI; Lots 19-23 and the S half of Lots 24-30, Range VII; Lots 20-23, Range VIII; and Lots 17-20, Range IX, all of interest because of pegmatites containing beryl and other potentially valuable pegmatite species. Some beryl was also found on Lot 22, Range VIII and on the Heroux-Gamache-Massicotte property in the S half of Lots 14-19, Range VIII.¹⁰ In Lamotte Twp. beryl occurs with

spodumene in the S half of the twp. and on Lots 60, 61, Range X and Lot 64, Range IX. In Fiedmont Twp. it occurs with molybdenite on Lots 41-44, Range IV. Figuery Twp. contains beryl on Lots 20-33, Range I and in pegmatites near the granite massif covering large areas of Ranges I and II. Villemontel Twp. has beryl in tantalite-spodumene pegmatites; Landrienne Twp. on Lots 25, 26, Range I.

Rouyn-Noranda Co. Here beryl was reported in Desroberts Twp. and Granet Twp.^{1,3}

Berthier Co. Maisonneuve Twp. contains beryl at Lots 1, 2, Ranges II, III at a place about 16 km (10 mi) NW of St. Michel des Saints.^{1,3,6}

Labelle Co. Beryl occurs here in Robertson Twp., Lot 25, Range IV at the N end of Lac des Îles, about 11 km (7 mi) SW by road of Mt. Laurier, and also at Lot 26, Range V.

Temiskaming Co. Delbreuil Twp. features abundant beryl as small green crystals in a large pegmatite in NE corner of Lac Simard (Lac Expanse).^{1,3}

Papineau Co. In Villeneuve Twp. beryl may be found in a large pegmatite worked for mica and feldspar on Lot 31, Range I, about 32 km (20 mi) N of Buckingham, a locality favored by mineral collectors.^{8,12,13} Other minor localities given by Traill.³

Ontario

Nipissing Co. Beryl occurs in Calvin Twp. on Lot 13, Concession IV and about 1.6 km (1 mi) NW of Eau Claire. In Mattawan Twp. it may be found in Purdy Mica mine, about 4.8 km (3 mi) N of Eau Claire.^{1,6,8}

Renfrew Co. In Lyndoch Twp., on Lot 23, Concession XV, a well-known beryl-bearing pegmatite is located about 2.6 km (1.6 mi) N of Quadeville; it was first discovered about 1897 but not opened until 1926. In 1927, 1,782 kg (4,456 lb) of beryl were produced and the mine closed. Some beryl rough was saved during intermittent mining between 1929-50 and in 1950, 22,840 kg (57,100 lb) of ore beryl were sold from the stockpile. Another beryl pegmatite of similar mineralogy is located on Lots 30-31, Concession XV. Both bodies are in Precambrian granitic metasediments, but at Quadeville, the country rock is gneissic granite and the body mainly containing amazonite-perthite, microcline, white and rose quartz, albite, minor schorl, garnet, mica, and rare-element minerals.^{6,8,14,15} The beryl crystals

World Sources of Ore and Gem Beryl / Canada

Table 14-7
CHEMICAL ANALYSIS OF
LYNDOCH BERYL¹⁶

Percent		Percent		Percent	
SiO ₂	64.40	CaO	0.18	Li ₂ O	0.18
Al ₂ O ₃	18.08	MgO	0.33	Na ₂ O	0.35
Fe ₂ O ₃	0.97	MnO	0.04	H ₂ O	1.08
BeO	14.38	K ₂ O	0.18	Total	100.17
					G = 2.726

are well-formed, simple hexagonal prisms, rarely well-terminated, and up to 7.6 cm (3 in) in diameter. Sometimes they range to 20 cm (8 in), and may be as much as 1 m (3 ft) long. Pale blue or greenish hues predominate. The crystals are translucent, much flawed and fissured, but small areas have occasionally yielded gems. The smaller, sharper crystals sometimes afford attractive in-matrix specimens.

Parry Sound Co. Henvey Twp. includes Besner mine, which produces massive greenish-blue, glassy beryl. Crystals to 4 cm (1.5 in) long occur on Lot 5, Concession B, 3.2 km (2 mi) NE of Britt Station or about 86 km (54 mi) S of Sudbury. This body is remarkable for containing thucholite and oil.¹⁷ Beryl also occurs in Conger Twp., SE of the town of Parry Sound.⁶

Thunder Bay Co. Beryl occurs in pegmatite near Saga Lake and in Lake St. Joseph area¹; also in the Conway pegmatite, 9.75 km (6.2 mi) slightly NE of Macdiarmid, which is at the S end Lake Nipigon. On an island in Georgia Lake, 8 km (5 mi) ESE of Orient Bay, in the MNW pegmatite mine, 2.4 km (1.5 mi) W of Cosgrove Lake and in the Swanson pegmatite near the MNW beryl also found. These bodies are essentially feldspar-quartz with mica, but also contain spodumene and sometimes cassiterite and columbite, with relatively uncommon beryl in whitish anhedral crystals.¹⁸

Kenora Co. Small crystals on E shore of English River 3.2 km (2 mi) NW of Separation Rapids and 4.8 km (3 mi) W of Oneman Lake, about 40 km (25 mi) NNW of Kenora. Beryl in pegmatites on the E shore of Medicine Lake, Tustin Twp. Small green crystals have been found on Lot 17, Concessions VII and VIII about 16 km (10 mi) E of Dryden, Zealand Twp. NW of Ghost Lake about 4.8 km (3 mi) farther NE from the

last locality.^{1,3} Beryl has been reported in pegmatites around Linklater Lake in Caribou-Pikiti-gushi area.¹

Rainy River Co. Translucent yellow-green crystals to 5 cm (2 in) were found on an island in Turtle Lake, about 32 km (20 mi) NW of Atikokan.^{1,8,19}

Manitoba

Beryl, spodumene, apatite reported in many pegmatites in Cross Lake area about 80 km (50 mi) N of Norway House settlement, the latter at the inlet of NE Lake Winnipeg.²⁰ In the Wekusko Lake district beryl occurs near village of Herb Lake on the E shore of Wekusko Lake, about 136 km (85 mi) E of Flin Flon. It occurs also in spodumene pegmatites in two places near the narrows leading into Crowduck Bay, Wekusko Lake, or about 16 km (10 mi) N of Herb Lake village. Another beryl pegmatite occurs ca. 4 km (2.5 mi) SE of Crowduck Lake. The bodies are zoned and reach lengths of 240 m (800 ft) and contain feldspars, micas, quartz, and several rare species; also beryl in poor crystals of less than 2.5 cm (1 in) size. The Sherritt Gordon property, 0.8 km (0.5 mi) W of Crowduck Bay narrows contains two Li-pegmatites reported to contain golden beryl.¹

In SE Manitoba, a large number of granitic pegmatites occur in a belt that generally parallels the Winnipeg River from near the S end of the lake, thence SSE for a distance of ca. 64 km (40 mi). The area is centered ca. 105 km (65 mi) NE of Winnipeg. The bodies contain Li and Be species as well as other rare-element minerals and occur close to the borders of intrusive granitic rock masses. Many bodies are zoned. Beryl is usually unimportant and is commonly associated with albite, tantalite-columbite, and in places with topaz, monazite, euxenite.^{21,22} In the Lac du Bonnet mining division pale green and white beryl may be found in pegmatites around Cat Lake, 32 km (20 mi) NE of the E extremity of the lake and in central Twp. 19, Range 15.^{20,23} Farther S, extending into the Winnipeg River pegmatite fields, the bodies intrude volcanic and granitic rocks near margins of large granite masses; most bodies are in the granite, and beryl is most likely to be found in flat-lying bodies. Around Oiseau (Bird) Lake, Booster Lake, Bernic Lake, Shatford Lake, and along the Winnipeg River nearby in an area is about 19 km (12

BERYL LOCALITIES



Fig. 14-16 Sketch map of Manitoba-Ontario region showing some beryl deposits. From Canada Geological Survey Map 1045A-M2, 1958.

mi) E of the E end of Lac du Bonnet.^{20,24} Considerable exploration has been done for rare-element minerals, including beryl, but few deposits offer remarkable mineral specimens. Some beryl crystals with clear areas affording small gems were found on the Evans claim on the water edge of S side of Winnipeg River, ca. 14 km (9 mi) above Pointe du Bois.²³ The Huron, or Silverleaf, or Bob claim is remarkable for large green crystals and irregular masses of golden beryl to 46 cm (18 in) across, while the Annie claim and Grace claim yielded crystals from 25–30.5 cm (10–12 in) in diameter.^{24,25} In a complex pegmatite in the Falcon Lake–West Hawk Lake area,

4.8 km (3 mi) NE of Glenn.²⁰ The principal Manitoba occurrences are described by Mulligan.¹

Saskatchewan

Opaque, yellow-green beryl occurs in the Birch Portage area, ca. 48 km (30 mi) W of Flin Flon as crystals to 2.5 cm (1 in). Beryl has been identified in 61 pegmatites in this area.²⁶

Northwest Territories

Beryl is found in pegmatites NW of Paul Lake, 64°44' N, 110°19' W, and Lac de Gras-Aylmer Lake area, 63°59' N, 108°32' W, or about 320 km (200 mi) NE of Yellowknife and in Reid Lake

World Sources of Ore and Gem Beryl / Canada



Fig. 14-17 Sketch map of Western Canada showing some beryl deposits. From Canada Geological Survey Map 1045A-M2, 1958.

BERYL LOCALITIES

area, 63°44' N, 109°55' W.^{1,3} Nearly 500 granitic pegmatite bodies were examined by geologists in the Yellowknife-Beaulieu district, located about the town of Yellowknife along the N shore of Great Slave Lake. The area is estimated to be 12,800 sq km (5,000 sq. mi) and beryl was found in 228 bodies. The pegmatites are related to younger granites which, along with older granodiorites, were intruded into Archean sediments.²⁷ Kretz examined beryl-bearing bodies in the Sparrow Lake-Thompson Lake-Hidden Lake area, 45 km (28 mi) ENE of Yellowknife, and indicated many occurrences on his map.²⁸ The following localities are from Joliffe,²⁷ and Mulligan,¹ and as summarized in Traill.³ See also mineralogically interesting deposits described by Sabina.²⁹

Beryl localities are: S end Prosperous Lake; Blaisdell Lake area, 62°48' N, 113°34' W where beryl is found in bodies that reach 600 m (2,000 ft) in length and up to 3 m (9 ft) in width. Most bodies contain tourmaline but sparse Li mineralization; some are zoned. N of Blaisdell Lake immediately SW of Schist Lake, 62°50' N, 113°34' W, small crystals occur in several bodies. Ross Lake-Redout Lake area (Redout Lake 62°45' N, 113°7' W), contains several hundred pegmatites in gneiss, many with small amounts of beryl. At Sproule Lake, 62°44' N, 113°29' W, SE of the lake, white to pale green crystals to 5 cm (2 in) occur sparsely in 10 of 34 bodies of a pegmatite swarm. At Prelude Lake, 62°39' N, 113°58' W, fifty-six beryl-bearing bodies exist in an area ca. 3.2-5.4 km (2-4 mi) N of the lake. Concentrations in some bodies attain 0.4-2% beryl, with much in crystals larger than 15 cm (6 in). The bodies are distinctly zoned and contain some tourmaline and tantalite-columbite but little Li mineralization. At Bighill Lake, 62°30' N, 114°5' W, some beryl may be found with spodumene in a pegmatite just E of the lake. Buckham Lake, 62°20' N, 112°40' W, has Lit 1 and Lit 2 claims on N shore containing beryl along with spodumene, columbite-tantalite in a zoned body. The same occurs at MacDonald Lake, where Lit 3, or the Ramona group of claims, is located about 8 km (5 mi) SW of the N end of the lake in which are found beryl, spodumene, amblygonite, lithiophilite, and tantalite-columbite. Tanco Lake, the Echo group of claims, 62°26' N, 112°11' W, just SE of Francois Lake, has many beryl crystals up to 7.6 cm (3 in). Hearne Channel, Great Slave Lake, Moose group of claims, 62°11' N, 112°13'

W, located immediately N of channel has beryl in irregular masses with some stockpiled.³ Blatchford Lake, Tan group of claims, 62°12' N, 112°22' W, contains pegmatites near the SE corner of lake. The bodies are zoned and one contains fine crystals. Drever Lake, Best Bet claims, 62°14' N, 112°18' W, just N of the lake, has creamy white crystals to 15 cm (6 in) in a zoned body.

Yukon Territory

Pale green crystals occur in a pegmatite body in granite of Cassiar batholith at Wolf Lake, 60°22' N, 131°20' W.¹ In Horse Ranch Range, 60°21' N, 128°52' W, pegmatites cutting sedimentary and foliated metamorphic rocks contain beryl on 26 claims on the W side of the range crest. Beryl also found in detritus; this locality is placed in British Columbia by Mulligan.¹

British Columbia

Jennings River area 59°59.5' N, 131°36' W, has small, poorly formed opaque blueish-green crystals and shapeless masses in pegmatites cutting altered limestones and quartzites near contacts with a granite pluton.¹ Finlay River area, 65°30' N, 124°30' W, produced pale blueish-green crystals in pegmatites of Butler Range, W of Finlay River (now submerged under Williston Lake). Bodies are numerous, particularly in an area 8-16 km (5-10 mi) S of Ft. Grahame. Beryl occurs in the McConnell Creek area, 56°25' N, 126°77' W, near the source of Doratelle Creek. Near Tete Jaune Cache, the Bonanza Mica mine on Mica Mt., ca. 11 km (7 mi) S of Tete Jaune Cache, 52°53' N, 119°30' W, contains numerous bodies; Topaz is also reported here.^{1,3} Woolsey (Silver) Creek area, near Albert Canyon, 51°7' N, 117°54' W, has beryl in pegmatites along Snowflake Trail, about 3.2 km (2 mi) W of the canyon. Mt. Begbie area, near Revelstoke, 50°53.5' N, 118°15' W, on NE side at a point about 12.8 km (8 mi) S of Revelstoke, has beryl with schorl and a little red and green tourmaline, garnet and lepidolite. At Skookumchuck Creek, East Kootenay, 49°58' N, 116°12' W, it occurs in pegmatites W of Burnt Creek, a tributary. The bodies are numerous, but only a few glassy beryl crystals were found up to 5 cm (2 in) diameter. At White Creek in the same area, blue-green crystals along the border of White Creek batholith. Beryl occurs in road cuts about 4.8 km (3 mi) S

World Sources of Ore and Gem Beryl / Colombia

of St. Mary's Lake, 49°34' N, 116°11' W; and in Angus Creek. Kootenay lake, just S of Midge Creek, about 1.6 km (1 mi) from the lake, large blue-green crystals with garnet, magnetite, and schorl occur.

1. Mulligan, R. 1960. Beryllium occurrences in Canada (preliminary account). *Geological Survey of Canada Paper* 60-21. 40 pp.
2. Sabina, A. P. 1964. Rock and mineral collecting in Canada. Vol. 2. *Geological Survey of Canada Miscellaneous Report* 8. 103 pp.
3. Traill, R. J. 1970. A catalogue of Canadian minerals. *Geological Survey Canada Paper* 69-45. 649 pp.
- 3a. ———. 1974. A catalogue . . . Supplement I. *Geological Survey Canada Paper* 73-22. 260 pp.
4. Wright, W. J. 1940. Molybdenum prospect at Pabineau Lake, Gloucester County, N. B. *New Brunswick Department of Lands and Mines Paper* 40-1.
5. Victor, I. 1957. Burnt Hill wolframite deposit, New Brunswick, Canada. *Economic Geology* (Lancaster Pa.) 52:149-68a.
6. Ellsworth, H. V. 1932. Rare-element minerals of Canada. *Geological Survey Canada Economic Geology Series* No. 11. 272 pp.
7. Schneiderhöhn, H. 1961. *Die Erzlagersstätten der Erde*. Vol. 2: *Die Pegmatite*. Stuttgart: Gustav Fischer. 721 pp.
8. Sabina, A. P. 1964. Rock and mineral collecting in Canada. Vol. 2. *Geol. Survey of Canada Misc. Rept.* 8. 252 pp.
9. Remick, J. H.; Gillain, P. R.; and Durden, C. J. 1963. Geology of Rupert Bay-Missisicabi River area, Abitibi and Mistassini territories, preliminary report. *Quebec Department of Natural Resources, Geological Survey Branch P. R.* 498.
10. Rowe, R. B. 1953. Pegmatitic beryllium and lithium deposits, Preissac-Lacorne region, Abitibi County, Quebec. *Geol. Survey Canada Paper* 53-3. 35 pp.
11. Norman, G. W. H. 1945. Molybdenite deposits and pegmatites in the Preissac-Lacorne area, Abitibi County, Quebec. *Quebec Economic Geology* (Montreal) 40:1-17.
12. De Smid, H. S. 1912. Mica: its occurrence, exploitation, and uses. *Canada Department of Mines, Mines Branch* No. 118. 411 pp.
13. Sabina, A. P. 1969. Rocks and minerals for the collector. *Geol. Survey Canada Paper* 68-51. 107 pp.
14. Ellsworth, H. V. 1927. Lyndochite—a new mineral in the euxenite-polycrase group from Lyndoch Township, Renfrew County, Ontario. *American Mineralogist* 12:212-18.
15. McLaren, D. C. 1946. The Lyndoch beryl deposit. *Canadian Mining Journal* 67:857-62.
16. Walker, T. W., and Parsons, A. L. 1927. Beryl and associated minerals from Lyndoch Township, Renfrew County, Ontario. *University of Toronto Studies, Geological Series, Contributions to Canadian Mineralogy* 24:12-14.
17. Spence, H. S. 1930. A remarkable occurrence of thucholite and oil in a pegmatite dyke, Parry Sound district, Ontario. *American Mineralogist* 15:499-520.
18. Pye, E. G. 1965. Geology and lithium deposits of

Georgia Lake area. *Ontario Department of Mines, Geological Report* No. 31. 113 pp.

19. Meen, B. V. 1959. *Quetico Geology*. Toronto: University of Toronto Press. 54 pp.
20. Davies, J. F.; Bannatyne, B. B.; Barry, G. S.; and McCabe, H. R. 1962. *Geology and Mineral Resources of Manitoba*. Manitoba Department of Mines and Natural Resources, Mines Branch. 190 pp.
21. Davies, J. F. 1955. Geology and mineral deposits of the Bird Lake area, Lac du Bonnet Mining Division, Manitoba. *Manitoba Dept. of Mines and Nat. Res., Mines Branch Publication* 54-1:42-3.
22. ———. 1958. The lithium and beryllium pegmatites of southeastern Manitoba. *Canadian Mining and Metallurgical Bulletin, Transactions* 61:230-36.
23. Stockwell, C. H. 1932. "Lithium deposits" in Geology and mineral deposits of a part of southeastern Manitoba, by J. F. Wright. *Geological Survey Canada Memoir* 169:108-26.
24. Sabina, A. P. 1963. Rocks and minerals for the collector. *Geol. Survey Canada Paper* 63-18. 69 pp.
25. Springer, G. D. 1950. Mineral deposits of the Cat Lake-Winnipeg River area, Manitoba. *Manitoba Dept. of Mines and Min. Res., Mines Branch Publ.* 49-7.
26. Radcliffe, D., and Campbell, F. A. 1966. Beryl from Birch Portage, Saskatchewan. *Canadian Mineralogist* 8:493-505.
27. Joliffe, A. W. 1944. Rare-element minerals in pegmatites, Yellowknife-Beaulieu area, Northwest Territories. *Geol. Survey Canada Paper* 44-12. 23 pp.
28. Kretz, R. 1968. Study of pegmatite bodies and enclosing rocks, Yellowknife-Beaulieu region, District of Mackenzie. *Geological Survey Canada Bulletin* 159. 111 pp.
29. Sabina, A. P. 1964. Rock and mineral collecting in Canada. Vol. 1. *Geol. Survey Canada Misc. Report* 8. 147 pp.

CHILE

Beryl is reported in one occurrence in pegmatite in the Valparaiso district.¹

1. Landes, K. K. 1935. Age and distribution of pegmatites. *American Mineralogist* 20:81-105, 153-75.

COLOMBIA

Colombia stands supreme in respect to emerald, for nowhere else are they found in such consistently high quality and quantity. The deposits were exploited by the natives long before the appearance of Europeans in the 16th century and have been worked more or less continuously since then. Nevertheless, the formations in which they occur are so widespread that new deposits have been found in modern times and the probability is great that still others will be discovered in the future. There will be no shortage of emeralds in our lifetime; indeed, the problem may be one of regulating production to insure that no glut on the

BERYL LOCALITIES

market drives down the price. However, as with so many other precious stones, Colombian emeralds must be won arduously and at high cost.

Although knowledge of emerald among European-Near East cultures antedates the Christian era, emerald became common in world trade only after the Spanish conquests in South America reopened the ancient Indian mines. Initial supplies were obtained by looting in Mexico as well as in South America, but systematic mining commenced very shortly after the deposits were discovered, and large quantities of the crystals were dispatched to Europe. Here they were further redistributed and quickly passed into the hands of Turkish, Persian, and Indian rulers who were particularly fond of emerald and more than willing to exchange gold, which the Spanish wanted, for the Colombian crystals. Thus we find the finest of Colombian emeralds obtained during Spanish colonialization still preserved in such Indian jewelry depicted by Hendley,¹ and in the Iranian treasure described and pictured by Meen and Tushingham,² not to mention important stones in the Topkapi Museum treasury in Istanbul.³ Much less important were Colombian stones incorporated in crowns and other regalia of Europe.^{4,5}

Prior to the conquest, Colombian emeralds were traded into Peru and Ecuador, into Central America, and as far north as Mexico.⁶ Colombian Indian legends concerning emerald are recounted by Otero Muñoz⁷ and Canova,⁸ and strongly suggest that emerald was known and revered for many years before the advent of Europeans. The belief that the Chibcha Indians of Colombia, like the Mayas of Mexico, threw sacrifices and objects of value into lagoons or other bodies of water to appease the gods resulted in a number of attempts to recover treasures of gold and emeralds rumored to lie on the bottom of Lake Guatavita, located about 40 km (25 mi) N of Bogotá. The latest recovery attempt was led in 1966 by a group of adventurers from the United States.⁹

Chronology of Colombian Emerald

1000. A.D., or earlier. Colombian Indians possessed emerald;¹⁰ deposits were exploited and stones traded to other countries before the conquest.⁶

1514. Spanish explorer Pedrarias (Pedro Arias de Avila, 1440?-1531) obtained the first stones when he touched at Santa Marta (Colombia) enroute to Darien (Panama).⁶

1518. Juan de Grijalva (1489?-1527) received a gift of masks "parts of which were covered with turquoise-like stones, which are emerald matrix," from Indian lord of Tobasco,⁶ according to Antonio de Herrera y Tordesillas (1559-1625).¹¹

1519. Hernan Cortés (1485-1547) received gifts, including splendid emeralds, from Montezuma (1480?-1520), and later obtained many fine stones during sacking of Tenochtitlan.⁶

1536. Gonzalo Jimenez de Quesada (1500?-1579?) departed Santa Marta on an expedition of conquest and pacification into the interior of Nueva Granada (Colombia).^{12,13,14}

1537. Quesada penetrated Guachetá valley, receiving nine "green stones" as gifts. Rumors of an emerald mine known as "Somondoco" led a party to Turmequé village where the location of the Chivor mine was disclosed. Captain Pedro Fernández Valenzuela was directed to lead a forty-man party to the site, which was found about nine leagues from Guatequé, close to a waterfall of Nagar River where the Garga River joins the Guavia River.^{8,14} The locality is described as on a tongue of land between Rio Rucio and Rio Sinai. In August, Quesada conquered the Indian town of Tunja and seized 1,815 emeralds in the palace of the fleeing chief, ultimately obtaining over 7,000 stones during his campaign.⁶

1538. City of Bogotá founded by Quesada.

1539. Francisco Pizarro (1475-1541) sent six "Peruvian" emeralds to Queen of Spain and vowed to find the source, but was unsuccessful [because all "Peruvian" stones were imported from Colombia].

1544. Lonso Luis, or Luiz Alfonso de Lugo, organized an expedition to explore the Muzo region.

1545. Captain Diego Martinez, under de Lugo, explored the Fura-Tena and Rio Itoco areas of Muzo; one of his men, Juan de Penagos, obtained crystals of emerald presumably originating from some nearby deposit.¹⁵ Schumacher, however, stated that Penagos found the stones in entrails of domesticated animals.¹⁴

1555 (?). Evidence of nearby source caused Luis Lanchero to found the Villa de Santísima Trinidad de Los Muzos.¹⁴ Otero Muñoz gave the founding date as 1559 or 1560.⁷ Hintze claimed that a certain Andres Diaz Venero de Leiva was the first to suspect a local source because

World Sources of Ore and Gem Beryl / Colombia

- of accidentally finding an emerald in the helmet of a Muzo Indian; he gave the founding date as 1559.¹⁶
- 1555, ca. Captail Valenzuela worked the Chivor deposit with great energy using enslaved Indian labor, but inhumane treatment led to complaints to the Crown by resident Catholic priests and eventually resulted in reforms.¹⁷
1558. Mining began at Muzo under Francisco Morcillo and was vigorously pressed despite harassment and repeated attacks from natives. In the next several years important quantities of stones were sent to Spain, including two crystals valued in Spain at 24,000 gold Castilian guilders,¹⁴ (but see the following entry indicative of confusion in accounts of early Muzo history).
1564. An emerald discovered by a Spanish horseman at Muzo village was identified as such by a native, who stated that more stones were to be found on nearby Cerro de Itoco. The first mayor of Muzo, Alonso Ramírez Gasco Manchego, was credited with discovery of in-place, emerald-bearing, calcite veins.^{7,15} According to Hintze, the first official news of the discovery was sent in this year to Spain.¹⁶
1567. Rich emerald vein was discovered at Abipí, 2.5 leagues from Muzo, but lack of water prevented working, and the site lapsed into obscurity.¹⁸ Compare Wokittel¹⁹ and Hintze¹⁶ who stated that the mine was first worked "intensively"; a company was organized for that purpose in this year.²⁰
1568. Muzo began formal mining.¹⁸ Operations were pursued with great energy and many stones were dispatched to Spain.
- 1572–1612. During this period the Spanish Crown's "royal fifth" duty on mined stones from Muzo totaled 300,000 pesos and averaged 75,000 pesos per year.^{12,14,18}
1592. First grant or "merced" to Chivor mines given to Francisco Maldonado de Mendoza by Presidente Antonio Gonzales (ruled Nueva Granada, 1590–97).⁸
1593. Maldonado constructed the aqueduct to bring water to Chivor mines.⁸ Gonzales issued regulations governing use of native labor and just treatment. A Spanish Crown order decreed freedom from slavery for Indians.
1595. Rodrigo Maldonado, son of Francisco, was appointed "encomendero" or official in charge of Somondoco district to last for "two lives." He thereby obtained virtual power of life and death over all natives, although restrictions on use of labor had already been instituted.⁸
- 1595 ca. Chivor mines were abandoned, but see following entries.
- 1601–1610. Abuses of Indian labor continued at Muzo and corrective decrees were issued by the Crown.
1616. Lesmes de Espinoza Saravia, Oidor or Judge of Inquiry, visited Muzo and Tunja districts to correct continuing abuses of natives.
1636. The official chronicler of Bogotá visited Muzo and reported poverty due to decline in mining brought about by local labor troubles and the impossibility of importing Negro slaves or other cheap labor.¹⁴
1643. Maldonado heirs leased Chivor mines to Miguel Soriano for a seven-year term with proviso that he repair and restore the aqueduct within two years.⁸
1646. Coscuez deposit was discovered and worked for a short period but was abandoned and eventually lapsed into obscurity when a landslide buried 300 miners.
1648. Soriano ousted from Chivor in suit brought by Maldonado heirs.
- 1650 ca. Mining resumed at Muzo in behalf of the Crown, but with poor results.
1660. Francisco Tovar Alvarado sent an emerald to the Crown valued at 10,000 pesos.¹⁴
1664. Viceroy of Nueva Granada sent mineralogist José Antonio de Villegas y Avendaño to Muzo to investigate deposits. A favorable report resulted in opening new sites and the use of opencuts in lieu of tunnels, but production remained low.¹⁴
1672. Francisco Retuerta laid claim to the emerald mine "Concepcion" in Somondoco mountains, but Pedro Solís de Valenzuela, a priest, contested the claim. According to trial testimony the mine had lain idle for fifteen years since 1657.
- 1672 ca. Probable time when Chivor mines lapsed into the obscurity from which they were not to emerge until modern times.
1772. Attorney General Francisco Moreno T. Escandon reported to Viceroy Zerda on Muzo mines and noted their profitable working but stated that the Chivor deposits could no longer be found.¹⁴ Production figures showed that Muzo mines operated continuously from 1766–1772.

BERYL LOCALITIES

1777. Muzo mines under Crown control.
1796. Muzo mines working, but at some time after this date they are again leased to private parties at the pleasure of the Crown and with remission of the usual "Crown fifth."
- 1816-1819. Colombian War of Independence; emerald production virtually nil.²¹ Muzo mines placed under "inalienable" control of the new nation. Contracts let for mining with the government to receive 10% of net profits. This system lasted until 1948.
- 1824-1848. The first Muzo lessee under the new regime was José Ignacio (or Jnacio) Paris, friend of Simon Bolivar and Mariano Eonardo de Rivero, colleague of Boussingault and warden of the Natural Sciences Museum in Bogotá. Paris obtained exclusive rights until 1838. The rights were later extended for ten years to 1848, with royalty payments reduced to 5%.¹⁴
1835. Joaquin Acosta, Colombian engineer and historian, visited the Muzo mines and returned to Europe with a suite of specimens, including the first examples of an unidentified mineral later named parisite after J. J. Paris.
1847. Colombian government promulgated a law permitting all existing emerald deposits to be exploited only on behalf of the nation under regulations that allowed privately owned deposits to continue working, with production taxed, only so long as the work did not cease for longer than one year, in which event the title to the deposit passed to national ownership. As a result of this law, the nation acquired many properties in addition to those at Muzo and those as yet undiscovered.²⁰ In this year, the government issued bid tenders to work Muzo, to take effect upon expiration of the Paris lease.
- 1848 (?). The Government operated Muzo mine under supervision of Thomas Fallon, mining engineer and former superintendent under Paris.²⁰
1849. Government operations at Muzo ceased; mines leased to a London-Bogotá firm, principals Juan de Francisco Martín and Patrick Wilson of Bogotá, and Stiebel Brothers of London. The contract was to expire February 28, 1861; and the company was titled "Sociedad de las Minas de Esmeraldas de la Nueva Granada."^{14,20}
1859. Muzo was crippled by a serious landslide and work ceased.
1860. The government reoffered the Muzo lease, but fear of internal political disorders in Colombia resulted in no takers.
1861. Thomas Fallon was appointed administrator of Muzo mines, assisted by Felipe Paul and work carried on until April, 1865.
1864. On August 1, the government concluded a contract with a Parisian consortium, represented by Gustave Lehmann, to work Muzo for a ten-year period beginning April 1, 1865. Rights granted to consortium not only for Muzo but also for all other deposits belonging to the nation, and "other persons are allowed to work only those mines which without doubt belong to private persons."^{14,20}
1870. Colombian law of May 31 granted the right to freely exploit known emerald deposits *not* belonging to the nation.
1871. A government decree of December 14 provided that emerald mine properties must be extended sufficiently to include not only the mining sites but also such areas in which occur exploited veins, water sources, and all land necessary to operate the mine. The decree was made effective upon expiration of the Muzo lease on April 1, 1875.
1875. Muzo leased to Juan Sordo of Bogotá on April 21; Sordo transferred rights to Compañía de Minas de Esmeraldas.^{7,20}
1883. Stock issue of 100,000 shares at £ 1/- each floated to finance The Emerald Mines (Limited) of London, to develop a property of about 750 acres in Boyacá known as the Esmeralda Emerald Mine, situated about "two leagues" from the Muzo mine in the "same geological formation"; Gustave Lehmann named a director of the company.²²
1886. Terms of the new Colombian Constitution proclaim Muzo and Coscuez the property of the nation.²⁰
1888. Francisco Restrepo read Fray Martín de Aguado manuscript in the library of the Dominican convent in Quito; and obtained clues to the lost location of Chivor mine,²⁰ (but see remarks of F. Klein in 1903 entry).
1889. Restrepo petitioned government of Boyacá Province for exploration rights to Chivor.
1890. The Standard Mining Company, incorporated in 1888, and later changing its name to

World Sources of Ore and Gem Beryl / Colombia

- Emerald Mines of Colombia, registered to work Muzo, but was ordered by government to wind up affairs in 1892.^{23,24}
1891. The Emerald Mining Company reorganized in London; Chivor property (?) purchased for \$1,100,000²⁵ (but see entry under 1896).
1893. Muzo leased to a French-Colombian syndicate.²⁵
1896. Restrepo discovered Chivor workings, including water supply system, opencuts, tunnels, etc.^{8,20}
1897. The company exploiting Chivor (Somondoco) formed but accomplished little up to 1899.²⁶
1900. Somondoco Emeralds, Ltd. was refinanced and paid off old debts.^{27,28,29}
1901. Muzo contract negotiated with Lorenzo Cuellar.²⁰ Upon payment of a sum equivalent to twenty years taxes to the government, perpetual title to Chivor was granted to Restrepo and associates.
1902. Muzo under management of Plantagenet Moore.²⁰
1903. Lease to Muzo-Coscuez offered by government.³⁰ Klein gave this year as the date when Restrepo discovered the Aguado ms in Quito,³¹ which seems to be grossly in error.
1904. The year Klein cited as the time when Restrepo found Chivor.³¹ From 1904 to 1906, Muzo recorded a production of 4,448,435 carats of all grades of emeralds.²⁰
1905. The government decreed on April 5 that henceforth all newly-discovered emerald deposits belonged to the nation.
1906. Muzo mine was leased to a Colombian syndicate for five years under the name Colombian Emerald Company, Limited.³² Dominguez indicates the lease commenced in 1908,²⁰ Herman and Wussow state 1909,²¹ and so does Smith.³³
1911. Restrepo and Klein reopened Chivor.³¹ Government prohibited issuance of any license to work alluvial deposits of emeralds derived from weathering of in-place deposits.³⁴
1912. An attempt by the government to tax Chivor was nullified by the Colombian Supreme Court who reaffirmed that the property was forever free of such taxation (see under 1901).³¹ The government rescinded Muzo lease of Colombian Emerald Mining Company, Limited. Legal steps were taken to restore company rights and eventually the government was forced to pay damages. Muzo became inoperative.³³ According to Herman and Wussow the annulment of the lease took place on January 1, 1913.²¹
1913. Colombian Supreme Court ordered the government to cease and desist from attempts to tax Chivor or to obtain control of property. Muzo mines were closed due to low production and remained closed to 1923.¹⁹ Klein reported favorably on Chivor prospects to German syndicate.³¹
1914. Klein departed for Germany upon outbreak of World War I. Francisco Restrepo died at Chivor. As of this year 157 emerald mines were known.³⁵
1915. Campaña de Minas de Chivor dissolved and a new venture, Sociedad Ordinaria de Minas des Esmeraldas de Chivor, S.A., formed. Rights to Chivor were sold to Wilson E. Griffiths and Carl K. McFadden representing the Colombian Emerald Development Corporation of New York.²⁰
- 1915 or 1916. Small emerald crystals were discovered in calcite deposit exploited for lime at Nemocón.^{36,37}
1918. Colombian Emerald Syndicate, Ltd., obtained option on Chivor to expire in 1919.
1919. Colombian Emerald Syndicate, Ltd., purchased five claims of the Chivor property; and later sold them to Columbia Emerald Development Corporation. The latter then reorganized as Chivor Emerald Mines, Inc.³⁸
1922. Legal difficulties attending the operation of Muzo were settled. The firm of Bauer, Marchal et Cie. was deputed to sell emerald stock in London. Kunz stated that "the entire stock of emeralds, all uncut, was purchased by Messrs. Rosenthal & Cie of Paris, who have cut and are disposing of this accumulation of many years' mining."³⁹ The government reserved the right to resume exploitation of the Muzo mines in fifteen months' time.
- 1925-1927. Muzo closed; production resumed ca. 1935 but from 1928 on the government took charge of selling stones.²¹
1930. Muzo was seized by "armed mob;" lease to government mines was to be sold at auction in September.⁴⁰
1931. Colombian Law 12 was passed to permit leasing of government emerald mines. Work

BERYL LOCALITIES

- at Chivor was reduced or suspended due to political strife. Mines remained virtually closed until 1936.
1933. Muzo reopened under direction of Peter W. Rainier and an American group marketed production on commission basis for the government.⁴¹
1934. Muzo operated part of the year. The government decreed that all persons engaged in selling or cutting emeralds must register, and emeralds found in unregistered hands would be confiscated.⁴²
1937. Chivor Emerald Mines, Inc., lease was made effective September 15 to continue to 1940.
1938. Stockpile size permits closing the Muzo and Coscuez mines.²⁰ Chivor operated on a restricted scale from about November, 1937.⁴³
1946. Mining rights to Muzo were granted by government to Banco de Republica, Bogotá, who in turn subcontracted for the work and for grading and cutting the stones.^{19,20}
1947. Colombian Emerald Development Corporation sold rights to Chivor to Chivor Emerald Mines, Inc., of Delaware.²⁰ Government issued regulations designed to eliminate black market in emeralds.⁴⁴ Minor work was carried out at Coscuez.
- 1948-1949. Muzo operated for about one year at considerable loss. Work was reduced or suspended at Chivor but resumed in 1948.
1949. Muzo and Coscuez shut down for last quarter. Chivor resumed operations but abandoned opencuts for tunnels.
1950. Chivor was practically closed over a bitter struggle between New York and Colombian interest for control of property.⁴⁵ Muzo closed.
1951. Muzo and Coscuez operated in latter part of year. Chivor Emerald Mines, Inc., entered bankruptcy, but workers continued mining and reportedly obtained many fine stones.
1952. Chivor closed. Sporadic operations continued at Muzo and Coscuez.
1954. Emeralds discovered at Las Vegas de San Juan, Gachalá, Cundinamarca Province. Illegal mining removed large quantities of fine stones.⁴⁶
1955. Colombian Decree 0585 established new regulations for emerald mining, in particular giving authority to issue licenses and permits in behalf of the government to the Ministry of Mines and Petroleum Resources for private parties intending to prospect and mine for emeralds.¹⁹
1956. Chivor Emerald Mines, Inc., in receivership of Colombian government since 1952. Willis F. Bronkie appointed trustee.³⁸
1957. Chivor operated under Bronkie.⁴⁷ Gachalá was heavily guarded by government troops. The government was reported to be preparing new decrees regulating emerald mining that would grant rights up to twenty years in return for a nominal percentage of production. The export of rough only instead of cut stones to India would be permitted.⁴⁸ Coscuez closed. Vega de San Juan exploited under permit from Ministry of Mines and Petroleum Resources. Buenavista mine in Municipio de Ubalá, Cundinamarca Province, began operating in December 1957.¹⁹
1959. Colombian Law 145 passed to control mining and disposition of emeralds.
1960. Muzo, Chivor, Vega de San Juan, Buenavista and Coscuez operated.
1961. Banco de La Republica formed Empresa de Esmeraldas, a new company to control and work the mines in behalf of the government, including recently discovered deposits in Boyacá Province. Vega de San Juan closed due to litigation.⁴⁹
1965. Chivor operated, also Muzo and Coscuez and the new Peña Blanca mine at Muzo. Lesser qualities of emerald were sold primarily in Italy, Mexico, and Brazil, with India the biggest buyer of moralla; extra fine stones brought U.S. \$4,000 per carat for "gems of any appreciable size."⁵⁰
1968. Government-sponsored ECOMINAS (Empresa Colombiana de Minas) was authorized to mine Muzo, and buy stones from private sources, and cut and sell stones. The company still existed in 1979.¹⁶ United Press, Bogotá, reported the government was suspending indefinitely all issuance of permits for emerald exploration and mining "in order to regulate national and international dealings in the stones."⁵¹
1970. Colombian court order restored Chivor Emerald Mines, Inc., to its 3,000 United States stockholders who own about 90% of the total of 2,500,000 shares.⁴⁷
1971. Government mines were in a state of disorder with much clandestine mining producing an estimated 90% of all emeralds entering the

World Sources of Ore and Gem Beryl / Colombia

world markets.⁵² Chivor was operated under tight control.⁵³

1976–1977. Anarchy existed at government mines with illegal mining and disposition of emeralds the rule rather than the exception.^{54,55}

For a report on recent mining activities, see P. C. Keller, 1981.⁵⁷

Geology of Colombian Emerald Deposits

Three prongs of the northern end of the Andes form the western portion of Colombia. The mountain cores are igneous and metamorphic rocks, overlain on their flanks by folded and faulted sedimentary rocks of Cretaceous age. The emerald-bearing formations lie along the flanks of the east prong, or the Cordillera Oriental, and occur mainly in the provinces of Boyacá, Cundinamarca, and Santander, or generally N–NE of Bogotá. All deposits are in steep, rugged terrain, solidly covered with lush and largely impenetrable tropical rain forest with dense underbrush. Mine altitudes range from 600 m (2,000 ft) to 1200 m (4,000 ft) above sea level. The terrain reflects weathering and erosion of a series of strongly folded anticlines and synclines of sedimentary rocks, especially limestones.^{16,56}

On the basis of fossils, chiefly ammonites, the age of the emerald-bearing formation and underlying formations at Muzo is fixed as Cretaceous, with Gutiérrez further fixing the age as Lower Cretaceous⁵⁷ although Pogue was of the opinion that further study was needed before a closer correlation was possible.⁵⁸ The geological column at Muzo, which holds more or less true for other distant though similar formations, was given by Pogue as red sandstone with septarian nodules, compact sandstone, gray fossiliferous limestone between layers of gray shale with plant impressions, black carbonaceous shale and shaley limestone (which carry the emerald veins at Muzo), and siliceous schists and conglomerates with jasper and flint,⁵⁸ all compressed into long N-S trending folds generally lacking igneous intrusions.

Bürgl described Muzo stratigraphy: "the mines . . . are situated within a rather uniform series of black shales which frequently present local dislocations and irregularities. These disturbances render it sometimes difficult to recognize the dip . . . of the beds. With the aid of rather badly preserved but . . . sufficiently decisive fossils and by comparison with neighboring regions, it was

possible to recognize [this] stratigraphical sequence:

Upper Albian	1,280 m (4,200 ft)
Higher Middle Albian	1,240 m (4,070) ft
Lower Middle Albian	600 m (1,970 ft)
Lower Albian	230 m (755 ft)
Upper Aptian	1,300 m (4,265 ft)
Barremian (& Lower Aptian?)	300 m (985 ft)
Hauterivian more than	150 m (490 ft)

"The sequence from the Hauterivian up to the Lower Albian is developed E of the Minero River and forms there the narrow Muzo anticline and rises again toward this river. West of the Minero River, in contrast, only Middle and Upper Albian beds are to be found, forming the wide anticline of Itoco, in the core of which the emerald mines are situated. The contact between the . . . units E and W of the Minero River is a NNE-SSW trending (reverse?) fault with some 5,000 m (16,400 ft) of vertical displacement. It is likely that the region is also crossed by NW-SE trending minor faults; one of them has been observed in the immediate neighborhood of the emerald mines."⁵⁹ According to Gansser,⁵⁶ the mines are in the lower portion of the Middle Albian (see Fig. 14-19).

MUZO-COSCUEZ GEOLOGY. The mines are located about 105 km (65 mi) N of Bogotá. More exact positions for some are as follows:

The Muzo mines are in a deep ravine of the SE-flowing Rio Itoco, which joins the N-flowing Rio Minero. The Coscuez mines are about 10 km (6.2 mi) N of the Muzo mines along the margin of the Rio Desaguadero ravine which empties into the ravine of Rio la Caca, the latter flowing W into Rio Minero. These mines lie within the area delineated by Decree 400 of 1899 as shown in Fig. 14-20; the land is national property under control of Banco de la Republica (ECOMINAS).

The workings penetrate a series of black pyritiferous argillites (shales) intercalated with thin-bedded limestones and folded into varying amplitudes as drag folds which have been exten-

BERYL LOCALITIES

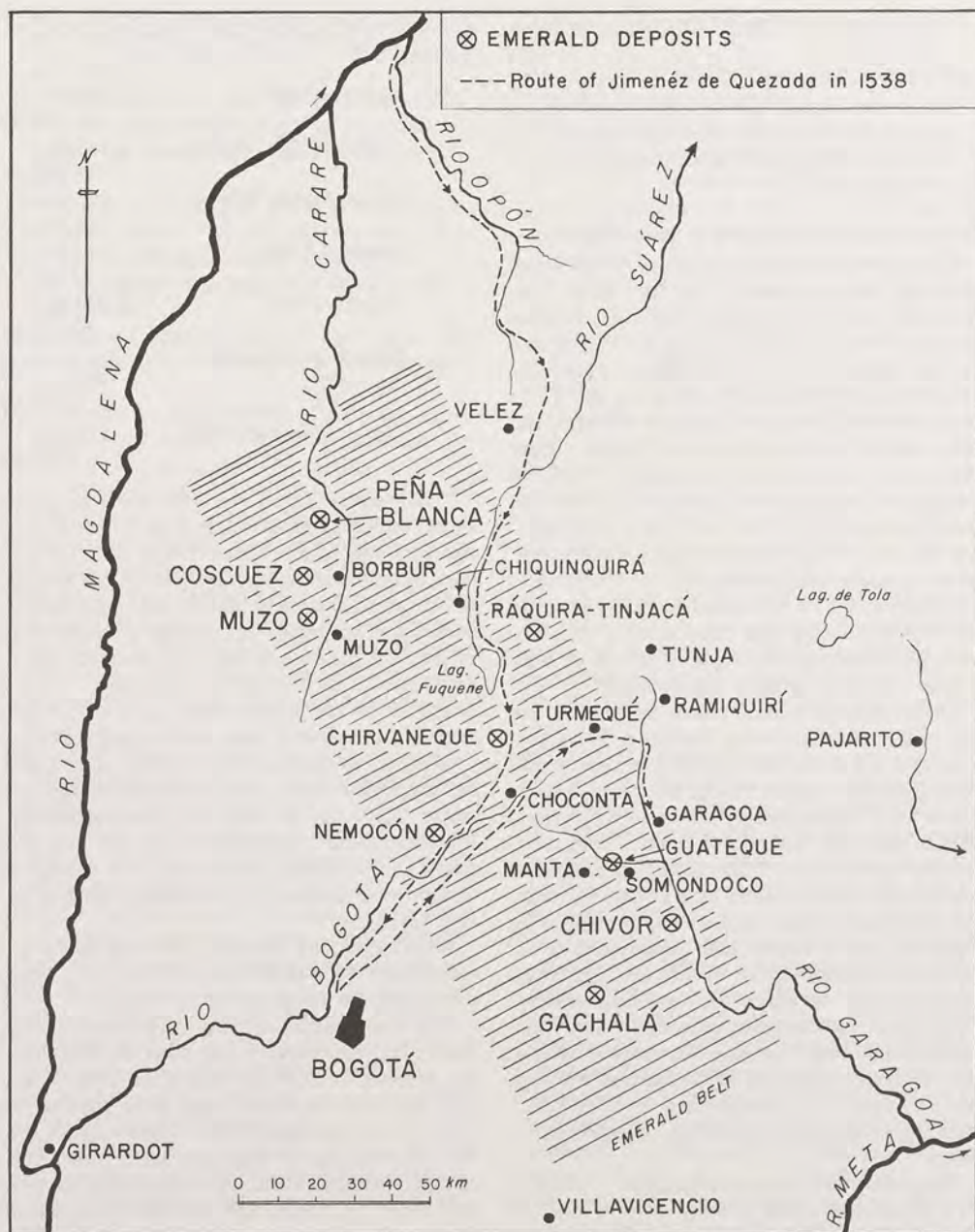

Fig. 14-18 The "emerald belt" in Colombia, showing general locations of emerald deposits and the route of exploration taken by Jimenez de Quezada (or Quesada) in 1538. After a map in Cundinamarca-Boyaca Muzo emerald mines 1961, *Colombian Society of Petroleum Geologists and Geophysicists Second Annual Field Conference*, March 25-26, 1961, p. B-1 (Fig. 3).

World Sources of Ore and Gem Beryl / Colombia

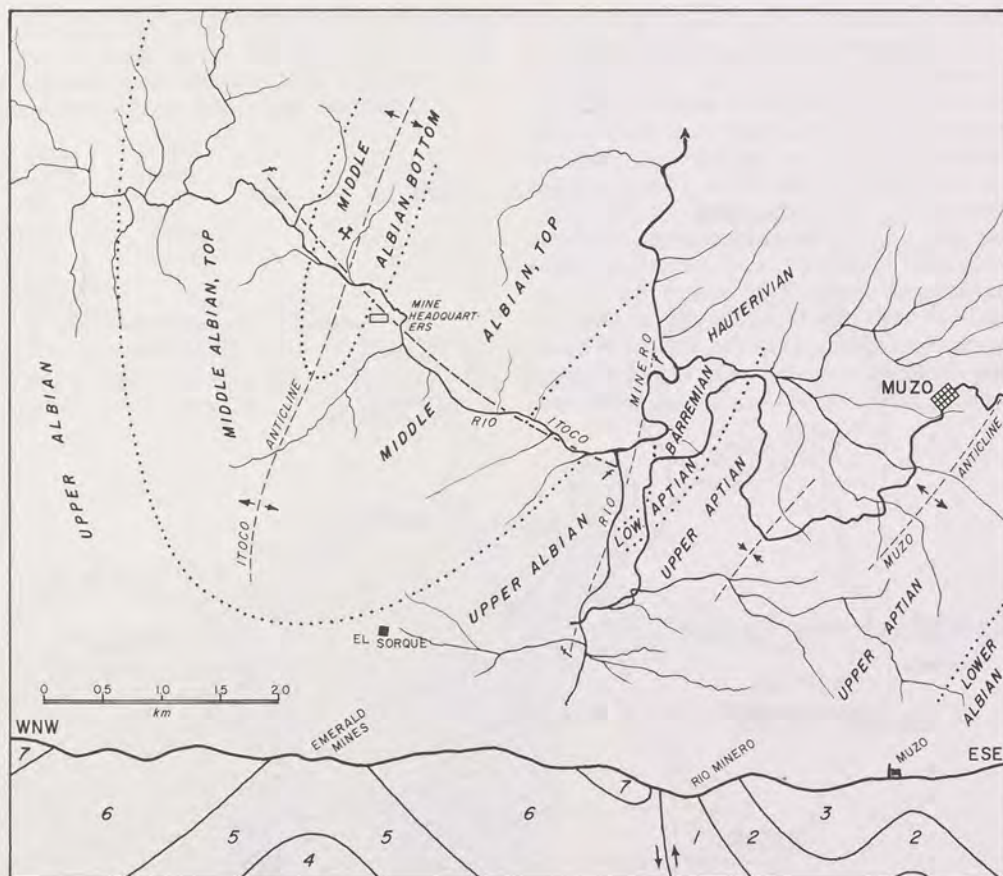

Fig. 14-19 Local geology at Muzo emerald mines, Boyaca, Colombia. *Upper Albian*: siliceous slates and shales; *Middle Albian* (top): pale gray and black slates; *Middle Albian* (bottom): argillites and black, pyritiferous shales in which emerald veins occur; *Lower Albian*: sandstones and sandy argillites; *Upper Aptian*: black shales and compact argillites; *Barremian* and *Lower Aptian*: black shales and sandy shales; *Hauterivian*: black shaley argillite. From a map of H. Bürgl and L. H. Pardo Vargas, in E. Hubach, *Exploración de nuevos yacimientos esmeraldíferos en Muzo*, Instituto Geológico Nacional Informe T188 (Bogotá, 1956): Plancha II.

Table 14-8
LOCATIONS OF THE MUZO AND COSCUEZ MINES

Primary Group		Secondary Group			
Coscuez	5°39'N	74°11'W	Peña Blanca	5°44'N	74°05'W
Muzo	5°33'	74°11'	Alumbral	5°32'	74°07'
Ramal	5°32'	74°12'	Cuincha	5°30'	74°08'
Amarilla	5°29'	74°14'	Isabí	5°28'	74°08'

BERYL LOCALITIES



Fig. 14-20 Sketch map of the property limits of the Muzo emerald mine, showing principal streams and the extent of the "capas esmeraldíferas" or the emerald-bearing formations. Based on a map of R. Scheibe, Informe geológico sobre la mina de esmeraldas de Muzo, *Servicio Geológico Nacional Informe 676* (Bogotá, 1933): Lamina IV.

sively fractured and fissured due to compressional and torsional forces created during the formation of the horst of Muzo and Coscuez. The formations are laterally limited by faults normal to the N-S direction in the contacts with Upper and Lower Albian Formations.⁶⁰ Spaces formed as a result of fracturing were filled with calcite-dolomite and other species, and in places include emerald. Because such formations are at the surface and covered with topsoil, which may reach depths

of 9 m (30 ft), they are called "capas buenas" or "good" or "promising" formations,³⁷ or "capas esmeraldíferas" or "emerald-bearing cappings."⁵⁸ They lie upon a distinctly different formation called the "cambiado" or "change" rock, a name applied locally to signify that beneath the contact of these two rocks no emeralds will occur.

Emerald-bearing rocks distinctively bleach upon exposure to yellowish-gray to brownish. Is-

World Sources of Ore and Gem Beryl / Colombia

olated nodules of pyrite and calcite-rich lenses occur in them but not as prominently as in the cambiado. Lévy analyzed black calcareous emerald-bearing rock from Muzo and found:⁶¹

CaCO ₃	47.8%
MgCO ₃	16.7%
SiO ₂	24.4%
Al ₂ O ₃	5.5%
Fe ₂ O ₃	2.6%
Minor BeO,	
FeS ₂ , alkali	

The emerald-bearing rocks are distinctly layered, severely fractured, and shot through with parallel or cross-cutting veinlets of calcite, at

times with aragonite, and are occasionally fibrous in texture. Also present are thin to thick veins of pale calcite and yellowish Ce-bearing dolomite, generally later than the first type of calcite vein. While calcite is predominant, some vein fillings are wholly dolomite and may also contain emerald. Even slight weathering of dolomitic veins causes them to crumble readily into grains which somewhat resemble rice and thus give them the name "guarruceros" or "rice-like," from guarroz = arroz = rice.³⁷ Dolomite forms after calcite, but calcite continues to form throughout the period of infilling of spaces and is found enclosing early species as pyrite, quartz, emerald, parsite, albite, apatite and fluorite. Barite in veins

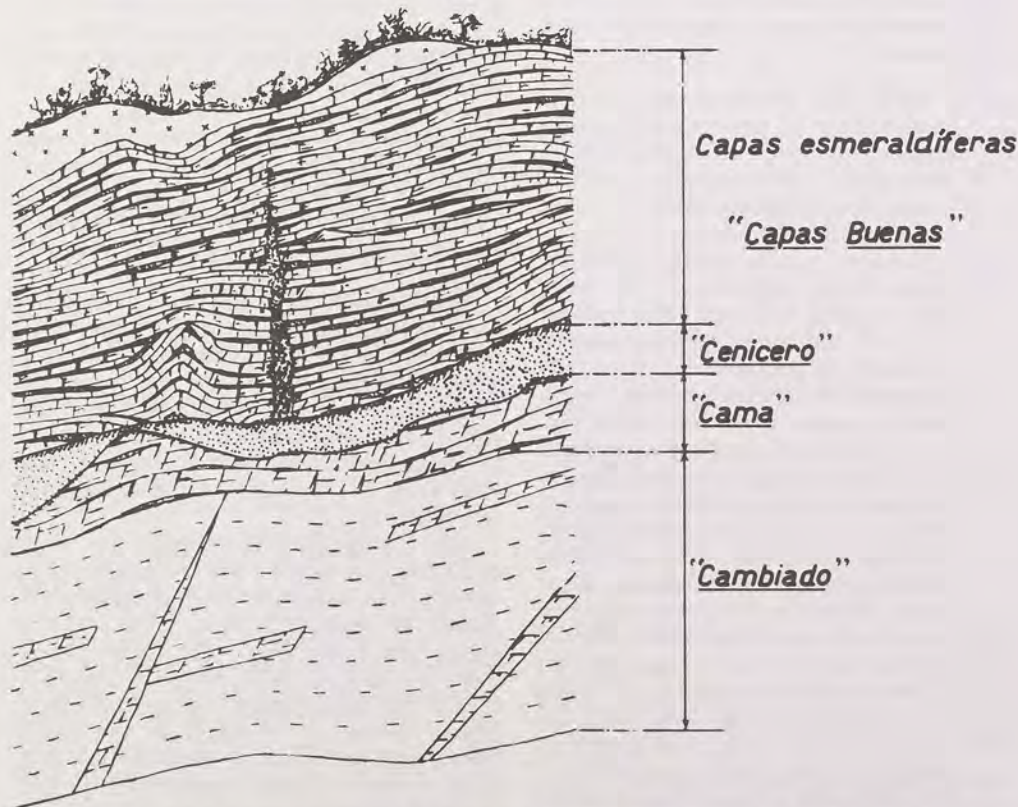

CORTE GEOLOGICO ESQUEMATICO DE LA ZONA ESMERALDIFERA

Fig. 14-21 Cross-section of Muzo emerald deposit showing relationships of the several formations. From G. Otero Muñoz and A. M. Barriga Villalba, *Esmeraldas de Colombia*, part 2 (Bogotá, 1948).

BERYL LOCALITIES

is always a late species and forms contemporaneously with albite. The paragenesis according to Scheibe is:³⁷

- I. Calcite, pyrite
- II. Calcite, (pyrite), dolomite, quartz, emerald, parisite, albite, apatite, fluorite
- III. Calcite, (pyrite), barite

In normal Muzo veins albite is very uncommon. It is more abundant though still minor in thick veins which occur in nest-like concentrations in the lower emeraldiferous layers. The thickness of the alternating layers of argillite-limestone in the emeraldiferous formation averages 2 cm (0.75 in)⁵⁸ while the total thickness never exceeds 50 m (165 ft)³⁷ and is usually less.

Between the emerald-bearing rocks at the top and the cambiado underneath occur several rock types of great significance in suggesting the origin of the emeralds:^{37,58}

I. *Albite Rock*. Grades into the top of the cambiado; grayish granular-massive; albite crystals 1–3 mm size set in greenish-black groundmass; albite apparently replaces calcite; druses contain splendid crystals of albite, calcite and dolomite.

II. *Cenicero*. A name locally applied because of color and texture, with "cenicero" meaning "ash-bed." Two types occur: "red" and "gray," the latter reaching several m in thickness and essentially composed of soft, granular calcite, considerable quantities of a scaly talcose mineral (pyrophyllite?), and sometimes barite (occasionally in large nodules). The red cenicero takes its name from the weathered color and is mainly yellow-brown granular dolomite with variable content of albite crystals, pyrite, minor calcite and quartz (rare). Druses are lined with handsome crystals of dolomite and albite. The red cenicero usually forms in layers less than 20 cm (8 in) thick. Pyrite is sometimes very abundant and may form lenses 200 × 20 cm (80 × 8 in).³⁷ In both types of cenicero are found concretions of marble-like calcite with quartz crystals (sometimes greenish in hue), sulfur, chalcopyrite, bornite, chalcocite, malachite, azurite, and rarely emerald (in gray type only).

III. *Cama*. The name means "bed" and re-

fers to a layer of intergrown large and well-formed calcite rhombs of 5–10 cm (2–4 in) diameter in a fine-granular matrix with some quartz crystals and barite, the whole forming a breccia-like mass.

The cambiado is the visible bottom formation at Muzo and consists of layers of steeply-dipping limestone alternating with layers of thin-bedded argillite. It is an extensive and important formation in the region. Cambiado characteristically weathers to blueish-green and on long exposure to whitish, hence providing a sharp visual distinction from other formations. Microscopic examination shows ragged granular masses of calcite enclosed in black carbonaceous matter with variable numbers of fragmentary albite crystals. In places it grades upwards into an albitic rock. Various subtypes within the cambiado were described by Scheibe as albite veins near the border with emerald-bearing rocks, in which, in places, beautiful twins of albite to 1 cm are found and elsewhere occurs a talcose mineral, albite, pyrite, much dolomite, and rarely allophane.³⁷ Pyrite nodules of "fist size" and even to several meters in diameter have been found.²⁶ Poorly preserved fossils occur in thick sandstone-like quartzites or graywacke-like rocks intercalated in the cambiado.

Pegmatites were discovered in the cambiado of Banco Amarillo and Banco Central by Scheibe in 1915, and a pegmatite body exposed at the latter place was examined by Pogue who found it to consist of quartz, some crystallized though decomposed feldspar, some albite crystals and apatite, much greenish to colorless allophane, and many small fine crystals of pyrite as well as a little hyalite opal.⁵⁸

ORIGIN OF THE EMERALD DEPOSITS. The origin of the Muzo and similar emerald deposits elsewhere in Colombia has not been satisfactorily explained. The presence of beryl, parisite, fluorite, apatite, albite, and barite suggest mineralizing sources outside the sedimentary formations.⁵⁸ Granitic pegmatites indicate that a granite magma may lie underneath the region and that hydrothermal solutions emanating therefrom may have introduced these minerals. Furthermore, the contact-type of albite rock noted in the cambiado suggests permeation by magmatic solutions. Scheibe offered the following postulates:³⁷

1. Initial ascending solutions deposit calcite and pyrite

World Sources of Ore and Gem Beryl / Colombia

in cracks and fissures of cambiado; deposition of calcite-pyrite lasts to closing of next stage.

- Vapors from igneous rocks alter portions of cambiado into albite-rich rocks.
- Fissures near cambiado—emerald bearing rock zone fill with albite accompanied by talc-pyrophyllite, calcite, dolomite and pyrite; cambiado metasomatically altered in places to albite rock with calcite inclusions.
- Pegmatite veins intrude deeper parts of cambiado.
- Crustal movements cause more fissuring in cambiado and overlying rocks, resulting in further introduction of calcite-dolomite and producing the cama layer.
- Emerald veins begin to form, enriched in calcite, dolomite, pyrite, also fluorite, parisite, rarely apatite, and finally albite and much dolomite; vein formation persists and younger veins cut through older veins.
- Red cenicero forms with and over the cama.
- More crustal movement causes overthrusts and brecciation in the formations, allowing introduction of albite as veins and as albitic rocks in portions of overthrusted cambiado rocks.
- Cenicero produced by intermixing of brecciated fragments of emerald-bearing veins, cambiado rocks, albitized cambiado rocks, etc., resulting in breccias composed of fragments of veins, rocks, emerald-bearing veins, loose emerald crystals, etc., with later cementation by barite.

A review of the various theories on the origin of these deposits was given by Hintze.¹⁶

MUZO MINERALOGY. The following data are mainly from Pogue, who provided the most complete descriptions.⁵⁸

Beryl. Emerald occurs mainly in calcite veins as single crystals, clusters, or fragments of crystals, and is rarely found outside the veins. Most crystals are below several cm long but may reach 10 × 5 cm (4 × 2 in) and sometimes a little more. Predominant habit is short prismatic. Large crystals are almost exclusively bounded by faces of first order prism $m\{10\bar{1}0\}$, and base $c\{0001\}$, and less commonly with the second order prism $a\{11\bar{2}0\}$. One or more bipyramidal forms may appear, mostly on small crystals, as $\{10\bar{1}1\}$, $\{10\bar{1}2\}$, $\{11\bar{2}1\}$, $\{11\bar{2}3\}$, $\{20\bar{2}1\}$, $\{21\bar{3}1\}$, $\{21\bar{3}3\}$, $\{30\bar{3}1\}$, $\{30\bar{3}2\}$, $\{33\bar{6}1\}$, $\{4041\}$, $\{42\bar{6}3\}$, $\{51\bar{6}5\}$, $\{12.0.12.1\}$, and $\{16.8.24.1\}$.^{62,63} The curious sectored crystals known as trapiches, and previously described in another chapter, were first mentioned by Bertrand.⁶⁴ Brief descriptions were also provided by Codazzi,⁶⁵ Pogue,⁵⁸ and Scheibe³⁷ who mentioned their occurrence in dark coaly shales in Banco Amarillo and near Tambre Boliche, Muzo. Klein gave their source as a small area in Banco la Fragua (p. 152–3).³¹ Bernauer investigated forty trapiche crystals.^{66,67} More recent studies include those of Barriga Villalba^{7,69} and Nassau and Jackson.^{68,68a} Spontaneous frac-

turing of emerald crystals shortly after removal from the ground was reported by Pogue who stated "the flaws or internal cracks . . . are not always present in the freshly mined stones, but if not they almost invariably develop soon after the specimen is removed from the enclosing rock, a result presumably caused by the strained condition of crystallization."⁵⁸ Olden, however, believed that there was no evidence to support this view and that the cracks were caused by stresses prior to removal and only became evident when the water within them evaporated.³⁴

Table 14-9
ANALYSES OF MUZO EMERALDS

	Dana System, 6th ed.		Barriga Villalba ⁷
SiO ₂	67.85	67.2	65.250
Al ₂ O ₃	17.95	19.4	17.617
Fe ₂ O ₃	—	—	1.002
Cr ₂ O ₃	trace	trace	0.264
BeO	12.4	12.7	13.891
MgO	0.9	0.4	0.426 ^a
Na ₂ O	0.7	—	—
H ₂ O	—	— ^b	1.550
Totals	99.8	99.7	100.00
G	2.67	2.640	

^a total of K, Na, Ca, Mg oxides; ^b ignition loss. See analyses in Chapter 5.

The density is variable within narrow limits and Barriga Villalba provided the following according to variety:⁷

Table 14-10
DENSITY OF MUZO EMERALDS

Moralla ^a , slightly green	2.5664
Moralla, green	2.6370
Emerald, very jardin ^b	2.6769
Emerald, prime quality	2.6890

^a"Moralla" is translucent to nearly opaque beryl which may or may not be colored emerald green; the opacity is owing to numerous very small inclusions.

^b"Jardin" or the French term for "garden," is applied to emeralds of good color in which numerous, more or less uniformly distributed veil-like inclusions resemble mossy growths. The densest emerald is of course one totally free of inclusions.

BERYL LOCALITIES

The following refractive indices are from Vogel but the exact Colombian source was not given;⁷⁰ also see optical data in Chapters 7 and 8.

Table 14-11
REFRACTIVE INDICES OF MUZO EMERALDS

	<i>n</i> B(6870 Å)	<i>n</i> D(5893 Å)	<i>n</i> E(5270 Å)
<i>o</i>	1.5730	1.5762	1.5797
<i>e</i>	1.5675	1.5706	1.5739
<i>n</i> F(4861 Å) Dispersion		<i>D.R.</i>	
	1.5825	0.0095	0.0056
	1.5767	0.0092	0.0056

Webster provided values of *o* = 1.584 and *e* = 1.578 (Na), *D.R.* = 0.006, *G* = 2.71⁷¹

The color of Muzo emeralds is generally described as more yellowish than those from Chivor. The color was once ascribed to carbon,⁶¹ but Wöhler attributed it to chromium.⁷² There is little evidence to suggest that the green in Muzo or other Colombian emeralds is due in whole or part to vanadium. The color is commonly evenly distributed, but colorless or paler zones have also been noted as well as areas of irregular form in which color is weaker. As a rule the crystals are lighter in color at their bases, but much of this may be due to the paling brought about by more numerous gas-liquid inclusions.

Small crystals tend to be free of flaws while large crystals not only tend to contain more flaws but also numerous basal and prismatic cracks. Two- and three-phase inclusions are characteristic, consisting of irregular to elongated (parallel to *c*-axis) bubble-like voids containing gas, gas-liquid, or gas-liquid plus minute crystals of halite, etc.^{73,73a} According to Barriga Villalba calcite is the most common solid inclusion, followed in decreasing order of frequency by magnesite, barite, pyrite, quartz and parisite.⁷ The "magnesite" may, however, be dolomite. Pogue listed the following associates: calcite, dolomite, parisite, pyrite and quartz, and rarely barite, fluorite and apatite.⁵⁸ Gübelin identified the following as inclusions in Muzo crystals: calcite crystals, "coaly" inclusions, parisite and "hexagonal slabs" of an unidentified species.⁷³ Parisite, in yellowish-brown hexagonal tapered crystals of

small size is considered to be a diagnostic inclusion.

Calcite. Abundant in vein fillings and well crystallized in vugs; water clear to opaque gray due to carbonaceous inclusions; rich in forms but rhombohedral and prismatic habits predominate; occurs as unit rhombohedra $r\{10\bar{1}1\}$ in the cama; sometimes forms cross-fiber seams.³⁷

Dolomite. Small transparent honey-yellow rhombs in veins and cenicero; may contain Ce.³⁷

Ankerite. Yellowish-brown rhombs in veins.

Aragonite. White, radiate massive; acicular crystals to 2.5 mm; also coralloidal "flos ferri."⁷⁴

Parisite. Crystalline masses and terminated brownish-yellow crystals, usually less than 1 cm, associated with emerald and sometimes included.

Pyrite. Abundant in good crystals in veins and stringers, also in nodules in associated formations; vein crystals cubic, octahedral, and pyritohedral in habits or combinations. Reiss and Stübel mention crystals to 30 mm (1.2 in),⁷⁴ but nodular masses may be much larger.³⁷ Commonly associated with emerald.

Quartz. Well-formed colorless crystals, sometimes greenish due to inclusions; occasionally in veins as clear, colorless individuals to 28 mm (1.1 in) long; less perfect crystals in cama; also form-rich crystals in the pegmatite behind Banco Central.

Fluorite. Small colorless or greenish crystals in some emerald veins, generally uncommon to rare; also massive.

Apatite. Uncommon as small, well-formed, glassy crystals in emerald veins and pegmatite.

Gypsum. Clear slender crystals, sometimes greenish.³⁴

Albite. Tabular twinned crystals, sometimes perfectly developed in vugs in albitic phases of the cambiado; uncommon in emerald veins.

Barite. Massive, in layers to 40 mm (1.55 in) thick in uppermost parts of the cenicero; also small glassy tabular crystals in some emerald vein vugs; in thin layers and veinlets or in breccia cavities in associated formations.

Anthracite. Small impure fragments in joints in some parts of the formations.

Marcasite. In nodules.

Bornite. In the cenicero.³⁷

Chalcopyrite. A few poor crystals were found in veins; also present in cenicero.

Chalcocite. In the cenicero.³⁷

World Sources of Ore and Gem Beryl / Colombia

Sulfur. Some conspicuous masses were found in the cenicero.

Limonite. Abundant in films and masses.

Melanterite. An alteration product.⁶⁰

Pyrophyllite. "Apple-green" folia in small inconspicuous seams in the emerald formations.⁵⁸

Allophanite. Clay-like masses forming lenses in the formations.

Fuchsite. Green laminae in some rock joints.

Muscovite. Very small leaflets in rock joints; in pegmatite.⁷⁴

Malachite. In the cenicero.³⁷

Azurite. In the cenicero.³⁷

CHIVOR GEOLOGY. The formations at Chivor are about 1,000 m (3300 ft) of conformable sediments consisting of light gray calcareous shales with some lenses of carbonaceous matter. The top member is hard gray fossiliferous limestone, the lower member, rarely exposed, is hard, blue, thin-bedded limestone or calcareous shale (argillite). The strata were tilted in the late Cretaceous or early Tertiary and now dip about 35° W and strike about N 30° E. Uniform folding resulted in large local distortions and much jointing, followed by fault-displacements. The rocks were broken into small angular fragments and are easily dislodged with hand tools during mining.⁷⁵

Klein described the column at Chivor as exposed during the mining conducted under his supervision.³¹ The formations are listed from the surface down.

Figure 14-22

KLEIN'S CHIVOR COLUMN

1. Shale, mostly altered, yellowish to grayish blue; contains many large blocks of black limestone; many small veinlets of calcite with some quartz but no emerald; this formation terminates abruptly upon:
2. Shale breccia, black shale fragments of blocky shapes not over 20 cm (8 in) diameter, jumbled; no veins present; sharply demarcated from:
3. Iron oxides layer: a thin brown band.
4. Shale, bluish gray, with isolated veins of albite containing only pale green emerald.
5. Ferrojinoso I., a 1 m (3 ft) thick layer composed mainly of iron oxides with albite and quartz; sharply demarcated from:
6. Shale, emerald-bearing, a hard blueish rock

containing the principal emeraldiferous albite-quartz-apatite veins; thickness about 15 m (50 ft).

7. Ferrojinoso II., similar to Ferrojinoso I.
8. Shale, soft, altered, exposed for at least 40 m (130 ft) depth at various points and containing typical albite-quartz-apatite veins from which many fine emerald crystals were recovered, including some 15–18 carat crystals; this formation appeared in the Sinai workings.
9. Shale, the bottommost formation exposed; a solid rock, no emerald veins.

Vertical to near-vertical fissures provided mineralization channels for vein fillings while later faulting resulted in some displacements of earlier-formed veins.⁷⁵ Klein indicated such veins only in general terms, and did not speculate on this role in the mineralization process.³¹ Mentzel believed that mineralization occurred before and after faulting, with quartz being the earliest species, followed by pyrite, emerald, and albite.⁷⁵ Large veins, beds, and masses of limonite, and sometimes hematite, formed from alteration of pyrite and are conspicuous features. He also noted that within such limonitic masses occur quartz crystals to 2.7 kg (6 lb) in weight whose clarity suggests formation earlier than the enclosing iron oxides. Above the limonitic beds quartz also permeates cracks and fissures. Pyrite appeared after faulting, followed by emerald as suggested by inclusions of pyrite in the emerald. Mentzel also believed that two periods of mineralization took place, the first being in-filling of E-W fissures and the second, the mineralization afterwards. Albite appears to be the last species to have formed and is noted as the cement in broken emerald crystals.

Klein found no emerald crystals in calcite veins of the uppermost formation at Chivor despite the presence of numerous early Spanish tunnels.³¹ It was not until the strata below the ferrojinosas were exposed that emeralds were discovered, the limonitic bands apparently forming an impenetrable barrier to upward mineralization. In this connection, Mentzel believed that beryl appeared from a "deep-seated" source and crystallized at moderate temperature and pressure in the veins as evidenced by lack of vein-wall alteration,⁷⁵ but according to Johnson, a thin-section of wall rocks

BERYL LOCALITIES

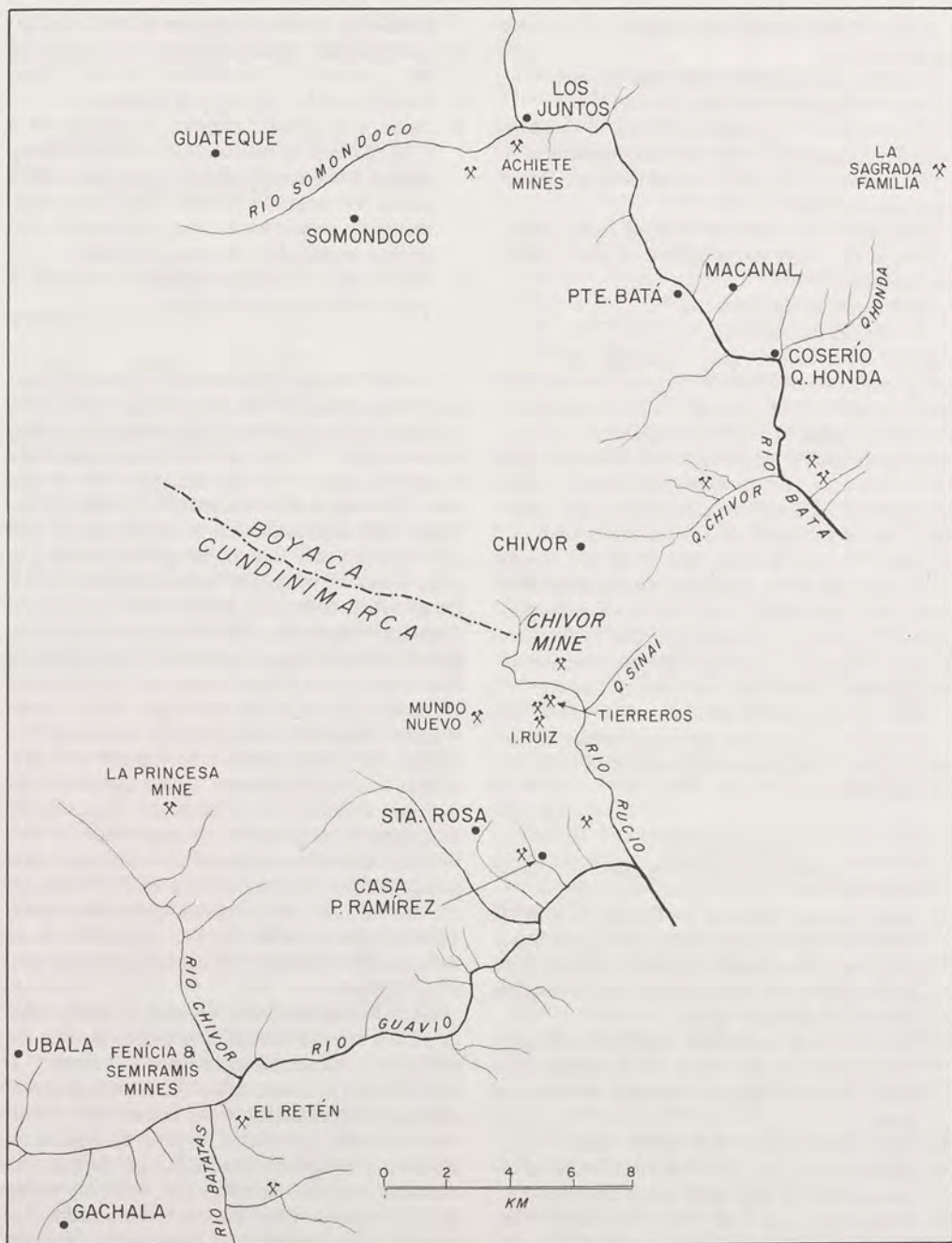

Fig. 14-22 Emerald mines in the Somondoco-Gachalá region, Colombia, after a map of V. Mutis and R. Wokittel, in R. Dominguez A., *Historia de las Esmeraldas de Colombia* (Bogotá, 1965).

World Sources of Ore and Gem Beryl / Colombia

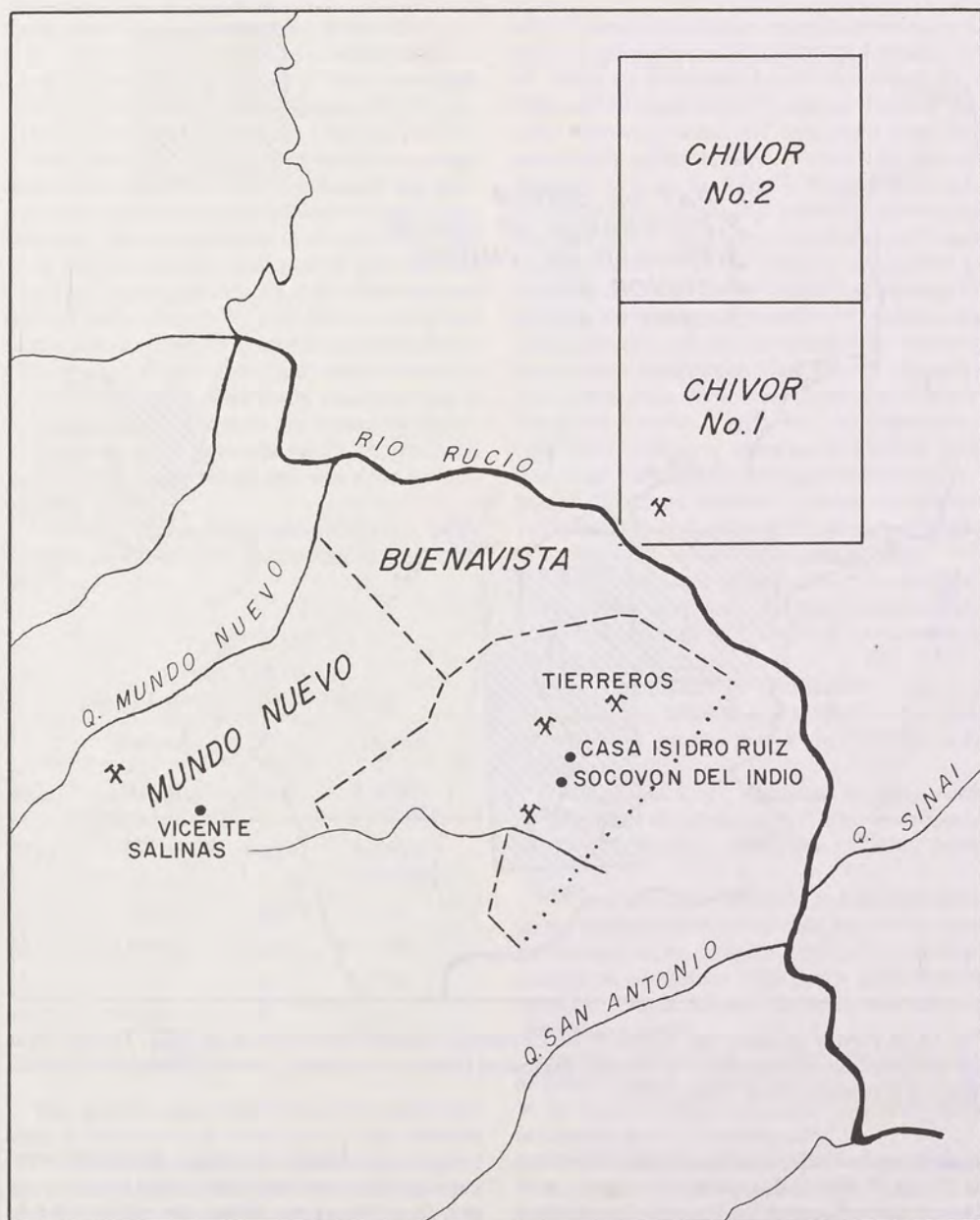

Fig. 14-23 Emerald mines in the Chivor region, Colombia, from a map of V. Mutis and R. Wokittel, in R. Dominguez A., *Historia de las Esmeraldas de Colombia* (Bogotá, 1965).

BERYL LOCALITIES

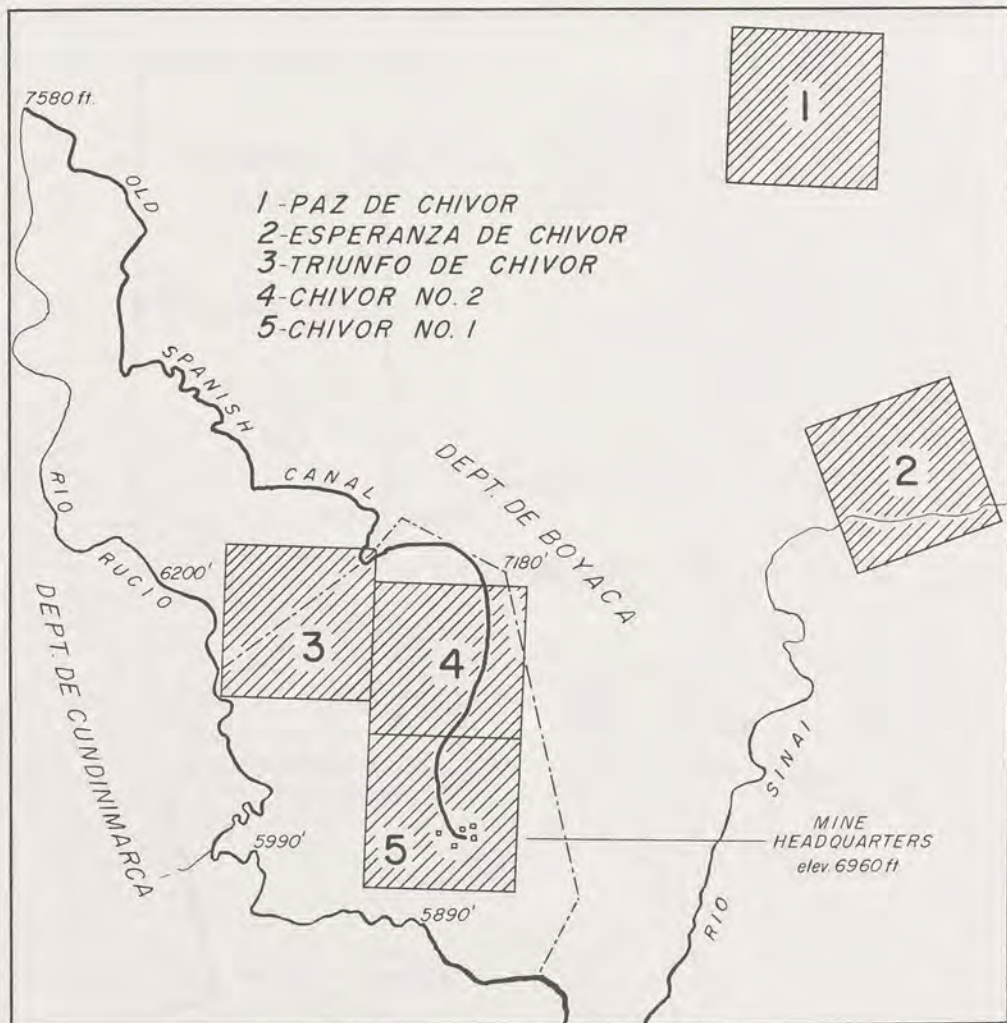

Fig. 14-24 Private property and claims of the Colombian Emerald Syndicate as of 1920. The dot-dash line indicates the property that was actually exploited. From L. J. Canova, *Chivor-Somondoco Emerald Mines of Colombia* (New York, 1921).

showed signs of alteration to a depth of 3.4 mm (0.13 in).³⁸ Mentzel appeared to agree with Klein's suggestion that the limonitic bands acted as barriers, for he stated that they "seem to have acted as a dam, preventing in general the farther rising of the emerald solutions."¹⁷⁵

Emerald-bearing veins range from hairline cracks to as much as 15 cm (6 in) thickness and seem not to exceed about 65 m (215 ft) in length, or to form below 35 m (115 ft) depth.³⁸ In such

veins the emerald is irregularly distributed without any visible pattern. Where veins transect rock rich in carbonaceous matter, the pyrite is fresh, but where such veins pass through areas displaying alteration of pyrite, the emerald crystals are cemented by limonite, and these must be extracted with care to avoid damage to the crystals.

MINERALOGY OF CHIVOR

Beryl. Emerald, predominantly in first order prisms, somewhat more elongated as a rule than

World Sources of Ore and Gem Beryl / Colombia

those from Muzo; also slender to acicular prismatic, divergent prismatic, and granular massive. Most common forms: *m* and *c*, also commonly second order prism $a\{1120\}$. Bipyramids $s\{11\bar{2}1\}$, $p\{1011\}$, and $o\{1122\}$; also $\{1011\}$, $\{2021\}$, $\{42\bar{6}3\}$. Sparingly as tapered crystals, sometimes with central cavities extending through the crystals; very rarely with pointed terminations. Flattened moralla crystals occur to 20 × 10 mm (0.8 × 0.3 in) in lengths to 50 mm (2 in); such are found on gray argillite matrix with albite and pyrite in Colifor tunnel.³⁸ As at Muzo, some fine matrix specimens have been found, but those of Chivor often display more numerous crystals in a given area, often attractively scattered over a vug lining. Many emeralds are marred by limonitic coatings which cannot be easily removed with acids because such would also attack the carbonate rock matrix.

The following spectrographic analysis is on an emerald sample from El Taladro tunnel area. Chivor:³⁸

Table 14-12
ANALYSIS OF
EL TALADRO, CHIVOR EMERALD

	Percent		Percent
SiO ₂	60-70	V ₂ O ₅	0.00001- 0.000001
Al ₂ O ₃	15-20	Na ₂ O	0.00001- 0.000001
BeO	10-15	MnO	nil
MgO	0.01-0.1	K ₂ O	nil
CaO	nil	Cu	nil
Fe ₂ O ₃	0.001-0.0001	Ni	nil
Cr ₂ O ₃	0.0001-0.00001		

The specific gravity of Chivor emerald averages 2.69 according to Webster,⁷¹ but Johnson weighed ten samples to obtain a range of 2.646-2.730, average 2.684.³⁸ A moralla gave 2.593. Refractive indices from Webster are $o=1.577$, $e=1.571$, diff. 0.006. Johnson found a range from 1.565 to 1.579, presumably the maximum between *o* and *e*.

Chivor beryls range from colorless or white to faint green, medium green, thence into the rich emerald green commonly described as a "cool" bluish green as compared to the yellower green

of Muzo emeralds. Color zoning is common, generally in prismatic zones, often with a central core of white or colorless beryl enveloped by a "sleeve" of dark-colored material. Reverse patterns were also noted, as dark green cores surrounded by colorless beryl. Various zonings are depicted in color by Klein.³¹ Rainier stated that crystals are consistently colored throughout a vein and that dark stones occur together, light stones together, etc.,⁷⁶ but the opposite is claimed by Klein (p. 261-2),³¹ who stated that various intensities of color can be found in crystals that are found together. Klein also noted that emeralds found under Ferrojinoso I are blueish green, but that stones from lower formations are yellower, like those of Muzo.³¹ As a rule, equivalent-sized crystals from Chivor seem to be freer of flaws than those from Muzo. Veil inclusions characteristic of Chivor are swarms of minute, three-phase voids; solid inclusions may be pyrite, considered to be diagnostic, quartz, albite, and goethite.^{38,73,73a}

Albite. Abundant as vein fillings with pyrite and emerald; in granular aggregates, also tabular translucent crystals to 1 cm (0.5 in), sometimes altered to allophanite.

Pyrite. Abundant in well-formed cubes and pyritohedrons; some cubes striated and slightly curved. Most are less than 7 cm (2.75 in) in diameter.

Goethite (limonite). Abundant in many places as porous to compact masses; also pseudomorphous after pyrite, sometimes retaining pyrite core.

Calcite. Common in white to colorless transparent rhombohedra in cap rock but rarely found in emerald veins as gray rhombs⁷⁵; "showy" specimens of rhombs with pyrite crystal inclusions from Klein tunnel,³⁸ definitely *not* an associate of emerald.³¹

Quartz. Transparent, sometimes doubly-terminated crystals, rarely with phantoms, to 20 × 10 cm (8 × 4 in); crystals to several kg found in limonite bands; also massive.^{38,75}

Allophanite. An alteration product of albite.

Halloysite. Noted by Johnson.³⁸

Muscovite. Noted by Johnson.³⁸

Fuchsite. Found in one place in a limonite band.⁷⁵

Apatite. Uncertainly identified as crystals in emerald vein;⁷⁵ mentioned by Klein (p. 178)³¹ as associate of emerald.

Hematite (specularite). Noted by Johnson.³⁸

Opal (hyalite). Noted by Johnson.³⁸

BERYL LOCALITIES

Gachalá Deposits. The first recovery of emeralds in the municipality of Gachalá was from eluvial material,⁴⁶ but a commission charged by the Ministry of Mines to investigate the status of emerald mining in the municipalities of Gachalá, Almeida, Macanal, and Somondoco, found that mining was taking place *in situ*.⁷⁷ At Mina el Reten or Mina 12 de Junio, located on the road to Vegas de San Juan, mineralized ferruginous shales containing emeralds were found enclosed in slate beds, while at the Mina Rio Batatas, a minor prospect yielded emeralds weathered from decomposed arenaceous-argillaceous shales enclosed in beds of hard, compact sandstone of the Caquéza Formation.

Buenavista Deposits. The Buenavista group of mines is located in the municipality of Ubalá. The geology and mineralogy are similar to that of Chivor,⁷⁷ and indeed the areas are adjacent to each other. Mina Buenavista Baja, including claims La Perla, La Cueva, La Laguna, Buenos Aires, is separated from Chivor by the Rio Rucio. Workings are underground in slate, with emerald mineralization in more or less hard argillites. Mina Buenavista Alta is similar. Mina Buenavista Tierreros is worked by washing decomposed emerald mineralized rock. Mina Mundo Nueva No. 1, near Chivor, is in similar formations as the latter. A tunnel, the Socavon del Indio, according to local legend, was worked by Indians and Spaniards who obtained large quantities of emeralds, but recent examinations found no signs of favorable mineralization in the exposed argillaceous-slatey gritstone.⁷⁷

Elsewhere in the Buenavista area are large workings at Mina la Princesa, Roblegal district, including claims La Palma No. 1 and No. 2. In 1954 these belonged to the Compañía Ordinaria de Minas de Esmeraldas de Muzo y Coscuez. Mina Quebrada Negra, located 1500 m (0.9 mi) SE of Santa Rosa village consists of small galleries driven into mineralized shales. Mina San Martin, about 800 m (2600 ft) N of the mouth of Quebrada Negra, where the latter empties into Rio Guavio, also obtains emeralds from veins in an argillaceous-ferruginous formation. Minas Mundo Nuevo 1 and 2, on a hacienda of the same name, and Mina La Fenicia, on the road to Cusio Grande, are mines in reddish quartzitic sandstones and gritstones of the Caquéza Formation.

Miscellaneous Deposits. In the municipality of Macanal occur: Minas Palvarañado No. 1 and 2, near Quebrada Negra, where in colonial times

beds of slates and shales were exploited for emeralds; Minas la Sagrada Familia, formerly exploited with pits and galleries; Mina la Tirania on Rio Batá near the mouth of Quebrada Chivor, where emerald mineralization occurs in argillaceous shales and slates exposed in small opencuts; Mina San Pedro near Macanal village; also Minas las Animas. In the municipality of Somondoco: Minas de Juntas 1 and 2 near Puente Juntas, with pyrite and morallas found in several mineralized formations; Mina El Quemado at Rio Guatequé, and Mina Los Canos. All these deposits lie within an area of about 24,000 hectares bounded on the S by the villages of Ubalá and Gachalá, Rio Batatas and its sources, the Vegas de San Juan to the right margin of Rio Guavio, including Hacienda Monte Cristo, and thence to the mouth of the Rio Rucio. The area is delimited to the W by Cerro del Diablo, Tres Esquinas, Cerro de la Cabrera, Cerro de Somondoco and Somondoco village. At the N, it is bounded by the villages of Macanal, Garagoa, and Guatequé, and to the E by the village of Macanal and the road from Agua Blanca to Rio Batá, and thence to the mouth of the Quebrada Esmeraldas.⁷⁷

Nemocón Emerald Occurrence. Small emerald prisms, $10 \times 2-4$ mm ($0.4 \times 0.08-0.16$ in) occur SE of Nemocón village in a salt deposit. The low hill of the salt deposit is located in the N outliers of the Sabana of Bogotá and is near that city. The salt forms a columnar protrusion piercing Cretaceous strata and is covered by brecciated black shale containing much pyrite and occasional veins of calcite in which occur the emerald crystals. The vein calcite is fibrous to granular, sometimes crystallized into small rhombs, and contains pyrite crystals, small smoky quartz crystals, and some isolated dolomite crystals. It is cemented with a fine-grained breccia of calcite and clay-like material. The emerald crystals are not only small but also of poor quality, and no commercial value is seen in them. This occurrence was first noted from 1915-16 during mining operations for lime.^{36,37}

Large Colombian Emerald Crystals. In April 1969 the Associated Press carried a news release from the Colombian government reporting the discovery in the Tres Cruces mine of the largest emerald crystal ever recorded from the country. The crystal weighed nearly three pounds, or about 1.2 kilograms, and was tentatively valued at \$300,000. It was placed in storage in the Banco de la Republica in Bogotá.

World Sources of Ore and Gem Beryl / Colombia

In pre-conquest days, legend has it that a magnificent emerald as large as an ostrich egg was worshipped by natives of Manka valley in Peru as the "Goddess of Emeralds." It was hidden by priests upon approach of the Spanish and to this day remains undiscovered. Another fabulous stone, the "Emerald of Texcoco," was said to be a large pyramidal object fitted with an aigrette of plumes on top. This too was never heard of again, although Cortez, in his third letter to the King of Spain, sent on May 15, 1522, mentioned an emerald that he was sending to Spain, also pyramidal in shape, and so large that its base was "as broad as the palm of the hand." Tagore mentioned a great slab-like emerald in possession of Maharajah Duleep Singh that measured $3 \times 2 \times 0.5$ in ($7.5 \times 5 \times 1.25$ cm) of fine color and with few inclusions.⁷⁸ Many other large and fine Colombian emerald crystals found their way into the treasuries of Moslem and Indian potentates.

Another famous Muzo crystal is the Duke of Devonshire emerald, a simple hexagonal terminated prism which measures about 5 cm (2 in) in diameter and 6 cm (2.3 in) tall and weighs 1,384 carats. The splendid unguent jar carved from a single Muzo crystal by Miseroni, and now in the Kunsthistorische Museum in Vienna, weighed, as carved, even more than the Devonshire stone, that is, 2,680 carats. It stands about 10 cm (4 in) tall as shown in fig. 4-8.

The famous Patricia or Patrizius multiple emerald crystal, sketched in fig. 4-24, was found by Fritz Klein on January 20, 1921, in a small pocket in the Chivor mine and was given its name after St. Patrick. An exciting account of its discovery along with a colored illustration is given by Klein in his book *Smaragde unter dem Urwelt*.³¹ This splendid specimen, though not of the best color nor clarity by any means, was sold for £21,000 (U.S. \$60,000) in 1921. For many years its whereabouts was unknown, but it surfaced in the 1950s when an anonymous donor presented it to the American Museum of Natural History in New York. It is not a large crystal for emerald, but very extraordinary for Chivor, and weighs 630 carats. It is 8 cm (3.25 in) tall and about 55 mm (2.25 in) wide or somewhat more, if a side crystal is taken into account. The crystal is roughly cylindrical in shape because of nearly equal development of both *m* and *a* prisms.

A more recent addition to the ranks of large Colombian emeralds is the crystal found in 1967 at the Vega San Juan mine in Gachalá. It is a

stubby hexagonal prism, terminated, with very smooth, well formed faces, measuring about $5 \times 5 \times 5$ cm ($2 \times 2 \times 2$ in) and weighs 858 carats. It is considerably transparent and dark green in hue. Harry Winston, the late gem dealer of New York, purchased the stone and presented it to the Smithsonian Institution, Washington, D.C. According to Trapp it is the "finest example [of an emerald crystal] to be seen in any museum of the world today."⁷⁹ Other large crystals are described and depicted by Keller.⁸⁷

Mining Methods

In all mining, where the valuable mineral constitutes only a minute fraction of the rock removed, e.g., gold mining, diamond mining, etc., the problem of waste removal becomes increasingly important and indeed can increase costs to where the operation becomes unprofitable. This accounted for the use of tunnels by the Spanish rather than any extensive open-cutting, such as is now commonly employed. Tunnelling could follow attractive leads and selectively mine out portions of ground that seemed to be richest. However, it could also mean bypassing extremely valuable "pockets" of ore that could be only inches away from the tunnel walls. The Colombian government, according to Klein, faced with mounting tunnelling costs in their Muzo operation, brought in several mining engineers to devise a cheaper method for mining large volumes of emerald "ore."³¹ This resulted in the most common method now used, that is, benching of steep slopes and flushing debris away with powerful streams of water (fig. 14-25).

The terrain and availability of water in the emerald mines made benching an efficient method, although considerable work had to be done beforehand to insure the necessary supply of water in reservoirs placed above the open-cuts. In practice, the mining proceeds like this. Promising sloping ground, beneath which emerald-bearing veins are known to exist, is stripped of vegetation and topsoil down to bed rock. A narrow, horizontal step is then started across the working face, the friable rock being easily dislodged with steel bars. Workers simultaneously watch for signs of emerald veins. When such a vein is found, the foreman examines the spot and carefully works out such emeralds as may be found, placing them in a bag to be delivered later to mine headquarters.^{80,81} When the spot is exhausted of its emeralds, work proceeds to complete the step across

BERYL LOCALITIES

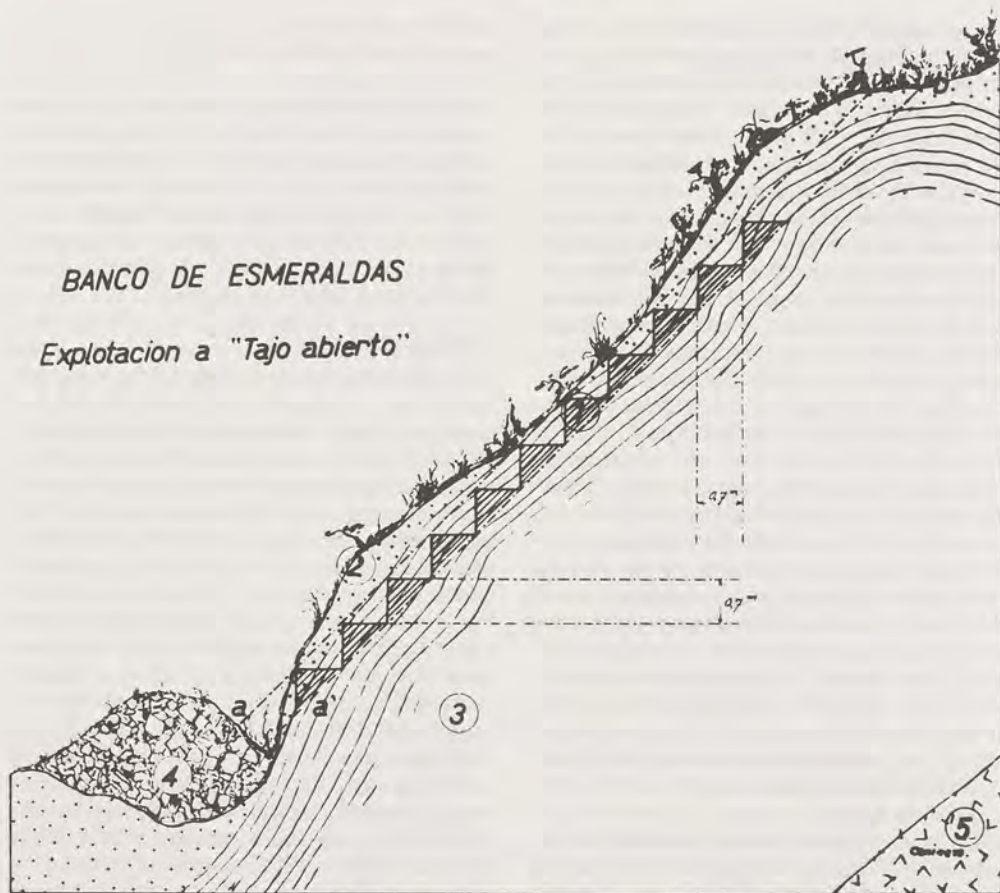

Fig. 14-25 A. M. Barriga Villalba's schematic illustration of the mining method known as benching employed at Muzo. (1) Series of steps. (2) Parts of the Lower Cretaceous formation covering the emerald-bearing formation (3), underlain by the "ash bed" or cenicero (5). Washed-down debris is shown at (4). From G. Otero Muñoz and A. M. Barriga Villalba, *Esmeraldas de Colombia*, part 2 (Bogotá, 1948).

the working face, at which time another step is started above, with the debris dumped below. The new step is carried across the working face as before.

After the entire slope is slowly and systematically excavated in a surface layer one step deep by this means, it becomes necessary to clear off the debris to expose fresh rock. The gates at the reservoir above are opened, and a flood of water washes and tumbles the debris to the bottom of the slope. This method only works well in those places where the hillsides are sufficiently steep, water is available, and enough storage capacity

exists at the base of the slope to accommodate the waste. If these conditions are not met, other means are used, including tunnelling, bulldozing, use of explosives to loosen ground, etc.

The productivity varies widely according to richness of ground and the amount of mining effort expended. No direct correlation exists between the various factors in any case, and only generalizations are possible. Scheibe recorded that in a period of twenty months at Muzo during 1911-12, about 16% of the emeralds mined were of commercial quality but only 2.33% were of fine, green first quality.³⁷ During this period,



Fig. 14-26 Views taken in the Chivor emerald mine about 1920, showing clearing of overburden (top photos) and development of the "step" or "benching" method to systematically excavate the emerald-bearing ground. From L. J. Canova, *Chivor-Somonoco Emerald Mines of Colombia* (New York, 1921).

BERYL LOCALITIES

256,000 carats of commercial stones were produced, reckoned at 1,075,000 pesos. Morallas, or non-commercial emeralds, were produced at the same time to a total of 277 kg (611 lb). Scheibe was of the opinion that profitable mining at Muzo could be continued for an indefinite period and that at least one million gold pesos worth of emeralds could be produced each year using 10–15% of that amount for actual operating expenses. In contrast, Klein, after visiting Muzo, concluded that only 0.002–0.003% of all emerald mined was gem quality.³¹

In regard to production actually delivered, Klein was of the opinion that about 30% of the best quality stones were stolen and sold into illegal channels by the miners themselves.³¹ He attributed thievery to the very low standard of living among the workers, who were very poorly paid. In 1911, for example, as little as U.S. \$.25–.45 was paid daily. However, by 1958, according to Wolf, workers were paid 2.30–4.70 pesos daily, but with food, lodging, and medical attention provided free.⁸⁰

Due to similar topography, formations, supply of water, etc., mining at Chivor generally follows the patterns established at Muzo.^{17,31,38,76} At the time of Johnson's visit in about 1960, the mine was being worked by benching, tunnelling and bulldozing, with major effort concentrated on benching.³⁸ Only one tunnelling project was underway and that was scheduled to cease in the near future. Bulldozers were used to strip away overburden but were also employed to follow emerald-vein leads. Recovered stones at Chivor, according to Colombian law, must be kept in storage at mine headquarters until a government official from Bogotá comes to inspect, weigh, and seal production lots. These are then shipped under seal to the capital. In Bogotá the seals are ex-

amined by government officials and the contents of the parcels verified and their value appraised. The parcels are then re-sealed, export licenses granted, and the stones allowed to leave the country if such is desired. For a recent account of mining, see Keller.⁸⁷

Color and Quality Grading

In 1960, according to Wokittel, government standards recognized six grade groups from No. 1 downward, based on quality of color, brilliancy, clarity, etc.¹⁹ However, in 1973, Barriga Villalba and Barriga del Diestro furnished a governmental standard, based on the same fundamental properties, but further subdivided into three grades each.⁶⁹ Under color, for example, the first grade is the finest or "grass green," while the third grade is pale green. Under brilliance, the best grade is "adamantine, resplendent," but the third grade is "brilliant as cut glass." In respect to clarity, the best grade is that entirely free of inclusions and flaws; the second grade is "transparent but with jardin," and the last grade is "transparent with much jardin."

The above standards presumably apply to government production, while at Chivor, rough is assigned numerical values for intensity of color, from No. 1 downward to No. 6 the lowest grade. A letter from A to D is assigned to clarity, the first for flawless stones. Locally the best color is called "gota de aceite" or "drop of oil."³⁸

Approximate prices for rough, per carat, at Chivor according to this grading system were: 1B – \$1,000, 1C – \$500, 2B – \$300, and 3A – \$60. Morello was informed by Francis P. Pace of Chivor Emerald Mines, Inc., that a superb quality, 13-carats rough sold for \$10,000 per carat.⁸²

MacFadden provided the following statistics for a two-months production sample at Muzo:⁸³

Table 14-13
GRADING OF MUZO PRODUCTION SAMPLE

Color Class	Carats	Value ^a	Percent of total wgt.	Percent of value
No. 1	523	\$130,750	0.75	7.70
No. 2	2,182	218,500	3.15	12.80
No. 3	9,548	477,400	13.60	28.60
No. 4	12,649	316,200	18.50	18.50
No. 5	44,116	551,400	64.00	32.40

^aEstimated values based on 1 carat of No. 1 at \$250, No. 2 at \$100, No. 3 at \$50, No. 4 at \$25, and No. 5 at \$12.50. The average production per month = 34,509 carats valued at \$847,125.

World Sources of Ore and Gem Beryl / Colombia

Table 14-14
PRODUCTION AND SALES AT MUZO AND COSCUEZ, 1904-1946

<i>Year</i>	<i>Carats</i>	<i>Reference</i>	<i>Year</i>	<i>Carats</i>	<i>Reference</i>	<i>Year</i>	<i>Carats</i>	<i>Reference</i>
1904	643,000	20	1910	223,515	20,84	1928-32 ^a	—	19
1905	466,406	20	1911-23	no production		1933	25,000	41
1906	571,886	20	1924	120,961	20	1934 ^b	—	42
1907	575,347	20	1925	44,343	85	1935-37	no data	
1908	173,063	20	1926	49,130	20	1938	118,645	19,20
1909	1,874,447	20	1927	51,059	20,19	1939-46	no production	

^aNo production in 1931; other data unavailable.

^bProduction figure unavailable, value given as U.S. \$238,000.

Table 14-15
PRODUCTION AND SALES AT MUZO AND COSCUEZ, 1947-1962
Banco de la Republica data, in carats²⁰

<i>Year</i>	<i>Mine</i>	<i>Piedras</i>	<i>Morallas</i>	<i>Sales</i>	<i>Value, cut</i>
1947	Muzo	220.00	1,287.00	20.42	\$ 9,000
1948	Muzo	8,485.63	68,433.80	1,086.47	113,760
1949	Muzo	11,574.78	—	1,062.48	120,275
1949	Coscuez	823.97	—	—	—
1950	Muzo	—	60,284.00	212.80	75,474
1951	Muzo	58,496.65	86,148.02	1,040.18	394,380
1952	Muzo	4,707.84	23,346.22	2,803.22	805,350
1953	Muzo	504.69	4,189.01	37.25	81,662
1954	Muzo	6,848.84	15,540.24	143.72	82,675
1955	Muzo	14,462.14	39,554.67	609.88	283,860
1956	Muzo	3,666.97	18,262.74	2,670.47	519,592
1957	Muzo	1,579.03	26,113.88	999.22	223,060
1958	Muzo	4,729.83	6,889.54	325.21	119,875
1959	Muzo	28,153.30	34,134.40	1,923.29	282,405
1960	Muzo	11,716.56	19,910.22	1,940.69	1,192,825
1960	Coscuez	365.15	957.37	—	—
1961	Muzo	25,954.23	73,015.10	1,671.57	1,680,815
1961	Coscuez	1,453.33	6,373.50	—	—
1962	Muzo	28,474.36	239,624.91	2,977.19	1,821,219
1962	Coscuez	17,624.37	17,915.39	—	—

The income of the government from emerald mining during 1832-1919 totaled \$3,059,065 and during 1923-1932 a total of \$1,102,700.52 according to Wokittel (p. 154-5).¹⁹

BERYL LOCALITIES

Table 14-16

CHIVOR EMERALD PRODUCTION, 1926-1962

In carats. Taken from archives of Compañía de Minas de Chivor and from records of the Columbian Ministry of Mines.²⁰

Year	Total ^a	Morallas	Totals	Year	Total	Morallas	Totals
1926	37,570	5,900	43,470	1952	18,930	5,143	24,073
1927	37,545	—	37,545	1953	15,835	3,170	19,005
1928	—	—	—	1954	7,225	31,657	38,882
1929	29,444	34,400	63,844	1955	7,558	154,970	162,528
1930	35,505	30,000	65,505	1956	9,120	410,564	419,684
1931	46,250	—	46,250	1957	22,279	336,604	358,884
1937-40	28,837	73,933	102,770	1958	12,013	14,064	26,077
1941-47	—	—	—	1959	20,733	31,503	52,236
1948	49,735	12,090	61,825	1960	19,787	25,201	44,988
1949	70,516	23,030	93,546	1961	10,692	9,884	20,576
1950	10,507	12,117	22,624	1962	5,060	60,582	65,642
1951	12,456	16,625	29,081	Totals	507,597	1,282,438	1,790,035

^aIncludes piedras, chispas, canutillos.

Despite the high value of the No. 1 grade, its total value is less than 8% of the whole, showing that profits are actually made on gems of lesser quality. At the time (1931), the best market was New York City where fine gems sold for as much as \$5,000 per carat and some special gems for double that figure. According to Hintze who gave figures as of 1976, the average price for good quality Colombian rough in the country itself was U.S. \$400-600 per carat as compared to only U.S. \$10 per carat for Brazilian rough.¹⁶

Local terms designating certain classes of rough are as follows. *Morallas* are greenish to nearly white fragments, masses, or even portions of crystals that are so filled with inclusions and flaws as to be opaque. They are worthless for gems, although they can be sold in India where crushed gemstones are still employed as medicines. *Canutillos* are very thin, small prismatic crystals, commonly of gem quality, but too small for cutting into faceted gems. They may be used uncut as insets in jewelry, especially in small gold crosses. *Chispas* are very small gemmy bits of rough seldom used for faceted gems because of size. In terms of production, morallas are the major part.

In another table of statistics, prepared by Willis F. Bronkie of Chivor and published by Johnson (p. 150),³⁸ the total production of gem grades for the period 1921-1957 is given as 502,365 carats and morallas 1,101,882 carats. The following table shows the amounts produced in the several grades.

Table 14-17

CHIVOR EMERALD PRODUCTION
BY GRADES, 1921-1957
Compiled by Willis F. Bronkie³⁸

Grade ^a	Carats	Grade	Carats	Grade	Carats
1B	769	3A	25,250	4D	2,335
1C	1,550	3B	29,928	5	7,240
2A	8,806	3C	21,076	5A	122,876
2B	14,649	3D	5,977	5B	67,981
2C	8,317	4A	82,346	5C	12,645
2D	1,527	4B	35,452	6	17,958
3	1,242				

^aGrading system: 1 = best color to 6 = poorest color; A = flawless to D = very flawed.

World Sources of Ore and Gem Beryl / Colombia

Production figures for Chivor were also supplied by Rainier,⁷⁶ Eppler,⁸⁶ while a production of 4,000 carats, apparently an approximation, was given by Ball for 1933.⁴¹

Table 14-18

EMERALD PRODUCTION, GACHALÁ MINE
VEGA DE SAN JUAN
Dominguez (p. 162),²⁰ in carats

Year	Piedras & Chispas	Morallas
1954	749.51	177.93
1957	9,532.11	32,847.94
1958	23,367.77	34,676.33
1959	3,291.47	8,165.00
Totals	36,940.86	75,867.20

Table 14-19

EMERALD PRODUCTION, GACHALÁ
BY GRADES FOR 1959
Wokittel,¹⁹ in carats

Grade	Quantity
No. 1, No. 2	nil
No. 3	1,285.17
No. 4	851.03
Other grades	3,020.49
Total	5,156.69
Morallas	19,966.93
Grand total	25,123.62

Table 14-20

EMERALD PRODUCTION, BUENAVISTA MINE
Dominguez (p. 162),²⁰ in carats

Date	Piedras & Chispas	Morallas	Totals
Dec. 1957	1,570.09	1,583.50	3,153.59
Mar. 1958	233.95	28,214.63	28,448.58
June 1958	1,408.44	2,220.74	3,629.18
Sept. 1958	3,502.26	255.07	3,757.33
Apr. 1959	3,258.81	3,670.00	6,928.81
May 1959	3,502.42	255.06	3,757.48
July 1959	233.75	28,380.92	28,614.67
Totals	13,709.72	64,579.92	78,289.64

Table 14-21

EMERALD PRODUCTION, BUENAVISTA
BY GRADES FOR 1959
Wokittel,¹⁹ in carats

Grade	Quantity
No. 1, No. 2	nil
No. 3	258.72
No. 4	3,580.05
No. 5	468.70
Other grades	2,687.51
Total	6,994.98
Morallas	32,305.98
Grand Total	39,300.96

Thefts and Illicit Traffic

The open character of the deposits and locations in remote areas has always made it relatively easy for determined men to steal emeralds, if not mine them for themselves. Despite close supervision of miners at work, and elaborate security measures taken to guard the property during darkness, stealing has been, and remains a serious problem. F. C. Pace, president of Chivor Emerald Mines, Inc., stated to Morello⁸² that the company had lost an estimated \$15-20 million to thieves since 1925. A Bogotá official estimated that up to 90% of all Muzo stones eventually find their way into contraband channels, but Banco de la Republica and Chivor officials agree that thefts by mine workmen probably do not exceed 5% of the total production, although one may be sure that if such is the case, the 5% probably represents the highest quality stones. In a single raid by Colombian authorities on a Bogotá cafe frequented by dealers in contraband emeralds, uncut stones valued at 200,000 pesos or about U.S. \$80,000 were recently seized. It is impossible to place accurate figures on such thefts and illicit dealings, but it seems that an enormous quantity of stones are afloat in the black market as indicated in newspaper articles of recent dates.^{52,54,55} Many authorities who have examined official production figures, such as those given above, point out that the quantity of emeralds in the hands of jewelers all over the world vastly exceeds such figures and strongly supports the view that the black market is very large.

BERYL LOCALITIES

Beryl Elsewhere in Colombia. Beryl is reported from mica pegmatites in Norte de Santander Province near the Venezuelan border. Aquamarine occurs in calcite/dolomite veins near Guatequé, Boyaca; the occurrences seem related to the emerald-bearing veins of Somondoco-Chivor-Almeida.¹⁹ In 1922, Ward's Natural Science Establishment of Rochester, N.Y. advertised for sale aquamarine crystals, possibly from this locality, described as 0.5–1.0 cm (0.25–0.4 in) complexly-faced, transparent crystals of "good" color, displaying faces of prisms *m* and *a*, *c* and several dihedral bipyramids.

- Hendley, T. H. 1906–1909. *Indian Jewellery*. London: Journal of Art. 189 pp., 167 pls.
- Meen, V. B., and Tushingham, A. D. 1968. *Crown Jewels of Iran*. Toronto: University of Toronto Press. 159 pp.
- Topkapi Palace Museum. 1977? *Guide Book: The Treasury Department of the Topkapi Palace Museum*. Istanbul: Kemal Cig. 64 pp.
- Twining, Lord 1960. *A History of the Crown Jewels of Europe*. London: Batsford. 707 pp.
- . 1967. *European Regalia*. London: Batsford. 334 pp.
- Lothrop, S. K. et al. 1937. Coclé, an Archaeological Study of Central Panama. *Memoirs, Peabody Museum of Archaeology & Ethnology*, Harvard University, vol. 7, pt. 1. Cambridge, Mass.: The Museum. 327 pp.
- Otero Muñoz, G., and Barriga Villalba, A. M. 1948. *Esmeraldas de Colombia*. Bogota: Banco de la Republica. 133 pp.
- Canova, L. J. 1921. *Chivor-Somondoco Emerald Mines of Colombia*. New York: Colombian Emerald Syndicate, Ltd. 30 pp.
- Lernoux, P. 1966. Colombia's lost treasure sought by U.S. combine. *The San Diego Union*. Sunday, Feb. 6, p. G-4.
- Ball, S. H. 1931. Historical notes on gem mining. *Economic Geology*, (Lancaster, Pa.) 26:681–738.
- Herrera, A. de 1730. *Historia general de los hechos de los Castellanos en las Islas i Tierra firme de mar Océano*. 4 vols. Madrid.
- Simon, Fray 1891. *Noticias historiales de las Conquistas de Tierra Firme en las Indias occidentales*. Bogota.
- Piedrahita, L. F. 1881. *Historia general de la Conquista del Nuevo Reyno de Granada*. Antwerp, 1688; Bogota, 1881.
- Schumacher, H. A. 1875. Ueber die columbischen Smaragden. *Zeitschrift der Gesellschaft für Erdkunde zu Berlin* 10:38–62.
- Codazzi, R. L. 1929. Minas de esmeraldas. *Boletín de Minas y Petroleos, Colombia* (Bogota) 1:114–43.
- Hintze, J. 1979. Die Smaragdlagerstätten Kolumbiens. *Der Aufschluss* (Heidelberg) 30:83–92.
- Latham, E. B. 1911. The newly discovered emerald mines of "Somondoco." *Columbia School of Mines Quarterly* 32:210–14.
- Acosta, J. 1848. *Compendio histórico del Descubrimiento y Colonización de la Nueva Granada*. Paris, 1848; Bogota, 1901.
- Wokittel, R. 1960. *Recursos minerales de Colombia*. Bogota: Editorial Lumbre. 393 pp.
- Dominguez A., R. A. 1965. *Historia de las Esmeraldas de Colombia*. Bogota: Impreso en Graficos Ducal. 297 pp.
- Herman, F., and Wussow, D. 1935. The emerald deposits of the world. *The Mining Magazine* 53:20–5.
- The Esmeralda Emerald Mines (Limited). 1883. *The Mining Journal* 53:410.
- . [Emerald syndicate registered to work in Colombia]. 1891. *The Mining Journal* 61:7.
- . [Emerald Mines of Colombia ordered to cease work]. 1892. *The Mining Journal* 62:222.
- Kunz, G. F. 1894. Precious stones. Chapter in *U.S. Geological Survey Mineral Resources of the U.S. for 1893*, pp. 696–7.
- The Somondoco Company Emeralds. 1899. *The Mining Journal* 69:936.
- . Somondoco Emeralds, Limited. 1900. *The Mining Journal* 70:1482.
- . Somondoco Emeralds, Limited. 1901. *The Mining Journal* 71:1400–1.
- Dixon, S. S. 1902. Mining in Colombia in 1901. *The Mining Journal*, 72:429.
- Lease of emerald mines offered. 1903. *The Mining Journal* 73:632.
- Klein, F. 1941. *Smaragde unter dem Urwald*. Berlin: Oswald Arnold. 285 pp.
- Sterrett, D. B. 1907. Precious stones. Chapter in *U.S. Geological Survey Mineral Resources of the U.S. for 1906*, p. 1213–52.
- Smith, G. F. H. 1926. The Colombian emerald. *Jeweller and Metalworker* (London) Oct. 1, pp. 1374, 1376.
- Olden, C. 1911. Emeralds: their mode of occurrence and methods of mining and extraction in Colombia. *Transactions, Institute of Mining and Metallurgy*, (London) 21:194–209.
- Levine, V. 1914. *Colombia*. New York.
- Scheibe, R. 1922. Esmeraldas de Nemocón, Departamento Cundinamarca. *Informe de Instituto Geológico Nacional, Bogotá*, No. 546 in *Compilaciones de los Estudios Geológicos Oficiales en Colombia 1917–a* (Bogota 1933) 1:223–8.
- Scheibe, R. 1926. Das Smaragdorkommen von Nemocón. *Beiträge zur Geologie und Mineralogie von Kolumbien*, ed. O. Stutzer, in *Neues Jahrbuch für Mineralogie* (Stuttgart) 53:312–4.
- Johnson, P. W. 1961. The Chivor emerald mine. *Journal of Gemmology* 8:126–52.
- Kunz, G. F. 1924. Precious stones. Chapter in *The Mineral Industry during 1923*. Vol. 32. New York: McGraw-Hill Book Co. p. 578.
- . 1930. Precious stones. Chapter in *The Mineral Industry during 1929*. Vol. 38. New York: McGraw-Hill Book Co. pp. 530–54.
- Ball, S. H. 1934. Precious and semiprecious stones (gem minerals). Chapter in *U.S. Bureau of Mines Minerals Yearbook 1934*, Pt. 3, p. 1095.
- . 1935. Precious and semiprecious stones. Chapter in *U.S. Bureau of Mines Minerals Yearbook 1935*, p. 1211.

World Sources of Ore and Gem Beryl / Czechoslovakia

43. ———. 1938. Gem stones. Chapter in *U.S. Bureau of Mines Minerals Yearbook 1938*, p. 1295.
44. ———. 1947. Gem stones. Chapter in *U.S. Bureau of Mines Minerals Yearbook 1946*, p. 541.
45. Anderton, R. W. 1950. Report on Chivor emerald mine. *Gems & Gemology* 6:276–7, 379.
46. ———. 1955. The new Gachalá emerald mine in Colombia. *Gems & Gemology*. 8:195–6.
47. Cochrane, R. S. 1970. U.S. owners regain Colombia gem mine. *San Diego Union*. June 14.
48. Anderton, R. 1957. Emerald outlook in Colombia. *Gems & Gemology* 9:60–1.
49. Mining miscellany. 1961. *The Mining Journal* 257:317.
50. Anderton, R. 1965. The present status of Colombian emerald mining. *Lapidary Journal* 19:374–77.
51. [United Press story, July 21, 1968]. 1968. *Lapidary Journal* 22:824.
52. Emeralds and bullets. 1971. *Time*, July 12, p. 56.
53. Bancroft, P. 1971. The lure of Chivor. *Lapidary Journal* 25:128–31.
54. Jewel poachers make millions. 1976. *San Diego Union*, Sunday, Jan. 4.
55. Hazards abundant in emerald trade. 1977. *The New York Times*, Oct. 13.
56. Gansser, A. 1963. Quarzkristalle aus der kolumbischen Anden (Südamerika). *Schweizerische mineralogische und petrographische Mitteilungen* (Zurich) 43:91–103.
57. Gutierrez, M. 1913. Estudio geológico de las minas de esmeraldas de Muzo. *Anales de Ingeniería* (Bogotá) p. 1–14. Reprinted in ref. 20 pp. 211–19.
58. Pogue, J. E. 1916. The emerald deposits of Muzo, Colombia. *Transactions, American Institute of Mining & Metallurgical Engineers* 55:810–34.
59. Bürgel, H. 1956. Condiciones geológicas de las minas de esmeraldas de Muzo, Boyacá. *Revista de la Academia Colombiana de Ciencias Exactas, Físicas y Naturales* (Bogotá) 9:381–8.
60. Restropo, H. 1961. Reconocimiento de las minas de esmeraldas de Muzo, Departamento de Boyacá. *Servicio Geológico Nacional, Boletín Geológico* 7, nos. 1–3, pp. 61–84.
61. Lévy, B. 1857. Recherches sur la formation et la composition des émeraude. *Compte Rendu de l'Académie des Sciences* 45:877–81.
62. Vrba, K. 1881. Mineralogische Notizen: 13. Smaragd von Santa Fé de Bogotá. *Zeitschrift für Kristallographie und Mineralogie* (Leipzig) 5:430.
63. ———. 1882. Mineralogische Notizen. III. *Neues Jahrbuch für Mineralogie* p. 355–9.
64. Bertrand, E. 1879. [Trapiche crystals, Muzo]. *Bulletin de la Société Française de Minéralogie* 2:31.
65. Codazzi, R. L. 1915. Los minerales de Muzo. *Contribución al Estudio de los Minerales de Colombia*. Bogotá: Imprensa de la Cruzada. pp. 3–7.
66. Bernauer, F. 1926. Die sogenannten Smaragdgrülinge von Muzo und ihre optischen Anomalien. *Neues Jahrb. für Min.* Abt. A, Beilage-Bd. 54, pp. 205–42.
67. ———. 1933. Las llamadas maclas múltiples de esmeraldas de Muzo y sus anomalías ópticas. *Informe de la Instituto Geológica Nacional, Bogotá*, No. 757; also in *Compilaciones de los Estudios Geol. Oficiales en Col.* 1:199–221.
68. Nassau, K., and Jackson, K. A. 1970. Trapiche emeralds from Chivor and Muzo, Colombia. *American Mineralogist* 55:416–27; correction, 55:1808–9.
- 68a. ———. 1970. Trapiche emeralds from Chivor and Muzo, Colombia: nature and origin. *Lapidary Journal* 24:82, 84–6.
69. Barriga Villalba, A. M., and Barriga del Diestro, A. M. 1973. *La Esmeralda de Colombia*. Bogotá: Colegio Mayor de Nuestra Señora del Rosario. 100 pp.
70. Vogel, P. 1934. Optische Untersuchungen am Smaragd und einigen anderen durch Chrom gefärbten Mineralien. *Neues Jahrb. für Min.* 68:401–38.
71. Webster, R. 1975. *Gems*. 3rd ed. London: Butterworths. 931 pp.
72. Wöhler, F., and Rose, G. 1864. Sur la nature colorante des émeraude. *Compte Rendu de l'Académie des Sciences* 58:1180.
73. Gübelin, E. J. 1953. *Inclusions as a Means of Gemstone Identification*. Los Angeles: Gemological Institute of America. 220 pp.
- 73a. ———. 1973. *Internal World of Gemstones*. Zurich: ABC Edition. 234 pp.
74. Reiss, W., and Stübel, A. 1902. Geologische Studien in der Republik Colombia. II. Petrographie. 2. Die älteren Massengesteine, krystallinen Schiefer und Sedimente. *Zeitschrift für Krist. und Min.* 35:298–301.
75. Mentzel, C. 1931. Geology of the Chivor No. 1 mine. Appendix 1 in Rainier, P. W. ref. (76) pp. 213–16.
76. Rainier, P. W. 1931. The Chivor-Somondoco emerald mines of Colombia. *Transactions of the American Institute of Min. & Met. Eng.* 96:204–23.
77. Mutis Jurado, V., and Wokittel, R. 1954. Informe sobre los yacimientos esmeraldíferos de los municipios de Ubalá, Gachalá, Almeida, Macanal y Somondoco. *Colombia, Instituto Geológico Nacional*, Informe 1050, pt. 1, pp. 1–30; pt. 2, pp. 1–29.
78. Tagore, S. M. 1879. *Máni-Mála, or a Treatise on Gems*. 2 vols. Calcutta: Stanhope Press.
79. Trapp, F. W. 1969. The Gachala emerald shares the spotlight with the Hope diamond at the Smithsonian. *Lapidary Journal* 23:628.
80. Wolf, B. 1958. The green treasure of the Andes. *Saturday Evening Post*, Oct. 11, pp. 24, 25, 80, 82–3.
81. Feininger, T. 1970. Emerald mining in Colombia: history and geology. *The Mineralogical Record* (Bowie, Md.) 1:142–9.
82. Morello, T. 1956. The gem of Colombia. *Americas*, vol. 8, no. 10, pp. 21–4.
83. MacFadden, C. K. 1931. Brief review of emerald mining in Colombia. Appendix 2 in Rainier, P. W. ref. (76) pp. 216–23.
84. Colombia Emerald Company. 1910. *The Mining Journal* 90:853.
85. Kunz, G. F. 1927. Precious stones. Chapter in *The Mineral Industry during 1926*. Vol. 35. New York: McGraw-Hill Book Co. pp. 563–91.
86. Eppler, W. F. 1935. Die Smaragdgruben von "Chivor" oder "Somondoco" in Kolumbien. *Deutsche Goldschmiede-Zeitung* 38:9–12.
87. Keller, P. C. 1981. Emeralds of Colombia. *Gems & Gemology* 17:80–92.

CZECHOSLOVAKIA

Beryl is commonly found in granitic pegmatites in Bohemia, Moravia, Silesia and middle Slo-

BERYL LOCALITIES

vakia. Extended treatments of minerals in Moravia are in Burkart¹ and Krutá,² while the mineralogy of the entire country was described by Zepharovich.³

Bohemia

Yellowish, opaque beryl is occasionally found in iron ores of Blatno, 20 km (12.5 mi) N of Karlovy Vary according to Zepharovich (vol. 2).³ Tin ores of Příbusy, 25 km (16 mi) NW of Karlovy Vary contain some beryl with lepidolite, fluorite, tourmaline, tantalite, wolframite in feldspar, quartz and mica.⁴ At Nýdek, 17 km (10.5 mi) NW of Karlovy Vary, very small white crystals occur in granite. At the famous mineral specimen locality of Schlaggenwald, 11 km (7 mi) SSW of Karlovy Vary, pale blue crystals occur in quartz, also grayish to greenish-white in radiate growths with molybdenite, chalcopyrite and sphalerite.^{3, v.1} At times the crystals are clear, and some are varicolored green and pink near terminations. In veins at Göllnauer, dark blue crystals occur.^{3, v.2} Granitic pegmatites near Kynšperk and Mariánské Lázně contain small amounts of beryl.⁵

In the northern Bohemian Forest, near the Bavarian border, a group of pegmatites is situated about 40 km (25 mi) SW of Plzen; those at Poběžovice, Metzling, and Bischofsteinitz are known to produce beryl;⁶ the pegmatites intrude granite and adjoining rocks and range up to 1,000 m (1200 yd) long. Beryl occurs in greenish prisms to 10 kg (22 lb) but not in commercial quantities.⁷ For Poběžovice beryl Kratochvíl gave $G = 2.707$, $o = 1.581$, $e = 1.575$ for common beryl, and $G = 2.709$, $o = 1.580$, $e = 1.575$ for a pale green variety.⁸ Near this locality at Kikersberg beryl is found in pegmatite intruding gabbro as well formed yellowish, yellowish-green crystals, rarely blue-green, the last sometimes semitransparent and up to 35×20 cm (10×8 in) in size. $G = 2.707$ (yellow), 2.708 (green); $o = 1.581$ (yellow), $o = 1.580$ (green) and $e = 1.575$ for both. Beryl is reported from Schütwa and Metzling.^{3, v.3}

The best known beryl locality is at Pisek, a city in S Bohemia located about 87 km (52 mi) S of Praha (Prague). Several complex granitic pegmatites, emplaced in tourmaline granite, contain microcline perthite, tourmaline, apatite, muscovite, beryl, quartz (sometimes rose), albite, hem-

atite, bertrandite, arsenopyrite, pyrite and chalcopyrite. The largest amount of ore beryl was taken from the quarry "U Obrázku" in 1884 and from the quarry "Ondraž" on the Schwarzenberg about 2 km (1.3 mi) N of Pisek. Woldrich recorded prisms to 0.5 kg (1.1 lb) from Ondraž.⁹ Zepharovich (vol. 3) described greenish white prisms to 10×4 cm (4×1.7 in) and smaller green and larger wine-yellow crystals in quartz at the Pisek quarries.³ According to Döll gem quality crystals of asparagus-green, but seldom over 1 cm (0.4 in), were found.¹⁰ Vrba noted two varieties of beryl from the Obrázku quarry, the first opaque common beryl, but the second transparent gem crystals, sometimes of beautiful golden color or pale blueish-green.¹¹ The common beryl was always more or less altered and friable, pale yellow or greenish-yellow in color, and with advanced alteration, assuming a yellow to brownish color. Nacreous bertrandite platelets commonly coat such beryls and fill small cavities and fissures in the crystals.¹² The common variety occurred in hexagonal prisms to 15 cm (6 in) diameter and 20 cm (8 in) long, with forms $m\{10\bar{1}0\}$, rarely $c\{0001\}$, and very rarely with $\{10\bar{1}1\}$, $\{11\bar{2}1\}$, and $\{21\bar{1}1\}$. In contrast, the gem beryls display corrosion figures and striae, with the largest crystal seen by Vrba about 3 cm (1.25 in) long and 2.25 cm (0.8 in) in diameter. Some gemmy fragments were completely formless and apparently were corroded remnants of larger crystals. Forms on the better gemmy crystals are: $\{10\bar{1}0\}$, $\{0001\}$, $\{11\bar{2}1\}$, $\{10\bar{1}1\}$, and $\{31\bar{4}1\}$.^{6, 10, 11} The catalog of the precious stones in the National Museum in Prague¹³ lists six faceted Pisek beryls ranging from pale yellow or pale green to deep yellow or yellow green; they weigh from 2.5 carats to 18.555 carats, the last a step brilliant of deep yellow green. Other localities near Pisek are Velká Skalá and at Rother Berg at Otava.^{3, vol. 1; 14}

Miscellaneous localities are: Berg, Alt-Gratin, Varinec Hill near Domazlice, Troatlin, Haslava, Nacetin, Ohnistovice.^{3, vol. 1; 3; 15}

At Caslav, 75 km (47 mi) ESE of Praha, and at Trebesic nearby, small crystals occur in pegmatite. Large greenish white masses occur in quartz in pegmatite at Jenikau, 88 km (55 mi) NW of Brno.^{3, vol. 1} Biotite pegmatites carry beryl near Budislav in E Bohemia.

World Sources of Ore and Gem Beryl / Czechoslovakia

Moravia

Beryl occurs in granitic pegmatites cutting serpentinites in quarries of Věžna near Rožna, about 60 km (37.5 mi) NW of Brno; alteration of beryl to epididymite and milarite is noted by Černý.¹⁶ Beryl also occurs in complex, zoned bodies at Rožna, near Pernštejnem, in the vicinity of Bistřice ca. 48 km (30 mi) NW of Brno^{6,17} at Kozlov by Štěpánova, 41 km (26 mi) NW of Brno; and at Drahonín by Tišnova 21 km (13 mi) NW of Brno. It is also found in schorl-rich pegmatite blocks at Komarovice near Jihlavy, a city ca. 77 km (48 mi) WNW of Brno.¹ A famous occurrence is known at Jaclov near Jihlavy, where a lithium pegmatite contains two types of beryl, the first in pegmatite containing lithium minerals and the second as granules enclosed in lithium minerals. The first type gave $o = 1.576$, $e = 1.570$, the second $o = 1.582$, $e = 1.576$ (more alkalies). The latter is associated with petalite, topaz, columbite and bertrandite.^{1,18,19} Pegmatite dikes at Puklice near Jihlavy furnished crystals to 2 cm (0.8 in) long and 2–3 mm thick of yellowish or yellow green color associated with amblygonite, columbite, lepidolite, tourmaline, topaz and other species.^{1,18,20} Small prisms appear in granitic pegmatite at Dolní Bory near Velkého Meziříčí ca. 48 km (30 mi) NW of Brno.^{1,18} A pegmatite at Cyrilov in W Moravia contains bavenite with adularia pseudomorphous after beryl and filling cavities corresponding to original beryl crystals.⁶ Minor beryl is found at Ctudružice at Moravské Budejovic, 60 km (37.5 mi) SW of Brno.

In the vicinity of Šumperka, ca. 98 km (60 mi) NNE of Brno, many complex granitic pegmatites occur, some with beryl. Those around and nearby Maršikov were described by Pokorný and Staněk,²¹ who particularly noted a complex body near Scheibengraben between Maršikov and Wermsdorf remarkable for its richness in species. In the same group, a body at Schinderhübel yielded chrysoberyl as well as 5 cm (2 in) long beryl crystals.²² Greenish and blueish crystals occur on Trausnitzberg, a mountain on Merta River above Maršikov and opposite Stättenhof.²³ Other localities are: Sedm Dvorů, in large white and greenish crystals; in alluvial pegmatite blocks at Ullersdorf on Tess River; in gneiss at Kozlov; at Velké Losiny near Sobotřina; at Kouty as rolled pebbles in alluvium; on Goldenstein at Dämmbaude

in Mittelbord Tal as finger-thick prisms of pale green hue to 6 cm (2.25 in) long; at Petrovice on Desnou River on the Trausnitzberg, and at Rodolice in pegmatite blocks between the Hirsch-kamm and Hemmberg.^{3, vol. 1: 1}

1. Burkart, E. 1953. *Moravské Nerosty a jejich Literatura-Mährens Minerale und ihre Literatur*. Prague: Československo Akademie Véd. 1004 pp.
2. Kruta, T. 1966. *Moravské Nerosty a jejich Literatura, 1940–1965*. Brno: Moravské Museum. 379 pp.
3. Zepharovich, V. von. 1859–1893. *Mineralogisches Lexicon für das Kaiserthum Österreich*. Vienna: Wilhelm Braumüller. Vol. 1, 1859; vol. 2, 1873; vol. 3, 1893.
4. Putzer, H. 1952. The tin-ore deposits of Fröbuss and their cleft mechanics. *Berg- und Hüttenmännische Monatshefte, Montanische Hochschule Leoben* 97:41–51.
5. Sellner, F. 1924. Die Pegmatite der Umgebung von Marienbad. *Zeitschrift für Kristallographie und Mineralogie* (Leipzig) 59:504–12.
6. Schneiderhöhn, H. 1961. *Die Erzlagerstätten der Erde*. Vol. 2: *Die Pegmatite*. Stuttgart: Gustav Fischer. 721 pp.
7. Kimbauer, F. 1940. Die Feldspatvorkommen bei Ronsperg, Katzling und Bischofsteinitz. *Zeitschrift für Praktische Geologie* (Berlin) 48:15–23.
8. Kratochvíl, F. 1934. Beryl z Meclova u Poběžovic. *Rozpravy Česke Akademie Věd e Uměni* (Prague) vol. 44, no. 32. 8 pp.
9. Woldřich, J. N. 1888. Ueber das Vorkommen einiger Mineralien in Südböhmen. *Zeitschrift für Krist. u. Min.* 13:630.
10. Döll, E. 1888. Ueber einen Riesenpegmatit bei Pisek. *Zeitschrift für Krist. u. Min.* 13:629–30.
11. Vrba, C. 1895. Mineralogische Notizen. VI. *Zeitschrift für Krist. u. Min.* 24:104–23.
12. Machatschki, F. 1926. Mineralogische Notizen. *Zeitschrift für Krist. u. Min.* 63:457–65.
13. Kouřimský, J. 1968. [Catalogue of the Collection of Precious Stones in the National Museum in Prague]. Prague: Národní Muzeum v Praze. 159 pp.
14. Ježek, B., and Krejčí, A. 1919. [Minerals from the Velká Skalá near Pisek]. *Rozpravy Česke Akademie Věd e Uměni* (Prague) cl. 2, vol. 28, no. 19. 4 pp.
15. Rost, R. 1943. Minerály pegmatitových žil na Vavřinečku u Domažlic. *Věda Přírodní* (Prague) 21:278–83.
16. Černý, P. 1963. Epididymite and milarite-alteration products of beryl from Věžná, Czechoslovakia. *Mineralogical Magazine* 33:450–7.
17. Pokorný, J. 1956. Lepidolithpegmatit von Rožna bei Bistřice ob Pernstein. *Acta Musei Moraviae* (Brno) 41:31–48.
18. Staněk, J. 1953. [Contributions to the mineralogy of some west Moravian pegmatites]. *Časopis Moravského Musea v Brně* 38:112–29.
19. ———. 1954. Spodumen a bavenit z Jaclova. *Časopis Moravského Musea v Brně* 39:67–77.
20. Jaroš, Z. 1928. Nové naleziště lepidolithu a nerostůs ním sdružených na západní Moravě. *Příroda* (Brno) 21:43–4.

BERYL LOCALITIES

21. Pokorný, J., and Staněk, J. 1951. [Beryl pegmatite of Scheibengraben near Maršikov, Moravia]. *Práce Moravskoslezské Akademie Věd Přírodních* (Brno) 23:247-58.
22. Laus, H. 1906. *Die nutzbaren Mineralien und Gesteine der Markgrafschaft Mähren und des Herzogtums Schlesien*. Brno: Carl Winiker. 182 pp.
23. Melion, J. 1903. Neuer Fundort von Beryll bei Zöptau-Petersdorf. *Tschermak's Mineralogische und Petrographische Mitteilungen* (Vienna) 22:78-9.

ECUADOR

An interesting story which appears to have some substance concerns an emerald mine in the eastern vastness of Ecuador.¹ Reportedly the mine was found by a Stewart Connelly (1899-1924?), a citizen of the United States, as a result of intensive research through colonial records in the National Library of Spain at Madrid. Here he read the account of Father Valverde telling of Pizarro receiving seven large emeralds, each as big as a hen's egg, from Atahualpa, the last emperor of the Incas. Pizarro charged Father Valverde with the task of extracting the mine location from the recalcitrant Incas, but even torture failed to divulge the information. All that Valverde learned was that the mine was deep in the impenetrable jungles of what is now part of eastern Ecuador.

Further research by Connelly in the archives of Quito supposedly uncovered the locality among old documents and maps, and armed with this information, he set off eastward over the Andes into the Oriente of Ecuador. He returned nine months later, in delirious condition and speaking a strange Indian dialect, but with a leather pouch containing emeralds. One stone was displayed prior to his return to Quito and was said to have been of magnificent quality and about 20 carats weight. It was given to the rector of the mission that nursed him back to health. One estimate valued all Connelly's stones at \$100,000.

A claim for the mine property was filed in Quito, No. D-3311397, for a ten-year exclusive rights period, with the emeralds shown as evidence to a Señor José Rafael Villacreces of the Bureau of Mines. Lacking specific locality data, Connelly was allowed to submit his handwritten trip journal, with supplementary verbal information, to support his claim and its probable location. On this basis, the claim was granted conditionally, and from the journal this account of location was taken: "as the crow flies . . . not more than sixty-five miles from Puerto Napo . . . on the banks of the Rio Napo which had

been my starting point." More exact information from Connelly gave the mine as located 10 miles E of the Rio Numbo, and about 124 land miles in a NE direction, beginning at Puerto Napo and ending 15 miles beyond the Orinoco Indian village, in the black slate cliffs [!] of an unknown range of mountains. Connelly later organized an expedition to the mine, setting out on March 1, 1924, and leaving Puerto Napo on about March 14, 1924, but never to return. To this day nothing further is known of the mine nor of what fate befell Connelly.

1. Krippene, K. 1960. A fortune in emeralds. *Argosy* (New York) June 1960, pp. 30-33, 104-7.

ETHIOPIA

Granitic pegmatites, some with beryl, occur SE of Massua in Eritrea. A notable occurrence is at Mount Martmei, ca. 17 km (11 mi) SSE of Massua: hexagonal prisms of pale aquamarine, sometimes colorless, opaque to translucent; the crystals reach several cm in diameter; $G=2.674$. Blue beryl in quartz is reported from Harar region in Ethiopia.²

1. Liberi, G. 1932. Il berillo dell'Eritrea e sua composizione. *Annali di Chimica Applicata* (Rome) 22:544-54.
2. Pelloux, A. 1937. Brevi notizie di mineralogia dell'Impero. Sopra alcuni minerali del governo di Harar (Etiopia). *Periodico di Mineralogia* (Rome) 8, no. 1. 3 pp.

FINLAND

Beryl-bearing granitic pegmatites occur in the southern third in regions where Precambrian rocks, similar to those of southern Sweden and Norway, predominate.

Eräjärvi Parish. The Viitaniemi pegmatite is a complex, zoned body emplaced in biotite schist that was mined originally for feldspar but also produced commercial quantities of amblygonite, mica, beryl and columbite.¹ The intermediate zone contained microcline perthite, quartz, a little topaz, much beryl, and tourmaline, some colored. Beryl occurred near the quartz core. Vuggy replacement zones were notable for complex mineralizations, especially of phosphates.

Pohjanmaa Area. This includes numerous pegmatites in the Peräseinäjoki-Alavus area, 62°35' N, 23°35' E, near Kaatiala, located about 40 km (25 mi) SE of Seinäjoki.² Beryl pegmatites occur at Kuorasjärvi, Kaatiala, Hunnakojarvi, Vetamajarvi, Haapaluoma Quarry, and others,

World Sources of Ore and Gem Beryl / France

Table 14-22
PROPERTIES OF BERYLS FROM FINLAND⁶

Place	G	Refractive Indices (Na)	
Lemnäs	2.682	$o = 1.5774 \pm 0.003$	$e = 1.5717 \pm 0.003$
Fröjdböle	2.669	1.5749 ± 0.003	1.5692 ± 0.003
Rosendal	2.677	1.573 ± 0.003	1.569 ± 0.003

emplaced in Precambrian quartz diorites, granodiorites, gabbros and schists. In Haapaluoma the beryl occurs in five generations ranging from small, yellowish-green crystals in the wall zone, grayish or greenish and up to 10×4 cm (4×1.7 in) in intermediate zones, and as conical crystals of pale hues, nearly colorless, in the core. Hunnakojarvi beryl is small but some crystals reach 10 cm (4 in) diameter.

Karelia. A pegmatite dike at Uuku contains many closely-packed prisms of beryl 4–5 cm (1.5–2 in) long in biotite with much dark violet fluorite in a body that is only 30 cm (12.7 in) wide; it is emplaced in granite-gneiss. Clear yellow beryl associated with oligoclase, K-feldspar, pyrite, epidote, calcite, sericite, chlorite, and apparently no quartz, occurs here; $G = 2.677$, $o = 1.5783$, $e = 1.5723$.³ Pehrman described twins of beryl from this locality twinned at $44^\circ 56'$ on $n\{3141\}$.⁴

Tammela and Somero Parishes. A broad pegmatite district is located ca. 80 km (50 mi) NW of Helsinki or S of Forssa. There are many bodies with beryl but especially so around Pakalanmäki, Rajamäki and Penikoja. They are emplaced in mica- and amphibole-gneisses, and consist principally of microcline perthite, quartz, albite, muscovite, biotite, tourmaline and beryl, along with a number of rare accessories. The beryl is usually well-formed to $20 \times 6-7$ cm (8×3.5 in), forms $\{10\bar{1}0\}$, $\{11\bar{2}0\}$, $\{21\bar{3}0\}$, but only $m\{10\bar{1}0\}$ is common and terminal faces very rare.⁵ Volborth also mentioned rose quartz, muscovite pseudos after ilolite, and colored tourmalines in this body.¹

Kimito (Kemiö) Island. An island in the extreme SW of Finland, ca. 125 km (78 mi) W of Helsinki, with many beryl-bearing granitic pegmatites emplaced in granodiorite and noted for content of yttrium, scandium, tantalum and beryllium.⁵ Large beryl crystals are especially abundant in quarries of Rosendal, Brokärr, Lemnäs, and Fröjdböle. At Lemnäs a prism 1 m (3 ft) long

and 25 cm (10 in) diameter was reported. The beryl is associated with microcline, quartz, muscovite and Mn-apatite; also with cleavelandite and sericite, which may encrust crystals. Forms are primarily $m\{10\bar{1}0\}$, also $c\{0001\}$, $\{11\bar{2}0\}$, $\{1011\}$, and $\{11\bar{2}1\}$. Beryl twins are reported from Lemnäs by Pehrman crossing at 80° and twinned on $s\{11\bar{2}0\}$.⁴ Remarkably, some crystals at Rosendal and Brokärr were corroded to a depth of 1 cm upon their surfaces, such outer zones containing chrysoberyl crystals. At Brokärr some crystals were found consisting of alternating zones of quartz and beryl arranged parallel to the c-axis; the quartz was shown optically to be in different orientations and suggested rhythmic crystallization. Inclusions of spinel were noted.⁶

1. Volborth, A. 1956. Die Mineralparagenese im Lithiumpegmatit von Viitaniemi (Zentralfinland) vom geochemischen Standpunkt. *Tschermak's Mineralogische und Petrographische Mitteilungen* (Vienna) 3 Folge, 5:273–83.
2. Haapala, I. 1966. On the granitic pegmatites in the Peräseinäjoki–Alavus area, South Pohjanmaa, Finland. *Bulletin de la Commission Géologique de la Finlande*, no. 224, Helsinki, 98 pp.
3. Krauck, E. H. 1929. A beryl-bearing pegmatite from Uuku in Carelia (E. Finland). *Bulletin de la Commission Géologique de la Finlande* 85:70–77.
4. Pehrman, G. 1953. Zwei neue Zwillingengesetze bei Beryll. *Neues Jahrbuch für Mineralogie* (Stuttgart) Monatshefte, Jg. 1953, p. 154.
5. Makinen, E. 1913. Die Granitpegmatite von Tammela in Finland und ihre Mineralien. *Bull. de la Comm. Géol. de la Finlande*, no. 35, 101 pp.
6. Pehrman, G. 1945. Die Granitpegmatite von Kimito (S.W.-Finland) und ihre Minerale. *Acta Academiae Aboensis, Math.-Phys. Cl.*, vol. 15, no. 2, 84 pp.

FRANCE

Variscian age granites and associated gneisses and schists related to those of Cornwall and Devon in England are assumed to extend under the English Channel to emerge in the peninsulas of Normandy and Brittany in NW France. These formations extend diagonally SE across France to around Lyon, turning toward the NE and passing

BERYL LOCALITIES

through the Vosges of NE France into Germany. Throughout this belt occur numerous granitic pegmatites, many containing beryl and other rare minerals. A different pegmatite province lies along the Pyrenees in the extreme S and is related to Alpine formations.¹

Vosges. Large translucent crystals with tourmaline, mica, and garnet in pegmatite occur at Huchère pond, Saint. Nabord; small crystals at Raon-l'Étape.²

Orne (NW). Long known through Alençon, particularly from the Pont-Percé and Hertré stone quarries which have rosettes of prismatic crystals to 8 cm (3 in) diameter; others are yellowish-gray, greenish, sometimes transparent, with quartz and feldspar in pegmatitic veinlets.² Beryl occurs in granite near Barfleur with feldspar, tourmaline and quartz; in pegmatites near Gatteville and Retteville.³

Finistère (NW). Crystals are found in small lenticular pegmatite bodies in granite on the islands of Steroc near Plouésoc'h, and Terenz near Plougasnou, Bay of Morlaix along Brittany coast.⁴ Beryl is abundant in pegmatites of Fer-à-Cheval in St. Pol; at Mespaul; and in Carrière-ar-Ménez. It occurs in fibrous-radiate masses near Kergoulouarn. Other locations are at Créach-André, Kérigou; Roscoff; Coat Crenn and Troumeur in Plouvorn; Trefflez; in hexagonal prisms several cm long but as much as 20 × 6.8 cm (8 × 3 in) at Plouvez-Lochrist in Plouescat; with color generally yellow or yellow-green but fine green at Fer-à-Cheval. Beryl may be found in pegmatites 24 km (15 mi) NW of Quimper as crystals 3–4 cm long, pale green to partly colorless, transparent, and sometimes in groups.⁵

Morbihan (NW). La Villeder tin mines near Roc-Saint-André in the N of the department are noted for cassiterite in greisen and quartz-vein deposits but also for beryl crystals, some of which are perfectly formed and completely transparent. Beryl is in vugs in quartz veins with apatite, muscovite, topaz, schorl, fluorite, and cassiterite, and sometimes implanted on cassiterite crystals. The transparent beryls are generally colorless or sometimes pale blue or green and unusually brilliant upon terminal faces but matte on prism faces. They also are opaque, pale yellowish-white, in crystals or massive associated with mica and cassiterite. Individuals are not over 4 cm (1.7 in) long. Forms found are *m* and *c*, also {1011} and {1.0.1.14}; some crystals are tabular in aspect

due to large development of an opposing pair of prism faces; also found in parallel growths. Partial replacement by kaolin and bertrandite has been noted.^{2,6}

Loire Atlantique (NW). Whitish-green crystals with cassiterite occur at Piriac. Green beryl, some of gem quality, with feldspar, black and colored tourmaline, large mica books, garnet, apatite, arsenopyrite, autunite and uraninite occur in a large pegmatite body at Orvault, a town about 10 km (6.5 mi) NNW of Nantes.^{2,7} Quarries at Miseri near Nantes contain granitic pegmatites in which beautiful beryl crystals have been found along with feldspar, mica, arsenopyrite, molybdenite, tourmaline, chalcopyrite and erubescite; crystals to 10 cm (4 in) long of almost cylindrical shape occur due to nearly equal development of first and second order prisms *m* and *a*. Colors are greenish, yellowish, sometimes colorless, and then very transparent and considered among the finest of French beryl specimens.⁸ In La Salle-Verte quarry at St. Clair, beryl is translucent greenish in radiate masses of narrow prisms and up to several kilograms in weight. Sometimes it is partly kaolinized and associated with tourmaline.^{2,8} Minor occurrences found around Nantes at Trémisnière, Sautron, Chêne-Vert and Saint-Herblain. Tabular crystals in quartz lenses occur in mica schist at Noeveillard, Sainte-Marie near Pronic.⁹ Lacroix mentioned beautiful green emerald, quite transparent, from mica schist, which is supposed to have come from the immediate environs of Nantes, but the locality is now lost.

Indre (Central). Common beryl occurs in pegmatite between Cuzion and Châteaubrun.²

Allier (Central). Grayish-white prisms exist to 2 cm (1 in) in albitic granulite in mica schists in massif of Échassières, ca. 30 km (19 mi) SE of Montluçon; similar crystals scattered through apatite-rich zones in albitite at S edge of "des Collettes" granite massif near Beauvoir.^{10,11} Granulite of Droiturier near La Palisse, 20 km (12.7 mi) NE of Vichy, contains large whitish-green opaque crystals in pegmatoid portions and small clear prisms of 3–4 mm wide with some molybdenite in vugs.^{2,12}

Saône-et-Loire (E Central). Pegmatites around Autun are rich in greenish-white beryl crystals that are rarely transparent, to 10 cm (4 in) long, usually associated with grayish quartz and large schorl and almandite crystals. Forms: *m*, *c*, *a* and

World Sources of Ore and Gem Beryl / France

{21 $\bar{3}$ 0}. Some crystals are flattened; others are strongly curved and the cracks healed with quartz.² A pegmatite in the park of Montjeu contains beryl with schorl and almandite.¹³ Other beryl-bearing pegmatites appear at Broye, Marmagne, and Saint-Symphorien-de-Marmagne.²

Creuse (Central). Granitic pegmatites near Crozant contain cassiterite, columbite, apatite, triplite, several Mn and Al phosphates, spessartine, lepidolite, topaz and beryl.¹⁴

Haute-Vienne (W. central). One of the earliest notices of beryl in France appeared in *Universal Magazine*, London, 1802, wherein a certain Mr. Lelievre, traveling near Limoges, found beryl among stones used in road repair. Samples sent to Vauquelin and Haüy confirmed the identity. Beryl is abundant in quarries south of Bessines around Chanteloube and in quarries along the route of Bessines-Chanteloube; the crystals are sometimes wine-yellow, transparent, lightly etched, also whitish-green and strongly etched with adherent kaolin.^{2,15} Lacroix mentioned that beryl crystals of this region may reach 100 kg (220 lb), are feebly translucent to opaque, and range from several cm to several decimeters in length. The colors are usually white, greenish-white, or yellowish. Commonly the crystals have bright faces and the following forms: *c*, *m*, and {11 $\bar{2}$ 1}, {31 $\bar{3}$ 1}, {1.0. $\bar{1}$.14}. Beryl occurs at La Vilate and in quarries at the bridge of Barost (Pécout) in crystals sometimes coated with glassy second generation beryl. Beautiful transparent gem beryl, colorless, pale yellow and golden, furnished cut gems up to several grams weight from crystals obtained at Bachelerie in Compreignac, the quarries of Saint-Sylvestre, particularly at Huréaux and Pécout at Barost.² Gem quality colorless beryl occurs in Limousin district. The Saint-Sylvestre granulite massif near Ambazac contains important quantities of beryl.¹⁶ A pegmatite at Chabannes provided a pocket of very pale blue-green transparent crystals encased in earthy sericite-bertrandite in sizes to 3.5 × 1.8 cm (1.5 × 0.70 in), with some small clear crystals cut into gems.¹⁷ In the Saint-Sylvestre area other localities are at Coudier near Larmont, and a quarry at Chedeville in La Chèze; many of these pegmatites are complex and contain lithium.

Puy-de-Dôme (Central). Small crystals exist in ravine gravels on Boulade Mountain;¹⁸ similar occurrences occur in Allier River.¹⁹ Environs of Olliegues, 40 km (25 mi) SE of Clermont-Fer-

rand, show beryl in pegmatite with quartz, microcline, muscovite and schorl; similarly at Cibertasse. At Biauchaud, NE of Saint-Pierre-la-Bourlhogne, crystals up to 30 cm (11.7 in) occur in pegmatite with large mica books.²⁰ They are partly altered to kaolin, pale green or yellowish-white and somewhat transparent.^{2,21}

Loire (SE). Crystals occur in vugs of pegmatite at Vizezy near Montbrison, with smoky quartz, microcline, apatite and chlorophyllite.²²

Haute-Loire (SE). Here are found slender hexagonal prisms of only several mm, white or greenish, with almandite, tourmaline, and green apatite in pegmatite veins in granulite about 500 m (0.32 mi) N of Chaise-Dieu village in the extreme N of the department.^{2,23}

Haute-Savoie (E central). Beautiful, strongly dichroic beryl, originally mistaken for sapphire, occurs in eluvial pegmatite blocks in the large ravines descending the pinnacle of Charmoz along edges of Mer de Glace, Mont Blanc region. Small crystals also occur in moraine blocks along the edge of Glacière Miage.² Duparc mentioned beryl in this region associated with epidote in biotite, with allanite, albite-oligoclase, and quartz.²⁴

Isère (SE). Beryl is reported doubtfully in this region at the cascade of Vajjany, Oisons, for it may be phenakite.² It is vaguely reported from Allemont.

Tarn (S central). Granulite veins in gneiss pass into pegmatites N of Brassac and contain greenish to greenish-white prisms up to 6 cm (2.2 in) in diameter with microcline, quartz, schorl, colored tourmaline, muscovite, lepidolite, columbite and garnet.^{2,25}

Haute-Garonne (S central). Large blueish or greenish prisms occur in pegmatites of Burbe valley near Bagnères-de-Luchon, Clot-de-Culgo, and Bosquet-des-Bains.²

Basse-Pyrénées (Extreme SW). Grayish prisms occur in quartz at Labourd.²

Haute-Pyrénées (Extreme S central). Fine white crystals to 4 cm (1.6 in) occur in pegmatite lenses in schists on the path to the hostelry of Pic-du-Midi. At Lac Bleu near the outlet, pale blueish-green crystals with feldspar in vugs occur in pegmatite in feldspathic schists.²

Ariège (Extreme S central). Numerous prisms exist in pegmatites in mica schists of Mount Fourcat, especially at Col d'Aigotorto; also S of Ax along Gnoles brook near Naguille pond. Two cm prisms with tourmaline and garnet have occurred

BERYL LOCALITIES

near the confluence of Ariège River and the outlet of Baxouillade pond. Clear aquamarine crystals may be found in a quartz vein near Saint-Lary by Vallongue.²

Pyrénées Orientales (Extreme SE). Large translucent greenish-white prisms occur in pegmatite in granite near Saint-Martin-de-Fenouillet.²

- Schneiderhöhn, H. 1961. *Die Erzlagerstätten der Erde*. Vol. 2: *Die Pegmatite*. Stuttgart: Gustav Fischer. 721 pp.
- Lacroix, A. 1926. *Minéralogie de la France et de ses anciens Territoires d'Outre-Mer*. 6 vols. Paris: A. Blanchard. Reprint of first issue.
- Chauris, L. 1960. Vue d'ensemble préliminaire sur la métallogénie de la Basse-Normandie. *Bulletin de la Société Linnéenne de Normandie* (Caen) ser. 10, vol. 1, p. 95-104.
- Burnol, L., and Chauris, L. 1926. Sur un phénomène de concentration du béryllium dans une granite de la Baie de Morlaix (Finistère). *Compte Rendu de la Academie des Sciences* (Paris) 255:2487-9.
- Mercier, M. Le. 1953. [Note on beryl in Finistère]. *Bulletin de la Société Française de Minéralogie et Cristallographie* (Paris) 76:xxxix.
- Tronquay, R. 1912. Contributions à l'étude des gîtes d'étain. *Bull. de la Soc. Franç. de Min. et Crist.* 35:238-468.
- Baret, C. 1878. Tourmalines bleues, vertes et roses dans un filon de pegmatite du granite d'Orvault. *Bull. de la Soc. Franç. de Min. et Crist.* 1:71-2.
- . 1887. Sur la présence du béryl et de l'érubescite dans les carrières de Miséri (pres Nantes). *Bull. de la Soc. Franç. de Min. et Crist.* 10:131-3.
- Lacroix, A., and Baret, C. 1889. Note sur quelques minéraux de la Loire-Inférieure. *Bull. de la Soc. Franç. de Min. et Crist.* 12:527-36.
- Aubert, G., and Burnol, L. 1964. Observations sur les minéralisations en béryllium du massif granulitique d'Échassières (Allier). Découverte de herdélite. *Compte Rendu de la Academie des Sciences* 258:272-3.
- Aubert, G.; Autran, A.; and Burnol, L. 1965. L'albitite quartzique à lépidolite de Beauvoir, variété d'apogranite. *Compte Rendu de la Academie des Sciences* 260:6158-61.
- Gonnard, F. 1889. Sur les minéraux accidentels des gneiss de l'île Barbe et des bords de la Saône, pres de Lyon. *Bull. de la Soc. Franç. de Min.* 12:13-26.
- Barbier, P., and Gonnard, F. 1910. Sur le béryl de Montjeu (Saône-et-Loire). *Bull. de la Soc. Franç. de Min.* 33:78-9.
- Aubert, G., and Pierrot, R. 1959. Sur un gisement de pegmatite à Li, Mn, Nb, Ta, Sn et Be dans la région de Crozant (Creuse). *Bull. de la Soc. Franç. de Min.* 82:400.
- Guimin, L. 1937. Le glucinum, élément d'avenir. *Mines, Carrières* 16:1-7.
- Charrin, V. 1958. Les minéraux exceptionnels de la région d'Ambazac, dans la Haute-Vienne. *Génie-Civil* (Paris) 135, no. 11, pp. 247-9.
- Gesbaud and Geffroy. 1960. Présentation d'échantillons béryl transparent de Chabannes en Saint-Sylvestre

(Haute-Vienne). *Bull. de la Soc. Franç. de Min. et Crist.* 83:28.

- Deveze de Chabriol, J. S., and Bouillet, J. B. 1827. *L'essai géologique et minéralogique sur les environs d'Issoire, département du Puy-de-Dôme*. . . . Clermont-Ferrand.
- Bouillet, J. B. 1854. *Topographie minéralogique du département du Puy-de-Dôme*. 2nd ed. Clermont-Ferrand.
- Barbier, P., and Gonnard, F. 1910. Sur le béryl et la muscovite des environs d'Olliergues (Puy-de-Dôme). *Bull. de la Soc. Franç. de Min.* 33:74-8.
- Gonnard, F. 1896. [Beryl occurrences in Puy-de-Dôme]. *Bull. de la Soc. Franç. de Min.* 12:614.
- . 1884. [Chlorophyllite at Mont Brison]. *Bull. de la Soc. Franç. de Min.* 7:345-6.
- . 1886. Sur deux roches à béryl et à apatite du Velay et du Lyonnais. *Compte Rendu de la Académie des Sciences* 103:1283-5.
- Duparc, L. 1922. Sur l'origine de l'épidote dans certaines roches granitiques. *Bull. de la Soc. Franç. Min.* 45:21-7.
- Arsандаux, H. 1901. Sur quelques minéraux des environs de Brassac (Tarn). *Bull. de la Soc. Franç. Min.* 24:428-32.

FRENCH GUIANA

Sodium-lithium pegmatites occur in the area between Sinnamary and Maroni rivers; some contain beryl.¹ Zoned, complex pegmatites occur in Tamanor massif, in the lower Mana River region, with aquamarine, also black and colored tourmaline, common beryl, lepidolite, muscovite, zircon, spessartine, gahnite, monazite, amblygonite, columbite-tantalite, bismuth, bismuthinite, magnetite, and limonite.

- Choubert, B., and Sandréa, A. 1961. Sur les pegmatites soda-lithiques de Guyane française. *Compte Rendu de la Académie des Sciences* (Paris) 252:3299-3301.
- Tissot, F. 1961. Étude sur des pegmatites de la Basse-Mana, Massif de Tamanor. *Proceedings, 5th Inter-Guiana Geological Conference, Georgetown, 1959*, pp. 285-90.

GERMAN DEMOCRATIC REPUBLIC

Lausitz Region. This is in the SE part, between Dresden on W and Görlitz on E. Beryl is uncommon in vugs of granitic pegmatites of Plauenschen Grund N of Dresden.¹ Pegmatites in several granite quarries directly N of Königshain, 12.5 km (8 mi) W of Görlitz, sometimes contain cavities lined with crystals of quartz, feldspar and beryl.² However, the crystals, of sky-blue color, are only 1 mm; forms are *m* and *c*.^{3,4} According to Mobus and Lindert, as many as 33 species have been identified in these vugs, a number of them rare.⁵

World Sources of Ore and Gem Beryl / Germany

Erzgebirge, Saxony. Beryl as prismatic to acicular crystals, also grayish-white and green masses, occurs in granitic pegmatite in Grube Paradies, Kahlberg near Altenberg, 35 km (22 mi) directly S of Dresden. It is noted in granite between Schellerhau and Altenberg and as pebbles in Pöbelbachtal above Seben Gottes Erbst iron mine at Schellerhau. Beryl is greenish in pegmatite at Geyer. In the famous cassiterite deposits of Ehrenfriedersdorf, a town 18 km (11 mi) S of Karl-Marx-Stadt (formerly Chemnitz) beryl is found in the mines in the Sauberg district, or about 1 km (0.6 mi) SSE of the town. Deposits are pegmatitic-pneumatolytic mineralized veins stemming from granite and intruding mica-gneiss schists. Species include topaz, quartz, molybdenite, mica, triplite, fluorite, cassiterite, arsenopyrite and galena; pneumatolytic quartz veins contain arsenopyrite, loellingite, wolframite, apatite, scheelite, beryl, mica, cassiterite, molybdenite, siderite and fluorite.⁴ Beryl occurs in elongated pale to dark blue prisms enclosed in mixtures of apatite and fluorite and also in compact masses.

At Johannegeorgenstadt beryl is found as greenish-white to pale green prisms with drusy quartz or feldspar and apatite in Grube Valerian. Drusy veins in gneiss of central Fastenberge at Treue Freundschaft yielded beryl crystals associated with tourmaline, quartz, mica and fluorite; prismatic, bluish or greenish-white, some enclosing cores of black tourmaline. Other sources are in pegmatite at Steinbach near Johannegeorgenstadt⁶; minor occurrences are in Erzgebirge near Freiberg, Klingenberg and Radenberg.

Vogtland. Beryl occurs in granitic pegmatite about midway between the towns of Irfersgrün and Hirschfeld, ca. 16 km (10 mi) SSW of Zwickau; species include large quartz crystals, feldspar, mica, elongated schorl crystals, rutile, cordierite in large crystals, and sea-green strongly corroded beryl crystals, some clear and cuttable.⁴

Thuringia. Radiate sprays or "suns" of beryl prisms occur in Henneberg granite at Weitersberga, about 15 km (9.3 mi) SSE of Rudolstadt; crystals are gray-green, sometimes pale blue.^{4,7}

1. Fischer, W. 1934. Die Mineralien im Syenit des Plauenschen Grundes bei Dresden. *Mitteilungen aus dem Museum für Mineralogie, Geologie und Vorgesichte zu Dresden* 29:126-70.

2. Woitschach, G. 1881. Das Granitgebirge von Königshain in der Oberlausitz. *Abhandlungen der Naturforschenden Gesellschaft zu Görlitz*, 1881, pp. 141-97.

3. Traube, H. 1888. *Die Minerale Schlesiens*. Breslau: J. U. Kern. 286 pp.
4. Vollstadt, H. 1972. *Einheimische Minerale*. 2nd ed. Dresden: Theodor Steinkopff. 342 pp.
5. Mobus, G., and Lindert, W. 1967. Das Granitmassiv von Königshain bei Görlitz. *Abhandlungen der Deutschen Akademie der Wissenschaften zu Berlin, Klasse für Bergbau, etc.* no. 1, 1967.
6. Frenzel, A. 1874. *Mineralogisches Lexicon für das Königreich Sachsen*. Leipzig: Engelmann. 380 pp.
7. Heide, F. 1953. Berylliumminerale vom Henneberg bei Wurzbach im Thüringen. *Chemie der Erde* 16:295-6.

GERMANY

Granitic beryl-bearing pegmatites occur mainly in the SE in the Bavarian mountains adjacent to Czechoslovakia. All beryl is of the common variety, in the Hühnerkobel, for example, as opaque to translucent prisms, with poorly developed faces, and up to 7.5 cm (3 in) in diameter.¹

Fichtelgebirge. These mountains lie immediately SW of the W extremity of Czechoslovakia and are centered about 25 km (15.5 mi) ENE of Bayreuth. Pegmatite schlieren, some with vugs, occur in large granite masses; beryl is found in the vugs but is rare. The extent, character and quarries in the granite are described in *Nutzbaren Mineralien, Gesteine und Erden Bayerns* but without mention of beryl.² In Gregnitzgrund at Nagel, 12 km (7.4 mi) SW of Marktredwitz, the druses in pegmatite are famous for superb crystals of orthoclase, albite, smoky quartz, muscovite and rare topaz, beryl, tourmaline and phenakite.³ At Rodolfstein peak, 3 km (1.9 mi) S of Weissenstadt, a beryl-bearing pegmatite is exposed in a quarry. The soapstone quarry at Göpfersgrün also exposes a pegmatite containing large greenish-yellow prisms of beryl.⁴

Oberpfälzer Wald. This granite-gneiss pegmatite region extends N-S for 90 km (56 mi) from Tirschenreuth at the N end to just E of Regensburg at the S. Some pegmatite bodies are large and have been quarried for feldspar, but vugs are rare.⁵ Localities for beryl in NE part of region are: Sägemühle at Tirschenreuth; Grün and Schwarzenbach, both SE of Tirschenreuth; Pilmersreuth 5 km (3.1 mi) SSW; Plössberg, 12 km (7.4 mi) NE of Neustadt, and the "Auf der Wacht" quarry at Püchersreuth. The Plössberg pegmatite is complex, zoned, and contains a number of rare species, especially phosphates, in addition to beryl. The latter occurs in large yellowish or greenish prisms with *m*, *a* prisms, also

BERYL LOCALITIES

a dipyrmaid and the base c .^{6,7,8,9} At Püllersreuth, 3 km (1.9 mi) SW of Windischenbach, beryl may be found in a pegmatite quarry with columbite, zircon, sphalerite, etc., and also in a well-developed graphic granite phase; the beryl crystals are greenish yellow, ca. 1 cm in size. Near Weiden, beryl occurs in pegmatite at Muglhof.

Pleystein-Hagendorf. This area is located ca. 30 km (18.6 mi) E of Weiden. It is noted for large, complex, zoned pegmatite bodies at Pleystein (actually within the town) and at Hagendorf-Süd and Hagendorf-Nord. Hagendorf-Süd is an enormous stocklike pegmatite body, the largest in Europe, while the Hagendorf-Nord body is lenslike. Originally Hagendorf-Süd was exploited by opencut but later through shafts and tunnels. Beneath the opencut it was found that the quartz core necked near the center of the body and below that point enormous masses of phosphate minerals were found. Deeper still, the core swelled again. At the 103–109 m (ca. 120 yd) level in the W section occurred quantities of translucent, white prisms of beryl, grown partly in radiate aggregates and not more than $15 \times 3\text{--}4$ cm (6×1.5 in) in size. These occurred in feldspar and were enveloped in albite; forms were m and $\{11\bar{2}1\}$.

Table 14-23
ANALYSIS OF BERYL
HAGENDORF-SÜD¹⁰

	Percent		Percent		Percent
SiO ₂	65.75	Na ₂ O	0.56	MnO	0.03
Al ₂ O ₃	19.75	K ₂ O	0.48	P ₂ O ₅	0.12
Fe ₂ O ₃	0.17	CaO	0.03	TiO ₂	0.03
BeO	12.50	MgO	0.01	H ₂ O	0.87
				Total	100.30

Spectro.: tr. Li, V, Cu, Zn, Ga, Sn.

The mineralogical complexity of this pegmatite is indicated by the presence of 11 sulfides, 6 oxides, 8 silicates and at least 33 phosphates. Specimens from this body are prized by mineral collectors for fine micro-crystals of rare species. Despite their closeness, the Hagendorf-Nord and the Pleystein bodies seem to lack beryl.^{5,10}

Bayerischer Wald. This forest lies SE of Oberpfälzer Wald, extending to Passau near the Czechoslovakian–Austrian border. Beryl is a rare

constituent of Hühnerkobel pegmatite, a body about 90 m (300 ft) long and 15–20 m (50–65 ft) wide that is well-zoned. It lies between Bodenmais and Rabenstein and was discovered in 1756. It was mined mostly for quartz and feldspar, but some beryl was recovered along with columbite, phosphates and good-quality rose quartz. The beryl occurred as “arm thick” crystals.^{1,7} Farther SE at Kerber quarry, at Matzendorf near Tittling, pegmatite veins contain beryl, also helvite, bavenite, bityite and milarite, as well as zeolites, phosphates, oxides, sulfides, and silicates.¹¹

Baden. Small crystals occur in schlieren and vugs in granite around Heidelberg, as do large white, yellow or dark reddish prisms in pegmatite. Small crystals occur in pegmatites of Karmelitwäldchen. Along the road Schiltach–Schramberg at Hinterhof beryl may be found in druses in granite, sometimes as transparent, 2 cm (0.75 in) crystals.¹²

- Schmid, H. 1955. Verbandsverhältnisse der Pegmatite des Oberpfälzer und Bayerischen Waldes. *Neues Jahrbuch für Mineralogie* (Stuttgart) Abh. 88, pp. 309–404.
- Nutzbaren Mineralien, Gesteine und Erden Bayerns (1924–1936) 2 vols. Bayerische Oberbergamt, Geologische Landesuntersuchung. Munich: R. Oldenbourg & Piloty & Loehle. 220, 512 pp.
- Laubmann, H. 1924. *Die Minerallagerstätten von Bayern und rechts der Rheins*. Munich. 111 pp.
- Strunz, H. 1960. Die Kluft- und Drusenminerale der Fichtelgebirgsgranit. *Der Aufschluss* (Heidelberg) 11:233–51.
- Forster, A.; Strunz, H.; and Tennyson, C. 1967. Die Pegmatite des Oberpfälzer Waldes, insbesondere der Pegmatit von Hagendorf-Süd. *Der Aufschluss* 16:137–98.
- Muller, H. 1852. Ueber die geognostisch-mineralogischen Verhältnisse der Gegend von Tirschenreuth in der Oberpfalz. *Korrespondenzblatt der zoologisch-mineralogischen Vereines in Regensburg* 6:33–76.
- Laubmann, H., and Steinmetz, H. 1920. Phosphatführende Pegmatite des oberpfälzer und bayerischen Waldes. *Zeitschrift für Kristallographie und Mineralogie* (Leipzig) 25:523–86.
- Lambrecht, W. 1931. Über Beryllvorkommen in der Oberpfalz. *Metall und Erz* 28:293–5.
- Lorz, O. 1953. Der Pegmatit von Wildenau-Plössberg Opf. *Der Aufschluss* 4:122–3.
- Forster, A. 1965. Vorkommen von Beryll im Pegmatit von Hagendorf-Süd. *Der Aufschluss* 16:65–9.
- Strunz, H., and Tennyson, C. 1964. Helvin von Tittling im bayerischen Wald. *Der Aufschluss* 15:119–23.
- Osann, A. 1927. *Die Mineralien Badens*. Stuttgart: E. Schweizerbart'sche Verlagsbuchhandlung. 238 pp.

World Sources of Ore and Gem Beryl / India

GHANA

Beryl in granitic pegmatites was discovered only in about 1960.¹ Pegmatites occur in the Cape Coast batholith in the Cape Coast and Saltpond districts. Enclosing rocks are mainly biotite granite with the pegmatites in the granite or in surrounding schists.^{2,3} Bodies reach 0.8 km (0.5 mi) long and up to 30 m (100 ft) wide. Species include quartz, mica, feldspar, apatite, garnet, tourmaline, spodumene, columbite-tantalite, gahnite, heterosite and kaolinite. Beryl occurs in greenish yellow to white prisms, the largest only about 15 cm (6 in) in diameter and nowhere found sufficiently abundant for economical hand-removal. Localities are near Saltpond, Oda, Kumasi, at milestone 8 on Mankesim-Dominasi road 0.8 km (0.5 mi) N of Kramkron, on the E bank of Ochi River at Ochi-Ochi, and 64 km (40 mi) W of Sunyani. Analyses of four specimens given in Hughes and Farrant.³

In about 1974, Schmetzer and Brezina received two small emerald crystals of cabochon quality that were found at Mampong in the Ashanti region.⁴ Properties are $G = 2.70$, $\rho = 1.5890$, $e = 1.5816$; absorption only for Cr^3 bands.

1. Newman, E. G. 1962. *Beryllium Resources of the British Commonwealth, 1962*. Vol. 1, London: British Commonwealth Geological Liaison Office. 22 pp.
2. Jones, R. H., and Hughes, C. J. 1963. The geology of 1/4° field sheet 28 Cape Coast NE. *Ghana Geological Survey Bulletin* 34 (Accra) 28 pp.
3. Hughes, C. J., and Farrant, J. R. 1963. The geology of the 1/4° field sheet No. 26—Cape Coast and Saltpond districts. *Ghana Geological Survey Bulletin* 34. 28 pp.
4. Schmetzer, K., and Brezina, J. 1975. Smaragde aus Ghana. *Zeitschrift der deutschen gemmologische Gesellschaft* (Idar-Oberstein) 24, no. 2, p. 94.

GREENLAND

Gothaab District. Crystals occur to 13 cm (5 in) and 5 kg weight with schorl in pegmatite at Eقالunguit. Characteristics are: faces dull, imperfectly developed, sometimes with cores of quartz and muscovite; forms m and $\{21\bar{3}0\}$; some crystals semi-transparent, greenish, brownish or blueish. At Qarajat small crystals occur to 8 mm (0.3 in) in granular quartz with biotite as greenish, rude prisms. Giesecke described an Ameralik Fjord specimen in the collection of the Royal Dublin Society Museum as "228. Emerald, of bright grass-green colour, verging towards blueish-green; from Kassigiengoit, Firth of

Ameraglik, Greenland. (Only found in rolled pieces.)"¹

Julianehaab District. "Schorlartigen Beryll" reported by Giesecke² from Niaqornarsuk is probably apatite according to Bøggild.³ Near Julianehaab, a greenish-white fragment is reported from a local hill called "Black Peak." At Sardoq, Igdlorpait, and Uvkusik, beryl occurs with fergusonite in granitic pegmatites; features are rude crystals, translucent, greenish blue, grayish blue or pale blue.

East Greenland. A crystal fragment, good faces of m , translucent, greenish, has been reported from Tunua Island. At Karra Akungnak beryl occurs in pegmatite with quartz; crystals range to 8 cm (3 in); forms are m and sometimes a ; colors are opaque or pale blue.³ Haller reports beryl in one pegmatite of a swarm in granodiorite on Cape Madelaine, NE Greenland;⁴ bodies are veinlike, mainly consisting of feldspar, quartz, and also albite, oligoclase, biotite, muscovite, epidote, spinel, ilmenite, calcite, tourmaline and fluorite.

1. Giesecke, C. L. 1832. *A Descriptive Catalogue of a New Collection of Minerals in the Museum of the Royal Dublin Society*. Dublin: R. Graisberry. 268 pp.
2. Johnstrup, F. 1878. *Gieseckes Mineralogiske Rejse i Grønland*. Copenhagen: Bianco Lunos Bogtrykkeri. 372 pp.
3. Bøggild, O. B. 1953. The Mineralogy of Greenland. *Meddelelser om Grønland*, 149 (Copenhagen) 442 pp.
4. Haller, J. 1953. Geologie und Petrographie von West-Andrée's Land und Ost-Franklandsland, NE. Grønland. *Meddelelser om Grønland*, 113. 193 pp.

INDIA

Knowledge of beryl apparently extends into prehistory. Ball believed that gem beryl was mined about 400 B.C. but presented no convincing evidence.¹ Strabo (63 B.C.—24 A.D.) mentioned beryl used in ornamentation of drinking cups, while the scepter of Sopeithes, King of Lahore, was made of gold and set with emeralds. Upon his defeat by Alexander the Great he presented this object to the latter as a token of submission. The geographer Ptolemy (2nd Century A.D.) mentioned beryl gems as occurring in southern India, but ancient Sanskrit writers refer merely to a source of emeralds which only fits the Egyptian locality, indicating that this variety was not mined in India during antiquity. Abul Fazl, court historian to Emperor Akbar (1556–1605), described the import of emeralds through Bengal seaports,

BERYL LOCALITIES

while in respect to Muzo emeralds, large quantities were acquired by the Mogul rulers during the 17th century. Mentions of an Indian source of emerald, variously given as "Cangagem" or "Canjargum" (probably a corruption of Kangayam, a town in Coimbatore, Madras), most likely refer to aquamarines of greenish color, which have been found, in modern times at least, at Padyur.² It is only since 1943 that true emeralds were found in several deposits in Rajasthan.³ One could suppose that these were known to local inhabitants since antiquity were it not for the fact that no signs of ancient excavations were found, nor is there any mention of them in legend or in recorded history.

Emerald lore is deeply ingrained in Indian cultures, and the high esteem this gem held in antiquity, and still holds, is described by Tagore in his *Máni-Mála*, a work largely devoted to ancient Indian gem lore.⁴ Brown² and Brown and Dey³ also provide historical notes on beryl in India. Emerald, for example, is mentioned in the great Sanskrit epic the *Mahabharata*, probably compiled in its present form between the first and third centuries A.D., while later Sanskrit lapidaries rank emerald fifth among the precious stones, preceded only by diamond, pearl, ruby and sapphire. The *Agastimata*, a treatise on gemstones dated before the 10th century A.D., recognized eight classes of emerald and gave careful instructions on their selection.

Aside from emerald occurrences in India, which will be dealt with in a later section, virtually all gem and common beryl is presently mined from granitic pegmatites. However, only small quantities are obtained from the pegmatites that are mined for mica, of which India has been a very important producer, and a few deposits contain either gem aquamarine or ore beryl. In regard to the latter, Crookshank gave the following production data: 1932, 255 metric tons produced; 1933, 293 metric tons, and no ore beryl until after World War II; in 1943 and 1944 an estimated 900 metric tons were mined.⁶

Kashmir

The famous sapphire area of Soomjam (Sum-sam) is also noted for fine blue gem-quality aquamarines, the locality lying in the Padar area of Zanskar-Udhampur, 33°25' N, 76°25' E.^{7,8,9,10,11} The mines are 4 km (2.5 mi) W 30° N of Soomjam, the highest village on the S side of the

range dividing Zanskar from Chanab and at an altitude of 4,440–4,850 m (14,800–14,950 ft). They were discovered in 1881 or 1882, and the then unrecognized sapphires were sent to F. R. Mallet of the Geological Survey of India for identification. The geology-mineralogy was described by Middlemiss.⁹ Gem beryls were found not only in the pegmatite bodies but also as loose crystals in detritus below the outcrops (see fig. 14–27). Common beryl and aquamarine also occur in a pegmatite vein 2.4 km (1.5 mi) N of Kaban village, 33°17' N, 76°16' E on a small tributary of Chandar Bhaya River; also 2.4 km (1.5 mi) NNE of Kaban, 3.2 km (2 mi) NNW of Hamur, 33°24'8" N, 76°19'13" E, and 2.4 km (1.5 mi) SW of Chishote, 33°22' N, 76°16' E.

Haryana

Pale green prisms to 20 cm (8 in) diameter and 20–70 cm (12–24 in) long in kaolinized pegmatites occur on the road between Mehrauli and Najafargh, about 2 km (1.2 mi) NNW of Masadpur; also in quartz as slender prisms. One of these bodies produced about 450 kg (1,000 lb) of ore beryl, another about 14 metric tons (15 tons). At Narnaul, 120 km (75 mi) SW of New Delhi, altered yellowish green crystals to 2.5 cm (1 in) occur in cavities in impure calcite associated with tremolite.¹²

Hamachal Pradesh

Pale blue, much flawed prisms up to 8.5 cm (3.25 in) appear in pegmatites cutting gneiss at Wangtu and for some distance up the Sutlej and Wangur river valleys in Bashar district. They also occur in the valley of Chandra River above Haimantha Pass in Kangra district.^{7,11} Considerable beryl occurs with kyanite at Niti in Garwhal district, S of Shapki in Bashar district, and at many points in the central Himalayas between Bhagirati River, Tehri Garwhal district, and the Sutlej River, Bashar district; also between Kamet, Garwhal district and Spiti, Kangra district. Behind Manikera in Kulu, clear green stones were found atop the range. Opposite Thakur Kua near Dompal on the banks of the E tributary to the Rutta Rani, emeralds have been found.¹¹

Rajasthan

The following notes are from Crookshank:⁶ Granitic pegmatites and decay products, the latter in gravels of the Ganges River, occur in a broad

World Sources of Ore and Gem Beryl / India

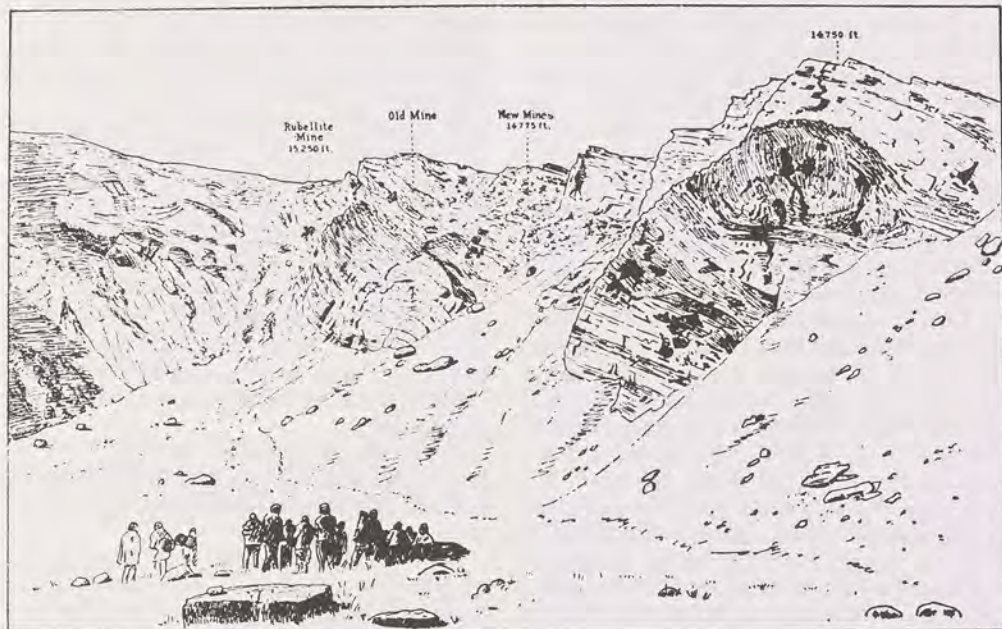

Fig. 14-27 View of the famous sapphire locality of Sumjam, Padar, in Kashmir, India. From C. S. Middlemiss, *Jammu and Kashmir Mineral Survey Reports*, no. 9 (Jammu, 1931).

belt 240 km (150 mi) wide running SW from around Delhi-Agra SW to the borders of Gujarat State, or a distance of about 480 km (300 mi). This vast region encloses nearly all of the E half of Rajasthan and includes a very large number of simply mineralized pegmatites that have been mined for many decades for mica. Common beryl, and sometimes gemmy material, occurs in some of the bodies but seldom in quantity to make it profitable to mine for that mineral alone. Most bodies are intruded into schists but also granites, quartzites and crystalline limestones. In the Ajmer area they are related to the Erinpura granite of post-Delhi age. Large bodies are exceptional. Beryl and columbite most commonly occur in those pegmatites near the borders of granite masses. Efforts to work some bodies for gem beryl took place in the hills NW of Dhai Dinka Jhonpra, Ajmer, and in the east pit of Bisundni but were abandoned as unprofitable.

The crystals are usually well developed, with forms *m* and *a*, the latter sometimes nearly as large and thus imparting a rudely cylindrical cross-section. Fluting is common. Terminal faces are rare and many crystals are tapered, broken,

or bent and rehealed with quartz. Cored crystals are found in a number of bodies and fillings may consist of quartz, feldspar, tourmaline, and mica, alone in or in combination (see fig. 9-27); such cores may reach as much as 19 cm (7.5 in) in diameter inside the beryl crystals, and sometimes only a thin shell of beryl encloses such cores. Crookshank specifically noted a cylindrical crystal from Lohagal which contained a quartz core and was further surrounded by a cylinder of quartz and tourmaline.⁶ Beryl was also noted inside tourmaline crystals. Still another curious crystallization was noted at Kishengarh, where beryl crystals were formed of interlamination of beryl-albite parallel to prism faces.

Colors are very variable. Tints of blue and green are most common; milk-white occurs at Kharwa and Mkrera; orange and amber are rare but have been found at Lohagal; a black Mn-beryl was found in Mewar and at first was mistaken for schorl; pink beryl occurs in Kishengarh, Lohagal and Bisundni; water-clear crystals at Lohagal and Bisundni sometimes contained flawless areas suitable for gems. Brown and reddish hues were also noted by Brown and Dey.⁵ Crookshank deter-

BERYL LOCALITIES

mined specific gravities and found highest values for blue and green beryls and lowest for those of reddish, whitish or brownish hues, the range being 2.716 for a blue beryl to 2.689 for a red-brown specimen.⁶ Chaudhari studied a color-zoned crystal from the Shikarwadi pegmatite, Rajasthan, and found a decided difference in composition and properties between the outer yellowish green material and the yellowish core.¹³

In the Alwar city region, 128 km (80 mi) SSW of New Delhi, small amounts of beryl occur in the Tonk mica mines. About 9 metric tons of ore beryl were produced from Tartarpur, from Ninjar, 27°26' N, 76°31' E. In the Kishengarh city region there are many minor occurrences but only two major deposits at Dadia and Katsura centered about 26°27' N, 74°59' E. Pink and red varieties were reported here.⁵ The Ajmer city region is a very large field in a broad belt extending from several km N of Ajmer along a NW-SE axis to about 135 km (85 mi) SE of Ajmer. Beryl pegmatites are at Boraj, Foyasagar Lake, Makrera and Quazipura.^{3,6} Near Lohagal, 26°31' N, 74°42' E, beryl pegmatite was opened by the Indian government but with poor results. Pinkish beryl occurs at Makawarli Tank; blueish green, seldom well formed, occurs in Neem Tree area. Beryl is found in detritus W of Lohagal village and in the Gishala group of pegmatites N of the village.¹⁴

In 1943 mines in the Neem Tree area produced 950 kg (2,375 lb) of ore beryl in small crystals or in columnar and acicular aggregates; some hexagonal specimens proved to be quartz pseudomorphs after beryl; hollow beryl crystals were found filled with quartz and feldspar, also quartz, feldspar, tourmaline, and rarely apatite. Beryl was also found at Taragarh Hill near Ajmer. At Tihari, 32 km (20 mi) N of Bhilwara city, several bodies produced crystals to 150 × 30 cm (60 × 12 in); small crystals were found near Danta, 26°22' N, 74°44' E. Large prisms occurred in a quarry E of Kesarpura.³ Beryl has been found in mica mines both in Dhauli village 19 km (12 mi) NE of Malpura city, and S of Pawalia village, near Pathraj Buzurg and Lachminpura. Beryl also occurs at Shokla and Toda Rai Singh. Large quantities of ore beryl have been mined at Borara, 26°12' N, 75°3' E, and Mindoti nearby.³ Aquamarine was found at Sagar near Sarwar, 26°4' N, 75°4' E.⁸ Ore beryl comes from Para.³ Beryl occurs at Sankerwara, Barchola, and comes from two groups of mines near Thola and Berla. Near

Kakpria, Gaunri and Kushalpura it also occurs³ and small rolled pieces of green beryl have been found in Banos River and on Sora Hills near Rajmahal.⁸

At Bisundni, 25°44' N, 75°12' E, near the town of Deoli or about 112 km (70 mi) SE of Ajmer, pegmatite bodies more than 300 m (1,000 ft) long and 22-30 m (75-100 ft) wide contain quartz, pink and green microcline, mica, albite and beryl, some beryl prisms reaching 6 × 1.2 m (20 × 4 ft). A single crystal yielded 16 metric tons (20 t) of ore beryl.⁶ A little pale green aquamarine was also obtained.¹¹ Beryl came from detritus of a large decomposed body forming a hill at Jamoli. Large crystals stem from Deora area, others occur at Rajmahal.

In the Beawar city region, 26°6' N, 74°21' E, beryl comes from Kharwa, Giri, Bar, Ghazipura, Lotiana, Bhambipura, Harialighatti, Modia Guar, Bichudara, Todgarh, etc.³

Bhilwara city region, 25°21' N, 74°20' E, features beryl around the city. At Sikarbarh a pegmatite was mined exclusively for ore beryl to a depth of 24 m (80 ft). There are important beryl-pegmatites near Meja, also Kangni, Bagor, Gangapur, Khemana, and Makria. Crookshank mentions 96 beryl occurrences in the Bhilwara-Beawar region between 25°8'-59' N and 73°49'-74°32' E, with the Sangua and Tiloli deposits considered most promising.⁶ Elsewhere (p. 152) he mentions a pegmatite at Tiloli that produced enormous beryl crystals exceeding in size those recorded at Bisundni and described above.⁶

Madhya Pradesh

Beryl was first reported from here by Kilpady and Dave from Tirodi, Balaghat district, as pale blue, green or yellow crystals, prominent basal parting, slender to short prismatic, to 100 × 38 mm (4 × 1.5 in); $G=2.696$, $\rho=$ less than 1.58, $e=1.57-1.58$; BeO content 13%; often altered into soft white kaolin.¹⁵

Bihar

Many pegmatites with large muscovite crystals occur in a 19 km (12 mi) wide "mica belt" extending about 112 km (70 mi) through Gaya, Hazaribagh, and Monghyr districts. They intrude Archean schists and gneisses and are generally lenticular in shape; some are zoned. Species include albite, amazonite, orthoclase, quartz, muscovite, apatite, beryl, biotite, lepidolite, magne-

World Sources of Ore and Gem Beryl / India

tite, tourmaline, pitchblende, garnet, columbite, epidote, fluorite, cassiterite, kyanite, leucopyrite and emerald(?).¹⁶ Latouche⁸ mentioned small yellow crystals of beryl found abundantly in a pegmatite crossing the Tendwaha stream S of Mahabar Hill, 24°43' N, 85°50' E. Faceting beryl was reported from a mica mine near Muhaisri.¹¹ Beryl is also common in the mica pegmatites of Kodarma area near Hazaribagh city as crystals bordering pegmatite cores.¹⁷ A single crystal of more than a ton was taken from the Charkhi mine.¹⁸ Tapered crystals occur in a pegmatite near Rola village about 6 km (3.75 mi) E of Harzaribagh.¹⁹

Orissa

Some gem beryl occurs in pegmatite veins near Angul and Ramidi on the border of Talchir coal field, Cuttack district; Angul city is 88 km (55 mi) NW of Cuttack.¹¹

Andhra Pradesh

Many pegmatite bodies are mined for mica in Nellore district, centered on the city of Nellore, 152 km (95 mi) N of Madras. The mica belt extends inland to about 79°35' E and lies between 14° and 15° N, and is over 96 km (60 mi) long and about 24–32 km (15–20 mi) wide. Most mines are around the towns of Kavali, Atmakur, Rapur and Gudur. Included are simple and complex pegmatites, the latter branched or vein-like, and intruding gneisses and schists. Dimensions from 30–90 m (100–300 ft) long and 15–60 m (50–200 ft) wide. Species include quartz, feldspars, micas, also garnet, tourmaline, apatite, beryl, and less commonly, ilmenite, magnetite, samarskite, and rarely columbite-tantalite, sipylite, rubellite, automolite, allanite and cyrtolite.²⁰

Important deposits occur at Gudur, 14°8.5' N, 79°51' E, where beryl crystals to about 1 m (3 ft) have been found, and in the Srinivasa mine, just E of Kurumbapatti. In mica mines near Saidapuram, especially in Vasantakalyani, L.N. and Killy mines, there is some gem beryl.²¹ "Beautiful" aquamarine stems from mica mines about 1 km (0.6 mi) W of Saidapuram.⁵ Beryl is common in Sudarsano mine. Green and blue gem beryl comes from Kalichedu, Killy, L.N., Pallimetta and Tellabodu mines; yellow from Rappala Dibha mine near Tatiparti.¹¹ Swaminathan provided analyses of specimens from Lakshminarayana and Kubera mines:²²

Table 14-24
SWAMINATHAN'S CHEMICAL ANALYSIS OF
INDIAN BERYLS²²
Lakshminarayana

	Percent		Percent		Percent
SiO ₂	67.28	BeO	13.51	Li ₂ O	trace
Al ₂ O ₃	16.10	CaO	0.48	H ₂ O	1.60
Fe ₂ O ₃	0.43	Na ₂ O	0.64	Total	100.64
Kubera					
SiO ₂	64.78	BeO	13.53	Li ₂ O	trace
Al ₂ O ₃	16.56	CaO	0.52	H ₂ O	2.10
Fe ₂ O ₃	1.99	Na ₂ O	0.56	Total	100.04

Mysore

In pegmatites near Tattapur, Marodi, Gadgal, and Daregundi in Shimoga city district.¹¹ The Ooregum mine in Kolar gold field contains beryl.²³ At Yediyoor in Bangalore city district, a pegmatite contains short opaque yellow prisms analyzed as follows by Ramaswamy:²⁴

Table 14-25
RAMASWAMY'S CHEMICAL ANALYSIS OF
YEDIYOOR BERYL²⁴

	Percent		Percent
SiO ₂	70.18	Fe ₂ O ₃	0.30
Al ₂ O ₃	18.70	Ignition loss	2.20
BeO	8.50	Total	99.88
Alkalies not detected; G = 2.676-2.707; ρ = 1.583, e = 1.578			

Many granitic pegmatites occur in the area around Krishna Sagara, Kannambadi, Mysore city district with crystals of colorless, yellowish, greenish and blueish beryl, sometimes darkly tinted, and found only in muscovite-rich zones. Some crystals develop a trigonal cross-section due to suppression of alternate prism faces, while others are nearly circular in cross-section due to equal development of first and second order prisms. "Knee-shaped twins" were found and described by Radhakrishna²⁵; he also correlated a rise in specific gravity with intensification of color:

BERYL LOCALITIES

colorless	G = 2.63
yellowish	2.68
green	2.70
dark blue	2.73

Table 14-26
RADHAKRISHNA'S CHEMICAL ANALYSIS OF
DARK BLUE BERYL²⁵

	Percent		Percent
SiO ₂	65.12	MgO	trace
Al ₂ O ₃	19.63	CaO	0.44
BeO	13.96	Ignition loss	2.03
Fe ₂ O ₃	0.57	Total	101.75

Gem beryls were found in pegmatites at Tank Bund at Melkote, 12°40' N, 76°42.5' E; S of Chathanhalli, 6.4 km (4 mi) S of Melkote in the Mandya district, and at Chikayarhalli and Katteri near Mysore.^{8,11}

Tamil Nadu

Beryl is found in pegmatites at Vaniyambadi city, 185 km (115 mi) WSW of Madras at N base of Nilgiri Hill. In Salem city district, 280 km (125 mi) SW of Madras, small pale blue crystals appear in the Alachchiamoalaiyam (Alasiramani) mica mine, 3.2 km (2 mi) WSW of Idappadi; also in the Srinivasi mica mine, 0.8 km (0.5 mi) E of Kurumbapatti and SE of Vairamangalam.¹¹ In mica mines about 0.8 km (0.5 mi) N of Karaiyanur beryl may also be found.²¹

The most important occurrences of gem beryl are in Coimbatore district, 425 km (265 mi) SW of Madras and were first exploited in the early part of the 19th century. Productive pegmatites were mined near Pattalai (or Padiyur), 11°3.5' N, 77°30' E; during 1819–20 they yielded 2,196 stones weighing 10 kg (22 lb) valued at £1,210. For Indian pegmatites, it was unusual that the crystals occurred in vugs associated with "interlacing crystals of cleavelandite" and were sea-green to blue in color. Some experts classed them better in quality than comparable Siberian aquamarines.^{8,10,11,21} An account of the mines was given by De La Tour in 1822.⁵

Common beryl occurs in the same district, just SE of Vairamangalam.²¹ Emeralds, blue aquamarines and amethyst were reported found during

well-sinkings near Palaiyakottai, Mullipuram and Pappani; some stones fetched high prices but the pegmatites in which they occurred are irregular and unprofitable to work.¹¹ Beryl occurs in pegmatite on NE spur of Mungilmalai Hill near Tiruchchirappalli (Trichinopoly).²¹

Kerala

Paulose described a complex zoned pegmatite at Odara, 9°22' N, 76°38' E, in Thiruvalla district of central Travancore, cutting gneiss and containing a core of quartz with beryl, as well as an intermediate zone with beryl.²⁶ Some of it is beautiful blue aquamarine, otherwise it is blue white, yellowish or greenish common beryl. Core crystals reached 60 × 10 cm (24 × 4 in). The aquamarine and yellow beryl are marred by cracks but contain areas large enough for faceted gems.

Table 14-27
PAULOSE'S CHEMICAL ANALYSES OF
ODARA BERYLS²⁶
Sea Blue, Core Unit

	Percent		Percent		Percent
SiO ₂	65.17	BeO	12.53	P ₂ O ₅	0.04
Al ₂ O ₃	18.46	CaO	0.07	H ₂ O+	1.55
Fe ₂ O ₃	1.73	Na ₂ O	0.23	H ₂ O-	0.02
FeO	0.41	K ₂ O	—	Total	100.21
G = 2.713; o = 1.591, e = 1.584					

Yellow, Intermediate Zone

	Percent		Percent		Percent
SiO ₂	65.59	BeO	11.94	P ₂ O ₅	0.05
Al ₂ O ₃	18.73	CaO	0.05	H ₂ O+	1.34
Fe ₂ O ₃	0.61	Na ₂ O	0.07	H ₂ O-	0.04
FeO	1.53	K ₂ O	0.03	Total	99.98
G = 2.722; o = 1.577, e = 1.572					

Emerald in India

The modern history of emerald in India began with the discovery in 1943 of green crystals near Kaliguman, a small village between Amet and the old fortress of Kumalgarh in south Rajasthan. The crystals were identified as emerald by H. Crookshank of the Geological Survey of India.²⁷ A mining lease on about 5 square miles of land near

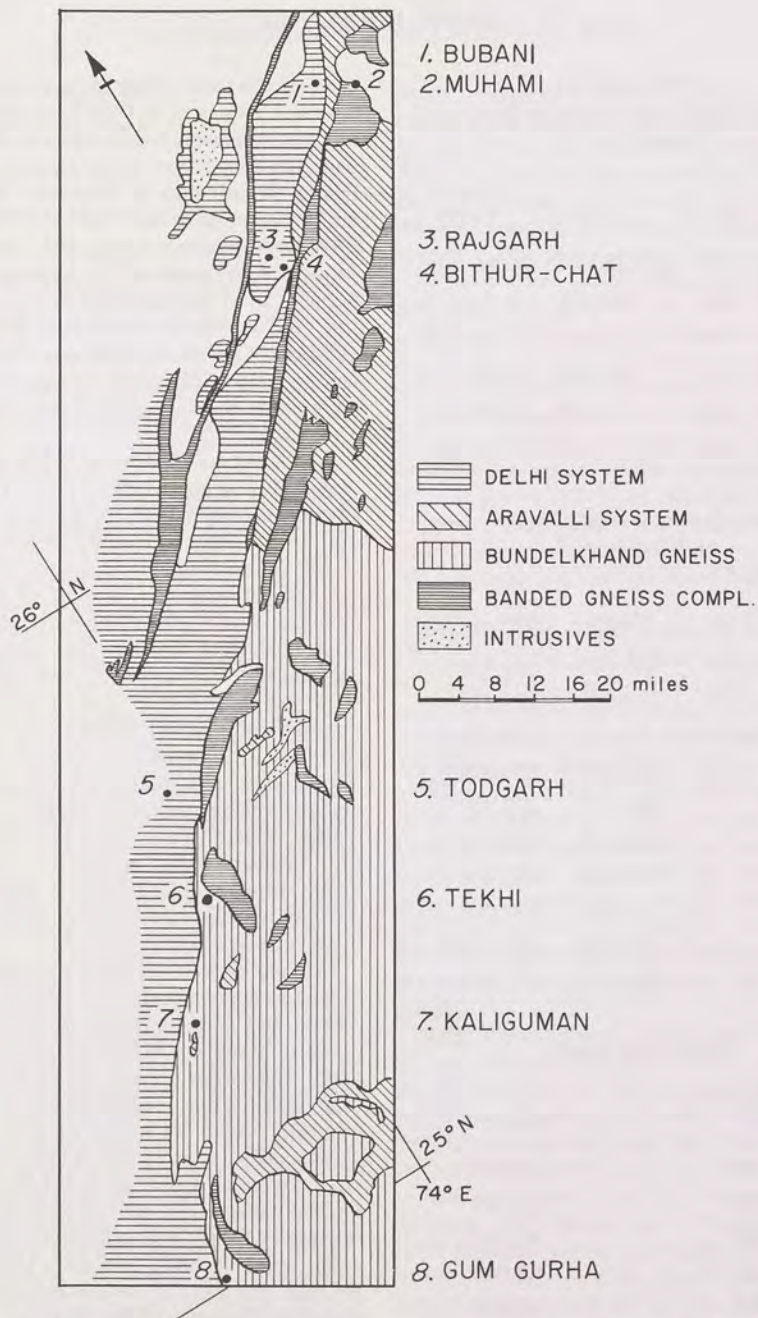

Fig. 14-28 Emerald mines in the Ajmer-Merwara field of India. The Pre-Cambrian Delhi System rocks consist of calc-silicate rocks, limestones, quartzites, schists and calc-gneisses while the Aravalli rocks are schists and gneisses. Simplified from a map of B. C. Roy, *Records of the Geological Survey of India* 86, part 2 (1955).

BERYL LOCALITIES

Table 14-28
EMERALD PRODUCTION IN INDIA
From Roy^{3,29}

Production Years	Pounds	Carats	Value in Rupees
1944-1945	169	ca. 38,400	none sold
1945-1946	922	209,000	2,65,176
1946-1947	946	212,000	1,82,276
1947-1948	490	109,000	none sold
1948-1949	198	45,000	2,53,127
1949-1950	123	25,400	74,684

From Iyer and Thiagarajan¹¹
and Krishnan³⁰

Production Year	Tolas	Carats	Value in Rupees
1948	37,376	440,000	251,834
1949	11,727	137,000	195,918
1950	6,575.6	79,000	134,926
1951		252,995	256,948
1952		461,872	277,740
1953		550,938	230,374
1954		509,180	670,406
1955		191,723	637,000 (est.)
1956		474,364	240,000 (est.)
1957		338,000	25,000 (est.)

From Viswanath³¹

Production Year	Carats
1964	ca. 53,000
1965	65,000
1966	54,000
1967	38,000
1968	23,000

Kaliguman was granted to Sir Bhagchand Soni and mining began in 1944. Shortly thereafter, probably in 1945, the Bubani and Rajgarh deposits were located at points about 32 km (20 mi)

apart on the same strike of rocks but farther NE toward Ajmer city. In 1945 the Tekhi deposits N of Kaliguman were found, again in the same rock belt, the concession being awarded to Messrs. Pusalal Mansinghka of Bhilwara. New finds in the belt occurred at Gum Gurha, 36.8 km (23 mi) SSW of Kaliguman during 1950-1951, and the deposits were leased to U. Asbestos & Mineral Supply Co. of Bombay, also to Mewar Minerals, Ltd. and to Messrs. Moolchan Suganchan. In 1955 the Kaliguman mine was converted from underground workings to an open-cut. By 1955 other mines were known at Kabra, Bagmara, and Malpura.^{3,5,7,27,28,29}

All known occurrences lie within a narrow and remarkably straight belt of rocks in which the emerald-bearing schists are included as shown in Fig. 14-28. They strike NE-SW over a distance of 200 km (125 mi).²⁹ The country rocks are Delhi and Pre-Aravaliis, a suite of Precambrian phyllites, biotite and other mica schists, sometimes containing feldspar, talc schists, vermiculite schists, etc., associated with altered peridotites and intruded by quartz veins, granitic pegmatites, and tourmaline-bearing granitic rocks. It is believed that the emerald deposits formed under pneumatolytic conditions, the mineral parageneses including emerald, beryl, tourmaline, apatite, quartz, feldspar, mica and biotite. Typical species in adjacent rocks include kaolin, sericite, chlorite, albite, tourmaline, vermiculite, calcite, talc, serpentine, tremolite, anthophyllite and others.²⁹

Emerald crystals are simple hexagonal prisms as well as angular grains and broken crystal fragments, and sometimes occur in aggregates of crystals. Many are brittle and easily crumbled. Sizes range from several mm to about 12.5 cm (5 in) long but those over 2.5 cm (1 in) are scarce. Typically, there are numerous flaws and inclusions such as layers of talc or biotite.^{5,27} The best emeralds came from the Rajgarh deposits and fetched better prices than those from Kaliguman because of being larger on the average, better in color, softer in luster and more transparent.⁵ In the best, the color is velvety emerald green and compares favorably to that of Muzo emerald.³²

Dichroism: *e* - blue-green, *o* - light yellow-green to blue-green to yellow-green. Spectroscopic absorptions: *o* - 6830, 6828, 6758, 6640, 6460 Å; *e* - 6758, 6388, 6370, 6300-5800, 4775 Å.³² None of the stones turned red under color

World Sources of Ore and Gem Beryl / India

Table 14-29
PROPERTIES OF RAJASTHAN EMERALDS

<i>o</i> (Na)	<i>e</i> (Na)	diff.	<i>G</i>	Reference
1.5875	1.580	0.0075	2.746	Gübelin ³²
1.5875	1.580	0.0075	2.739	Gübelin ³²
1.591	1.582	0.009	2.781	Gübelin ³²
1.5927	1.5853	0.00745	2.73–2.74	Webster ³³
1.598	1.589	0.009	2.740	Gübelin ³²

filters. Under UV (2500, 3650 Å) all remained inert. Under x-rays two paler stones glowed a faint dull red.

Mining was accomplished mainly by open-cut and benching using hand tools to loosen the rock. Roy reported that the emerald ore was taken to sheds and there crushed to extract the crystals.²⁹ Brown and Dey stated that the stones were then placed in locked boxes and later emptied into bags that were sealed under strict supervision.¹¹ Further processing involved removal of rock remnants and cleaning of crystals by boiling in both alkaline and acid solutions and finally coating with thin oil. The stones were graded into six categories and divided into lots for sale at public auction in Jaipur. The proceedings were closely supervised throughout by agents of the government and the mine owners. In January 1951, the best stones commanded a price of Rs 18 per carat. Cut gems sold locally for as much as Rs 2,000 per carat. Much of the rough was bought and cut by local lapidaries in Jaipur.

Bubani Mines. These are on small low hills between Bubani and Muhami villages, 26°31' N, 74°48' E. A number of small workings occur around Gudas. The southernmost mine is the most important, the open-cut at the time measuring 107 m (250 ft) × 15 m (50 ft) and in places sunk to 12 m (40 ft) in depth; some underground workings were driven also. The strike of the emerald-bearing formation is NE–SW to NNE–SSW, dipping steeply to nearly vertical toward the W. Emerald is associated with some beryl and apatite and is sporadically distributed in biotite and talc schists. The northernmost cut is 28 m (125 ft) × 12–15 m (40–50 ft) and sunk to 6–12 m (20–40 ft) by 1958.³

Rajgarh Mines. These are located about 1.6 km (1 mi) SE of Rajgarh village, 26°17.5' N, 74°38' E. The main open-cut is on a low ridge of

highly folded and contorted biotite schists intruded by a beryl-bearing pegmatite which formed the top of the ridge. Another pegmatite here contains inclusions of emerald-bearing biotite schist. The main quarry is 61 m (200 ft) × 15–25 m (50–80 ft) and 25 m (80 ft) deep. Another important quarry lies a little S and is about 45 m (150 ft) × 25 m (80 ft) across and 25 m (80 ft) deep. Emeralds occur in a 6 m (20 ft) thick biotite schist zone adjacent to pegmatites. Mining began here in 1947 and the total value of emeralds sold until November 1951 was nearly Rs 250,000.^{3,11}

Chat Mines. These are near Chat village, 26°18' N, 74°28'45" E, or about 1.2 km (0.7 mi) from the Rajgarh group. The open-cut is 23 m (75 ft) × 4.5–9 m (15–30 ft) and 9 m (30 ft) deep. Country rock is muscovite-biotite, biotite, and hornblende schists intruded by pegmatite. Inferior beryl and emerald were produced from the biotite schists.

Bithur Mines. These mines are located about 1.2 km (0.75 mi) N of Bithur village, 26°16'45" N, 74°27.5' E. Exploration failed to produce commercial quantities of emerald.

Tekhi Mines. Near the city of Deogarh, about 1.6 km (1 mi) SE of Tekhi village, 25°31' N, 73°57' E are the Tekhi mines. They were worked in 1959 by Pusalal Mansinghka of Bhillwara. Open-cuts were emplaced next to a low ridge composed of biotite schists with talc and actinolite schists; the complex is invaded by siliceous veins. The main cut is 610 m (2,000 ft) × 6–9 m (20–30 ft). Good quality stones were found in talc schists but only a translucent type in the actinolite schists.

Kaliguman Mines. Located near Kaliguman village, about 25°20' N, 73°50' E, or about 89 km (55 mi) NNE of Udaipur city. They are the oldest mines, having been worked since 1944, at first by underground methods, then later converted to open-cut. In 1959, the main pit was 137 m (450 ft) × 4.5–22 m (15–70 ft) and 14 m (45 ft) deep. The country rock is hornblende schist with emerald crystals irregularly distributed within veinlike bodies of soft talcose biotite schists ranging from 0.5–1.5 m (1.5–5 ft) thick and emplaced between hornblende schist and an altered peridotitic rock. Nearby are numerous granite pegmatite intrusions.¹¹ Roy described the N end exposure as consisting of altered peridotite, with partly talcose actinolite-tremolite schists, actinolite-tremolite-biotite schists, biotite schists

BERYL LOCALITIES

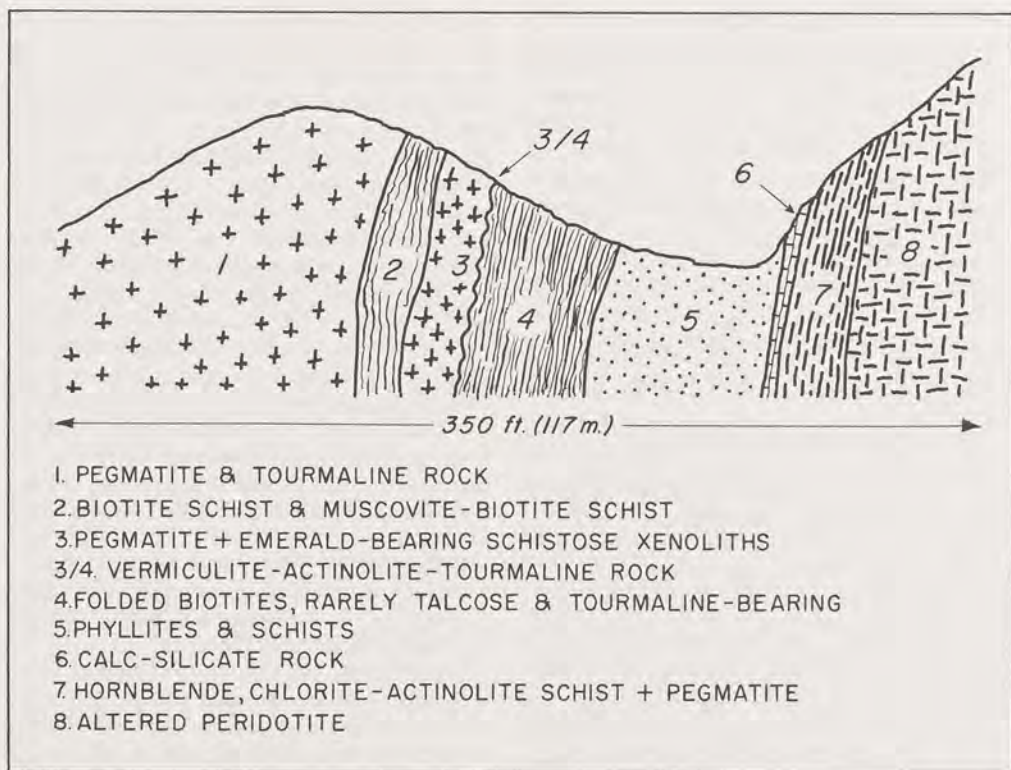

Fig. 14-29 Cross-section at Rajgarh mines showing the rock series in which the emeralds occur. After B. C. Roy, *Records of the Geological Survey of India* 86, part 2 (1955).

with hornblende schist intercalations, hornblende schists, also granitic pegmatites and quartz veins, among others.³ The emerald crystals occur sporadically in a 1.5 m (5 ft) zone of biotite schist and actinolite schist. Up to the end of 1951 production stood at 2,567 lb or about 1,165 kg of mine-run material, while sales of stones up to November 1951 totaled Rs 7,78, 261.¹¹ Other mines in this district are the Kabra, a small open-cut, the Bagmara mine, an open-cut of 31 m (100 ft) square and 9 m (30 ft) deep, and the Malpaira mine, an open-cut in which crystals occur in actinolite schists.³

Gum Gurha Mines. These are the southernmost workings in the emerald belt and are found at 25° N, 73°39' E. About six pits are on the flanks of a hill composed of altered peridotite, pegmatites, and actinolite, talc and biotite schists. A good quality emerald was produced from the talcose biotite schists.

1. Ball, S. H. 1931. Historical notes on gem mining. *Economic Geology*, (Lancaster, Pa) 26:681-738.
2. Brown, J. C. 1953. Emeralds in India. *The Gemmologist* 22:133-6, 165-8.
3. Roy, B. C. 1959. *The economic geology and mineral resources of Rajasthan and Ajmer*. Memoirs of the Geological Survey of India, Vol. 86. Calcutta. 356 pp.
4. Tagore, S. M. 1879. *Māni-Mālā, or a Treatise on Gems*. 2 vols. Calcutta: Stanhope Press.
5. Brown, J. C., and Dey, A. K. 1955. *India's Mineral Wealth*. 3rd ed. Oxford: Oxford University Press. 761 pp.
6. Crookshank, H. 1948. Minerals of the Rajputana pegmatites. *Transactions, Mining, Geological and Metallurgical Institute of India* (Calcutta) 42:105-89.
7. La Touche, T. H. D., 1890. The sapphire mines of Kashmir. *Records of the Geological Survey of India*. Vol. 23, pt. 2.
8. ———. 1918. *A Bibliography of Indian Geology and Physical Geography with an Annotated Index of Minerals of Economic Value*. Part II: *An Annotated Index of Minerals of Economic Value*. London: K. Paul, Trench, Trübner & Co. 490 pp.
9. Middlemiss, C. S. 1931. Precious and semi-precious

World Sources of Ore and Gem Beryl / Inner Mongolia

- gemstones of Jammu and Kashmir. *Jammu and Kashmir and Mineral Survey Reports*, no. 9. (Jammu) 58 pp.
10. Iyer, L. A. N. 1948. *A Handbook of Precious Stones*. Calcutta: Baptist Mission Press. 188 pp.
 11. Iyer, L. A. N., and Thiagarajan, R. 1961. Indian precious stones. *Geological Survey of India Bulletin* 18. 105 pp.
 12. Chhibber, H. L. 1945. An unusual occurrence of beryl near Narnaul, Patiala State. *Journal of Scientific and Industrial Research* 3:423.
 13. Chaudhari, M. W. 1971. A study of a zoned beryl from Rajasthan. *Norsk Geologisk Tidsskrift* (Kristiana) 51:187-90.
 14. Mathur, S. M., et al. 1955. The beryl quarries of Lohagal, Ajmer-Merwara. *Records of the Geological Survey of India* 84:405-14.
 15. Kilpady, S., and Dave, A. S. 1954-1955. On the occurrence of beryl in Madhya Pradesh. *Journal of the University Geological Society, Nagpur*. 1:11-2.
 16. Roy, S. K. 1932. Report on mica and the mica industry of Bihar and Orissa. *India, Department of Industries, Bihar and Orissa, Bulletin* 4. 41 pp.
 17. Rao, B. R. 1930. Kodarma excursion. *Transactions, Mining, Geological and Metallurgical Institute of India* 24:321-8.
 18. Roy, S. K.; Sharma, N. L.; and Chattopadhyay. 1939. The mica pegmatites of Kodarma, India. *The Geological Magazine* 51:145-64.
 19. Rao, K. B. 1972. Beryl and cleavelandite from Bihar, India. *The Mineralogical Magazine* 38:896-7.
 20. Roy, B. C. 1956 The Nellore mica belt. *Geological Survey of India Bulletin*, Ser. A, no. 11.
 21. Krishnan, M. S. 1951. *Mineral resources of Madras*. Memoirs of the Geological Society of India, vol. 80 (Calcutta), 299 pp.
 22. Swaminathan, V. S. 1928. Mode of occurrence and chemical composition of beryl from Nellore. . . . *Transactions, Mining, Geological and Metallurgical Institute of India* 22:258-67.
 23. Rao, B. R., and Rao, M. B. R. 1939. Spodumene and its associated minerals from the Ooregum mine, Kolar gold field. *Records of the Mysore Geological Department* (Bangalore) 37:38-42.
 24. Ramaswamy, C. 1945. On the occurrence of beryl at Yedyoor, Bangalore. *Records of the Mysore Geol. Dept.* 42:81-6.
 25. Radhakrishna, B. P. 1946. The occurrence of beryl, feldspar, and other minerals in the Krishnaraja Sagara (Kannambadi) area. *Records of the Mysore Geol. Dept.* 43:97-108.
 26. Paulose, C. V. 1957. The Odara pegmatite. *Economic Geology* 52:702-8.
 27. Crookshank, H. 1947. Emeralds in Mewar. *Geological Survey of India, Indian Minerals*, Vol. 1: pp. 28-30.
 28. Geological Survey of India. 1951. Investigations for emeralds in Udaipur. *Indian Minerals*. V. 5 (Calcutta) pp. 148-50.
 29. Roy, B. C. 1955. Emerald deposits in Mewar and Ajmer Merwara. *Records of the Geological Survey of India* 86:377-401.
 30. Krishnan, M. S. 1955. The mineral production of the Indian Union during 1952. *Records of the Geological Survey of India* 86:309-76.
 31. Viswanath, N. 1970. Diamond news from India. *Journal of Gemmology* 12:41-3.
 32. Gübelin, E. J. 1951. Some additional data on Indian emeralds. *Gems & Gemology* 7:13-22.
 33. Webster, R. 1950. Some notes on Indian emeralds. *Gems & Gemology* 6:344-5.

INNER MONGOLIA

Beautiful clear beryl crystals, sometimes doubly terminated, occur in clay-filledmiarolitic cavities in biotite granite on Tachingshan mountain, Hsinho district, 41°14' N, 113°47' E, Suiyuan Province.¹ They are 2-4 cm (0.75-1.6 in) long, pale blueish green, and display forms {10T0}, {1120}, {2130} and {5160}. G = 2.61 - 2.699. Further information on this and nearby occurrences was provided by Sun.² He states that the cavities are in pegmatites, the latter found in a range of maturely dissected hills composed principally of gneiss with granite intrusions, forming a belt about 85 km (56.5 mi) wide immediately N of 41° N, and extending in an E-W direction between 110° and 114° E in the Huanghuakotung and Sailinhtang districts of Suiyuan. The deposits have been known locally for some years as evidenced by old workings, and suggests that this may have been one of the sources for slender aquamarine crystals that were used by Chinese lapidaries for carving into small objects.

At Tsungshengkou, more or less spherical cavities, 60-90 cm (2-3 ft) in diameter, contain beryl crystals. W of Tungtaikou, about 1 km (0.6 mi) NE of Tsungshengkou, occur more or less round, clay-filled cavities with smoky quartz crystals to 8 x 30 cm (4 x 12 in) and small greenish beryl crystals often firmly attached to the quartz crystals. In the Hsümawan area, about 500 m (315 yd) SE of that town, irregular cavities up to 130 cm (4 ft) diameter contain yellowish-red clay, quartz, topaz, and beryl crystals attached to the walls or loose in the clay. The topaz is pale green. Another locality exists 1 km (0.6 mi) NE of the preceding one. The Sailinhtang area features a few cavity pegmatites just W of Ch'ach'itsun and on the slope of Tsaothan hill, 1 km (0.6 mi) SW of Sailinhtang. In the Tachingshan area, pegmatites appear near Erhtaopei village on W slope Tachingshan hill with cavities 1 m (3 ft) diameter containing smoky quartz, beryl crystals of pale green to pale blue color in hexagonal prisms modified by second order prism. Omori mentions pale green beryl in pegmatite at Su Su Kon in southern Inner Mongolia.³

BERYL LOCALITIES

1. Wang, S. W. 1931. Crystals of beryl from Taching-shan Mountain, Suiyuan Province. *Geological Survey of China Bulletin* (Peking) 2:65-73.
2. Sun, C. C. 1933. Notes on the precious stone (beryl, etc.) deposits of Suiyuan. *Geological Survey of China Bulletin* 12:275-82.
3. Omori, K. 1958. Some pegmatite minerals from southern Inner Mongolia. *Science Reports of the Tohoku (Imperial) University*, ser. 3. (Sendai) 6:25-38.

IRELAND (EIRE)

County Donegal. Common beryl is an accessory species in pegmatites and quartz veins in granites and schists of the Gweebarra Mountains of W central Donegal. The best known localities are in the granites of the Rosses, a district between the town of Dunglow on the W coast northward to the village of Lough Anure. According to Burke et al.,¹ the occurrence of beryl was first noted in 1862 by Scott² and Haughton,³ with a description of the rocks by Pitcher,⁴ who also included a detailed petrological map. A later paper by Hall and Walsh⁵ was devoted to a study of the beryls and supplemented the material of Burke et al. All beryl is of the common variety, generally blueish-green and forming simple hexagonal prisms not over 8 cm (3 in) long. Some very good mineral specimens have been obtained, especially from the deposit N of Sheskinarone which itself lies about 2.7 km (1.7 mi) N of Dunglow. Here beryl occurs at numerous points in greisenized granite associated with quartz, muscovite, and feldspars. Other occurrences are on Meenbann Hill, N of Sheskinarone in coarse-grained muscovite granite and on Alterin Hill, about 1.7 km (1.1 mi) N of Dunglow, where it occurs in quartz veins and pegmatites. Analyses of beryls from these deposits, with properties, were given by Hall and Walsh.⁵ Of six specimens examined, refractive indices range as follows; $n_o = 1.583 - 1.585$, $n_e = 1.580 - 1.582$. $G = 2.706 - 2.726$. These localities were also recorded by T. M. Hall⁶ and F. W. Rudler.⁷

County Dublin. Beryl is fairly common in pegmatite bodies exposed in quarries in the mountains lying directly S of Dublin; all are clustered in a small area along the NE flank about 8-13 km (5-8 mi) from the center of the city. The crystals are more or less perfect prisms, grayish-green and blueish-gray, but translucent at best as at Dundrum, Stillorgan, Killiney near Dalkey, Glencullen granite quarry on Three Rock Mountain, and Bullock.^{7,8,9} The Killiney pegmatite is

complex with spodumene, schorl, apatite and "killinite," a clay pseudomorph after spodumene.⁸

County Wicklow. Common beryl may occur in pegmatites in the same mountain range noted above in County Dublin, except extending S over the border. Localities are Glenmacarnass (near the waterfall), Rathdrum, Roundwood, Annamoe, and near the mines of Cronebane.^{8,9}

1. Burke, K. C. et al. 1964. Beryl in the Rosses granite, north-west Ireland. *Economic Geology* (Lancaster, Pa.) 59:1539-50.
2. Scott, R. H. 1862. On the granite rocks of the southwest of Donegal. *Journal of the Geological Society of Dublin* 9:285-94.
3. Haughton, S. 1862. Experimental researches on the granites of Ireland. Pt. 3: On the granites of Donegal. *Quarterly Journal of the Geological Society of London* 19:403-20.
4. Pitcher, W. A. 1953. The Rosses granitic ring-complex, County Donegal, Eire. *Proceedings of the Geological Association* 64:153-78.
5. Hall, A., and Walsh, J. N. 1971. The beryls of the Rosses district, Donegal. *The Mineralogical Magazine* 38:328-34.
6. Hall, T. M. 1868. *The Mineralogist's Directory . . . Principal Mineral Localities in the United Kingdom of Great Britain and Ireland*. London: Edward Stanford. 168 pp.
7. Rudler, F. W. 1905. *A Handbook to a Collection of the Minerals of the British Islands*. London: Wymann & Sons. 241 pp.
8. Giesecke, C. L. 1832. *A Descriptive Catalogue of a New Collection of Minerals in the Museum of the Royal Dublin Society . . .* Dublin: R. Graisberry. 268 pp.
9. Greg, R. P., and Lettsom, W. G. 1858. *Manual of the Mineralogy of Great Britain and Ireland*. London: John Van Voorst. 483 pp.

ITALY

Trentino-Alto Adige

Large common beryl crystals occur in granitic pegmatites near Merano, 25 km (16 mi) NW of Bolzano. Schuster¹ described whitish gray and also blueish green crystals in mica schist on N side of the Ifinger, Masul Schlucht above Verdins in Passeyer; forms were $\{10\bar{1}0\}$ and $\{11\bar{2}0\}$ without terminations and size to 34×18 cm (13.5×7 in). The crystals are fractured and recessed with albite, quartz, and mica, and associated with epidote, tourmaline and pseudophite. Other references to Masul Schlucht localities appear in Zepharovich,^{2,vol. 3} Dittler,³ Scherillo,⁴ Millosevich and Scherillo,⁵ and Müller.⁶ Analyses are provided for Ifinger beryl by Schuster¹ and

World Sources of Ore and Gem Beryl / Italy

for Masul beryl by Dittler³ and Scherillo.⁵ The Masul deposit was mined in 1943 and yielded ca. 60 kg (120 lb) of beryl weekly in crystals to 3–4 kg (6–9 lb); these were whitish green to yellow, also reddish and green, rarely with good end faces and only translucent.⁶ Common beryl is rarely found in granitic pegmatites of Val Racines, W of Vitipeno or about 45 km (28 mi) N of Bolzano.⁷

Lombardy

Beryl may be found in pegmatites around Sondalo or about 80 km (50 mi) NE of Bergamo. Brugnatelli found beryl in talus blocks in lower Dombastone and Scala valleys as greenish blue prisms with {1010} and {0001}; $o = 1.5823$, $e = 1.5762(\text{Na})$.⁸ In the same region are beryl-bearing pegmatites described by Emiliani.⁹ In pegmatites of the Veltin area beryl may also be found.

In the Lago di Como district, beryl occurs in pegmatites at the N end of the lake on the small peninsula of Piona as prisms of 7–8 cm (2.75–3 in) long of greenish blue color;^{10,11} an analysis of a large cloudy greenish crystal is provided by Ferrari;¹² indices(Na) are $o = 1.5713 - 1.5747$, $e = 1.5664 - 1.5708$, mean diff. 0.0048; $G = 2.67$. Colasso describes a complex pegmatite at Olgiasca containing twenty species, among them common beryl.¹³ On the N slopes of Monte Legnoncino near Lago di Como, twelve pegmatite dikes were exploited for commercial mica; beryl was found in several.¹⁴ In the same general region, a group of pegmatites in Val Codera yielded excellent beryl crystals to 14 cm (5.5 in) long.¹⁵

Piedmont

Michele first discovered beryl here in an aplite vein in red granite of Baveno, W shore Lago Maggiore, just N of Montecatani quarry, as elongated prisms 5–6 cm (2–2.5 in) long, intensely blue and translucent; $G = 2.68$.¹⁶

Beryl exists in pegmatites in Vall'Antoliva and Cosasca on the W shore of Lago Maggiore. It is greenish white with some clear spots and in forms m and c ; commonly with mica and chlorite inclusions.¹⁷ Beryl is an important constituent of granitic pegmatite on Montescheno, SE of Moncuco, Val Antrona, Ossola, ca. 10 km (6.2 mi) S of Domodossola, NW of Lago Maggiore. Peretti described crystals of "azure" color to 18 × 40

Table 14-30
CHEMICAL ANALYSIS OF BAVENO BERYL
E. Pezzoli, analyst¹⁶

	Percent	Percent	Percent
SiO ₂	65.23	Fe ₂ O ₃	trace
Al ₂ O ₃	19.92	CaO	trace
BeO	13.76	MgO	?
		Total	99.99

cm (7 × 17 in) as fairly abundant;¹⁸ an olive green variety also occurs. However, Pagliani¹⁹ and Pagliani and Martinenghi²⁰ describe them as opaque, white to blueish green, to 20 × 35 cm (8 × 14 in); the largest crystal weighed 11.97 kg (26.5 lb). The beryls were so abundant in the central portion of the body that they were estimated to constitute 4–5% of the whole. Two new forms were reported: {3140} and {3250}.

Table 14-31
CHEMICAL ANALYSIS OF
MONTESCHENO BLUE BERYL¹⁸

	Percent	Percent	Percent
SiO ₂	64.95	BeO	12.56
Al ₂ O ₃	17.24	CaO	0.53
Fe ₂ O ₃	0.48	MgO	0.31
FeO	trace	K ₂ O	0.50
		Total	99.82

$G = 2.718$ (blue), 2.726 (olive-gray)
 $o = 1.5836$, $e = 1.5772$ (blue)
 $o = 1.5825$, $e = 1.5750$ (olive gray)

Strüver^{21,22} and Cossa²³ described opaque altered yellowish beryl crystals in detrital pegmatite blocks in Val Vigezzo on the road to Alp Marco from Craveggia; Val Vigezzo lies opposite Domodossola. Other localities are Vogogna, S of Domodossola, and Lonedo.

Valle d'Aosta

Beryl is found in pegmatite at the foot of Mt. Vélán near Étroubles, 13 km (8 mi) NNW of Aosta.

Tuscany

Beryl occurs in pegmatite on the small island of Giglio, lying off W coast 65 km (40 mi) SE of Elba.

BERYL LOCALITIES

Elba (Isola d'Elba)

This small island, only about 30×20 km (19×12.4 mi) in size, lies between the N end of Corsica and the Tyrrhenian (W) seacoast of Italy, or about 200 km (125 mi) NE of Rome. Since antiquity it has been noted for its iron mines (classic specimens of pyrite and hematite) and in more recent times for splendid pocket crystals from numerous small granitic pegmatite bodies of vein-like form. These occur along a N-S interlaminated contact between the Monte Cappane granite stock, which forms the W half of the island, and schists, gabbros, and calc-silicate rocks, among other types, which lie immediately E of the contact. The pegmatite bodies are rarely over 1 m (3 ft) thick and strike generally N-S to SSW-NNE and dip 50° - 90° . They occur in the hundreds.²⁴ A consistent feature is the presence of black tourmaline, and in some, well-defined

symmetrical zoning, with tourmaline at contacts, coarse-grained and graphic-granite textured feldspar-quartz, and a central zone of feldspar, albite, quartz, lepidolite-muscovite, tourmaline, garnet, beryl, pollucite, petalite, cassiterite and pyrochlore.²⁴ Apatite and zeolites were also reported.²⁵

In some bodies, vugs are common and the species lining them are sharply and cleanly crystallized, particularly feldspars, quartz, tourmalines, and beryls, which accounts for the high esteem in which specimens are held. In the immediate vicinity of San Piero village, and stretching N to San Illario, three quarries were operated for at least fifty years prior to 1909 for the sake of druse minerals. The pegmatites, however, are not mineralogically equivalent, the Grotta d'Oggi vugs containing no zeolite, pollucite, or petalite, yet in the Speranza quarry these are abundant, though



Fig. 14-30 Sketch map of the gem pegmatite region around San Piero in Campo, Island of Elba, Italy. Based on a map of de Michele, *Guida Mineralogica d'Italia 2* (1974).

World Sources of Ore and Gem Beryl / Italy

in poor quality. Furthermore, the Grotta d'Oggi tourmalines are black in vugs of thick veins and colored only in vugs of thinner bodies.²⁵ Beryl and garnet are associated with black tourmaline as well as colored tourmaline. Aquamarine occurs with white orthoclase, black tourmaline, and large quartz crystals. In Grotta d'Oggi are found these species listed in order of decreasing abundance: quartz, orthoclase, albite, lepidolite, tourmaline, beryl, garnet, cassiterite, pollucite and apatite. Rose beryl is very rare but some has been found here as well as in the Speranza quarry. They are transparent, to 60 × 18 mm (2.3 × 0.7 in), and tabular in habit. Other beryls are colorless, greenish, blueish green, pale blue (usually milky), and yellowish.²⁶ Achiardi described some as "smoky" in hue, also dark bottle green, and sometimes color-zoned with blue terminated by green or colorless.²⁷

Recent visitors stated that quarrying is inactive but that many small dumps exist around the quarries all within several hundred meters around the village of San Piero. Occasionally specimens may be purchased from the villagers. Most openings are now brush-filled and neglected, with exposures nearly obliterated. Specific localities mentioned by Achiardi are Fonte del Prete, S of the village 100 m (100 yd), Grotta d'Oggi, Facciatora, Tabbiali, and Speranza.²⁷

The varietal name *rosterite*, after G. Roster, an Italian mineralogist, was applied to pale pink beryl crystals by Grattarola on the tenuous grounds that (a) the crystals were tabular instead of prismatic as in "normal" beryl, (b) the prism faces were not striated vertically, (c) the basal faces were bulged and covered with numerous growth hillocks, (d) the color was pink, and (e) under polarized light six optically distinct triangular segments appeared in the basal plane.²⁸ A further chemical distinction was made because of the lesser amount of BeO and more Al₂O₃ than called for in the ideal composition, as well as the presence of alkalis and water. Grattarola furnished analyses of four specimens and ascribed the color to lithium.²⁸ However, Arzruni, in reviewing the problem, concluded that there were not enough differences to warrant a varietal name.²⁹ Some years later, Busatti applied the same name to a pale green beryl from San Ilario.³⁰

Maddalena analyzed Elba beryls for alkalis and found 0.41% for colorless, 3.89% for "peach

blossom pink," and none in sky blue beryl.³¹ The following properties were provided:

Table 14-32
PROPERTIES OF ELBA BERYLS³¹

	Colorless	Pink	Sky blue
<i>o</i> (Na)	1.57682	1.57778	1.59169
<i>e</i>	1.57169	1.57269	1.58524
G	2.6891	2.6917	2.7639

Elba beryls are noted for their sharpness and richness in faces. Achiardi listed 19 forms that were recognized prior to his work, but doubted the existence of {2243}, {15.0.15.2} and {4261} and then added five more forms which are included in his list.

Table 14-33
FORMS NOTED ON ELBA BERYLS²⁷

10 $\bar{1}$ 0	20 $\bar{2}$ 5	11 $\bar{2}$ 2	21 $\bar{3}$ 1
11 $\bar{2}$ 0	hoh1	11 $\bar{2}$ 3	31 $\bar{4}$ 1
21 $\bar{3}$ 0	10 $\bar{1}$ 2	22 $\bar{4}$ 3	51 $\bar{6}$ 1
51 $\bar{6}$ 0	20 $\bar{2}$ 1	11 $\bar{2}$ 1	42 $\bar{6}$ 1
10 $\bar{1}$ 1	15.0. $\bar{1}$ 5.2	42 $\bar{6}$ 3	11.2. $\bar{1}$ 3.2
1.0. $\bar{1}$.12	12.0. $\bar{1}$ 2.1	9.7. $\bar{1}$ 6.8	0001

Out of a total of 138 crystals examined by Achiardi, forms {10 $\bar{1}$ 0} and {0001} were found on 23 specimens while {10 $\bar{1}$ 0}, {10 $\bar{1}$ 1}, {11 $\bar{2}$ 1} and {0001} were found on 57 crystals. Millosevich added {10 $\bar{1}$ 3} as new form to the list, this being a first order dipyrmaid, and another new form for Elba of {1.0. $\bar{1}$.14}; then dipyrmaids of the second order of {5.5. $\bar{1}$ 0.7} (new for Elba); {33 $\bar{6}$ 5}, {4489}, and {1.1. $\bar{2}$.10} (new for the species), and lastly, dihexagonal dipyrmaids new for the species of {32 $\bar{5}$ 5}, {5499}, and {8191}.³²

In general, the Elba beryls are considerably overshadowed by the magnificent colored tourmalines, but Rath mentioned a superb tabular pink crystal in a Florence collection that was hexagonal in outline, 1 cm (0.4 in) thick and 5 cm (2 in) in diameter;²⁴ another in a Turin collection was a prism enveloped in lepidolite, muff-fashion, with the lepidolite oriented on the beryl such that its cleavage planes coincided with the basal plane of the beryl.

BERYL LOCALITIES

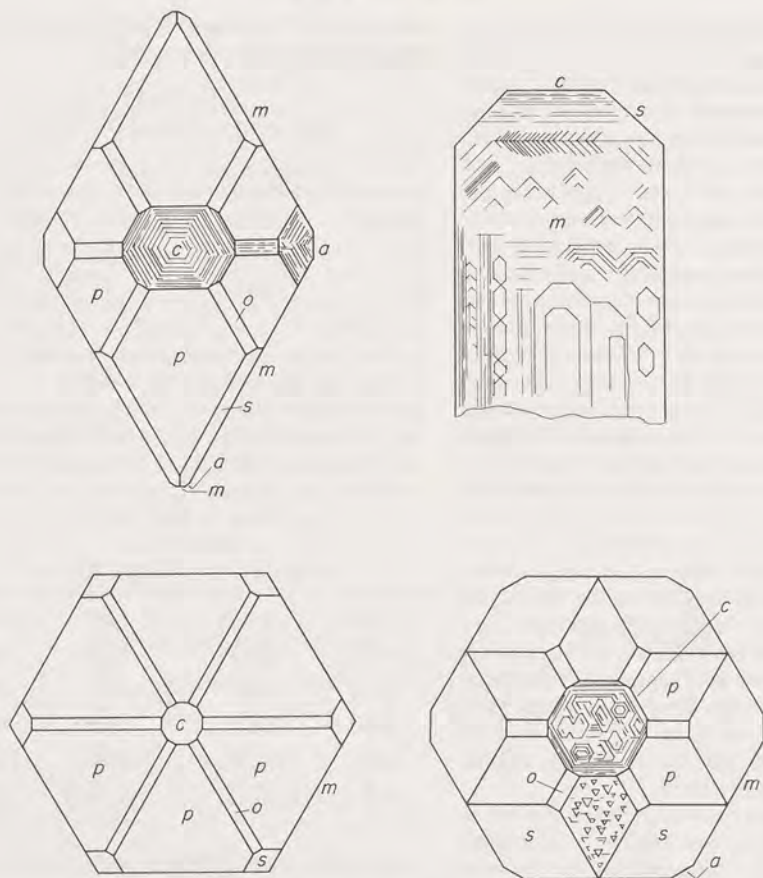

Fig. 14-31 Beryl crystals from Elba. Such beryls occur in the granitic pegmatites of Fonte del Prete, Grotta d'Oggi, Facciatoia, Stabbiali, Speranza, etc. Several crystals show growth hillocks or etch marks. Forms $c\{0001\}$, $m\{10\bar{1}0\}$, $p\{10\bar{1}1\}$, $o\{11\bar{2}2\}$, $a\{11\bar{2}0\}$, $s\{11\bar{2}1\}$.

- Schuster, M. 1888. Ueber das neue Beryllvorkommen am Ifinger. *Zeitschrift für Kristallographie und Mineralogie* (Leipzig) 13:623-4.
- Zepharovich, V. v. 1859-1893. *Mineralogisches Lexicon für das kaiserthum Österreich*. 3 vols. Vienna: Wilhelm Braumüller.
- Dittler, E. 1929. Neue Beryllaufschlüsse in der Mallschlucht, Südtirol. *Tschermak's Mineralogische und Petrographische Mitteilungen* (Vienna) 40:188-9.
- Scherillo, A. 1934. Ricerche sulle pegmatiti de rio Masul (Merano). *Periodico di Mineralogia* (Rome) 5:181-90.
- Millosevich, F., and Scherillo, A. 1934. Beryllium: geochemical and mineralogical study, with special reference to the Italian deposits. *Ricerca Scientifica, Consiglio Nazionale delle Ricerche* (Rome) 5:325-37.
- Müller, F. 1949. Sammlerfahrt nach Südtirol. *Kärnthin, Mitteilungen des naturhistorischen Landesmuseums für Kärnthin* (Klagenfurt) 4:63-66.
- Morgante, S. 1952. Segnalazione di pegmatiti antiche a berillo in Val Racines (Alto Adige). *Rendiconti della Società Mineralogica Italiana* (Pavia) 8:155-6.
- Brugnatelli, L. 1901. Berillo ed altri minerali delle pegmatiti di Sondalo in Valtellina. *Rendiconti dell'Istituto Lombardo di Scienze e Lettere* (Milan) 34:914-20.
- Emiliani, F. 1955. Nota preliminare sulla studio di pegmatiti del gruppo dell'Ortler. *Rendiconti della Società Mineralogica Italiana* 11:350-1.

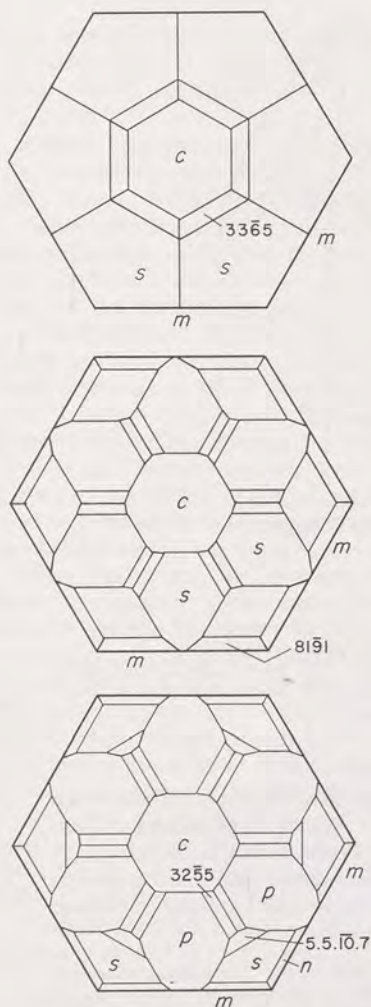

Fig. 14-32 Elba beryl crystals (basal projections) showing forms $c\{0001\}$, $s\{11\bar{2}1\}$, $m\{10\bar{1}0\}$, $p\{10\bar{1}1\}$, $n\{31\bar{4}1\}$, and unlettered $\{33\bar{6}5\}$, $\{81\bar{9}1\}$ and $\{5.5.\bar{1}0.7\}$. From F. Millosevich, "Forme nuove del berillo elbano," *Atti della Reale Accademia (Nazionale) dei Lincei Roma* 20 (1911).

10. Bertolio, S. 1903. Sui filoni pegmatitici di Piona e sulla presenza in essi del berillo. *Rendiconti dell'Istituto Lombardo di Scienze e Lettere*, 36:368-74.
11. Magistretti, L. 1940. Berillo nel filone pegmatitico del Laghetto di Piona. *Natura* (Milan) 31:70-2.
12. Ferrari, M. 1921. Sul berillo di Piona (Lago di Como). *Atti della Reale Accademia (Nazionale) dei Lincei, Rendiconti, Cl. Fisiche e Matematiche* (Rome) ser. 5, vol. 30, sem. 1, pp. 89-92.
13. Colasso, T. 1937. I minerali dei filoni pegmatitici di Olgiasca. *Atti della Società Italiana di Scienze Naturali e del Museo Civile di Storia Naturale* (Milan) 76:403-18.
14. Magistretti, L. 1946. [Pegmatite dikes near Mount Legnoncino near Lake Como]. *Atti della Società Italiana di Scienze Naturali* . . . 85:136-46.
15. Peco, G. 1949. [Beryl pegmatites of the Val Codera, Sondrio]. *Industria Ceramica e Silicata*, vol. 2, no. 10, pp. 6-9.
16. Michele, V. de. 1966. Sulla presenza del berillo a Baveno. *Atti della Società Italiana di Scienze Naturali* . . . 105:298-403.
17. Lincio, G. 1905. Sul berillo di Vall'Antoliva e di Cosasca. *Atti della Reale Accademia delle Scienze, Cl. Fisiche, Matematiche e Naturali* (Turin) 40:870-9.
18. Peretti, L. 1939. Il berillo di C. Mondei presso Montescheno (Val d'Ossola). *Atti della Reale Accademia (Nazionale) dei Lincei, Rendiconti, Cl. Fis. e Matematica*, ser. 7, vol. 1, pp. 63-6.
19. Pagliani, G. 1941. Un filone pegmatitico a struttamento integrale. *Rendiconti della Società Mineralogica Italiana* (Pavia) 1:120-2.
20. Pagliani, G., and Martinenghi, M. 1941. Il filone peg-

BERYL LOCALITIES

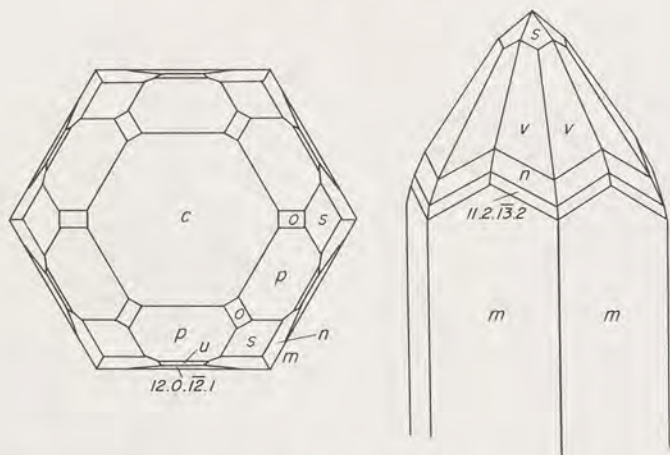

Fig. 14-33 Beryl crystals from Elba showing forms $u\{20\bar{2}1\}$, $v\{213\bar{1}\}$, $n\{314\bar{1}\}$, and the very steep dihexagonal bipyramid $\{11.2.13.2\}$.

- matitico di Montescheno in Val Antrona (Ossola). *Periodico di Mineralogia* (Rome) 12:49-78.
21. Strüver, G. 1885. Ueber Columbit von Craveggia in Val Vigizzo (Ossola, Piemont). *Zeitschrift für Kristallographie und Mineralogie* 10:85-6.
 22. ———, 1889. Contribuzioni alla mineralogie della Valle Vigizzo. *Atti della Reale Accademia (Nazionale) dei Lincei, Rendiconti* 5:183-5.
 23. Cossa, A. 1888. Analyse des Columbits von Craveggia. *Zeitschrift für Kristallographie und Mineralogie* 14:505-6 (abstract).
 24. Rath, G. v. 1870. Geognostische-mineralogische Fragmente aus Italien. VIII. Die Insel Elba. *Zeitschrift der deutschen geologischen Gesellschaft* (Berlin) 22:591-732.
 25. Adams, J. W. H. 1909. Die Pegmatitzüge des San Piero in Campo auf Elba. *Zeitschrift für Praktische Geologie* (Berlin) 17:499-500.
 26. Grilli, E. 1940. I minerali d'ornamentazione Italiani. *Rendiconti dell'Istituto Lombardo di Scienze e Lettere, Cl. Scienze, Matematiche e Naturali* (Milan) 73:355-65.
 27. Achiardi, G. d'. 1904. Forme cristalline del berillo Elbano. *Processi Verbali della Società Toscana di Scienze Naturali in Pisa* 14:75-83.
 28. Grattarola, G. 1880. Sopra una nuova varietà (rosterite) del berillo elbano. *Revista Scientifico-Industriale delle Principale Scoperte ed Invenzioni fatte nelle Scienze e nelle Industrie* (Florence) 12:423-32.
 29. ———, 1881. Eine neue Varietät des elbaner Berylls. *Zeitschrift für Kristallographie und Mineralogie* 5:502-4 (abstract).
 30. Busatti, L. 1891. Sopra un aspetto nuovo del berillo elbano. *Processi Verbali della Società Toscana di Scienze Naturali in Pisa* 7:299-302. Also appears in *Giornale di Mineralogie* (Milan) 2:278-82.
 31. Maddalena, L. 1912. [Chemical-mineralogical investigation on some Elban beryls]. *Atti della Reale Accademia (Nazionale) dei Lincei* 21:633-9.
 32. Millosevich, F. 1911. Forme nuove del berillo elbano. *Atti della Reale Accademia Nazionale dei Lincei* 20:138-44.

IVORY COAST

Beryl occurs as small crystals, not over 1 cm (0.5 in), greenish, blueish, in pegmatites of Gonaté and D'Issia, Upper-Sassandra; at Béoumi in Baoulé; and in pegmatites in gneiss along the sea-coast between Popoko and Monogaga in Lower Cavally.¹

1. Aubert De La Rue, E. 1927. Sur quelques minéraux de la Côte-d'Ivoire. *Compte Rendu de l'Académie des Sciences* 184:104-6.

JAPAN

Fukushima Prefecture. Beryl occurs at Mujinamori, Tomaki, and other points near Ishikawa village in pale green, opaque crystals to 10×6 cm (4×2.3 in); smaller crystals about 2.5 cm (1 in) are darker in hue and transparent.¹ Yoshimura analyzed beryl from Ishikawa for alkalies and mentioned its source as from one of many pegmatites outcropping in the hilly region 4 km (2.5 mi) NW of the village.² The pegmatites characteristically contain columbite and beryl.³ Omori and Yokoyama describe and provide an analysis for large crystals with apple-green cores and oil-

World Sources of Ore and Gem Beryl / Madagascar (Malagasy Republic)

green exteriors from a feldspar quarry at Ameda, Ohigashi village; lengths range to 1 m (3 ft); forms {10 $\bar{1}$ 0}, {21 $\bar{3}$ 0}; $o=1.5784$, $e=1.5728$, $G=2.698$.⁴

Ibaraki Prefecture. Pale green and yellowish gray crystals in pegmatite occur at Yamano,¹ about 4 km (2.5 mi) E of Makabe.³

Nagano Prefecture. Many granitic beryl-bearing pegmatites, complexly mineralized, occur here at Idowaza and Honzawa, Yamaguchi village, and are described by Shibata.³

Gifu Prefecture. (formerly "Mino"). Around Takayama beryl is commonly obtained from alluvial deposits and rarely from vugs in pegmatites. Crystals are perfectly transparent, pale greenish or colorless, but only 4.5 × 0.2 cm (1.8 × 0.01 in).¹ Jimbo, however, states that prisms 1 cm (0.5 in) thick occurred with smoky quartz here and elsewhere in the district and provided good single-crystal and group specimens.⁵

Shiga Prefecture. In Tanokamiyama, called by Nakatsukasa the "great treasure house of minerals,"⁶ beryl is associated with topaz as opaque to transparent pale green crystals. The opaque type reaches 4.5 cm (1.8 in) diameter, but the transparent crystals only about 1.6 cm (0.75 in), although such may be elongated to 15 cm (6 in) and wholly transparent, with strongly striated prism faces and perfectly sharp and smooth terminal faces.¹ A "perfect" basal cleavage may be noted on both types. Jimbo mentions greenish or blueish prisms from here of 13 × 3 cm (5 × 1.25 in) with forms {10 $\bar{1}$ 1}, {11 $\bar{2}$ 1} and {0001}.⁵

Kyoto Prefecture. Allanite pegmatites contain beryl crystals to 1 m (3 ft) long.⁷

Fukuoka Prefecture. White beryl occurs in pegmatites at Nagatare.³

1. Wada, T. 1904. *Minerals of Japan*. Translated by T. Ogawa. Tokyo. 114 pp.
2. Yoshimura, J. 1926. Alkali metals in beryl from Ishikawa, Iwaki Province. *Bulletin of the Chemical Society of Japan* (Tokyo) 1:239.
3. Shibata, H. 1952. Mineralizations in granite-pegmatites in Japan and Korea. *Science Reports of the Tokyo Bunrika Daigaku*, sect. c, vol. 2, no. 10-11, p. 107-44.
4. Omori, K., and Yokoyama, K. 1956. Beryl from a pegmatite at Ameda in Ohigashi Village, Fukushima Prefecture. *Science Reports of the Tohoku (Imperial) University* (Sendai) ser. 3, vol. 5, p. 149-51.
5. Jimbo, K. 1901. Notizen über die Mineralien vom Japan. *Zeitschrift für Kristallographie* . . . (Leipzig) 34:215-23; originally in: *J. College of Science, Imperial Univ. of Tokyo* (1899) 11:213-81.

6. Nakatsukasa, M. 1929. [Minerals of Tanokami, Japan]. [*The Earth*], 11:330-44.

7. Takubo, J., and Masahisa, T. 1951. Allanite found in Kobe and Miemura, Kyoto Prefecture. *Journal of the Geological Society of Japan* (Tokyo) 57:1-5.

KENYA

Beryl is a minor constituent of granitic pegmatites intruded into rocks of the basement system in this country.¹ They are concentrated mainly at Maralal, Baragoi district, in the Machakos district, and the country between Tsavo and Taveta in SE Kenya.² Some gem quality blue has recently been found in Baragoi district about 360 km (225 mi) N of Nairobi. Green beryl was mined at Sebit in Cherangani Mountains, 300 km (190 mi) NNW of Nairobi. In N Kenya, beryl pegmatites occur at Boji in Timtu Hills; mined for ore beryl. In Embu district, ca. 100 km (68 mi) NE of Nairobi, some golden beryl of gem quality as well as common beryl may be found. Beryl pegmatites occur in Isiolo and Wamba districts of central Kenya. Beryl occurs in Mokogodo district, and at Machakos in Sultan Hamud district in S Kenya. Ore beryl production reported as follows: 1957, 5 long tons; 1959, 2.25 long tons; 1960, 3,145 lb; 1961, 1,232 lb.³ (See fig. 14-34.)

1. Pulfrey, W. 1960. The geology and mineral resources of Kenya. Rev. ed. *Geological Survey of Kenya Bulletin* 2 (Nairobi), p. 29.
2. Dodson, R. G. 1958. Pegmatites of Kenya [with discussion]. *Commission for Technical Co-Operation in Africa South of Sahara, East-Central & South Regional Commission, Geological Meeting 2*, (Tananarive 1957) pp. 89-93.
3. Newman, E. G. 1962. *Beryllium Resources of the British Commonwealth*, 1962. Vol. 1. London: British Commonwealth Geological Liaison Office. 22 pp.

MADAGASCAR (MALAGASY REPUBLIC)

The fourth largest island in the world is Madagascar, which is 1,580 km (1,000 mi) long and 580 km (365 mi) across at its widest. Two major groups of rocks cover the island: ancient Precambrian basement rocks and younger sediments. The basement rocks, which cover most of the area, consist mainly of gneisses and schists overlain over wide areas by crystalline limestones, cipolins in part, and schist-quartzites. Numerous granite intrusions contributed pegmatite mineralization which is commonly complex and affords a large variety of minerals, including those suitable for gems and mineral specimens. Both com-

BERYL LOCALITIES

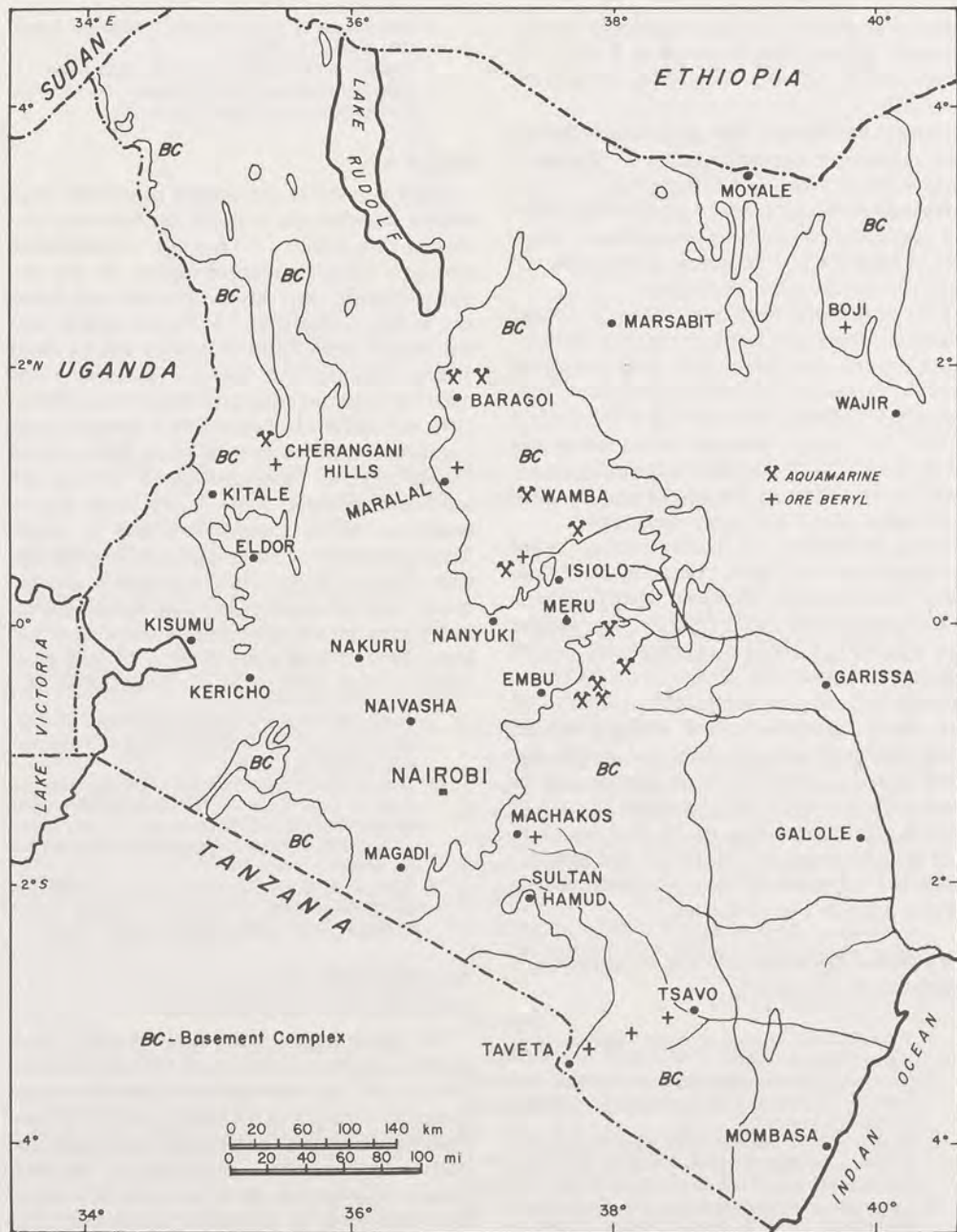

Fig. 14-34 Gem and ore beryl localities in Kenya. From a geological map of the Survey of Kenya, 1969, and additional information from an overlay to same prepared by John M. Saul.

World Sources of Ore and Gem Beryl / Madagascar (Malagasy Republic)

mon and gem beryl occur in many bodies.¹ The areas in which productive pegmatites occur extend with some interruptions from Daraina in the north to Ejeda in the south, or about 1,340 km (850 mi) as shown in fig. 14-35. Perhaps even more astonishing than the extent of this pegmatite-rich province is the richness of the pegmatites in desirable minerals, a circumstance that is rivaled in few other pegmatite regions in the world. Much of the information on them, and the minerals contained therein, was obtained from the splendid three-volume work on Madagascar minerals by Alfred Lacroix.²

History

Shortly after the conquest of the island by the French, a certain Captain Jean Fonteneau declared in 1547 that he had found precious stones. These probably came from alluvial deposits, inasmuch as little of the interior had been explored, but about 1888, the famous pegmatite district around Mount Bity, S of Antsirabe, was discovered by a Mr. Bing. Through the services of A. Grandidier, the French mineralogist, a very large crystal of rubellite was presented to the Musée Nationale de Minéralogie in Paris. Toward the close of 1893, a Mr. Gautier reported fragments of rubellite and other tourmalines in place in the Betafo region pegmatite bodies. Explorations by commercial lapidary M. Vuillerme uncovered many promising prospects in the central highlands and led to the organization of several mining companies, whose members hastened to exploit the gem-bearing deposits. The first regular shipment of gemstones began in 1904, and controls over the trade were established in 1907. The total weights, undivided, of exports during 1908-1922 inclusive, ranged from a low of 46 kg (101 lb) in 1915 to a high of 1,029 kg (2,266 lb) in 1920, the annual average being 282 kg (620 lb). Most was shipped to France and the remainder to Germany and Switzerland.³

Statistics are meager for recent production and for several reasons cannot accurately reflect actual export quantities. Dumas noted that Ambatofiaorana pegmatite, N of Tananarive, produced 6,770 gm of gem beryl during 1922-1923 valued at 20,000-40,000 Fr.⁴ Murdock stated that in 1959, only 0.7 kg and in 1960 only 6.5 kg of gem beryl were exported, but elsewhere he mentioned "clandestine" mining operations which suggests

that considerably more than these reported quantities reached the market.¹ Despite such small quantities, the quality of beryls tends to be much higher than that from other countries. Especially prized are the pink beryls, of a unique magenta tint that suggests the color of high quality kunzite. Of equal merit are the blue varieties, some of which were described by Lacroix as "sky-blue," as from Ampangabe, or of "a very special dark blue, with a black tint," as from Tongafeno, Fefena, etc.⁵ Murdock and other writers extolled the beauty of the blue beryls of Marijao.¹

Cut pink beryls from Madagascar appear in almost every important public and private collection. The American Museum of Natural History in New York owns several splendid gems of 98.5 and 75.25 carats,⁶ and a remarkable Chinese carving in pink beryl that measures 15 cm (6 in) tall and is said to be the finest such carving in pink beryl in existence. An astonishingly large and fine, rich-pink, cut, beryl gem from Madagascar is displayed in the Mineral Hall, British Museum (Natural History) London; it is a flawless, square cushion-brilliant weighing 598.7 carats (see color fig. 12). Large Madagascar beryl gems are also in the U. S. National Museum, Washington, D.C., and include a 133-carat faceted yellow gem and a 44-carat golden-yellow cat's-eye cut from a Sahanivotry crystal.

Lacroix summarizes color varieties and type sources for beryl as follows (vol. 2, pp. 91-2).² *Colorless*: Ampangabe, Anjanabonoina. *Yellow*, pale to golden: Ampangabe, Sahanivotry, Ankazobe. *Sky-blue or pure blue*: Ankazobe, Ampangabe, Ambotolampy, Masompenoarivo, Ikalamovony, Betsiriry, etc. *Deep blue*, with tint of black: Tongafeno especially, seldom cuttable over 9 carats; similar but not identical from Antaboaka, Fefena, the last providing stones zoned in blue with a touch of green. *Blue green*, ordinary aquamarine color: Ampangabe, Jaiky, Ifempina, Betsiriry, Ankazobe. *Asparagus green*: Sahanivotry, Antaboaka, Ifempina. *Green*, with a touch of olive (like kornerupine): W of Laondany where it is common. *Emerald green*: not found; an exterior zone of blue Tongafeno crystals is reminiscent of emerald (see a later section for a recent discovery of true emerald). *Rose*: Tsilazina, Ampangabe, Vohidahy, Tsaravovonana, Marahitra, Anjanabonoina, finer than those from San Diego County, California.

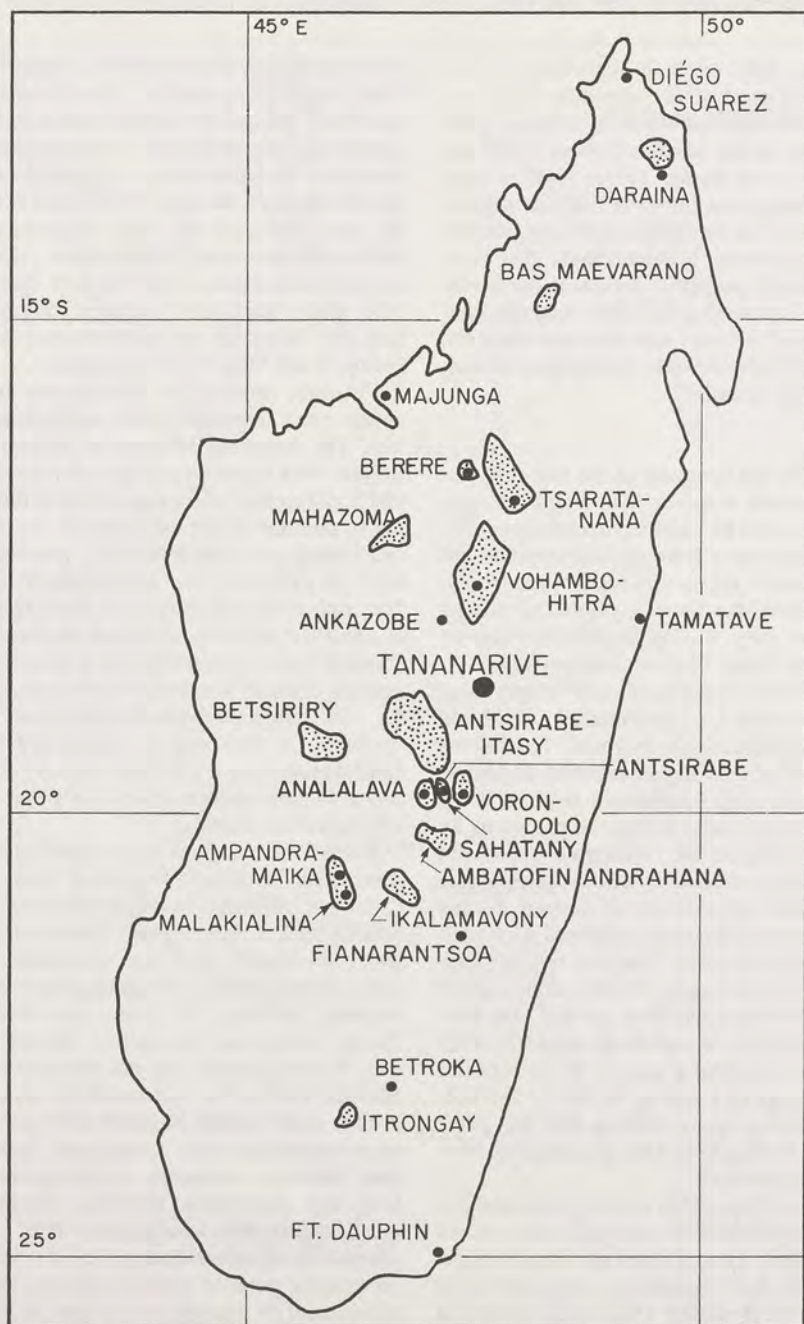

Fig. 14-35 Map of Madagascar showing locations and extents of the major ore beryl-producing regions as of 1962. From T. G. Murdock, "The beryl resources of the Malagasy Republic," *Mineral Trade Notes*, 34 (Washington D.C., 1962).

World Sources of Ore and Gem Beryl / Madagascar (Malagasy Republic)

In 1916, 500-gm lots of rough, sky-blue beryl and vivid, rose beryls, weighing over 2 gm per stone, sold for 4–5 Fr. per gm, and for one-gm pieces, one Fr. Pure blue stones sold for 0.20 to 1 Fr. per gm, depending on color. Larger stones obtained much higher prices. Large yellow stones fetched 1.5 Fr. per gm, while pure rose stones of 2 gm went for 2.5 Fr. per gm. Cut stones sold for 10–15 Fr. per carat, if of good color; a very fine blue stone brought 150 Fr. per carat; blue from Tongafeno sold for 80 Fr. per carat; outstanding rose gems sold for over 100 Fr. per carat and greens at 40 Fr. per carat. In 1963, prospects for continued or increased production of gem beryl and other pegmatite gemstones seemed unfavorable according to Murdock, who remarked that “unfortunately the pegmatites, occurring generally as dikes, lenses, or irregular masses, lack continuity and regularity, and only rarely constitute large deposits.”¹ However, there is much doubt that all possibly productive bodies have been exhausted or even discovered, and recent visitors are unanimous in characterizing the gem industry as dormant due to lack of incentives, discouragement of foreign investment and ownership of deposits, trivial restraints on exports, and a general administrative malaise.

Aside from gem beryls, significant production of ore beryl has taken place from 1950 onwards. From this date, the French Atomic Energy Commission, the Geological Service, and more recently the Bureau Minier, instituted vigorous explorations for pegmatites containing Be-minerals. By 1960, thirteen producers were active and production for that year established a record, with the total from 1948 to 1960 being 4,433 metric tons.¹ During 1958 to 1960, 678 metric tons were exported to France and 389 metric tons to the U.S.A. In 1960, 635.815 metric tons were produced, of which the Pechiney Company mined the major amount, that is, 422.6 m tons.¹

The Pegmatites

Lacroix classified Madagascar granitic pegmatites as potassic and sodalithic, according to relative abundances of K and Na + Li (vol. 2).² Typical mineral assemblages in them are given in table 14-34.

According to Lacroix (vol. 2) potassic beryl-pegmatites may be rich in muscovite with tour-

maline rare or absent; rich in tourmaline and poor in muscovite, or lacking this mineral; or rich in both species. Biotite is generally present only in small amounts. The quartz which usually accompanies beryl contains much gas-liquid inclusions and commonly assumes an attractive rose color on the outcrops but may darken to gray in depth. Beryl is an early species to form. Sodalithic pegmatites are more complex by far and characterized by abundant albite associated with microcline-perthite, lithium minerals, frequent appearance of iron and manganese species, and an abundance of tourmaline. Micas are absent or present only in minor amounts. Beryl occurs in the entire range of chemical composition from common beryl of low density to high density alkaline beryls. The latter are found only in vugs while common beryl appears elsewhere but not in such large crystals as occur in potassic pegmatites. Alkali beryl crystals are usually flattened on the basal plane, *c* and rarely reach 10 cm (4 in) maximum dimension. The color is commonly a more or less intense rose or pink, but sometimes colorless, and in exceptional instances, a green beryl is associated with rose in the same crystal, as at Vohimasina, or a blue with rose, as at Antaboaka. Rarely, cesian beryl is opaque, milky white, or tinged with pink, as at Maharitra.

Daraina Field. Beryl may be found at Daraina town 100 km (64 mi) SSE of Diego Suarez at N end of island; some ore beryl is also produced.

Ambatoharanana–Ambohimirahavavy Region. Minor ore beryl pegmatites occur E of Port Bergé and S of Sofia; Port Bergé is 400 km (250 mi) N of Tananarive.

Berere–Tsaratanana Region. Tsaratanana city is 240 km (150 mi) N of Tananarive. Nearby deposits produced 20 metric tons of ore beryl through 1959.¹ Berere field, 39 km (24 mi) NW of Tananarive, produced 800 metric tons through 1959 as summarized by Besairie.⁷ Giraud described the pegmatites in detail.⁸ Berere bodies also explored for gem beryl, especially in the Mahajamba area where crystals to 3 m (9 ft) found, some areas furnishing beautiful blue or green gems.^{2, vol. 2} Many pegmatite veins appear in the vicinity of Maevatanana; a pegmatite at Besakay produced some beryl. Near the peak of Namakia, 43 km (28 mi) SW of Tananarive, beautiful blue beryl has been found.^{2, vol. 2} Complex bodies in the valley of Androfia River and

Table 14-34
MINERAL ASSEMBLAGES IN MADAGASCAR GRANITIC PEGMATITES²

Species	Potassic Type	Sodalithic Type	Species	Potassic Type	Sodalithic Type
Quartz	Gray, white, smoky, rose ^a	Gray, white, smoky ^a	Oxides, <i>cont'd.</i>	Crichtonite (ilmeneite)	
Feldspars	Microcline, white or green (amazonite) ^a	Microcline, white or green (amazonite) ^a	Aluminates	Hematite [Gahnite]	
Micas	Albite ^a Biotite	Albite ^a Biotite; [Li-muscovite]; Lepidolite ^a ; zinnwaldite	Ferrites Fluorides Carbonates Elements	Magnetite [Fluorite]	Magnetite Calcite Bismuth
Tourmaline Garnet	Fe-varieties ^a Almandine; alm.-spessartine	Fe-var.; Li-var. (polychrome) ^a Spessartine ^a	Sulfides	[Gold] Bismuth Graphite	
Accessory silicates	Common beryl; colorless, green, blue ^a	Common beryl; rose, rarely blue or green; high-density beryl, rose, rarely green ^a	Sulfosalts	Bismuthinite Molybdenite Pyrite Pyrrhotite Chalcocite Bornite Chalcopyrite [Cosalite]	
Niobates	Topaz Allanite [Scapolite] [Thortveitite] Sphene Chevkinite Columbite Fergusonite Samarskite Ampangabeite Euxenite Priorite Betafite Samiresite Blomstrandine Apatite Monazite Xenotime?	Spodumene (kunzite) ^a Danburite ^a Bityite ^b Manandonite ^b Palygorskite ^b [Columbite] [Manganocolumbite] [Euxenite] Blomstrandine	Secondary minerals	Autunite Bismutite Pucherite Pyromorphite Hematite (martite) Rutile Malachite Limonite Stilpnosiderite Psilomelane Opal Quartz Chalcedony Hydrargillite Alumogels Kaolinite Clays	Autunite Bismutite Psilomelane Quartz Chalcedony Hydrargillite Alumogels Kaolinite Clays
Phosphates		Apatite Mg-apatite	Endomorphous minerals	Grossular Corundum Pleonaste Sillimanite Kyanite	Grossular Hudsonite Tremolite Actinolite Calcite
Borates		Hambegite Rhodizite			
Oxides	[Rutile] Ilmenorutile Struverite Zircon Malakon Uranothorite Orangite [Thorianite]				

^aSpecies found in body of pegmatite and in vugs. ^bFound only in vugs. [] found at one occurrence only.

World Sources of Ore and Gem Beryl / Madagascar (Malagasy Republic)

around Ambaliha village have been exploited for gem beryl. In Menazomby area, 35 km (22 mi) NNE of Tsaratanana, rose + water green beryl occur in the same crystals, but such split readily along the color-division plane; also present were yellow and blue beryls. The G of rose beryl is 2.70; it is Cs-bearing. When heat treated, the yellow variety turns blue.⁹ At Andakana, SE of Tsaratanana and W of Ambolomborona, beryl occurs in a lenticular body in gneiss. Complex pegmatites occur around the villages of Ampananganan'i Tsilavirana, Andasibe, Ampandrano, Ambongolava, Maropapango, and in the mountains of Antevatapaka. Other pegmatite fields may be found between Tsaratanana and Andramena, near the villages of Antsampsandrano, Bepia, Mahatsinjo, and in Ampizarantany Mountains.

Andriamena Region. The village of Andriamena is 72 km (44.5 mi) S of Tsaratanana or 158 km (113 mi) N of Tananarive and areas to the N and S contain complexly mineralized pegmatites. In the Andriamena-Manakana villages area many bodies characteristically contain beryl, columbite, garnet, euxenite, xenotime, and fergusonite. Beryl pegmatites in the area are bounded on the W by Betsiboka River, to the E by the migmatite-granite massif of Beampody, and on the S by Mavolava River. Greenish to blueish prisms are common in many.¹⁰ Numerous pegmatites occur SE of Andriamena. At Ambalanirana a clear gem aquamarine was found. At Mahabe, 27 km (17 mi) E of Andriamena, splendid clear topaz crystals were mined from pegmatite. One weighed 2,290 gm and was secured for the British Museum (Natural History), London.¹¹ This locality was also noted for giant amazonite crystals, quartz crystals, and blue, green, and golden beryls.^{2, vol. 2} The following localities in the region on the N and E borders of the Vohambohitra granite massif furnish beryl: near Manakana village at Betsitonga; Analatetina (bicolored green-rose beryls); Ambaibofo; Ampasimandrotra.¹¹ Giraud noted ore beryl in bodies at Antombakatsa (8 bodies), Ambalaniran (1), Ambohitranivo (9), Ambodiketsa (several), Manakana (33), Morafeno (4), and at Telomita.¹⁰

Lac Alaotra Region. This lake, 38 km (24 mi) long, lies 180 km (112 mi) NE of Tananarive and is surrounded by numerous pegmatite dikes, those at the NE end at Andilena, near Andranavola, being kaolinized and containing large crystals of greenish beryl. Blue and white beryl is found 2

km (1.3 mi) SE of Andreba on the road between Imerimandroso and Ambatondrazaka. A pegmatite NE of Ambatosoratra, near SE shore of lake, furnished splendid, glistening tabular twinned crystals of yellowish-greenish chrysoberyl, S of this pegmatite, 1 km (0.6 mi) SE of Ambohipasika, veins contain transparent orthoclase with green beryl.^{2, vol. 2}

Tamatave Region. Tamatave city is on the E coast, 220 km (140 mi) ENE of Tananarive. Blue beryl occurs in the valley of Ivondrona River, 30 km (19 mi) W of Tamatave; yellow beryl SE of Anivorano, 80 km (50 mi) SSW of Tananarive.^{2, vol. 2}

Ankazobe-Vohambohitra Region (see Fig. 14-36). This is an area centered about 100 km (63 mi) N of Tananarive and contiguous with Andriamena region above. A beryl-pegmatite field extends ca. 20 km (12.4 mi) from Androfia to Vohambohitra granite massif, in which beryl was found in 56 bodies and through 1959 yielded 180 metric tons of ore.¹ NE of Vohambohitra area occurs a beryl pegmatite at Anahidrano village; this may be the same mentioned by Gignes as on the "right bank of the Betsiboka River" which furnished "large clear fragments of topaz."¹¹ Lacroix stated that magnificent crystals of monazite associated with white quartz, milky blue beryl, almandine-spessartine, titanium-magnetite, biotite, etc., occurred along the right bank of this river.^{2, vol. 2} Other localities are Betsitonga, Ambatolampy, Ambodiriana, Ampitiliana, Sambotsy, Antsanatra, and Ankisatra.¹²

Ankazobe city is 62 km (39 mi) NNW of Tananarive. In the early years of this century, this was the principal beryl-producing region. Pegmatite fields are located primarily to the N, E, and SE of the city, with many bodies on the left side of Betsiboka River valley. Numerous bodies also occur between Ankazobe and Andriba village, the latter 84 km (52.3 mi) NNW of Ankazobe. Pegmatite veins are generally intercalated in altered amphibolitic schists.^{2, vol. 2} Many pegmatites occur around Bevato, 69 km (43 mi) NNE of Ankazobe, about 3 km (1.8 mi) W of Betsiboka River. At Ankijanabe and Amboasary in the valley of Ambatomaintikely stream beryl has been found. A major occurrence is at Antsahavola, just NE of Andranomielyambony village, where blue beryl occurred associated with beta-fite, citrine and amethyst, etc. An especially productive area has been around villages of Antani-

BERYL LOCALITIES

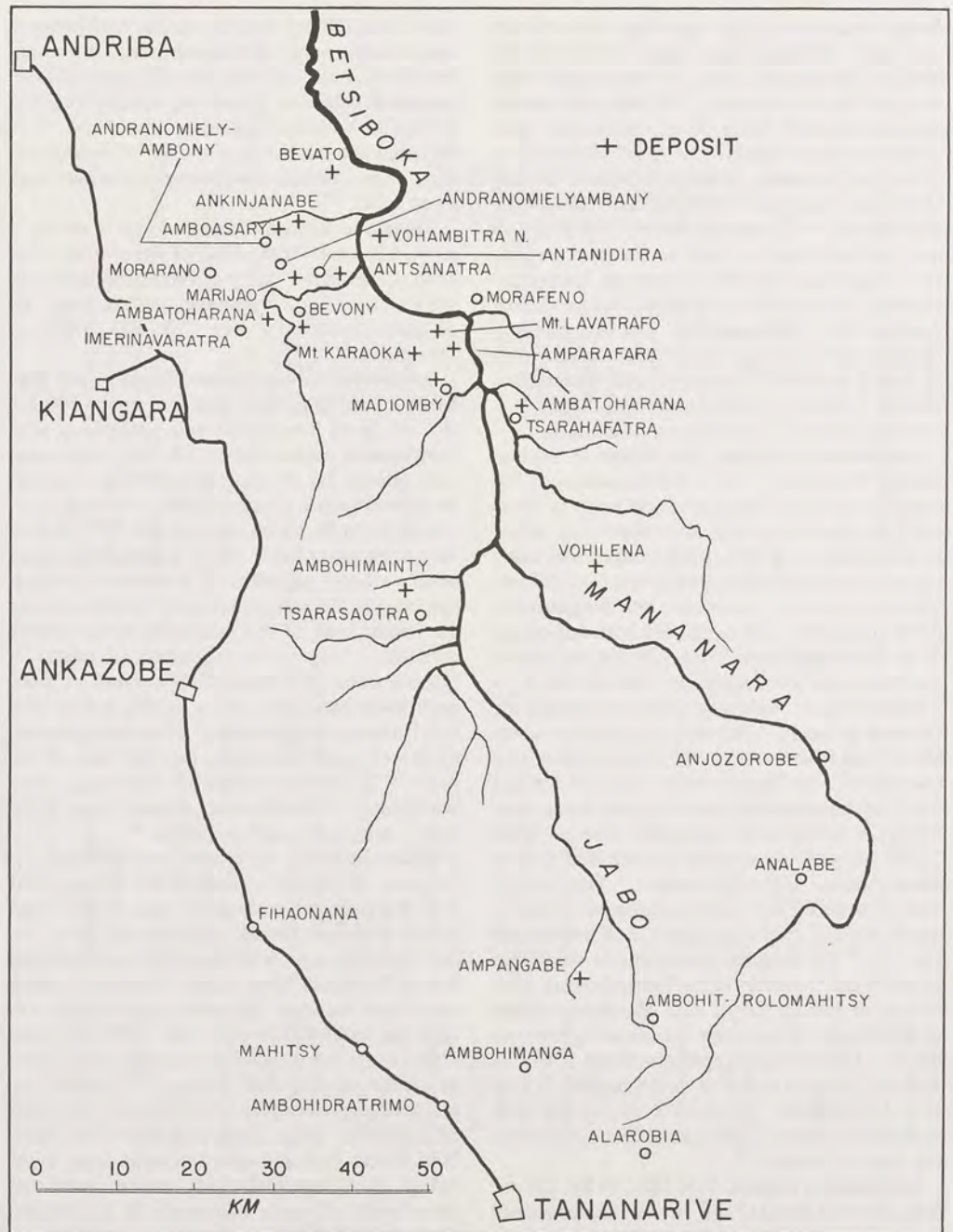

Fig. 14-36 Occurrences of gem beryl in granitic pegmatites in the Ankazobe region northwest of Tananarive. After a map of A. Lacroix, *Minéralogie de Madagascar 2* (Paris, 1922).

World Sources of Ore and Gem Beryl / Madagascar (Malagasy Republic)

ditra and Bevonny, 54 km (39 mi) NNE of Ankazobe and 29 km (18 mi) ENE of Kiangara town. At Marijao, 4 km (2.5 mi) W of Antaniditra, a beryl pegmatite was intensively worked during the early 1920's for very large prisms of bright green beryl which contained areas of transparent blue gem material; the crystals were enclosed in smoky quartz with muscovite, biotite, columbite, rock crystal and amethyst.^{2,vol. 2} According to Lautel,¹² one crystal of beryl measured 1.7×0.35 m (4.5×1.25 ft) and provided 30 kg (66 lb) of gem quality sky-blue beryl. At Ankazotsifantatra, 3 km (1.9 mi) S of Bevonny, a Mr. Krafft obtained beryls yielding 25-30 kg (55-66 lb) of gemmy material, 25% faceting grade.¹² At Ambatoharanana, 200 m (235 yd) W of Amboasirabe, 57 km (37 mi) NE of Ankazobe, a weathered pegmatite furnished clear, unblemished glassy beryl prisms of sky-blue and sea-green colors which sometimes reached diameters of 10 cm (4 in).^{2,vol. 2} E of Bevonny, beryl is found with muscovite, biotite, columbite, monazite and euxenite on Mont Antsanatra. In environs of Madiomby town, 50 km (32 mi) NE of Ankazobe, enormous crystals of blue, green, and yellow beryl are associated with monazite, garnet, and clear quartz on mountains of Lavatrafo and Amparafara.^{2,vol. 2}

Large common beryl crystals occur N of Mont Vohilena, a mountain on the right bank of Mananara River, a branch of the Betsiboka, NW of Anjozorobe town or 78 km (48 mi) E of Ankazobe.^{2,vol. 2} In Amparihibe valley near the confluence of Jabo River and two others which form the Betsiboka, beryl pegmatites exist 10-15 km (6.3-9.4 mi) W of Antanetibe village (35 km [22 mi] ESE of Ankazobe); some were exploited for gem beryl.¹¹ In pegmatites of Anjanabano and Ampamoizamaso beryl may be found associated with muscovite, chrysoberyl, fergusonite and schorl.¹³ Nearby is Miakanjovato, where pegmatite was noted by Lacroix as containing chrysoberyl intimately intergrown with beryl;^{2,vol. 2} here also exist acicular inclusions of schorl in clear quartz and large crystals of monazite, also bismuthinite, bismutite, columbite, samarskite, and ampingabeite. Beryl pegmatites occur in the Befanamo River area, E of Ankazobe, the Befanamo draining into the Betsiboka. Occurrences in this area include: S of Ampanaofolaka, E of Andranorama; gem beryl N of Andranorama, W of Befanamo, near Antsimiasy.¹¹ Beryl pegmatites are

found in the area E and NE of Maharidaza town, 22 km (14 mi) E of Ankazobe; specific sources are Ambohinierenana, Ambohitrandriana, Maroambo, Lailoza, and Kelihenjana. Large green and blue green translucent prisms have been obtained at Ambolotarafotsy. At Marivolanitra beryl is associated with chrysoberyl and columbite. A curious type occurs on Mont Miakanjovato, where rose quartz, magnificent yellow crystals of chrysoberyl, ilmenite, martite, monazite, columbite, ampingabeite, samarskite, euxenite, and bismutite occur in a complex pegmatite; the chrysoberyl is enveloped in beryl-muscovite-quartz. At Vazozo beryl is associated with monazite.^{2,vol. 2}

A famous locality is at Tsarasaotra village, 32 km (20 mi) ENE of Ankazobe, where a unique pegmatite furnished transparent gem quality yellow scapolite in addition to beryl, euxenite, and monazite. The scapolite crystals reached several cm across and displayed deeply corroded prism faces.

Lautel provided gem beryl production figures for the Ankazobe region as 87.52 kg (193 lb) for 1920 and 6.95 kg (15.5 lb) for 1950.¹² In the period from 1916-1944, a total of 1,164.5 kg (2,562 lb) of gem beryl was reported by 28 mining permit holders. The major production years were 1921-1924 and 1942. Ore beryl production during 1924-1950 was 4,320 metric tons mined by five major producers.

Tsiroanmandidy Region. The town of this name is located 146 km (92 mi) W of Tananarive. The Marosoanjo pegmatite produced several tons of ore beryl.¹³

Tananarive Region. Tananarive is the capital city, with a population of ca. 208,000. Beryl exists in granitic pegmatite at Ampangabe, 32 km (20 mi) NNW, on a small branch of Jabo River (see Fig. 14-36). At Masombahiny, 1500 m (1800 yd) E of Fieferana, or 15 km (9.5 mi) NE of Tananarive, beryl is remarkably associated with fine quality sphene crystals of several cm size which are partly altered to xanthitine. In the city beryl is found S of Pasteur Institute in a pegmatite containing microcline, blue beryl and garnet and on the hill S of the Observatory. Beryl also occurs near Amatofisaorana.^{2,vol. 2:14,15}

Lac Itasy Region. Lake Itasy, ca. 10 km (6.3 mi) across, is 74 km (47 mi) WSW of Tananarive or 16 km (10 mi) SW of Miarinarivo city. Pegmatites are numerous in a large area extending in an arc from Lake Itasy to Morafeno Village, 60

BERYL LOCALITIES

km (38 mi) SSE of the lake, thence WSW to about 50 km (31.5 mi) from the lake. In the vicinity of Ambofatsy village beryl may be found both along the banks of Isampola River, 17 km (10.6 mi) WSW of Soavinandriana and S of Lake Pilina, 18 km (11.2 mi) SW of Soavinandriana. Many beryl occurrences occur in the area 11 km (7 mi) W of Romainandro such as Fieferana; near Sahomby; at Antsahavory; Marolahy-Amerobe; Ambotofotsy; Mahatsinjo; Amboanana; Fiakarantsoa.¹⁶ Near Ambatofotsikely village along the Kitsembi River valley, 45 km (28 mi) SW of Soavinandriana, beryl and aquamarine occur. In the Ampangabe village area, 57 km (36 mi) NNW of Antsirabe, beryl is common in several bodies, sometimes as prisms in 1 m (3 ft) long;¹⁷ some have transparent gem areas in sky-blue, shades of yellow, rose, and several hues within the same crystal. In the Antonifotsy area, 1500 m (1800 yd) E of Ampangabe beryl also occurs. The Marofahitra mine, 6 km (3.8 mi) S of Miandrivo produced about 50 metric tons of ore beryl.¹³

Around Lake Vinaninony, 40 km (25 mi) NNW of Antsirabe and along Ingalena River valley, particularly around Kokonana village, 40 km (25 mi) NW of Antsirabe, are other beryl occurrences.^{2,vol.2} The area between Faratsiho and Lake Itasy is rich with many pegmatites; some produced common and gem beryls.¹³ Gem beryl near Ankondronjavatra and Marofahitra.¹ A recently discovered pegmatite at Ambalanisofotsy, N of Ankazomiriotra village, 40 km (25 mi) WNW of Betafo, produced white and rose beryls, lepidolite, green tourmaline, and much topaz, a crystal of the latter weighing 6.48 kg (14.25 lb).¹⁵

Betsiriry Region. The pegmatite area begins W at Miandrivazo city, 235 km (150 mi) WSW of Tananarive and ends about 52 km (32.5 mi) to the east near Poste Ramartina village, 108 km (67 mi) WNW of Antsirabe; noted mainly for minor production of ore beryl, about 5–6 metric tons per year.¹ Ore beryl mines occur at Ambohipihaonana, 6 km (3.8 mi) from Miandrivazo, and Ampasangoaika, 14 km (8.8 mi) SW of Mor-

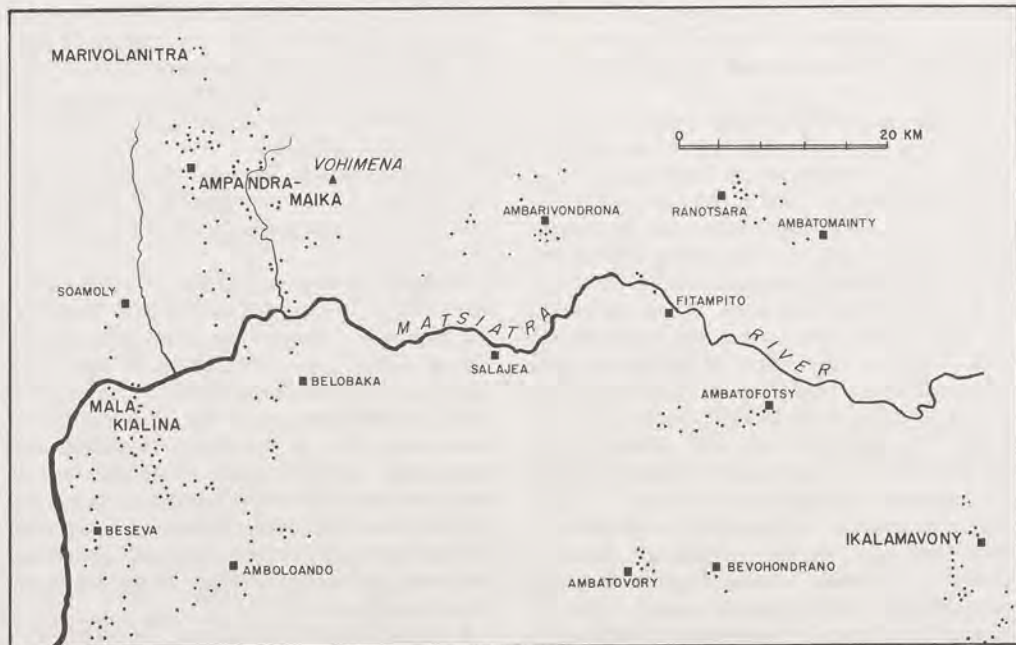

Fig. 14-37 Numerous beryl-bearing granitic pegmatites are here spotted in the region lying southwest of Tananarive (see Fig. 14-35). Most of the bodies have been exploited for ore beryl. After H. Besairie, "Gîtes minéraux de Madagascar," *Annales Géologique de Madagascar* 34 (1966).



Fig. 14-38 Gemstone granitic pegmatite localities in the Mandoto-Antsirabe region, lying southwest of Tananarive (see also Fig. 14-35). After the map of H. Besairie, "Gîtés minéraux de Madagascar," *Annales Géologiques de Madagascar* 34 (1966).

BERYL LOCALITIES

afeno. Some gem beryl has been obtained from a pegmatite group near the old gold-mining camp of Ankarongana and within a few km of the camp at Antsahamaloto, Amparikaolo, Ankaramainty, and Ambohipisaka. The beryl occurs in the weathered bodies as blue or greenish crystals. Large opaque prisms have been found 4 km (2.5 mi) S of Kiranomena and near Analaidirana.^{2,vol. 2} A newly discovered field is around Dabolava village, Morafeno.¹³

Betafo-Antsirabe Region. This is located immediately S of Lake Itasy region and includes the area S of the massif of Ankaratra to the Mania and Manandona rivers. The pegmatite region of Sahatany-Mont Ibity is treated separately. The city of Betafo is 20 km (12.5 mi) WNW of Antsirabe, while the latter is 110 km (69 mi) SSW of Tananarive. Regional rocks are granites or granitized types, with quartzites and mica schists, also the calcareous-dolomitic marbles called cipolins. Pegmatites generally are intruded conformably to the beddings of quartzites and associated cipolins, forming lenticular bodies, but some are branched and others cross cutting; lengths reach to several hundred meters. Minerals are primarily feldspar-quartz with micas, also amazonite, quartz (including rose), commonly graphic granite, and accessory tourmalines, garnets, beryl and sometimes kunzite. Many beryl pegmatites occur in the Andranomifafy River valley, a tributary of the Sahatrendrika, which in turn flows into the Onive River about 35 km (24 mi) ENE of Antsirabe.^{2,vol. 2} Beryl occurs in many bodies near Antsahalava village along right bank Sahatrendrika River. Rose quartz and beryl are found in the Mont Vohibe area, 18 km (11 mi) N of Antsirabe. A new mine at Ambondrona village, 15 km (9.4 mi) NE of Betafo was first worked in 1959 and produced beryl crystals to 5 kg (11 lb), but the average was only 50 gm.^{13,15} Common beryl occurs at Ambohimanana, 3 km (1.9 mi) S of Betafo. Many occurrences exist between Betafo and Antsirabe, especially around Antanamalaza.¹⁶ At Fefena village, 40 km (25 mi) SW of Betafo, fine green crystals have been found up to 10 cm (4 in) diameter.¹⁷ The Analava-Isakeley field SSW of Betafo includes major ore producers at Manampa, Ambondrona, and Antananofotsy; the field extends from Isakeley valley to the N to Mania River; it produced 230 metric tons through 1959 with the Ambondrona

mine accounting for 150–200 metric tons of the total.¹³ In the Anjanabonoina area, "two hours march west of Betafo,"^{2,vol. 2} a field of sodalithic pegmatites in quartzites and mica was world-famous for magnificent gem tourmalines as well as rose beryls. The latter are cesian, beautifully colored, opaque to translucent, but sometimes perfectly transparent; both the tourmalines and beryls occur in vugs.

One of the most remarkable of all gem pegmatites in Madagascar was mined at Tsaramanga village, 3 km (1.9 mi) N of Mont Itongafeno, a peak 15 km (9.4 mi) S of Betafo or 23 km (14.4 mi) SW of Antsirabe; this is the locality usually designated as "Tongafeno." A kaolinized pegmatite contained enormous rose quartz core masses with beryl occurring as large, glassy, unbroken crystals of the precious blue variety which Lacroix described as having a "blackish tint." Other colors were found also, as various shades of green and yellow, and some crystals that were blue in exterior zones but with cores of green, the latter reminiscent of the hue of emerald. Also found here were handsome groups of smoky quartz, many of the latter, as well as beryl, having been found in the outcrop.^{2,vol. 2} Duparc^{18,18a} et al. mentioned that other large pegmatite veins were uncovered in the area that were intruded into quartzites and mica schists and yielded rose quartz, mica, tourmaline and blue beryl, the last in crystals and fragments from several grams to several kilograms. The better-formed crystals of beryl displayed only faces of *m* and *c*, while many crystals were altered to clays containing clear fragments of the original crystal; some of these were tinged green, brown and greenish-brown. In a later reference Lacroix¹⁹ noted opaque beryl crystals from Itongafeno that had clear centers and were over 20 cm (8 in) long but with "fistular" zones. These were characteristically pointed hexagonal prisms with forms {39.0.39.2} and {5051} and seemed "twisted" because the pyramidal faces did not fall opposite the prism faces. In 1952 Guigues reported on Concession 393 Robert at Itongafeno, located 5 km (3.2 mi) SSE of Mahaiza village, at the N foot of the mountain, where beautiful blue, green, and yellow beryls were being mined at the time.¹⁶

Duparc et al. provided the following data on a blue Itongafeno beryl and optical data on beryls from other Madagascar sources:¹⁸

World Sources of Ore and Gem Beryl / Madagascar (Malagasy Republic)

Table 14-35
PROPERTY DATA ON SOME MADAGASCAR BERYLS¹⁸

Locality	Color	Mean G.	<i>o</i>	<i>e</i>	Diff.
Tzilaisina	Rose	2.7165	1.5747	1.5830	0.0083
Tsaravovona	Rose	2.7027	1.5725	1.5782	0.0057
Antaboko	Blue	2.7477	1.5819	1.5897	0.0077
Tetehina	Blue	2.7116	1.5748	1.5818	0.0070
Ambatolampy	Blue	2.7192	1.5752	1.5838	0.0086
Itongafeno	Blue	2.7379	1.5771	1.5849	0.0078
Itongafeno ^a	Blue	2.739	1.58497	1.57709	0.00788

^aUniaxial (-), $2e=8^{\circ}42'$; dichroism *o*=pale blue, yellowish; *e*= blue.

A large pegmatite body on the SE flank of Mont Tsaravovona, 30 km (19 mi) SE of Betafo, produced rose beryl crystals up to several kg weight from outcrop detritus. Duparc et al. recorded a 49.105 carat cut gem from this material which was "absolutely clean" (properties are given in table 14-35). At Antaboko, in the environs of Mandrarivo village, 12 km (7.5 mi) SW of Antsirabe, a large body intruded into

quartzite was famous for its abundance of vugs containing large amazonite crystals, quartz crystals, and rubellite crystals, and also pale to medium blue prismatic beryl crystals, many of which were altered to clay but contained fragments of clear material, some also multicolored. Forms were *m* and *c*; strongly dichroic in pale blue and blue; a cut gem of a little over 10 carats gave the properties shown in table 14-35.

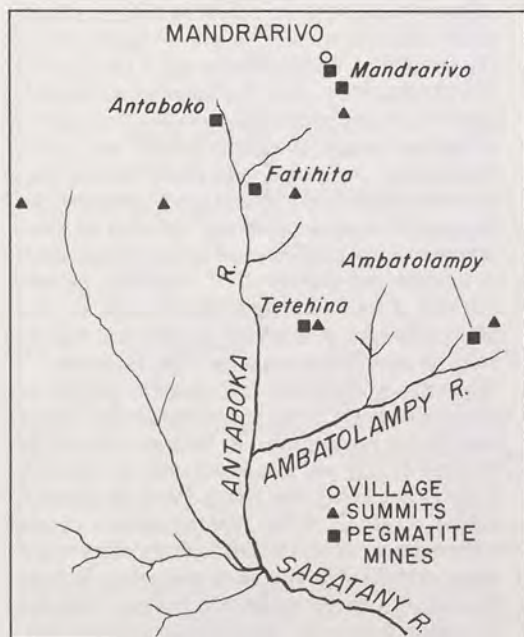

Fig. 14-39 Sketch map showing locations of gem-bearing granitic pegmatites in the vicinity of Mandrarivo. After L. Duparc et al, Les minéraux des pegmatites des environs d'Antsirabé à Madagascar, *Mémoires de la Société de Physique et d'Histoire Naturelle de Genève* 36 (1910).

BERYL LOCALITIES

Common beryl occurs at Manendrika village, 11 km (7 mi) S of Antsirabe and is abundant in the area Mahaiza-Vinaninkarena, 9 km (5.7 mi) S of Antsirabe.¹⁶ In the same area, Lacroix mentioned that a three hour march S of Mahaiza brought one to pegmatites containing blue beryl, some as small crystals, near Samiresy village a little E of Lake Tritiva.^{2,vol. 2} Around Antanananlaza village, SE of Lake Andranobe, 13 km (8 mi) SSE of Antsirabe, beautiful beryl crystals occurred with rose quartz. In the same area on Mont Tsaramanga some bodies contained vugs in the rose quartz with beryl-shaped cavities to several decimeters in diameter marking places where beryl crystals had been dissolved. Large crystals occur on flanks of Mont Vorondolo, SE of Antsirabe; also in the vicinity of Ambodifiakarana village, 40 km (25 mi) SE of Antsirabe.

Sahatany River Valley-Mont Ibity (or Bity) Region. This area lies generally S-SW of city of Vinaninkarena, the latter 8 km (5 mi) S of Antsirabe. It is enclosed by the watershed of Sahatany River on the W and Manandona River on E and S, where the latter changes course to WSW (see fig. 14-40). The sinuous Sahatany River valley is about 20 km (12.5 mi) long and is about 5 km (3.2 mi) W of the Mont Ibity massif. The entire region is dotted with granitic pegmatites, many productive of beryl and other rare or gem minerals. Fine blue beryl occurs near Mandriharivo village, 12 km (7.5 mi) WSW of Vinaninkarena, and just N at Antaboaka village. From this area Duparc et al. mentioned a rose beryl crystal of 25 kg (55 lb) which furnished beautiful cut stones,¹⁸ while Lacroix described dark blue beryl, also fine rose and white beryls, all in large crystals.^{2,vol. 2} Similar beryls were found associated with fine red tourmaline crystals in sodalithic pegmatite near Antaboaka; sometimes they enclosed small blue tourmaline crystals. At Antsofimbato, 2 km (1.25 mi) NE of Antaboaka, rose beryl and multicolored tourmalines are found in sodalithic pegmatite.¹⁶ According to Saint Ours, four bodies produced several tons of ore beryl in 1959.¹³ Around Ambatodidy, ore beryl was also produced, according to Murdock, but mainly gem beryl was obtained clandestinely.¹

At Tetehina (or Tetehana) village, 12 km (7.5 mi) SW of Vinaninkarena, a completely kaolinized body in gneissic granite was mined for altered prisms of blue green gem beryl; a cut gem

of 7.77 carats was used for the data in table 14-35. This gem displayed strong dichroism in sky-blue and colorless. A similar body at Ambatolampy village, ca. 2 km (1.25) mi ENE of Tetehina furnished beryl crystals to 60 cm (23.5 in) long associated with quartz and feldspar; forms *c* and *m*; color clear sky-blue with traces of green; dichroism very pale blue and sky-blue. Clean cut gems of 8.3751, 17.8849, and 16.3207 gm gave corresponding values of *G*, as 2.7192, 2.7180, and 2.7162; see table 14-35 for refractive indices.

On the flanks of Mont Tsiandaiza and near Ambohitvorano village, 14 km (8.8 mi) SW of Vinaninkarena, there are a number of productive bodies. On Mont Vohimasina's flanks, 12.5 km (7.8 mi) SW of Vinaninkarena, a large sodalithic body in gneissic granite provided peculiar crystals in which cores were rose but the outer zones green.^{2,vol. 2,20} Rose beryls and colored tourmalines occur at Andriamainty; at Mont Ampantsikahitra, 16 km (10 mi) SW of Vinaninkarena, rose beryl with rubellite.²⁰ Behier reported a recently discovered body at Ankararivo that produced several kg of white and rose crystals associated with blue topaz and lepidolite in sodalithic pegmatite.¹⁵

The celebrated locality of Maharitra includes a group of sodalithic bodies along Sahatany River valley centered around Maharitra village, 16 km (10 mi) SW of Vinaninkarena and 7 km (4.4 mi) NW of Mont Ibity. They are famous for splendid, colored, gemmy tourmalines and large rose beryls of flattened shape, along with kunzite and yellow spodumene, lepidolite, and rarely hambergite, danburite and bityite. Several km W of Marahitra, pegmatites emplaced along contacts of mica schists and cipolins furnished magnificent crystals of rubellite and rose beryl.^{2,vol. 2} In 1908, Lacroix mentioned that rose beryl was recovered from Mont Ibity area in "surface deposits and that the color is rapidly removed by heat treatment."²¹ The beryl is alkali-rich and characterized by an absence of prism faces and predominance of the basal face *c* accompanied by brilliant faces of the pyramid {1121} and also commonly the pyramid {3364}, but rarely the rough faces of pyramid {3141}. Crystals of this type sometimes exceed a diameter of 10 cm (4 in) and are often transparent with a lively salmon or rose color. At times they are also opaque white with tinges of carmine. Corrosion figures on basal faces are usually hex-

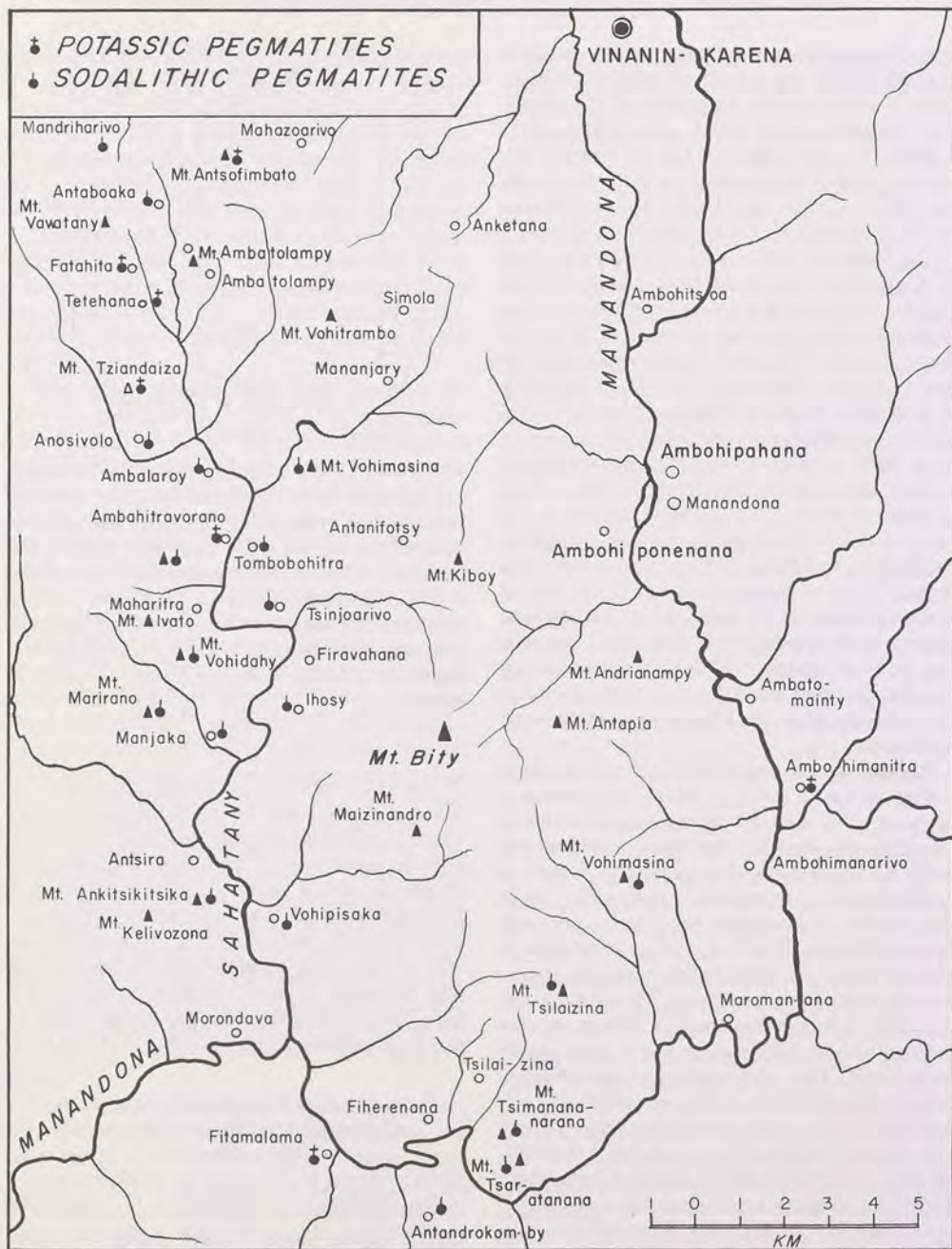

Fig. 14-40 Numerous granitic pegmatites famous for gem beryls and other gemstones spotted in the Sahatany River-Mount Bity (or Ibity) region south-southwest of Tananarive. After a map by A. Lacroix in his *Minéralogie de Madagascar* 2 (Paris, 1922).

World Sources of Ore and Gem Beryl / Madagascar (Malagasy Republic)

{20 $\bar{2}$ 1}, {33 $\bar{6}$ 5}, and {40 $\bar{4}$ 5}.¹⁷ Such crystals commonly contain cores of yellow cats-eye material from which excellent quality cabochons may be cut, one of which, a 44 carat gem, is in the National Museum of Natural History in Washington, D.C. Saint Ours¹³ and Murdock¹ refer to this field as "Vorondolo" and mention beryl pegmatites on the flanks of Mont Ambohimanita at the confluence of Sahanivotry and Manandona rivers which produced 25 metric tons of ore beryl. Rose quartz and beryl occur near Befotaka, S of Sahanivotry River on the right bank of Analavahady River.

Ambositra Region. This area lies S of the above region, across the Mania River and tributary Manandona River. The city of Ambositra is 85 km (52 mi) SSE of Antsirabe. Near Antandrakomby village may be found pink and green beryl, rubellite, spodumene and rhodizite; pink beryl gave $G = 2.82-2.85$.^{2,vol. 2:20} Some gem grade aquamarine occurs at Ifempina and Tsimanahy, 10 km (6.2 mi) N of Ambositra and at Soavina village, 38 km (24 mi) NNW of Ambositra. Beryl occurs at Ambolo, Bebaranga, Andrarato, and Fiherenana in Ambatofinandrahana area, 44 km (27.5 mi) W of Ambositra where ore beryl was recently recovered.^{1,13,20} At Andranolava, 9 km (5.6 mi) SSE of Ambatofinandrahana, blue beryl with colored tourmaline occurs. In Itia area at Tsilany, SW of Ambositra, there is blue beryl,²⁰ which also occurs at Ambatomainty and Fenoarivo, the latter 50 km (31 mi) SW of Ambositra.^{2,vol. 2} To the E of Ambositra, beryl is common in bodies in mica schists and quartzites along Ifempina River, a feeder of Sahanofa River. Near Antoetra village, 28 km (17.5 mi) SSE of Ambositra, beryl occurs in pegmatite near Ankarenanan 8 km (5 mi) N of Antoetra and elsewhere in the vicinity.²⁰ Near Ambodimanga village, 50 km (31 mi) SE of Ambositra, gem beryl is found.²²

Mananjary-Ifanadiana Region. Ifanadiana city is 72 km (45 mi) W of Mananjary city, the latter on the E coast of the island at the outlet of Mananjary River or about 250 km (157 mi) SE of Tananarive. An occurrence of emerald was reported at a place about 50 km (31 mi) WSW of Mananjary to the S of the granite massif of Analatsitevena. Small waterworn fragments accompanied by kyanite were found by a prospector in alluvium. Behier examined several grams of gem quality, and reported that while a pegmatite was

noted by the prospector, no emerald was found in it. This appears to be the only authentic source of emerald in Madagascar.¹⁵

Ampandramaika-Malakialina Region (see fig. 14-37). An area that lies along a N-S axis between Janjina and Mandrosonoro villages, 125 km (79 mi) W of Ambositra (on the north) and the junction of Mantsahala and Matsiatra rivers, 152 km (100 mi) WSW of Ambositra (on the south). Lacroix mentioned beryl occurrences in an area S-SE of Janjina and S to Matsiatra River, also along valleys of the streams Imahatodika, Mananbaroa, Mitody, Ampandramaika, and Manantsahala, all of which flow into the right (N) side of the Matsiatra.^{2,vol. 2} On Mont Ambatofotsy, S of Ampandramaika, enormous beryl crystals are associated with ilmenite.^{2,vol. 2} Recently ore beryl was mined in Ampandramaika from the Ampandramaika I and Marovolonitra mines, which produced 600 metric tons through 1959 from open-cuts.¹ Saint Ours mentioned ore beryl mines at Vohimara No. 8 and Soamaly;¹³ ore production figures given by Besairie up to 1960 show that the Ampandramaika I produced 143 metric tons and the Marovoloanitra 287 metric tons.⁷ Guigues noted that topaz occurred in some of these bodies.¹¹ The Malakialina group of pegmatites, 30 km (19 mi) SW of Ampandramaika town, were exploited for ore beryl from 1949 onward. Mine A.4 produced 1,770 metric tons by the end of 1962;^{7,23} crystals reached 2 m (6 ft) in diameter and several meters long. One enormous prism was 13 m (44 ft) long and 1.5-2 m (3-6 ft) in diameter; a total of 118 yellowish ore beryl prisms of similar diameter were uncovered.¹³ Pegmatite bodies here were mapped by Besairie.^{24,map 16}

Fianarantsoa Region. This city is 99 km (69 mi) S of Ambositra or 272 km (172 mi) S of Tananarive. Common beryl occurs in crystals to 100 kg (220 lb) on Mont Vohimena, 6 km (3.7 mi) N of Ikalamavony village, the latter 56 km (35 mi) WNW of Fianarantsoa. Near Ikalamavony, bodies at Maseza contain clear blue and green crystals in rose quartz. Beryl occurs in pegmatites on the right bank of Mananantanana River near Solila, 48 km (30 mi) W of Fianarantsoa, and to the W along the Iafu River between Solila and Ambalavao, 43 km (27 mi) SW of Fianarantsoa; also at Andravandahy.^{2,vol. 2} Beryl is also found NE of Farihitsara village, near Moranao, and at Ranomainty, a branch of the Matsiatra River SE of Fianarantsoa.²⁰

BERYL LOCALITIES

Bekisopa Region. A village 118 km (73 mi) WSW of Fianarantsoa near the N bank of the Zomandao River, or 82 km (51 mi) NNW of Ihosy city. NE of Bekisopa, a sodalitic pegmatite produced large crystals of rose beryl associated with large crystals of colored tourmaline, clear quartz, and cleavelandite from vugs.¹⁵

Farafangana Region. A city on the SE coast of the island, 170 km (107 mi) S of Manajary city. Damour gave a vague locality at Farafangana,²⁵ which Lacroix claimed as identical to Farafangana, a locality for rose beryl of gem quality.^{2,vol. 2}

Ejeda Region. This town is near the S end of island, 43 km (26.5 mi) NW of Ampanihy city; beryl occurs in pegmatites N of the town, also N of nearby Iandara and E of Ampanihy, at the last place in large crystals.^{2,vol. 2}

- Murdock, T. G. 1963. Mineral resources of the Malagasy Republic. *U.S. Bureau of Mines Information Circular* 8196. 147 pp.
- Lacroix, A. 1922-1923. *Minéralogie de Madagascar*. 3 vols. Paris: Augustin Challamel. 624, 694, 450 pp.
- Lavila, L. 1923. L'industrie des pierres précieuses à Madagascar. *Bulletin des Mines de Madagascar* no. 8, (Tananarive), pp. 138-42.
- Dumas, M. 1924. Sur le gisement de béryl d'Ambatofisaorana (Madagascar). *Bulletin de la Société Française de Minéralogie* 47:172-3.
- Lacroix, A. 1913. A trip to Madagascar, the country of beryls. *Annual Report, Smithsonian Institution for 1912*, pp. 371-82.
- Kunz, G. F. 1911. Precious stones. Chapter in *The Mineral Industry during 1910*. Vol. 19. New York: McGraw-Hill Book Co. 27 pp.
- Besairie, H. 1961. Les ressources minérales de Madagascar. *Annales Géologiques de Madagascar* (Tananarive) fasc. 30, 116 pp.
- Giraud, P. 1957. Le champ pegmatitique de Berere à Madagascar. [With discussion.] *Comm. Tech. Co-Op. Africa South of Sahara, East-Central South. Reg. Comm. Geol. Meeting 2, Tananarive, 1957, Proceedings*, pp. 79-86.
- Brière, Y. 1929. Notes sur quelques minéraux malgaches. *Bull. de la Soc. Franç. de Min.* 52:85-88.
- Giraud, P. 1956. Prospection des pegmatites et des gisements de chromite de la région Andriamena-Mankana. *Travaux de Bureau Géologique, Service Géologique de Madagascar et Dépendances* (Tananarive) vol. 74, 32 pp.
- Guigues, J. 1955. Étude des gisements de pegmatite de Madagascar. *Travaux de Bureau Géol., Service Géol. de Madagascar et Dép.*, vol. 67, 26 pp.
- Lautel, R. 1952. Étude géologique des feuilles Anjozorobe-Ankazobe. *Travaux de Bureau Géol., Service Géol. de Madagascar et Dép.*, vol. 29, 76 pp.
- Saint Ours, J. de 1960. Étude générale des pegmatites. *Rapport Annuel du Service Géologique de République Malgache* (Tananarive) pp. 73-87.
- Laplaine, L. 1952. Étude géologique des feuilles Miarinarivo et Tananarive Campagne 1951. *Travaux de Bureau Géol., Service Géol. de Madagascar et Dép.*, vol. 32, 73 pp.
- Behier, J. 1962. Travaux minéralogiques. *Rapport Ann. du Serv. Géol. de Republ. Malgache* pp. 253-66.
- Guigues, J. 1952. Étude géologique des feuilles Antsirabe-Ambatolampy. *Travaux de Bureau, Géol., Service Géol. de Madagascar et Dép.* vol. 28, 123 p.
- Ungemach, M. H. 1916. Contribution à la minéralogie de Madagascar. *Bull. de la Soc. Franç. de Min.* 39:5-38.
- Duparc, L., Wunder, M., and Sabot, R. 1910. Contribution à la connaissance des minéraux et des pegmatites de Madagascar. Note sur le béryl de divers gisements situés dans les environs d'Antsirabé. *Bull. de Soc. Franç. de Min.* 33:53-67.
- 18a. ———. 1910. Les minéraux des pegmatites des environs d'Antsirabé à Madagascar. *Mémoires de la Société de Physique et d'Histoire Naturelle de Genève* 36:283-410.
- Lacroix, A. 1914. Sur quelques déformations des cristaux de betafite et de béryl. *Bull. de Soc. Franç. de Min.* 37:101-7.
- Emberger, A. 1952. Étude géologique de la feuille Ambositra. *Travaux de Bureau Géol., Service Géol. de Madagascar et Dép.*, v. 31, 116 p.
- Lacroix, A. 1908. Les minéraux des filons de pegmatite à tourmaline lithique de Madagascar. *Bull. de Soc. Franç. de Min.* 31:218-47.
- Boulanger, J. 1952. Étude géologique de la feuille Ampasinambo. *Travaux de Bureau Géol., Service Géol. de Madagascar et Dép.*, v. 36, 92 p.
- Frere, G. 1963. La pegmatite à béryl et columbite A-4 de Malakialina à Madagascar. *Compte Rendu de Semaine Géologique 1963. Annales Géologiques de Madagascar*, fasc. 33, pp. 225-6.
- Besairie, H. 1966. Gîtes minéraux de Madagascar. *Annales Géologiques de Madagascar*, fasc. 34, 93 maps.
- Damour, A. 1886. Note sur un béryl provenant de Madagascar. *Bull. de Soc. Franç. de Min.* 9:153-4.

MALAWI (Nyasaland)

Beryl has been found in isolated crystals in a quartz vein in Nkata Bay lake shore area, and in alluvium near Lulwe Mission in the extreme S end of the Port Herald district.

MEXICO

Baja California

The same batholith that in Southern California contains so many mineralogically interesting granitic pegmatites crosses southward across the border into this state and continues in this direction for many hundreds of kilometers. The paucity of known pegmatite occurrences is due not so much to absence of favorably mineralized bod-

World Sources of Ore and Gem Beryl / Mongolian Republic

ies as it is to lack of access and exploration. During 1960–1970, a number of complex pegmatites were found and exploited in Baja California Norte, largely by teams of mineral collectors from the United States.

The earliest reference to beryl is a vague one by Flores and Gonzalez in 1912,¹ followed by one by Wittich,² who in 1914 stated that this species had been found in the Sierra de San Pedro Mártir, the highest range of mountains in the peninsula. In the early 1960s a swarm of small pegmatites of vein-like form were found just N of Route 2 at a place called La Jollita, about 40 km (25 mi) E of Tecate and very close to the border of the United States. Small amounts of blue topaz, smoky quartz crystals, apatite, green tourmaline, and golden beryl, the latter in much corroded crystals, were found.

Sinkankas reported other occurrences: gemmy aquamarine and golden beryl in small prismatic crystals from small vugs in a granitic pegmatite near El Mesquite village, about 27 km (17 mi) S of El Condor turnoff from Highway 2 (El Condor is ca. 49 km [30.6 mi] E of Tecate).³ The pegmatite occurs between Jasay and El Topo and is mineralogically simple, consisting largely of feldspar with some quartz, schorl, mica, rare purplish apatite, albite, and euhedral prisms of pale greenish yellow to pale golden-yellow beryl, ranging from acicular to some about 7 mm (0.5 in) in diameter and to 77 mm (3 in) long. Some are smooth-faced, others etched and tapered like the crystal depicted in fig. 9-7. Most contain abundant inclusions of extremely small size which render the bases opaque or only translucent but in a sharp transition; these disappear toward the terminations, the latter then being transparent. A similar body yielding the same type of crystals was found in barren hills immediately S of Jacumba, a town in the United States close to the Mexican border. Some beryl also occurs in complex pegmatites, which yielded colored tourmaline, topaz, and quartz in the Alamo-Rancho Viejo area as described by Sinkankas (p. 18 ff).³

Sonora

Crystals in pegmatite dikes on Sierra de Oposura, Municipio de Moctezuma, range up to 10 × 5 cm (4 × 2 in) in size; the bodies consist largely of feldspar with much schorl, some biotite, scheelite and little beryl.^{4,5}

San Luis Potosí

Beryl was reported from a ravine branching from Arroyo de Los Arcosin, Guadalcázar district as blue green prisms to 1 cm (0.4 in) in pegmatite.⁶ Jones reported small terminated aquamarine crystals not over 1 cm (0.5 in) in thin granitic pegmatite veins in the granite stock known as Cerro de San Cristobal, just S of Rancho Realejo near Guadalcázar; the locality is ca. 95 km (60 mi) NE of the city.⁷ Pegmatite veins with beryl are also mentioned by Foshag and Fries.⁸

Oaxaca

Granitic pegmatites, some beryl-bearing, occur near Santa Ana, Municipio de San Francisco Telixtlahuaca, about 39 km (24.5 mi) from Oaxaca city.⁹ The bodies are largely feldspar and quartz with accessory beryl, tourmaline, spodumene, ilmenite, allanite, and several rare species.

1. Flores, T., and Gonzalez, P. 1912. Las erupciones y diques pegmatíticos de la Sierra de San Pedro Mártir. *Sociedad Geológica Mexicana, B. C. Acta de la Asamblea General 19 Enero*, Mexico D.F.
2. Wittich, E. 1914. [Occurrence of precious stones in the peninsula of Lower California]. *Centralblatt für Mineralogie* (Stuttgart) pp. 449–56.
3. Sinkankas, J. 1976. *Gemstones of North America*, Vol. 1. New York: Van Nostrand Reinhold Co. 494 pp.
4. Santillan, M. 1933. Berilo y berilio en Mexico. *International Geological Congress, 16th Annual Meeting, Washington, D.C., abstracts*, pp. 65–6.
5. Reyna, J. G. 1956. Riqueza minera y yacimientos minerales de Mexico. *Congreso Geológico Internacional, XX Sesión, Mexico 1956*, 3rd ed. pp. 331–2.
6. Wittich, E., & Kratzert, J. 1922. Cenizas volcánicas de vidrio y de cuarzo en los placeres de Guadalcázar. S.L.P. *Memorias y Revistas de la Sociedad Científica "Antonio Alzate"* (Mexico) pp. 655–61.
7. Jones, W. 1962. The Guadalcázar–Realejo collecting area. *Lapidary Journal* 16:282–3.
8. Foshag, W. F., and Fries, C. 1942. Tin deposits of the Republic of Mexico. *U. S. Geological Survey Bulletin* 935-C, pp. 107–17.
9. Reyna, J. G. 1960. Las pegmatitas graníticas de Santa Ana, Telixtlahuaca, Oaxaca, México. *International Geological Congress, Reports of 21st Session, Norden 1960*. Part 17: Proceedings, pp. 63–76.

MONGOLIAN REPUBLIC

Krianovski described granitic pegmatites containing miarolitic cavities in which occurred fine crystals of topaz, quartz (up to 2 m [6 ft]), beryl, and other species, from a region about 40 km (25 mi) W of Urga on Gorikho River, NE of Ulan Bator. These occurrences were said to have much in common with those of Adun Chilon Moun-

BERYL LOCALITIES

tains, Transbaikalia, USSR, q.v. Species include quartz, smoky quartz, amethyst, microcline perthite, albite, biotite, garnet, muscovite, magnetite, zircon, allanite, tourmaline, cassiterite, fluorite, hematite, lepidolite, zinnwaldite, samarskite and various phosphate species among others. Especially large and fine were crystals of topaz, beryl, and fluorite, not to mention the several varieties of quartz.

1. Krianovski, V. 1925. Sur les pegmatites des environs d'Urga en Mongolie. *Compte Rendu de l'Academie des Sciences de l'URSS (Leningrad)* pp. 13-16.

MOROCCO (French Morocco)

Beryl occurs very sparingly in tin-tungsten veins on the W edge of Middle Atlas Mountains, 130 km (75 mi) E of Casablanca near Oulmès.^{1,2} The veins are almost entirely quartz and contain small amounts of mica, tourmaline, cassiterite, wolframite, ferberite, scheelite and rarely beryl.

Beryl occurs in central Morocco in pegmatite bodies intruded into Precambrian rocks of the Anti-Atlas Mountains ca. 150 km (95 mi) SSE of Marrakech; the largest bodies are in schists adjacent to granite masses, some reaching several hundred meters.³ Around Plaine Tazenakht, pegmatite swarms outcrop at Angarf-Sud and Ifenouane, also in the center and NE of the plain.² In SW part of the plain, many beryl-bearing pegmatite bodies occur in the Boutonniere d'Iguerda district, at Agadir-Jdid and L'Azarar.⁴ Some beryl crystals from Angarf-Sud reached 100 kg (220 lb).⁵ Other localities are at D'Adrar, 2 km (1.25 mi) S of Angarf-Sud, Tazeroualt SE of Tiznit, and Trafout, the last two deposits also containing cassiterite. Angarf-Sud was opened for ore beryl in 1952 and produced 450 tons; D'Adrar provided 8 tons and the D'Aguerda body and some others a total of 6 tons. As of January 1961, all beryl pegmatites in the region furnished a total of 528 tons.⁴ No gem beryl was found.

1. Heck, E. T. 1946. Tin and tungsten deposits of French Morocco. *Economic Geology* (Lancaster, Pa.) 44:383-9.
2. Morin, P. 1952. Mica et béryl. *Géologie des Gîtes Minéraux Marocains. Service Géologique du Maroc Mémoire* 87:337-46.
3. Bouladon, J.; Jouravsky, G.; and Morin, P. 1950. Étude préliminaire des pegmatites a muscovite et béryl de sud de la plaine de Tazenakt (Maroc). *Service Géologique du Maroc Mémoire* 76:207-35.
4. Jouravsky, G., and Destombes, J. 1961. Les différents types de minéralisations de l'Anti-Atlas. Leur cadre géologique et les méthodes de leur prospection. *Mines et Géologie, Bulletin trimestrial de Direction des Mines*

et de la Géologie, Royaume du Maroc, 1961, no. 13, prem. trimestre 1961, pp. 19-57.

5. Gaudefroy, C. 1955. Description provisoire des espèces minérales du Maroc - IV. *Service Géologique du Maroc, Notes et Mémoires* 125:154-5.

MOZAMBIQUE

Numerous granitic pegmatites occur principally in central and N-central Zambésia Province and extend into SW portion of Moçambique Province.¹ This region is about 370 km (230 mi) WSW of seacoast city of Moçambique.² A smaller district is near Nova Freixo (Cuamba) in S Niassa Province.³ In the first mentioned region, granitic pegmatites intrude Precambrian gneisses and metasediments, also younger granites, but only those bodies occurring outside the granites are economically important.⁴ Bodies range from 1 m (3 ft) to 400 m (1200 ft) in width and up to 1200 m (3600 ft) long, as at Muiâne. Many are deeply kaolinized; larger bodies are well zoned; simple and complex pegmatites occur, the lithium-bearing ones being remarkably like similar bodies in New England, South Dakota, and Pala, California.²

Alto Ligonha. The "alto" or plateau is located ca. 260 km (165 mi) WSW of Moçambique city and averages 450 m (1480 ft) above sea level. Pegmatites outcrop in a zone several km wide around granitic intrusives as at Entata, located in the triangle formed between the Namiroe and Metuisse rivers. The bodies strike radially from the granite masses.⁵ The Muiâne body, the best known, was mined by Empresa Mineira do Alto Ligonha in a quarry where the dike-like body is 40 m (130 ft) wide. Its length is inferred at 1200 m (3600 ft). Enclosing rocks are gneisses or amphibole schists. It is well zoned and contains large masses of lepidolite in its upper portion, also large quartz crystals, sometimes in fine specimens to 900 kg (1980 lb); several feldspars, muscovite, spodumene, garnet, tourmaline (some polychrome), topaz sometimes in fine crystals, zircon, various rare element species, phosphates, sulfides, etc. Guillemin recorded a crystal of rubellite of 25 cm (10 in) long, also colored tourmalines that were "perfectly transparent, blue and violet."⁶ An extremely large multiple-growth rubellite crystal, ca. 50 cm (15 in) long, is believed to have come from this body and is now in the U.S. National Museum, Washington, D.C.

The beryls of the Muiâne pegmatite are outstanding in every way and occur in white, green,

World Sources of Ore and Gem Beryl / Mozambique



Fig. 14-42 Complex pegmatite fields of Mozambique. 1. Namalalo, 2. Namagoa, 3. Igaro, 4. Maoloa, 5. Cunheia, 6. Maria, 7. Ginama, 8. Ildo, 9. Morrua, 10. Maria I., 11. Malolo, 12. Conco, 13. Munhamola, 14. Nacaca, 15. Namivo, 16. Muiâne, 17. Becota, 18. Nihire, 19. Mirricui, 20. Muepe, 21. Muirre, 22. Bôa Esperança 23. Monapo I., 24. Monapo II., 25. Monapo III., 26. Tulua, 27. Baessa. Numbers 16–21 in the Alto Ligonha field. After J. M. Correia Neves et al., "Mineralogy and Structure of Some Pegmatites from Mozambique," *Revista da Faculdade Ciencias Universidade Lisboa* (1972) p. 111.

yellow, blue, and more rarely, in colorless and rose crystals. A peculiar black beryl was also found, displaying a pyramidal habit due to development of faces of $\{4041\}$; its color is attributed to numerous inclusions.⁷ Behier, in describing beryl specimens in the Museu Freire d'Andrade, stated that they are basically aquamarine, the black "probably due to manganese as in the case of the beryls from Bevaondrano, Madagascar."¹³ Bettencourt noted black beryl from Maridge, Naípa, Muhano, and Nahora in Mozambique.⁷ Beryls occur mainly in perthite intermediate zones as perfect crystals or irregular masses that range in weight from a few grams to almost 900 kg (1980 lb). It is also found next to core quartz and in intermediate zones of quartz with plumose mica.

In respect to size of beryl crystals, Mitchell

mentioned one exposed in the quarry wall that was 244 cm (8 ft) in diameter and extended "many yards" into the pegmatite.⁸ Gemmy beryls are much smaller, and in the larger crystals, only small clear areas are found. Forms: principally $\{0001\}$, $\{1010\}$, and $\{11\bar{2}1\}$, less commonly $\{5160\}$ and $\{3031\}$. The splendid rose-violet crystals, generally tabular in habit and unusually transparent, display c , m and $\{10\bar{1}1\}$, $\{11\bar{2}1\}$, $\{2131\}$, less commonly $\{3141\}$ and rarely $\{1122\}$ and $\{1.0.\bar{1}.12\}$. Rose-salmon crystals, often severely corroded, are very clear, usually tabular on c , and while rich in other forms, are smooth only on c -faces. Some individuals of the latter variety are truly enormous, as for example a crystal fragment that weighed 7 kg (15.5 lb) which Guillemin estimated to be only one-seventh of the original, or making the complete crystal about 50

BERYL LOCALITIES

kg (110 lb).⁶ Another rose beryl was 25 cm (10 in) in diameter and 9 cm (3.5 in) thick with "perfect" faces. The black crystals previously referred to are sometimes zoned with cores of black material surrounded by green beryl, or the center and exterior may be white or green with an intermediate zone of black.⁴ Apparently gem aquamarine is not abundant, but Behier mentioned a fragment of 45 × 25 cm (17.6 × 10 in) as an exception.³ Others were smaller and "better formed," in part of "fine blue gem of jewelry gems."

In his visit to this district in 1949, Bandy noted that ore beryl was produced from at least seven bodies for a total of over 100 tons.⁹ "The crystals occur isolated and in pockets in the feldspar along the feldspar-quartz core contacts. Some are three feet [1 m] in diameter and 24 inches [60 cm] long. These are usually a mottled green color and the degree of opacity varies from place to place . . . an unknown quantity of gem beryl of light shades has been produced and sold to lapidaries in South Africa. Some of the gem material is found in the core of large crystals . . . approximately 60% of the gem material is aquamarine, the remainder morganite, golden, colorless, black or dark blue, and several fancy shades. Some is pleasing cream or pale ecru tint. In general the shades are not deep. A crystal of non-gem quality morganite from Muiâne with sharp faces and of a fine deep color 3 inches [8 cm] in diameter and 2 inches [5 cm] high is now in the U.S. National Museum."⁹ In respect to black beryls, Bandy noted that "the crystals of black or deep blue color are characteristically deeply corroded and often coated with a zone of white alteration. All of the deeply corroded crystals observed tapered to a point."⁹

Aside from the Muiâne body, principal beryl producers are clustered around the Entata granite intrusive: Nanro, Nacuissapa, Murrupane, Mirruchi, Nihere, Mirracui, Nahia, Piteia, Injela, Maridge, Naípa, Namacotcha, Murropoci, Najamele, Mtomiti, Nuaparra, Boã Esperança, Naimiparra, Munhamola, Namivo, and Morrui.^{1,5,10} The Naípa body is emplaced in gneissic granite and is remarkable for containing large masses of finely crystallized lepidolite. Associated species include tourmaline, sometimes of gem quality, muscovite, lithium minerals, and beryl, the latter fractured, however, and rarely transparent.¹ At Itaia, beryl occurs in granitic pegmatites. A body

at Colina yielded 40 tons of ore crystals in which aquamarine types occurred in the proportion 1:1,000. The Murrupane body yielded some ore beryl but was mainly noted for its ruby muscovite. The Nahia pegmatite contained enormous white apatite crystals up to 30.5 cm (12 in) in diameter and 15 cm (6 in) tall. At Ribauê, a pegmatite furnished brilliant rutile crystals over 5 cm (2 in) across. The Piteia body was remarkable for large masses of fluorite providing cleavage octahedrons to 10 cm (4 in) across. Bandy also mentioned that the Muiâne body produced sharp stibio-bismutotantalite crystals.⁹

Nahora Area. Beryl and columbite-tantalite and bismuthinite come from pegmatites at Nahora, Namicaia, Mamitaca, Alata, Mocachaia, Macula, Muacumauano, and Navaharra.⁵

Behier recorded beryl from Metocheria, Meconta, Mocubela, Ilodo, Muahamola, Mocuba, Cunheia (Moçambique Province), and a deposit near Novo Freixo (Cuamba) in Niassa Province.³ According to Behier, emerald in "fine green" crystals in a block of gneiss with biotite is preserved as Specimen No. 65-522 in the Museu Freire d'Andrade, with a doubtful locality of Porto Amelia.³

1. Borges, A. 1957. Subsídios para o estudo das pegmatitos de Moçambique (Africa Oriental Portuguesa). *Estudos, Notas e Trabalhos dos Serviços de Indústria e Geologia Boletim* 24 (Laurenço Marques), p. 17.
2. Hutchinson, R. W., and Claus, R. J. 1956. Pegmatite deposits, Alto Ligonha, Portuguese East Africa. *Economic Geology* (Lancaster, Pa.) 51:757-80.
3. Behier, J. 1957. Minerais de Província de Moçambique. *Província Moçambique, Serviços de Indústria e Geologia Boletim* 22:135 pp.
4. Cotelto Neiva, J. M., and Correia Neves, J. M. 1960. Pegmatites of Alto-Ligonha (Mozambique-Portuguese East Africa). *International Geological Congress, Reports of 21st Session, Norden, 1960. Part 17: Minerals & Genesis of Pegmatites*, pp. 53-62.
5. Bettencourt Dias, M. 1957. The pegmatites of Alto-Ligonha. *Estudos, Notas e Trabalhos dos Serviços de Indústria e Geologia Boletim* 24:48-51.
6. Guillemin, C. 1959. *Bulletin de la Société Française de Minéralogie et Cristallographie* 82: xxxix.
7. Bettencourt Dias, M. 1961. Os pegmatitos do Alto-Ligonha. *Estudos, Notas e Trabalhos, Serviços Geol. e Minas, Província Moçambique Boletim* 27, no. 2, pp. 17-36.
8. Mitchell, K. 1959. The largest beryl crystal? *The Gemmologist* 28:228.
9. Bandy, M. C. 1951. The Ribauê-Alto Ligonha pegmatite district, Portuguese East Africa. *Rocks and Minerals* (Peekskill, N.Y.) vol. 26, nos. 9-10, pp. 512-21.
10. Knorring, O. v. 1962. Pegmatite and related investi-

World Sources of Ore and Gem Beryl / Northern Ireland

gations. *University of Leeds, Research Institute of African Geology, 6th Annual Report, Session 1960-61 (Leeds), pp. 7-13.*

NEPAL

A recent visitor to several pegmatite gem mines confirmed that these were complex granitic types and yielded colored gem tourmaline and pale blue beryl crystals.¹ The principal mines are around Hyakule, Sankhuwa Sabha district, Kosi zone, E Nepal, near the towns of Chainpur and Khandbari and E of Arun River on the W slope of Jaljale Himal. The mines are called the Hyakule and the Phakuwa, the latter being noted for its pale blue aquamarine crystals up to 10 × 5 cm (4 × 2 in) size. Forms include *m* and *c*, the second order prism *a*, and several pyramids. Large crystals of "good medium blue" have been found, one of which contained a clear area estimated as capable of being cut into a 100 carat gem. Another occurrence contained small, nearly opaque, pale blue beryl crystals in pegmatite; another source bore tapered blue crystals of non-gem quality.

1. Bassett, A. M. 1979. Hunting for gemstones in the Himalayas of Nepal. *Lapidary Journal* 33:1492-1520, *passim*.

NEW GUINEA

Beryl with topaz and gold has been found in gravels of Fly River, 485 km (304 mi) WNW of Port Moresby.

1. Dunstan, B. 1913. Queensland mineral index and guide. *Queensland Geological Survey Publication* 241 (Brisbane) 1014 pp.

NIGERIA

The Precambrian basement complex of granites, gneisses, predominant mica schists, quartz schists, quartzites and altered limestones, contains many granitic pegmatites genetically related to the older granites.¹ The bodies are in the granites along their margins and also in roof pendants; all are narrow, not over 70 cm (30 in) in width, and up to 0.8 km (0.5 mi) long. The larger bodies are more poorly mineralized. Species are feldspars, quartz, tourmaline (sometimes colored), garnets, phosphates, rare element species, and also beryl, chrysoberyl, cassiterite, and others. Beryl is a common accessory but seldom found in quantity. The Okere dike furnished 20 tons of ore beryl but this is an exception. Most Okere crystals are pale greenish, yellowish, or nearly

white; simple hexagonal prisms range to 43 cm (15 in) diameter. In the Jemaa region, noted for an abundance of cassiterite-pegmatites, small amounts of beryl are also found. Such bodies are numerous on Jos Plateau in Zaria and Nassawara provinces, also between Zaria and Kano, and especially near Faike. Falconer described the geology of the Jos tin fields but did not mention beryl.²

1. Jacobson, R., & Webb, J. S. 1946. The pegmatites of central Nigeria. *Geological Survey of Nigeria Bulletin* No. 7 (London) 61 pp.
2. Falconer, J. D. 1921. The geology of the plateau tin fields. *Geological Survey of Nigeria Bulletin* no. 1. 55 pp.

NORTHERN IRELAND

One of Europe's classic aquamarine localities is Mourne Mountains, County Down, an ovoid granite massif, ca 20.8 × 11 km (13 × 7 mi), centered at a point about 48 km (30 mi) S of Belfast. Porous granite containsmiarolitic pegmatite cavities famed for splendid crystals of aquamarine and topaz. As early as the opening decades of the last century, fine specimens had been collected. Sir Charles Giesecke, for example, noted that "the most perfect, interesting, and valuable collection of Irish beryls, particularly those of the Mourne Mountains, is preserved in the splendid collection . . . of George Knox . . . purchased for the Museum of Trinity College, in Dublin."¹ Furthermore, "it is very remarkable, that this granite exhibits all the characters of the granite from Adontschelon . . . in which the beryls and topazes are found there."¹ Much of the value of Mourne specimens lies in the fact that they are matrices, sometimes showing fine, clear crystals of beryls perched on clean feldspar-quartz crystals of vug linings.²

Vugs occur in centers of pegmatitic schlieren bodies of small size. Essential species are feldspars, quartz and mica, with accessories of topaz, beryl and albite. Fayalite is an unusual species in the granite.³ The beryls are splendid, lustrous, hexagonal prisms, pale to medium blue color, often clear and gemmy. Many are only several cm in length but at times "giants" of 10 cm (4 in) have been found. Divergent groups of prisms are also noted. Associated with the beryl in vugs are smoky quartz, microcline (sometimes adularescent), albite, mica and chlorite.^{3,4} Less common are beryls in shades of green passing insen-

BERYL LOCALITIES

sibly into blue, also pale yellow and wine yellow, and rarely, crystals that are multicolored. Giesecke noted broken crystals recemented with quartz as well as some of nearly triangular cross section and clusters of acicular crystals. Forms: *c* and *m*, also {1011}, {1121}, and {1120}, and sometimes a dihedral prism.⁴ A decided rarity among beryls is asteria or star beryl, but apparently some occurred here according to Greg and Lettsom, who remarked on a polished beryl with decided "opalescence" that exhibited a "six-rayed star like some varieties of corundum."⁴

Fine blue crystals, sometimes transparent, occur with topaz, smoky quartz, and feldspar on Slieve Corra or Slieve Carrach [slieve = mountain]. Beryl occurs in large, rough-surfaced prisms on the W side of Rocky Mountain; in fair crystals on the NW side of a small lake on Binion Hill; fine radiating crystals occur on Slieve Havila, 4.8 km (3 mi) SSW of Lord Roden's Castle. The finest crystals occur on Chimney Rock Mountain on Lord Newry's estate.^{4,5} Topaz crystals, colorless and pale blue, rarely wine yellow, and not over several mm in length as a rule (but at times reaching several cm), are found in particular abundance in the area known as Diamond Rocks on the flanks of Slieve Donard, in the N part of the range.^{1,3}

1. Giesecke, C. L. 1832. *A Descriptive Catalogue of a New Collection of Minerals in the Museum of the Royal Dublin Society. To Which is added an Irish Mineralogy.* Dublin: R. Graisberry. 268 pp.; beryl pp. 20-1, 206-7.
2. Rüdler, F. W. 1905. *A Handbook of a Collection of the Minerals of the British Islands.* London: Wyman & Sons. 241 pp.
3. Delesse, A. E. O. J. 1853. Sur la pegmatite de l'Irlande. *Bulletin de la Société Française de Minéralogie* 10:568-88.
4. Greg, R. P., and Lettsom, W. G. 1858. *Manual of the Mineralogy of Great Britain and Ireland.* London: John Van Voorst. 483 pp.; beryl pp. 125-7.
5. Hall, T. M. 1868. *The Mineralogist's Directory . . . to the Principal Mineral Localities in the United Kingdom of Great Britain and Ireland.* London: Edward Stanford. 168 pp.; beryl pp. 114-5.

NORWAY

The southern tip and coastal portions consist of gneisses and gneiss-granites intruded by younger granites and bordered by quartzites, schists, gabbro, norite and amphibolite; younger granites are accompanied by pegmatite bodies, especially in the coastal islands.¹

Nordland. Common beryl occurs here at Stetind quarry, Tysfjord, 125 km (78 mi) NNE of Bødo.

Rogaland. Beryl occurs in Ollestad quarry, Hestad, 20 km (12.5 mi) ENE of Egersund.

Vest-Agder. Granite pegmatites are found on the island of Hitterø, 42 km (26 mi) SE of Egersund, long noted for rare-earth species. Adamson described ten bodies and complex mineralizations, but noted that beryl was rare.² Other localities are at Eitland, Austa, Rona, Randøysundfjord near Kristiansand, and Håvåsen near Eptevann in Iveland district, the last noted for crystals to 3.5 × 1.1 m (11 × 3.3 ft); five crystals weighed 9 tons.³

IVELAND DISTRICT. This area is partly in Vest- and Aust-Agder. Very many pegmatites occur with beryl a common accessory. Iveland is in the S part of Setesdal, about 50 km (33 mi) N of Kristiansand. Pegmatites occur mainly in Precambrian amphibolites in a belt which extends N to Evje; they have been quarried since 1898.⁴ Many bodies are rich in rare minerals, including beryl. The latter are commonly found in crystals up to 1,000 kg (2200 lb) in green, blue, yellow, and partly transparent but always severely fractured. Partial alteration along the cracks has been noted. Zoning in crystals is common and inclusions of other minerals are noted in many. Strand found pseudomorphs after beryl consisting chiefly of bertrandite and muscovite with subordinate quartz and albite and less than 1% euclase.⁵ Beryl has been found in both types of pegmatites distinguished by Bjørlykke, namely those rich in microcline-quartz and those rich in cleavelandite-quartz; the first type is most common.^{4,6}

Aquamarine was found in the Beryl Quarry at Landsverk near Evje.⁷ The following farms contain beryl-bearing pegmatites according to Bjørlykke:⁴ Katterø, Vegusdal; Frikstad; Eptevann; Håverstad (2 bodies, one with large crystals); Ljosland, containing numerous bodies, one quarry with blue and green prisms up to 100 × 70 cm (40 × 27.5 in); Mølland (crystals to 25 cm [10 in] diam.); Støledalen (altered crystals containing bertrandite); Skripeland; Birktevit; Ivedal; Hiltveit; Røsas; Frøyså; Dalane; Tveit (crystals to 100 × 15 cm [40 × 6 in] some containing small white translucent bertrandite crystals). Further listings of beryl localities in Iveland are provided by Neumann.⁷

In the Gjerstad district, ca. 17 km (10.5 mi) W of Kragerø, many beryl-pegmatites occur, such as at the hill Mørkhøgda in the N, at the farms Brokeland in the S and Brenndalsmo at Hulleknatten.⁸

World Sources of Ore and Gem Beryl / Norway

Telemark. Here beryl occurs in lepidolite-cassiterite-cleavelandite pegmatite at Tørdal, E of Nisservatn. The body is intruded near the Telemark granite massif and is complex, zoned, and contains prisms of colorless, yellowish, blueish or greenish beryl to 10 cm (4 in) diameter, some containing alkalis.⁹ Other localities include Brudalen, Kviteseid; Bivasshei, Nisserdal; Høydalen, Tørdal.⁷

Buskerud. Beryl is found at Snarum and Modum near Skuterud, SW of Tyrifjord, and at Bjertnes quarry, Krødsherad.⁷

Akerhus. Norway's sole emerald deposit is near the railroad station of Eidsvoll (formerly Eidsvold) on the W shore and S end of Lake Mjøsen not far from farm Byrud. Websky described "deep emerald green" crystals in a rock composed of feldspar, quartz, mica and fluorite; forms *m* and *c*, also {1011} and {1121}, and a dihedral bipyramid.¹⁰ Kunz noted that the "Arendal, Norway [*sic*]" deposit was taken for exploitation in 1899 by the Norwegian and General Exploitation Company, Ltd., of London, who set up an exhibit of emeralds at the Paris International Exposition of 1900, and that "many cut gems, most of them pale in color, but generally free from flaws, were shown."¹¹ Furthermore, "this occurrence of emerald strikingly resembles that at Crab Tree Mountain, Mitchell County, N.C."¹¹ Selset stated that the mine ceased work about 1900, after two tunnels were driven to explore a pegmatite vein running along the shore of the lake.¹² Local stories claim that much of the emerald-bearing portion of the pegmatite was blasted into the lake by ill-advised use of explosives. Only rarely were good stones found and then never more than about 6 mm (0.25 in) in diameter, but the color quality was considered to be of highest grade, and if anything a little too blueish. Selset cut some of the crystals himself and claimed that the gems matched the finest from any other source.¹²

A vague mention of emerald in biotite schist at Kjerringoe seems unsubstantiated. Common beryl was also found near the emerald deposit at Byrud and Minnesund.⁷ Raade described a large pegmatite body, 230 × 24 m (373 × 27 yd), containing beryl at Spro, Nesodden near Oslo; it is emplaced in Precambrian gneiss and is complexly mineralized.¹³

Østfold. A large granite massif trending NNW-SSE lies just W of Frederikshalde and contains almost countless pegmatite bodies emplaced

in gneiss along the edges.¹⁴ Most of the pegmatites are coarse-grained and have been quarried principally for feldspar and quartz, sometimes for mica, but beryl was collected only incidentally as ore. Beryl is a widespread though minor constituent in many of the bodies, however, and has been recorded in crystals to 300 kg (660 lb). Brøgger claimed that reports of beryl in syenite pegmatites also found in this region were erroneous and that apatite crystals were commonly mistaken for beryls.¹⁵ Geochemical studies of the beryls showed that many contained Rb and Sc, with the earlier-formed crystals, usually yellow and partly corroded, containing Sc while later generation crystals, usually blue and pink, contain no Sc.¹⁶

Numerous localities have been furnished by Neumann,⁷ among them: Boksjøen quarry near Aspedammen; Idd, 1 km (0.6 mi) S of farm Toklund, where the body is 5–10 m (5.5–12 yd) wide and contains bavenite associated with the beryl, the latter described as an alteration product by Neumann and Sverdrup.¹⁷ The following beryl localities are in Råde: Halvorsrød,⁸ Evestad, Aker; near Moss are Ånnerud and Arnoldskåven, Vausjø; in Rakkestad are Ski and Vatevedt; others are at Berby and Ødegårdsletten, Våler.

1. Schneiderhöhn, H. 1961. *Die Erzlagertstätten der Erde*. Vol. 2: *Die Pegmatite*. Stuttgart: Gustav Fischer 721 pp.
2. Adamson, O. J. 1942. The granite pegmatites of Hitterø, southwestern Norway. *Geologiska Föreningens i Stockholm Förhandlingar* 64:97–116.
3. Rosenqvist, I. T. 1949. Store beryllkristaller i Iveland. *Norsk Geologisk Tidsskrift* (Kristiana) 27:233.
4. Bjørlykke, H. 1935. The mineral paragenesis and classification of the granite pegmatites of Iveland, Setesdahl, Southern Norway. *Norsk Geologisk Tidsskrift* 14:211–307.
5. Strand, R. 1953. Euclase from Iveland, occurring as an alteration product of beryl. *Norsk Geologisk Tidsskrift* 31:1–5.
6. Bjørlykke, H. 1937. The granite pegmatites of Southern Norway. *The American Mineralogist* 22:241–68.
7. Neumann, H. 1961. The scandium content of some Norwegian minerals and the formation of thortveitite—a reconnaissance survey. *Norsk Geologisk Tidsskrift* 41:197–210.
8. Bjørlykke, H. 1937. Mineral paragenesis of some granite pegmatites near Kragerø, Southern Norway. *Norsk Geologisk Tidsskrift*, 17:1–16.
9. Oftedal, I. 1942. Lepidolite- and cassiterite-bearing pegmatites in Tørdal, Telemark. *Norsk Geologisk Tidsskrift* 22:1–14.
10. Websky, M. 1876. Ueber Beryll von Eidsvold in Norwegen. *Tschermak's mineralogische und petrographische Mitteilungen* (Vienna) 6:117–8.
11. Kunz, G. F. 1902. Precious stones. Chapter in *U. S.*

BERYL LOCALITIES

- Geological Survey Mineral Resources of the United States for 1901*, pp. 729-71.
12. Selset, R. 1963. Emerald locality on Mjøsa Lake, Norway. *Rocks & Minerals* (Peekskill, N.Y.) 38:608-9.
 13. Raade, G. 1965. The minerals of the granite pegmatite at Spro, Nesodden, near Oslo. *Norges Geologiske Undersøgelse* (Kristiana) 234:160-6.
 14. Brögger, W. C.; Vogt, T.; and Schetelig, J. 1906. Die Mineralien der südnorwegischen Granitpegmatitgänge. *Skrifter udgivne af Videnskabselskabet i Christiania*, Mat.-Nat. Kl. 2 vols. 162, 151 pp.
 15. Brögger, W. C. 1890. Die mineralien der Syenitpegmatitgänge der südnorwegischen Augit- und Nephelin-Syenite. *Zeitschrift für Kristallographie* (Leipzig) vol. 16. 235, 663 pp.
 16. Ofstedahl, I. 1956. Contribution to the geochemistry of granite pegmatite. *Norsk Geologisk Tidsskrift* 36:141-50.
 17. Neumann, H., and Sverdrup, T. L. 1959. Bavenite from Boksjøen mineral mine, near Aspedammen in the county of Østfold. *Norsk Geologisk Tidsskrift* 39:339-42.

PAKISTAN (WEST)

Granitic pegmatites are abundant in the foothills and flanks of the extreme N portion of the Himalaya Mountains. Much of the following information was taken from Heron's directory of economic minerals.¹

Hunza (Azad Kashmir)

Beryl occurs in granitic pegmatites near Bulchidas and 1.6 km (1 mi) S of Iskere in the Haramosh area. Aquamarine is found in pegmatites near Deche, Iskere, and at Jutial; the deposits are not considered workable.¹

Baltistan

Splendid aquamarine crystals and common beryl are found near Daso village, 35°43' N, 75°31' E, on the right bank of the Braldu River, several mi above the junction with Shigar River at an altitude of 2500 m (8300 ft). Pegmatite bodies that were discovered in 1915 are intruded in biotite-gneiss; common associates are: feldspars, quartz, tourmaline, and garnet. The finest crystals come from vugs with some beryl crystals observed penetrating into open spaces from cavity walls. Crystals are blueish green and range from transparent to cloudy, flawed. Common beryl crystals go up to 15 × 8 cm (6 × 3 in), but higher quality transparent crystals are smaller, 5-8 cm (2-3 in) long and 1-4 cm (0.5-1.5 in) in diameter.² These mines were worked in 1917 when good stones sold for 5 shillings per carat.³

Ball recorded a production of 6,260 carats in 1937 but none for 1935-36.⁴ In a later account, Heron noted 14 pits between the upper and lower Dasu villages plus others on a path from lower Dasu to Tingstun village at a point 1.6 km (1 mi) W.¹ Another aquamarine mine exists at Nirjit village. Heron regarded these deposits as promising for future exploitation.

North-West Frontier Province

Beryl occurs in Chitral, ca. 170 km (108 mi) NNE of Rawalpindi, as very beautiful, water clear aquamarine crystals with remarkable dark banding parallel to basal plane {0001}; they are believed to be from a granitic pegmatite field along the right bank of Sirink Gold River, 34 km (20 mi) upstream from Mogh. Beryl is also reported from Latkoh and Gabar-O-Bach districts, the last noted for large aquamarine and topaz crystals from pegmatite.¹

In the Swat region, Shams reported inky blue beryl displaying strong biaxiality and with R.I. of 1.599 ± 0.001 and 1.607.⁵ Far better known are the emeralds which were reported in 1962 by Davies who gave the locality as Mingaora.⁶ The deposit was traced from a find of a beautiful crystal in alluvium of Swat River, and the in-place deposit was located about 1 km (0.6 mi) NE of the town of Mingaora, 34°47' N, 72°22' E; the deposit is accessible by road from Peshawar via Mardan.⁷ It is a schist-type occurrence, the emerald being found in quartz-calcite lenses in calcareous schist as well as in fractures. In adjacent talc-schist, emerald also occurs, but principally along the contact of the latter unit with a band of micas; the micas are adjacent to a serpentine layer produced from alteration of peridotite. In October, 1973 during Carbonnel's visit, the mine was being worked opencut by about 50 miners and "the mine is thought to have produced in 13 years about 400,000 carats."⁷ Inferred reserves are 14,500,000 cubic meters of ore that could eventually yield 50,000,000 carats, but these figures, supplied by the mine authorities, were taken to be optimistic by Carbonnel. The latter also mentioned an occurrence of emerald in Chitral district "where emeralds were exploited before 1938 near Shah Sadin at the Afghan frontier."⁷

Mingaora emeralds were examined by Gübelin who remarked that the quality of the finest cut gems is "good to outstanding" in respect to liveness, transparency and saturated green color,

World Sources of Ore and Gem Beryl / Peoples Republic of China

which compares them favorably to Muzo stones.⁸ However, lesser quality gems were considered rather poor. From a lot of 57 cut stones, from 0.30 to 2.34 carats, 50 were used to determine properties and 7 of the best gems of exceptional clarity to obtain the more accurate constants. R.I.(Na): $o = 1.595-1.600$, $e = 1.588-1.593$, all ± 0.001 ; $\text{diff.} = 0.007$. Averages are $o = 1.5975$, $e = 1.5905$, $\text{diff.} = 0.007$. $G = 2.75-2.78$, average 2.765; dichroism green and yellowish green. All were opaque to UV and inert under 3650 Å and 2537 Å UV. Absorption of shortwave UV indicates presence of iron. Distinct reddish to red color occurred under Chelsea filter and orange to red under Stokes fluoroscope. Distinct absorptions noted at 6830, 6620, and 6460 Å, with a broad absorption at 6200-5900 Å. Also distinct absorptions in some specimens at 6730, 6800, 6460-6370(strong), 6250-5900, and one at 4774(strong) Å. Inclusions: fractures, fissures, zoning striations, tubes filled with liquid and two-phase inclusions, swarms of filmy liquid-filled inclusions, liquid droplets, and fine, oriented tubular inclusions.

Ikramuddin

Large common beryl crystals have been reported.

Hazara

Beryl in pegmatites occurs at Godarpur, about 100 km (62.5 mi) N of Rawalpindi. Beryl-pegmatites are emplaced in schistose and gneissic rocks about 2.4 km (1.5 mi) SE of Rajdhawari, Oghi subdivision, of which 11 bodies yielded beryl; crystals are pale green to blueish green, 5-13 cm (2-7 in) long and up to 10 cm (4 in) diameter; one quarry produced 37 tons of ore beryl.⁹

1. Heron, A. M. 1954. Directory of economic minerals of Pakistan. *Records of the Geological Survey of Pakistan* (Karachi) vol. 7, no. 2. beryl pp. 10-11.
2. Middlemiss, C. S., and Parshad, L. J. 1919. Note on the aquamarine mines of Daso on the Braldu River, Shigar Valley, Baltistan. *Records of the Geological Survey of India* (Calcutta) vol. 49, pt. 3, pp. 161-72.
3. Iyer, L. A. N. 1948. *A Handbook of Precious Stones*. Calcutta: Baptist Mission Press. 188 pp.
4. Ball, S. H. 1940. Gem stones. Chapter in *U. S. Bureau of Mines Minerals Yearbook for 1940*. 13 pp.
5. Shams, F. A. 1963. An inky blue beryl from Swat State. *Punjab University Geology Bulletin* no. 3 (Lahore) p. 31.
6. Davies, R. G. 1962. A green beryl (emerald) near Min-

gaora, Swat State. *University Geology Bulletin* no. 2, pp. 51-2.

7. Carbonnel, J. P. 1976. A visit to the Mingaora emerald mine, Swat, Pakistan. *Lapidary Journal* 30:1236-8.
8. Gübelin, E. J. 1968. Gemmologische Beobachtungen am neuer Smaragd aus Pakistan. In *Edelsteine, Sonderheft 18 of Der Aufschluss* (Heidelberg) pp. 111-6.
9. Khan, S. N. 1964. Geology of Rajdhawari pegmatites, Oghi Sub-division, Hazara District, West Pakistan. *Geological Survey of Pakistan, Information Release* no. 19. 18 pp.

PERU

Emeralds were reported by a Mr. Colmenares of Lima on a property 12 km (7.5 mi) from Chuquihuana in Cerro Takee-Ccacca (Taquicacca) at an altitude of 3500 m (13,500 ft) and accessible by good road from Cuzco.¹ Steinmann reiterated this report and added that beryl had been vaguely reported from the Acomayo region.² Raimondi, however, does not mention beryl at all.³

1. South America, Peru. 1889. *Engineering and Mining Journal* (New York) 93:914.
2. Steinmann, G. 1929. *Geologie von Peru*. Heidelberg. p. 388.
3. Raimondi, A. 1878. *Minerales del Peru*. Lima: Imprenta del Estado. 305 pp.

PEOPLES REPUBLIC OF CHINA

Beryl is reported from Fanchih district, N Shensi Province. It has been observed as an accessory in tungsten-bearing veins of Kiangsi Province, in cassiterite-bearing pegmatite at Tungmuling, Nankang, S Kiangsi Province, and vaguely reported from granite regions of Hunan Province.

Hong Kong. Ruxton noted that beryl was found in the colony in 1914, but the deposit was lost until 1955, when it was rediscovered on Devil's Peak.¹ There small granitic pegmatites occur along the rim of a granite cupola. The bodies are vein-like, from stringers to some that are about 0.7 m (ca. 2 ft) wide and many meters long. Two complex beryl-bearing bodies in tunnels SSW of Devil's Peak are quartz-muscovite-beryl veins with minor feldspar and wolframite; in 1955 one ton of ore beryl was mined. Green prisms here are low in alkalis. On Kowloon Peninsula, beryl was reported in a railway cut near Hung Hom and near the S end of a tunnel through Smuggler's Peak. Deposits also occur on the E side of Tai Tam Bay on Hong Kong Island and above Anderson Road about 400 m (440 yd) from Custom's Pass, Clearwater Bay Road. The as-

BERYL LOCALITIES

sociation of beryl with wolframite in these deposits was studied by Davis.²

1. Ruxton, B. P. 1957. Notes on the occurrence of high grade beryl ore in Hong Kong. *Colonial Geology and Mineral Resources* 6:416-28.
2. Davis, S. G. 1958. Tungsten mineralization in Hong Kong and the New Territories. *Economic Geology* (Lancaster, Pa.) 53:481-8.

POLAND

Localities in Silesia, formerly German Schlesien, are given with German names and Polish equivalents where the latter are known. Beryl occurs in granitic pegmatites associated with granite masses E of Dresden and extending ESE to the N slopes of the Riesengebirge to Glatz (Kłodzko), Poland. Mineral parageneses in some of these pegmatites are described by Michell, but beryl is not mentioned.¹

Striegau (Strzegom). This town is located about 48 km (30 mi) SW of Breslau (Wrocław). A famous locality is Pilgrimshain quarry (construction granite) where small pegmatite veins with vugs are exposed from time to time; the beryl, mostly enveloped in stilbite, is associated with epidote, orthoclase (well-formed crystals), and quartz. Some beryl prisms are wine-yellow, also pale blue, and sometimes quite transparent; they average only 5-6 mm (ca. 0.25 in) long and are several mm thick; forms: *m* and *c*, also {1120}, {3.3.6.10} and {7.7.14.10}.^{2,3}

Schweidnitz (Swidnica). Beryl may be found in pegmatites on Tauberhügel at Steinkunzendorf near Schweidnitz, or 48 km (30 mi) SSW of Breslau; crystals to 8 × 4 cm (3.25 × 1.6 in) but they are often broken and recemented with quartz. The beryl is also associated with schorl. At Conradswaldau, Würben, near Schweidnitz beryl occurs in pegmatite. It is translucent, with prisms of yellowish white color about 1 cm (0.4 in) long and associated with garnet.^{2,4}

Waldenburg (Wałbrzych). In this town, located 65 km (41 mi) SW of Breslau, common beryl is found in pegmatite. At Rudolphswaldau large crystals occur.²

Reichenbach (Dzierżniów). A town located 50 km (32 mi) SSW of Breslau where pegmatite veins occur in gneiss at Mittel Peilau with yellowish, mica-covered prisms to 4 cm (1.6 in) diameter; also blue green at times; forms: *m* and 1120.^{2,5} Beryl is also in pegmatite on Weinberg, Langenbielau, featuring pale yellow and greenish white prisms, some over 10 × 3 cm (4 × 1.25

in); in quartz associated with schorl, apatite, and kyanite; forms: *m*, *c*, {1120}, {1011}, {1121}.

Frankenstein (Zabkowie Śląskie). This town is located 60 km (38 mi) almost due S of Breslau. Pegmatite veins at Rosenbach contain crystals to 15 × 7 cm (6 × 2.75 in) in size. Analyses may be found in Traube² and Fiedler.⁵

Neurode (Nowa Ruda). Beryl is reported in pegmatites of Weitengrund.

1. Michell, W. D. 1941. Paragenesis of the pegmatite minerals of Striegau, Silesia. *The American Mineralogist* 26:262-75.
2. Traube, H. 1888. *Die Minerale Schlesiens*. Breslau: J. U. Kern. 286 pp.
3. Schwantke, A. 1896. *Die Drusenminerale des striegauer Granits*. Leipzig: Veit. 88 pp.
4. Dathe, J. H. E. 1887. Neue Fundorte schlesischer Mineralien. *Zeitschrift der Deutschen Geologischen Gesellschaft* (Berlin) 39:232-33.
5. Fiedler, H. 1863. *Die Mineralien Schlesiens mit Berücksichtigung der angrenzenden Länder*. Breslau: F. E. C. Leuckart. 100 pp.

PORTUGAL

Granitic pegmatites, many beryl-bearing, occur in wide areas of the north and are associated with granite masses. However, beryl occurs only in small crystals and seldom in amounts sufficient to mine as ore.

Minho Province

Numerous beryl-bearing bodies are intruded in mica schists between Minho and Lima rivers NW of Viana do Castelo.

Douro Litoral Province

Around Amarante, 49 km (31 mi) ENE of Porto, cassiterite-wolframite bodies occur in granitic and schistose rocks; beryl crystals are of simple form, also in anhedral masses, and rarely over several mm across; colors white, colorless, rarely pale blue, and slightly pleiochroic.¹ Mineralogy of these deposits is described in part by Cotelto Neiva.² Beryl occurs also in mines of Rebordas and at Venda Nova, Rio Tinto near Porto.³

Beira Alta Province

Best known occurrences of beryl are around Mangualde and are described by several investigators.^{3,4,5,6} Mangualde is 15 km (9.5 mi) SE of Viseu, the provincial capital. In general, the ordinary bodies exhibit coarse grain and several have been mined for feldspar. At the Mangualde pegmatite, complex mineralization occurs and is famous for its large masses of phosphates and

World Sources of Ore and Gem Beryl / Republic of South Africa

sulfides and many other species.⁶ Beryl of gem quality and also some gem tourmaline have been found.⁷ In the SE part of the province, close to the border with Beira Baixa Province, numerous granitic pegmatites occur in the district around Bendada, about midway between Guarda city and Covilha.⁸ These are complex, zoned bodies associated with nearby granite. The Seixeira and Quinta da Ribeira pegmatites were mined during and after World War II for ore beryl. Typically the beryl is associated with quartz and K-feldspar, the latter kaolinized; also with albite, columbite-tantalite, and muscovite. Sharp prisms up to 3 kg (6.6 lb) that are commonly corroded, pale green, and translucent. Forms: m , c and $\{2130\}$, less commonly $\{11\bar{2}0\}$, $\{11\bar{2}1\}$, $\{10\bar{1}1\}$, $\{30\bar{3}1\}$, $\{30\bar{3}2\}$, $\{50\bar{5}1\}$, $\{11\bar{2}2\}$, $\{15.0.15.1\}$, and $\{39.0.39.2\}$. R.I. $o = 1.578$, $e = 1.573$, diff. 0.005.

1. Maijer, C. 1965. *Geological investigations in the Amaranite region (Northern Portugal) with special reference to the mineralogy of the cassiterite-bearing albite pegmatites*. Rotterdam: Grafisch Centrum, Deltro. 155 pp.
2. Cotelto Neiva, J. M. 1944. La muscovite dans le pegmatites granitiques et dans les veins hypothermales de la cassiterite et de la wolframite. *Publicações do Museu e Laboratório Mineralógico e Geológico da Faculdade de Ciências, Universidade do Porto* 36:1-11.
3. Tenne, C. A., and Calderon, S. 1902. *Die Mineralfundstätten der iberischen Halbinsel*. Berlin: A. Asher & Co. 348 pp.
4. Duparc, L., and Gysin, M. 1927. Notices minéralogiques. Les minéraux de la pegmatite de Mangualde. *Schweizerische mineralogische und petrographische Mitteilungen* (Zurich) 7:32-4.
5. Jesus, A. M. de. 1934. Pegmatitos mangano-litíferos da região de Mangualde. *Comunicações dos Serviços Geológicos de Portugal* (Lisbon) 19:65-200.
6. Oen, I. S. 1959. On some sulphide minerals in the beryllium-lithium pegmatite of Mangualde, north Portugal. *Neues Jahrbuch für Mineralogie* (Stuttgart) 93:192-208.
7. Steberl, G. 1963. Mineralfundpunkte in Portugal. *Der Aufschluss* (Heidelberg) 14:231-2.
8. Correia Neves, J. M. 1960. Pegmatitos com berilo, columbite-tantalite e fosfatos da Bendada (Sabugal, Guarda). *Memórias e Notícias, Museu e Laboratório Mineralógico e Geológico, Universidade do Coimbra* 50. Coimbra: University of Coimbra. 172 pp.

REPUBLIC OF SOUTH AFRICA

Namaqualand

In 1914, common beryl crystals to 1 m (3 ft) long had been found in granitic pegmatites in the Jackalswater area NNE of Steinkopf.¹ By 1929 production of ore beryl was underway, and one report described a crystal of $8.7 \times 1.5 \times 1.5$ m

($29 \times 5 \times 5$ ft) that was estimated to weigh 16 tons.² Kovaloff reported "many hundreds" of pegmatite bodies in gneiss around Jackalswater and estimated that 20 tons of ore beryl had been sorted out by miners from about 400 tons of rock.³ The geology of the area was briefly described by Mountain.⁴ The pegmatites are in a belt along both sides of the Orange River, which forms the border between the republic and South West Africa (to the N). The W-E extent is from Vioolsdrif, 48 km (30 mi) N of Steinkopf to past Pella, into the Kenhardt district, and terminating at a point 95 km (60 mi) W of Upington. However, the most important beryl-bearing bodies are around Jackalswater, Henkries, and Goodhouse, or in the area generally N of Steinkopf. They vary greatly in size, shape, zoning, and mineralization, most being mineralogically simple. Beryl is common, but occurs as ore in only a few bodies where it is usually found in blueish green, yellowish green or greenish yellow prisms from less than a cm to over a meter (3 ft) in length. Pinkish beryl is sometimes found in cores. The average tenor is 10-13% BeO.⁵ Gem material has not been reported.

A list of 66 beryl occurrences was compiled by G. K. Joubert but only a few of the more important can be given here.⁵

JACKALSWATER AREA: Many bodies are centered 35 km (22 mi) NE of Steinkopf. Near Kokerboomrad, 8 km (5 mi) W of Jackalswater. Sleight's mine, 3.2 km (2 mi) NW of Jackalswater, produced 16 tons of beryl in 1935 from a complex body. Near Uranoop River, between Uranoop Farm and Jackalswater, beryl is in large crystals.

HENKRIES AREA: At Witkop about 3.2 km (2 mi) W of entrance to Henkries Gorge, in highly greisenized and albitized pegmatite. At Spodumene Kop, about 5.6 km (3.5 mi) SW of Henkries Water. In Pegmatite Valley, 1 km (0.6 mi) SW of Henkries Water. At Noumas about 17.5 km (11 mi) NW of Jackalswater.

GOODHOUSE AREA: Many small bodies exist in a large area E of Goodhouse to as far as Kabis and across the Orange River into Hakiesdoorn in S.W. Africa; at the old mica mine near Goodhouse; near the boundary of Goodhouse-Wolf-ton.^{5,6}

KAKAMAS AREA: On Middel Post and Koegab farms, about 27 km (17 mi) SE of Kakamas, many bodies are intruded into gabbroic rocks, the most important occur on Middel Post Farm and

BERYL LOCALITIES



Fig. 14-43 A view in Pegmatite Valley in Namaqualand, Republic of South Africa, named from the abundance of granitic pegmatites found therein which appear as white streaks in the photograph. From T. W. Gevers et al. "The Pegmatite Area (South of the Orange River) in Namaqualand," *Memoirs of the Geological Survey of South Africa* 31 (Pretoria, 1937).

are up to 10 m (12 yd) wide; ore beryl is obtained here and also from Koegab Farm.⁶ Beryl comes also from pegmatites located about 60 km (38 mi) NW of Kakamas along N side of Orange River. See literature sources no. 7 and 8 for ore production figures.

Emerald in Namaqualand. A minor but interesting occurrence has been reported from near Baviaanskop: as deep green acicular crystals in quartz lenses and adjacent biotite schist within a band of coarse-grained biotite granite; no crystals large enough for gems were found.⁵

Transvaal

The important schist-type emerald deposits of Leysdorp, or more accurately, the Gravelotte district in NE Transvaal, were discovered sometime

late in 1927, but, as so often happens, the identity of the discoverer is controversial. According to an early account, the crystals, lying loose on the surface, were found by S. A. Van Lingen and correctly identified by W. E. Bleloch.⁹ However, Van Eeden et al. credit the discovery, locally at least, to a certain Jack Tarr, who was prospecting in the vicinity of what is now known as the Somerset Mine, and "his discovery led to the flotation of the Beryl Mining Company which commenced operations at the Somerset mine on the Farm Barbara in 1927."¹⁰ Very shortly thereafter, claims were staked by R. Reeves-Moore and acquired by the Beryl Mining Company, Ltd., which registered a capital of £20,000 in 200,000 shares at 2 shillings each. At this time prospecting and mineral rights were acquired over a large area

World Sources of Ore and Gem Beryl / Republic of South Africa

adjacent to the original claims. According to Kovaloff, a total of 100 claims were staked in 3 blocks of 60, 33, and 7 claims.¹¹

Intensive prospecting followed these early developments and many small operations were floated by Mme. Andree, F. Galley, Kaiser, and others, but most proved barren or unprofitable. Proven deposits as of 1938-39, according to Van Eeden et al. are as follows, with known dates of operation:¹⁰

- (a) *The Beryl Mine Group*
(Somerset mine area)
The Beryl Mining Co., Ltd., Somerset mine, 1927-34
Emeralds South Africa, Ltd., 1929-30
South African Emeralds
- (b) *The Cobra Group*
claims located by Capt. Elton, 1929
The African Emeralds Corp., Ltd., Lehman mine, 1929-30
Cobra Emeralds, Ltd., Empire mine, prior to 1929; 1929-

- (c) *The New Hope Mine Group*
Barbara Emeralds
New Hope Mine, 1935-
Union Emeralds
South African Emerald Corp
- (d) *The Lone Hand Mine Group*
African Emerald Co., New Chivor mine
Arundel Emeralds, operations S of Selati River
Anglo-French Emerald Co., Pty., Ltd., 1930
Leysdorp Emerald Syndicate, Ltd. (on Selati Ranch) 1930
Lone Hand Mine, 1936-
Selati Emeralds

In addition, Kunz mentions a Standards Emeralds Co., Ltd., which was in the process of organization in 1929.¹²

Only several companies survived the initial boom-and-bust period, among them the Beryl Mining Co., Ltd., and Cobra Emeralds, Ltd. The

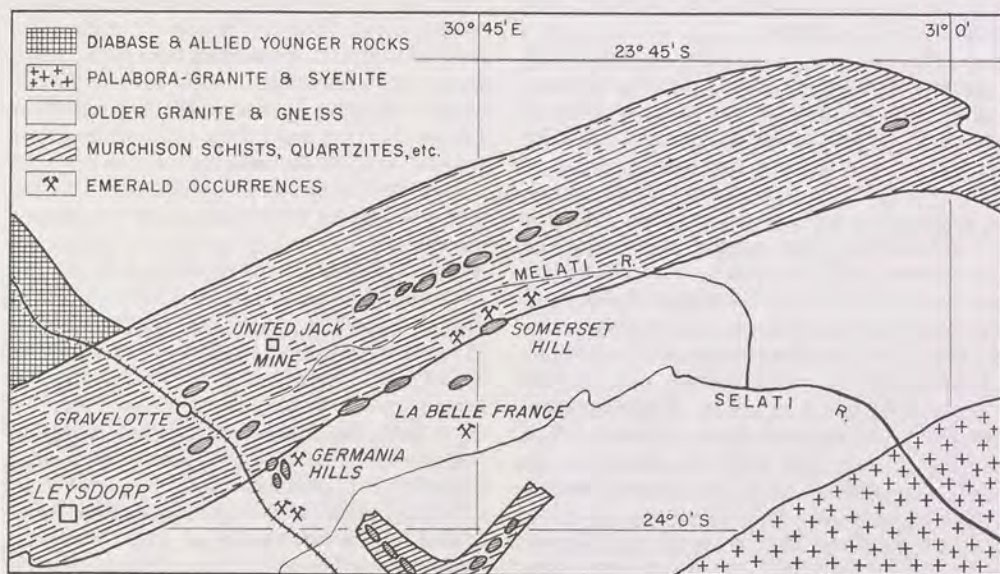

Fig. 14-44 Emerald occurrences in the Leysdorp, Transvaal district, Republic of South Africa. The elongated Murchison series form a folded mass of schists, amphibolites, quartzites, slates, and calcisilicate rocks, among others, resting on granites. The small island structures or "kops" are generally of quartzite. After J. M. Le Grange, "The Barbara Beryls . . ." *Transactions of the Geological Society of South Africa* 32 (1929).

BERYL LOCALITIES

deposit on Somerset Hill belonging to the Beryl Mining Co. proved to be the most prolific producer for a time and was blessed with rich ore bodies amenable to large-scale mining and recovery treatment. For example, in 1929, 300–350 lb (135–160 kg) of crystals were separated each week from about 300 tons of ore, and further selected were 5–10 lb (2.25–4.6 kg) of cuttable crystals of best color and quality for shipment to London for cutting and marketing. Clear crystals were faceted, others cut into cabochons, beads, and other small shapes. Occasionally large but flawed crystals were carved into cameos and miniature sculptures as in the case of a 10-carat crystal which was carved as a cameo of Nero in Berlin and then sold for £50. The finest cut gems sold as soon as marketed, and there was good demand for other items; for example, a high quality bead necklace was sold for £300. The largest price received for a cut gem was £100 per carat for a 9 carat gem cut from a crystal that originally weighed 212 carats. Other gems cut from this same crystal brought the amount realized from it alone to £1,168.^{12,13} Rough from the mine was also sold in Idar-Oberstein, Paris, Geneva, and even in China and India.

In 1929, the Somerset mine was supplied with a mechanical treatment plant capable of processing 200 tons of schist per day to reduce costs of hand work by native labor and reduce thefts. The ore was fed to a tube mill and trommel supplied with water from the Selati River for the purpose of softening the rock and aiding removal of most of the biotite mica that adhered to crystals. The concentrates, rich in crystals, were discharged into locked bins to await sorting. At this time, the opencuts reached a depth of 12 m (40 ft) with the size of the deposit estimated at 60 m (200 ft) wide at the W end and narrowing at the E. The average width was 6 m (20 ft). Weekly production parcels of selected stones averaged 5.5 lb (2.5 kg). During June 1929, cut goods sold for £915.¹³ In August of 1929, two splendid crystals were found of 2,200 and 552 carats. According to Kunz, the Beryl Mining Co. showed a profit of £4,015 for the year.¹² In the same area, Emeralds South Africa, Ltd., opened a deposit of 180 × 15 m (600 × 50 ft) on their property and found crystals of good quality. In 1929, the Leysdorp Emerald Syndicate, Ltd., registered for operation with a nominal capital of £5,000.^{14,15}

By 1930, the fortunes of most companies had been settled, and out of seven registered firms,

only the Beryl Mining Co. continued its Somerset mine, producing 270 lb (122 kg) of select-grade crystals in a twelve-month period ending October 31, 1929, netting £11,256, and 300 lb (125 kg) in the ten-month period ending August 31, 1930, from which sales of £8,394 were made. At this time the tenor of ore had dropped to 0.5 lb (0.22 kg) per ton average, with the Somerset mill treating 180 tons per day, from which 9.6 lb (4.3 kg) of select stones were sent off to London each week. Sales in 1931 were 46,178 carats for which £8,360 were obtained; a fine crystal found in May was cut into a gem that sold for £180. Operations were reduced in 1932, and only one other firm, Anglo-French Emeralds Co., Ltd., reported any production. Total sales of emeralds were 8,085 carats valued at £2,932 for that year.¹⁶ By 1933, only the Beryl Mining Co., Ltd., and Cobra Emeralds reported production, the total sales being 14,764 carats valued at £4,220.¹⁷

In early years of exploitation the Beryl Mining Co., Ltd. enlarged their opencut to 30.5 m (100 ft) in width and reached a depth of 12 m (40 ft). By 1930, tunnels had been driven at the 24.5 m (80 ft) and 91.5 m (300 ft) levels, still in emerald-bearing schist.¹⁸ This last reference, incidentally, depicted three carved emeralds from the Somerset deposit that were cut in London, including a particularly attractive figurine which measured about 7.6 cm (3 in) tall and 2.5 cm (1 in) wide, valued at £100. At about the same time, Cobra Emeralds worked their mine vigorously but were forced to shut down about 1939 because of a depressed market and decreasing quality in the stones mined.¹⁹ Official Cobra production figures for 1936 and 1937 are £6,082 and £10,838 respectively,²⁰ and to the end of 1937 production from all mines in the district was 664,612 carats valued at £84,294.¹⁹ At this time the yield of crystals ranged from 2.75 to 3.16 carats per load of 1 cubic yard. No production occurred during the war years of 1940–44, but some work was resumed in 1945, principally at the Somerset mine, which delivered 2,902 carats of stones worth £1,433 for the first quarter of 1946, with most going to India.²¹ In 1946, the total production was 11,533 carats with exports of 6,492 carats valued at £3,101; in 1947, 7,753 carats were produced.²² A news item in 1956 stated that the Cobra mine was reopened in January of that year under ownership and management of the African Gem Co. of Johannesburg, and that the mine's highest output was 154,081 carats in 1937.

World Sources of Ore and Gem Beryl / Republic of South Africa

The table of production below was compiled from Van Eeden et al.¹⁰ for 1928-38; *Union of South Africa Geological Survey Handbook for 1959*²³ for 1939-58; Hartwell and Brett²⁴ for 1959-62; and Republic of South Africa *Minerals*⁸

Table 14-37
TRANSVAAL EMERALD PRODUCTION
AND SALE RECORD

Year	Production (carats)	Value	Sales (carats)	Total value
1928	—	£ 3,192	—	—
1929	49,887	16,206	—	—
1930	36,431	11,100	—	—
1931	46,178	8,360	—	—
1932	8,085	2,932	—	—
1933	14,764	4,220	—	—
1934	116,768	10,608	—	—
1935	148,451	10,756	—	—
1936	89,967	6,094	—	—
1937	154,081	10,826	—	—
1938	—	—	—	—
1939-44	—	—	—	—
1945	1,765	—	1,765	£883
1946	—	—	6,492	3,101
1947	—	—	—	—
1948	—	—	914	335
1949-50	—	—	—	—
1951	27,560	—	3,220	38
1952	357,750	—	121,500	961
1953	7,875	—	7,875	200
1954-55	—	—	—	—
1956	9,988	—	—	—
1957-58	—	—	—	—
1959	4,050,000	—	6,480,000	U.S. \$113,000
1960	8,100,000	—	6,480,000	145,000
1961	—	—	2,700,000	—
1962	—	—	—	—
1963	1,180,000	—	—	R 294,000
1964	990,000	—	—	317,450

for 1963-64. Blank spaces mean no data rather than no production.

Recent Mining Practice

Wollin reported that in 1967 only two mines were operating, the Gravelotte Emerald Mine and the BVD, the latter reputed to have produced some exceptionally large crystals, one of 400 carats found recently was valued at 417,000 Rand or U.S. \$584,000.²⁵ At the Gravelotte mine the emerald-bearing schist forms a low hill that was being mined systematically at the rate of 250 tons per day with the rock taken to an adjacent plant for crushing and recovery of crystals. A total of 560 native laborers and other personnel were employed and required to reside at the mine for security reasons. Of this force, 138 were employed as sorters at the Gravelotte mine and 46 at the BVD. A useful innovation was a white-surfaced conveyor belt upon which the crushing plant output is discharged and from which the sorters pick out crystals and lumps of rock in which emerald crystals remained imbedded. Production commonly achieved 15 ounces of gemstones per day, along with 30 ounces of cabochon-quality rough. Considerable non-emerald beryl was also found as well as rounded lumps of apatite and small pieces of reddish amethyst, neither of gem grade. Sorted material was bagged on the spot and delivered to carefully-trained, final sorters who discarded waste and separated the rough into three categories according to quality. The lots were sold abroad, principally in Europe, and none of the rough stayed in South Africa.

Emerald Deposits

The first substantial description and local geology was published by Le Grange,²⁶ while a far more complete treatment of the geology of the entire Murchison Range, in which the deposits occur, was prepared by Van Eeden et al.,¹⁰ who also drew up a geological map showing the formations and the positions of the numerous mines and prospects, including those of emerald, within the coordinates of 23°38'-24.2' S and 30°28'-31°10' E.

The center of the emerald district lies about 335 km (210 mi) NE of Pretoria. Basement rocks surrounding the range are old granites intrusive into rocks of the Swaziland System, with igneous intrusives and metamorphic roof pendants aligned generally WSW-ESE in belts of varying widths. The rocks are divided into two groups:

BERYL LOCALITIES

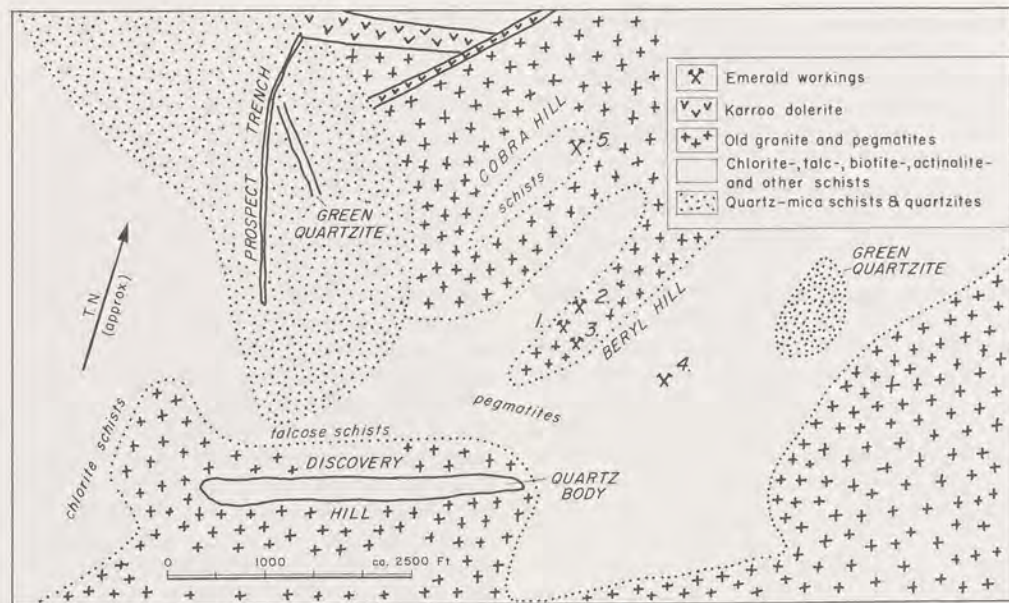

Fig. 14-45 Sketch map of the geology around the Germania Koppies (Hills), near Leysdorp, Murchison Range, Transvaal (see also fig. 14-44). Workings in Beryl Hill were underground while No. 5 on Cobra Hill and No. 4 were being developed as opencast mines. The workings all belonged to Cobra Emeralds, Ltd., at the time of the publication of this map in 1939 by O. R. Van Eeden et al. in "The Mineral Deposits of the Murchison Range East of Leysdorp," *Memoirs of the Geological Survey of South Africa* 36.

(1) Rooiwater igneous complex and quartz porphyries along the NW side, and (2) highly diverse quartzitic metasediments and carbonate rocks which form the spine of the hills, and chloritic and other basic schists which form the lower country around the hills.¹⁰

The emerald deposits all lie within schist masses of relatively small extent which form islands in the old granites south of the range. This "country schist" is composed mainly of amphibole-muscovite schist, but also contains talcose and pennininitic-chloritic types, usually with small amounts of sphene and magnetite as accessories. The original schists are locally altered into biotite schists which grade insensibly into the amphibole-muscovite schists previously mentioned. In some deposits there are talc-biotite schists which contain large crystals of actinolite. Schist layers strike between E-W and NW-SE and are vertical in dip or nearly so. Granitic pegmatite bodies, from several cm to 4.5 m (15 ft), intrude

the schists along the foliation as a rule, but sometimes are cross-cutting. Later quartz veins are also present, commonly cutting across the pegmatite bodies or forming small lenses in the biotite schists. Fig. 14-46 shows the relationships in an exposed outcrop section after Le Grange.²⁶

The granitic pegmatites contain beryl in places, and it is believed that the emeralds formed in the schists through transfer from these bodies of the necessary beryllium. The pegmatite is generally coarse-grained and consists principally of microcline, quartz, mica, and black tourmaline. Tongues of pegmatite also intrude the schist and develop aplitic areas of albite, quartz, and mica with the contacts containing colorless apatite and red garnet crystals.²⁶ Emerald occurs in the biotite schist but small amounts were noted as fractured and quartz-cemented crystals in sugary vein quartz. Minerals of the deposits are fluor-apatite, aquamarine, common beryl, emerald, biotite, chalcopyrite, clinocllore, almandine-spessartine,

World Sources of Ore and Gem Beryl / Republic of South Africa

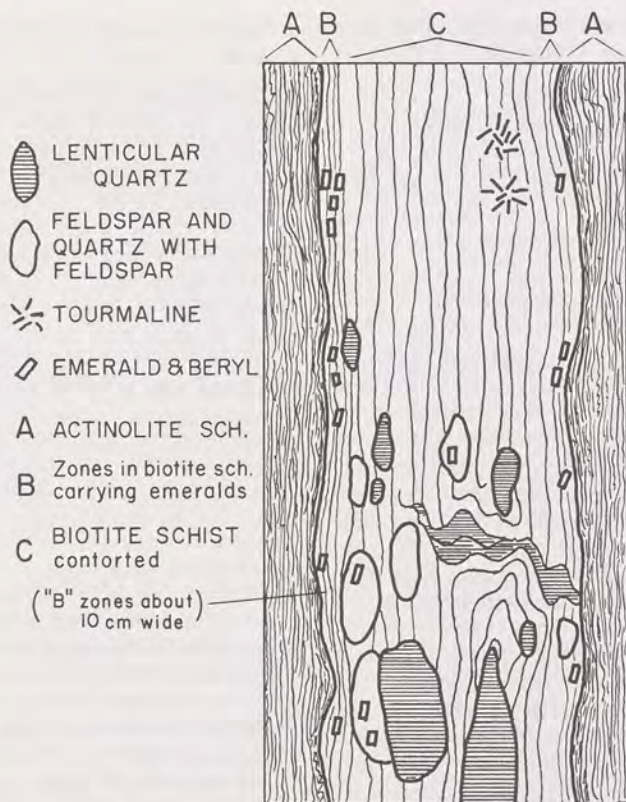

Fig. 14-46 Cross-section of emerald-bearing biotite vein, Barbara Farm, Leysdorp district, Murchison Range, Transvaal. After J. M. Le Grange, "The Barbara Beryls . . ." *Transactions of the Geological Society of South Africa* 32 (1929).

magnetite, Mn-oxides, microcline, molybdenite, molybdenite, muscovite-sericite, nontronite, plagioclase, pyrite, quartz, scapolite (rare), and tourmaline.¹⁰

Beryl ranges through all shades of white or colorless to intense emerald green, also through grayish white to gray, and from pale green to dark blue green. Pale brownish green to pale brown crystals also occur. Many crystals are color-zoned parallel to the prisms but sometimes parallel to the basal plane, and such zones may be white or colorless, or sometimes faint pink, enclosed in green (see fig. 8-1). Inclusions are common: small biotite flakes in green zones in addition to swarms and swarm-veils of typical gas-liquid inclusions, also at times, pyrite crystals.

Specific gravity variable, for emerald $G = 2.744$ average, for common beryl 2.725 average.

Table 14-38
REFRACTIVE INDEXES FOR
SOUTH AFRICAN EMERALD²⁷

Wave Length Å	<i>o</i>	<i>e</i>	Diff.
4308 (G)	1.5961	1.5887	0.0074
5893 (Na)	1.5850	1.5787	0.0063
7188	1.5807	1.5743	0.0064

Fluorescence under UV variable, blueish white

BERYL LOCALITIES

for some emeralds and beryls.¹⁰ Kovaloff gave the following analysis of emerald:¹¹

Table 14-39
ANALYSIS OF SOUTH AFRICAN EMERALD¹¹

Percent		Percent		Percent		
SiO ₂	61.20	Cr ₂ O ₃	0.25	BeO	14.60	
Al ₂ O ₃	17.20	CaO	0.17	Na ₂ O	0.85	
Fe ₂ O ₃	1.80	MgO	1.70	Ign. loss	1.85	
					Total	99.62

G = 2.60–2.75; R.I. aver. 1.57, diff. 0.006.

The emerald crystals are usually elongated single prisms with rounded or obscure terminations, some are broken or "bent," and others form aggregates, divergent groups, etc. Most are tightly wrapped with biotite folia and all faces are rough. On the other hand, other beryls, especially the colorless, may be sharp and glassy-faced with well-developed *m* and *c* faces and the second order prism. The size is extremely variable, Wollin found minute, highly perfect crystals, some doubly-terminated, but only several mm in thickness, among the "fines" from the wash material.²⁵ He also mentioned crystals toward the other extreme as up to 80 carats in weight (common) and some to 400 carats. A giant crystal was reported by Frey as 35 × 14 cm (14 × 5.5 in) and weighing 24,000 carats or about 11 lb.²⁸ A maximum reported length of 10.5 inches was given by Ball (pp. 2-3).²³ Other large crystals include one of 1629.6 carats found in 1959 as a waterworn prism in the Letaba district and picked up from the surface at some unspecified point.²⁹ However, the usual size of emerald crystals is considerably smaller. According to a flow sheet of the Cobra Emeralds mine, processed stones are passed through a sieve with 3 mm diameter holes, the stones dropping through being classed as "small" and those passing on are taken out as "oversize" or "contract emeralds."¹⁰ The Lone Hand mine sold unsorted mine-run crystals to India which averaged only 3–5 carats each.

In 1938, Cobra Emeralds, Ltd., marketed the following grades with Grade 3 being the standard quality:

Grade No.	1.	1% of the whole
	2.	2.5% of the whole
	3.	32.0% of the whole

4.	44.0% of the whole
5.	20.5% of the whole

According to Van Eeden et al., "The No. 3 grade is the standard quality which is taken by the buyers at 2s.6d per carat, while the two high class grades, which amount to only 3.5 percent of the output, are set-off against a certain number of carats of Nos. 4 and 5 grades on an agreed formula and bought at an average of 2s.6d. per carat. In the above distribution there is an excess of Nos. 4 and 5 grades . . . this . . . amounts to about 40 percent of the output and the stones called 'rejects' are sold at 12s.6d. per ounce. Smalls are sold at 5d. per carat" (pp. 110–1).¹⁰ Characteristically, Transvaal emerald cut gems are small, usually numbering several stones to the carat. Stones of several carats are uncommon and those over 5 carats rare, although essentially clean gems of about 10 carats have been cut.

Properties and Locations

The Beryl Mine Group comprises the Somerset mine of the Beryl Mining Co., Ltd., and the workings of Emeralds South Africa, Ltd., along with the workings of South African Emeralds on Somerset Hill, the latter located 15 km (8.5 mi) ENE of Gravelotte (25°54.5' S, 30°45' E). The hill is accessible by road from Gravelotte. The New Hope Group comprises the mines of Barbara Emeralds, Union Emeralds, and South African Emerald Corporation and is located 10.3 km (6.5 mi) almost directly E of Gravelotte and 3.6 km (2.3 mi) directly S of the Beryl Mine Group. The Lone Hand Group comprises properties of African Emerald Co., Arundel Emeralds, Anglo-French Emerald Co., Leysdorp Emerald Syndicate, Ltd., Lone Hand mine, and Selati Emeralds. It is centered 7.8 km (4.9 mi) SE of Gravelotte in a NW–SE belt of schists and covers a distance of about 2 km (1.25 mi) in a belt adjacent to the Selati River. The Cobra Group comprises Cobra Emeralds, Ltd., and African Emeralds Corp., Ltd., and is located in Germania Koppies 4 km (2.5 mi) SE of Gravelotte¹⁰ as shown in fig. 14-45. This data reflects the situation in 1939, much of which may have changed by now.

According to Van Eeden et al.,¹⁰ other non-emerald beryl occurrences in the Murchison Range are three deposits centered 7.3 km (4.7 mi) S and SW of La France and bearing ENE from Gravelotte, plus an isolated occurrence at

World Sources of Ore and Gem Beryl / Republic of South Africa

20 km (12.6 mi) ENE of Gravelotte. In the 1950's a "beryl boom" was experienced in the low veld country about 48 km (30 mi) E of Gravelotte when large quantities of ore beryl were found upon the dumps of a tantalite-columbite pegmatite mine on Farm Leeuwspuit, where it had been mistaken for quartz and discarded. For a short time, 50 tons per month were recovered.²³ Nearer to Gravelotte, deep blue aquamarine was found on Farm Arundel 483, Farm Thankerton 527, and Farm Willie 481. The Arundel deposit, now exhausted, was in pegmatite on the bank of the Selati River. The Willie deposit furnished aquamarine crystals both from granitic pegmatite and invaded biotite schists.¹⁰

Elsewhere in the Transvaal, common beryl is reported near Martinsdrif and Mopane Station N of Soutpansberg, and at Soekmekaar on the farm of the same name; also on Farm Welgevonden about 18 km (12 mi) from Mooketsi Station, and on Farm Kitchener in Pietersburg district in the extreme N of Transvaal.^{7,23} A minor emerald in biotite-schist deposit is reported at Uitvalskop in the Schweizer Reneke district.²³ The Keetmanshoop district produced several hundred tons of ore beryl.³⁰

Finally, in what may well be an erroneous report, Harger "read and heard" of several emerald discoveries in the Kalahari Desert.³¹ In 1911, a prospector by the name of P. Boyle reported to the *Northern News* that the "finest parcel of emeralds ever cut by Messrs. Streeter of London, was found in the western districts of Gordonia; they were valued at 65,000." Another equally unverified story concerns an "Emerald Valley" in the Kalahari in which a certain Mr. Norton is said to have found emeralds which were subsequently disposed of in London. The map of the northern Kalahari shows a Norton Valley at a point about 160 km (100 mi) W of the S shore of Lake Ngami, but apparently no one has reported emeralds from that place.

1. Rogers, A. W. 1915. Notes on the occurrence of radioactive minerals in South Africa. *Transactions of the Geological Society of South Africa* (Johannesburg) 18:5-10.
2. Remarkable beryl discovery. 1929. *South African Mining and Engineering Journal* 40:477-80.
3. Kovaloff, P. 1930. Notes on the beryl occurrences in Namaqualand. *International Geological Congress, 15 Session, South Africa, 1929, Compte Rendu 2* (Pretoria) pp. 439-43.
4. Mountain, E. D. 1931. Pegmatites of the Cape Prov-

ince. *Records of the Albany Museum, Grahamstown, South Africa* 4:122-44.

5. Gevers, T. W.; Partridge, F. C.; and Joubert, G. K. 1937. The pegmatite area (South of the Orange River) in Namaqualand. *Memoirs of the Geological Survey of South Africa* 31 (Pretoria), 180 pp.
6. Union of South Africa. 1959. *The Mineral Resources of the Union of South Africa*. 4th ed. Department of Mines, Geological Survey. Pretoria: The Government Printer. 622 pp.
7. Union of South Africa. 1940. *The Mineral Resources of the Union of South Africa*. Department of Mines, Geological Survey. Pretoria: Govt. Printer. 544 pp.
8. Union of South Africa. 1964. *Department of Mines, Quarterly Information Circular*, no. 120 (Pretoria), 108 pp.
9. Transvaal emeralds. 1928. *South African Mining and Engineering Journal, Yearbook*, pp. 585-8.
10. Van Eeden, O. R.; Partridge, F. C.; Kent, L. E.; and Brandt, J. W. 1939. The mineral deposits of the Murchison Range, east of Leysdorp. *Memoirs of the Geol. Survey of S. Africa*, no. 36 (Pretoria), 163 pp.
11. Kovaloff, P. 1928. Geologist's report on Somersset emeralds. *South African Min. and Eng. Journal*, 39:101-3.
12. Kunz, G. F. 1930. Precious stones. Chapter in *The Mineral Industry during 1929*, gemstones pp. 530-54. New York: McGraw-Hill Book Co.
13. The position and prospects of beryl mining. 1929. *South African Min. and Eng. Journal* 40:223-4.
14. Transvaal emerald field. 1929. *The Mining Magazine* (London) 40:225.
15. Leysdorp Emerald Syndicate, Ltd. 1929. *The Mining Journal* 167:904.
16. Kunz, G. F. 1932. Precious and semi-precious stones. Chapter in *The Mineral Industry during 1931*. Vol. 40, gemstones pp. 458-80. New York: McGraw-Hill Book Co.
17. Roush, G. A. 1934. Precious and semi-precious stones. Chapter in *The Mineral Industry during 1933*. Vol. 42, pp. 488-509. New York: McGraw-Hill Book Co.
18. The position of the Beryl Mining Company. 1930. *South African Min. and Eng. Journal* 41:470-1.
19. Ball, S. H. 1940. Gem stones. Chapter in *U.S. Bureau of Mines Minerals Yearbook for 1940*, 13 pp.
20. ———. 1939. Gem stones. Chapter in *U.S. Bureau of Mines Minerals Yearbook for 1939*, 12 pp.
21. ———. 1947. Gem stones. Chapter in *U.S. Bureau of Mines Minerals Yearbook for 1946*, 13 pp.
22. Ball, S. H. and Josephson, G. W. 1949. Gem stones. Chapter in *U.S. Bureau of Mines Minerals Yearbook for 1948*, 12 pp.
23. Union of South Africa 1960. Gem-stones other than diamonds. The Mineral resources of the Union of South Africa. *Geological Survey Handbook 1959*. 11 pp.
24. Hartwell, J. W., and Brett, B. A. 1963. Gem stones. Chapter in *U.S. Bureau of Mines Minerals Yearbook for 1962*, 13 pp.
25. Wollin, J. C. 1968. A rockhound visits Southern Africa. Part 3. *The Lapidary Journal* 22:756-65.
26. Le Grange, J. M. 1929. The Barbara beryls: a study of an occurrence of emeralds in the north-eastern Transvaal . . . in the Murchison Range. *Transactions of the Geological Society of South Africa* 32:1-25.

BERYL LOCALITIES

27. Vogel, P. 1934. Optische Untersuchungen am Smaragd und einige durch Chrom gefärbten Mineralien. *Neues Jahrbuch für Mineralogie* (Stuttgart) 68:401-38.
28. Frey, E. 1956. Ausserordentlicher Smaragdfund. *Deutsche Goldschmiede-Zeitung* 54:609.
29. Leiper, H. 1959. New South African emerald find. *The Lapidary Journal* 12:722-8, *passim*.
30. Booyesen, B. 1959. Pegmatites: hints to prospectors. *Geological Survey of S. Africa Information Pamphlet* 6. 57 pp.
31. Harger, H. S. 1927. The emerald discovery. *South African Min. and Eng. Journal* 38:351-2.

ROMANIA

In the E Banat and parts of the W Transylvanian Alps, many pegmatite deposits have been worked for rare minerals since 1925. In the Voilava area on Tilfa Mountain there is a broad pegmatite field in amphibolite, with bodies to 3 m (10 ft) across containing green beryl, apatite, tourmaline, mica, spessartine, and other species, with beryl next to core quartz. At Armeniş, Caransebeş region, in the extreme W of the Banat and near Teregova, well zoned bodies occur with small beryl crystals; some larger bodies yielded crystals to 11 kg (24 lb); forms: *m* and *c*, also {10 $\bar{1}$ 1}; {11 $\bar{2}$ 1}; {21 $\bar{3}$ 1}.^{1,2,3,4} In 1957 one ton of ore beryl was produced at Teregova. Species in these pegmatites include feldspars, quartz, beryl, niobite, tantalite, montebrasite, zircon, spessartine, spodumene, cassiterite, molybdenite, monazite, apatite and lepidolite. Some bodies contained cavities lined with exceptionally clear large quartz crystals with feldspar, dolomite, pyrite, bismuthinite and calcite. Analysis of Teregova beryl may be found in Schadler.⁵

In the SE Banat, beryl-bearing pegmatites exist at Toplitz in Tre Cucuie Mountains; in pegmatite at Pîrvova, Bozovici region, S Banat. In E Banat they occur at Muntele Mic and Pelveanu where granitic pegmatites are emplaced in schist; beryl crystals to 50 cm (20 in) long.⁶ Alluvial beryl fragments occur around massif of Muntele Mic.⁴

Semi-transparent crystals in pegmatite may be found at Gemenea, Dealul Feletin, Cîmpeni region in S Cluj Province of W central Romania.⁴ Small crystals reported in Gilău Massif at Crisani.

In the Transylvania Alps, N of the valley of Lotru and between Lotru and Sadu, beryl-bearing pegmatites form at least 100 bodies in an extensive field at high elevations. Beryl occurs in pegmatites at Muntele Rece, Răzoare in Laposch Mountains, and Munte Mare.⁷ The Răzoare locality is in Valea Sunatorii, Lăpus region, and

crystals to 8 cm (2.3 in) have been found; forms: *m* and *c*, also {1120} and {21 $\bar{1}$ 0}.⁴

1. Kirnbauer, F. 1931. Das Feldspatvorkommen von Teregova (Banat). *Berg- und hüttenmännischen Jahrbuch* (Leoben) 79:109.
2. Superceanu, C. 1957. Minerale rare in pegmatitele granitice din Banat. *Revista Minelor* (Bucharest) 3:140-54.
3. Dittler, E. 1931. Über ein neues Beryllvorkommen aus Teregova in Rumänien. *Tschermak's mineralogische und petrographische Mitteilungen* (Vienna) 41:474-6.
4. Rădelescu, D., and Dimitrescu, R. 1966. *Mineralogia topografică a României*. Bucuresti: Editura Academiei Republicii Socialiste România. 376 pp.
5. Schadler, J. 1930. Ein neues Beryllvorkommen (Teregova, Banat). *Verhandlungen der geologischen Bundesanstalt* (Vienna) 1930:224-5.
6. Schafarzik, F. 1899. Die geologischen Verhältnisse der Umgebung von Borlowa und Poiana Mărul. *Jahresbericht der k. ungarischen geologischen Anstalt* (Budapest) 1899:120-56.
7. Rotmann, D. 1922. Die Glimmerlagerstätten vom Lotru-Gebirge (Rumänien). *Annales des Mines de Roumanie* (Budapest) vol. 5.

RWANDA-BURUNDI

Beryl-bearing pegmatites are clustered in Rugendabari-Katumba region, accessible by road from Bohengari to Gitarama. The bodies are partly albitized and contain muscovite, large beryl crystals and amblygonite in pockets of greisen. The beryl crystals are whitish-cream, simple prisms, about 24 cm (9.5 in) in diameter and length. Beryl also occurs in strongly albitized bodies containing cassiterite and columbite-tantalite; green and white crystals to 5 cm (2 in). Between Kirengo and Bijojo there are muscovite pegmatites with large beryl crystals.^{1,2} Beryl occurs in mineralized granitic pegmatite at Buranga, about 1 km (0.6 mi) N of mining center of Gatumba, the body occupying a surface area of several hectares, and noted for rare phosphate species within a total of 91 recorded minerals; beryl crystals are simple pale yellow prisms, or sometimes blueish or greenish.³

1. Varlamoff, N. 1954. Répartition des types de pegmatites autour de la partie nord-ouest du grand massif granitique de Nyanza (Ruanda, Afrique). *Annales de la Société Géologique de Belgique* (Liège) 78:1-25.
2. Bertossa, A. 1961. Quelques aperçus sur les pegmatites de la region de Katumba. *Rapport Annuel du Service Géologique de Ruanda-Urundi* 1:17-22.
3. ———. 1965. La pegmatite de Buranga. *Bulletin du Service Géologique, République Rwandaise* 2:1-15.

SOMALI REPUBLIC

In the NW part granitic muscovite and beryl pegmatites occur in a large lens-shaped field ori-

World Sources of Ore and Gem Beryl / South West Africa (Namibia)

ented E-W, one end at Bawn, the other about 46 km (28 mi) SSW of Bulhar on the Gulf of Aden. The length is about 120 km (75 mi), the greatest width about 37 km (23 mi). Localities are at Mirid, Wai-Wai, Il Haggar, Bawn, Theb, Waran-Weis, Hamar, Marodile, Ubali. Common beryl, crystals to 0.9 m (3 ft) long and 30 cm (12 in) diameter, white, pale blue, pale green, pale blue being most common; some crystals color-zoned. R.I.: $n_o = 1.580 \pm 0.002$. BeO ca. 13%.¹ Farquharson² and Pallister³ provide general remarks on this field, and note a production of ore beryl at Darreh Hos (Durriehauseh) and production of 33 tons in Henweina Valley around that place up to end of 1956. Beryl also occurs in tin-bearing quartz veins near Dalan, Erigavo district in the NE of the country, and in very minor amounts in pegmatites near Sikoba River, N of Gebile in Hargeisa district; also from Dobo Yer (Dobo Wein) in Borama district.³

1. Daniels, J. L. 1960. Minerals and rocks of Hargeisa and Borama districts. *Somaliland Ministry of Natural Resources, Minerals Resources Pamphlet 3*, 25 pp.

2. Farquharson, R. A. 1926. Geology and mineral resources of British Somaliland. *The Mining Magazine* (London) 34:265-76, 329-40.

3. Pallister, J. W. 1958. Mineral resources of Somaliland Protectorate. *Great Britain, Directorate of Overseas Geological Surveys, Geology and Mineral Resources* (London) 7:154-65.

SOUTH WEST AFRICA (Namibia)

A very large region of granitic pegmatites covers much of the central and extreme S portions of this country. In the Warmbad district of the S, ore beryl, seldom with less than 12% BeO, has been produced in substantial quantities, e.g., in 1952 and 1953, production was 592 and 590 tons respectively.¹ Beryl is also common in the great Erongo tin field lying immediately NW of Karibib; this field extends 220 km (140 mi) in a belt that contains at least 1700 pegmatite bodies, some with beryl.^{2,3} A few bodies, such as those at Rössing and Spitzkopje, are world famous for golden beryl and gem aquamarine, as discussed below. Ball recorded a production of gem beryl from this area of 7,240 gm from 1937-39, of which 4,550 gm were exported.⁴

Beryl in pegmatites had been known since 1893,⁵ but early interest attached to cassiterite, and only later, when the gem pegmatites at Rössing were opened in 1910 for quartz, tourmaline and topaz as well as beryl, did interest in such bodies result in explorations for the sake of gemstones

alone. Most beryl pegmatites are distinctly zoned. Many formed as pegmatitic phases within coarse-grained granitic masses as stocks, bosses, etc.,^{6,7} but others are sharply-defined bodies emplaced in granites or in schists and gneisses. In cassiterite-rich bodies,miarolitic cavities are common and from these were obtained superb crystals of beryl, topaz, quartz and other species, which have found their way into collections all over the world. In recent years, exploitation of lithium pegmatites has produced large amounts of pollucite, petalite, and amblygonite as well as spodumene. Because of the great abundance of bodies, the potential for discoveries of mineralogically interesting pegmatites in the future is great.

Brandberg. This location is 160 km (100 mi) NW of Karibib; cassiterite pegmatites formed as schlieren in a red granite; associates include tourmaline, quartz and sometimes beryl. Numerous outcrops exist along the Ugab River.⁸

Omararu Area. Numerous complex, cassiterite pegmatites in a NE-SW belt contain scheelite, wolframite, tantalite-columbite, lepidolite, fluorite, garnets, apatite, triphylite, topaz, tourmaline, beryl, and albite.^{9,10} The Humdigams body, located 88 km (55 mi) NW of Karibib, a cassiterite pegmatite, contained vugs lined with beautiful small crystals of beryl, as did also the Meridas pegmatite, located 85 km (54 mi) NW of Karibib and about 13 km (8 mi) NE of Humdigams.¹⁰ A little, beautiful, yellowish green beryl in crystals to 15 cm (6 in) long was found in quartz lenses in the Paukwab bodies, about 4 km (2.5 mi) ENE of the Meridas deposits. Beautiful, clear, pale green aquamarines occur in quartz pods in a strongly greisenized pegmatite in Kohero field, Farm Kawab No. 117, about 72 km (45 mi) NNE of Karibib.¹⁰ Beryl pegmatites exist at Nareis, 77 km (48 mi) NW of Karibib. Kranzberg or Krantzberg, 40 km (25 mi) N of Karibib, is noted for common beryl in cassiterite pegmatites but also for green crystals in cavities associated with cassiterite and tourmaline. Pegmatite bodies N of Kranzberg produced part-gem crystals 10 × 3 cm (4 × 1.25 in) from strongly greisenized sections; associates were tantalite, fluorite, wolframite, etc. Some beautiful pale green prisms have been found in vugs near contacts with granite and older schist rocks. Beryl occurs in pegmatites at Ameib, 29 km (18.5 mi) WNW of Karibib, also at Ababis, Neu Schwaben, Becker's, Riksburg,

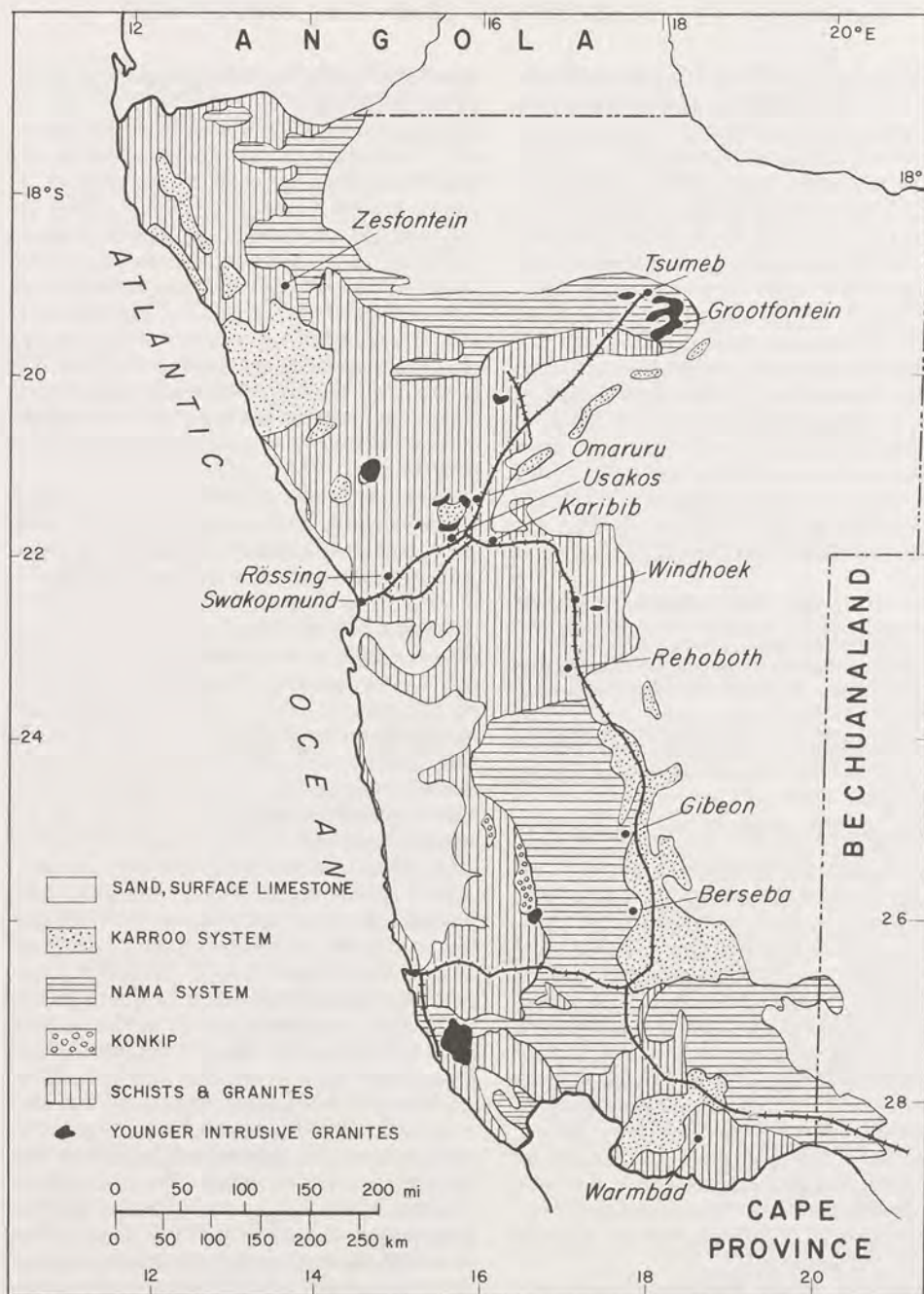

Fig. 14-47 Geological sketch map of South West Africa showing distribution of major rock types and several important towns. Most beryl-bearing pegmatite bodies occur in the schists and granites (vertical lines). Based on a map of H. F. Frommurse and T. W. Gevers, *International Geological Congress, Guide Book Excursion C.21* (South Africa, 1929).

World Sources of Ore and Gem Beryl / South West Africa (Namibia)

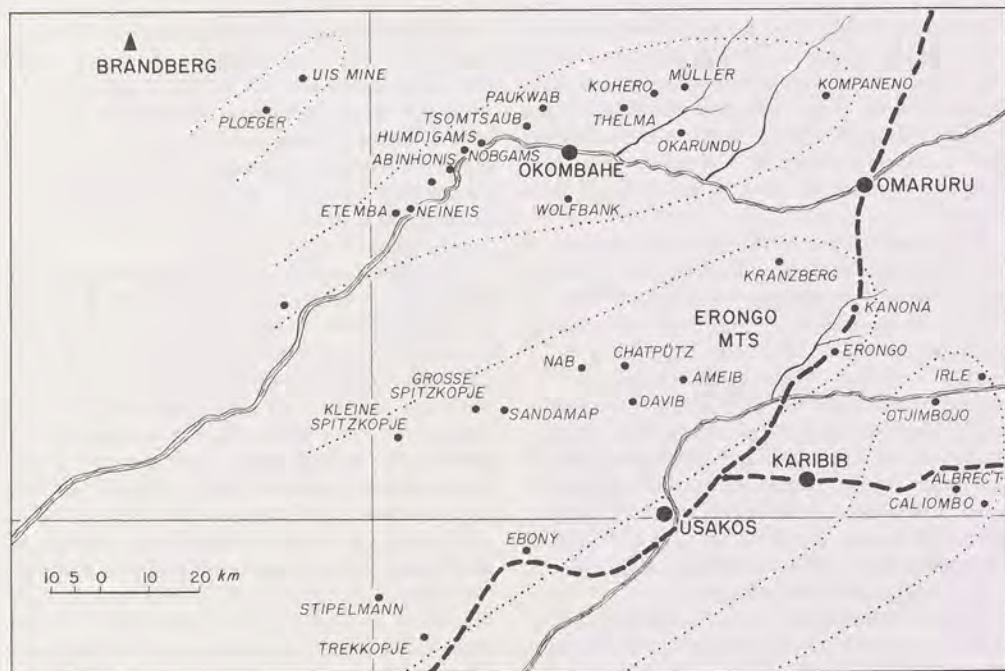

Fig. 14-48 Sketch map of the northwestern portion of Damaraland, South West Africa showing zones of pegmatites and greisens in which cassiterite as well as beryl, topaz, quartz, tourmaline, and other minerals have been found. Based on a map of G. Bürg, *Die nutzbaren Minerallagerstätten von Deutsch-Südwestafrika* (Berlin, 1942).

Dobbelsberg, Okawayo, Brockmann's mine (gem aquamarine), Farm Etamba, Etiro mine (rose beryl), etc.¹¹

Karibib Area. The Dernberg pegmatite body has been mined for beryl (partly altered to bertrandite) and amblygonite and is located 4 km (2.5 mi) W of Karibib.¹¹ Small crystals to 4 cm (1.5 in) of greenish white color occur in outer zones of the 960 m (3200 ft) long Rubicon pegmatite body located on Farm Okongava, 22 km (14 mi) SE of Karibib; much larger crystals, 8–46 cm (3–18 in) wide and to 150 cm (30 in) long, occur in intermediate zones but only small white crystals to 5 cm (2 in) in the core. This body was rich in petalite and amblygonite. The Helicon bodies on the NE corner of Farm Okongava, 20.5 km (13 mi) ESE of Karibib, contained a few whitish crystals to 15 × 10 cm (6 × 4 in); this pegmatite was rich in pollucite and amblygonite. On the Van der Made property, along

the W wall of Erongo Schlucht (ravine), simple to complex pegmatites, some with beryl, have been found. A large body near the farmhouse is exposed for 425 × 120 m (1450 × 400 ft) and contained beryl prisms to 100 × 50 cm (38 × 20 in) in an intermediate plagioclase-quartz unit traced for 90 m (300 ft). At the Tinschmann mine, Farm Ost, beryl may be found in alluvium and in quartz pods.¹²

Windhuk District. Small white common beryl crystals occur in granitic pegmatites of Karlsbrunn area, 6.3 km (4 mi) SSW of the Albrechtshöhe railway siding, on the main line from Windhuk to Walvis Bay. Zoning in Karibib-Windhuk pegmatites was specially studied by Roering.⁷

Donkerhuk District. Numerous, elongated, zoned pegmatite bodies in biotite granite, located generally 125 km (78 mi) SSE of Swakopmund, contain Nb-Ta species, beryl, uraninite, rare earth species, sulfides and Li minerals; quartz cores are

BERYL LOCALITIES

common, with beryl occurring around them as greenish tabular crystals, with apatite crystals and other species.^{10,13} Beryl in pegmatites may be found between Hope mine and Naramas, about 115 km (72 mi) SE of Swakopmund; crystals are blueish green or white, 20 × 4 cm (8 × 1.6 in). Similar occurrences occur 14 km (8.8 mi) E at Niguib.¹⁰

Warmbad District. This is in the extreme S of the country, along the Orange River, with the pegmatite field crossing over into South Africa, (q.v.). At Hackiesdorn, 75 km (47 mi) SW of Warmbad, crystals of ore beryl range to 75 × 22 cm (30 × 8.6 in). Other localities are: Gaobis, about 50 km (33 mi) SW of Warmbad, and Hochfeld, 30 km (19 mi) SW.⁶ Numerous granitic pegmatites, some with scattered beryl crystals, occur in Tantalite Valley, Umeis Farm, about 40 km (25 mi) S of Warmbad; yellowish prisms to 30 cm (12 in) mined for ore. Beryl occurs also in bodies at the bend of Krom River and along the borders of farms Umeis and Kinderzitt, etc.¹²

Kleine Spitzkopje. Both Kleine Spitzkopje (1580 m) and Grosse Spitzkopje (1750 m) rise steeply from the Namib Plain about 110 km (69 mi) NE of Swakopmund, or 55 km (35 mi) WNW of Usakos. The Grosse Spitzkopje is about 15–17 km (9.4–11.6 mi) NE of its smaller namesake. Both are remnants of Erongo granite massifs that rose through post-Algonkian metamorphic rocks consisting of schists, quartzites, marbles, and amphibolites.¹³ Many pegmatitic schlieren bodies with cavities occur along the edges of the granite of Kleine Spitzkopje, notably along the SE base of the mountain, and it is this area that is famous throughout the world for its production of splendid crystallized specimens.

Cavity openings reach several square meters across and may be many meters long as shown in fig. 14-49, but smaller openings, on the order of several cm to 10 cm (4 in) across, are more typical.¹⁴ In such cavities occur euhedrons of beryl and topaz, in part gem quality, associated with quartz, microcline, fluorite, mica, albite, phenakite, siderite, bertrandite, chlorite, nacrite, stiepelmannite, ilvaite, allanite, and pyrite, together forming a suite of minerals as remarkable for their variety as for the rarity of some of its members. Species deposited later are limonite, Mn oxides, hyalite, and calcite. The rock adjacent to cavities is strongly altered into a porous, coarse-grained, beryl-tourmaline-quartz rock. Beryl appeared in several generations, microcline is

completely altered, and upon it rests the first generation of quartz, orthoclase, mica, beryl, topaz, and fluorite, as well as further generations of these species plus phenakite, bertrandite, and siderite. The last minerals to form were yttrifluorite, quartz, and albite. Phenakite is abundant in compact masses, as drusy aggregates in cavities, as coatings on microcline crystals, and as single or twin crystals.¹³

Early beryl crystals are clear aquamarine and golden beryl, commonly corroded and containing tubes parallel to the *c*-axis. Others are murky due to numerous liquid inclusions. While both varieties occur near each other, they do not occur in the same cavity. As a rule, golden beryl is associated with pale yellow fluorite and mostly confined to the smaller vugs, with the gem grade crystals usually associated with scaly mica. The largest prisms are 12 × 5 cm (4.7 × 2 in). While golden beryl is commonly corroded, the effect of dissolution is even more severe on the aquamarine crystals, with faces of {1121} attacked more than those of {1010}, {0001}, and {1011}. Prism faces of *m* {1010} are commonly striated with more or less parallel channels. For all golden beryls predominant forms are *m* {1010}, *c* {0001}, and {1121}; also smaller in size and sometimes absent are faces of {1120}.¹³

Colors range from deep golden yellow to pale to yellow green, the latter at times reminiscent of peridot, and also into colors that are nearly pure blue. Cloudy crystals are filled with minute gas-liquid inclusions with the gas bubbles disappearing at 246°C ± 1°.¹⁴

In contrast to golden beryls, aquamarines are stubbier in habit with {0001} less prominent and with corroded faces of {0001}, {1010}, and {1121}. All degrees of sharpness of these crystals have been noted, from some so severely corroded that no traces of original faces remain, to others that are almost untouched, hence sharp and brilliant. Severely corroded crystals sometimes become so loose in their matrix that they drop from their "sockets" and are found loose in the floor debris of cavities. In such cases, they are commonly accompanied by abundant phenakite and bertrandite which presumably formed at their expense. Vacant, beryl-shaped cavities are often found in solid quartz, in massive scaly mica, in the crusts over microcline, and elsewhere, indicating that much early-formed beryl had dissolved during later stages of mineralization. Other remarkably fine crystals that occur in these cavities

World Sources of Ore and Gem Beryl / South West Africa (Namibia)

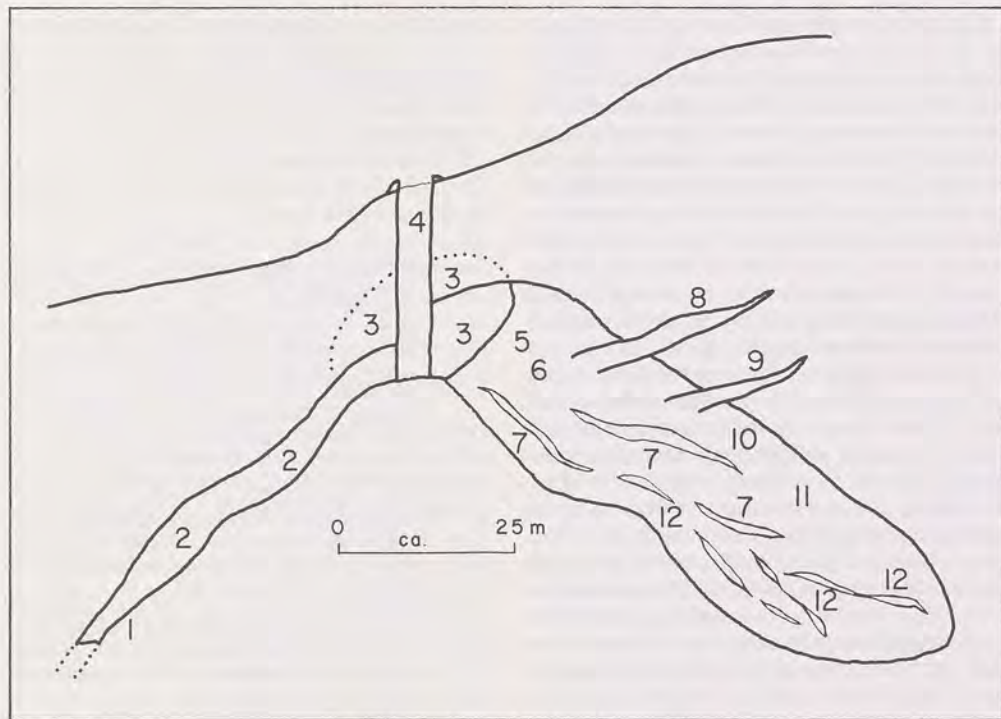

Fig. 14-49 Cross-section of a miarolitic-greisen deposit yielding aquamarine and golden beryl at Kleine Spitzkopje, South West Africa. 1. Water level; 2. open cavities with large quartz crystals; 3. fine-grained massive quartz with albite; 4. shaft; 5. orthoclase, bertrandite, and phenakite; 6. massive, fine-grained mica, phenakite, bertrandite, and corroded beryl; 7. blue beryl crystals in veinlets with feldspar; 8. two tube-like cavities with large mica crystals; 9. also beautiful but pale beryl crystals; 10. giant altered topaz crystals; 11. an area rich in phenakite; and 12. yellow beryls in scattered nests and stringers, often with yellow fluorite. From P. Ramdohr, "Eine Fundstelle von Beryllium-Mineralien im Gebiet der Kleinen Spitzkopje, Südwestafrika, unde ihre Paragenese." *Neues Jahrbuch für Mineralogie* . . . Beilage Band 76, Abt. A. (1940) p. 3.

are sharp, colorless crystals of topaz, late-stage quartz in sharp, complex crystals, fluorite in several hues, curious oriented overgrowths of small albite-quartz groups, phenakite crystals to 1 cm across in aggregates or sometimes in singles to 3 × 1 cm (1.25 × 0.4 in), and crystals of bertrandite.

Rössing. This classic mineral locality was first brought to the attention of the world when E. Reuning, in 1910, discovered a series of remarkable, complexly mineralized granitic pegmatites about 5 km (3.3 mi) N of Rössing railway station, at a point about 35 km (22 mi) ENE of Swakopmund. The deposits were worked on a small scale prior to World War I and produced gem

aquamarine and golden beryl, the latter partly of the heliodor variety, as well as excellent, rich-hued, rose quartz and numbers of splendid mineral specimens.¹⁵ Mining ceased during the war, and was not resumed until early in 1921,¹⁶ from which period a production of 7,390 gm of gem beryl was recorded by Bürg.¹⁰

The main pegmatite is a "blanket" or sheet-like body dipping at a low angle, exposed over an area of about 550 × 320 m (600 × 350 yd), and ranging in thickness from less than 1 m to 4 m (1–12 ft). Both the main body and adjacent sheets are more or less concordantly intruded in quartz-biotite schist. Common beryl occurs in crystals to 80 × 20 cm (32 × 8 in) in the inter-

BERYL LOCALITIES

mediate zones while beryl prisms that are mostly white but also rose occur in cavities in the quartz core units, accompanied by colorless or smoky euhedrons of quartz.¹⁶ North of the main body is another of smaller size containing mostly smoky to white quartz in its core. Golden yellow to brownish yellow crystals are also found here, and these were touted in Europe as possessing remarkable properties that set them off from other golden beryls, thus justifying the name "heliodor," first applied to these crystals. Claims of unusual properties for these specimens were systematically rebutted by Eppler.¹⁷

In summary, beryls found in the Rössing bodies appear in every state from the common, dull, cloudy and fractured crystals of grayish, greenish gray, greenish yellow, pale blue green and blueish crystals, the largest which are found in the bodies, to those that occur in vugs and hence are smaller, but gemmy, and afford fine, sharp, aquamarine and golden beryl crystals. The aquamarines in particular, afford the largest clear areas suitable for faceted gems and range in color from nearly colorless, very pale blue, to blueish green and yellowish green. Their density was found to be 2.692–2.694. Golden beryls range from golden yellow to brownish yellow, some crystals displaying a "peculiar opalescence" according to Wagner.¹⁶ The radioactivity claimed for the heliodor variety, noted above, seemed to be established by the presence of a small amount of uranium as shown in the following analysis of Hauser and Herzfeld, *Chemiker Zeitung* (Cöthen), June, 1914:

Table 14-40
CHEMICAL ANALYSIS OF HELIODOR
FROM RÖSSING

	Percent	Percent	Percent
SiO ₂	66.89	BeO	13.88
Al ₂ O ₃	13.60	Fe ₂ O ₃	0.55
G = 2.68–2.685		U ₃ O ₄	0.02–0.04 ^a

^aSchneiderhöhn (p. 166)¹³ gives 0.2–0.4%

Inclusions are characteristic, sharply-defined bands parallel to the basal plane, or more rarely, parallel to prism faces. Such consist of 1-, 2-, and 3-phase inclusions. Commonly one part of the crystal may be clear, and other parts cloudy, and in some, clear gem-grade material may be obtained from cores within otherwise badly

cracked crystals. On the whole, the best crystals do not exceed about 10 cm (4 in) in length. A distinctive feature is richness in prism faces which often imparts a cylindrical aspect; forms: *m* and *c*, also {11 $\bar{2}$ 0}, {21 $\bar{3}$ 0}, {1011}, {11 $\bar{2}$ 1}.^{15,16} *G* = 2.675–2.686; a clear, flawless aquamarine gave 2.692–2.694; heliodor 2.680–2.685; a clear gem of heliodor gave 2.693.¹⁵

- Paine, L. G., and Wilson, P. T. 1954. Mineral resources of South-West Africa. *The Mining Magazine* (London) 91:329–35.
- Gevers, T. W., and Frommurze, H. F. 1930. The tin-bearing pegmatites of the Erongo area, South-West Africa. *Transactions of the Geological Society of South Africa* (Johannesburg) 32:111–49.
- Reuning, E. 1923. Pegmatit und Pegmatitminerale in Südwestafrika. *Zeitschrift für Kristallographie und Mineralogie* (Leipzig) 58:448–59.
- Ball, S. H. 1940. Gem stones. Chapter in *U.S. Bureau of Mines Minerals Yearbook for 1940*. 13 pp.
- Gürich, G. 1893. Geologisch-mineralogische Mitteilungen aus Südwestafrika. 1. Mineralien aus dem deutschen Schutzgebiete in Südwestafrika. *Zeitschrift für Kristallographie*. 21:150–1.
- Roering, C. and Gevers, T. W. 1962. Lithium- and beryllium-bearing pegmatites in the Karibib district, South West Africa. *University of the Witwatersrand, Economic Geology Research Unit Information Circular* 9. 24 pp.
- Roering, C. 1966. Aspects of the genesis and crystallization sequence of the Karibib pegmatites, South West Africa. *Economic Geology* (Lancaster, Pa.) 61:1064–89.
- Dennis, J. G. 1959. Note on some cassiterite-bearing pegmatites near Brandberg, South West Africa. *Economic Geology* 54:1115–21.
- Haughton, S. H.; Frommurze, H. F.; Gevers, T. W.; Schweltnus, C. M.; and Roussouw, P. J. 1939. The geology and mineral deposits of the Omaruru area, South West Africa. *Geological Survey of South Africa, Explanation of Sheet 77 (Omaruru)* (Pretoria) 151 pp.
- Bürg, G. 1942. *Die nutzbaren Minerallagerstätten von Deutsch-Südwestafrika*. Mitteilungen der Gruppe deutscher koloniale wirtschaftlicher Unternehmungen. Vol. 7. Berlin: Walter De Gruyter and Co. 305 pp.
- Knorring, O. v. 1962. Pegmatite and related investigations. *University of Leeds, Research Institute of African Geology, 6th Annual Report, Session 1960–61*. pp. 7–13.
- Cameron, E. N. 1955. Concepts of the internal structure of granitic pegmatites and their applications to certain pegmatites of South West Africa. *Transactions of the Geological Society of South Africa*, vol. 58, reprint, pp. 1–26.
- Schneiderhöhn, H. 1961. *Die Erzlagerstätten der Erde*. Vol. 2: *Die Pegmatite*. Stuttgart: Gustav Fischer. 721 pp.
- Ramdohr, P. 1940. Eine Fundstelle von Beryllium-Mineralien im Gebiet der Kleinen Spitzkoppe, Südwestafrika, und ihre Paragenese. *Neues Jahrbuch für Mineralogie* (Stuttgart) Abt. A, no. 76, pp. 1–35.
- Kaiser, E. 1912. Ein neues Beryll (Aquamarin) Vor-

World Sources of Ore and Gem Beryl / Sri Lanka (Ceylon)

kommen in Deutsch Südwestafrika. *Centralblatt für Mineralogie*, (Stuttgart) 13:385-90.

16. Wagner, P. A. 1922. On some mineral occurrences in the Namib Desert. *Transactions of the Geological Society of South Africa*. 24:71-97.
17. Eppler, A. 1920. Der Heliodor. *Die Umschau* (Berlin) 24:497-500.

SPAIN

Many pegmatite bodies, some beryl-bearing, are associated with a large granite massif that stretches from Galicia in the extreme NW towards the S into Portugal.

La Coruña. Crystals to 15 cm (6 in) have been recorded from Monte Pedroso near Santiago de Compostela.

Pontevedra. Yellowish green or whitish crystals are plentiful in pegmatites between Ramallosa and Carballedo.^{1,2} At Lalin, ca. 50 km (33 mi) NE of Pontevedra, granitic pegmatites, with or without a lithium phase, trend NE-SW in vein-like bodies in mica schists and gneisses; most contain only quartz, feldspars, and micas but occasionally contain beryl crystals of 1 cm size with schorl and arsenopyrite; a few bodies contain spodumene.³ Comba stated that beryl has been found in over 50 localities in Galicia but was mined systematically only at Ornachuelas and Fuenteovejuna.⁴ Sobrino-Buhigas describes a beryl pegmatite located ca. 2-3 km (1.25-1.8 mi) from Pontevedra along the road to Vigo, and another at about Kilometer 107-8 near Campo d'Armida in San Vicente de Cerponzones parish along the road Pontevedra-Santiago de Compostela.⁵ A crystal from the latter deposit measured 300 × 80 cm (118 × 32 in) and weighed 3,450 kg (7,590 lb). Most crystals are associated with quartz, feldspars, micas, and are greenish in color and only translucent in small areas. Some fine clear crystals were found near Puente de Los Molinos on the Pontevedra-Marin road.

Orense. Minor aquamarine beryl occurs in quartz veins bearing wolframite at Pico de Las Melas, Sierra de Jures near the Portugal frontier.⁶

León. Small crystals occur with cassiterite in tin deposits of Zamora;² near Ponferrada in large common beryl crystals.

Oviedo. White beryl occurs at Soto de Los Infantes near Salas.²

Avila. Beryl is mentioned in pegmatites containing albite, columbite, wolframite, garnet, lepidolite, topaz, cassiterite, etc.¹

Madrid. Here beryl occurs in granitic pegmatites at various places in Sierra de Guadar-

rama;² in pegmatites in gneiss of Cordillera Carpetana; N of Madrid in the Cabanillas de la Sierra and at Miraflores; near the bridge of Miraflores de la Sierra on the road to Chozas; and as whitish crystals in the tunnel of Paradilla not far from San Lorenzo de el Escorial about 40 km (25 mi) NW of Madrid. Blueish beryl comes from Peguerinos.⁷

Cáceres. Beryl is found at Canchal de la Muela.

Córdoba. Beryl occurs in granitic pegmatites in a district extending between Villaviciosa de Córdoba and Espiel, centered about 20 km (12.5 mi) NW of Córdoba in Sierra de los Santos.⁸ The bodies strike NNE and at La Alcubilla they are emplaced in Precambrian schists. At Mina las Esmeraldas near the village of La Alcubilla, villaviciosa, the crystals reach 15 cm (6 in) in diameter and 35 cm (14 in) in length. The presence of Cr was noted in the pegmatite, but no mention was made of emerald.

Granada. Beryl is found in pegmatites and as crystals in gold gravels.²

Gerona. Semi-transparent greenish prisms to 2 cm (0.8 in) occur at Cabo de Creus.²

1. Tenne, C. A., and Calderon, S. 1902. *Die Mineralfundstätten der iberischen Halbinsel*. Berlin: A. Asher & Co. 348 pp.
2. Calderon, S. 1910. *Los Minerales de España*. 2 vols. Madrid: Imprenta de Eduardo Arias. 416, 561 pp.
3. Parga-Pondal, J., and Cardoso, G. M. 1948. Die Lithiumpegmatite von Lalin, Prov. Pontevedra, Galizien. *Schweizerische mineralogische und petrographische Mitteilungen* (Zurich) 28:324-34.
4. Comba, A. 1942. Los yacimientos españoles de minerales especiales para ferroaleaciones. *Instituto Geológico y Minero de España, Notas y Comunicaciones*, no. 9 (Madrid) pp. 85-120.
5. Sobrino-Buhigas, R. 1920. Contribution a la gea de Galicia (Nuevo yacimiento de berilo). *Boletín de la Real Sociedad Española de Historia Natural* (Madrid) 16:541-3.
6. Sanchez, G. G. 1957. Notas sobre la Sierra de Jures (Orense). *Instituto Geológico y Minero de España, Notas y Comunicaciones*, no. 45, pp. 25-35.
7. Vicuña, P. C. 1929. *Los Minerales de el Escorial*. Imprenta del Real Monasterio de El Escorial. pp. 82-3.
8. Carbonell and Trillo-Figueroa, A. 1930. Los berilos o esmeraldas de Córdoba. *Revista Minera, Metalurgia y Ingeniería* (Madrid) 81:157.

SRI LANKA (CEYLON)

Gem aquamarine pebbles have been found for centuries in the gem gravels, but only a few in situ deposits are known and these offer virtually no gem material. According to Wadia, common beryl is found in large prisms in pegmatite veins,

BERYL LOCALITIES

especially those that have been worked for mica.¹ Most are blueish or greenish and may weigh up to 1.8 kg (4 lb). Such crystals have been noted in mica pegmatite at Gannoruwa near Peradeniya, Central Province, as sharp crystals of fine blueish green color. They are transparent in part and more than 15 cm (6 in) long but so flawed that only small areas could be cut into gems. Beryl occurs also in pegmatite at Kaiawela, Matale district, Central Province. Yellowish crystals come from Talatu-oya near Kandy and from mica pegmatites at Akuesssa.

In the gem gravels, some beautiful stones of pale blue color have been found which weigh as much as 200–300 carats.¹ The firm of Macan Markar, jewelers of Colombo, possess a 271-carat gem which came from a pit near Ratnapura.² Another in the American Museum of Natural History, New York, is a cushion-cut gem of 355 carats. Coates concluded that such beryls weathered from pegmatities.³

1. Wadia, D. N. and Fernando, L. J. D. 1945. Gems and semi-precious stones of Ceylon. *Ceylon, Records of the Department of Mineralogy, Professional Paper 2* (Colombo) 44 pp.
2. Gübelin, E. J. 1968. *Die Edelsteine der Insel Ceylon*. Luzern: privately published. 152 pp.
3. Coates, J. S. 1935. The geology of Ceylon. *Spolia Zeylanica, Ceylon Journal of Science* (Colombo) Sect. B., vol. 19, pp. 101–87.

SUDAN

Numerous granitic pegmatities are emplaced in Precambrian rocks of the Mograt area, Northern Province, some containing mica and others beryl, the latter occurring as pale greenish prisms, translucent to opaque, up to 10 × 6 cm (4 × 2.25 in). The area is enclosed in a bend of the Nile River and extends about 45 km (28 mi) E–W and 15 km (9.5 mi) N–S; the center is 425 km (268 mi) N of Khartoum. Most beryl has been found in the El Koro mica mine, with some crystals formed as "shells" over cores of quartz, plagioclase, schorl, garnet and sometimes apatite. G average = 2.7. Analyses given in Kabesh.^{1,2}

1. Kabesh, M. L. 1960. Mica deposits of Northern Sudan. *Republic of Sudan Geological Survey Department Bulletin 7* (Khartoum) pp. 10–11.
2. ———. 1962. Pegmatites of the Mograt area, Northern Province, Sudan. *Journal of Geology of the United Arab Republics* (Cairo) 6:45–71

SWAZILAND

Economical amounts of ore beryl were discovered in 1959 in granitic pegmatites of Hlatikulu

district, SW Swaziland;¹ these bodies also contained cassiterite, columbite-tantalite and monazite; 15.26 tons of ore beryl were shipped during 1959–61.²

1. Davies, D. N. 1961. *Swaziland, Annual Report of the Geological Survey and Mines Department for the Year Ended 31st December 1959*. 56 pp.
2. ———. 1961. *Swaziland Annual Report of the Geological Survey and Mines Department for the Year Ended 31st December 1960*. 46 pp.

SURINAM (DUTCH GUIANA)

Beryl, also cassiterite, columbite-tantalite, amblygonite, and lepidolite occur in granitic pegmatites which outcrop in a broad E–W belt, about 20 km (12.5 mi) wide in the NE; one locality is shown as 60 km (38 mi) almost due S of Paramaribo near Suriname River.¹

1. Dahlberg, E. H. 1976. The metallogenic map of Suriname. Contributions to the Geology of Suriname 5. *Mijnbouwkundige Dienst van Suriname Mededeling 24* (Paramaribo) 10 pp.

SWEDEN

Granitic pegmatites, associated with granite masses and intruded into metamorphic rocks, occur in a very long belt stretching from N Sweden to the SW extremity adjacent to Norway. Numerous localities are listed in Brotzen¹ and Flink.² Most of the bodies, generally worked for feldspar and quartz, occur to the SW and NW of Stockholm, and thence toward the S end of Norway.

Norbotten. Beryl occurs at Jokkmokk; Muorjevara; Mjölfjärden; Sörhällen near Råneå.

Västerbotten. The granitic pegmatite of Varuträsk, famous for its mineralogical complexity, is located 15 km (9.5 mi) from the Baltic seacoast town of Skellefteå. It has been studied in great detail by Quensel and is a tabular, zoned body emplaced in amphibolitic rock with an outcrop of 350 × 3–30 m (1340 × 10–100 ft).^{3,4,5} Beryl occurs in several varieties according to phase of mineralization, e.g., (1) milky white, sometimes tinged with yellow, crystals to 30 cm (12 in), $\rho = 1.583$, $e = 1.577$, $G = 2.712$ – 2.725 ; BeO 12.87%, also with small amounts of Na, Cs, K, Li; (2) white, glassy, partly transparent rounded masses to about 2–3 cm (ca. 1 in) with about the same alkalies but somewhat more Cs; BeO 12.98%. Quensel provides analyses of both types.⁵ A crystal of dark brown beryl was also found and contained 2.8% Cs₂O. None of the beryl was mentioned as gem quality.

World Sources of Ore and Gem Beryl / Sweden

Jämtland. Localities for beryl are: Snasahögen; Jeriskaite near Tärna.

Västernorrland. Bollsta is a known source.

Kopparberg (formerly Dalecarlia or Dalarna). Nya Kårarvet near Falun provided fresh crystals to 20 × 15 cm (8 × 6 in), opaque and some completely altered to muscovite. Finnbo produced dull and sometimes completely altered prisms to 1 cm, pale gray and yellowish in a quartz quarry (pegmatite). Broddbo is a well-known pegmatite locality where beryl occurs in considerable quantity; the largest crystals are up to 17 cm (6.8 in) diameter and have good faces of *m*, *a*, and *c*. Color is pale gray inclining toward greenish. According to Flink, these were among the best-formed crystals from Sweden. Other beryl sources are Myckelmyran and Mejdåsen; in considerable quantity in the large pegmatite body of Kolsva; crystals to 40–60 cm (16–23.5 in) diameter; some altered in part to euclase and bertrandite; associates are chrysoberyl, phenakite and gadolinite. Sundius described beryl and chrysoberyl from this quarry and noted that both were "large and well crystallized."⁷ At Pershytte, near Grängesberg iron mine, beryl occurs in pegmatite with quartz, feldspar, and mica, but as very small, poorly formed crystals, yellowish to greenish gray. Very close to the iron mine, a pegmatite body contains small glassy crystals to 1.5 cm (0.75 in) of dark gray color inclining toward greenish; associates are feldspar and schorl. Beryl is found at Burungsbergsgruvan, Grangärde; close to Grängesberg, in pegmatite as small prisms of pale gray to yellowish color; at Gimsbergs Klack, Tuna.

Värmland. Beryl localities are Gumklinten, Gustaf Adolf; Långbanstrakten.

Västernorrland. At Reboda, Lindes twp., crystals found in pegmatite are completely altered to small granular aggregates of some dark gray mineral but may also occur as fresh prisms to 5 cm (2 in) in diameter, pale gray to yellowish and slightly translucent. Other localities are Guldsmedshyttetrakten, Söderfjäll, Vaddö.

Stockholm. The famous Ytterby pegmatite body, noted for rare minerals, contains only unattractive beryl crystals intergrown with K-feldspar and quartz, and seldom over 1 cm (0.6 in) in diameter. They are pale ash-gray color inclining toward yellowish.² Regular intergrowths of beryl with microcline were noted by Högbom.⁸ The quarry lies on Resarö (island) about 20 km (12.5 mi) ENE of Stockholm and was mentioned

in the literature as early as 1788. Nordenskiöld described it as a zoned body containing such rare species as gadolinite, allanite, fergusonite, yttrantalite, xenotime, etc.⁹ Gadolinite was first identified here and from this mineral and others the elements yttrium, terbium, erbium, ytterbium, holmium and scandium were isolated. At Utö, S of Stockholm, a lithium pegmatite, of a type not hitherto found in Sweden, contains amblygonite associated with spodumene and rose beryl, also colored tourmaline, petalite, lepidolite, holmquistite, manganotantalite, mossite, etc.¹⁰ Hafsgruvorna, a pegmatite quarry in the archipelago near Stockholm, contains 15–20 cm (6–8 in) beryl crystals of glassy luster, pale yellowish to greenish gray crystals; forms *m* and *c*. Other beryl may be found at Frederikshof, Stockholm.

Södermannland. Norrö, Nynäsham.

Örebro. Västerby, Hammar; Broo, Askresund; Nora.

Östergötland. Around Godegård: localities are Jakobshyttan, Lidbacken, Skrumpetorp, Perstorp. Others are at Ryegruvan and Kampeländet.

Göteborg. Locations of beryl are: Lilla Holma, Skee twp. Brattås and Timmerhult, Orust. At Bön, Röa twp., a pegmatite produced crystals to 25 cm (10 in) long with good forms, fresh and glassy, and distinctly green, more so than from other Swedish deposits, and reminiscent of emerald but poorly translucent.² In Högsbo feldspar quarry, SE of Högsbo station, beryl occurs with fluorite, columbite, and monazite in pegmatite.¹¹ Beryl is also found on Donsö and Styrösö near Göteborg.

1. Brotzen, O. 1959. Mineral association in granitic pegmatites. A statistical study. *Geologiska Föreningens I Stockholm Förhandlingar*, March-April 1959, pp. 231–96.
2. Flink, G. 1917. Bidrag till Sveriges mineralogi. *Arkiv för Kemi, Mineralogi och Geologi, Kungl. Svenska Vetenskapsakademien I Stockholm* 6, no. 21, pp. 1–4.
3. Quensel, P. 1937. Minerals of the Varuträsk pegmatite. *Geologiska Föreningens I Stockholm Förhandlingar* 59:269–72.
4. ———, 1942. Die Mineralien des Lithium-Pegmatits von Varuträsk. *Tschermak's mineralogischen und petrographischen Mitteilungen* (Vienna) n.s. 53:354–7.
5. ———, 1957. The paragenesis of the Varuträsk pegmatite including a review of its mineral assemblage. *Arkiv för Mineralogi och Geologi* (Stockholm) 2, no. 2, pp. 9–125.
6. Mårtensson, C. 1960. Euklas und Bertrandit aus dem Feldspatpegmatite von Kolsva, Schweden. *Neues Jahrbuch für Mineralogie* (Stuttgart) Abh. 94, pp. 1248–52.
7. Sundius, N. 1950. Beryll och krysoberyll från Kolsva

BERYL LOCALITIES

- fältspatgruva. *Geologiska Föreningens i Stockholm Förhandlingar* 72:358-9.
8. Högbom, A. G. 1899. Ueber einige Mineralverwachsungen. *Zeitschrift für Kristallographie* . . . (Leipzig) 31:314-5.
9. Nordenskiöld, J. 1906. Der Pegmatit von Ytterby. *Bulletin of the Geological Institution of the University of Upsala* 9:183-228.
10. Backlund, H. 1918. Amblygonit von Utö. *Geologisk Föreningens i Stockholm Förhandlingar* 40:757-75.
11. Sundius, N. 1951. Mineral från Högsbo fältspatbrott vid Göteborg. *Geologisk Föreningens i Stockholm Förhandlingar* 72:473.

SWITZERLAND

Beryllium minerals are among the rarest in the Alpine assemblages, but recent finds suggest that they may be more common than is generally supposed. Beryl and its scandium analogue bazzite occur in granitic pegmatites, in aplite-granites, but rarely in the classic cleft cavities.¹ Most localities are in the cantons of Graubünden and Tessin close to Italy.

Graubünden

In clefts on the W slope of Piz Scharboden, opposite Val Nova, beryl occurs as pale blue, long prismatic crystals, and rarely as corroded prisms with a first order bipyramid and perceptible cleavage parallel to basal plane; $G=2.750$. It is associated with quartz in altered gneiss of Adula Formation² and found in clefts on Piz Frunt.³ Both localities are about 10 km (6.4 mi) WNW of Vals. Bazzite, in azure blue, 30 mm (1.25 in) prisms, occurs in eluvial blocks on the slopes of Witenalp between Calmut and Stremhörner about 6 km (3.8 mi) NNW of Sedrun.^{3,4} Common beryl occurs at Piz Nair near Sedrun and in Val Ferrera, located about 13 km (8 mi) S of Thusis near the Italian border.⁴

Fine, sometimes clear prisms of beryl in granitic pegmatites are associated with a large granite stock S of Val Bregaglia (Bergell) close to Italy and about 25 km (16 mi) SW of St. Moritz; the region encompasses Vedretta del Forno, Vedretta dell'Albigna and upper Val Bondasca. The principal country rock is a very coarse-grained, porphyritic biotite-granite and the pegmatites contain euhedrons to 10 cm (4 in) long that are milky blue, somewhat greenish, or sometimes deep blue with transparent areas. Elongated prisms occur also for radiate groups or "suns." Associates are feldspars, quartz, biotite, garnet, tourmaline, hematite, and rarely allanite and molybdenite.³

Schneiderhöhn said: "I saw, in 1930, upon the edge of Forno Glacier, beautiful, clear green beryl crystals in pegmatite schlieren in the fresh granite."⁵ Specific localities from Niggli et al. are Monte del Forno, Torrone Orientale, Passo Casnile, Punta Pioda, Passo Cacciabella, Cengalo, and Pizzo Trubinasca.³

Staub provided the following analysis (by J. Jakob) of a Bondasco specimen:

Table 14-41
ANALYSIS OF BONDASCO BERYL⁶

	Percent	Percent	Percent
SiO ₂	65.25	Fe ₂ O ₃	2.03
Al ₂ O ₃	18.41	BeO	13.03
		H ₂ O	0.38
			Total 100.02

Not found: CaO, MgO, Cr₂O₃

Other occurrences are in the extreme S of Canton Graubünden, generally NE of and around Bellinzona, e.g., numerous pegmatite bodies in Castenenda in Val Calanca provide pale blue prisms to 3 cm (1.25 in) long and of considerable beauty.³ See also the adjacent areas of Tessin.

Tessin (Ticino)

Granitic pegmatites with beryl are common, especially in the S near the Italian border.⁷ Crystals have been found on the highest peaks of Monte Prosa, St. Gotthard region, about 4 km (2.5 mi) NNW of Airolo in the extreme N of the canton; however, the occurrences are in granite with muscovite and apparently not connected with either pegmatite or aplite bodies; crystals of dark blue to 2 cm (0.75 in) have been found.⁸ Stalder described beautiful pale blue crystals to 25 mm (1 in) long from an aplite vein exposed during work on the old Banchi road in Gotthard Pass,⁹ associates in a vug were quartz, muscovite, calcite, albite, chlorite, apatite, pyrite, hematite (or ilmenite?). Beryl in sharp, translucent, yellowish to blueish prisms to 7 cm (2.75 in) long and several cm in diameter occurs in pegmatites, associated with muscovite, tourmaline, and garnet, at Claro (Claro Alto) in Val Molino, Ticino River valley, N of Bellinzona; a specific site is below the hill bearing the convent of Santa Maria di Claro.^{3,10} Just N of Claro, pegmatite veins exposed in a gneiss quarry at Cresciano, near the railway station of Osogna, contain beryl associated with tourmaline, garnet, quartz, and graphitic

World Sources of Ore and Gem Beryl / Tanzania (Tanganyika)

granite. At Monte di Daro, E of Bellinzona, good yellowish to blueish translucent crystals occur with tourmaline. At Madonna del Sasso, above Locarno in a quarry, yellowish white prisms occur in an exposed pegmatite vein.³ In the Punteglias region there are other occurrences.⁴ An unusual association of beryl with scapolite takes place in dolomite at Passo di Cadoghino. Near Monte Uri, in Valletta della Mondada, beryl occurs in biotite as prisms several cm long.¹⁰

Uri

Beryl is reported from near Wiler in the Reusstal, but may be bazzite.³

Bern

At Handegg, about 5 km (3.2 mi) S of Guttanen, beryl and bazzite prisms to 1.5 mm have been found in a hydroelectric tunnel at Oberhasli.⁴

Valais (Wallis)

Beryl occurs on Firrenhorn in upper Valais.⁴

1. Hügi, T. 1956. Verbreitung des Berylliums und der Beryllium-Mineralien in den Schweizer Alpen. *Schweizerische mineralogische und petrographische Mitteilungen* (Zurich) 36:497-510.
2. Königsberger, J. 1909. Beryl aus dem Valsertale. *Zeitschrift für Kristallographie* (Leipzig) 47:202.
3. Niggli, P.; Königsberger, J.; and Parker, R. L. 1940. *Die Mineralien der Schweizeralpen*. 2 vols. Basel: B. Wepf & Co.
4. Parker, R. L. 1954. *Die Mineralfunde der Schweizer Alpen*. Basel: Wepf & Co. 311 pp.
5. Schneiderhöhn, H. 1961. *Die Erzlagerstätten der Erde*. Vol. 2: *Die Pegmatite*. Stuttgart: Gustav Fischer. 721 pp.
6. Staub, R. 1924. The Bergell beryls. *Schweiz. min. petrogr. Mitt.* 4:364-7.
7. Taddei, C. 1940. Pegmatiti della Svizzera Italiana e minerali in esse continuti. *Schweiz. min. petrogr. Mitt.* 20:247-52.
8. Jakob, J. 1925. Über das Auftreten von Beryll am Monte Prosa (St. Gotthard). *Schweiz. min. petrogr. Mitt.* 5:242.
9. Stalder, H. A. 1967. Über neue Mineralfunde aus den Schweizer Alpen. *Der Schweizer Strahler* (Bern) 1, no. 1, p. 14.
10. Taddei, C. 1937. *Dalle Alpi Lepontine al Ceneri: note di geo-mineralogia*. Bellinzona: Editoriale. 183 pp.

TANZANIA (TANGANYIKA)

Mica pegmatites in the Uluguru Mountains, about 200 km (126 mi) WSW of Dar es Salaam, are zoned bodies containing some beryl, the latter in simple prisms of only several cm length. Larger crystals occur in the Makanjoro pegmatite

mine in the extreme SE of the country in Masasi district; 2.5 short tons of ore beryl were produced here in 1949.¹ A pegmatite in Namaputa area, S of Masasi, is reported to have had crystals to 46 cm (18 in) diameter. Some ore beryl has been mined from Sibweza mica mine in Mpanda district.^{2,3}

Lake Manyara Emerald. In 1969, the first emerald crystals from this deposit, then in possession of a Mr. Khanji of the town of Moshi, were seen by H. P. Kristen, a prospector, who ultimately found the deposit on February 17, 1970.^{4,5,6} The property is located about 2.4 km (1.5 mi) W of the shore of Lake Manyara, just S of Moji Moto Hot Springs, or about 110 km (69 mi) WSW of Arusha, from which town it is reached via the Dodoma-Arusha road. Details on the mine location, its installations, etc., were given by Gübelin after a visit in 1973, and the following information is largely based on his account.⁶

The country rocks are meso- and catamorphic schists and gneisses containing lenses of biotite in which occur aggregations of emerald, alexandrite, and corundum. Usually small pegmatite lenses are also present, apparently formed by the remobilization of mineral matter in the country rocks and recrystallized along bedding planes. The deposit beds uniformly strike 70° and dip 45° SE.^{6,8} Workings are opencuts exposing biotite mica in which occur the emerald crystals and from which rock they are easily separated. During its early days, the mine produced 231,877 gm of rough from July 1970-April 1972. It was nationalized by the government in February 1973, and the original exploiter, H. P. Kristen, relegated to the position of manager.⁶

The emerald crystals occur in contact zones between schists and pegmatites, the majority being very small and of poor quality, although larger crystals are found up to 10-20 mm (to 0.75 in) which sometimes contain medium to very high quality emerald. Gübelin reported that a new vein found about 1973 yielded very fine crystals, some as much as 150 gm in weight.⁶ Typically the prisms are faced with *m*, sometimes with *c*, and rarely with truncations of dipyrarnidal forms. Associates are chrysoberyl, also its alexandrite variety, ruby corundum, apatite, garnet, spinel, olivine, clinopyroxene, chondrodite, blue corundum, phenakite, dark tourmaline, pale colored beryl, and others.⁷ R. I.: $\rho = 1.582-1.590$,

BERYL LOCALITIES

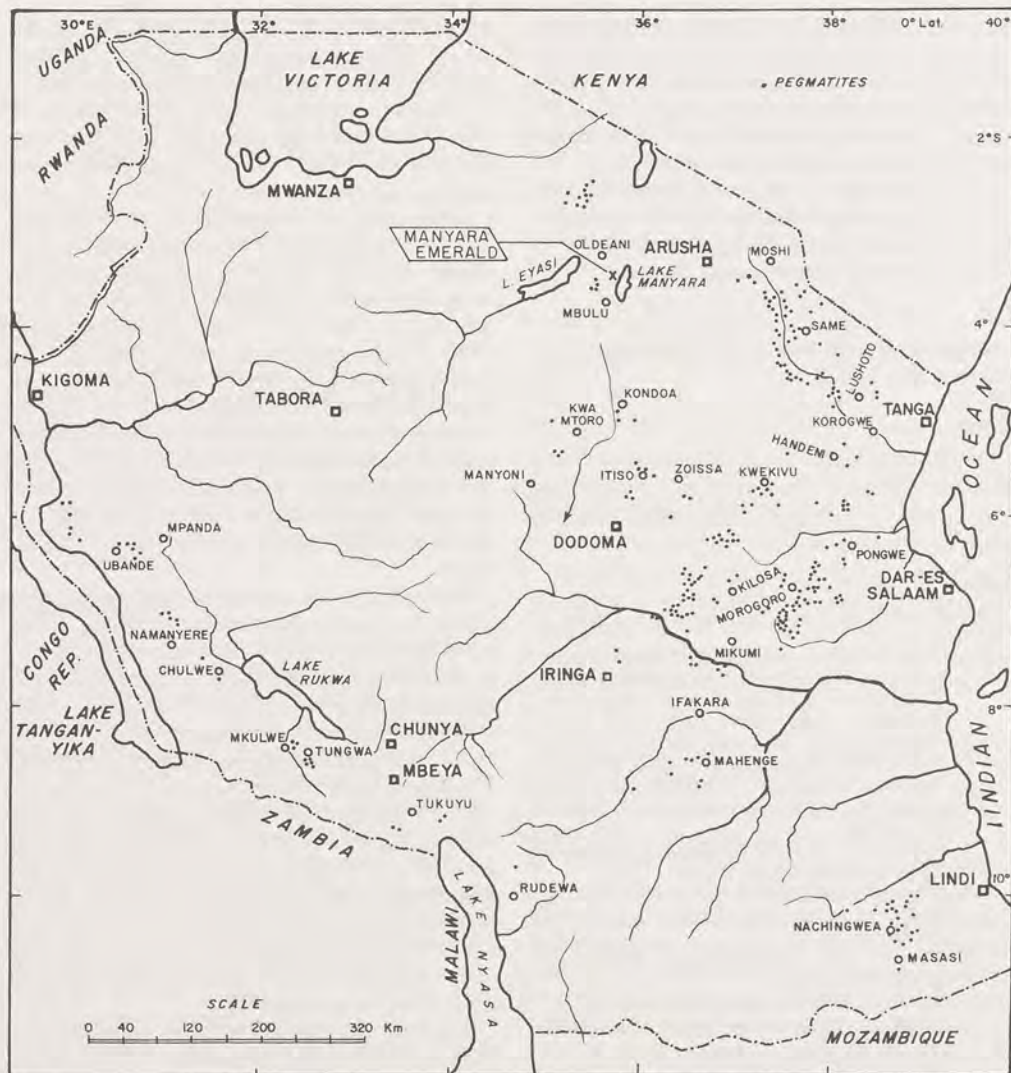

Fig. 14-50 Sketch map of Tanzania showing locations of granitic pegmatites yielding mica and also beryl. The Lake Manyara emerald deposit is also shown. After a map of D. N. Sampson, "The mica pegmatites of Tanzania," *Overseas Geology and Mineral Resources* 10 (1966).

$e = 1.576-1.581$, diff. $0.006-0.009$, uniaxial (-). Dichroism $o =$ yellow green, $e =$ blue green. Absorption maxima are for o , 6125 \AA and 4325 \AA , for e , 6460 \AA and 4212 \AA . $G = 2.69-2.75$. No luminescence under UV. Inclusions are mostly very small, in dust-like concentrations which when abundant make the emerald cloudy. They

are mostly biotite and muscovite, accompanied by liquid-filled cavities; other inclusions are alkali, feldspar, and quartz.^{6,7}

This locality is also remarkable for its twinned alexandrite crystals, commonly corroded and invested in biotite mica. They are dark green to brownish and blueish green, and under artificial

World Sources of Ore and Gem Beryl / Union of Soviet Socialist Republics

light show a good change to red. Faceted gems up to 5 carats have been cut and rarely small cat's-eyes.⁷

1. Sampson, D. N. 1954. The mica pegmatites. *Records of the Geological Survey of Tanganyika* (Dar es Salaam 4:21-31).
2. Harris, J. F. 1959. Summary of the mineral resources of Tanganyika. *Tanganyika Geological Survey Report* 2.
3. ———. 1961. Summary of the geology of Tanganyika. Part 4: Economic geology. *Memoir of the Geological Survey of Tanganyika* no. 1, pp. 34-5.
4. Thurm, R. E. 1972. The Lake-Manyara-emeralds of Tanzania. *Journal of Gemmology* 13:98-9.
5. ———. 1972. Smaragde vom Lake Manyara in Tansania. *Zeitschrift der deutschen gemmologischen Gesellschaft (Idar-Oberstein)* 21:9-12.
6. Gübelin, E. J. 1974. The emerald deposit at Lake Manyara. *Lapidary Journal* 28:338-44, 346, 347, 359, 360.
7. Bank, H., and Gübelin, E. 1976. Das Smaragd-alexandritvorkommen von Lake Manyara/Tansania. *Zeits. der deutsch. gemm. Ges.* 25:130-47.
8. Amstutz, G. C., and Bank, H. 1977. Geologische, petrographische und mineralogische Beobachtungen in einigen Minen von Smaragd, Tansanit, Tsavorit und Rubin in Tansania und Kenya. *Zeits. der deutsch. gemm. Ges.* 26:118-27.

TURKEY

Ryan listed only two occurrences of common beryl: Kütahya in Usak County and township near Usak, and in Manisa, Gördes County and township near Gördes, the latter said to be in pegmatite.¹

1. Ryan, C. W. 1960. *A Guide to the Known Minerals of Turkey*. Ankara: Mineral Research and Exploration Institute of Turkey. 196 pp.

UGANDA

Northeast. Beryl-bearing granitic pegmatites are in Karamoja region adjacent to the Kenya border.¹

South Central. (Buganda). Granitic pegmatites and greisenized tungsten-quartz veins, some with beryl, in upper portions of Singo County granite batholith sometimes invading overlying sedimentaries. Principal occurrences are within batholithic rocks, where wolframite-quartz veins are flanked by greisen zones containing quartz, micas, and iron minerals as consistent associates, but in places also containing tourmaline, pale green beryl (sometimes altered to an unidentified waxy mineral), danburite, fluorite, chalcopyrite, and molybdenite.² Small amounts of ore beryl are produced from Mbale mine.³

Southwest. An important granitic pegmatite field lies within a belt of schists intruded by granites, extending from SW Ankole across central Kigezi.^{4,5} A number of complexly mineralized bodies are emplaced in the schistose aureole surrounding the Paragwe-Ankolean granites and contain feldspars, quartz, micas, and sometimes lithium species; less common are apatite, tantalite, columbite, cassiterite, manganite, and tourmaline. Several bodies were worked for ore beryl in the 1930s but production rose only in the 1950s due to exploitation of beryl-rich deposits at Kigezi and Ankole. In Ankole district beryl pegmatites occur at Kazamu, Kashozuo, Ruemeriro, Nyabakweri, Kanena, Lyasa, Kabira, Namherere, Mwirasandu; in Kigezi district at: Bulema, Kihanda, Kayonza, Kanungu.^{4,5,6}

1. Barnes, J. W. 1961. The mineral resources of Uganda. *Bulletin of the Geological Survey of Uganda* no. 4 (Entebbe) 89 pp.
2. King, B. C. 1950. Wolfram deposits of Singo County, Buganda Province, Uganda. *Colonial Geology and Mineral Resources* (London) 1:303-26.
3. Roberts, R. O. 1948. Amblygonite and associated minerals from Mbale mine, Uganda. *Bulletin of the Imperial Institute* (London) 46:342-7.
4. Combe, A. D. 1932. *The geology of southwest Ankole and adjacent territories with special reference to the tin deposits*. London: Uganda Geological Survey. 236 pp.
5. Gallagher, M. J., and Hawkes, J. R. 1966. Beryllium minerals from Rhodesia and Uganda. Part 7. *Geological Survey of Great Britain Bulletin* 25 (London) pp. 59-75.
6. Knorring, O. v. 1962. Pegmatite and related investigations. *University of Leeds, Research Institute of African Geology, 6th Annual Report, Session 1960-61*. pp. 7-13.

UNION OF SOVIET SOCIALIST REPUBLICS

As may be expected from the vast extent of this union, deposits containing beryl are plentiful but scattered among widely-separated regions in Asia and Europe. Three major regions, notably the Chita subdivision of southern central Siberia (Transbaikalia), the Ural Mountains, and more recently, the Ukraine, have provided excellent gem material and mineral specimens. Smaller regions, adjoining these large ones, are also discussed below.

Chita Subdivision (Transbaikalia)

Known anciently by the name of Dauria, it is the opinion of some authorities that beryl gemstones have been mined here since antiquity.¹

BERYL LOCALITIES

This view is reasonable because of the fact that it has been populated for many centuries; in regard to the gemstone deposits, some of which are superficial, as at Adun Chilon, these would have yielded their treasures to anyone caring to take them away. More certain is the exploitation of these deposits in modern times: Koksharov, for example, quoted Kulibin's remarks as follows: "the famous locality for colored stones in the Adun-Chilon was, as one must presume, discovered in 1723 by the Nerchinsk inhabitant Gurkov, as published in a ukase of the Berg-Collegium of 22 December 1724 which awarded him a gratuity of 5 rubles for his discovery." Furthermore, "the most fruitful production of colored stones occurred in 1796 when in this year alone more than 5 pud [80 kg or 180 lb] of pure and workable aquamarine were found." (vol. 1, p. 164).²

Brückmann, the indefatigable chronicler of gemstone news during the 18th century, remarked that he first obtained beryl crystals from this locality in 1780 (p. 83),³ while Macquart, in 1789, described a number of typical Adun Chilon crystals,⁴ thus showing that by the latter part of the 18th century, aquamarines from this area were already well-distributed throughout Europe. It is not known if these deposits are being worked now, but the absence of specimens on the world market, aside from those redistributed from old collections, suggests that they lie dormant.

The largely mountainous region under consideration is located immediately N of the junction of the borders of the Mongolian Republic, Inner Mongolia, and Siberia, and generally lies E of Lake Baikal. The city of Nerchinsk, on the Shilka River, is at the N end of a series of ranges that are studded with granitic pegmatites and related beryl-bearing deposits. For practical purposes, the area is enclosed between 50°15'–52° N and 115°30'–118° E (see fig. 14-51). Three subareas are treated below.

I. Borschchovochnoi or Pravoshilkinski Khrebet (range). This area lies immediately S of Nerchinsk across the Shilka River, enclosed by the Shilka (N), Onon River (W), and Unda River (S). The range, or *khrebet*, runs WSW–ENE, with pegmatite mines from 69 km (43 mi) SW of Nerchinsk to some 21 km (13 mi) S of Stretensk, a city on the Shilka located 84.5 km (53 mi) NE of Nerchinsk. According to Fersman, there are about 18 principal mines or groups of mines, some noted for colored tourmalines, some for topazes, and some for beryls.¹ Granitic pegmatites

are linked to large granite intrusions of Variscian age, consisting normally of porphyritic biotite-granite with subordinate pegmatoid and aplitic granite. Pegmatite bodies are numerous in the granites and in roof pendant metamorphic rocks and may be fracture-filling types or schlierens, commonly with much graphic granite and with cavities in both (p. 171).⁵

Outstanding beryl crystals were formerly obtained from bodies along the Urulga River, which flows NE to join the Shilka about 15 km (9.4 mi) SW of Nerchinsk. These were "of extraordinary beauty, pleasing color, transparency and significant size,"² and usually yellowish green but sometimes blue, yellow, or intermediate hues, and more rarely, colorless. The largest were about 10 × 5 cm (4 × 2 in), some transparent, others more or less fissured. Many individuals were terminated by first and second order bipyramids, and sometimes by faces of dihexagonal bipyramids. In rare instances, doubly-terminated crystals were found, sometimes almost completely so. On Urgachan Mountains small, transparent, wine-yellow crystals terminated by a steep second order bipyramid alone were found. Kuznetsov noted that pegmatites in the valley of the Urgachan River, a tributary of the Shilka, and directly S of Nerchinsk on the N slope of the *khrebet*, produced colored tourmalines and pink beryls, but the latter only in poor crystals or broken fragments.⁶ Just W is the Savateeva, Savvateevo, or Usovskoe deposit, "long famous for its beautiful colored tourmalines and gem quality vorobeyevite [pink beryl], which was mined by prospectors from cavities in the initial period of exploitation."⁵ This mine is 15 km (9.4 mi) from Nerchinsk, and the body itself is about 400 m (440 yd) long with a mean thickness of 50 m (55 yd). Pink beryl is associated with rubellite and lepidolite, while green beryl is found with quartz and schorl. Famous mines in this group include Peshkovskoe, Solotaya Mountain, Zolotaya Strelka, Mokhovoe, Kiberevskoe and others, in part, on Kuchuserken Mountain. A pegmatite body near the junction of the Onon and Shilka rivers contained "large crystals of yellowish-white color which are translucent only on edges and are of the first order prism form terminated with the base."² Similar crystals were found in the tin-gravels of the Onon River.

II. Udinskoe-Gazimurskii Khrebet. This area is adjacent to the above and to the S, lying between Unda River (N) and Turga River (S), and

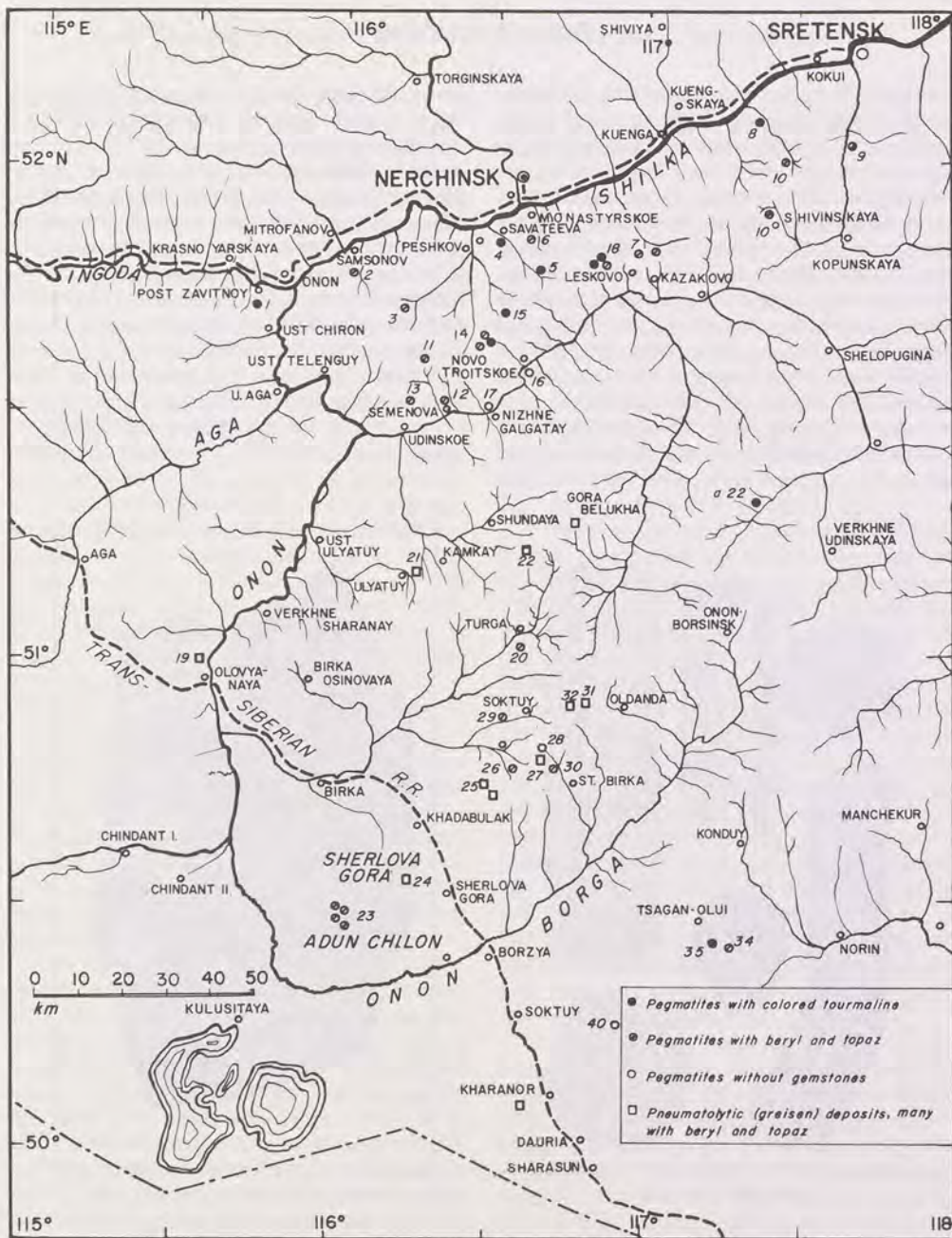

Fig. 14-51 The famous gemstone-bearing pegmatite districts in the Chita (Transbaikalia) region of the USSR. Perhaps the finest beryl specimens of all were found in the deposits shown in the lower portion of the map, namely Sherlova Gora (Schorl Mountain) and Adun Chilon. Mines: 1. Zavitnaya, 2. Boetz, 3. Urulga, 4.-6. Urulgaya (Savateeva), 7. Borshchovka, 8. Kurkura, 9.-10. Kurenga, 11. Zolotaya Gora, 12. Tulun, 13. Dushnaya, 14.-15. Kibirevskie Kopi, 16. Kokui (amazon.), 17. Kokui (moonstone), 18. Leskovo, 19. Olovyannye Rudnik, 20. Turga, 21. Ulyatui, 22. Bukuka, 22a. Alengui, 23. Adun Chilon, 24. Sherlova Gora, 25. Antan, 26.-29. Soktui mines, 30. Birka, 31. Oldonda, 32. Antonova, 34. Altangan, 35. Kadaya, 40. Kliuchevskoi Karer. After A. E. Fersman, *Dragotsennyye i Tsvetnyye Kamni, SSSR 2* (Leningrad, 1925).

BERYL LOCALITIES

bounded SW by the Onon River and its branch, the Birka. There are at least six groups of mines, with several in bodies that are classified as pneumatolytic greisen types.¹ Noted mines are Alenguy, Belukha, Bukuka, Turga, and Ulyatuy.

III. **Onon-Borzinskaya Mountains.** This region includes the mountains of Kuchuserken, Adun Chilon, Sherlovaya Gora, and the Suktui, Turga, and Alenguya areas. It lies S of the above district, approximately between the Suktui and Turga rivers (N), the Onon River (W), and the branch of the latter known as the Onon-Borzha which curves E then NE. Fersman shows about ten groups of mines developed on bodies that are normal granitic pegmatites as well as greisenized

bodies, the latter far more important and providing most of the splendid beryl crystals for which this district is famed (see fig. 14-51). The two major localities are Sherlovaya Gora or "Schorl Mountain" and Adun Chilon, which is part of the same mountain; both are located in a relatively small area in the triangle formed by the Onon River (W), the Onon-Borzha River (SW), and the Siberian Railway (NE). Its center is 171 km (108 mi) almost due S of Nerchinsk. A nearby railway station is named Sherlovaya Gora.

SHERLOVAYA GORA. This mountain lies NE of Adun Chilon; largely porphyritic alkali granite occurs on the summit, also granite porphyry, aplite, and hornfels.^{2,7} Occurrences are princi-

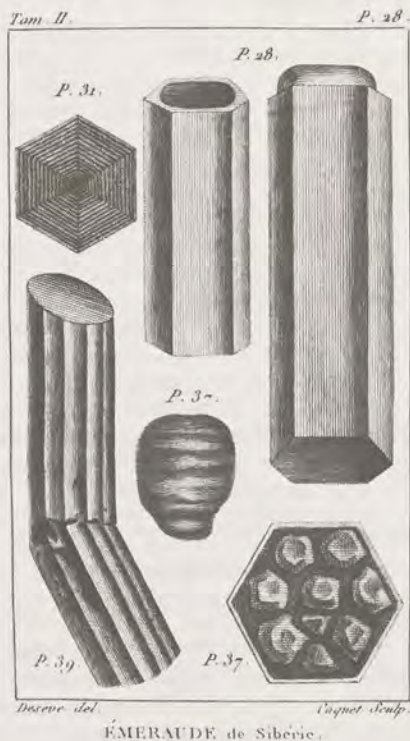

Fig. 14-52 Illustrations of beryl specimens from the quarries on Adun Chilon Mountain, Transbaikalia collected by the French mineralogist E.-M.-L. Patrin (1742-1815) during a visit in 1795. Left: color zoning, broken and re-healed prism, and development of clear, facet grade nodules within crystals, a feature common in certain tourmalines but rarely observed in beryl. Right: typical matrix specimen showing a beryl prism partly overgrown by a quartz crystal. From engravings in E.-M.-L. Patrin, "Histoire Naturelle des Minéraux," *Buffon's Histoire Naturelle* 2 (Paris, 1801).

World Sources of Ore and Gem Beryl / Union of Soviet Socialist Republics

pally quartz veins and greisenized rock. Beus described several types as quartz mica, topaz-quartz, and topaz veins, also greisens of siderophyllite mica (pp. 265-70).⁵ Vein fillings contain beryl associated with quartz, arsenopyrite and siderophyllite with quartz-beryl the most common associates. Accessories include ferberite, fluorite, siderite, bismuthinite, muscovite, bismuth, molybdenite, pyrite and chalcopyrite. Numerous cavities occur, filled with brownish clays in which loose crystals of aquamarine occur, "commonly of the best gem quality," associated with crystals of green and violet fluorite. In some, arsenopyrite cements broken crystals.

Beryl is usually yellow-green, translucent, fissured, and corroded, some of the latter being mere relict fragments. There are also, however, superb crystals of blue and gold, the yellow hues typical of cavities in which siderophyllite (rich in iron) is found in the vein. Some beryls grew with pale blue topaz crystals as well as smoky quartz and may contain ferberite inclusions. The crystals have been thoroughly described by Ikornakova, who noted that larger individuals tended to be translucent only and greenish or blueish in hue, while smaller, more transparent crystals were paler in hue.⁸ There are many variations in habit and some crystals display terminal bipyramidal faces as well as those of dihexagonal bipyramids. A crystal was found which Ikornikova considered to be a new contact twin on {4041}. Striations on prism faces parallel to the *c*-axis are abundant. Sushchinsky found refractive indices to be typically $n_o = 1.5734$, $n_e = 1.5682$ (Na).⁹

ADUN CHILON, ADUN CHOLON, OR (RARELY) HOPPEKAYA GORA. This mountain peak lies SW of Sherlovaya Gora in the same massif and consists of a central E-W ridge with spurs extending S and SE (p. 320).¹ It is literally honeycombed with pits and tunnels "such that one can scarcely find upon it an undisturbed place." (vol. 1, p. 166).² Nefedov noted that most of the pegmatitic bodies are small and commonly assume stock-like and vein-like forms.¹⁰ Chief species are quartz and K-feldspars, but albite and fluorite are common. Biotite is often found along margins and black tourmaline in the centers. Other species are bismuth, arsenopyrite, cassiterite (intergrown with albite and rarely beryl), zircon, rutile, brookite, struverite, opal, calcite, yttrapatite, and synchisite. The astonishing richness in aquamarines was remarked upon by Shcherbakov,

who mentioned that in 1929 alone, 150 kg (330 lb) of crystals of asymmetrical shapes, but of outstanding quality, were found in clay-filled pockets in one vein named the "Millionaya" on a spur of the mountain called Zolotoy Otrog.¹¹ Furthermore, millennia of erosion resulted in eluvial material accumulating along the flanks, especially on the S side, and in this material, commonly cemented with porous limonitic earth, numerous splendid crystals were found, all being coated with thin to thick limonite films. Some crystals showed wear upon sharp edges, as shown in fig. 8-2. The crystals were distinguished by the fact that "the prismatic faces are always covered with deep vertical striations" and hence may be distinguished from those from Borshchovochnoi and Uralian deposits (vol. 1, p. 167).²

While varied in color, most of the above beryl crystals are greenish blue, but also sky blue, yellowish green, wine-yellow, and sometimes colorless. Pockels noted a tendency to form thin growth layers parallel to the basal plane or the plane of the *a*-axes, in some instances accompanied by marked changes in hue and hence easily distinguished from beryl crystals from other localities on that account (see fig. 8-2).¹² A crystal of this kind, once in my possession, had at least six such zones near the terminus, all sharply defined by planes of blue, greenish blue, and yellow; wear along the edges suggested that it came from the eluvial material at the foot of the mountain. It has also been noted that some crystals which appear homogeneous actually consist of layers of markedly different refractive index, such that total internal reflection is sometimes observable when a polished section is moved to the correct angle under a light.¹²

Many crystals are broken off at both ends, others are untruncated because they grew from one side of the cavity to the other, and some are intergrown with smoky quartz and faintly blue, or colorless topaz crystals. A remarkable matrix specimen was described by Lapparent¹³ which consisted of a base of wolframite, 13 × 9.5 cm (5 × 2.75 in) on which was grown a beryl crystal of 5.8 × 1.2 cm (2.3 × 0.5 in), with smaller prisms of yellow beryl scattered over the wolframite. A fine transparent prism from this locality is in the mineral collection of the British Museum (Natural History) in London and measures 31 × 5 cm (12 × 2 in).¹⁴(p. 322) In 1936, Ward's Natural Science Establishment of Rochester, N.

BERYL LOCALITIES

Y., advertised for sale at \$300 a carving of sea-green aquamarine from this locality which measured 15 × 5 cm (6 × 2 in) and weighed 385 grams.

In addition to these famous mines, numerous beryl occurrences lie to the NE of Sherlovaya Gora, as shown on Fersman's map.^{1, (pl. 9)} They include such well known mines as Oldanda, Antonova, Suktui, Antam, Birka, etc. Granitic beryl pegmatites also occur 54 km (37 mi) and 110 km (69 mi) due E of the city of Borzya on the Altanganskiy Khrebet and Mulina Gora respectively. Another locality is on Gor Khra-Nor near the station of the same name on the Siberian Railway S of Borzya.

Elsewhere, Jeremeyev reported discovery of beryl crystals near the village of Mangut, 260 km (162 mi) S of Chita in the vicinity of the Butev River, Onon River drainage, not far from the Mongolian Republic border.¹⁵ These crystals were pale yellowish green, transparent, and with exceptionally smooth faces of forms *m* and *c*, but also {1121}, {1011}, {2130}, and {13.1.14.1}. They were small in size, however, not over 4 × 2 cm (1.6 × 0.8 in). Orlov described pegmatite beryl crystals from the Groth beryl mines 20 km (12.5 mi) SSE of Narassun village on a tributary of the Gasakin River near the border; forms *m* and *c*, also {2130} and {1120}.¹⁶

Buryat ASSR

This is an autonomous republic lying along the E side of Lake Baikal. Muscovite pegmatites, some with beryl, outcrop in the extreme N near the junction of Mama and Vitim rivers.¹⁷ In the extreme S, beryl occurs in pegmatite bodies near the Mongolian border.¹⁸

Irkutsk-Sayan. An area that is located S of the S end of Lake Baikal and to the W of same. References to granitic pegmatites are meager. Tarasov and Plekanov stated that in the sunken portion of the Sayan graben, a pegmatite belt extends some 460 km (285 mi) and contains bodies yielding ores of beryllium and lithium.¹⁹ Beryl is found in granitic pegmatites in Sangilen highlands,²⁰ and as early as 1849 it was found with topaz crystals in the region of Tunka River SW of the S end of Lake Baikal (p. 272).¹

Krasnoyarsk-Yenesei Mountains. Shcherbakov briefly describes granitic muscovite pegmatites along the Taseyeva River near its confluence with Angara River, about 230 km (145 mi)

N of Krasnoyarsk, but beryl is rare.¹¹ A zoned body near Padun village contained compact masses of yellow beryl.

Altay (Altai) Mountains. This range is about 400 km (250 mi) S of Novosibirsk close to the border of Siberia with the Kazakh ASSR. In 1788, Renovantz mentioned beryl in quartz-feldspar outcrops of the Tigreretsk region but considered the greenish prisms to be a variety of quartz (pp. 268-9).²¹ Later, numerous granitic pegmatite bodies were found in a barren, snow capped granitic range of mountains, the Tigreretsk Byelki, lying about 60 km (38 mi) ESE of Zmeinogorsk. Koksharov notes sky blue and greenish blue prisms to 1 m × 15 cm (39 × 6 in) (vol. 1, pp. 163-4),² while Jeremeyev describes a deep blue aquamarine, 4-5 cm (1.5-2 in) long with basal cleavage and platy cavities parallel to the basal plane and displaying "good asterism."²² Forms: *m*, also {2130} and {1120}. Pilipenko also mentions localities near Kolyvan, Irkutka, and Mt. Posepnaya.²³ Fersman describes pegmatite occurrences and provides a sketch map of three groups of pegmatite mines (p. 356):¹ (1) Tigreretsk, near the town of the same name; (2) a group along the Tulata River near its junction with the Charish River about 90 km (56 mi) ENE of Zmeinogorsk; (3) near the E shore of Lake Kolyvan, 23.5 km (15 mi) N of Zmeinogorsk. Gavrushevitch²⁴ notes that the west Altay granitic pegmatites consist of graphic granite, microcline, quartz, biotite, magnetite, allanite, and zircon as primary constituents with a pneumatolytic phase that introduced quartz, beryl, monazite, zircon, xenotime, tourmaline and muscovite, and a still later phase of quartz, fluorite, ilmenite, hematite, rutile, and bertrandite. Hydrothermal species are epidote, pyrite, rutile and hematite.²⁴ Details on Tigreretsk pegmatites are discussed in Boldryev.²⁵

Kazakh ASSR (Kazakhstan)

The Altay extends SW from Siberia into the NE corner of this republic, and includes granitic pegmatite fields here and along the series of high mountain ranges that extend SW along the borders of Soviet territories with neighboring Sinkiang and Afghanistan. Ginsburg²⁶ describes pegmatite veins carrying pollucite, lepidolite, tourmaline, amblygonite, spodumene, petalite, microlite, and white beryl, among others, in Ungursay and Krasno-Kordon areas of the Kalbin Range, 90 km (56 mi) SE of the city of Ust-

World Sources of Ore and Gem Beryl / Union of Soviet Socialist Republics

Kamenogorsk.²⁶ Greenish crystals with pink cores were found in granitic pegmatite in the Kara-Irtish River basin in the same general region.²⁷ N of Lake Balkash is the Kounrad granite massif in which beryl was found in high-temperature quartz veins with K-feldspar, pyrite, fluorite, sphalerite, chalcopyrite, magnetite, wolframite, bertrandite, and gilbertite.²⁸ Beryl in acicular crystals to 1.5 cm (0.75 in) occurs in vugs in pegmatite in Kentsk granite massif, Central Kazakhstan, with quartz, fluorite, barite, and mica. The crystals are intense blue or greenish and some colorless.²⁹ Properties: $G = 2.77 \pm 0.01$; $\rho = 1.627$ (colorless), $e = 1.607$ (dark blue). These properties and the below analysis identify the mineral as bazzite.

Table 14-42
ANALYSIS OF
BAZZITE, CENTRAL KAZAKHSTAN²⁹

	Percent	Percent	Percent
SiO ₂	58.80	MnO 1.58	Cs ₂ O 0.31
Al ₂ O ₃	0.25	Li ₂ O —	H ₂ O + 2.60
Sc ₂ O ₃	14.44	Na ₂ O 2.82	H ₂ O not found
Fe ₂ O ₃	2.21	K ₂ O 0.22	
FeO	3.68	Rb ₂ O 0.037	
		Total	100.67

Shcherbakov reported beryl pegmatites in Dzungar Ala Tau range E of Lake Balkash and along the upper reaches of the Chorgoss River.¹¹

Tadzhik SSR

The area between Afghanistan and Sinkiang, encloses most of the Pamir mountain ranges. Gavrusevitch located granitic beryl pegmatites in S Ferghana, or S of the city of the same name at the headwaters of Seoch and Lyailyak (or Lailiyak) rivers in the middle of the Turkestan Mountains.²⁴ Granitic intrusions are accompanied by zoned pegmatites with quartz cores. Beryl is found as prisms to 4–5 cm (1.7–2 in) with feldspar, quartz, and muscovite; also with lepidolite and tourmaline in intermediate zones. Jonin notes that such bodies were found over an area of 50 km (32 mi) in extent and included some very large bodies, up to 600 m (660 yd) long and 10–15 m (11–16.5 yd) wide.³⁰ Some are mica, beryl, and garnet pegmatites containing large crystals of feldspar, tourmaline, and cassiterite crystals to 5–7 cm (2–2.7 in). Shcherbakov mentions local-

ities for beryl along the N slopes of the mountains beside the Karavansh River and near the glaciers Tro and Rama on the S slopes;¹¹ many beryl pegmatites also occur on Kryk-Bulak River, a branch of the Lyailyak. Fersman mentions beryl localities at Isfary and Lyal-Khan which may be in this region (pp. 256–7).¹

Uzbek SSR

This division lies NW of Afghanistan and includes part of the Aral Sea. Beryl is found in many pegmatites at upper margin of the granite intrusion of Ala Tau in the central Kyzyl Kum range.³¹

Ural Mountains

Beryl pegmatites occur in three approximately N-S oriented belts: (1) from near Verkhoturysk, 270 km (170 mi) N of Sverdlovsk (formerly Ekaterinburg) south to a point just W of Lipovka or 75 km (47 mi) NNE of Sverdlovsk; (2) from a point about 60 km (37 mi) NE of Sverdlovsk to near the village of Bagryak, about 85 km (53 mi) SE of Sverdlovsk; and (3) from about 35 km (24 mi) NE of Ufaley, thence SSW to Miass Lake (Lake Ilmen). Altogether the total length of these belts, scarcely interrupted, is 415 km (260 mi).^{1, (pl. 2)} (See fig. 14-53.)

Schneiderhöhn provides a concise summary of the structure and petrology of the mountains, as gathered from recent Soviet studies (p. 116).³² Granitic pegmatites containing beryl and other gemstones are associated with Variscian magmatism which formed elongated granitic-syenitic intrusive belts along the E slopes of the Urals. In the Miass area, the pegmatites are intruded into nepheline syenites in part. The best details on specific occurrences were given by Fersman who also provides maps of the more interesting sub-areas.¹

Generally the terrain is hilly rather than mountainous and rugged and completely forested with evergreens, except in flat areas suitable for farming. In the Mursinka-Alabashka area, for example, the relief is so low that ground water hampers mining except in winter, when strong freezes lock up the water and permit excavations below the water tables. In years past, most pegmatite mining, specifically for gemstones and mineral specimens, was administered by local entrepreneurs who hired local workers as needed and operated under authority granted from the Director, Im-

BERYL LOCALITIES

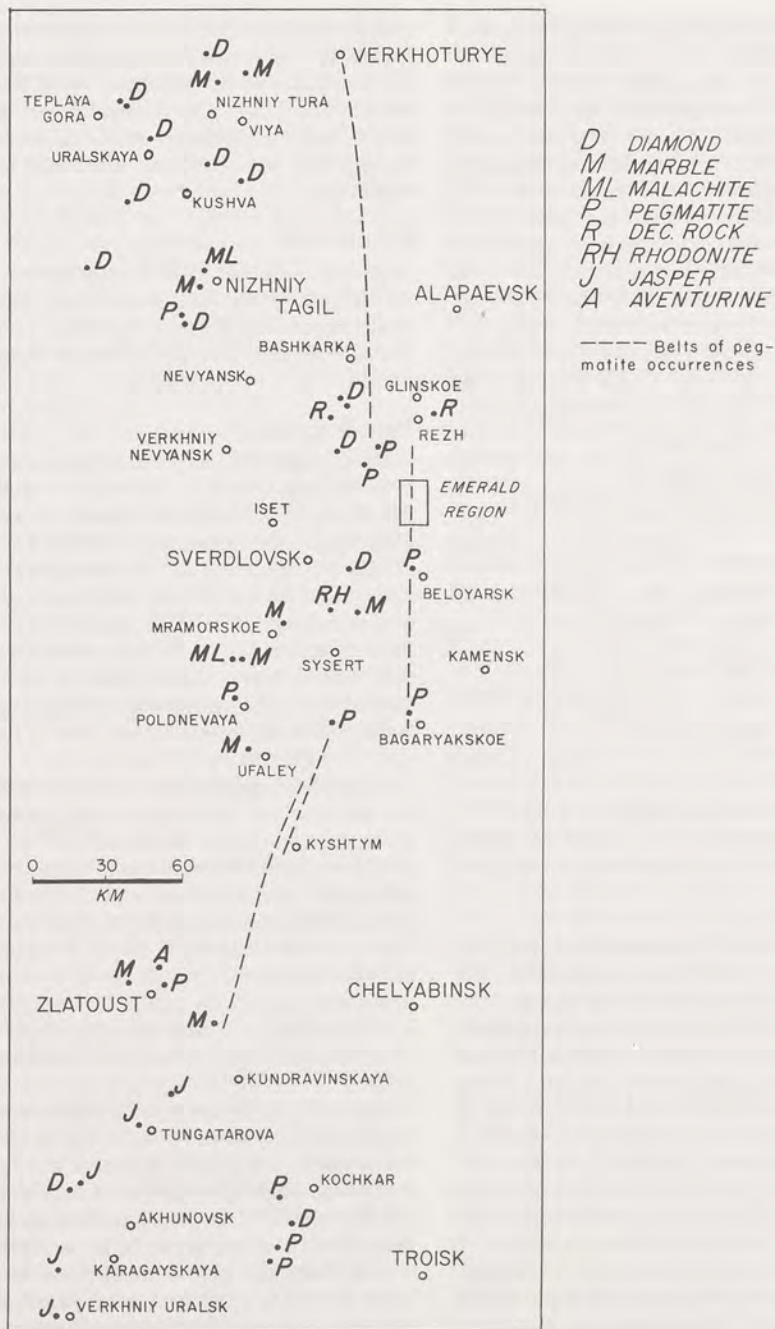

Fig. 14-53 Gemstone deposits along the east flanks of the Ural Mountains, USSR. After the map of A. E. Fersman, *Dragotsennyye i Tsvetnyye Kamni*, SSSR 2 (Leningrad, 1925).

World Sources of Ore and Gem Beryl / Union of Soviet Socialist Republics

perial Lapidary Works, Ekaterinburg. The heyday of gem mining came to an abrupt halt with World War I, and mining was thereafter forbidden by the Revolutionary Government in order to shift workers to occupations considered more helpful to the economy and far more significant than catering to the desires of some for self-adornment. Even today, if the current market is any indication, no gemstones or specimens identifiable as coming from these mines are available and suggest that the deposits are not being worked. However, some recently-mined materials such as nephrite, charoite, etc., have come from the USSR and offer some hope that these mines, as well as those in Transbaikalia, will be reopened and work resumed.

Alabashka-Mursinka-Shaytansk Region. This region is enclosed between 57°45'–15' N, straddling the 61° E meridian, and is centered about 70 km (44 mi) NNE of Sverdlovsk. It is by far the best known and justifiably famous of the granitic pegmatite regions in all of the USSR, being particularly noted for superb crystals of topaz, beryl, and colored tourmaline. A chronology of events, from discovery into modern times, was provided by Fersman who noted that "the first deposits of precious beryl and topaz in Russia . . . [were] discovered by the miner Michael Tumashev in the Mursinki area in the Central Urals in 1668" (p. 65).¹ The emerald deposits, to be considered later, were found in the early part of the last century. In the region, the northernmost group of mines lies around Alabashka village, as shown in fig. 14-54. Other mines are found southward to Mursinka village, thence to the villages of Kornilova, Lipovska, Sarapulka, and Shaytansk, the last known since 1815 for fine pink beryls. The first useful account of the deposits is by Rose, who visited them early in the last century as a member of Humboldt's famous exploring expedition (vol. 1, pp. 439 ff).³³ At Mursinka he found and described various pegmatite minerals, including yellow, transparent beryl crystals, and at Shaytansk, pale rose-red beryls perched on ball-like aggregates of albite. Even at this time, he noted that the mines had been long unworked.

All deposits are in low, wooded, and well-watered terrain, with mining conducted in winter for the reasons mentioned before. Photographs of the mines taken in the early part of the present

century show rude cabins for miners next to open-cuts with crude log cribbings and shaft linings, and primitive but effective hoisting arrangements. Mezhetsky visited the mines sometime before 1886 when many were in operation and found three groups of workings around Mursinka, 44 pits around Mursinka itself, 23 around Alabashka, and 8 around Sarapulka along the Ambarka River.³⁴ However, by 1886, only 9 remained working, mostly for amethyst, while a mine on Krivaya brook was being worked for beryl and topaz. The average annual production was 63.5 kg (140 lb) of amethyst, 6.8 kg (15 lb) of topaz and beryl, and 455 kg (1,000 lb) of quartz. On the other hand, Kalugin visited the area several years later and located 75 mines, of which 65 produced quartz and amethyst, with 54 of the latter number exclusively devoted to these gemstones and 9 mines to topaz, of which 4 also produced gem tourmaline and beryl.³⁵

The pegmatite bodies are variable in size and shape but those around Mursinka are typically lenticular and composed largely of yellowish white to grayish white feldspar, with much graphic granite, minor quartz and still less grayish-white mica. Vugs were numerous and ordinarily filled with brown clay in which many of the crystals occurred loosely. According to Kosharov, the beryl crystals from these mines were the finest in all the Urals and were usually wine-yellow to greenish yellow, but also yellowish green, blueish green and less commonly pale blue (vol. 1, pp. 147 ff).² A large number were transparent, very regularly formed, and ranged in size from individuals that were only a few mm long to some that were several decimeters. A multiple crystal group, found in the Starzevsky mine near Mursinka in November 1828, and placed in the Mining Museum in St. Petersburg, measured 27 cm (10.6 in) long and 31 cm (12.2 in) in circumference. Its value was placed at 42,830 rubles. Another large crystal of the time was in the collection of Grand Duke Nicolai von Leuchtenberg and described as a specimen "distinguished by transparency, beauty and pleasing yellowish green (asparagus green) color and also by size." Presumably this crystal was also from around Mursinka and measured 65 cm (25.8 in) in height and 26 cm (10.2 in) in diameter (vol. 6, pp. 94-7).² It was further notable for its complex termination which bore faces of several dihedral

BERYL LOCALITIES



Fig. 14-54 Detailed map of the Alabashka-Mursinka beryl-producing pegmatites, east flank of the Ural Mountains, USSR. After A. E. Fersman, *Dragotsennyye i Tsvetnyye Kamni, SSSR 2* (Leningrad, 1925).

World Sources of Ore and Gem Beryl / Union of Soviet Socialist Republics



Fig. 14-55 View of the Ural Village of Mursinka, noted for the numerous gemstone-producing pegmatite mines in the neighborhood. Photo by A. E. Fersman taken in 1912 and used in his *Verständliche Mineralogie* (Berlin, 1949).



Fig. 14-56 Typical pegmatite mines in the forests near Mursinka, Urals, from which were obtained aquamarine crystals and other gemstones. Photos by A. E. Fersman from *Ocherki po Istorii Kamnya I* (Moscow, 1954).

BERYL LOCALITIES

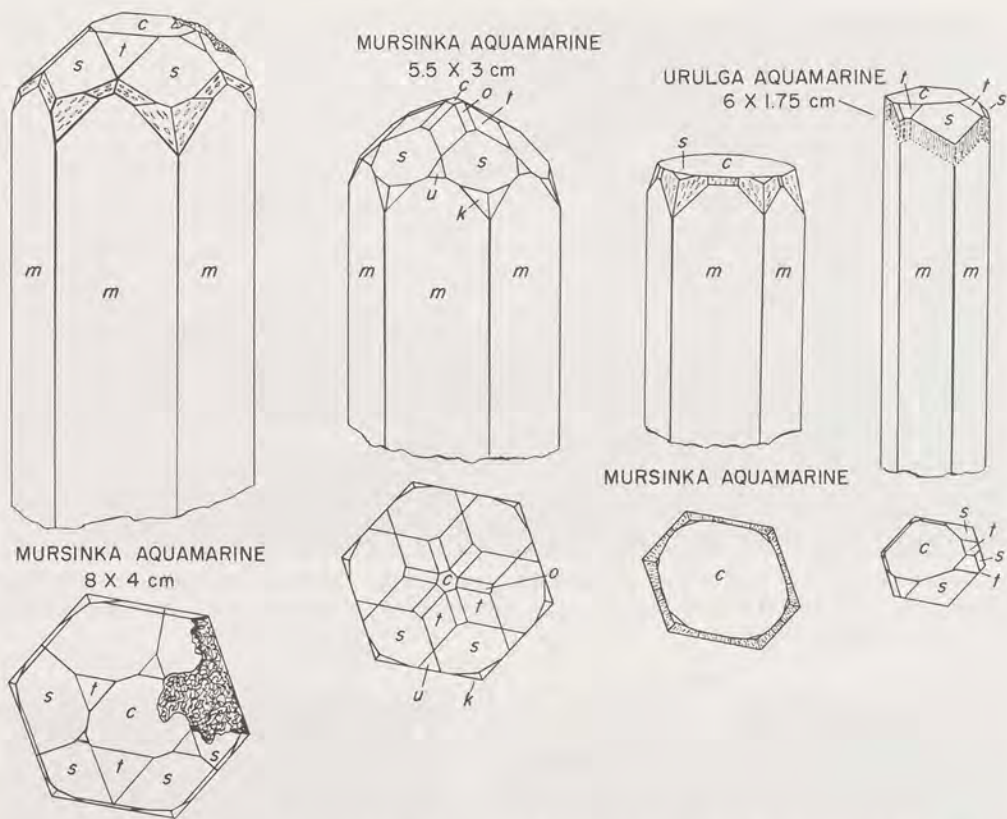

Fig. 14-57 Aquamarine crystals from Mursinka in the Urals and from Transbaikalia. Forms lettered on unetched faces where identification was possible: $c\{0001\}$, $m\{10\bar{1}0\}$, $s\{11\bar{2}1\}$, $t\{4041\}$, $u\{2021\}$, $k\{42\bar{6}1\}$. From N. V. Koksharov, *Materialien zur Mineralogie Russlands* 3 (St. Petersburg, 1858).

gonal-bipyramidal forms and by the fact that "with the exception of a few fissures . . . the crystal is completely transparent."

In addition to aquamarines, rose beryls were also found, especially at Alabashka and Shaytansk, where they occurred in low prismatic to tabular crystals. At Shaytansk they were usually colorless or only pale rose red. Koksharov mentions one that was 5 cm (2 in) long and about as thick (vol. 1, p. 147).² One of the prettiest ever found, however, was 4.5 cm (1.75 in) long and 6.5 cm (2.7 in) wide, of a pleasing pale red color and further remarkable for being implanted on a matrix of granite in association with smoky quartz, lepidolite, and mica. This specimen, at the time, was in the collection of the Mining Academy Museum in St. Petersburg.

Jeremeyev describes white beryl crystals from Mursinka displaying faces of m and c , also $\{10\bar{1}1\}$, $\{2243\}$, and $\{11\bar{2}1\}$ on ordinary prismatic crystals but only m , c , and $\{11\bar{2}1\}$ on tabular crystals.³⁶ Both types of crystals were found in the same deposit and furnished crystals intermediate between these extremes in respect to proportions. Romanovski describes colorless to partly pink crystals from Alabashka with forms m and c , also $\{10\bar{1}1\}$, $\{11\bar{2}1\}$, and $\{11.1.\bar{1}2.1\}$ and on colorless crystals, m , c , and $\{11\bar{2}1\}$, $\{10\bar{1}1\}$, $\{21\bar{3}1\}$, $\{3141\}$, and $\{4041\}$.³⁷

Adui River District. This area lies S of Shaytansk or 45 km (28 mi) NNE of Sverdlovsk. Fersman describes 7 mine groups in this small district, all sunk upon granitic pegmatites in two-mica granite and granite-gneiss, but with differences

World Sources of Ore and Gem Beryl / Union of Soviet Socialist Republics

in genesis which made them more like beryl-bearing quartz veins with little microcline rather than the usual granitic pegmatites (pp. 115–22).¹ Rare species include monazite, allanite, titanite, zircon, xenotime, tourmaline, biotite, and later minerals such as fluorite, ilmenite, hematite, rutile, bertrandite, pyrite, and epidote. A famous deposit here, known as the Monetnaya Dacha mine, was worked by a shaft sunk to 20 m (22 yd) on a pegmatite body 2–3 m (3.3 yd) wide and exploited by a local combine in 1900. "In a few weeks," states Fersman, the miners "collected more than a half-ton of grass-green beryls to the value of 46,000 rubles" (p. 136).³⁸

EMERALD DEPOSITS OF THE URALS. Uralian emeralds were surely discovered in the early part of the last century, but it has been suggested by various writers that these deposits may have been the source of the Scythian emeralds mentioned by Pliny in his *Natural History*, and hence known long before. The Scythians inhabited some vaguely-defined region N of the Black Sea and it is conceivable that they were in communication with tribes living in the Urals. Greek and Roman writers spoke of fabulous precious stones from the mysterious Rhípaí Montes, which mountains, according to the *Oxford Classical Dictionary*, lie between 57°30' and 63°21' N but are not further identified. However romantic these speculations may be, there is no firm evidence that emeralds were found earlier than the modern era. What is certain is that the first *in situ* crystals were found in 1830 or 1831 near the small brook called the Takovaya in an area lying about 45 km (28 mi) NE of Sverdlovsk. According to Rose, the stones were found by a woodcutter from Bieloyarsk village in decomposed mica schist exposed among the roots of a wind-fallen tree (vol. 1, pp. 483 ff).³³ The peasant collected several stones and took them to Kokavin, the Director of the Imperial Lapidary Works at Ekaterinburg. He recognized them as emeralds and directed the finder to take him and a working party back into the woods to where they were found. A series of exploratory trenches laid bare a vein-like body of schist in which the emeralds were imbedded. As early as 1832, Rose further remarks, a fine crystal of 20 cm (8 in) tall and 13 cm (5 in) wide had been found and sent off to St. Petersburg for the mineralogical collection of the Mining Academy.

A somewhat different version of the discovery was given by Atkinson, who picked up a local tale during a visit to Ekaterinburg (now Sverd-

lovsk) explaining that the crystals were found by children playing in the forest, and the gems were "tossed about in the cottage for a considerable time before their character was recognized. At length they were sent to Ekaterinburg, and were most splendidly cut in the Granilnoi Fabric" (p. 100).³⁹ Atkinson goes on to say that the stones, clearly the property of the Tsar according to law, were sent off to Germany instead of to St. Petersburg and sold illegally to the family of a reigning prince. Some years later, the prince's consort wore jewelry incorporating these stones during a state occasion in Russia, where they were seen by the Tsarina. When the Tsarina asked where they came from, she was told that they were from the Urals, a statement that both astonished her and perhaps excited envy. After the Tsar heard this, he sent an officer to Ekaterinburg to investigate and to search the houses and buildings of all persons connected with the lapidary works. As a result, the home of the director yielded several emeralds of great value, although the director claimed they were being kept for safe keeping. Despite pleas of innocence, he was sent to prison, and there he died some years later. Atkinson states that the director was actually innocent but became the scapegoat to protect the guilty party who was "closely connected" with the throne.

In still another version of these gems' discovery, Grevingk claims that the crystals were found in 1830 by a charcoal-burner, and that in the next year, 1831, systematic mining began under the direction of the lapidary works administration.⁴⁰ Koksharov agrees with this discovery date and adds that the finder was a certain Maksim Koshchevnikov, as reported in a story in *Gornye Zhurnal*, 1831, vol. 2, p. 147.² In any event, Grevingk notes that the first few years' work produced outstanding crystals, one of which was presented to the Tsarina, who had it cut into a 101.25 carat pear-shaped gem valued at 6,075 rubles in 1832. Upon invitation of Count L. Perovsky, Minister of Appanages in St. Petersburg, Grevingk conducted the first systematic investigation of these deposits, and in 1853, he published the first geologic map of the mine district.⁴⁰ By this time, a series of pits had been sunk upon the N–S outcrop of the emerald-bearing schist, and the mines had been named as follows: (from N to S) the Marinsky and nearby Krestovik; the Troitsky or Starsky; the Lubinskaya or Takovskaya (the original find); the Stretensky; and a branching belt of sim-

BERYL LOCALITIES



Fig. 14-58 View of the famous lapidary and mining center of Ekaterinburg in the Urals, engraved from a photograph taken about 1865. From T. W. Knox, *Overland Through Asia* (Hartford, 1871).

ilar schists farther to the S contained the Ostrovsky, Krasnobolotsky and Chitny mines.

In the district, the terrain is low, wooded, swampy in places, and drained by several brooks which feed into the north-flowing Bolshoi Reft River or its branches. The highest point at the mines is only a little over 11 m (36 ft) above the level of the river. In 1853, the northernmost mines, the Marinsky group that have been worked since 1834, included a sorting house for ore, a blacksmith shop, and dwellings for workmen. Like the rest of the mines, it was a large opencut which exposed three biotite schist veins, the largest of the latter not over 1.5 m (5 ft) wide. Ground water was a severe problem, and continual pumping was required. Other mines examined by Grevink resulted in recommendations for mining but more importantly, drew attention to characteristic mineralogical associations which could be used as prospecting guides.

Apparently some emerald crystals from the outcrops found their way into nearby gravel beds, for it was reported in 1842 that a rounded crystal of $\frac{3}{4}$ solotnik (ca. 4 gm) was found in the Pokrovsk-Danilovsk alluvial gold mines on Sche-

meika brook, which lies N of the emerald deposits not far from the Marinsky mines (vol. 1, p. 180).² This stone was completely clear and of beautiful color. Small emerald crystals were subsequently found in stream gravels elsewhere in the district.

Opencut mining, carried on until about mid-19th century, was abandoned in some of the deposits in favor of shafts and tunnels with mechanization of ore-crushing and sorting. Steady production was maintained toward the latter part of the century when costs, sporadic finds, and other factors, forced closure of most of the mines (pp. 128 ff).¹ Considerable work was done in 1898, but little emerald was recovered.⁴¹ In 1900, the mines were leased to "The New Emeralds Company," at which time they were examined by Zemyatchensky, who furnished some mineralogical notes on the deposits.⁴² After World War I, the mines were taken over by the Soviet Government, who formed a "Precious Stones Trust" in 1923 to administer these and other gemstone deposits.⁴³ In 1925, the Trust announced that the emerald mines and the lapidary plants at Peterhof, Sverdlovsk, and Kolivan would work through 1925-26, with the aim of increasing production



Fig. 14-59 *Top*: bridge crossing the celebrated Takovaya Brook, the scene of the first emerald discovery in the Urals. *Bottom*: tumbling and washing samples of emerald-bearing rock to remove mica and isolate emerald crystals. Photos by A. E. Fersman, "Smaragdgruben im Uralgebirge," *Abhandlungen zur praktischer Geologischer und Bergwirtschaftslehre* 18, part 1 (Halle, 1929).



Fig. 14-60 Top: prospect pits being opened in the forest near the Stretensky emerald mine, Urals. Bottom left: a long trench dug to expose bedrock in order to aid in mapping the geology of the emerald formations. Bottom right: washing samples of emerald-bearing rock. Photos by A. E. Fersman, "Smaragdgruben im Uralgebirge," *Abhandlungen zur praktischer Geologischer und Bergwirtschaftslehre* 18, part 1 (Halle, 1929).

World Sources of Ore and Gem Beryl / Union of Soviet Socialist Republics

at the emerald mines to 10,000 carats of stones, it being noted that in a previous year (1924) only 2,500 carats had been produced.⁴⁴ In 1927, the New York precious stones firm of Heller & Son announced that they had won the competition to lease the mines, stating their intention to work them with American machinery and to send the gems to Paris by air.⁴⁵ According to Gilliams, when Heller & Son experts visited the mines they found them deep in the forest, employing about 700 persons, including several hundred women, but with the pit work accomplished by men only.⁴⁶ Practically all mining and haulage was done by hand. The shafts at this time were sunk to depths of 30 m (100 ft) below the surface in some places, and a constant battle was being waged to keep ahead of the large influx of water. About three cubic meters of rock on the average had to be mined to produce one carat of emerald. Cutting of gems was extremely primitive, the lapidaries using only hand-held quadrants set to specified angles for applying the facets. Only about 20% of the rough sent to Sverdlovsk was suitable for cutting and the production varied widely from month to month.⁴⁷

In 1931, Lavrov noted that rough was produced at a rate of 100,000 carats per annum, with a potential reserve of ten million carats, but this seems optimistic when compared to previous remarks on production.⁴⁸ Lavrov further quoted Fersman as the authority for an estimate that from 1830 to 1930, 36,000 pounds (16,330 kg) of crystals had been mined, but only 500,000 carats proved suitable for cutting. Taking \$7.50 per carat as an average, according to Lavrov, the sum of \$3,750,000 had been so far realized from the mines. In contrast, Herman and Wussow noted that production, while rising in the 20s began to sink by 1937, and mining had to be stopped because of water problems.⁴⁹ They also reported that in 1900, a British company, "The New Emerald Company," obtained the mining concession, but this was later taken over by a French firm whose activities were curtailed because of the Revolution. Later, when the government's Precious Stones Trust took over, rights to mine in 1925-1926 were awarded to the miners themselves, who united into federations and sold their output to the Trust. At this time, the annual production, mainly from the Troitsky mine, operating in emerald-bearing schist at the 44 m (150 ft) level, was 50,000 carats per annum, selected from the output of a new dressing plant installed

in 1925. Fersman notes that the Troitsky mine, the best known of all, had its name changed to Pervomaysky ("First of May") in honor of the Revolution.⁵⁰

During the 1940s, a system was devised whereby the ore was taken by trucks to the processing plant, broken up in tromeels, and washed to get rid of enclosing mica. Sorting was done on a long trough-like table supplied with running water where women were given the task of separating the emeralds from the waste. Sorted stones were sent to Sverdlovsk where they were further cleaned and suitable crystals were cut into gems. The gems were then made up into parcels and sent to Moscow, and after additional sorting were shipped to Paris, New York, and the East.

Not much is presently known about the current status of the mines inasmuch as the entire region around Sverdlovsk is forbidden to visits by foreigners. In about 1970, some lots of emerald rough were made available for export, but the material seen in the United States was disappointingly low in color, quality, and freedom from flaws, and was generally so poor that it was unsuited for any lapidary purpose whatsoever.

In terms of quality, the best Uralian emeralds compare very favorably with the finest stones from any other source, but such stones were generally very small in size and large ones were the exception. Many of these have long since disappeared into the sea of anonymous cut gems and are no longer distinguishable, except perhaps by examination and evaluation of inclusions. Epler,⁵⁰ in describing famous emeralds, remarks that the Tsarist treasures included a number of splendid cut emeralds and also crystals and specimens of great interest. Exceptional specimens were sent to the Imperial Mineral Cabinet in St. Petersburg, one of which was a crystal 25 cm (10 in) long and 12 cm (4.75 in) in diameter. Another, a splendid double crystal, measured 17 × 10 cm (6.7 × 4 in) and weighed 8,398 carats. Especially noteworthy was a matrix specimen of 25 × 30 × 12 cm (14 × 12 × 8.7 in) that weighed 31,259 carats. Other fine examples are said to be in the collection of the Mining Academy at St. Petersburg, including a crystal of 20 × 13 cm (8 × 5 in). Most of these mammoth emeralds are still preserved, but recent visitors claim that they are largely non-gem material. Koksharov also notes the great variation in crystal sizes, and mentions several giants, such as one that reached 40 × 25 cm (16 × 10 in) and a

BERYL LOCALITIES

matrix specimen in the Tsar's collection which was "a piece of mica-schist upon which numerous emerald crystals were grown which were 10 to 12 cm long" (vol. 1, p. 181).² Another crystal in this collection was 25 × 12 cm (10 × 4.75 in) and seems to be the same mentioned by Eppler above. For the most part, the crystals were seldom over 3–4 cm (1.25–1.6 in) long and as is usual in such instances, provided the bulk of cuttable material.

Geology and Mineralogy of the Deposits. The deposits were intensively studied by Fersman for at least a decade, and of his two articles on them,^{51,52} the one in German is the most conveniently accessible. Many of his findings as well as notes on history, mining, and commerce are incorporated in his study of Russian gemstones.¹ A summary of the most important conclusions appear in Schneiderhöhn³² and Beus,⁵ while the most recent work is that of Vlasov and Kutakova,⁵³ part of which was translated into English by U. S. Joint Publications Research Service as *Emerald Mines (of the Urals)*, JPRS 5979, 1 November 1960.

The emerald district is on the E side of the Ural range and is oriented approximately N–S. It consists of three zones of differing petrological character, described from west to east. *Western zone:* biotite and two-mica granites, muscovite granites, pegmatite bodies, and inclusions of amphibolite bodies. *Central zone:* Paleozoic metamorphic rocks, more or less following the granite contact for about 25 km (15.8 mi) and about 0.5–0.7 km (0.3–0.44 mi) wide and consisting of serpentine, talc-serpentine, talc, talc-chlorite, talc-phlogopite, tremolitic rocks, amphibolites, amphibole-gneisses, quartzites and others, in which occur small lenticular bodies of peridotites and talc-peridotites usually converted to serpentines. All these are invaded by many quartz diorite and diorite-porphyrite dikes.⁵³ This zone contains the emerald-bearing complex as shown in Fig. 14–61. *Eastern zone:* basic and ultrabasic rocks of the Asbestovskiy intrusion, as peridotites, dunites, pyroxenites, and gabbros.

According to Fersman, the formation of the Central Zone resulted from entrapment and compression of sediments between the acidic granites of the Western Zone massif and the basic and ultrabasic rocks of the Eastern Zone massif, with introduction of mineral materials from both into the Central Zone, especially via pegmatite

intrusions from the western granites. Subsequent chemical activity altered these rocks, and because of the introduction of many new elements, some of them rare, caused formation of about 40 mineral species that were recognized during Fersman's time. This number was subsequently raised to 80 by later workers. The Central Zone rocks formed in sheet-like or vein-like masses elongated parallel to the strike of the contact but with much local interlamination and distortion (see fig. 13–5). In general, the process of metamorphism was one of transfer of elements from the silica-rich granites on the one side and elements from the basic rocks on the other side, among the former being beryllium and among the latter being the chromium necessary to impart the emerald color to beryl. Evidences of chemical activity in the Central Zone are migmatites, reaction rims, desilicified pegmatites, and the zone series of actinolitic, talcose, and chloritic rocks, not to mention the biotite-phlogopite micas in which many emeralds occur.

Emerald is found almost exclusively in biotite schists of the Central Zone according to Fersman,⁵² especially in places where quartz or granitic pegmatite lenses occur. Less commonly, emeralds appear in actinolite-talc or talc schists, but in such areas biotite is present in quantity. The darkest and best grade crystals were found in biotite schists, some good crystals were found in quartz when it was enclosed in biotite, and elsewhere beryl (almost colorless) occurred in feldspar. Most emerald crystals are in hanging-wall portions of the biotite schists, commonly associated with fluorite, apatite, and phenakite but not alexandrite. The greatest concentrations were found wherever the rocks were most strongly compressed, bent, or distorted.

In contrast to the above, Vlasov and Kutakova offered significantly different views on the occurrences and associations of the emeralds.⁵³ They stated that "the emeralds are found only in desilicized pegmatites," and "tend to occur mainly in the phlogopite zone and at its contact with plagioclase bodies and cores. Emeralds are often present in the plagioclase itself. It is considerably rarer that the emerald crystals are observed in the phlogopite-talc zones in which the talc has formed with the phlogopite. In isolated cases the fine emerald crystals occur in quartz separations in the plagioclase cores, as well as in actinolite lenses and phlogopite-tremolite zones."⁵³

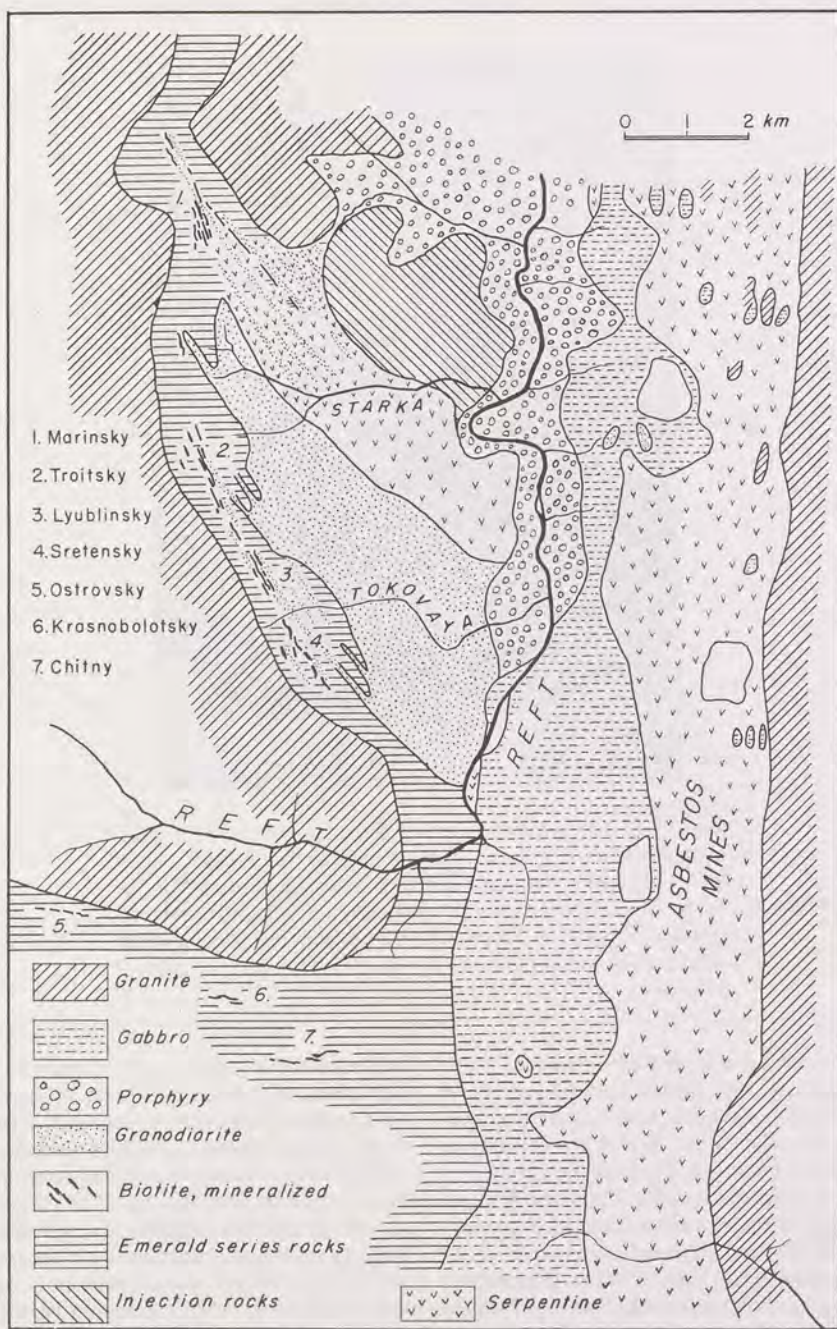

Fig. 14-61 Generalized geological map of the emerald mine region on the east flank of the Ural Mountains. After A. E. Fersman, "Smaragdgruben im Uralgebirge," *Abhandlungen zur praktischer Geologischer und Bergwirtschaftslehre* 18, part 1 (Halle, 1929). A much more detailed map is available in K. A. Vlasov and E. I. Kutakova, *Izumrudnye Kopi* (Moscow, 1960) p. 10; but Fersman's map shows more clearly the locations of the emerald-bearing biotites in the several mine groups.

BERYL LOCALITIES



Fig. 14-62 Aleksandr Evgenevich Fersman (1883–1945), Russian geochemist, mineralogist and gemologist. From his studies of the Uralian emerald deposits he was able to explain the origin of schist-type emerald deposits and account for the coloration of beryl by introduction of chromium. Frontispiece photo from *Akademikh A. E. Fersman Izbrannye Trudy 2* (Moscow, 1953).

They also noted that elsewhere "emeralds found in the phlogopite-talc zones also display intensive green color . . . emeralds which occur in plagioclase, on the other hand, contain the least inclusions, are less corroded, although the intensity of color is considerably weaker." In respect to associations, "the closest associations characteristic of the emerald are phlogopite, plagioclase, fluorite, topaz, apatite and beryl."⁵³ Thus it seems that the mica intimately associated with the emerald is phlogopite rather than biotite, which species is not mentioned at all by Fersman.

Common Beryl. This variety is found in the granitic pegmatites as well as in desilicated pegmatites, as yellowish or even colorless crystals,

but assumes a greenish color when containing chromium, with the most intense green occurring in crystals enclosed in phlogopite. Habits are short to long prismatic, also in granular masses and groups of radiate prisms. Common forms are m and c , rarely $\{11\bar{2}1\}$, and $\{11\bar{2}0\}$. The crystals are seldom well-terminated. Longer prisms are commonly striated parallel to the c -axis and some stubby prisms are often fluted or irregularly-formed. Color zoning is common parallel to the basal plane and less so parallel to faces of prism m . Transparent to translucent. The size is variable, usually about 6×1.5 cm (2.3×0.7 in) but also up to 20×7 cm (8×2.7 in) and larger.

Vlasov & Kutakova also provide trace element

World Sources of Ore and Gem Beryl / Union of Soviet Socialist Republics

Table 14-43
PARAGENESIS OF CENTRAL ZONE MINERALS
Vlasov and Kutakova⁵³ p. 182

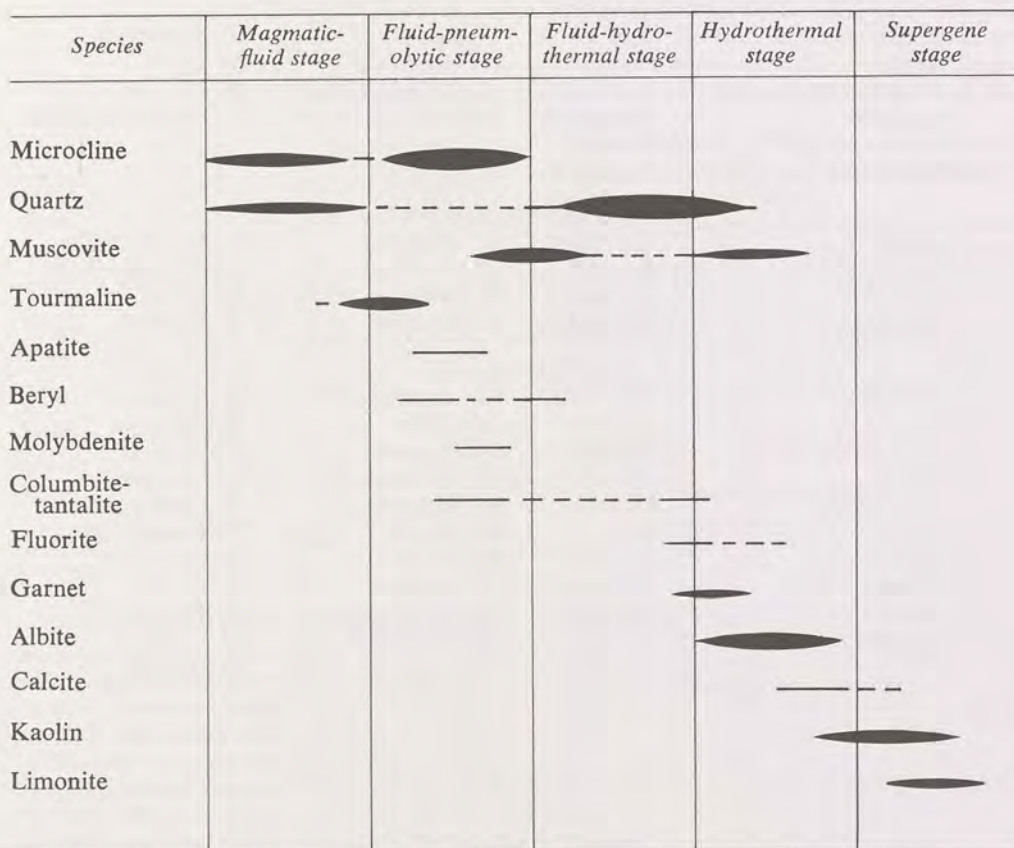

determinations, x-ray data for beryl and emerald, and dehydration versus weight loss curves.⁵³

Emerald. Usually the crystals are long prismatic, often jointed or broken, and recemented within the enclosing phlogopite. The prism faces are well-developed, but the terminations seldom of good quality. In size they range from 3 to 5 cm (1.2–2 in) long and up to 1 cm (0.3 in) in diameter, but sometimes reach dimensions of 20 × 5 cm (8 × 2 in), and very rarely, larger. Color zoning is characteristic, an outer colorless layer usually enclosing an intensely colored core. Rarely the crystals are color-zoned parallel to the basal plane. Transparent to translucent. Properties

are given in Table 14-45, but a specimen from talc schist gave $o = 1.586$, $e = 1.582$, difference 0.004.⁵³

Inclusions are abundant; platelets of phlogopite, talc; actinolite needles; slender prisms of tourmaline; gas-liquid etc. Some crystals were strongly corroded by phlogopite, muscovite, and corundophyllite with mechanically-formed cracks filled with plagioclase, quartz, phlogopite, muscovite, and fluorite. Crystals taken from plagioclase are smoother, more lustrous, and with fewer inclusions.

EMERALD MINES AND ASSOCIATED MINERALS. The following data are from Fersman.⁵²

BERYL LOCALITIES

Table 14-44
MINERALS OF THE URALIAN EMERALD DEPOSITS
Vlasov and Kutakova^{53,pp.67-8}

<i>Principal Primary Species</i>			
1. Microcline	7. Opal	13. Biotite	19. Hornblende
2. Albite	8. Fluorite	14. Prochlorite	20. Talc
3. Oligoclase-Andesine	9. Muscovite	15. Corundophyllite	21. Olivine
4. Kaolinite	10. Phengite	16. Penninite	22. Monocl.-pyroxene
5. Quartz	11. Fuchsite	17. Tremolite	
6. Chalcedony	12. Phlogopite	18. Actinolite	
<i>Accessory Rare Element Species</i>			
23. Beryl	27. Alexandrite	31. Columbite	35. Ferrimolybdate
24. Emerald	28. Bavenite	32. Microlite	36. Molybdc Ochre
25. Phenakite	29. Bertrandite	33. Molybdenite	37. Zircon
26. Chrysoberyl	30. Be-margarite	34. Powellite	38. Scheelite
<i>Secondary Species</i>			
39. Apatite	49. Chrysotile	60. Corundum	70. Sphalerite
40. Garnet	50. Asbestos	61. Calcite	71. Pyrrhotite
41. Tourmaline	51. Prehnite	62. Dolomite	72. Pyrite
42. Topaz	52. Stilbite	63. Rhodochrosite	73. Marcasite
43. Clinohumite	53. Phacolite	64. Malachite	74. Chalcopyrite
44. Epidote	54. Rutile	65. Azurite	75. Bornite
45. Zoisite	55. Ilmenite	66. Stibnite	76. Chalcocite
46. Clinozoisite	56. Chromite	67. Bismutite	77. Covellite
47. Spheue	57. Magnetite	68. Basobismutite	78. Graphite
48. Antigorite	58. Hematite	69. Tetradyomite	79. Copper
	59. Limonite		80. Bismuth

Table 14-45
BERYL PROPERTIES
Vlasov and Kutakova^{53,p.114}

Source	Habit	Color	G	<i>o</i>	<i>e</i>	Diff.
Normal granitic pegmatite	Short columnar	Light yellow	2.675	1.576	1.570	0.006
Phlogopite zone, desilic. pegm. with musc.-fluorite lenses	Long prismatic	Light green	2.70	1.580	1.574	0.006
Plagioclase lenses, desilic. pegmatite	Long prismatic	Greenish white	2.683	1.580	1.574	0.006
Phlogopite zone, desilic. pegm., with plagiocl. lenses	Long prismatic	Light green	2.713	1.582	1.576	0.006
Pneumatolytic-hydrotherm. vein	Short prisms	Colorless	—	1.584	1.578	0.006

World Sources of Ore and Gem Beryl / Union of Soviet Socialist Republics

Table 14-46
ANALYSES OF BERYLS
Vlasov and Kutakova,^{53,p.116}

	Color Phase		
	Light Yellow	Light Green	Colorless
SiO ₂	66.03	64.99	64.38
Al ₂ O ₃	18.95	18.38	19.48
Cr ₂ O ₃	—	0.06	—
Fe ₂ O ₃	0.42	0.23	trace
BeO	12.33	13.83	13.72
MgO	0.21	—	0.11
CaO	0.78	0.40	0.30
Na ₂ O	0.65	1.16	1.10
K ₂ O	0.0116	—	—
Li ₂ O	0.105	0.30	—
Cs ₂ O	0.095	—	—
H ₂ O+	0.55	0.90	1.25
H ₂ O-	—	0.00	—
Totals	100.67	100.25	100.34

Marinsky Mines. The most productive, yielded the finest emeralds, wine-yellow and rose phenakites, large aggregates of fluorite (into hundreds of tons!), and beautiful rutile crystals from phlogopite or talc-chlorite schists adjacent to emerald veins. Also faint greenish beryls were found in large crystals and masses to 50 kg (110 lb); black to green tourmaline and handsome specimens of actinolite and rose fluorite were also mined. In 1924, one mass of ore about 10 cubic meters contained so many emeralds that it was estimated it would produce 1.5 millions in gold marks of emeralds.

Troitsky or Starsky Mines. Formerly principal workings with the deepest shafts to 50-70 m (55-78 yd), yielding garnets, greenish fluorite, tourmaline, coloumbite (good crystals in albitite), also very rarely alexandrite, phenakite, and apatite crystals.

Lublinsky or Tokovsky Mines. Remarkable for rare occurrences of wine-yellow topaz but in poor crystals not over 3 cm (1.3 in).

Stretensky Mines. It is here that emeralds were first discovered in the Urals. The deposits are noted for extraordinarily large emerald crystals

which are always associated with phenakite and apatite.

Krasnobolotsky Mines. These were discovered in 1839 and are especially famed for dark color alexandrite crystals. During 1915 and 1922, over 1,000 small, flat, and sharp twins were found and sent to the Mineralogical Museum, Academy of Sciences, Leningrad. Ordinary chrysoberyl was also found.

Ostrovsky Mines. These deposits produced splendid twin crystals of alexandrite and some small phenakite crystals.

In view of the interesting species associated with emerald in these deposits, a few words on them appear below, taken largely from Vlasov and Kutakova⁵³ and Fersman.⁵²

Phenakite. This species is found in desilicated pegmatites and in clinohumite-dolomite masses cutting serpentine. The crystals are usually crude

Table 14-47
ANALYSIS OF EMERALD
Vlasov and Kutakova^{53,p.122}

	Percent	Percent	Percent
SiO ₂	64.69	BeO	13.37
TiO ₂	nil	MnO	trace
Al ₂ O ₃	15.16	MgO	1.89
Cr ₂ O ₃	0.25	CaO	0.80
Fe ₂ O ₃	0.35	Na ₂ O	1.80
		K ₂ O	trace
		H ₂ O+	1.29
		H ₂ O-	nil
		Total	99.60

Table 14-48
SPECTROGRAPHIC ANALYSIS OF
EMERALD
Vlasov and Kutakova^{53,p.122}

Zone of Crystal:	Outer	Inner
Vanadium	0.5%	—
Nickel	0.025	0.005
Gallium	0.005	0.005
Lithium	0.07	0.07
Scandium	0.03	—
Cobalt	0.001	—
Copper	0.0005	0.0005

BERYL LOCALITIES



Fig. 14-63 Magnificent matrix specimen of twinned alexandrite crystals, with emerald crystals, worked out of enclosing rock and reputed to be the finest specimen of its kind in existence. Several crystals of emerald appear at left center and lower right. Dimensions are about 25 cm (10 in) long, 14 cm (5.5 in) tall and 11 cm (4.4 in) wide. Formerly in the collection of P. A. von Kotchubey. From N. von Koksharov, *Materialien zur Mineralogie Russlands* 4 (St. Petersburg, 1862).

or rounded but sometimes sharp and then short prismatic in habit, or sometimes flattened into a discoidal habit, all with rhombohedral terminations. In some specimens, no traces of crystal faces occur and the whitish to colorless masses assume almost ball-like or botryoidal shapes. The sizes of crystals range from a little over one centimeter in diameter to 6×5.5 cm (2.3×2.2 in), and rarely to as much as $10 \times 9 \times 8$ cm ($4 \times 3.6 \times 3.2$ in). One aggregate of crystals was found which measured $18 \times 15 \times 12$ cm ($7.2 \times 6 \times 4.75$ in). In addition to white and colorless, wine-yellow crystals have been found but the latter hue fades in sunlight. Transparent to translucent, with some transparent crystals affording faceted gems.

Chrysoberyl. Crystals from these deposits are world-famous for two reasons, providing firstly, the rough for alexandrite gems, and secondly, fine, sharp sixling twins much prized by mineral collectors all over the world. The gem variety is very rare because most crystals are minutely frac-

tured and seldom contain unflawed areas. However, when such do occur, they can be faceted into gems which display a remarkable color change from raspberry red in candle or tungsten light to emerald green in daylight. As a rule, the crystals are short prismatic, also flattened, and commonly like thin plates in habit, but granular aggregates also occur. It is also rarely found in short to long prismatic single crystals or forming two-individual twins. The platey crystals are usually striated and all types are covered with flakes of phlogopite and chlorite. Hues in the ordinary variety range from yellow, greenish-yellow to brownish-yellow, but in the alexandrite variety, the color appears a very dark green to olive green in daylight with the color change noted above evident when the crystals are examined under artificial light. The alexandrite is colored by about 0.30% Cr. The prized sixling twins of hexagonal outline appear in the illustration of Figure 14-63, the largest known group of alexandrite crystals, measuring $25 \times 14 \times 11$ cm ($9.9 \times 7.6 \times 4.3$

World Sources of Ore and Gem Beryl / Union of Soviet Socialist Republics

in), with the largest pseudo-hexagonal twin crystal being 9 cm (3.6 in) in diameter. However, most crystals are smaller, generally about 1.5 × 1.5 × 0.7 cm (0.7 × 0.7 × 0.3 in).

Apatite. Found in beautiful, long crystals of delicate pale green color or as large, well-formed, flattened crystals of rose color.

Bogdanovich Emerald Deposit. This is a minor occurrence shown just NW of the town of that name, 58 km (36.5 mi) E of Sverdlovsk on Fersman's map of Uralian occurrences (p. 48).¹

Ilmen Mountains. These are part of the Ural Chain, oriented approximately N-S, and lying immediately E of Miass or about 80 km (50 mi) WSW of Chelyabinsk. The region was populated by Cossacks by the end of the 18th century, and pegmatite bodies were mined for muscovite by a certain Prutov. Further explorations revealed pegmatites with topaz, beryl, and amazonite.^{1,38} In 1826, the mines were visited by I. N. Menge of Lübeck to collect minerals, at which time he discovered zircon crystals and drew attention to the interesting nature of the local mineralogy, encouraging local authorities to search for new deposits.³³ By the time of Rose's visit in 1830, mines had been established around Lake Ilmen directly E of Miass, including a group of topaz mines on the SE side of the lake which had been in operation for some years before.³³

Melnikov⁵⁴ noted that in about 1886, not less than 87 mines had been opened, some of which were begun in the first two decades of the century, but others had opened in the previous century. According to Fersman, at least 200 mines had been opened at one time or another in the district, the best-known being those that exploited granitic pegmatites containing amazonite, topaz, and beryl, with amazonite being locally regarded as a favorable sign of pocket mineralization.³⁸ "Without this [amazonite] there are no gemstones, and the resident miners, after long years of experience, prized this indication as the best for the simultaneous occurrence of topaz."³⁸ Furthermore, the darker the amazonite, it was claimed, the more favorable it was as a sign of topaz in vugs.

Fersman's strip map of the region (p. 224)¹ placed mines along the SE and S shores of Lake Ilmen, thence between this lake and Lake Argayash, which lies about 3 km (1.9 mi) E of Lake Ilmen, thence to a point about 4 km (2.5 mi) due E of Miass. These mines are on the SW slopes

of Gora Kosaya, with another group about 8 km (5 mi) NNE of Miass. Locally, a complex of igneous and metamorphic rocks, mostly granite-gneisses and gneisses with subordinate amounts of amphibolite and some quartzites, as well as bodies of biotite-nepheline syenites, extends N-S for a distance of about 135 km (85 mi) and reaches widths of 15 km (9.3 mi), in which belt are intruded granitic pegmatites. The latter are abundant in zones of granite-gneiss but also intrude other rocks of the belt. They largely consist of pink microcline perthite, gray quartz, and black mica, often with considerable graphic granite and sometimes amazonite in central portions, and at times, highly developed albitization. Rarer species include beryl, topaz, tourmaline, and phenakite in albitized vugs, also spessartine, monazite, columbite and samarskite, among others.^{55,56} Brief descriptions of Ilmen species appear in Titov.⁵⁷

Among gem species, the topazes were the most important, forming crystals of rare perfection and luster as individuals to 5 cm (2 in) length, although in earlier days some were found that weighed 3-4 kg (4.5-10 lb). Koksharov mentions beryl crystals from cavities that were of leek-green color to 25 cm (10 in) long. One such specimen, composed of two individuals, was at that time in the collection of the Mining Academy in St. Petersburg (vol. 1, pp. 162-3).²

ILMEN MINERALOGICAL RESERVATION. Upon the instigation of A. E. Fersman and N. M. Fedorovsky, a portion of the Ilmen Mountains was declared a "mineralogical reservation" of the state in 1920, and thenceforth preserved as a natural park area in which visitors could view numerous abandoned mines and inspect exhibits in a museum building. The latter also houses a mineralogical institute supported by the USSR Academy of Sciences. In 1935, another increment was added and brought the total reservation to 42,000 hectares.

Other localities in this region include pegmatite bodies 13 km (8 mi) SE of Zlatoust and near the Ahtensk mine about 26 km (16 mi) N of Zlatoust.

Kochkar-Sanarka Region. This is centered about 65 km (41 mi) WNW of Troitsk and noted mainly for alluvial gold deposits along the Sanarka and Kamenka rivers (p. 240).¹ In these deposits were found small tabular beryl crystals remarkable for their thinness, measuring 1.5 ×

BERYL LOCALITIES

0.75 cm (0.7 × 0.3 in) across but only 3.5 mm thick.⁵⁸ Forms: *c*, *m*, {1011}, and {1121}; $G=2.6044$ (vol. 8, p. 223).² These deposits also yielded excellent gem crystals of euclase. Beryl-bearing pegmatites and veins occur in a granite massif which outcrops over a considerable area in this region, with beryl being obtained mainly from near the village of Mikhailovsky, in the forest of the same name, and near the village of Borisovka, the latter on the Kamenka River. Pits sunk in granite near Borisovka produced blueish gray beryl crystals.⁵⁴ In a vein near Sanarka village, fully clear greenish yellow crystals to 2.5 cm (0.75 in) in diameter were found. Melnikov believed that the gemstones in the alluvial deposits of Sanarka, Toplaya, and Topkaya in this area owe their origin to decomposition of the granite massif mentioned.⁵⁴

Among species found in the alluvials, the following are briefly described by Fersman (pp. 244–5):¹ spinel, corundum, quartz, amethyst, smoky quartz, chrysoberyl, alexandrite, olivine, beryl, garnet, tourmaline, kyanite, euclase, topaz, actinolite, emerald, diamond, and carnelian. Barbeaut de Marny described gem quality ruby, olivine, and topaz but noted that the emerald was completely opaque.⁵⁹

Kola Peninsula, Karelian ASSR. Beryl occurs in complex granitic pegmatite at Leshaya in the N part of the peninsula, associated with eucryptite, pollucite, amblygonite, rubellite, cleavelandite, achroite, quartz, and muscovite.^{60,61} In the SE part, greenish yellow prisms of beryl to 15 cm (6 in) long come from undifferentiated plagioclase-microcline pegmatites;⁶² $\sigma=1.583-1.585$, $e=1.578-1.581$, $\text{diff.}=0.003-0.005$; $G=2.72-2.75$; an analysis is furnished in Averanova.⁶²

Elsewhere, common beryl in prisms to 20 cm (8 in) long appears in granitic pegmatites near Alakurtti at the N end of the Gulf of Kandalaksha and in granitic pegmatites at Liupiko in S part of the ASSR.⁶³

Ukrainian SSR

Complex granitic pegmatites containing beryl and other gemstone minerals were known in the Volhynia region of Central Ukraine since 1924 (p. 37).¹ Large topaz crystals were described by Gavrusovich from pegmatite bodies in reddish granite and gabbro-norite, some weighing 2 kg

(4.4 lb), with some beryl crystals from the same deposits being as much as 60 kg (132 lb).^{64,65} The bodies are lenticular or vein-like, often zoned, with aplitic borders and zones of graphic granite. Principal species are feldspars with quartz, the latter often forming cores; some cavities contain smoky quartz, topaz, beryl, tourmaline, and fluorite, among other species. These pegmatites are associated with the porphyritic granites of the Korosten pluton in the NW portion of the Ukrainian crystalline shield, with the pegmatite bodies intruded into the granites ringed older gabbro-anorthosites (p. 173).⁵ The pluton is about 150 km (94 mi) wide and extends N–S, with its N end just S of Ovruch and its S end, covering a distance of about 225 km (142 mi), terminating near Vinnytsa.⁶⁶ The belt of plutonic rocks is centered on the city of Zhitomir, the latter located about 83 km (52 mi) W of Kiyev. Fersman's map (p. 32),¹ see fig. 14-64, showed gemstone localities clustered about 55 km (34 mi) NW of Zhitomir, at Zhitomir itself, at Tserkov 70 km (44 mi) S of Kiyev, and at Korsun and Gorodishche 135 km (85 mi) SSE of Kiyev.

Many of the pegmatite bodies contain crystallized cavities, some such vugs being truly enormous in size and containing correspondingly large crystals of quartz, topaz, and beryl. Beus noted some openings that ranged from 1–2 m (1.1–1.2 yd) to as much as 10–20 m (11–12 yd) (p. 173).⁵ Such were commonly filled with fine, loose mica and clay masses in which the crystals were loosely imbedded. Beryl occurred associated with lepidolite and protolithionite, in the alkali-free variety that was typically olive-green to honey-yellow in color. Beryl crystals were commonly corroded, and as described and depicted by Bartoshinsky et al.,⁶⁷ resulted in many crystals being reduced to glittering remnants covered with multitudes of complex faces and etch figures as shown in fig. 9-22. Many crystals occur in prisms about 10–15 cm (4–6 in) long and 3–4 cm (1.3–1.7 in) in diameter, often fully transparent and suitable for cut gems.

Ukraine Emerald

Lavrinenko et al. reported finding emerald for the first time in the Ukraine in 1968 but did not state where.⁶⁸ The crystals are associated with albite, quartz, phlogopite, tourmaline, and garnet in the altered zone of basic rock enclosing a gran-



Fig. 14-64 Occurrences of granitic gem-bearing pegmatites in the Ukraine, USSR. After the map of A. E. Fersman, *Dragotsennyye i Tsvetnyye Kamni*, SSSR (Leningrad, 1925).

BERYL LOCALITIES

itic pegmatite, the latter believed to be the source of the necessary beryllium mineralization while the coloring chromium was picked up from the invaded basic rock. An analysis showed the presence of 0.04% Cr_2O_3 .

Caucasus Mountains. Light brownish yellow, very transparent and brilliant crystals up to 2×1 cm (0.7–0.4 in) were found in alluvium of Sulak River above Yevgeniev Bridge in Dagestan.⁶⁹ Also in the north Caucasus, in granitic pegmatites associated with the granites of the Central Division occurring particularly along contacts with crystalline schists.⁷⁰ These are mainly muscovite-tourmaline pegmatites carrying beryl in addition to the usual essential minerals such as microcline and quartz; other associates are albite, chlorite, garnet, apatite, zircon, columbite, and calcite. Numerous beryl-bearing pegmatites also occur in Dzirul massif in the area NE of Kutaisi city, Georgian SSR, and between the headwaters of the Rioni and Kura rivers.⁷¹ These bodies may or may not be zoned, and quartz cores are commonly present as well as zones of graphic granite; associates include garnet, bertrandite, niobite, allanite, tourmaline, and molybdenite with beryl crystals up to 6 kg (13 lb).

- Fersman, A. E. 1925. Dragotsennye i Tsvetnye Kamni SSSR. *Izdavaemye Komitssiy po Izucheniu Estestvennykh Proizvoditelnykh sil SSSR, Akademiya Nauk, Leningrad, Monografiya* 3. Vol. 2: Mestorozhdeniya. 386 pp.
- Koksharov, N. 1853–1891. *Materialien zur Mineralogie Russlands*. 11 vols., atlas. St. Petersburg: Carl Kray.
- Brückmann, U. F. B. 1783. *Gesammelte und eigene Beyträge zu seiner Abhandlung von Edelsteinen*. Zwote Fortsetzung. Braunschweig: Fürstl. Waisenhaus Buchhandlung. 250 pp., beryl p. 83.
- Macquart, L. C. H. 1789. *Essai ou Recueil de Mémoires sur plusieurs Points de Minéralogie*. Paris: Chez Cuchet. 580 pp.
- Beus, A. A. 1966. *Geochemistry of Beryllium and Genetic Types of Beryllium Deposits*. Translated by F. Lachman. San Francisco: W. H. Freeman. 401 pp.
- Kuznetsov, S. 1910. Zur Mineralogie Transbaikaliens. I. Lagerstätte von Wobioffit und Lepidolith. *Izvestiya Imperatorskoi Akademii Nauk St. Petersburg* 1910: 711–18.
- Sushchinsky, P. P. 1915. [Preliminary report on a journey to southern Transbaikalia for the investigation of the deposits of colored minerals and wolframite]. *Travaux du Musée Géologique (et Minéralogique) Pierre le Grand pres l'Académie Impériale des Sciences de St.-Petersbourg* 9:17–41.
- Ikornikova, N. Y. 1939. [Crystallographic investigation of beryl crystals from Sherlova Mountain]. *Mémoires de la Société Russe de Minéralogie, Petrograd*, ser. 2, vol. 68, pp. 536–54; English summary pp. 554–55.
- Sushchinsky, P. P. 1923. [On aquamarine from Schorl Mountain in Transbaikalia Province]. *Annales de l'Institut Polytechnique du Don du Césarévitch Alexis (Novocherkassk)* vol. 8 (for 1920–22), pp. 66–7.
- Nefedov, E. I. 1941. On some newly discovered minerals in the pegmatites of Adun-Cholon (Transbaikalia). *Doklady Akademii Nauk SSSR (Leningrad)* 32:361–4.
- Sheherbakov, D. I. 1936. Geneticheskie tipi beryllievikh mestorozhdenii SSSR. *Redkie Metally* 5, no. 1, pp. 35–42.
- Pockels, F. 1892. Über die Änderung des optischen Verhaltens von Alaun und Beryll durch einseitigen Druck. *Neues Jahrbuch für Mineralogie . . . (Stuttgart)* Beilage Bd. 8, pp. 217–68.
- Lapparent, A. 1896. [Specimen of wolframite with beryl]. *Bulletin de la Société Française de Minéralogie* 19:4–5.
- Bauer, M. 1904. *Precious Stones*. Translated by L. J. Spencer. London: Charles Griffin. 627 pp.
- Jeremeyev, P. V. 1896. [Reports recent find of beryl near Manghut Station, Transbaikalia]. *Zapiski Imperatorskogo (S. Peterburgskogo) Mineralogicheskogo Obshchestva*, vol. 34, ser. 2, pp. 58–9.
- Orlov, N. 1901. Neuer Fundort des Berylls in der Nähe der mongolischen Grenze und der Stanitza Narassun. *Zeitschrift für Kristallographie und Mineralogie (Leipzig)* 34:699–70.
- Althausen, M. N. 1935. [The Kolotoska deposit of the Mama-Vitim-Ulica bearing region]. *Trudy Vsesoyuznogo Nauchno-Issledovatel'skogo Instituta Mineralnogo Syrva (Moscow)* 86:1–70.
- Smolyaninov, N. A. 1940. [Mineralogical feature of the Dshidin deposits in the Buryat-Mongolian ASSR]. *Trudy Instituta Geologicheskikh Nauk, Akademiya Nauk SSSR (Moscow)* vol. 39, Mineralogical-Geological series 8.
- Tarasov, E. P., and Plechanov, S. S. 1956. Die Pegmatite mit seltenen Erde im Gebirge Östsajan. *Materialien zur Geologie Östsiberien (Chita)* 1956:343–6.
- Martyanov, N. N. 1957. [Geologie der Pegmatite des Hochlandes Sangilen]. *Doklady Akademii Nauk, SSSR (Leningrad)* 115:987–90.
- Renovantz, H. M. 1788. *Mineralogisch-geographische und andere vermischte Nachrichten von den Altaischen Gebirgen russisch-kayserlichen Antheils*. Reval: privately printed. 272 pp.
- Jeremeyev, P. V. 1899. Ueber einige Beryllkristalle von Mursinka und von Tigaret'skije Bjelki, Altai. *Zeitschrift für Kristallographie . . .* 31:507.
- Pilipenko, P. P. 1915. [Mineralogy of the western Altai]. [Bulletin Imperial Tomsk University] no. 63 (Tomsk) 763 pp.
- Gavrusevich, B. 1932. Granitpegmatite am Oberlauf des Flusses Seoch und des Flusses Leiljak, Süd-Fergana. *Doklady Akademii Nauk, SSSR*, pp. 101–43.
- Boldryev, A. K. 1932. [Tigerek beryl deposit in the Altai]. In: [Papers of the 4th All-Union Geological Conference on Nonferrous Metals, Issue 5, "Minor and Rare Metals,"]. Moscow: Tsvetmetisdat.
- Ginsburg, A. I. 1946. [Pollucite in pegmatites of the Kalbin Range (eastern Kazakhstan)]. *Doklady Akad. Nauk SSSR* 52:335–7.

World Sources of Ore and Gem Beryl / Union of Soviet Socialist Republics

27. Solodov, N. A. 1960. Distribution of alkali metals and beryllium in the minerals of a zoned pegmatite in the Mongolian Altai. *Geochemistry* (Ann Arbor) 8:874-85.
28. Chukrov, F. V., and Smolyaninova, N. N. 1956. [Bertrandite from the granite massif Kounrad in central Kazakhstan]. *Doklady Akad. Nauk SSSR* 107:579-80.
29. Chistyakova, M. B.; Moleva, V. A.; and Razmanova, Z. P. 1966. [First find of bazzite in the USSR]. *Doklady Akad. Nauk SSSR* 169:1421-24.
30. Jonin, N. 1934. [A new tin-bearing region of the USSR in the Turkestan Range]. *Problemy Sovetskoi Geologii* (Moscow) 4:43-61.
31. Sosedko, A. F. 1932. [The pegmatites of the Altyn-Taou (Kyzyl-Kumy central)]. *Doklady Akad. Nauk SSSR* 1932:251-9.
32. Schneiderhöhn, H. 1961. *Die Erzlagerstätten der Erde*. Vol. 2: *Die Pegmatite*. Stuttgart: Gustav Fischer 721 pp.
33. Rose, G. 1837. *Mineralogisch-geognostische Reise nach dem Ural, dem Altai und dem Kaspischen Meere*. 2 vols. Berlin: Sanderschen Buchhandlung. 641, 606 pp.
34. Mezheritsky, 1886. Ueber die uralischen Gruben "farbiger Steine." *Zeits. für Krist.* . . . 11:393.
35. Kalugin, P. 1889. Die Edelsteingruben von Mursinka und Alabaschka. *Zeits. für Krist.* . . . 15:550.
36. Jeremeyev, P. 1897. [On several beryl crystals from Mursinka and Tigeretsk Byelki, Altai]. *Verhandlungen der kaiserlichen Gesellschaft für die Gesamte Mineralogie zu St. Petersburg*, ser. 2, vol. 35, pp. 58-60.
37. Romanovsky, E. 1899. Ueber die Berylle aus der Umgegend von Ober- und Unter-Alabaschka am Ural. *Zeits. für Krist.* . . . 31:509 (abstract).
38. Fersman, A. E. 1949. *Verständliche Mineralogie*. Berlin: Verlag Neues Leben. 288 pp.
39. Atkinson, T. W. 1858. *Oriental and Western Siberia*. New York: Harper & Brothers. 533 pp.
40. Grevingk, C. 1854. Die Smaragd-Gruben des Ural und ihre Umgebung. *Verhandl. der Russ.-kaiserl. min. Gesellschaft zu St. Petersburg* 1854:206-33.
41. Kunz, G. F. 1899. Precious stones. Chapter in *Mineral Resources of the United States for 1898, Part IV*. 20th Annual Report, Director of the U.S. Geological Survey, (Washington, D.C.) pp. 557-600.
42. Zemyatchensky, P. A. 1900. Izumrud i berill Ural'skikh izumrudnykh kopei. *Trudy Imperatorskogo Sankt-Petersburgskogo Obshchestva Estestvoispytatelei*, (geol. min. sect.), vol. 29, no. 5, pp. 1-21.
43. Kunz, G. F. 1924. Precious stones. Chapter in *The Mineral Industry During 1923*, vol. 32. New York: McGraw-Hill Book Co. p. 578.
44. ———. 1926. Precious stones. Chapter in *The Mineral Industry During 1925*, vol. 34. New York: McGraw-Hill Book Co. pp. 590-616.
45. Russian emeralds: U.S. concession. 1927. *The Mining Journal* 159:902.
46. Gilliams, T. F. 1928. More emeralds to come from Russian mines. *Jewelers' Circular* (New York) 97, no. 11, pp. 78-81.
47. Kunz, G. F. 1930. Precious and semi-precious stones. Chapter in *The Mineral Industry During 1929*, vol. 38. New York: McGraw-Hill, pp. 530-54.
48. Lavrov, S. E. 1931. Precious and ornamental stones of Russia. *Economic Geology* (Lancaster, Pa.) 26:432-43.
49. Herman, F., and Wussow, D. 1935. The emerald deposits of the world. *Mining Magazine* (London) 53:20-5.
50. Eppler, W. F. 1924. Berühmte Edelsteine. *Deutsche Goldschmiede-Zeitung*, (Stuttgart) 52:394-99.
51. Fersman, A. E. 1923. Izumrudnye kopi na Urale. *Sbornik statei i materialov* 46, *Materialy dlya izucheniya estestvennykh proizvoditelnykh sil Rossii*. Komissiey Pri Rossisskoi Akademii Nauk, Petrograd (St. Petersburg). 82 pp.
52. ———. 1929. Smaragdgruben im Uralgebirge. *Abhandlungen praktische geologische Bergwirtschafislehre*. Vol. 18, pp. 74-116. Halle (Saale): Wilhelm Knapp.
53. Vlasov, K. A., and Kutakova, E. I. 1960. *Izumrudnye Kopi*. Moscow: Akademiya Nauk SSSR. 252 pp.
54. Melnikov, M. P. 1886. Neue Mineralfunde am Ural. *Zeits. für Krist. u. Min.* 11:394.
55. Zavaritsky, A. N., and Krianovsky, V. 1937. Ilmen State Mineralogical Reservation. In: *International Geological Congress, XVII Session, USSR, 1937, Uralian Excursion, Southern Part*, pp. 5-17.
56. Zavaritsky, A. N. 1939. [Geological and petrographical sketch of the Ilmen Mineralogical Reservation and its mines]. In: *Izbrannye Trudy*, Vol. 2, Izdatelstvo Akademiya Nauk SSSR, Moscow, 1958 pp. 3-308.
57. Titov, A. 1928. *Opyt Mineralogii Ilmenskikh Gor: Mineraly* . . . Zlatoust: Izdanne Zlatoustovskogo Obshchestva Kraevedeniya. 68 pp.
58. Jeremeyev, P. V. 1879. Beryl von südlichen Ural. *Zeits. für Krist.* . . . 3:439 (abstract).
59. Barbeaut-de-Marny, N. 1856. Mineralogische Novellen vom Ural. *Verhandl. der russ.-kaiserl. min. Gesellschaft zu St. Petersburg*. 1855-56:197-206.
60. Sosedko, A. F., and Gordienko, V. V. 1957. [Eu-cryptite from a pegmatite vein in northern Kola Peninsula]. *Doklady Akad. Nauk SSSR* 116:135-6.
61. Borovik-Romanova, T. F., and Sosedko, A. F. 1958. [On Rb content of beryls in pegmatite veins of Kola Peninsula]. *Doklady Akad. Nauk SSSR* 118:534-6.
62. Averyanova, I. M. 1968. K mineralogii protsessov izmeneniya berilla. *Akademiya Nauk SSSR, Kolskii Filial, Materialy po Mineralogii Kolskogo Poluostrova* 2:140-42.
63. Kalita, A. P. 1965. Osobennosti mineralizatsii granitykh pegmatitov redkosmelnogo ryada vostochnoi chast Baltiskogo shchita. *Novye Dannye po Geologii, Geokhimii i Genezisu Pegmatitov*. Moscow: Izdatelstva Nauk. pp. 266-304.
64. Gavrusevich, B. A. 1932. [A contribution on the study of the mineralogy of topaz pegmatites in Ukraine]. *Doklady Akad. Nauk SSSR* 1932:173-181.
65. ———. 1933. [On the geochemical-genetic types of pegmatites of the right bank of the Ukraine]. *Trudy Lomonosovskogo Instituta, Geokhimii, Kristalografii i Mineralogii*. (Moscow and Leningrad) 2:23-69.
66. Buryanova, E. Z. 1940. [An account of the mineralogy of granite pegmatites from Korosten pluton massif in Volhynia and a study of their iron biotites]. *Mémoires de la Société Russe de Minéralogie, Petrograd* 69:519-39 (English summary pp. 539-40).
67. Bartoshinsky, Z. B.; Matkovsky, O. I.; and Srebrodolsky, B. I. 1969. [Accessory beryl from chambered

BERYL LOCALITIES

- pegmatites of the Ukraine]. *Mineralogicheskii Sbornik* (Lvov) 23:382-97.
68. Lavrinenko, L. F.; Levenshtein, M. L.; Polynovsky, R. M.; Rozanov, K. I.; and Rozenberg, D. S. 1971. [The find of emerald in the Ukraine]. *Mineralogicheskii Sbornik* 25:85-7, with English summary.
69. Mushketov, I. V. 1883. Beryll and Amphibol aus Kaukasien. *Zeits. für Krist. u. Min.* 7:208.
70. Kobysheva, M. M. 1938. [Materials for investigation of pegmatites of northern Caucasus]. *Materialien der Asow-Schwarzmeer Geologie* (Rostow-Don) 5:45-89.
71. Kuznetsova, E. 1931. [Materials for the study of pegmatite veins of the Dzur massif, Transcaucasia]. *Izvestiya Vsesoyuznogo Geologo-Razvedochnogo Obedineniya* (Moscow) 50:1469-88.

UNITED ARAB REPUBLIC (Egypt)

Egypt's emerald deposits supplied this treasured gemstone to the rest of the civilized world for centuries, but while the exact date of the discovery of the deposits remains unknown, tools found in some of the older workings were dated to the reign of Sesortis II in the 12th Dynasty or about 1925 B.C.^{1,2} Schneider believes that the earliest mining began by at least 1500 B.C. during the reign of Thotmes III and "was known to be flourishing in 1425 B.C. during the reign of Amenophis II."³ Little studied a translation of the oldest known Egyptian writing entitled "The Instruction of Ptah-Hotep" (E.P. Dutton, 1910), and noted the sentence "fair speech is more rare than the emerald that is found by slave-maidens on the pebbles," and concluded that since Ptah-Hotep lived about 3500 B.C., the emerald was known to the Egyptians by at least that date. However, he hastened to add that this would be so only if the "translated [word for] emerald is strictly the emerald as we define it."⁴

In contrast, Lucas was firmly of the opinion that these dates were pushed back too far, stating "that there is not any evidence that the mines were worked in the reign of Amenophis III as stated by Wilkinson" (p. 339)⁵ in the latter's *The Ancient Egyptians* (vol. 2, 1890, p. 237). Lucas only committed himself to the statement that the "extensive old workings" are "probably of Graeco-Roman date age." It is known that mining was continued by the Greeks during the time of Alexander the Great (356-323 B.C.) and by the Romans, as shown in the numerous extracts from their writings as cited by Ball^{1,2,6} and Schneider.³ After the Romans, further exploitation was carried on by Arabs, with the oldest Arabian descriptions of the mines and their emeralds appearing in the works of the naturalist Al-

Kindi (d. 870 A.D.), the scientist Al-Beruni (d. 1048 A.D.), who mentioned the mines in his *Al-Gamahir fi Marifat al-Gawahir*, or "Summary of Knowledge of Precious Stones" (Bonn, 1935), and the extensive and detailed account of the emeralds themselves by the 13th century Cairo jeweler Ahmed bin Jusuf Al-Tifaschi who called his work on gemstones *Azhar al-Akfar fi Gawahir al-Aghar*, or "Thoughts on Gemstones."⁷ Tifaschi gave the last mining data for emerald as 1237 A.D. in the reign of Sultan al-Kaamel.

In succeeding centuries, emerald mining was also undertaken by the Turks, but all mining ceased by about 1740, at which time the mines lapsed so completely into obscurity that their very existence came to be doubted, with some authorities even venturing opinions that the emeralds of antiquity actually had come from Siberia or Far Eastern sources no longer identifiable. Still others went so far as to suggest that the fabled mines did not produce emeralds but only an inferior greenish quartz-prase, which massive variety was commonly called "mother of emerald" or "prime d'émeraude," under the delusion that it was either the host rock of true emerald or the substance of emerald but in "unripened" form.

In 1770, James Bruce (1730-1794), a Scottish explorer and rediscoverer of the Blue Nile, sailed south from Quseir (Kosseir) on the Red Sea coast and then penetrated inland toward the west to find the emerald mines. Some ancient mine workings were discovered in an area that corresponds to their present location, but uncertainty remains as to their identity although Schneider was of the opinion that Bruce had found the long-lost emerald deposits.³ The controversy was laid to rest, however, with their relocation by the Nantes goldsmith-adventurer Frédéric Cailliaud (1787-1869) who went to Egypt in 1815 to enter the service of Viceroy Mehemet Ali (1769-1849) and undertook two trips to the site.⁸ Cailliaud's first journey in 1816 was exploratory in nature, but the second, in the following year, was a serious attempt to mine emeralds, and Cailliaud was placed in charge of a large expedition financed by the viceroy. While mining proved uneconomical, much of value was learned about the geography of the region and the nature of the deposits. A good summary of Cailliaud's work appeared in Schneider.³

Despite this initial failure, the viceroy continued to dispatch expeditions to work the mines on

World Sources of Ore and Gem Beryl / United Arab Republic (Egypt)

a small scale. Giovanni Battista Belzone (1778–1823), the celebrated Italian explorer-archaeologist, traveled to the mines sometime before 1820 and found fifty men working there under miserable conditions and with little success.⁹ Sir John Gardner Wilkinson (1797–1875), the British egyptologist, visited the mines and briefly described them sometime before 1835, when they were still in operation.¹⁰ Giovanni Battista Brocchi (1772–1826), another Italian naturalist and geologist, explored the region from 1822 to 1823, staying for a considerable time at Gebel Sikait and Gebel Zabara at the emerald mines. His findings, the first modern and competent account, are incorporated in a posthumous work.¹¹ Brocchi accurately described the fundamental geology and mineralogy and noted the schist-type nature of the deposits. Other visitors to the mines included Nestor L'Hote in 1841 and Helekyon Bey in 1844, the latter finding the mines abandoned.

Much later, E. A. Floyer explored and mapped the area while on a scientific expedition for the Khedive of Egypt.¹² In 1899, Streeter and Company, London jewelers, dispatched an expedition to work the mines, the account of which was given by D. A. MacAlister, a geologist member.¹³ The parent firm created the Egyptian Mine Exploration Company to work the mines,¹⁴ but again such work quickly proved unprofitable and the mines were abandoned. In 1911, J. Couyat of France visited the sites and reported on the mineralogy.¹⁵ A. Stella, an Italian geologist, examined the deposits in about 1934 and gave a brief account of the geology and petrology of the emerald-bearing formations and the occurrence of beryl as related to aplitic and granite-porphry bodies.¹⁶ He was the first to point out the strong resemblance of these deposits to those of the Urals, Habachtal, and Leysdorp. In 1927, a group of Parisian jewelers decided to reopen the mines despite discouraging advice given by Max Ismalun.¹⁷ Nevertheless, an expedition was dispatched under French geologist Arsandeaux during the winter months of 1927–28, but as predicted, without financial success. Ismalun reviewed the history of the mines, especially in modern times, and concluded that the deposits "were not susceptible to remunerative exploitation for gem emeralds," basing his opinion on the fact that the deposits were of the metamorphic schist-type and the emerald crystals could never attain the perfection of those found in vugs at Muzo, Colom-

bia.¹⁷ He candidly stated that Egyptian emeralds are generally "mediocre" in quality, a conclusion that is confirmed by products of recent mining and by specimens still available for examination in museum collections. An excellent historical summary of emerald mining and descriptions of the deposits and the emeralds themselves is contained in Hume.¹⁸

Location

The deposits are centered on Gebel [mountain] Sikait, approximately 24°40' N, 34°48' E, or 285 km (180 mi) slightly SE of Idfu, a city on the Nile River; or, from the Red Sea coast, located 130 km (82 mi) NNW of the port of Berenice. The area is about 700 km (440 mi) SSE of Cairo. The occurrences lie along a NW–SE axis for a distance of about 34 km (21 mi), beginning with Gebel Zabara on the NW, Gebel Sikait in the center, and ending at Wadi Um Dabaa near Wadi Um Kaba on the SE.^{19, pl. 175} The entire region is desert with rugged low mountains rising above barren rock terrains laced with wadis [dry river beds]. (See fig. 14–65.) All water and supplies must be brought in; roads are absent, and summer temperatures unbearable.

Geology and Mineralogy

Much information of value is to be found in Hume (pp. 107–25),¹⁸ but the most recent studies took place during 1956–57 when Basta and Zaki reported on their visit.²⁰ The following notes are taken largely from their paper. The rocks consist mainly of schists, serpentines and granites, together with various types of aplite, pegmatite, and beryl and fluorite veins and dike rocks. The most abundant schists are mica and talc types but also present are actinolite, chlorite, tourmaline, quartz-muscovite, and graphite schists. All are cut in places by small veins or bands of tourmaline rock. Folding has been intense and repeated, forming a series of ripples ranging from small size to some which may be several hundred meters across (see fig. 14–67). Serpentines form the summit of Gebel Sikait and overlie the schists, in places intruding the latter. Granitic rocks are younger than the schists and serpentines, and include foliated gneissose rock containing numerous subparallel pegmatitic muscovite veins, and in some places, fluorite veins. An intrusive white granite is also present and is believed to be younger than the gneissose type.

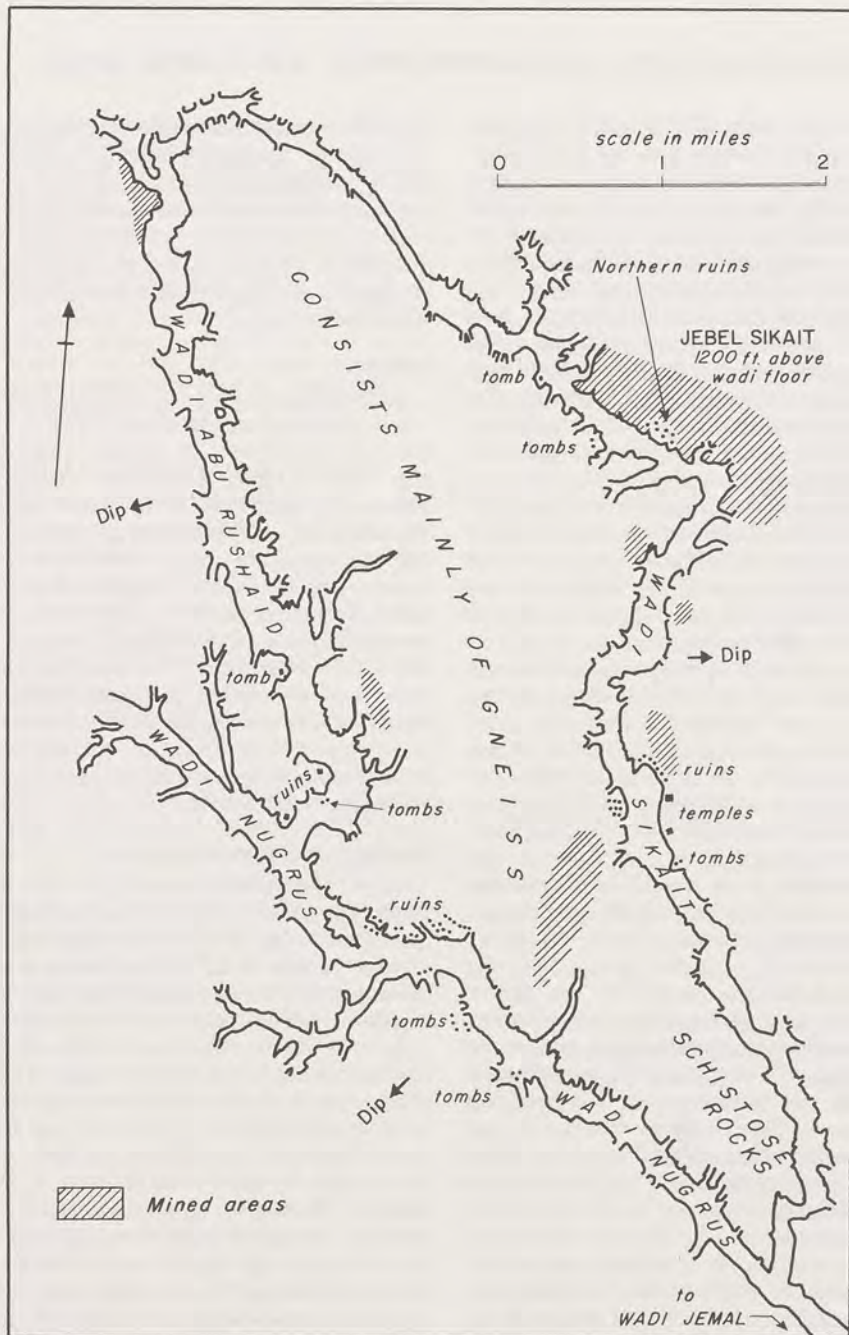

Fig. 14-65 The emerald mines district of Wadi Sikait, United Arab Republic. The wadi or "wash" floors are fairly level stretches of sand with numerous side wadis and with the mountains rising abruptly from the floors. After a sketch map of D. MacAlister, "The Emerald Mines of Northern Etbai," *Geographical Journal* 16 (1900).



Fig. 14-66 View of Wadi Sikait showing ruins of a large building in center and small buildings, probably homes of workmen, to the right on the lower slope of the mountain range. Photographed by Dr. Peter Bancroft in March, 1980.



Fig. 14-67 Entrance to an emerald mine, Wadi Sikait. The schistose character of the country rock is readily apparent. Photographed by Dr. Peter Bancroft in March, 1980.

BERYL LOCALITIES

Beryl occurs in three types of schist: (1) biotite-quartz, as at the emerald mine on the E side of Wadi Sikait where the rock is irregularly cut by small bands and veinlets of quartz, while beryl crystals occur in the quartz as well as in the enclosing schist. Associates are plagioclase, calcite, iron oxides, and in the biotite, inclusions of zircon and allanite. The beryl is pale blueish green or yellowish green, sometimes stained red by hematite in fissures, the latter imperfection being very common. Simple hexagonal prisms occur to 5 cm (2 in) long, sometimes striated parallel to *c*-axis. $G =$ about 2.75; $o = 1.580$, $e = 1.573$; estimated alkali content is 15%. Inclusions are abundant threads or elliptical cavities filled with cloudy liquid-gas matter and oriented parallel to the *c*-axis.

The type (2) schist in which beryl occurs is actinolite-biotite schist such as found in the old emerald mines at the base of Gebel Sikait. It is also like the previously described schist, but contains greenish black aggregates of actinolite while being relatively poor in quartz. Associates are actinolite, biotite, beryl, and quartz, also calcite, magnetite, and hematite. Beryl occurs as 2–30 mm (0.1–1.25 in) prisms; estimated alkalis 18%; refractive indices $o = 1.585$, $e = 1.577$.

Type (3) is a tourmaline-biotite schist as at Um Harba emerald mines E of Wadi Sikait. The rock containing the emerald crystals consists of a matrix of quartz and biotite (sometimes stained red with hematite) in which are prisms of pale green beryl 3–25 mm (0.12–1 in) long. These are commonly fractured basally, sometimes with segments slightly displaced and the fissures filled with quartz and hematite. The beryl is slightly kaolinized on the edges. The tourmaline in this rock may be dravite. Beryl index $o = 1.585$.

Elsewhere emerald is found in lenticular bands or in small veins of quartz-beryl in the emerald mines on the E side of Wadi Sikait and at Um Harba. It is usually darker green than that found in schists as noted by Cailliaud and others.³ The enclosing quartz is ordinarily milky but may also be smoky. X-ray data on emerald from the E side of Wadi Sikait appears in Basta and Zaki (p. 18).²⁰

The crystallography of the Egyptian emeralds, like those from similar schist-type deposits elsewhere, is very simple: the predominant and virtually only form being the first order prism *m*, sometimes accompanied by the basal face *c*. A twelve-sided prism, indicating the presence of the

second order prism $a\{11\bar{2}0\}$ was mentioned by Brocchi among crystals collected by him in 1823.¹¹ During growth, some crystals overdeveloped alternate prism faces such that the cross-sections became equilateral triangles. Most individuals occur singly but may be broken into many segments. The habit is short to long prismatic, but very long and even acicular crystals are known, the latter even in radiating groups (see Hume, p. 187).¹⁹

Compared to crystals from other like deposits, the average size is small, generally less than several cm (ca. 1 in) long. Ball, however, claims that the large hemispherical cabochon set in the tiara of Pope Julius II is an Egyptian emerald of fine color that is nearly 5 cm (2 in) in diameter.¹ He also reports that during Arab mining, a stone of 22 carats was found but broke while being extracted. Cailliaud states that his largest crystal was only about 2.5–4 cm (1–1.5 in) long and 1.8 cm (0.75 in) in diameter.⁸ Brocchi claimed that Turkish miners accompanying him to the mines in 1823 showed him a matrix impression of a crystal that was nearly 30 cm (12 in) long and the thickness of the index finger.¹¹ The miners said that this crystal, extracted in segments as usual, was sent to Cairo but proved to be worthless for cut gems.

Older references suggest that crystals of substantial size were found during earlier mining campaigns. For example, Masudi, or Abu-al-Hasan Ali al-Masudi (d. 956 A.D.), an Arabian historian, in his account of the mines entitled *Meadows of Gold and Mines of Gems*, declared that emeralds were found up to 5 mithkal (or miskal) in weight, or about 35 carats. Tifaschi cited Kadi Maan el-din, former supervisor of the mines for the Sultan of Egypt as the authority for a "turnip-green" emerald crystal which broke into pieces but weighed in the aggregate 88 drams or about 1400 carats.³ Tifaschi also once bought a "basil-green" specimen which weighed 12 mithkal or about 420 carats, which, after "purification" (trimming?), was sold to the Sultan of Damascus. Makrisi or Tagi-al-Din Ahmad Maqrizi (1364–1442 A.D.), a Moslem historian, wrote a topographical history of Egypt and told of two very fine emeralds in the possession of Emir Neshku when the latter was imprisoned; one weighed one rottel or about 2700 carats. Makrisi also mentioned that in the year 704 of the Hegira (1326 A.D.), an emerald was found weighing 165

World Sources of Ore and Gem Beryl / United Arab Republic (Egypt)

mithkal or about 1150 carats.³ Such large crystals seem to have completely disappeared and none of this size is known to be in existence today.

In regard to color, Egyptian emeralds range from very pale blueish green or yellowish green to the intense green hue of top quality stones, but all authorities agree that these were extremely rare. According to Couyat, the emerald of Sikait tends toward whitish green while that of Zabara and Abou Reched is blueish green.¹⁵ Hume depicted specimens of good color upon his color plate.¹⁹ In the hoard of the rough and worked emeralds described by Schneider, among those found on the beach east of Alexandria near Pharos the hues ranged from whitish or yellowish greens, through apple and grass greens, to the saturated green of the best quality.³ A number of these crystals contained white cores as well as inclusions of various kinds.

Ancient experts were keenly aware of the importance of color. Masudi, cited in ref. 3, gave four qualities of emeralds based chiefly on color but also on freedom from inclusions. The top quality was "mar," a gem of finest water and dazzling green, usually without flecks or black shadings. Ismalun, also citing Masudi, gave the term for this grade as "dubbani,"¹⁷ while Tifaschi, cited in Schneider, used "zabadi," a name "given after the zabab, which according to Rainieri, the translator of this work, is a green-bottle fly of spectacular iridescence."³ Ismalun identified the insect as "la mouche cantharide."¹⁷ In any case, it is evident that these descriptions correspond to the present ones for top quality emerald, that is, intense, pure and uniform green and a minimum of flaws. Concerning the latter, Tifaschi stated that "the most serious defect of the zababi and other kinds of emeralds is variation in color from place to place in the same stone," and among other defects are "irregularity in the shape of the stone . . . and finally the small cracks which reach the surface."³

A second quality of emerald was called "bahri," or "sea-emerald," by Masudi, the color and luster approaching the first kind, but "the green being like that of young leaves which grow near the ground or upon the tips of the twigs of the myrtle." Tifaschi likened the color to basil leaves, while Ismalun, quoting Masudi, called it a "retain" of "leaf color."

The third grade is "magrebi" according to Masudi, or "seloungi" according to Ismalun, and

"turnip green" according to Tifaschi. The fourth grade is designated "asamm" by Masudi, for which Schneider employs the synonym "matte" or dull in reference to the hue, being "the least beautiful and costly because the green is pale and has little luster; it includes many subvarieties which are distinguished according to nuances of color."³ Tifaschi defined this last as "soap color," while Ismalun gave it as "sabouni."

Mining

The exploitation of the deposits in early days must have been attended with severe hardships and considerable loss of life, if the extremely narrow, dust-laden, and primitive underground workings are taken into consideration along with the severity of the desert climate. All supplies and food had to be brought in by caravan from the Nile River—a week's journey, and water, sometimes available from catch-basins that trapped a scanty rainfall, had to be brought in from wells a half-day's march away. The miseries of work and life in the mines were vividly described by Cailliaud and subsequent visitors.⁸ To support mining in ancient periods, the Egyptians established towns of considerable size at Sikait and Zabara, complete with temples, houses for miners, and other necessary structures largely built from local stone (see figs. 1-1 and 1-2). There are eight mines or groups of mines within several hours walk from Gebel Sikait, with other mines to be found at Zabara, Nugrus, and Um Debaa. According to Floyer, "the Emerald Mines cover some forty square miles of valley and mountain, and much resemble a large rabbit-warren. From countless holes in every dark hillside pour streams of silvery, powdered mica."¹²

It is apparent from all accounts that the ancients simply burrowed into likely biotite schist outcrops to eventually create an astounding network of underground passages, many just barely large enough to admit the human frame (see fig. 14-67). But sometimes these were expanded into chambers of great size where emerald-rich ore concentrations were found. One such chamber is large enough to accommodate 300 miners at once.^{8,13} Some tunnels are said to reach 240 m (800 ft) in length. The narrowness of the openings followed the long established pattern of only excavating rock that yielded crystals or removing only so much of the country rock as could gain

BERYL LOCALITIES

access to profitable ground. Personal comfort was a last consideration.

Emerald crystals were recovered by simply breaking up the schist until crystals were exposed, then removing as much of the micas as possible, and promptly immersing the crystals in warm oil. These were wrapped in wood shavings and enclosed in cloth, such parcels then being sent off to Cairo for further disposition.³

1. Ball, S. H. 1928. Egyptian gem stones of the pre-Ptolomaic days. *Jewelers' Circular* (New York) Feb. 23, pp. 147-57, *passim*.
2. ———. 1950. *A Roman Book on Precious Stones*. Los Angeles: Gemological Institute of America. 338 pp.
3. Schneider, O. 1892. Der aegyptische Smaragd. *Zeitschrift für Ethnologie*, (Berlin) 24:41-100; mineralogy/petrography by Arzruni, pp. 91-100.
4. Little, H. P. 1917. An ancient reference to emerald. *Science* (New York) n.s., vol.45, no. 1160, pp. 291-2.
5. Lucas, A. 1934. *Ancient Egyptian Materials and Industries*. 2nd ed. London: Edward Arnold & Co. 447 pp.
6. Ball, S. H. 1931. Historical notes on gem mining. *Economic Geology* (Lancaster, Pa.) 26: 681-738.
7. Haschmi, M. Y. 1956. Der aegyptische Smaragd. *Der Aufschluss* (Heidelberg) 7:100-2.
8. Cailliaud, F. 1821. *Voyage à l'Oasis de Thèbes . . . Pendant les Années 1815-1816, 1817-1818*. Paris: Imprimerie Royale. pp. 60-63, 81.
9. Belzoni, G. B. 1820. *Narrative of the Operations and Recent Discoveries within the Pyramids, Temples, Tombs, and Excavations in Egypt and Nubia*. London. Cited in (3).
10. Wilkinson, J. G. 1835. *Topography of Thebes and General View of Egypt*. London. Cited in (5).
11. Brocchi, G. B. 1841. *Giornale delle Osservazioni fatte ne' Viaggi in Egitto*. Cited in (3).
12. Floyer, E. A. 1892. Notes on the geology of the Northern Etbai. *Quarterly Journal of the Geological Society of London* 48:576-82.
13. MacAlister, D. 1900. The emerald mines of northern Etbai. *Geographical Journal* (London) 16:537-49.
14. Prospecting in Egypt. 1902. *The Mining Journal* (London) Dec. 13. p. 1691.
15. Couyat, J. 1911-12. Quelques minéraux d'Égypte et du Sinaï. *Bulletin de la Société Française de Minéralogie* 35:560-5.
16. Stella, A. 1935. Contributo alla conoscenza dei giacimenti di berillo dell'Alto Egitto. *Bollettino della Società Geologica Italiana* (Rome) v. 35.
17. Ismalun, M. 1943. Émeraudes et béryls. *Bulletin de la Société Royale Géographique de Égypte* (Cairo) 21:51-60.
18. Hume, W. F. 1934. *Geology of Egypt*. Vol. 2, part 1: *The Metamorphic Rocks*. Cairo: Government Press. 300, 124 pp.
19. ———. 1937. *Geology of Egypt*. Vol. 2, part 3: *The Minerals of Economic Value*. Cairo: Government Press. pp. 689-990.
20. Basta, E. Z., and Zaki, M. 1961. Geology and min-

eralization of Wadi Sikait area, South-Eastern Desert. *Journal of Geology of the United Arab Republic* (Cairo) 5:1-38.

UNITED KINGDOM

Scotland

Inverness Shire. Beryl occurs in a complex granitic pegmatite at Chiapaval, S Harris, Isle of Lewis, Outer Hebrides, located 2.4 km (1.5 mi) NW of Northton, opened at the N end for feldspar. Associates: quartz, feldspars, micas; also magnetite, columbite, gahnite, spessartine, uraninite, thorite, kasolite, zircon, monazite, allanite, tourmaline, and pyrite;¹ white beryl, opaque, associated with muscovite, feldspar, graphic granite, rose quartz.² Minor beryl occurs in several pegmatite bodies N of Loch Nevis, Knoydart, where they are intruded into garnetiferous schists of Moine series. The crystals are simple prisms to 10 × 3 cm (4 × 1.3 in), greenish white; average R.I. (7 specimens) $\rho = 1.582-1.584$, $G = 2.68-2.71$.³ One prospect provided some ore beryl.⁴ Pale yellow green prisms to 8 cm (3 in) occur in pegmatite in gneiss at Struy Bridge quarry, about 27 km (17 mi) WSW of Inverness; associates are garnet, tourmaline, muscovite and feldspar; some beryl crystals of "shell" type with alternating layers of quartz/beryl.²

Ross Shire. Found in two pegmatite bodies near Garve, 32 km (20 mi) NW of Inverness.³

Banff Shire. Weathered pegmatites on the E slopes of Cairngorm in the extreme SW formerly yielded clear smoky quartz crystals ("cairngorms"); also topaz and beryl, the latter in corroded transparent crystals and masses of blue green, apple green, and rarely "peridot-green" color.² Some crystals are color-zoned. Beryl is also reported in pink, white, and pale green or colorless. At Loch Avon, just below Cairngorm summit, 19 km (12 mi) NW of Braemar, minute, complexly-faced crystals occur as inclusions in smoky quartz.²

Aberdeen Shire. Here beryl occurs in gneiss in railway cut between Old Deer, 40 km (25 mi) N, and Ellon, 25 km (16 mi) N of Aberdeen; at Black Dog Rock, near Belhelvie, about 13 km (8 mi) N of Aberdeen, and at Keig Bridge. In Rubislaw quarry beryl occurs as large opaque, yellow prisms to 30 cm (12 in) long in the so-called "davidsonite" variety once thought worthy of a distinctive name (see Glossary), with apatite,

World Sources of Ore and Gem Beryl / United States of America

tourmaline, garnet, feldspar and muscovite. At Pitfoddels quarry, beryl is pale emerald green, transparent. It occurs with topaz in alluvials of Dee River near Braemar and at Invercauld, 3.2 km (2 mi) NE of Braemar. In the Pass of Ballater it occurs as small yellow crystals with muscovite, zinnwaldite, microcline. On Mt. Battock, at the junction of Kincardine and Angus shires it occurs as divergent pale green prisms in granite.^{2,5}

Kincardine Shire. Beryl may be found in Tory granite quarry on the S bank of Dee River opposite Aberdeen as rough yellow crystals with tourmaline, pinitite, and margarodite.²

Perth Shire. Beryl is found at Kinloch Rannoch.⁵

Bute Shire. At Glen Shant near Brodrick, beryl occurs as blue crystals to 2.5 cm (1 in) in fine-grained granite on the Island of Arran.^{2,6}

England

Isle of Man. Located N of Wales in the Irish Sea. The Fixdale granite is cut by pegmatite bodies containing beryl in the NW and in the center of Granite Mt.; pale blueish green, subhedral to anhedral crystals, commonly in aggregates, or singles to 8 cm (3 in) long.⁷

Lundy Island, Cornwall. About 38 km (24 mi) W of Ilfracombe in the Bristol Channel. Narrow pegmatite veins in muscovite-biotite granite at SE end contain vugs lined with crystals, including pale blue to colorless beryls, the largest 0.7 × 0.3 cm (0.3 × 0.1 in), terminated, with basal face, prism, and pyramids, associated with topaz, quartz, micas, schorl, fluorite, apatite, and clays.⁸

Cornwall. Greenish white prisms to 6 × 4 mm (0.25 × 0.1 in) occur in pegmatite on Kit Hill, in New Consols mine, and at Stoke Climsland.⁹ Translucent white beryl occurs in fissures enclosing tourmaline and surrounded by cassiterite within Beam mine, St. Austell. In South Crofty mine, Illogan, 19 km (12 mi) NW of Falmouth, beryl is found in cassiterite-bearing vein-stone with quartz, chlorite, tourmaline, orthoclase, fluorite, apatite, and bertrandite;¹⁰ crystals acicular to 0.5 mm diameter, also in masses of same. Mabe Parish, 4.8 km (3 mi) W of Falmouth, provides small white but sharp crystals in fine-grained granite; similarly at the quarry in Constantine Parish, 8 km (5 mi) SW of Falmouth.⁵ Beryl is found in Wheal Castle mine, St. Just, very near Land's End^{5,6} and at St. Michael's

Mount, a granite stock in Mounts Bay, about 15.2 km (10 mi) ENE of Land's End, in numerous vugs in quartz veins and in pegmatitic phases of the granite; these provide small blueish beryl crystals with topaz, quartz, and feldspar, also apatite, cassiterite, fluorite, lepidolite, mica, stannite, and wolframite.^{5,6}

Devonshire. Beryl occurs at Lustleigh, 22 km (14 mi) NNW of Torquay.^{6,11}

1. Knorring, O. v., and Dearnley, R. 1960. The Lewisian pegmatites of South Harris, Outer Hebrides. *Mineralogical Magazine* (London) 32:366-78.
2. Heddle, M. F. 1901. *The Mineralogy of Scotland*. 2 vols. Edinburgh: David Douglas. 148 pp., 51 pls.; 247 pp.; beryl, vol. 2, pp. 43-5.
3. Gallagher, M. J. 1966. Beryl from Knoydart, Inverness-shire. *Bulletin of the Geological Survey of Great Britain*, no. 25 (London) pp. 95-6.
4. Ramsay, S. 1960. A beryl crystal from Scotland. *Rocks & Minerals Magazine* (Peekskill, N.Y.) 35:252-3.
5. Greg, R. P., and Lettsom, W. G. 1858. *Manual of the Mineralogy of Great Britain and Ireland*. London: John Van Voorst. 483 pp.; beryl pp. 125-7.
6. Hall, T. M. 1868. *The Mineralogist's Directory . . . to the Principal Mineral Localities in the United Kingdom of Great Britain and Ireland*. London: Edward Stanford. 168 pp.
7. Dawson, J. 1966. Beryllium in the Foxdale granite, Isle of Man. *Bull. of the Geol. Survey of Great Britain*, no. 25, pp. 55-8.
8. McLintock, W. F. P., and Hall, T. C. F. 1912. On topaz and beryl from the granite of Lundy Island. *Mineral. Mag.* 16:294-301.
9. Embrey, P. G. 1953. The occurrence of beryl and loellingite at the New Consols Mine, Stoke Climsland, Cornwall. *Mineral. Mag.* 30:259-62.
10. Phenister, J. 1940. Note on the occurrence of bertrandite and beryl at the South Crofty mine, Cornwall. *Mineral. Mag.* 25:573-8.
11. Collins, J. H. 1871. *A Handbook to the Mineralogy of Cornwall and Devon*. Truro: Heard & Sons; London: Longmans, Green, Reader, and Dyer. 108 pp.; beryl p. 15.

UNITED STATES OF AMERICA

It is not known when the first beryl was found, but the place of discovery probably was in New England. As early as 1803, the Ruggles mine, Grafton, New Hampshire, was opened for mica.¹ By 1825, Samuel Robinson had published his *Catalogue of American Minerals with Their Localities*,² in which he included 21 beryl localities in New England, 10 in the Middle Atlantic states, and one in Maryland. In following years, beryl was also discovered in other pegmatite deposits of Maryland, Virginia, and additional southeastern states. Localities in the Rocky Mountains and

BERYL LOCALITIES



Fig. 14-68 Aquamarine from several United States deposits. The two transparent crystal sections, pale blue in color, fit together to form a crystal about 10×2.5 cm (4×1 in); from near Centerville, Idaho. Upper right: faceted heart from Roebbling mine, Connecticut, blue-green, about 22 mm ($\frac{7}{8}$ in) long, weight 40.44 carats. Center gem: pale yellow-green, from Yancey County, North Carolina, about 2.5 cm (1 in) long. Lower left: mixed cut fine blue gem from Maine, 3 cm ($1\frac{1}{4}$ in) long, weight 66 carats. *Courtesy Smithsonian Institution, Washington, D.C.*

California were found much later, indeed many of them only in this century.

Up until World War II, beryl was saved at pegmatite mines only if it afforded attractive mineral or gem specimens; by far the largest quantity was sent over the dumps as economically useless. However, as the need for beryllium metal increased, intensive examinations of potential pegmatite deposits of beryl took place throughout the

states from about 1940 through the 1950s, resulting in the publication of a very large quantity of literature by the United States Geological Survey as well as various state surveys and other agencies. A useful summary of pegmatite districts is provided by Landes for all of the country,³ while the most important papers on regional groups of pegmatites are those of Cameron et al.,¹ Jahns et al.,⁴ and Page et al.⁵ Reserves of beryl

World Sources of Ore and Gem Beryl / United States of America

in New England are recorded in Barton and Goldsmith,⁶ while occurrences of gem beryls are described by Sinkankas,⁷ whose work includes an extensive bibliography on North American gemstones in its second volume.

Maine

Almost all beryl-bearing granitic pegmatites are located within Oxford, Androscoggin, Sagadahoc, and Cumberland counties in the extreme SE corner, and more specifically, in a belt of about 32 km (20 mi) wide that extends SSE from near Rumford to terminate near Brunswick, or over a distance of about 120 km (75 mi).^{1,7,8} Concentrations are heaviest around Rumford, Bethel, and Norway in Oxford County, around Auburn in Androscoggin Co., and around Brunswick, Cumberland Co.; from the latter place a narrow belt with numerous bodies extends N into Sagadahoc Co. The bodies are intruded mainly into schists and gneisses, but also into granites, with quartz-mica schist being the most abundant country rock. Most beryl occurs as small to large simple prisms of the common variety and only rarely as transparent, gemmy crystals in vugs or as clear areas in large crystals suitable for gem material.

Oxford County. Common beryl is found on Spruce Mt. and Saddleback Mt., 11 km (7 mi) W of Andover and in 7 quarries around and on Whitecap Mt. and Black Mt., 9.5 km (6 mi) W and WNW of Rumford.² The Black Mt. quarries on the W slope produced an estimated 33 tons of white and colorless beryl easily mistaken for quartz.^{9,10} Plumbago Mt., 14 km (9 mi) almost directly W of Rumford is noted for large prisms of common beryl,² but recently also for spectacular colored tourmaline crystals from vugs in Dunton mine near the summit.^{7, vol. 2, p. 82; 10} Earlier the Dunton pegmatite produced some pinkish gray tabular beryl crystals, about 2.5 cm (1 in) thick and 8–10 cm (3–4 in) in diameter.¹¹ Detailed descriptions of this and nearby bodies appear in Shainin and Dellwig, who noted ore beryl in "significant quantities" only in the main pegmatite, a very large flat-lying body covering much of the summit of the Newry Hill spur of Plumbago Mt.; crystals are subhedral to euhedral, forms *m* and *c*, also *a*; white to pale green, mostly opaque, sizes to 1.3 m (4 ft) long and 60 cm (24 in) diameter.¹² Some subparallel intergrowths of beryl-milky quartz-muscovite were noted. A gemmy beryl is reported by Bastin,^{13, p. 78} while

Fraser reported tabular crystals from the Dunton pegmatite of pale green to greenish white color to 13 cm (5 in) diameter with high R.I., suggesting an alkali beryl; also some green, well-formed crystals that were found in pockets and at times were transparent and largely free of flaws.¹⁴

Beryl is found in Lobikis mine, 8 km (5 mi) SSE of Rumford and some of gem quality in Hedgehog Hill pegmatite, 11 km (7 mi) SSE of Rumford.^{1,8} It occurs in pegmatite quarries on Peaked Hill, 2.8 km (1.75 mi) W of West Bethel¹ and on NE flank of Pickett Henry Mt., 1.6 km (1 mi) SW of West Bethel; also in several prospects 10 km (6.5 mi) SSE of West Bethel; on mountains in an area centered about 13 km (8 mi) SSW of West Bethel⁸ where beryl is abundant in small crystals in a pegmatite body on E side of Durgin Mt.¹⁵ Beryl occurs on Sugar Hill, 4.7 km (3 mi) NW of North Lovell and on Chapman Hill nearby. On Speckled Mt., in the same area, fine beryl and aquamarine have been reported.¹⁵

Giant crystals of ore beryl were once found in the Bumpus quarry, located 7.3 km (4.6 mi) due N of Lynchville¹ and described by several visitors at time of discovery.^{16, 17} The longest crystal 5.7 m (18 ft) and 1.2 m (4 ft) diameter, estimated at 18 tons. Such large prisms were found closely grouped and appeared to radiate from a common center on the pegmatite wall. G. F. Kunz secured one of about 2.1 m (7 ft) long and 1.2 m (4 ft) diameter, weighing close to 4 tons, for the American Museum of Natural History in New York, where pieces are still exhibited.¹⁸ These record sizes were eclipsed in 1949 with a crystal that was conical in shape and measured 8.4 m (27 ft) long, 28 cm (11 in) wide at the narrow end and 1.9 m (6.5 ft) at the wide end; weight was 23,869 kg (52,600 lb).¹⁹ According to Neumann, the Bumpus pegmatite yielded 255 tons of ore beryl until about 1952, the largest crystal above furnishing 26 tons alone.²⁰

Due E of Bumpus quarry, 6.3 km (4 mi), is the Emmons quarry on the E face of Uncle Tom Mt. It is noted for large crystals of alkali beryl,¹⁰ one of pink color being 50 × 38 cm (20 × 15 in) and containing a clear area at the termination from which about 5,000 carats of gem stock was obtained, fit for cutting gems to 2–3 ct.

A cluster of beryl-bearing pegmatites are located about 8.8 km (5.3 mi) NNE of Stow in Stoneham Township and are noted for some fine

BERYL LOCALITIES

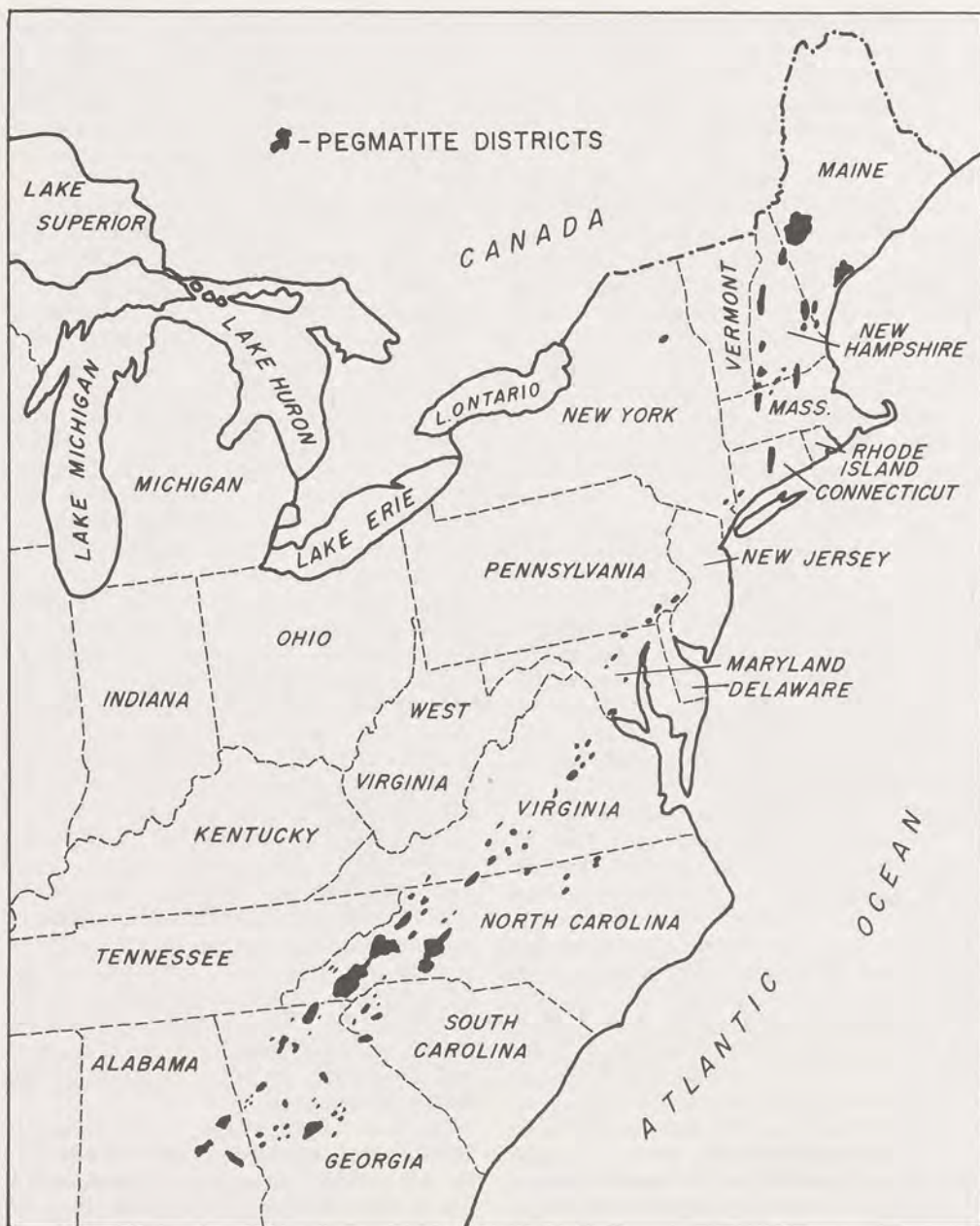

Fig. 14-69 Sketch map showing locations of granitic pegmatite districts in the Eastern United States. Modified, with additions, after E. N. Cameron et al. Internal Structure of Granitic Pegmatites, *Economic Geology Monograph* 2 (Urbana, 1949).

World Sources of Ore and Gem Beryl / United States of America

gem-quality aquamarine crystals. A splendid crystal which furnished a cushion-brilliant faceted gem of 133.75 carats, sketched in Fig. 4-25 and now in the Field Museum of Natural History, Chicago, was found near here loose in the soil;^{7, vol. 1, p. 69, 21} it is described and pictured by Kunz.²² Beryls of the Lord Hill pegmatite in this area are described by Woodard,²³ who notes a milky yellow variety enclosing triplite, a pale green type veined with muscovite and cleavelandite, and a clear blue gemmy variety. The Melrose quarry on Sugar Hill (Sugarloaf Mt.) produced some gemmy blue aquamarine and golden beryl but is perhaps best known for facet grade beryllonite crystals.¹⁰

Numerous pegmatite quarries are clustered on and around Noyes Mt., 3.2 km (2 mi) S of Greenwood or 6.3 km (4 mi) SW of West Paris; considerable beryl is found from time to time, including alkali varieties, but such quarries as the Harvard, Waisenen, and Tamminen are best known for gemmy tourmaline crystals and rare phosphate species.¹

In the Paris-Buckfield area many quarries were opened on the mountains included in the area between Paris-North Buckfield-Buckfield-Hebron-Paris and are centered on Paris itself. NE of Paris 2.2 km (1.4 mi) is the famous tourmaline locality of Mt. Mica whose history and productions have been immortalized in Hamlin's works,^{24, 25} with numerous later accounts of mining activity and geology by Bastin,¹³ Sinkankas,⁷ Stevens,¹⁰ and others. Alkali beryls, pink, white, and colorless, also aquamarine, have been found here, including a 16.6 kg (30 lb) prism "believed to be the largest single mass of gem quality aquamarine ever found in Maine" which is now in the Maine State Museum.²⁶ In 1949 a pocket yielded remarkable complexly-faced alkali beryl crystals from about 1.3 cm (0.5 in) to 20 cm (8 in) long, all milky white in interiors but with colorless outer zones. The largest measured 20 × 8 × 5 cm (8 × 3 × 2 in) and weighed 1.7 kg (3 lb). The crystal habits were far different from the usual, 30 forms being recognized, although the most common were *c*, *m*, {1121}, and {2131}.²⁷ Due to inclusions, the cores only gave $G=2.650$ with outer clear zones giving 2.780. R.I. (milky): $\rho=1.573-1.580$, $e=1.568-1.574$; (clear) $\rho=1.598$, $e=1.591$.

On Ryerson Hill, 4.8 km (3 mi) NNE of Paris, good gem aquamarine was reported.²⁸ The Bennett quarry, 6.8 km (4.3 mi) NE of Paris, is fa-

Table 14-49
ANALYSES OF MT. MICA BERYLS²⁷

	Clear Percent	Milky Percent		Clear Percent	Milky Percent
SiO ₂	64.54	64.80	K ₂ O } Rb ₂ O } Cs ₂ O }	0.21	0.16
Al ₂ O ₃	18.51	18.38			
BeO	13.20	14.68			
Li ₂ O	0.86	0.68	H ₂ O	1.24	0.78
Na ₂ O	1.12	0.76	Totals	99.68	100.24

mous for a large variety of pegmatite minerals including common beryl in prisms to 20 × 8 cm (8 × 3 in), blueish to greenish, sometimes tapered; also colorless, sometimes pink, and pale green alkali beryls, one crystal of which measured 10 cm (4 in) long and 15 cm (6 in) wide.²⁹ Non-pocket beryl $G=2.73$, $\rho=1.681 \pm 0.003$, $e=1.575 \pm 0.003$; vug beryl $G=2.82-2.85$, $\rho=1.598 \pm 0.003$, $e=1.590 \pm 0.003$. Cloud reported crystals to "nail-keg" size.³⁰ Fine cesium beryls occur in Fletcher mine, 8 km (5 mi) ENE of Paris,¹⁵ in Irish mine just to the E, and elsewhere in this vicinity. Other pegmatite mines with beryl are on Owls Head Mt., Streaked Mt., and Singepole Mt.¹ Others occur just to the NE and SE of Hebron.

Androscoggin County. Beryl has been reported in Pitts-Tenney quarry, 2 km (1.2 mi) NNW of Minot and in Kennedy quarry, same distance bearing NE. The best known occurrences are the pits atop Mt. Apatite, located 2 km (1.2 mi) almost directly E of Minot. These produced beautiful purple apatite crystals and some fine green tourmaline. Sterrett reported a large pink beryl crystal, 56 cm (22 in) long and 30.5 cm (12 in) diameter from Maine Feldspar Company's quarry in 1914, from clear portions of which small faceted gems were cut.¹⁵ Another well-known deposit is the Berry or Poland quarry, located 2.3 km (1.5 mi) SE of Minot;¹ it produced exceptional green tourmalines, also a variety of rare minerals, and occasionally blueish white beryl crystals; an alkali beryl from here, much corroded, $\rho=1.585$, is described by Berman and Gonyer.³¹

Sagadahoc County. Numerous large granitic pegmatite bodies extend from Topsham, just N of the Brunswick, to just S of Richmond Corner,

BERYL LOCALITIES

a distance of about 19 km (12 mi) along an NNE axis, many of them exploited by quarries originally opened for ceramic feldspar. Beryl was found in Coombs and Ordway quarries, just NE of Bowdoinham, in the Consolidated, Rumrill, Willes, Alice Staples, and Fisher quarries, all grouped closely together about 6 km (4 mi) NNE of Brunswick; also in a quarry almost within the limits of the populated portion of Topsham and in an area about 6 km (4 mi) SW of Brunswick.^{1,8} Other locations are near Phippsburg and Bay Point, about 14 km (9 mi) to 22 km (14 mi) SE of Brunswick.¹ Good aquamarine and golden beryl, usually as clear areas in large crystals, were occasionally found in the quarries just NNE of Topsham. In 1894, the Trenton Flint and Spar Company of Topsham uncovered several vugs which yielded green, yellow, and white beryl crystals, some doubly-terminated, with the largest about 13 × 2.5 cm (5 × 1 in), all more or less transparent and cuttable.³² Other fine crystals were found in 1896, including one of 30.5 cm (12 in) long and 5 cm (2 in) wide.³³ A hexagonal, striated prism of pale greenish beryl from Topsham is illustrated in color by Kunz;³⁴ it measured 10.5 × 2 cm (4 × 0.75 in). The Fisher quarry, 4.8 km (3 mi) NNE of Brunswick, uncovered a pocket in 1933 that contained a considerable quantity of pale blue corroded topaz crystals and herderite, and also several kilograms of colorless, pale blue and pink beryls, mostly in the form of severely corroded fragments of crystals.^{35,36}

1. Cameron, E. N. et al. 1954. Pegmatite investigations 1942-45 New England. *U.S. Geological Survey Professional Paper* 255. 352 pp.
2. Robinson, S. 1825. *A Catalogue of American Minerals with their Localities*. Boston: Cummings, Hilliard, & Co. 316 pp.
3. Landes, K. K. 1935. Age and distribution of pegmatites. *American Mineralogist* 20:81-105, 153-175.
4. Jahns, R. H. et al. 1952-3. Mica deposits of the Southeastern Piedmont. *U.S. Geol. Survey Prof. Paper* 248 A-G.
5. Page, L. R. et al. 1953. Pegmatite investigations 1942-1945 Black Hills, South Dakota. *U.S. Geol. Survey Prof. Paper* 247. 228 pp.
6. Barton, W. R., and Goldsmith, C. E. 1968. New England beryllium investigations. *U.S. Bureau of Mines Report of Investigations* 7070. 177 pp.
7. Sinkankas, J. 1976. *Gemstones of North America*. 2 vols. New York: Van Nostrand Reinhold Co. 675, 494 pp.
8. Maine Geological Survey. 1957. *Maine pegmatite mines and prospects and associated minerals*. Mineral Resources Index No. 1 (Augusta, Me.) 43 pp.
9. Maillot, E. E.; Boos, M. F.; and Mosier, M. 1949. Investigation of Black Mountain beryl deposit, Oxford County, Maine. *U.S. Bureau of Mines Rept. of Invest.* 4412. 10 pp.
10. Stevens, J. P. 1972. *Maine's Treasure Chest, Gems and Minerals of Oxford County*. West Paris: privately published. 216 pp.
11. Hess, F. L.; Whitney, R. J.; Trefethan, J.; and Slavin, M. 1943. The rare alkalis in New England. *U.S. Bureau of Mines Information Circular* 7232. 51 pp.
12. Shainin, V. E.; and Dellwig, L. F. 1955. Pegmatites and associated rocks in the Newry Hill area, Oxford County, Maine. *Maine Geological Survey Bulletin* 6. 58 pp.
13. Bastin, E. S. 1911. Geology of the pegmatites and associated rocks of Maine. *U.S. Geol. Survey Bulletin* 445. 152 pp.
14. Fraser, H. J. 1930. Paragenesis of the Newry pegmatite. *American Mineralogist* 15:349-64.
15. Sterrett, D. B. 1914. Gems and precious stones. Chapter in *U.S. Geological Survey Mineral Resources of the United States for 1913*, pp. 649-708.
16. Gedney, E. K., and Berman, H. 1929. Huge beryl crystals at Albany, Maine. *Rocks & Minerals Magazine* (Peekskill, N.Y.) 4:78-80.
17. Spence, H. S. 1929. [Beryl crystals 18 ft. long]. *Engineering and Mining Journal* (New York) 128:858.
18. Kunz, G. F. 1930. Precious and semi-precious stones. Chapter 3 in *The Mineral Industry During 1929*, Vol. 38. New York: McGraw-Hill Book Co. pp. 530-54.
19. Blakemore, J. 1976. *We Walk on Jewels: Treasure Hunting in Maine for Gems and Minerals*. Rockland: Courier of Maine Books. 175 pp.
20. Neumann, G. L. 1952. Bumpus pegmatite deposit, Oxford County, Maine. *U.S. Bureau of Mines Rept. of Invest.* 4862. 15 pp.
21. Kunz, G. F. 1883. A note on the finding of two fine American beryls. *Proceedings, American Association for the Advancement of Science* 32:275-6.
22. ———. 1886. Rare gems and interesting minerals. *Transactions of the New York Academy of Sciences* 5:131-3.
23. Woodard, H. H. 1951. The geology and paragenesis of the Lord Hill pegmatite, Stoneham, Maine. *American Mineralogist* 36:869-83.
24. Hamlin, A. C. 1873. *The Tourmaline*. Boston: J.R. Osgood & Co. 107 pp.
25. ———. 1895. *The History of Mount Mica of Maine, U.S.A.* Bangor; privately published. 72 pp., 43 color pls.
26. [Large aquamarine crystal found at Mt. Mica]. 1971. *Lapidary Journal* 25:368-9.
27. Hurlbut, C. S., and Wenden, H. E. 1951. Beryl at Mount Mica, Maine. *American Mineralogist* 36:751-9.
28. Jorgensen, N. 1950. Some mines of Oxford County, Maine. *Rocks & Minerals* 25:158-9.
29. Landes, K. K. 1925. The paragenesis of the granite pegmatites of Central Maine. *American Mineralogist* 10:355-411.
30. Cloud, P. E. 1934. Mineral collecting in the vicinity of Paris, Maine. *Rocks & Minerals* 9:183-5.
31. Berman, H., and Gonyer, F. A. 1930. Pegmatite minerals of Poland, Maine. *American Mineralogist* 15:375-87.
32. Kunz, G. F. 1895. Precious stones. Chapter in *U.S. Geol. Survey Min. Resources of the U.S. for 1894*. Pt

World Sources of Ore and Gem Beryl / United States of America

4. 16th Annual Report of the Director of the U.S. Geological Survey, pp. 595-605.
33. ———. 1897. Precious stones. Chapter in *U.S. Geol. Survey Min. Resources of the U.S. for 1896*. Pt 5. 18th Ann. Rept. of the Director of the U.S. Geo. Survey, pp. 1183-1217.
34. ———. 1899. Precious stones. Chapter in *U.S. Geol. Survey Min. Resources of the U.S. for 1898*. Pt 4. 20th Ann. Rept. of the Director of the U.S. Geo. Survey, pp. 557-600.
35. Palache, C. 1934. A topaz deposit in Topsham, Maine. *American Journal of Science* 27:37-48.
36. Burbank, B. B. 1934. Topaz and herderite at Topsham, Maine. *Rocks & Minerals* 9:125-30.

New Hampshire

Granitic pegmatites are abundant and widespread; many were formerly worked for feldspar and mica, some for ore beryl. A locality index may be found in Myers and Stewart with map,¹ also in Morrill with many maplets.² Page and Larrabee³ and Cameron et al.⁴ provide much detail on individual deposits. Occurrences of gem beryl are given in Sinkankas.⁵

Coos County. Rarely beryl occurs in miarolitic vugs and in associated pegmatites at Greens Ledges, extreme W of Milan Township;⁶ green and golden prisms to 10 cm (4 in) appear on N. Baldface Mt., ca. 6 km (3.8 mi) W of N. Chatham.²

Grafton County. Localities by township are as follows. **Wentworth Twp.:** King mine, 4.8 km (3 mi) W of Wentworth, crystals to 1 m (3 ft);⁷ Conner mine, 1.2 km (0.75 mi) N of Wentworth; New Gove, Whicher, McGinnis mines about 3.2-4.8 km (2-3 mi) SSW of Wentworth. **Rumney Twp.:** Eight Ball mine, 5.6 km (3.5 mi) SE of Wentworth.⁴ Leggett mine, 6.4 km (4 mi) WNW of Rumney. Wheat and Keniston mines on mountain slopes just W of Rumney. Burgess mine, 4.8 km (3 mi) WSW of Rumney. Ashley mine, 3.2 km (2 mi) N of Groton. **Groton Twp.:** many mines on mountains NNW of and W of Groton, also on Fletcher Mt. to the E. Gem beryl in Charles Davis mine, 1.2 km (0.75 mi) W of N. Groton.⁴ Valencia mine, NW flank of Fletcher Mt., 3.2 km (2 mi) ENE of Groton famous for aquamarine in the pegmatite quartz core; crystals to 15 cm (6 in) long but with only small clear areas, cutting gems to 4 carats or less.⁸ Palermo pegmatite on Bald Hill, 1.6 km (1 mi) SW of N. Groton, famous for complex mineralization but also furnished large beryl crystals (some with small, clear, faceting areas) to 60 cm (2 ft) di-

ameter and 1.6 m (6 ft) long,³ but gemmy material was found usually in much smaller crystals of aquamarine and golden beryl.^{9,10} Orange and golden crystals were observed near uranium minerals and grayish to brownish near phosphates.³ Details on Palermo and nearby Rice deposits in Cameron et al.⁴ **Orange Twp.:** large prisms in Keyes mine, 4.8 km (3 mi) NNE of Orange,¹¹ also in Standard mine, 1.2 km (0.75 mi) NE of Orange; in the African mine just E of Orange and in Williams mine 2.4 km (1.5 mi) S of Orange.⁴ **Hebron Twp.:** on Hobart Hill 1.6 km (1 mi) WSW of Hebron. **Alexandria Twp.:** many pits 3.2 km (2 mi) W of Alexandria extending N to Marston mine 5.6 km (3.5 mi) NW of Alexandria. **Grafton Twp.:** Ruggles mine, on Isinglass Hill, 5 km (3.1 mi) NW of Grafton is world-famous for complex mineralization but also produced common beryl and a little gem beryl.¹¹ In Demott and Haile-Buckley mines, 5 km (3.1 mi) W of Grafton, also Sargent mine on Pleasant Hill, 1.6 km (1 mi) SE of Grafton.⁴ The Alger (Beryl Hill) mine, 2.1 km (1.3 mi) W of Grafton Center, is famous for large beryl crystals which have been known since the 1850s;^{4,12} about 1856 a crystal of 120 × 46 cm (48 × 18 in) was sent off to the U.S. National Museum, Washington, D.C., while another, weighing about 455 kg (1,000 lb) was placed in Boston Society of Natural History collection. Kunz described it as having dimensions of 130 × 80 × 56 cm (51 × 32 × 22 in);¹³ a still larger prism was exposed in the quarry by Alger and was estimated at 5 tons.

Merrimack County. Danbury Twp.: Danbury, Tenney, Pickwick, and Wild Meadow mines in the extreme N of twp. and county; small facet grade areas in aquamarine prisms from pegmatite occur on Stewart Hill, 4.8 km (3 mi) SE of Grafton; also gem beryl in pegmatite on Porter K. Filbert farm, 2 km (1.25 mi) WSW of S. Danbury.¹⁴

Sullivan County. Springfield Twp.: in the NE corner of the county common beryl occurs in Aaron Ledge, Colby, Melvin Hill, Murphy, and Globe mines, ca 6.3-8 km (4-5 mi) SW of Grafton Center.⁴ The Reynolds, Columbia, and Playter mines on Pillsbury Ridge, 4.8 km (3 mi) SSW of Grafton Center, are noted for substantial production of gem aquamarine.¹⁴ Morrill notes that 340 kg (750 lb) of gem stock was mined from the Playter pegmatite in the 1870s as clear areas in crystals up to 30 cm (12 in) long that were mostly

BERYL LOCALITIES

removed from the quartz core. **Sunapee Twp.:** Ledge Pond mine. **Acworth Twp.:** a notable beryl locality is at Beryl Mountain, 1.2 km (0.75 mi) SW of S. Acworth in extreme S of the county. It was known since the early 1800s when it was already famous for large beryl crystals.⁴ According to Mr. Eugene Crossett owner of the prospect, an attempt was made in 1884 to quarry a large beryl crystal here for use as a tombstone over the grave of [Ralph Waldo] Emerson at Concord, Mass. . . . but difficulty was experienced in removing the crystal without fracturing and the attempt was abandoned.^{14,p.662} During his visit, Sterrett noted an exposure in the quarry in which 35 large beryl prisms were counted, ranging in size from 40 cm (16 in) to 1 m (3 ft) in diameter. An apple green crystal of the last size was noted in 1918 by Holden.¹⁶ Another description of this deposit was given by Levin, who described blue green and golden brown crystals assaying 14% and 13.8% BeO respectively.¹⁷ Sampter described the mine while in operation during 1949, at which time the object of search was ore beryl;¹⁸ the crystals were largely deep blue to golden, but there were very few gemmy areas within them; some crystals were altered to bertrandite in parts and others were replaced by quartz. A recent description of the deposit is in Page et al.³

Cheshire County. Alstead Twp.: many beryl-bearing pegmatite bodies are known, such as Colony mine on Cobb Hill, 4.8 km (3 mi) NW of E. Alstead, Allen mine, 3.2 km (2 mi) NW of same, George Porter mine, 4 km (2.5 mi) W of same, and Lakin, Lyman and Fitzgibbons mines 2.4–3.2 km (1.5–2 mi) N of E. Alstead, S of E. Alstead are the Britton mine (3.2 km or 2 mi), the Golding-Keene mine, 3.2 km (2 mi) S of E. Alstead (noted for gemmy areas in beryl crystals).^{19,20} A cluster of mines 5 km (3.2 mi) in the same area includes the Island mine, a past producer of gem aquamarine and golden beryl;¹⁴ the Big mine and Blister mine are described by Levin and Mosier.^{21,22} **Walpole Twp.:** Howe Ledge mine, 4.7 km (2.9 mi) NW of Surry. **Surry Twp.:** Surry Dam mine on lower W flank Surry Mt., 1 km (0.6 mi) NE of the village. **Gilsum Twp.:** Nichols mine, 2 km (1.25 mi) NNW of Gilsum, also Kirk No. 2 mine, 1.3 km (0.8 mi) NW, J. White mine, 1.6 km (1 mi) S, and Kirk No. 1 mine, 2.8 km (1.75 mi) S of Gilsum. **Sullivan Twp.:** Cory and Nims mines. Sterrett describes a gem aquamarine occurrence in the Roxbury dis-

trict of the city of Keene, as on Bassett Hill, 8 km (5 mi) ENE of the city, also Horse Hill, 7 km (4.5 mi) E, and in the Keene Granite quarry, 4.8 km (3 mi) ESE of Keene.^{23,p.316}

Carroll County. Chatham Twp.: Chandler or North Star mine, 1.8 km (1.15 mi) N of N. Chatham village produced blue green to light green crystals to 38 × 15 cm (15 × 6 in).³ On S. Baldface Mt., 4.4 km (2.8 mi) WSW of N. Chatham.¹ **Wakefield Twp.:** Weeks mine, 1.6 km (1 mi) W of Province Lake, noted also for occurrence of chrysoberyl.²⁴

Strafford County. Strafford Twp.: pale green to white prisms to 60 × 30 cm (2 × 1 ft) in Parker Mt. mine, 3.8 km (2.4 mi) NE of Center Strafford village.^{3,4,25}

Rockingham County. Nottingham Twp.: Corson mine, 6.1 km (3.9 mi) NE of Raymond and Vacher mine, 4 km (2.5 mi) NW. **Raymond Twp.:** McGall mine, 1.2 km (0.75 mi) S of Raymond, and a little farther S, the McMullen prospect. A group of pegmatite mines including the Chandler, Smith, Welch, Gillingham and Lane are centered ca. 5.1 km (3.3 mi) SW of Raymond.³

1. Myers, T. R., and Stewart, G. W. 1956. *The Geology of New Hampshire*. Pt. 3: Minerals and Mines. Concord: New Hampshire State Planning and Development Commission. 108 pp.
2. Morrill, P. 1958? *New Hampshire Mines and Mineral Locations*. Naples, Me.: Dillingham Natural History Museum. 64 pp.
3. Page, L. R., and Larrabee, D. M. 1962. Beryl resources of New Hampshire. *U.S. Geological Survey Professional Paper 353*. 49 pp.
4. Cameron, E. N. et al. 1954. Pegmatite investigations 1942–45 New England. *U.S. Geol. Survey Prof. Paper 255*. 352 pp.
5. Sinkankas, J. 1976. *Gemstones of North America*. 2 vols. New York: Van Nostrand Reinhold Co. Vol. 1: 675 pp.
6. Verrow, H. J. 1945. Amethyst-smoky quartz-topaz in northern New Hampshire. *Rocks & Minerals* 20:255–60.
7. Barton, W. R., and Goldsmith, C. E. 1968. New England beryllium investigations. *U.S. Bureau of Mines Report of Investigations 7070*. 177 pp.
8. Kunz, G. F. 1886. Precious stones. Chapter in *U.S. Geological Survey Mineral Resources of the United States for 1885*. pp. 437–44.
9. Verrow, H. J. 1941. Pegmatite minerals of the Palermo quarry, North Groton, N.H. *Rocks & Minerals* 16:208–11.
10. Lisle, T. O. 1947. Beryl hunting in New Hampshire. *Rocks & Minerals* 22:1018–22.
11. Bannerman, H. M. 1943. *New Hampshire Mineral Resource Survey*. Pt 4: Structural and Economic Features of Some New Hampshire Pegmatites. Concord:

World Sources of Ore and Gem Beryl / United States of America

- New Hampshire State Planning and Development Commission. 22 pp.
12. Flint, G. M. 1919. Famous mineral localities: Beryl Hill, Grafton, New Hampshire. *American Mineralogist* 4:21-2.
 13. Kunz, G. F. 1931. Precious and semi-precious stones. Chapter in *The Mineral Industry During 1930*. Vol. 39. New York: McGraw-Hill Book Co. pp. 506-28.
 14. Sterrett, D. B. 1914. Gems and precious stones. Chapter in *U.S. Geol. Survey Min. Res. of the U.S. for 1913*, pp. 649-708.
 15. Morrill, P. 1955. The New Hampshire gem mines. *Rocks & Minerals* 30:247-51.
 16. Holden, E. F. 1918. Famous mineral localities: Beryl Mountain, Acworth, N.H. *American Mineralogist* 3:199-200.
 17. Levin, S. B. 1948. Beryl Mountain, Sullivan County, New Hampshire. *U.S. Bureau of Mines Report of Invest.* 4216. 3 pp.
 18. Sampter, E. L. 1949. My mineralogical activities for the 1949 season. *Rocks & Minerals* 24:594-6.
 19. Modell, D. 1931. The pegmatites near Gilsun, N.H. *Rocks & Minerals* 6:18-22.
 20. Bartsch, R. C. B. 1940. Collecting at Alstead, N.H. *Rocks & Minerals* 15:124.
 21. Levin, S. B., and Mosier, M. 1949. Investigation of Big Mica mine, Cheshire County, N.H. *U.S. Bureau of Mines Rept. of Invest.* 4410. 16 pp.
 22. ———. 1949. Investigation of Blister Mica mine, Cheshire County, N.H. *U.S. Bureau of Mines Rept. of Invest.* 4409. 12 pp.
 23. Sterrett, D. B. 1915. Gems and precious stones. Chapter in *U.S. Geol. Survey Min. Res. of the U.S. for 1914*. pp. 307-46.
 24. Chayes, F. 1944. Occurrence of chrysoberyl at Wakefield, Carroll County, New Hampshire. *American Mineralogist* 29:320-3.
 25. Switzer, G. 1938. The paragenesis of the Center Stratford, New Hampshire, pegmatite. *American Mineralogist* 23:811-20.

Vermont

Beryl has been reported in granitic pegmatites exposed in road cuts on the E side Willoughby Lake, Orleans Co.

1. Grant, R. W. 1968. Mineral collecting in Vermont. *Vermont Geological Survey Special Publication*, no. 2 (Montpelier) 49 pp.

Massachusetts

Worcester County. The famous beryl locality at Royalston was known as early as 1841 to Hitchcock who described the occurrence and the crystals, some more than 31 cm (1 ft) long but never more than 5-6 cm (2-2.5 in) in diameter, and noted that "the small crystals are frequently limpid; usually abounding in fissures; but sometimes so free of them, as to admit of being cut

and polished" (p. 703).¹ Apparently this locality was neglected until the early 1900s when Sterrett reported the finding of good gem quality blue and yellow crystals, one blue prism being worth \$200.² The pegmatite quarry is located 4 km (2.5 mi) N 68° E of Royalston, and was worked by F. H. C. Reynolds of Boston. In 1910, the quarry yielded a perfectly clear aquamarine about 7.5 cm (3 in) long and 5.5 cm (2.25 in) wide and 2 cm (0.7 in) thick; a fine cut gem of 12 carats was sold for \$100.³ In addition to the usual pale green and pale blue crystals, a few of dark orange color were found. The pegmatite body is enclosed in mica gneiss cut by biotite granite and consists of buff to pink feldspar, albite, quartz, muscovite and biotite, also black tourmaline, dark red garnet, and beryl crystals, the last from very small prisms to those about 5 cm (2 in) diameter. One fine crystal of good blue green hue and containing some gem material measured 28 cm (11 in) long and 4 cm (1.5 in) in diameter.⁴ Many fine gems were cut, including one of 13.75 carats and another fine blue stone of 12.5 carats. In 1915, the mine produced more gem beryl and several fine gems were cut, one of fine blue color, 16 × 13 mm, 15.7 carats.⁵

Another well known locality is Rollstone Hill, in the W outskirts of Fitchburg, where pegmatite veins are exposed in McCauliff quarry, one of which yielded common beryl, but only translucent, deep golden to pale green, and up to 2 cm (0.75 in) diameter; forms *m* and *c*; R.I. *o* = 1.578, *e* = 1.585.⁶ At an earlier time (1916), some pale yellowish green and rarely, golden beryl crystals were found, from a larger crystal of which a gem of 2.5 carats was cut.⁷ Also near Fitchburg, at the N end of Pine Hill in Cogshall Park, greenish white crystals to 7.5 cm (3 in) across were reported.⁸ Beryl localities vaguely reported by Hitchcock include Pearl Hill "two or three miles north of the village" of Fitchburg.² Hitchcock also describes a beryl locality at Barre, "situated in the extreme west part of the town, near the road to Dana . . . [in a] huge vein of coarse granite in gneiss."² The beryl crystals were not abundant, but Hitchcock remarked on the fine crystals of rutile in the body.

Franklin County. Northfield: "abundant crystals up to 10 inches [25.4 cm]" occur 1.6 km (1 mi) NE of the village in pegmatite; also on Northfield Mt. and Brush Mt., at the latter in 33 cm (13 in) diameter prisms.⁹

BERYL LOCALITIES

Hampshire County. The mineralogically famous locality at Goshen gave its name to the colorless variety of beryl known as *goshenite*, although it seems clear from early descriptions that pink beryls and other pale-colored beryls were meant as well as those that lacked color (p. 703).¹ The classic source apparently is the Lily Pond mine, a pegmatite body at the N end of a small body of water about 1.5 km (0.95 mi) N 80° W of the village of Goshen,¹⁰ or about 1 km (0.63 mi) N of the village of Lithia and 22 km (14 mi) NW of Northampton. A good description of the occurrence is in Hess et al. (p. 38),⁸ while specimens are described in Emerson (p. 35).⁹ Beryl was found in white, pink, yellowish, blueish green and greenish blue prisms from several cm across to some as much as 38 cm (15 in) in diameter, but all rose and colorless crystals were generally small. Elsewhere beryl occurs in granitic pegmatites near Worthington, Chesterfield, Huntington, and Pelham. The Walnut Hill pegmatite, NW corner of Huntington Twp., about 2.2 km (1.4 mi) SE of the town of S. Worthington, was described by Shaub,¹¹ who noted euhedral crystals of spodumene, also schorl, garnet, apatite, columbite, lithiophyllite, triphylite, zircon, heterosite, autunite, and beryl, one crystal of the last measured 20 × 7.5 cm (8 × 3 in). Hess et al. described a beryl-bearing body in W. Chesterfield on top of Isinglass Hill.⁸ Other localities are listed in Emerson.⁹

Hampden County. In the vicinity of Blandford beryl is found;⁹ a large crystal of common beryl of 1.5 m (5 ft) long and 60 cm (2 ft) in diameter was obtained here for Lehigh University in 1907.¹²

1. Hitchcock, E. 1841. *Final Report on the Geology of Massachusetts*. Amherst: J.S. & C. Adams. 831 pp.
2. Sterrett, D. B. 1907. Precious stones. Chapter in *U.S. Geological Survey Mineral Resources of the U.S. for 1906*, pp. 1213-52.
3. ———. 1912. Precious stones. Chapter: *U.S. Geol. Survey Min. Res. of the U.S. for 1911*, pp. 1047-78.
4. ———. 1914. Precious stones. Chapter: *U.S. Geol. Survey Min. Res. of the U.S. for 1913*, pp. 649-708.
5. Schaller, W. T. 1915. Gems and precious stones. Chapter in *U.S. Geol. Survey Min. Res. of the U.S. for 1915*, pp. 843-58.
6. Hitchen, C. S. 1935. The pegmatites of Fitchburg, Massachusetts. *American Mineralogist* 20:1-24.
7. Schaller, W. T. 1916. Gems and precious stones. Chapter in *U.S. Geol. Survey Min. Res. of the U.S. for 1916*, pp. 887-99.
8. Hess, F. L. et al. 1943. The rare alkalis in New England. *U.S. Bureau of Mines Information Circular* 7232. 51 pp.

9. Emerson, B. K. 1895. A mineralogical lexicon of Franklin, Hampshire, and Hampden counties, Massachusetts. *U.S. Geological Survey Bulletin* 126. 180 pp.
10. Sterrett, D. B. 1915. Gems and precious stones. Chapter in *U.S. Geol. Survey Min. Res. of the U.S. for 1914*, pp. 307-46.
11. Shaub, B. M. 1954. The Walnut Hill spodumene ledge near South Worthington, Massachusetts. *Rocks & Minerals* 29:339-43.
12. Kunz, G. F. 1911. Precious stones. Chapter in *The Mineral Industry During 1910*. Vol. 19. New York: McGraw-Hill Book Co.; reprint of 27 pp.

Rhode Island

Providence County. Cumberland Twp.: Beacon Pole (Tower) Hill, Copper Mine Hill, Cumberland Hill Village (Cook Tavern Farm), Diamond Hill, Sneece Pond. **Foster Twp.:** Hopkins Mill area. **Gloucester Twp.:** Chepachet, Spring Grove, and Victory Highway. **Johnston Township:** road cuts along highways 195 and 295. Reported in **Lincoln, North Providence, and Pawtucket townships. Smithfield Twp.:** Georgiaville, Wolf Hill, Spragueville; Greenville.

Kent County. Coventry Twp.: Rice City.

Washington County. North Kensington Twp.: Plum Beach. **South Kingston Twp.:** Moonstone Beach; Mooresfield. **Westerly Twp.:** Sullivan's quarry and Westerly Granite quarry in Bradford; Smith's quarries; White Rock quarry. In the foregoing quarries beryl is found in pegmatite veins traversing granite. **New Shoreham Twp.:** Block Island, along S shore.

1. Barton, W. R. and Goldsmith, C. E. 1968. New England beryllium investigations. *U.S. Bureau of Mines Report of Investigations* 7070, p. 115.
2. Morrill, P., and Winslow, W. S. 1969. *Rhode Island Mines and Minerals*. n.p.; privately published. 40 pp.
3. Miller, C. E. 1972. *Minerals of Rhode Island*. Kingston: University of Rhode Island. 83 pp.

Connecticut

Beryl in this state was noticed from the colonial period onward, with specific localities given by Hitchcock and Shepard, both especially remarking on the pegmatite deposits of the Middletown area.^{1,2} Other localities were given by Robinson.³ Topographical mineralogies include Schairer's 1931 work,⁴ its revision by Sohon,⁵ Januzzi's account of the minerals in the W portion of the state,⁶ its enlarged version of 1961,⁷ Schooner's account of 1961,⁸ a small handbook by Ryerson,⁹ and in 1971, another by Hiller,¹⁰ all of which include pegmatite deposits of beryl. The famous deposits on Collins Hill, Portland were described



Fig. 14-70 View in the Slocum quarry, near East Hampton, Connecticut, a source of fine etched golden beryl crystals. The pegmatite body (light rock) dips to the left and is enclosed in schist (dark rock).

in 1935 by Jenks,¹¹ while Cameron and Shainin surveyed beryl pegmatites in the state that could be economically important.¹² Much details on pegmatites is also included in Cameron et al.¹³ and is augmented by the studies of Middletown pegmatites by Stugard¹⁴ and Barton and Goldsmith's work from 1968.¹⁵ Gem beryl occurrence is described in Sinkankas.¹⁶

Windham County. Dana's *6th System of Mineralogy* depicts a beryl crystal from Willimantic but without giving locality information.

Hartford County. Schooner mentions pale aquamarine and dark colored morganite of gem quality from pegmatites in E. Glastonbury Twp. and also vaguely mentions beryl in Madison.⁸ Common beryl occurs in the Brack prospect in the extreme SE corner of Glastonbury Twp.¹⁵ Important beryl-bearing pegmatite bodies outcrop on rocky hills that form a narrow ridge running south starting immediately S of South Glastonbury past the border of Hartford-Middlesex counties and ending at Collins Hill, just E of Portland city, a

distance of 8.5 km (5.3 mi). Stugard locates beryl pegmatites about 0.8 km (0.5 mi) S of South Glastonbury, then describes the several Howe quarries, and the Hollister quarry,¹⁴ the last located about 2.8 km (1.8 mi) SSE of South Glastonbury.¹³ Beryl also occurs in Simpson quarry and Blumenthal prospect, Glastonbury.^{10,15} Most of the beryl is the common variety, usually in large, simple prisms, in which small clear spots are sometimes found which afford gems of several carats.

Middlesex County. Beryl is found in pegmatites in Meshomasic State Forest in NE portion.¹³ Schooner noted particularly fine green and blueish green crystals with facetable areas.⁸ Common beryl occurs in Hall quarry on Clark Hill and in Worth quarry at base of Hog Hill.^{7,8,10} The Slocum quarry in East Hampton Twp. is noted for its splendid, completely etched golden beryl crystals, commonly of facet grade and weighing up to 320 carats.^{7,9,13,16} Small golden beryl crystals are found nearby in Becker quarry.^{7,8}

BERYL LOCALITIES

Much more important are beryl-bearing granitic pegmatites which occur in narrow belts of N-S trending Bolton schist and Monson gneiss.¹⁴ Near Portland, a division in the belts occurs, with one belt beginning at Straits Hill just SE of the city and continuing S across the Connecticut River while the other belt turns E, then S, to more or less parallel the course of the river but along its E side. Numerous bodies occur in both, of which there are several hundred at least. At the extreme N are Pratt, Andrews, and Hale quarries followed southward by the Bordonaro and Gotta-Walden quarries, and the nearby Case quarries located just E of Bordonaro or about 1.2 km (0.75 mi) NW of Portland Reservoir. These deposits are pinpointed on the geological map of Stugard;¹⁴ directions for access are available in Januzzi,⁷ Ryerson,⁹ and Hiller.¹⁰ Foye discusses some of the better known deposits in this area,¹⁷ while Cameron and Shainin¹² provide detailed descriptions of certain pegmatite bodies and the workings in them as do Barton and Goldsmith.¹⁵

In another paper, Cameron et al. gives details on Bordonaro, Case, Gotta-Walden, Hale-Walker, and other important deposits in this area.¹³ The Hale-Walker prospect, located 1.8 km (1.1 mi) N 26° E of Jobs Pond, Portland Twp., produced blue crystals with some gem quality areas.^{7,8} The Strickland-Cramer pegmatite quarries and mines atop Collins Hill, directly E of Portland city, are among the best known mineral-collecting localities in the Eastern United States, and at times provide many rare pegmatite species as well as colored tourmalines and fine crystals of beryl from its dumps.^{13,18} Both aquamarine and pink beryls are found, sometimes beautifully formed and occasionally clear enough to facet gems. Another interesting deposit is the Walden Gem mine, located about 2.1 km (1.3 mi) N of the intersection of routes 17 and 17-A, from which come gem pollucite and beryl.^{15,19} Alkali beryl crystals from the core are tabular, up to 20 × 10 cm (8 × 4 in) and are either colorless or pink.

Farther S on the E bank of the Connecticut River is the Gillette quarry in Haddam Neck, 8.6 km (5.4 mi) S 25° E of Cobalt, East Hampton Twp., and described in detail, with a map, by Cameron et al.¹³ Because of the variety of splendid crystals that occur in vugs, including smoky quartz, gem tourmaline, apatite and beryl, it received much attention from collectors. It is probably this deposit that moved Shepard to remark

as early as 1837 that "Haddam had also afforded a number of exquisitely beautiful beryls of perfect transparency, and well fitted for ornamental purposes" (p. 64).² In 1906, Ford described a small but very fine prismatic pink crystal and noted that larger and cruder crystals were found here measuring 45 × 30 cm (18 × 12 in).²⁰ Stobbe stated that this quarry was first opened in 1899 for feldspar and the last systematic work accomplished in 1942-44, since which time it has lain idle.²¹ The vugs in the body are remarkable for the cleanness of the crystals found within, being free of the tenacious clay coatings which so commonly deface pocket crystals elsewhere. A large number of species, many of them rare, have been identified, and include beryls that are blue green but opaque, and translucent to transparent colorless and pink crystals (see fig. 9-13), some with green cores and rose exteriors. One rose crystal measured 6.3 × 5 cm (3.5 × 2 in). In 1949, the New York mineral dealer Hugh Ford offered one of 10 × 7.6 × 5 cm (4 × 2 × 2 in) size, pink on the outside and greenish inside, and with numerous faces.

Elsewhere in this county, beryl has been found in the Haddam area generally,⁸ in the Arnold quarry,⁹ at Chatham N of Middle Haddam,³ in the Mt. Tom prospect in East Haddam,¹⁵ in various pits on Long or Turkey Hill about 2.4 km (1.5 mi) SSE of Haddam,¹⁵ in Sawmill quarry about 3.2 km (2 mi) S of Haddam,¹⁵ in White Rock quarry¹³ and several nearby prospects about 2.4 km (1.5 mi) SE of Portland,^{7,8,14} and in Tollgate quarry in Middletown.¹³

Despite the abundance of pegmatite bodies, not much ore beryl has been mined. Boos et al. investigated the Gotta-Walden, Bordonaro, and Myron Case deposits and recorded production up to 1942 of 700 lb for the Gotta-Walden and 3200 lb for the Case.²² Stugard estimated reserves as 2,430 tons and the "probable reserves" as perhaps five times as much.¹⁴

New Haven County. Beryl occurs in Burritt Curtis quarry at Southford, ca. 2 km (1.25 mi) SW of town center.^{7,9,13,15}

Litchfield County. Common beryl was found in a stone quarry opened for construction material for Morris Reservoir Dam, just SE of East Morris,^{10,23} and in a railroad cut below Thomaston Reservoir 1.6 km (1 mi) N of the town.^{7,9,10} The best known locality in this county is the Roebing quarry near Upper Merryall, New Milford Twp., located 8.8 km (5.5 mi) N 13° W of New Milford

World Sources of Ore and Gem Beryl / United States of America

village. It was most recently described in Cameron et al.¹³ and Barton & Goldsmith.¹⁵ Two quarries expose five pegmatite bodies of narrow, vein-like form in parallel position, worked since 1885 for mica, feldspar and beryl, and in the last part of its career for gem beryl.¹⁶ In 1886, cut gems of aquamarine and golden beryl realized \$5,000,²⁴ while in 1898, the mine reported production of 200 lb of aquamarine valued at \$400 and about 20 lb of golden beryl valued at \$200.²⁵ Sterrett²⁶ visited the mine in 1914 and reported that the best gem beryl came from the SW half of the open-cut where crystals to 30 cm (12 in) in diameter were found. The majority of the crystals are opaque to barely translucent, but some smaller crystals contain numerous clear areas from which the gem stock has been recovered. Colors noted are pale to dark golden yellow, some almost "topaz brown," pale to medium blue, blueish green, and some yellowish green, also white and colorless. By 1914, about \$17,000 worth of cut gems had been sold from material mined in the previous four years. After 1900, operations lapsed but were resumed briefly sometime after 1936, then resumed again in 1944 for a few months. Since then only sporadic mining has taken place, much of it in the form of collecting by visitors. Most faceted gems are small, generally less than five carats, although the U.S. Natural History Museum in Washington, D.C. owns a fine, blue-green, heart-shaped faceted gem of 40.44 carats (see fig. 14-68), while a bright yellow gem of 14.9 carats is in the American Museum of Natural History, New York. Elsewhere in this county beryl has been reported from near Woodbury.^{7,9}

Fairfield County. The Danbury Beryl prospect is located in Brookfield.¹⁵ Other beryl producers are: near Newtown in Captain Cook quarry;^{8,10} Biermann quarry near Bethel;^{8,9,10} near Monroe,⁸ reported vaguely near Huntington;³ and at Ridgefield.^{7,9,10} A famous locality is the Branchville mica mine, 153 m (550 ft) N 48° E of Branchville railroad station, first discovered in about 1875 by the Reverend William Dickinson, after whom one of its rare phosphate minerals was named.^{13,27} The quarry was first worked by A. N. Fallow of Branchville (whose name was given to another phosphate species), and a year or so after his work, a team from Yale University, headed by G. B. Brush and E. S. Dana, worked the deposit for the sake of rare minerals. Since then it has been mined intermittently for minerals and visited by hordes of collectors.^{7,9} Beryl is an unimportant

species here, forming greenish crystals of the common variety up to 60 cm (24 in) long. The famous topaz locality at the old tungsten mine of Trumbull also produced some common beryl.^{7,9}

1. Hitchcock, E. 1823. *A Sketch of the Geology, Mineralogy and Topography of the Connecticut*. New Haven: S. Converse. 154 pp.
2. Shepard, C. U. 1837. *A Report on the Geological Survey of Connecticut*. New Haven: B. L. Hamlen. 188 pp.
3. Robinson, S. 1825. *A Catalogue of American Minerals with Their Localities*. Boston: Cummings, Hilliard, & Co. 316 pp.
4. Schairer, J. F. 1931. The minerals of Connecticut. *Connecticut State Geological and Natural History Survey Bulletin* 51 (Hartford) 121 pp.
5. Sohon, J. A. 1951. Connecticut minerals: their properties and occurrence. *Conn. State Geol. Nat. Hist. Survey Bull.* 77. 133 pp.
6. Januzzi, R. E. 1959. *The Minerals of Western Connecticut and Southeastern New York State*. Danbury: The Mineralogical Press. 106 pp.
7. ———. 1961. *The Mineralogy of Connecticut and Southeastern New York State*. Danbury: The Mineralogical Press. 257 pp.
8. Schooner, R. 1961. *The Mineralogy of Connecticut*. Branford: Fluorescent House. 89 pp.
9. Ryerson, K. H. 1968. *Rock Hound's Guide to Connecticut*. Stonington: The Pequot Press. 60 pp.
10. Hiller, J. 1971. *Connecticut Mines and Minerals*. Shelton: privately published. 61 pp.
11. Jenks, W. F. 1935. Pegmatites at Collins Hill, Portland, Connecticut. *American Journal of Science* (New York) ser. 5, 30:177-97.
12. Cameron, E. N., and Shainin, V. E. 1947. The beryl resources of Connecticut. *Economic Geology* (Lancaster, Pa.) 42:353-67.
13. Cameron, E. N. et al. 1954. Pegmatite investigations 1942-45 New England. *U.S. Geological Survey Professional Paper* 255 352 pp.
14. Stugard, F. 1958. Pegmatites of the Middletown area, Connecticut. *U.S. Geological Survey Bulletin* 1042-Q. pp. 613-83.
15. Barton, W. R., and Goldsmith, C. E. 1968. New England beryllium investigations. *U.S. Bureau of Mines Report of Investigations* 7070. 177 pp.
16. Sinkankas, J. 1976. *Gemstones of North America*. 2 vols. New York: Van Nostrand Reinhold Co. 675, 494 pp.
17. Foye, W. G. 1922. Mineral localities in the vicinity of Middletown, Connecticut. *American Mineralogist* 7:4-12.
18. Shannon, E. V. 1920. Strickland's quarry, Portland, Connecticut. *American Mineralogist* 5:51-4.
19. Seaman, D. M. 1963. The Walden gem mine. *Rocks and Minerals Magazine* (Peekskill, N.Y.) 38:355-62.
20. Ford, W. E. 1906. Some interesting beryl crystals and their associations. *American Journal Science* 22:217-23.
21. Stobbe, H. 1949. The Gillette quarry, Haddam Neck, Connecticut. *Rocks & Minerals* 24:496-502.
22. Boos, M. F.; Maillot, E. E.; and Moser, M. 1949. Investigation of Portland beryl-mica district, Middlesex County, Conn. *U.S. Bureau of Mines Rept. of Invest.* 4425. 26 pp.

BERYL LOCALITIES

23. Zodac, P. 1941. A reservoir quarry in Connecticut *Rocks and Minerals*, 16:54-5.
24. Kunz, G. F. 1887. Precious stones. Chapter in *U.S. Geological Survey Mineral Resources of the United States for 1886*, pp. 595-605.
25. ———. 1899. Precious stones. Chapter in *20th Annual Report, Director of the U.S. Geological Survey for 1898*, Pt. 6, pp. 557-600.
26. Sterrett, D. B. 1915. Gems and precious stones. Chapter in *U.S. Geol. Sur. Min. Res. of the U.S. for 1914*, pp. 307-46.
27. Shainin, V. E. 1946. The Branchville, Connecticut pegmatite, *American Mineralogist* 31:329-45.

New York

Jefferson County. Vague locality in gneiss at Omar, Alexandria Twp.¹

Saratoga County. Robinson states that small crystals of "emerald" occurred with chrysoberyl near Greenfield.² **Edinburg Twp.:** Common beryl prisms 68 × 25.4 cm (27 × 10 in), the largest yet found in the state, were uncovered in the Batchellerville pegmatite quarry; some small clear crystals have also been recorded.^{3,4,5} This quarry is about 3.2 km (2 mi) N of the town and described in detail, with maps, by Tan.⁴

Westchester County. Beck mentions "emerald" near Sing-Sing or Ossining.⁶ Manchester also mentions "emerald,"⁷ but like Beck is really referring to ordinary beryl rather than to the precious variety. At Whitson, some beryl was found during excavation of Shaft 5, Croton Aqueduct.^{1,7} Common beryl occurs in granitic pegmatite quarries lying about 1.6 km (1 mi) SE of Bedford Village; these were opened on a low ridge across the Mianus River,⁸ but of eight openings, namely Baylis, Bullock, Bueresch, Hobby, Kelt, Kinkel, McDonald, and Speranza, only the Baylis remained in operation until recently, the others were filled in or surrounded by housing.^{4,5} The quarries were opened in 1878 for feldspar and quartz and attracted attention from mineral collectors because of the considerable variety of rare and desirable species found.^{5,p.317,p.38} Beryl occurred in greenish yellow prisms to 1 m (3 ft) long; some yellow crystals were found, some tapered, and at the Baylis, some greenish yellow crystal fragments coated with very small bertrandite crystals and aggregates of epistilbite.⁹

New York County. Early in the past century beryl was noted on Manhattan Island where it occurred in granitic pegmatite veins in the native schists and gneisses.² In 1897 Ries described a crystal of remarkable complexity found at 49th street and First avenue; it was not more than sev-

eral mm long but unusually bright and perfect; forms *m* and *c*, also $n\{3141\}$, $v\{21\bar{3}1\}$, and $p\{2021\}$.¹⁰ Even earlier, Kunz described beryl crystals to 10 cm (4 in) diameter from a pegmatite at Fort George,¹¹ while Manchester obtained some clear aquamarine from an excavation at Broadway and 157th street, and some golden beryl one block uptown, from which he had a number of small faceted gems cut as shown on the frontispiece of his book.^{7, pl. 1} Several other Manhattan localities are given by Chamberlin.¹²

1. Whitlock, H. P. 1903. List of New York mineral localities. *N. Y. State Museum Bulletin* 70, Mineralogy 3 (Albany) 108 pp.
2. Robinson, S. (1825). *A Catalogue of American Minerals with Their Localities*. Boston: Cummings, Hilliard, & Co. 316 pp.
3. Gosse, R. C. 1963. Some notes on the Batchellerville, New York quarry. *Rocks and Minerals Magazine* (Peekskill, N.Y.) 38:402-3.
4. Tan, Li-Pin 1966. Major pegmatite deposits of New York State. *N.Y. State Museum and Science Service Bulletin* 408 (Albany) 138 pp.
5. Jensen, D. E. 1978. *Minerals of New York State*. Rochester: Ward's Natural Science Establishment. 219 pp.
6. Beck, L. C. 1842. *Mineralogy of New-York*. Albany: W. & A. White & J. Visscher 536 pp.
7. Manchester, J. G. 1931. The minerals of New York City and its environs. *New York Mineralogical Club Bulletin*, vol. 3, no. 1, 169 pp.
8. Januzzi, R. E. 1961. *The Mineralogy of Connecticut and Southeastern New York State*. Danbury: The Mineralogical Press. 257 pp.
9. Pough, F. H. 1936. Bertrandite and epistilbite from Bedford, New York. *American Mineralogist* 21:264-5.
10. Ries, H. 1897. Note on a beryl crystal from New York City. *Transactions, New York Academy of Sciences* 16:329-30.
11. Kunz, G. F. 1887. Minerals from Fort George, New York City. *Transactions, N.Y. Acad. of Sciences*, vol. 7, no. 2, [1]p.
12. Chamberlin, B. B. 1888. The minerals of New York County, including a list complete to date. *Transactions, N.Y. Acad. of Sciences*, May 7, 1888, pp. 211-35.

New Jersey

Only recorded from Phillipsburg, Warren County.¹

1. Wilkerson, A. S. 1959. Minerals of New Jersey. *The Geological Society of New Jersey Report 1* New Brunswick: Rutgers University. 51 pp.

Pennsylvania

Beryl localities are all concentrated around Philadelphia and the SE corner of the state in granitic pegmatites intruded in Wissahickon gneiss.¹ Robinson mentions six localities, many

World Sources of Ore and Gem Beryl / United States of America

no longer identifiable,² while Genth gives better information on both deposits and types of beryl found.³ Localities around Philadelphia are described by Rand et al.⁴ The most complete information occurs in Gordon, listing 50 occurrences;⁵ amplifying information on beryl is contained in Montgomery.^{1, pp. 72-5} Gem beryls are discussed in Sinkankas.⁶

Philadelphia County. Chestnut Hill; Cobb's Creek; Fairmount Park; Germantown, Logan; Overbrook; Ryers; Shawmont;^{1,5} Flat Rock Tunnel.³

Delaware County. At Adele, Genth describes: "Fine crystals of almost emerald-green . . . associated with small crystals of black tourmaline in a dark micaceous schist at Deshong's quarry, near Leiperville; in the granitic veins of the same quarry and in the vicinity very beautiful slender crystals of yellowish, greenish and blueish beryl . . . sometimes ten to twelve inches in length and one and a half inches in diameter"; similarly, very beautiful crystals, "often doubly terminated with pyramidal and basal plane . . . Shaw and Ezra's quarry, near Chester."^{3, p. 70} Other localities are: Avondale, Boothwyn (green crystals to 30 × 7.5 cm (11.75 × 3 in); Bunting's quarry; Burk's quarry; Castle Rock.^{5, p. 85} Localities are very numerous around Media, "especially south and east of there."^{1, p. 75} Kunz mentions that in 1890 "a superb piece of golden beryl that afforded a perfect gem, weighing 35 and 11/16 carats" was found in the Avondale quarry.⁷ Sterrett visited the quarry in 1914 and noted that the opencut was nearly one-quarter mile (0.4 km) long and that golden beryl occurred in fragments in pegmatite veins cutting the country gneiss.⁸

Chester County. Genth records six- and twelve-sided prisms of blueish green and blue from near Unionville, Newlin Twp., one of which is in the Jefferis collection and weighs 51 lb (23 kg).^{3, p. 71} Many other localities in this county are recorded in Gordon⁵ and Montgomery.¹ The latter also notes that "all matrix specimens display clearly the frozen-in character of their contained beryl crystals, for there are no crystal pockets in these pegmatites."^{1, p. 75}

ology of Pennsylvania. Second Geological Survey of Pennsylvania. Harrisburg, v.B (1874). 206 pp.

1. Montgomery, A. 1969. *The mineralogy of Pennsylvania 1922-1965.* Academy of Natural Sciences, Philadelphia, Special Publ. 9. 104 pp.
2. Robinson, S. 1825. *A Catalogue of American Minerals with Their Localities.* Boston: Cummings, Hilliard, & Co. 316 pp.
3. Genth, F. A. 1875. *Preliminary report on the mineralogy of Pennsylvania.* Second Geological Survey of Pennsylvania. Harrisburg, v.B (1874). 206 pp.
4. Rand, T. D.; Jefferis, W. W.; and Cardeza, J. T. M. 1893. Mineral localities of Philadelphia and vicinity. *Proceedings, Academy of Natural Sciences, Philadelphia*, 44:174-202.
5. Gordon, S. G. 1922. *The mineralogy of Pennsylvania.* Academy of Natural Sciences Philadelphia, Special Publ. 1. 255 pp.
6. Sinkankas, J. 1976. *Gemstones of North America.* 2 vols. New York: Van Nostrand Reinhold Co. 675, 494 pp.
7. Kunz, G. F. 1892. *Gems and Precious Stones of North America.* 2nd ed. New York: The Scientific Publishing Co. 367 pp.
8. Sterrett, D. B. 1915. Gems and precious stones. *U. S. Geological Survey Mineral Resources of the United States for 1914*, pp. 307-46.

Maryland

Cecil County. Beryl occurs in Wiant's quarry, 1.2 km (0.75 mi) NE of the town of Pilot, in a desilicated pegmatite in serpentine; albitite units with small vugs sometimes contain minute, transparent, greenish, highly-modified beryl crystals.¹

Baltimore County. In gneiss quarries along Jones Falls [river] in the city, but such openings are now filled-in; from Wright quarry in the city; some gem aquamarine reported from Arundel gneiss quarry.²

Howard County. Greenish or yellowish prisms in Ben Murphy Mica mine, 1.6 km (1 mi) SW of Scaggsville.^{3, p. 104}

Montgomery County. The Earth Products Company feldspar quarry, 6.2 km (4 mi) N 70° W of Laurel, contained beryl crystals.³ Kensington Mica mine, also known as Gilmore or Warner mine, 6.2 km (4 mi) N 55° W of Kensington, has common yellowish beryl;³ a prism collected by Shannon was 9 kg (20 lb).⁴

1. Gordon, S. G. 1921. Desilicated granitic pegmatites, *Proceedings, Academy of Natural Sciences, Philadelphia*, pt 1, pp. 169-92.
2. Ostrander, C. W., and Price, W. E. 1940. *Minerals of Maryland.* Baltimore: The Natural History Society of Maryland. 92 pp.
3. Sterrett, D. B. 1923. Mica deposits of the United States. *U.S. Geological Survey Bulletin* 740. 342 pp.
4. Shannon, E. V. 1926. Some minerals from the Kensington mica mine, Montgomery County, Maryland. *American Mineralogist* 11:35-7.

Virginia

Despite the large number of granitic pegmatite bodies that have been exploited for feldspar and mica, beryl occurs in only a few of them, seldom in important quantities and rarely in gem grade. The earliest study of the deposits was by Sterrett

1. Montgomery, A. 1969. *The mineralogy of Pennsylvania 1922-1965.* Academy of Natural Sciences, Philadelphia, Special Publ. 9. 104 pp.
2. Robinson, S. 1825. *A Catalogue of American Minerals with Their Localities.* Boston: Cummings, Hilliard, & Co. 316 pp.
3. Genth, F. A. 1875. *Preliminary report on the mineralogy of Pennsylvania.* Second Geological Survey of Pennsylvania. Harrisburg, v.B (1874). 206 pp.

BERYL LOCALITIES

in 1923,¹ followed by a monograph completely devoted to the pegmatites of the state by Pegau.² Later reports include those of Lemke et al.,³ Griffiths et al.,⁴ and more recently, Brown.⁵ The mineralogy of the complex pegmatites near Amelia was treated by Glass⁶ and again by Sinkankas.⁷ The Morefield mine in the vicinity is described by Geehan.⁸ A guide to important localities appears in Morrill,⁹ but the most complete compilation is that of Dietrich.¹⁰

Caroline County. Beryl in prisms to 7 kg (15 lb) came from Last Mile mine, Lawrence Beazley Farm, ca. 10 km (6.5 mi) SW of Ladysmith.^{5,10}

Rockbridge County. Greisenized rock at the cassiterite deposit on Irish Creek, ca. 16 km (10 mi) SE of Steels Tavern, contains small, prismatic, greenish or yellowish crystals to about 1–2 cm (0.4–0.8 in) long and only 2 mm in diameter associated with cassiterite, muscovite, wolframite, siderite, ankerite, fluorite, biotite, phenakite, hematite, calcite, and minor sulfides as well as others.^{11,12,13}

Powhatan County. Crude prisms of common blue-green and milky white up to 1.5 m (5 ft) long and 68 cm (27 in) diameter came from Herbb No. 2 mine, 5.7 km (3.6 mi) NE of Flat Rock; most crystals were much smaller; a large crystal is depicted in Brown.^{5,10,52} An etched goshenite crystal from this deposit is recorded.¹⁰ Common beryl also occurs in Herbb No. 1 mine, 5.4 km (3.4 mi) NE of Flat Rock and in Jervey mine near Fine Creek Mills.¹⁰

Amelia County. Common beryl is found in many deposits but absent from cores with result that few fine crystals were ever found. Localities summarized in Dietrich are:¹⁰ Flippen prospect, 5.4 km (3.4 mi) E of Amelia; nearby Dobbin prospect, white to pale green crystals; blue fragments were found in James Anderson prospect near Rodophil; small golden crystals from Champion (Jefferson No. 4) mine ca. 4.8 km SW of Amelia. Well-formed greenish and yellowish crystals from Wingo No. 1 mine on Swann Farm in S part of town of Amelia, some with gemmy areas. Small gem fragments occurred in the Abner Pinchbeck mine, 0.8 km (0.5 mi) E of Amelia. At Ligon No. 3 mine, 14 km (9 mi) NE of Amelia, white crystals to 12.7 cm (5 in) diameter and 30 cm (12 in) long were found; nearby in Ligon No. 2, pale blue crystals and fragments. Blue-green crystals occur at McCraw No. 3 mine, 0.8

Table 14-50
ANALYSIS OF IRISH CREEK BERYL¹²

	Percent		Percent		Percent
SiO ₂	63.17	CaO	nil	K ₂ O	0.07
Al ₂ O ₃	18.75	MnO	nil	Rb ₂ O	nil
Fe ₂ O ₃	0.27	BaO	nil	Cs ₂ O	0.32
FeO	2.28	TiO ₂	0.02	H ₂ O +	0.08
BeO	12.23	Li ₂ O	0.07	H ₂ O -	1.82
MgO	0.22	Na ₂ O	0.53	Total	99.83

km (0.5 mi) E of county route 630, about 3.2 km (2 mi) NE of Amelia. Dark blue-green, well-formed crystals to 7.7 cm (3 in) occur in Vaughan Beryl Prospect No. 1, 5.2 km (3.3 mi) E of Amelia; also small white crystals in Vaughan Beryl Prospect No. 2 nearby and the No. 3 prospect 4.5 km (2.75 mi) due E of Amelia. Pale yellow-green crystals were found in Jefferson No. 2 mine, 3.2 km (2 mi) NE of Amelia. According to Brown, gemmy beryl has been reported from Truchart, Champion, and Morefield mines, and clear blueish green from James Anderson prospect.⁵

The Rutherford No. 1 and No. 2 mines on the Keener Farm near Amelia are noted for a large variety of rare species and gem spessartine, as well as fine amazonite, but are remarkably poor in beryl. König, however, mentions that at the "mica mine at Amelia Court House," presumably one of the Rutherford mines, a beryl crystal was found that measured 64 cm (25 in) in diameter and was over 3.6 m (12 ft) long.¹⁴ S. V. Morefield, owner of the mine of the same name near Amelia, reported in 1933 that he had produced and sold "several tons of beryl for the BeO content."¹⁵ Fontaine mentions large common beryl crystals to 45 cm (18 in) diameter and 0.9–1.4 m (3–4 ft) long from the Rutherford No. 2 mine¹⁶; see also Pegau.¹⁷

Charlotte County. Small prisms occur in Evans prospect S of Madisonville; in Crews No. 1 mine and elsewhere in the Cullen-Charlotte area.^{4,10,18}

Bedford County. Small crystals are found in Mitchell mine 10 km (6.5 mi) SE of Bedford and the Patterson feldspar mine.^{10,18}

Franklin County. Pale blue crystals to 3.5 cm (1.5 in) diameter come from Simms mine, 3 km (1.9 mi) W of intersection of county roads 632

World Sources of Ore and Gem Beryl / United States of America

and 619; pale blue from Klondike mine, 2.9 km (1.8 mi) W of same intersection.^{4,5,10,18} Fine blue and light green crystals occur in Sue Emma Brown mica mine, 1.6 km (1 mi) NW of Hundle's Store.¹⁰ At Center Ridge mine, ca. 33 km (21 mi) N of Martinsville beryl also occurs.¹⁹

Pittsylvania County. Large crystals are found in Hairston mine, 4.8 km (3 mi) N of Axton; in a prospect pit just NW of Whitehead mine, 0.8 km (0.5 mi) NE of Sycamore.¹⁰

Henry County. Gem golden beryl and common blue-green beryl has been found on K. E. Williams property about 4.8 km (3 mi) SW of Martinsville and about 0.8 km (0.5 mi) S of intersection of Highway 58 and Grassy Creek; crystals to about 15.6 cm (7 in) long.¹⁸ Another beryl source is the Holland mine, 2.8 km (1.75 mi) NNW of Axton.⁴

14. König, G. A. 1883. Notes on monazite. *Proceedings, Academy of Natural Sciences, Philadelphia* 34:15-6.
15. Morefield, S. V. 1933. [History of the Morefield mine]. *Rocks & Minerals Magazine* (Peekskill, N.Y.) 8:143-4.
16. Fontaine, W. M. 1883. Notes on the occurrence of certain minerals in Amelia County, Va. *American Journal of Science* 25:330-39.
17. Pegau, A. A. 1928. The Rutherford mines, Amelia County, Virginia. *American Mineralogist* 13:583-8.
18. Brown, W. R. 1945. Some recent beryl finds in Virginia. *Rocks & Minerals* 20:264-5.
19. Zeitner, J. C. 1968. *Appalachian Mineral & Gem Trails*. San Diego: The Lapidary Journal. 134 pp.

North Carolina

Discovery of beryl deposits probably does not antedate 1870, for Kerr, in his report on the geology of the state dated 1875, noted that mica mining "is a comparatively new industry in North Carolina, having been inaugurated only four or five years ago."¹ Kerr explains, however, that certain pegmatite bodies had been worked upon their outcrops by Indians seeking mica, and the likelihood is excellent that an occasional beryl crystal was found during such mining. In an appendix to Kerr's report, Genth notes beryl crystals having already been mined at Ray's mine on Hurricane Mountain, Yancey County, and at other points in Mitchell and Burke counties.^{1,p.71} More beryl occurrences were given by Genth in a paper of 1891.² An excellent history of gem mining in the state was published by Kunz in 1907.³ Considerably later, Stuckey prepared a detailed history of the development of the geological sciences in North Carolina,⁴ while the first systematic guide to mineral localities appeared in Conley.^{5,6} Much information on collecting is also contained in Zeitner,⁷ with the latest compilation appearing in 1978 in Wilson and McKenzie.⁸ Gemstone information is contained in Sinkankas.⁹

Interest in the pegmatites as sources of commercial mica prompted descriptions of such bodies in the Spruce Pine district by Maurice,¹⁰ Olson,¹¹ and Bropst,¹² and for the state as a whole, by Griffiths and Olson.¹³ By far most pegmatite bodies were mined for mica and feldspar, very few containing enough beryl to warrant exploitation for that mineral alone. However, large reserves of beryl are present in numerous pegmatites of the tin-spodumene belt in the form of disseminated crystals, generally less than 3-4 mm in size, whose recovery would require milling of entire bodies of rock. It is estimated that the belt

1. Sterrett, D. B. 1923. Mica deposits of the United States. *U.S. Geological Survey Bulletin* 740, 342 pp.
2. Pegau, A. A. 1932. Pegmatite deposits of Virginia. *Virginia Geological Survey Bulletin* 33, 123 pp.
3. Lemke, R. W.; Jahns, R. H.; and Griffiths, W. R. 1952. Mica deposits of the Southeastern Piedmont. Part 2. Amelia District. *U.S. Geological Survey Professional Paper* 248-B, pp. 103-39.
4. Griffiths, W. R.; Jahns, R. H.; and Lemke, R. W. Mica deposits of the Southeastern Piedmont. Part 3. Ridgeway-Sandy Ridge District, Virginia and North Carolina; Part 4. Outlying deposits in Virginia. *U.S. Geol. Surv. Prof. Paper* 248-C, pp. 141-202.
5. Brown, W. R. 1962. Mica and feldspar deposits of Virginia. *Virginia Division of Mineral Resources, Mineral Resources Report* 3 (Charlottesville) 195 pp.
6. Glass, J. J. 1935. The pegmatite minerals from near Amelia, Virginia. *American Mineralogist*, 20:741-68.
7. Sinkankas, J. 1968. Classical mineral occurrences: I. Geology and mineralogy of the Rutherford pegmatites, Amelia, Virginia. *American Mineralogist* 53:373-405.
8. Geehan, R. W. 1953. Morefield pegmatite mine, Amelia County, Virginia. *U.S. Bureau of Mines Report of Investigations* 5001, 41 pp.
9. Morrill, P. 1967. *Mineral Guide to Maryland and Virginia Areas*. Harrisburg, Va.: Park View Press. 40 pp.
10. Dietrich, R. V. 1970. Minerals of Virginia. *Virginia Polytechnic Institute Research Division Bulletin* 47 (Blacksburg) 325 pp.
11. Koschmann, A. H.; Glass, J. J.; and Vhay, J. S. 1942. Tin deposits of Irish Creek, Virginia. *U.S. Geol. Surv. Bull.* 936-K, pp. 271-96.
12. Glass, J. J.; Koschmann, A. H. and Vhay, J. S. 1958. Minerals of the cassiterite-bearing veins at Irish Creek, Virginia, and their paragenetic relations. *Economic Geology* (Lancaster, Pa.) 53:65-84.
13. Lesure, F. G.; Kiilsgaard, T. H.; Brown, C. E.; and Mrose, M. E. 1963. Beryllium in tin deposits of Irish Creek, Virginia. *U.S. Geol. Surv. Prof. Paper* 475-B, Art. 3, pp. B12-B15.

BERYL LOCALITIES

contains "823,000 tons of beryl, equivalent to 122,800 tons of BeO" and may someday provide a major source of this mineral, if it ever becomes economically feasible to exploit these deposits.^{14,p.1}

Warren County. Common beryl, lepidolite, smoky quartz, and amethyst occur in Fowler Mica mine, 4 km (2.5 mi) SSE of Inez;^{6,13,15} in Alston mine, 4.8 km (3 mi) NW of Centerville.¹³

Wake County. Found on the Fowler property, on Maple Branch, 4 km (2.5 mi) SE of Inez;¹⁶ on Thompson Farm, 4 km (2.5 mi) S of Purnell.^{6,8}

Ashe County. Small golden beryl crystals occur on Roy Goodman property at Crumpler; crystals as "large as a man's arm" were reported from Little Phoenix mine, 3.6 km (2.25 mi) N 60° E of Jefferson; also in nearby Tarkington mine.¹⁵ Beryl occurs in Duncan mine, 1.9 km (1.2 mi) SW of West Jefferson;^{6,8} crystals to 20 cm (8 in) diameter in S. Hardin mine, 2.4 km (1.5 mi) SW of Beaver Creek.^{9,15}

Iredell County. Common greenish and golden beryl were found in the W. A. Campbell prospect, 3.2 km (2 mi) SSW of Newhope.^{6,13}

Alexander County. The most important emerald deposits in North America are centered on the small village of Hiddenite, itself named after the emerald green spodumene which honors W. R. Hidden, the first systematic exploiter of the local deposits. Although Hidden received great publicity as a result of his mining efforts, it seems that his information on the existence of emeralds was obtained from a local resident, J. Adlai D. Stephenson of Statesville, who wrote a manuscript for Dr. G. F. Kunz of New York City, describing the gemstones of North Carolina and the places from which they could be obtained.¹⁷ Stephenson told of his simple plan for exploring for gemstones; "to go among the people of the country and endeavor to interest them in collecting the different crystals found in their respective sections." As a result, "the first beryl I collected suitable for cutting was found early in 1875, at the locality now known as the 'Emerald and Hiddenite Mine,' " the name for the company Hidden formed to exploit the deposits. Furthermore, stated Stephenson, "it was a beautiful Aquamarine, but only partly suitable for cutting; a few weeks later I obtained at this locality my first Emerald, it was small and rather opaque, but of fine color, and the file like markings on its planes were very distinct." Sometime later, in 1876 he states, "I collected two others at the same local-

ity, their color was not quite so good as the first, but one of them was more transparent."¹⁷

In the following year, 1877, additional specimens were forthcoming, for Stephenson wrote, "Mr. I. W. Miller brought me two Emeralds found on his mother's farm, two miles northeast of the 'Emerald and Hiddenite Mine.' They were of good color and quite transparent." In 1883, "Mr. I. O. Lackey brought me thirty-six small Emeralds, which he found in a vein in dark Mica, on his farm a short distance south west of the 'Emerald and Hiddenite Mine,' their color varied from light Emerald green to colorless."¹⁷ Stephenson also mentioned a small emerald found by a Dr. Parlier in the Bently Settlement, Sugar Loaf Township, Alexander County, as well as finds of beryl made elsewhere in the state.

Stephenson may also be the discoverer of hiddenite, because he said "the first crystal . . . was found April 1879, at the locality now known as the 'Emerald and Hiddenite Mine,' and I had previously found at this locality, quite a number of small fragments, but considered them fragments of Beryl, but this crystal convinced me that they were not Beryl, but some other mineral, unknown to me. It was pronounced by an expert to be Diopside [sic], which name it carried until an analysis made by the late J. Lawrence Smith, who found it to be a variety of Spodumene."¹⁷

The entry of Hidden upon the scene, according to Stephenson, took place considerably later when "on September 17th, 1879 . . . he and I visited this locality and made a hurried examination of it." Subsequently, "in March 1880, he returned to North Carolina and leased the property, which he afterwards purchased, and organized a company, and commenced mining for Gems."¹⁷ Hidden's first announcements of the results of this mining were made in 1881-1882, in which due credit was given to Stephenson for the discovery of emeralds.^{18,19,20} A good account of his activities appeared in an appendix to Kunz's precious stones chapter in *Mineral Resources of the United States for 1882*,²¹ but Hidden's statements therein leave the impression that he had ventured into the emerald field without the assistance of Stephenson. Indeed, Hidden was only made aware of the existence of emeralds by seeing them in Stephenson's collection, and it was Stephenson who actually led him to the spot where they were found.

Hidden initially explored the ground by trenching under the discovery point. There he uncov-

World Sources of Ore and Gem Beryl / United States of America

ered a vein at a depth of 2.4 m (8 ft) from which he obtained small emerald crystals and the spodumenes of green color that were later named after him. Up to 1882, over 80 narrow veins were found within an area of only 12 m (40 ft) square, from which were extracted emerald, hiddenite, quartz, rutile, mica, monazite, dolomite, calcite, apatite, and pyrite. Common beryl was also found, sometimes in sharp crystals. The largest emerald crystal, broken into several sections, was found at this time and measured 21.5 cm (8.5 in) long and weighed 9 ounces (258 gm). It was one of nine crystals found together in one vug; all were transparent though flawed. In the spring of 1882, one pocket alone yielded 74 emerald crystals, some between 5–12.5 cm (2–5 in) long, although most were smaller. Hidden noted that "the gems and crystals occur in open pockets . . . of very limited extent, these are cross-fractures or fissures,"¹⁹ an extremely important observation, as will be explained below. The largest crystal mentioned above eventually passed into the collection of the American Museum of Natural History in New York but was stolen in 1950 and never recovered.²² It is depicted in color on a plate in Kunz's work on North Carolina gems.³ This crystal, and many other smaller ones, are typical of the deposits near Hiddenite. The majority are unfit for faceted gems, as acknowledged by Hidden himself, who said, "in regard to the commercial value of the emeralds thus far found, I will frankly state that the majority . . . have little value for gem purposes; but as cabinet specimens they are unprecedented, and as such have a market value ranging from \$25 to \$1,000 each."¹⁹ Bernheim reported that the largest crystal noted above sold in 1882 for \$800.²³

In about 1884, Stephenson sent Kunz some emerald crystals, advising that they came from the property of J. O. Lackey, about 1 mile (1.6 km) SW of the Emerald and Hiddenite Company's mine, and were found in a vein of black decomposed mica associated with quartz crystals, rutile, and hiddenite.²⁴ This occurrence was noted by Hidden as on the Osborne-Lackey place about 1/2 mile NW of his own mine. About fifty crystals of emerald were found, 2–7 cm (0.75–2.75 in) long and 2–8 mm (0.1–0.30 in) in diameter, pale colored but transparent.²⁵ One crystal was large and clean enough for gems, but the hiddenite crystals found at the same time were pale in color and inferior in quality. A summary of the work

accomplished at the Hidden mine by Kunz noted the discovery of a large pocket that yielded excellent crystals of muscovite, brilliant rutile crystals, and nine doubly-terminated emerald crystals from 25 to 77 mm (1–3 in) long and up to 42 mm (1.7 in) in diameter.²⁶ The largest was classed as especially fine, of light green color and weight of 8.75 ounces (250 gm). It was valued at \$1,500 and all nine crystals as a lot at \$3,000. The only cut gem was prepared from a crystal that was found in a pocket 43 ft (13.5 m) below the surface and described as pleasing pale green, weight 4²³/₃₂ carats and valued at \$200. At this time the finest hiddenite crystal was found and sold to the eminent collector, Clarence S. Bement; it measured 68 × 14 mm (2.75 × 0.6 in). These events were also reported by Hidden.^{27,28}

During this early period of development, the best mineralogical descriptions of pocket contents were provided by Vom Rath, who examined specimens provided by Hidden.^{29–32} These included monazite from a locality 4.7 km (3 mi) E of the hiddenite mine, also xenotime, apatite, hiddenite, tourmaline, and rutile crystals, some of the last 11 mm (0.4 in) long. Comparable descriptions were also furnished by Hidden and Washington, who remarked particularly on a highly modified colorless beryl crystal found within a hiddenite pocket, (see fig. 9-12) and on rutile, brown muscovite, dolomite, siderite, pyrite, and tourmaline.³³ Further mineralogical information was supplied by Hidden in 1889.³⁴ By 1888, productive mining apparently ceased, for Kunz reported only two small emerald crystals found.³⁵ In 1897, Kunz described the circumstances under which Stephenson discovered the emeralds and hiddenites,³⁶ basing his remarks on the Stephenson manuscript previously mentioned.¹⁷

After some years of inactivity, the Emerald and Hiddenite Mine was reopened in 1907 by Cary Wright for the American Gem Mining Syndicate. At this time the Ellis mine, located only 0.4 km (0.25 mi) E of Hiddenite was also opened.³⁷ Work stopped less than a year later, in September, although emerald and aquamarine in "promising" quantities had been mined. A beautiful beryl crystal over 750 carats in weight, 50 × 38 mm (2 × 1.5 in), was found in the emerald diggings along with other numerous aquamarine crystals. Also some fine aquamarine crystals were found in the Ellis mine, and emeralds of fine color oc-

BERYL LOCALITIES

curred in both mines. One dark green emerald crystal from the Ellis weighed 276 carats. Sterrett examined the workings at this time and found a number of veins exposed in the emerald mine, the latter consisting of several shafts and pits sunk in the weathered country rock of biotite gneiss, which had been compressed and folded.³⁷ An excellent summary of the mining activity was furnished by Sterrett in another report.³⁸

Activity did not resume at the Emerald and Hiddenite mine until it was reopened in 1926 by the Colburn brothers of Asheville, who extracted some fine specimens of all the reported species, including emerald crystals, aquamarine crystals and hiddenite crystals on matrix.³⁹ A detailed report on the geology and mineralogy of the deposit was published by Palache et al. in 1930.⁴⁰ They noted the following species: abundant quartz, also amethyst, several feldspars, hiddenite, holmquistite, tourmaline, garnet, muscovite, nontronite, rutile, monazite, apatite, pyrite, arsenopyrite, and carbonates in addition to several varieties of beryl. A small, complex beryl crystal, figured by Palache, displayed forms *c* and *m*, also $a\{11\bar{2}0\}$, $p\{10\bar{1}1\}$, $n\{20\bar{2}1\}$, $d\{3\bar{3}64\}$, $a\{11\bar{2}1\}$, $\{51\bar{6}1\}$, $n\{31\bar{4}1\}$, and $v\{21\bar{3}1\}$. The collection of minerals from this locality assembled by the Colburns was later donated to the University of South Carolina in about 1945.

The recent history of the emerald mines and associated deposits is described in Sinkankas,^{9, vol. 2} The most notable event was the formation of American Gems, Inc., financed by Charles G. Rist of Fairfield, Pa., and placing W. D. Baltzley in charge of field operations. Baltzley had intensively prospected the field in 1968 and satisfied himself that profitable mining for emeralds could be resumed. By 1969, considerable trenching had uncovered productive veins from which a number of splendid emeralds were recovered, including the largest thus far discovered, a stubby hexagonal prism, forms *m* and *c*, weight 1,438 carats, found in that year by Michael Finger of Lincolnton, N.C. An account and excellent photographs of these events appeared in Trapp.⁴¹ In 1970, Wayne Anthony of Lincolnton, found a richly colored emerald of 59 carats at the locality (now called Emerald Valley) which contained a colorless core typical of these crystals, but was surrounded by an intense green envelope from which an excellent gem, 15.65 × 12.35 mm, weight 13.14 carats was cut. Crowning-

shield claims that it is "indistinguishable" in terms of color and quality from Muzo emerald.⁴³ This gem gave R.I. of 1.580–1.588, diff. 0.008, $G=2.73$, and a reddish fluorescence under long wave UV of 3660 Å. The gem was sold to Michael R. Santangelo of New York City, and resold to Tiffany's, of New York, who valued the gem at \$100,000 in 1971.⁴⁴ The largest crystal recently found, mentioned above, was stolen by an employee of American Gems, Inc., but fortunately recovered.⁴⁵ At the present time, the property is open to the public for digging upon payment of a small fee.

All occurrences hitherto mentioned in the Hiddenite area lie within contorted gneiss containing numerous veins and veinlets of feldspar-quartz concordant with the foliation and sometimes containing interesting species, although those most productive are cross-cutting fracture fillings, as previously noted by Hidden above. These appear to be shrinkage cracks. Sterrett, in his examinations, noted that the veins strike N of E, with steep dips to the N, and that rock adjacent to such veins was "highly silicified by the addition of much quartz," and that such quartz, "along with other minerals, as muscovite, rutile, pyrite, etc., has replaced the biotite and feldspars and other minerals of the country rock."³⁷ His evidence, and that found by myself during a visit to the locality, confirms that these openings were mineralized by hydrothermal activity rather than by injection of pegmatitic material as suggested by Palache et al.⁴⁰ The latter, in their discussion of the crystal-lined cavities, note that they "remind one very strongly of the alpine clefts in form, structure, and the habit and nature of the contained minerals."⁴⁰ After reviewing the remarks of others, and based on examinations in the field, Sinkankas concludes that "the emerald-bearing veins of the Hiddenite area are unlike all other emerald deposits so far discovered and should be regarded as a unique class" (vol. 2, p. 28).⁹

Other beryl deposits in Alexander County furnished excellent specimens. Kunz mentions a dark, sea-green, facetable beryl crystal, capable of yielding cut gems to 20 carats, found in a plowed field near Little Robinet's Store and Little River Church in the vicinity of Russell Gap road.³⁵ Sterrett mentions an occurrence of emeralds on the W. H. Warren property, about 2.4 km (1.5 mi) SE of Hiddenite, beryls on the adjoining Alexander Miller property, and gem beryls from



Fig. 14-71 Excavations made to follow emerald-bearing veins in the decomposed gneiss on the property of American Gems, Inc., near Hiddenite, Alexander Co., North Carolina. *Top*: A hole dug by amateur miners. *Bottom*: an exploratory hole dug by mechanical equipment belonging to the property owners; this excavation yielded some small, late-stage amethyst crystals from a narrow vuggy vein. Photos taken in 1969.

BERYL LOCALITIES

NW of Taylorsville just to the N of All Healing Springs.^{37,38} Here, on Eli Barnes's property, 2 km (1.25 mi) N 20° W of All Healing Springs, beautiful pale yellow beryl crystals were found. On the Thomas Barnes property, 3.2 km (2 mi) N 30° W of the springs, golden, yellow, greenish and colorless crystals were found, the largest reported as 48 × 7.6 cm (18 × 3 in). Good golden and yellow beryls were also found on James Chapman's place, 2.8 km (1.75 mi) N 15° E of the springs, and on John Webster's place, about 2 km (1.25 mi) N 50° E of same. The O. F. Patterson mine, 1.2 km (0.75 mi) SE of Hiddenite, also produced beryl.¹³

Burke County. Occurrences here are aquamarine and green and yellow crystals in Joel Walker prospects on a knob 0.8 km (0.5 mi) SE of Walker Knob, 13 km (8 mi) W of Morganton; some crystals were gem quality. Similar material occurs in pegmatites 1.6 km (1 mi) W of these prospects.^{46,47} Translucent to transparent, beryl, pale green, and yellowish green, also golden crystals of small size occur in Burkmont prospect, 0.4 km (0.25 mi) S of the top of Burkmont Mt., or 9 km (5.5 mi) S 10° W of Morganton.^{13,15} In sands of Brindletown Creek and the old J. C. Mills gold mine other beryl has been found.⁶

Catawba County. Localities for beryl are Besse Hudson mine, 0.6 km (0.4 mi) E of Burke-Catawba counties line, W of Highway N.C. 18;⁶ Drum mine, 7 km (4.5 mi) NNW of Conover.¹³

Lincoln County. Beryl occurs in Brown and Carbine mines, about .95 km (0.6 mi) W of Flay and Shull (John Dillinger) mines, 9 km (5.75 mi) E of Toluca.¹³

Rutherford County. Golden beryl occurs on Roy McFarland property on Duncan's Creek road, 3.2 km (2 mi) E of N.C. road 1006; in Dycus mine, ca. 1.6 km (1 mi) N of Ellenboro; on Martin and Toney properties nearby.⁶

Cleveland County. In 1909, a new emerald deposit was found on the land of W. B. Turner, 7.5 km (4.75 mi) S 30° W of Shelby near the E bank of First Broad River, but it was reported that these crystals were first found by local residents in about 1896. When visited by Sterrett in 1909, about a dozen, fine, dark green crystals had been found, all more or less checked and some with silky inclusions, the largest about 25 × 18 × 12 mm (1 × 0.75 × 0.5 in).⁴⁸ In 1910, trenching uncovered a pegmatite vein containing colorless and smoky quartz, albite, black tourmaline, and an occasional emerald crystal. The

largest emerald found by this time was 57 × 15 mm (2.25 × 0.65 in) and weighed 26.2 gm.^{38,46} The deposits were worked by Turner and George L. English, the noted New York mineral dealer, after which the property was leased to Lovat Fraser and eventually purchased by him and E. P. Earle, both of New York. By 1912, the total yield of emeralds was placed at 2,969 carats with an estimated value of \$12,875.³⁸

According to Griffiths and Olson, the country rock is olivine gabbro and hornblende gabbro;¹³ both biotite-rich and quartzose varieties of granite occur near the deposit. Several pegmatite dikes cut the gabbros, three of which contain beryl but only one containing emerald. The last contains quartz, plagioclase, and minor tourmaline, also beryl, muscovite, and biotite. Some cavities contained smoky quartz, plagioclase, tourmaline, and beryl crystals. The emeralds are simple prisms, forms *m* and *c*, many deeply etched, and some containing tubular inclusions. These occur in albite and quartz but may also be found free in cavities. Some gem quality aquamarine was found in one of the dikes near the emerald dike.

Elsewhere in this county, common beryl occurs in L. R. Elliott mine, 5.6 km (3.5 mi) NW of Casar; in Cooke mine, 4 km (2.5 mi) S 73° W of Toluca; in Lattimore mine, 6 km (3.75 mi) NW of Polkville; in Joe E. Humphries mine, 2.4 km (1.5 mi) N 52° W of Lattimore; in Sam Putnam mine, 9 km (5.5 mi) NW of Shelby; and on the W. H. Fortenberry property 4 km (2.5 mi) due N of Grover.¹³ Aquamarine appears in pegmatite along a tributary of Buffalo Creek, 2 km (1.3 mi) E of Earl.⁶ Sterrett^{38,47} mentioned common beryl on the Whisnant place, near Hollybush, and in granitic pegmatites on W. A. Ware Farm, about 5.5 km (3.5 mi) SW of Kings Mt.⁴⁹ Minute beryl crystals and aggregates of beryl occur in the alaskite rocks at Kings Mountain, along with a variety of rare species, which make these deposits of great interest to collectors as well as to the economic geologists.⁵⁰ The total quantity of beryl contained in these deposits is enormous, as previously mentioned.^{14,51}

Gaston County. Common beryl in prisms to at least 30 cm (12 in) diameter occurs in Big Bess (M. M. Carpenter or M. S. Bess) mine, 5.5 km (3.5 mi) S 32° E of Cherryville; also in Huskins mine, 8 km (5 mi) SE of Cherryville.

Mitchell County. The third emerald deposit in North Carolina was discovered in 1894 by J. L. Rorison and D. A. Bowman on Brush Creek



Fig. 14-72 Turner emerald mine near Shelby, North Carolina, 1912. The emerald-bearing pegmatite dike is to the right and appears as a crumbling feldspar streak passing almost vertically through the decomposed gneissic country rock. *Courtesy U. S. Geological Survey.*

about 6.2 km (4 mi) S of Spruce Pine.^{52,53} However, Chapman claimed that the deposit was found in 1890 by Alfred Chrisawn on property then belonging to Thomas Sparks, and after about two years it was leased to Rorison and Bowman who actually accomplished the first mining.⁵⁴ Later the property was exploited by the American Gem and Pearl Company of New York City, who worked the mine for varying periods in 1919, 1935, and 1942. The progress of early mining was followed by Kunz⁵⁵ and Pratt who provided notes on the mineralogy of the deposit.⁵⁶ Merrill noted that the country rock is a very evenly banded micaceous gneiss and biotite schist, with the emerald-bearing granitic pegmatite, largely composed of albite and quartz with accessory tourmaline, garnet, and beryl, dipping E at a steep angle.⁵⁷ The vein, about 3 m (10 ft) wide, was less sharply differentiated from the enclosing rocks than is usually found in such bodies. Most beryl is the common opaque variety, and such emeralds as do occur are found partly in the vein and partly along its edges in the country rock.

The crystals are small but generally of good color. Both Pratt and Merrill noted that those closest to the contacts with schist were of the best color while those farther away tended to become pale and yellowish.^{56,57} Some of the best crystals furnished good faceted gems and cabochons, and still others, when found in solid, albite-black, tourmaline-mica matrix were cut in matrix or fashioned into slabs, blocks, and other ornamental items. Sterrett noted a similar deposit about 0.4 km (0.25 mi) N of the main deposit and considerably lower down on the slope of Crabtree Mountain.⁴⁸ This deposit furnished crystals of paler color, some as thick as a pencil.

The most recent mining commenced in 1957 by the Little Switzerland Emerald Mines, Inc. with the mine open to visitors during clement periods and collecting allowed on the dumps.⁵⁴ Trapp visited the mine in 1968 and stated that the part-owner and manager was William H. Collins of Little Switzerland.⁵⁸ At this time, the mine was being exploited by an incline dipping 40° that had reached a total distance of 63 m (210 ft) with the

BERYL LOCALITIES

vein at the bottom 1–1.2 m (3–4 ft) thick and 3.25 m (12 ft) wide. Among the specimens found was a matrix of 20 × 33 cm (8 × 13 in) held at \$5,000; another with a large crystal of emerald estimated to weigh 70 carats, and a good crystal of 17 × 30 mm (0.75 × 1.25 in). Other crystals were found which could cut gems of 6 to 8 carats. Furbish described quartz inclusions in these emeralds and suggested that they were sufficiently distinctive to serve as a means of identifying Crabtree emeralds from others.⁵⁹

Elsewhere in the county have been found: large beryl crystals in Buchanan mine, 2.4 km (1.5 mi) N 25° W of Ledger; some aquamarine in Z. T. McChone mines, 1.6 km (1 mi) S 30° W of Spruce Pine;¹⁵ common beryl in Old 20 mine, 8 km (5 mi) SW of Spruce Pine and in the McKinney mine, 2.5 km (1.6 mi) S of the Old 20 mine.⁶ Bropst mentioned beryl in Biggerstaff and Poteat mines.¹²

Yancey County. Beryl is found in Spec mine, 4.3 km (2.7 mi) SE of Micaville;⁶ in Ray mine, 3.2 km (2 mi) S 35° E of Burnsville and "famous for its large yield of beryl crystals suitable for both cabinet specimens and for cutting into gems."^{6,15}

McDowell County. Beryl occurs in pegmatites along old Mt. Mitchell toll road near McDowell–Buncombe counties line.⁶

Buncombe County. Gem aquamarine has been reported on J. F. Reece land, 2.4 km (1.5 mi) SE of Black Mountain Station.¹⁵

Jackson County. Beryl crystals, some with clear areas, have been found on R. E. Brown property, 2 km (1.25 mi) S 25° E of the place where Johns Creek and Caney Fork join. Some gem beryl is found in Thomas Grimshaw mine, 2.8 km (1.75 mi) due E of summit of Whiteside Mt. or 0.8 km (0.5 mi) NE of Whiteside Cove.^{46,47} Gem aquamarine occurs in Rice mine on the spur of Sassafras Mt., N 10° E of its summit, or 3.2 km (2 mi) S 30° W of Sapphire.^{6,15} Conley mentioned a beryl locality SW of Toxaway Mt. about 0.5 km (0.3 mi) NW of Highway U.S. 64, and another, the Sheepcliff mine on Sheepcliff Mt., 4.8 km (3 mi) N of Cashiers.⁶ Olson noted that in the Cashiers district there were 60 pegmatite mines, of which 7 carried beryl.¹¹

Macon County. Kunz states that golden beryl crystals, over 5 cm (2 in) long were found in an Indian mound near Tennessee Creek, indicating

that the native inhabitants discovered and mined pegmatite deposits long before the advent of white men.⁶⁰ The locality is not far from the Littlefield Beryl mine, at the headwaters of Tennessee Creek, about 1.6 km (1 mi) S of Whiterock Mt.; the latter mine produced some gem aquamarine and golden beryl in 1902.^{46,47} Golden beryl was found near the N limits of Highlands, also in a mine about 1.6 km (1 mi) S of the intersection of State Route 1620 and U.S. Highway 64.⁶

1. Kerr, W. C. 1875. *Report of the Geological Survey of North Carolina*. Vol. 1: *Physical Geography, Résumé, Economical Geology*. Raleigh: Josiah Turner. 325, 120 pp.
2. Genth, F. A. 1891. The minerals of North Carolina. *U.S. Geological Survey Bulletin* 74. 119 pp.
3. Kunz, G. F. 1907. History of the gems found in North Carolina. *North Carolina Geological and Economic Survey Bulletin* 12 (Raleigh) 60 pp.
4. Stuckey, J. L. 1965. *North Carolina: Its Geology and Mineral Resources*. Raleigh: Department of Conservation and Development. 550 pp.
5. Conley, J. F. 1958. Mineral localities of North Carolina. *North Carolina Department of Conservation and Development Information Circular* 16 (Raleigh) 83 pp.
6. ———. 1971. Mineral localities of North Carolina. Rev. ed. *North Carolina Department of Conservation and Development Information Circular* 16. 128 pp.
7. Zeitner, J. C. 1968. *Appalachian Mineral & Gem Trails*. San Diego: *Lapidary Journal*. 134 pp.
8. Wilson, W. F., and McKenzie, B. J. 1978. Mineral collecting sites in North Carolina. *North Carolina Department of Natural Resources and Community Development Information Circular* 24. 122 pp.
9. Sinkankas, J. 1976. *Gemstones of North America*, 2 vols. New York: Van Nostrand Reinhold Co. 675, 494 pp.
10. Maurice, C. S. 1940. The pegmatites of the Spruce Pine district, North Carolina. *Economic Geology* (Lancaster, Pa) 35:49–78, 158–87.
11. Olson, J. C. 1944. Economic geology of the Spruce Pine pegmatite district, North Carolina. *N.C. Dept. of Conserv. and Dev., Division of Mineral Resources Bulletin* 43, pts. 1–2, 67 pp.
12. Bropst, D. A. 1962. Geology of the Spruce Pine district, Avery, Mitchell and Yancey counties, North Carolina. *U.S. Geological Survey Bulletin* 1122-A. 26 pp.
13. Griffiths, W. R., and Olson, J. C. 1953. Mica deposits of the southeastern Piedmont. Part 5. Shelby-Hickory district, North Carolina. Part 6. Outlying deposits in North Carolina. *U.S. Geological Survey Professional Paper* 248-D. 203–93.
14. Griffiths, W. R. 1954. Beryllium resources of the tin-spodumene belt, North Carolina. *U.S. Geological Survey Circular* 308. 12 pp.
15. Sterrett, D. B. 1923. Mica deposits of the United States. *U.S. Geol. Sur. Bull.* 740. 342 pp.

World Sources of Ore and Gem Beryl / United States of America

16. Steel, W. G. 1952. The eastern Piedmont pegmatite district of North Carolina. *N.C. Div. Nat. Res. Inform. Circular* 9, 13 pp.
17. Stephenson, J. A. D. 1888. *Gems of North Carolina*. Manuscript in Kunz Collection, U.S. Geological Survey Library, Reston, Va., 27 pp.
18. Hidden, W. E. 1881. Mineral discoveries in Alexander County, North Carolina. *American Journal of Science* (New Haven) 21:159-60.
19. ———. 1882. The discovery of emeralds in North Carolina. *Transactions, New York Academy of Sciences* 1:101-5.
20. ———. 1882. Notes on some North Carolina minerals. *American Journal of Science* 24:372-4.
21. ———. 1883. The discovery of emeralds in North Carolina. Appendix to Precious Stones chapter in *U.S. Geological Survey Mineral Resources of the U.S. for 1882*, pp. 500-2.
22. Pough, F. H. 1950. Emeralds stolen from New York City museum. *Rocks & Minerals Magazine* (Peekskill, N.Y.) 25:351.
23. Bernheim, L. C. 1883. Hidden and hiddenite: a sketch of the life and labors of Prof. Wm. Earl Hidden, discoverer of the famous new gem—"hiddenite." *At Home and Abroad* (Charlotte, N.C.) 5:1-10, portrait.
24. Kunz, G. F. 1884. [Exhibit of specimens of emerald from North Carolina]. *Trans., N.Y. Acad. of Sci.* 3:38.
25. Hidden, W. E. 1885. Occurrence of emeralds and hiddenite discovered on the Osborne-Lackey place. *American Journal of Science*, 29:250-1.
26. Kunz, G. F. 1886. Precious stones. Chapter in *U.S. Geol. Sur. Min. Res. of the U.S. for 1885*, pp. 437-44.
27. Hidden, W. E. 1886. A notable discovery of precious stones in Alexander County, N.C. *Trans. N.Y. Acad. of Sci.* 6:2-4.
28. ———. 1886. Recent discovery of emeralds and hiddenite in North Carolina. *American Journal of Science* 32:483-4.
29. Rath, G. vom. 1886. [Mineralien aus Alexander County, Nord-Carolina]. *Sitzungsberichte der Niederrheinische Gesellschaft für Natur- und Heilkunde, Allgemeine Sitzung 3 Mai, 1886*, pp. 149-58.
30. ———. 1886. [Beryll von der "Hiddenit-Grube," Alexander County, Nord-Carolina]. *Sitzungsberichte der Niederrheinische Gesellschaft für Natur- und Heilkunde, Allgemeine Sitzung 8 Feb. & 5 Jul., 1886*, pp. 67, 68, 254-6.
31. ———. 1887. Notes on minerals from North Carolina. *American Journal of Science* 33:159-60.
32. ———. 1888. Ueber Beryll, Monazit, Xenotim, Apatit, Spodumen, Turmalin und Rutil von Alexander County, Nord-Carolina. *Zeitschrift für Kristallographie*. (Leipzig) 13:595-98.
33. Hidden, W. E. and Washington, H. S. 1887. Contributions to mineralogy. *American Journal of Science* 33:501-7.
34. Hidden, W. E. 1889. Addendum to the minerals and mineral localities of North Carolina. *Journal of the Elisha Mitchell Scientific Society* (Chapel Hill, N.C.) 6:45-79.
35. Kunz, G. F. 1889. Precious stones. Chapter in *U.S. Geol. Sur. Min. Res. of the U.S. for 1888*, pp. 580-5.
36. ———. 1898. Precious stones. Chapter in *19th Annual Report, Director of the U.S. Geol. Survey*, Pt. 6. *Min. Res.*, pp. 497-514.
37. Sterrett, D. B. 1908. Precious stones. Chapter in *U.S. Geol. Sur. Min. Res. of the U.S. for 1907*, pp. 795-842.
38. ———. 1913. Precious stones. Chapter in *U.S. Geol. Sur. Min. Res. of the U.S. for 1912*, pp. 1023-60.
39. Davidson, S. C. 1927. The hiddenite occurrence in North Carolina. *American Mineralogist* 12:305-7.
40. Palache, C.; Davidson, S. C.; and Goranson, E. A. 1930. The hiddenite deposit in Alexander County, North Carolina. *American Mineralogist* 15: 280-302.
41. Trapp, F. W. 1970. "Green bolts" are found again near Hiddenite, N.C. *Lapidary Journal*, 24:116-18, 120, 122, 126.
42. ———. 1971. Emeralds are "in" at Hiddenite, North Carolina. *Lapidary Journal* 25:524.
43. Crowningshield, R. 1971. America's largest faceted emerald. *Lapidary Journal* 25:40, 42.
44. Cornfield emerald worth \$100,000. 1971. *San Diego Union*, May 17.
45. Ex-employee charged in gem theft. 1973. *San Diego Union*, Sept. 2.
46. Sterrett, D. B. 1911. Gems and precious stones. Chapter in *U.S. Geol. Sur. Min. Res. of the U.S. for 1910*, pp. 847-900.
47. Pratt, J. H. 1933. Gems and gem minerals of North Carolina. *American Mineralogist* 18:148-59.
48. Sterrett, D. B. 1910. Gems and precious stones. Chapter in *U.S. Geol. Sur. Min. Res. of the U. S. for 1909*, pp. 739-808.
49. Hess, F. L. and Stevens, R. E. 1937. A rare-alkali biotite from Kings Mountain, North Carolina. *American Mineralogist* 22:1040-44.
50. Brannock, K. C. 1967. 1966 collecting at the Foote Mineral Company's Kings Mountain, N.C., spodumene mine. *Rocks & Minerals* 42:403-6.
51. Kesler, T. L. 1961. Exploration of the Kings Mountain pegmatite. *Mining Engineering* 13:1063-68.
52. Kunz, G. F. 1894. A new locality of true emeralds. *American Journal of Science* 48:429-30.
53. ———. 1895. Precious stones. Chapter in *16th Ann. Rept. Dir. U.S. Geol. Survey*, pt. 4: *Min. Res. of the U.S. for 1894*, pp. 595-605.
54. Chapman, A. 1958. WNC emerald mines to be reopened. *Rocks & Minerals* 33:330-1.
55. Kunz, G. F. 1897. Precious stones. Chapter in *18th Ann. Rept. Dir. U.S. Geol. Survey*, Pt. 5: *Min. Res. of the U.S. for 1896*, pp. 1183-1217.
56. Pratt, J. H. 1898. Mineralogical notes on anthophyllite, enstatite and beryl (emerald) from North Carolina. *American Journal of Science* 5:429-32.
57. Merrill, G. P. 1899. Note on the gem mines of Mitchell County, North Carolina. Read before the Geological Society of Washington, D.C., Jan. 1899.
58. Trapp, F. W. 1968. The "Land of the Sky" and emeralds. *Lapidary Journal* 22:586, 588-92, 594-6.
59. Furbish, W. J. 1972. Unusual quartz inclusions in North Carolina emerald. *Gems & Gemology* 14:24-7.
60. Kunz, G. F. 1902. Precious stones. Chapter in *U.S. Geol. Sur. Min. Res. of the U.S. for 1901*, pp. 729-71.

BERYL LOCALITIES

South Carolina

Sloan stated that "good [beryl] crystals occur in the pegmatites in the southwestern portion, notably in Anderson County, where high-grade gems have been obtained."¹ However, in current times, no gem beryl is being produced and the mineral itself is rarely mentioned.

Cherokee County. "Occasional specimens of beryl are found in the monazite sands."¹

Greenville-Anderson Counties. "The monazite section adjacent to Pelzer, in Greenville and Anderson Counties, has furnished some fine specimens of aquamarine, beryl (and tourmaline)."¹

Anderson County. Almost emerald-green crystals were reported from a prospect on J. N. S. McConnell property, 5.1 km (3.25 mi) NNW of Anderson; the deposit was examined in 1913 by Sterrett but no beryl was reported.^{2,3} However, Schaller reported that 4.5 kg (10 lb) of pale blue beryl had been found here by McConnell.⁴ Yellowish crystals come from Fretwell prospects, 2.4 km (1.5 mi) W of Barnes,³ and blue-green and yellowish from J. J. Fretwell property on NE bank Savannah River about 0.4 km (0.25 mi) above the mouth of Big Generostee Creek.⁵

1. Sloan, E. 1908. Catalogue of the mineral localities of South Carolina. *South Carolina Geological Survey Bulletin* 2, ser. 4 (Columbia) 505 pp.
2. Sterrett, D. B. 1914. Gems and precious stones, Chapter in *U.S. Geological Survey Mineral Resources of the United States for 1913*, pp. 649-708.
3. ———. 1923. Mica deposits of the United States. *U.S. Geological Survey Bulletin* 740. 342 pp.
4. Schaller, W. T. 1916. Gems and precious stones, Chapter in *U.S. Geol. Sur. Min. Res. of the U.S. for 1915*, pp. 843-58.
5. Griffiths, W. R., and Olson, J. C. 1953. Mica deposits of the southeastern Piedmont, Part 7. Hartwell district, Georgia and South Carolina. Part 8. Outlying deposits in South Carolina. *U.S. Geological Survey Professional Paper* 248-E, pp. 293-325.

Georgia

Beryl as a gem mineral is mentioned in several places by McCallie,¹ common beryl by Galpin,² and by Furcron and Teague,³ the two latter authorities concerned primarily with pegmatite deposits of feldspar and mica. Sterrett described several mines with beryl.⁴ Later descriptions of deposits, some with beryl, noted in Griffiths and Olson⁵ and Heinrich.⁶ A summary of beryl occurrences may be found in Furcron.⁷ Some of the latter information is incorporated in Cook's *Minerals of Georgia*, 1978, the latest account.⁸ A popular summary of occurrences is in Willman.⁹

Fannin County. Small crystals, described as "emerald," up to 6 mm (0.25 in) diameter, were reported from Springer Mountain Mica mine, Chattahoochee National Forest.⁸

Rabun County. Blueish green, blue and yellow crystals occur in Beck Beryl mine, several km S of War Woman Creek;^{1,4,10} the locality is also given as 12 km (7.5 mi) SE of Clayton.^{3,7} Pale blue aquamarine occurs on W. T. Smith property, Moccasin district.^{1,7}

Habersham County. Transparent crystals came from Arrendale property, 2.3 km (1.4 mi) S of Batesville.⁶ Beryl may be found in pegmatite along Ga. Highway 197 about 8.4 km (5.2 mi) N of North Georgia Trade School.⁶

Stephens County. Blue crystals have been found in a field near Avalon School on J. F. Stowe property.^{7,8}

Franklin County. Olive-green crystals occur on McCannon property.⁷

Banks County. Yellow-green pieces have been found on J. T. Cheatham property, Ga. State Route 3, 8 km (5 mi) E of Commerce.⁷

Hart County. Crystals were found in a quarry from which stone was taken for Hartwell Dam.^{7,8} Gem crystals occur in Waterhole mine, on Martin Farm, 2.2 km (1.4 mi) SW of Crossroads.^{5,7} Greenish crystals appear in Taylor Mica mine, 1.9 km (1.2 mi) S 75° W of Crossroads.¹⁴ Beryl has been found in Hailey prospect, 5.5 km (3.5 mi) SW of Hartwell.⁴

Pickens County. Considerable common beryl has been mined from Bozeman (Jones) Mica mine, 4.8 km (3 mi) S 60° E of Tate; crystals up to 23 kg (50 lb), also large crystals nearby just E of Burleson mine.^{3,6,8} Gem quality aquamarine and golden beryl occur on R. H. Cook Farm, 6.4 km (4 mi) W of Tate in bed of Rock Creek; clear sections in crystals to 15 × 7.5 cm (6 × 3 in).¹¹ Common beryl occurs in Denson mines, 1.6 km (1 mi) S 60° E of Bethany Church;³ 710 kg (1567 lb) of ore beryl was sold from here between 1952-57.^{7,8} Pale green float crystals have been found on Austin Blan property, 0.64 km (0.4 mi) E of Denson mines.^{3,6,8} Beryl has been reported from J. L. Mulleneux prospect 2.6 km (1.6 mi) S 25° W of Talking Rock.^{7,8}

Cherokee County. Small common beryl crystals occur in Amphlett Mica mine, 0.64 km (0.4 mi) S 30° E of Conn Church or 7 km (4.3 mi) S 86° E of Ball Ground.^{6,8} Large ore beryl crystals were produced from Bennett Mica mine 9 km

World Sources of Ore and Gem Beryl / United States of America

(5.6 mi) S 85° W of Nelson but only a small quantity sold as ore.^{3,8} In 1933, Cochran Mica mine, 4 km (2.5 mi) N 60° E of Ball Ground, produced large well-formed common beryl prisms;^{3,6} production between 1952–57 amounted to 1843 kg (4064 lb); some crystals were excellent mineral specimens. Some ore beryl was produced at Hendrix Mica mine, near Ball Ground.^{7,8}

Forsyth County. Beryl occurs in pegmatite in cuts on Oscarville Road on N side of Silver Shoals Church.^{7,8}

Jackson County. Euhedral blue and green crystals occur to 10 cm (4 in) diameter in prospects and float around Harris School, 8.9 km (5.5 mi) E of Jefferson.^{7,8} Pegmatites along U.S. Highway 441, immediately N of Nicholson, contain small crystals approaching aquamarine in quality.^{7,8} Other sources are on W. R. Potts property, 0.4 km (0.25 mi) N of Harris School at Brockton⁸ and on M. F. Webb property, 8.9 km (5.5 mi) E of Jefferson.^{7,8}

Barrow County. Beryl occurs in pegmatite about 9.7 km (6 mi) SW of Jefferson.^{7,8}

Clarke County. Small yellow green gem quality crystals were found opposite the airport on Alps Road, near Athens; largest prism was only 3.7 cm (1.5 in) long.^{7,8}

Elbert County. Beryl occurs in Alexander and Chapman mines, 16 km (10 mi) N of Elberton by road.^{3,8} Crystals to 15 cm (6 in) diameter occur in Cooley Mica mines, Cooley Farm, 2.4 km (1.5 mi) W of Savannah River.^{3,8} Some crystals approaching gem aquamarine quality were found near Harmony Church, near Elberton.^{2,8} Beryl occurs in M. L. Gaines mine, 3.7 km (2.3 mi) SSE of Montevideo.^{5,8} Blue crystals, nearly gem quality, come from Dewy Rose.⁸ From near Rock Branch Church beryl has been found.⁷ Schaller noted blue crystals from near Antioch Hill mine and "several bushels" of deep blue crystals from near the Yellow Hill mine on N side of Little Broad River, about 4.8 km (3 mi) from Oglesby on the tracks of Seaboard Air Line Railroad.¹²

Oconee County. Sources of beryl are: Dickens Mica mine 5.6 km (3.5 mi) NW of High Shoals⁸ and Grady Thomas place (probably the D. S. Thomas Farm), 4.8 km (3 mi) NW of High Shoals.^{7,8}

Walton County. Float beryl crystals, some said to be gem quality, were picked up on G. C. Malcolm property near New Hope School.^{7,8}

De Kalb County. Small prisms in narrow peg-

matite veins are exposed in stone quarries at Arabia Mt. and on Rock Bridge Road between Bermuda and Macedonia Church.^{7,8}

Columbia County. Beryl occurs near the headwaters Little Kiokee Creek.⁸

Morgan County. Green, yellow crystals were found in a mica prospect on Adair Plantation just W of Appalachee; a perfectly clear crystal of 3.8 cm (1.5 in) was reported.^{7,8} Many small crystals occur in pegmatite in Carter prospect near Bostwick.^{6,8} Some ore beryl was mined from a pegmatite near bridge in High Shoals.^{7,8}

Spalding County. Fine pale blue gems of 1.5–2 carats were cut from float aquamarine found on T. J. Allen Farm, ca. 3.2 km (2 mi) E of Vaughn.^{2,6,7,8,13} Beryl was also reported from a point 4 km (2.5 mi) by road SW of Griffin.^{2,6}

Jasper County. Beryl is found in pegmatites NE of Hillsboro, in Parker Mica mine near Barron Fullerton home.^{7,8}

Lamar County. Green, yellow, blue crystals, nearly gem quality, have been found in pegmatites on J. T. Means and G. Dumas properties immediately W of Ramah Church.^{3,5,7,8} Common beryl occurs in Early Vaughn Mica mine, 9.7 km (6 mi) SE of Barnesville.^{3,5,7,8}

Monroe County. In the dumps of Battle and Chatfield mines, 4.4 km (2.75 mi) N 50° W of Colloden, beryl has been found.^{6,8}

Upson County. Localities and varieties are: dark green to blue crystals to 38 cm (15 in) long in Adams Mica mine, 4 km (2.5 mi) N 3° E of Yatesville;^{6,7,8} blue-green crystals to 10 cm (4 in) long in Blount No. 1 mine, 8 km (5 mi) E of Thomaston;^{6,8} Colbert Mica mine, 14.8 km (9 mi) N 65° E of Thomaston;^{6,8} Olive-green to blue crystals to 17.8 cm (7 in) diameter in Herron Mica mine, 0.4 km (0.25 mi) E of Yatesville;^{6,8} Stevens-Rock Mica mine, 6.4 km (4 mi) N 67° W of Yatesville;^{6,8} B. S. Gibson prospect, 5 km (3.1 mi) S 45° E of Thomaston.^{3,6,8}

Meriwether County. Pale green crystals, nearly gem quality, have been found on E. Strozzi property, Route 3, Greenville.^{7,8}

Troup County. Beryl is abundant in a number of granitic pegmatite bodies in this county and one of them, the Hogg, Foley, or Minerals Processing mine, contained the most important deposit of beryl in Georgia. This open-cut is located 12.9 km (8 mi) S of La Grange and 1.6 km (1 mi) W of Smith's Crossroads on the W side of Georgia Highway 219.¹⁵ Here the giant peg-

BERYL LOCALITIES

matite body strikes E-W and contains a quartz core (partly rose color) that is 95 m (320 ft) long and 15 m (50 ft) wide. In places it is surrounded by large beryl prisms partly imbedded in the core and partly in the pegmatite surrounding the core. It was originally opened for quartz and beryl, but some attempts were made to save scrap mica. Between 1952 and 1957, the U.S. Government purchased 78,200 kg (172,401 lb) of ore beryl.⁷ The latter occurred as well-formed prismatic crystals intergrown with quartz, tourmaline, and feldspar, with the largest crystals reaching 45 cm (1.5 ft) in diameter. Aquamarine occurred in areas large enough for faceted gems, which in color ranged from sky blue to a "smoky blue." Flawless gems up to 15 carats were capable of being cut. About 1,360 kg (3,000 lb) of gemmy material was produced. In addition, the rose quartz at times was of fine quality. Furcron and Chancey note that "this deposit has produced more deep colored star rose quartz to date than all other occurrences in Georgia."¹⁵

Elsewhere in the county, greenish beryl was found in excavations for the La Grange airport runways; also to the N of the airport.^{7,8} The Word or W. H. Allen beryl prospect produced common beryl crystals to 30.5 cm (12 in) diameter from a pegmatite body located 14.8 km (9 mi) S 34° W of La Grange;^{3,6,7,8} total production 470 kg (1,033 lb). A pegmatite body on Brown property, 0.97 km (0.6 mi) N of Smith's Crossroads produced about 272 kg (600 lb) of beryl.^{7,8} Small yellow crystals have occurred on L. M. Mulkey property, 8 km (5 mi) S of La Grange next to the Hogg mine.^{8,15} Other beryl sources are: in G. S. Stephens prospect, just S of Smith's Crossroads; close to Smith's Store;¹⁵ on A. H. Smith property (Casselwood), on Chattahoochee River, 10.7 km (6.65 mi) N 84° W of La Grange.⁸ Blue beryl occurs on W. Waugh property, 4.8 km (3 mi) N 15° E of La Grange.^{7,8} On S side of Youngs Mill Road, 0.8 km (0.5 mi) E of U.S. Highway 87 beryl also has been found.^{7,8}

1. McCallie, S. W. 1926. A preliminary report on the mineral resources of Georgia. Rev. ed. *Geological Survey of Georgia Bulletin 23* (Atlanta) 164 pp.
2. Galpin, S. A. 1915. A preliminary report on the feldspar and mica deposits of Georgia. *Geol. Sur. of Georgia Bull.* 30. 190 pp.
3. Furcron, A. S., and Teague, K. H. 1943. Mica-bearing pegmatites of Georgia. *Geol. Sur. of Georgia Bull.* 48. 192 pp.
4. Sterrett, D. B. 1923. Mica deposits of the United States. *U.S. Geological Survey Bulletin 740.* 342 pp.

5. Griffiths, W. R., and Olson, J. C. 1953. Mica deposits of the southeastern Piedmont. Part 7. Hartwell district, Georgia and South Carolina. Part 8. Outlying deposits in South Carolina. *U.S. Geological Survey Professional Paper 248-E*, pp. 293-325.
6. Heinrich, E. W.; Klepper, M. R.; and Jahns, R. H. 1953. Mica deposits of the southeastern Piedmont. Part 9. Thomaston-Barnesville district, Georgia. Part 10. Outlying deposits in Georgia. *U.S. Geol. Sur. Prof. Paper 248-F*, pp. 327-400.
7. Furcron, A. S. 1959. Beryl in Georgia. *Georgia Mineral Newsletter*. (Atlanta) 12:91-5.
8. Cook, R. B. 1978. Minerals of Georgia: Their properties and occurrences. *Georgia Geologic and Water Resources Division Bulletin 92* (Atlanta) 189 pp.
9. Willman, L. D. 1963. *Gem and Mineral Localities of Southeastern United States*. Jacksonville, Ala.: privately published. 97 pp.
10. Sterrett, D. B. 1911. Gems and precious stones. Chapter in *U.S. Geological Survey Mineral Resources of the United States for 1910*, pp. 847-900.
11. Furcron, A. S. 1953. Aquamarine prospect, Pickens County, Georgia. *Georgia Mineral Newsletter* 6:40-41.
12. Schaller, W. T. 1916. Gems and precious stones. Chapter in *U.S. Geol. Sur. Min. Res. of the U.S. for 1915*, pp. 843-58.
13. Sterrett, D. B. 1915. Gems and precious stones. Chapter in *U.S. Geol. Sur. Min. Res. of the U.S. for 1914*, pp. 307-46.
14. Lesure, F. G. 1962. Geology of the Taylor mica mine, Hart County, Georgia. *Georgia Mineral Newsletter* 15:9-14.
15. Furcron, A. S. and Chancey, C. N. 1954. The Minerals Processing Company mine and other beryl deposits in Troup County, Georgia. *Georgia Mineral Newsletter* 7:140-4.

Alabama

Cleburne County. Beryl occurs in the Jim Flemming Mica mine, 8 km (5 mi) almost due N of Pinetucky; and on the W. H. Howle property near Heflin.^{1,2}

Randolph County. Many pale green fragments, some of gem quality, are found on dumps of Pat Ayers No. 2 mine, 3.6 km (2.25 mi) NNE of Pinetucky.²

Clay County. The J. J. Smith No. 1 mine, 4.3 km (2.7 mi) NNW of Delta is said to have been mined by Indians for beryl for use in ornament; crystals have been reported to 30.5 × 20 cm (12 × 8 in).^{1,2}

Coosa County. Sterrett examined golden beryl and aquamarine pegmatites on J. H. Thomas place, 1.6 km (1 mi) NE of Hissop, also on Eliza Goggins place, 1.2 km (0.75 mi) SW of Hissop and on the S. Wade place adjoining.³ The Thomas deposit is described by Clark,⁴ Sterrett,⁵ and Heinrich and Olson.² White, greenish brown, and

World Sources of Ore and Gem Beryl / United States of America

yellow crystals containing considerable gem material, in sizes to 120 × 60 cm (4 × 2 ft) have been reported from this county.⁶

1. Pallister, H. D. 1953. Beryl in Alabama. *Alabama Academy of Sciences Journal* (Birmingham) 25:42-4.
2. Heinrich, E. W., and Olson, J. C. 1953. Mica deposits of the southeastern Piedmont. Part 11. Alabama district. *U.S. Geological Survey Professional Paper 248-G*, pp. 401-462.
3. Sterrett, D. B. 1915. Gems and precious stones. Chapter in *U.S. Geological Survey Mineral Resources of the United States for 1914*, pp. 307-46.
4. Clark, G. H. 1921. Mica deposits of Alabama. *Geological Survey of Alabama Bulletin 24* (University), 115 pp.
5. Sterrett, D. B. 1923. Mica deposits of the United States. *U.S. Geological Survey Bulletin 740*, 342 pp.
6. [Beryl in Alabama]. 1963. *Mining World* 25, no. 6, p. 40.

Missouri

Colorless to faintly blue common beryl, massive and in prisms to 5 cm (2 in) long occurs in pegmatite in Sheahan quarry, Graniteville, Iron County. R. I. $\sigma = 1.578 \pm 0.002$, $e = 1.571 \pm 0.002$; $G = 2.682 @ 24^\circ/4^\circ$.¹

Table 14-51

ANALYSIS, GRANITEVILLE, MISSOURI BERYL¹

	Percent	Percent	Percent	Percent	
SiO ₂	65.23	BeO	13.39	K ₂ O	0.01
Al ₂ O ₃	17.99	MgO	0.06	H ₂ O (ign.)	1.20
Fe ₂ O ₃	0.96	CaO	0.03	H ₂ O	0.03
FeO	0.57	Na ₂ O	0.52	Total	99.99

1. Tolman, C., and Goldich, S. S. 1935. The granite, pegmatite and replacement veins in the Sheahan quarry, Graniteville, Missouri. *American Mineralogist* 20:229-39.

South Dakota

Large quantities of ore beryl and some mineral specimen and gem beryl have been produced from numerous granitic pegmatites in the Black Hills which lie in the SW corner of the state. Details on geology appear in Connolly and O'Hara¹ and are summarized in Page et al.² In brief, the hills are sculptured remnants of a dome-like uplift whose core is granite and whose flanks are covered with metamorphic rocks which gradually change outward to sedimentary rocks. Pegmatites occur in the granite and in the metamorphic rocks along the fringes.

In 1914, 6 tons of ore beryl were produced, the first recorded production, and during 1914-1944 a total of 1,535 tons valued at \$126,466 were mined.² Production during 1948-1958 raised the total to 2,681 tons valued at \$1,156,000,³ for a grand total for 1914-1958 of 4,216 tons valued at \$1,282,466. However, later figures by Norton gave the total up to 1963 as 4,964 tons valued at \$1,654,260.⁴ Large reserves of small-size beryl are known, and milling, followed by flotation, was tried to determine effective recovery of beryl that could not otherwise be hand-sorted economically.⁵

In regard to the pegmatites themselves, their geology, mineralogy and internal features are best described by Page et al.,² who provide special remarks on beryl-bearing types and the mineralogy of beryls. On the whole, most of the large bodies examined are zoned, with by far most beryl occurring in intermediate zones and generally in those bodies that are mineralogically simple. Beryl also occurs in deposits that appear to be pegmatitic quartz veins containing mostly quartz with muscovite, some beryl and cassiterite, and associates in other vein types that also include wolframite and huebnerite, especially in the Hill City district.

There are many hundreds of bodies, a large number containing small amounts of beryl and only relatively few that carry enough to make mining for this mineral alone feasible. Page et al. also listed deposits known to have produced beryl during 1943-44, of which there are 47 in the Custer district, 3 in Hill City district, 13 in Keystone district, and 5 various. Many more deposits are listed in Tullis.⁶

Beryl crystals range in size from minute to giants that as early as 1883 had impressed Blake, who compared them to the enormous individuals found at Acworth, New Hampshire.⁷ Fisher recorded a crystal of 5.9 × 1.2 m (19 × 4 ft),⁸ Waldschmidt noted one of 1.2 m (4 ft) in diameter in the Bob Ingersoll mine,⁹ while about 1912, Scott found in his rose quartz mine a single crystal that was 6 × 1 m (20 × 3 ft).¹⁰ Perhaps the largest recorded crystal was found in the Bob Ingersoll body in 1933. It measured 2.5 m (8 ft) in diameter between opposite prism faces, but a total length could not be determined because much of it had been mined away.¹¹ However, such large crystals are uncommon, and the majority fall below about 25 × 5 cm (10 × 2 in). Much infor-

BERYL LOCALITIES



Fig. 14-73 Sketch map showing granitic pegmatite districts in the Western United States. Modified, with additions, after E. N. Cameron et al., *Economic Geology Monograph 2*, (Urbana, 1949).

World Sources of Ore and Gem Beryl / United States of America

mation on localities is available in references already cited, but a general article by Stobbe and the detailed and accurate descriptions of many localities for minerals of the Black Hills by Roberts and Rapp are noteworthy.^{12,13} Areal studies including pegmatites are found in Lang and Redden,¹⁴ Redden,^{15,17} Staats,¹⁶ and Fisher.¹⁸ An index map showing 166 deposits, many containing beryl, is in Page et al.²

Lawrence County. Beryl has been reported in Rough and Ready mine¹⁹ and in Tin Mountain mine.^{20,21}

Pennington County. Sources of beryl are: Hardesty mine, 4 km (2.5 mi) NW of Keystone; Bob Ingersoll mine, 3.2 km (2 mi) NW of Keystone, featuring enormously large crystals of common beryl, and blue and pink crystals with lepidolite;^{2,11,13} Dan Patch mine, 1.6 km (1 mi) W of Keystone, where a 26 ton crystal and "excellent specimens of greenish-white beryl enclosing sphalerite" have been found;¹³ Sitting Bull mine, 1.6 km (1 mi) NW of Keystone, with white crystals to 25 cm (10 in) diameter;^{2,13} Peerless mine, 0.8 km (0.5 mi) S of Keystone, contains beryl in a complex pegmatite with some crystals to 1.25 m (50 in) long and colorless, white, yellowish or greenish; R. I. $\rho = 1.574-1.587$; "shell" crystals have also been found.^{13,22} Hugo mine, 1.6 km (1 mi) S of Keystone, has crystals to 0.9 m (3 ft) diameter; many prisms are tapered and some zoned in "shell" types with inclusions of other pegmatite species; R. I. $\rho = 1.578-1.588$, and in inner zone 1.577-1.590, with colors ranging from yellowish white or pale green to white and pale pink from inner zones of the pegmatite.^{13,23} Etta mine, 1.6 km (1 mi) S of Keystone, contains white beryl.^{13,24,25} White Cap mine, 1.6 km (1 mi) SSE of Keystone, had crystals to 60 cm (2 ft) diameter.^{2,13} Wood Tin mine, 5.2 km (3.25 mi) ESE of Keystone, produced white crystals to 60 cm (2 ft) diameter.¹³ Ferguson Lode claim, 0.8 km (0.5 mi) NW of Wood Tin mine, is a source for white beryl crystals to 15 cm (6 in) diameter.¹³ Eureka mine, 4 km (2.5 mi) SE of Keystone, had glassy green crystals to 7.7 cm (3 in) diameter.^{13,26} Other beryl sources are: Glendale mine, 4.5 km (2.5 mi) SE of Keystone; Big Chief mine, 0.8 km (0.5 mi) S of Glendale, with common beryl and crystals cemented along fractures with pyrite;¹³ Mohawk mine, 0.8 km (0.5 mi) W of Hill City; Tin Queen mine, 7 km (4.5 mi) S of Hill City, contains common beryl, some

altered to sericite;^{2,13} Dyke mine, 4.8 km (3 mi) SSE of Keystone, white crystals to 2.4 × 0.9 m (8 × 3 ft).¹³

Custer County. Beryl occurs here in: High Climb mine, 9.5 km (6 mi) almost due N of Custer;^{2,18,27} Wilhelm mine, 8.4 km (5.3 mi) NNW of Custer;² Old Mike mine, 5.5 km (3.5 mi) N of Custer, with common beryl prisms to 30.5 cm (12 in);^{8,13} Crown mine, 4 km (2.5 mi) NW of Custer, having "superb white to pale green doubly terminated short prismatic crystals . . . to 5 inches diameter" and unusual tapering crystals;^{2,13,28} Custer Mica lodes, 2.9 km (1.8 mi) NE of Custer;² large crystals in Victory mine 3.2 km (2 mi) NE of Custer;^{2,13} Climax mine, 3.2 km (2 mi) ESE of Custer;² Highland Lode (John Ross) mine, 6.3 km (4 mi) W of Custer, with crystals to 2.4 × 1.2 m (8 × 4 ft);^{2,8,13} Custer Mountain mine, 2.4 km (1.5 mi) ESE of Custer; Dorothy V. mine, 2.7 km (1.7 mi) W of Custer, with "light green beryl crystals free of inclusions with an average diameter of 1½ inches";^{2,13} White Spar mine, 1.6 km (1 mi) SW of Custer, with crystals to 60 × 20 cm (24 × 8 in).^{2,13,28} Beryl may also be found at Hot Shot mine, 7.1 km (4.5 mi) ESE of Custer and a little farther on at the Elkhorn mine, where light green crystals, partly gemmy, occur.^{2,13,16} Buster Dike mine, 4 km (2.5 mi) SSW of Custer has crystals to 12.5 cm (5 in) enclosing quartz, muscovite, cleavelandite and garnet.^{2,8,13} Other sources for beryl are: Rocky Ridge mine, 5.8 km (3.7 mi) SW of Custer; Silver Dollar mine, 4.2 km (2.6 mi) almost due S of Custer;² Scott or Rose Quartz mine, 8.8 km (5.5 mi) SE of Custer, noted for production of handsome rose quartz from a large quartz core. This deposit was discovered in 1902 by Samuel Scott and worked almost continuously since then; at times very large crystals of common beryl were found.^{2,10} Enormous crystals occur in the Beecher mine, 7.1 km (4.5 mi) S of Custer.^{2,13,18,29} Bottle green crystals to 6.3 cm (2.5 in) diameter from Wonder Lode mine, 1.6 km (1 mi) W of Mayo School and 9.5 km (6 mi) S of Custer, yielded flawless faceted gems to 3 carats.¹³

Mountain Beryl mine, 3 km (1.9 mi) NW of Pringle, provided crystals to 120 × 45 cm (48 × 18 in).^{2,13} Green mine, 4 km (2.5 mi) NE of Pringle, produced crystals to 180 × 38 cm (72 × 15 in).^{2,13} At Tin Mountain mine, 9.7 km (6.1 mi) WSW of Custer, white to pale pink crystals to 3 × 1 m (10 × 3 ft) were mined in 1961.^{2,13,30}

BERYL LOCALITIES

Other mines for beryl are: Warren Draw mine, 9.5 km (6 mi) WSW of Custer; Dubuque and Royal Flush claims, 9.3 km (5.9 mi) WSW of Custer;^{2,13} Big Tom mine, 8 km (5 mi) S 61° W of Custer;^{2,12,13} Tip Top mine, 8 km (5 mi) SW of Custer, where "shell" crystals have been found;¹³ Helen Beryl mine, 9.6 km (6 mi) SW of Custer, crystals in many colors, "shell" types, and white to pale yellowish green prisms to 30.5 × 20.5 cm (12 × 8 in) sometimes with cores of facet material from which flawless gems to several carats were cut;^{2,13,16,31,32} New York mine, 9.5 (6 mi) SW of Custer, with "shell" crystals;^{2,13,28} Michaud Beryl mine, 10.5 km (6.5 mi) SW of Custer;^{2,13} Red Spar mine, 13 km (8.2 mi) SW of Custer.²

1. Connolly, J. P., and O'Harra, C. C. 1929. The mineral wealth of the Black Hills. *South Dakota School of Mines Bulletin* 16, 418 pp.
2. Page, L. R. et al. 1953. Pegmatite investigations 1942-1945 Black Hills, South Dakota. *U.S. Geological Survey Professional Paper* 247, 228 pp.
3. Norton, J. J. et al. 1964. Geology and mineral deposits of some pegmatites in the southern Black Hills, South Dakota. *U.S. Geol. Sur. Prof. Paper* 297-E, pp. 293-341.
4. Norton, J. J. 1964. Pegmatite minerals. In: *Mineral and Water Resources of South Dakota*. Report prepared by U. S. Geological Survey and Others. (Rapid City), pp. 112-33.
5. Runke, S. M., and Riley, J. M. 1957. Progress report on pegmatite investigations in South Dakota for fiscal years 1954-56. *U.S. Bureau of Mines Report of Investigations* 5339, 18 pp.
6. Tullis, E. L. 1952. Beryl resources of the Black Hills, South Dakota. *U.S. Bureau of Mines Report of Investigations* 4855, 19 pp.
7. Blake, W. P. 1883. Cassiterite, spodumene and beryl in the Black Hills, Dakota. *American Journal of Science* (New Haven) vol. 26, ser. 3, no. 153, p. 235.
8. Fisher, D. J. 1945. Preliminary report on the mineralogy of some pegmatites near Custer. *South Dakota Geological Survey Report of Investigations* 50, pp. 1-92.
9. Waldschmidt, W. A. 1919. The largest known beryl crystal. *Pahasapa Quarterly*, 9:4-16.
10. Scott, E. M. 1941. Scott rose quartz mine. *Rocks & Minerals Magazine* (Peekskill, N.Y.) 16:360-3.
11. Ziegler, V. 1914. The mineral resources of the Harney Peak pegmatites. *Mining and Scientific Press* (San Francisco) 108:604-8.
12. Stobbe, H. 1937. A brief description of the pegmatites southwest of Custer, South Dakota. *Economic Geology* (Lancaster, Pa.) 32:964-73.
13. Roberts, W. L., and Rapp, G. 1965. Mineralogy of the Black Hills. *South Dakota School of Mines and Technology Bulletin* 18 (Rapid City) 268 pp.
14. Lang, A. J., and Redden, J. A. 1953. Geology and pegmatites of part of the Fourmile area, Custer County, South Dakota. *U.S. Geological Survey Circular* 245, 20 pp.
15. Redden, J. A. 1968. Geology of the Berne quadrangle, Black Hills, South Dakota. *U.S. Geological Survey Professional Paper* 297-F, pp. 343-408.
16. Staatz, M. H. et al. 1963. Exploration for beryllium at the Helen Beryl, Elkhorn and Tin Mountain pegmatites, Custer County, South Dakota. *U.S. Geol. Sur. Prof. Paper* 297-C, pp. 129-97.
17. Redden, J. A. 1963. Geology and pegmatites of the Fourmile quadrangle, Black Hills, South Dakota. *U.S. Geol. Sur. Prof. Paper* 297-D, pp. 199-291.
18. Fisher, D. J. 1942. Preliminary report on some pegmatites of the Custer district. *S. D. Geol. Sur. Rept. of Invest.* 44 (Vermillion) 35 pp.
19. Smith, W. C., and Page, L. R. 1941. Strategic minerals investigations 1940: tin-bearing pegmatites of the Tinton district, Lawrence County, South Dakota. *U.S. Geol. Surv. Bull.* 922, pp. 595-630.
20. Hess, F. L., and Bryan, B. 1938. The pegmatites at Tinton, South Dakota. *U.S. Bureau of Mines Rept. Invest.* 3404, 19 pp.
21. Smith, A., and Roberts, W. L. 1964. Tin Mountain pegmatite mine, Custer County, South Dakota. *Rocks & Minerals* 39:565-8.
22. Sheridan, D. M. et al. 1957. Geology and beryl deposits of the Peerless pegmatite, Pennington County, South Dakota. *U.S. Geol. Sur. Prof. Paper* 297-A, 47 pp.
23. Norton, J. J.; Page, L. R.; and Bropst, D. A. 1962. Geology of the Hugo pegmatite, Keystone, South Dakota. *U.S. Geol. Sur. Prof. Paper* 297-B, pp. 49-127.
24. Schwartz, G. M. 1925. Geology of the Etta spodumene mine, Black Hills, South Dakota. *Economic Geology* 20:646-59.
25. Smith, A. 1963. Minerals from the Etta mine. *Rocks & Minerals* 38:453-6.
26. Roadifer, R. E. 1954. Geology of the Eureka pegmatite, Pennington County, South Dakota. *U.S. Geol. Sur. Open File Report No.* 273, 29 pp.
27. Sheridan, D. M. 1955. Geology of the High Climb pegmatite, Custer County, South Dakota. *U.S. Geol. Sur. Bull.* 1015-C, pp. 59-98.
28. Sterrett, D. B. 1923. Mica deposits of the United States. *U.S. Geol. Sur. Bull.* 740 342 pp.
29. Redden, J. A. 1959. Beryl deposits of the Beecher No. 3-Black Diamond pegmatite, Custer County, South Dakota. *U.S. Geol. Sur. Bull.* 1071-I, pp. 537-59.
30. Schwartz, G. M. 1930. The Tin Mountain spodumene mine, Black Hills, South Dakota. *Economic Geology* 25:275-84.
31. Gries, J. P. 1949. Sampling of the Helen Beryl pegmatite, Custer County, South Dakota. *U.S. Bureau of Mines Rept. Invest.* 4396, 14 pp.
32. Lisle, T. O. 1949. Beryl location in South Dakota. *Rocks & Minerals* 24:397.

Montana

Very few pegmatite deposits of beryl are known. Heinrich notes that he "has not found any beryl in the numerous pegmatites examined" [by him].¹ In another reference he says, "the general absence of beryl is characteristic of the exterior pegmatites," here referring to those bodies

World Sources of Ore and Gem Beryl / United States of America

intruded outside the margins of the granitic batholiths of this state.²

Cascade County. Beryl was found in San Miguel pegmatites near Monarch, SE of Great Falls.²

Mineral County. A. H. Welling reported finding beautifully colored emeralds of good quality, similar to those of Chivor, at some undisclosed locality near Superior; most of the crystals were said to be opaque but some had clear green portions;³ unconfirmed.

Madison County. "A few small crystals of green beryl have been found in the Big Chief mine and in one or more of the White Swan pegmatites."⁴ The Big Chief mine is 10 km (6.3 mi) NE of Sheridan and the White Swan group 11 km (7 mi) NNE of Virginia City.

Beaverhead County. Colorless to blue, slender prisms not more than 38 mm (1.5 in) long and several mm thick occur in contact-metamorphic zone of Red Buttons tungsten mine. Calvert Creek, SE ¼ Sec 12, T 1 N, R 13 W.⁵

1. Heinrich, E. W. 1949. Pegmatite mineral deposits in Montana. *Montana Bureau of Mines and Geology Memoir 28* (Butte) 56 pp.
2. ———. 1949. Pegmatites of Montana. *Economic Geology* (Lancaster, Pa.) 44:307-35.
3. A. H. Welling finds valuable emerald deposits near Superior, Montana. 1963. *California Mining Journal* (Sacramento) 33, no. 2, p. 7.
4. Stoll, W. C. 1950. Mica and beryl pegmatites in Idaho and Montana. *U.S. Geological Survey Professional Paper 229*. 64 pp.
5. King, R. H. 1966. Beryl in Montana tectite body. *American Mineralogist* 51:502-3.

Wyoming

Converse County. Beryl occurs in granitic pegmatite near Jasper mine, Douglas district.^{1,2} A few crystals were found in Schundler-Glenrock feldspar quarry S of Glenrock.²

Goshen County. Ball found beryl in Crystal Palace Mica mine in Haystack Range district, 16 km (10 mi) NE of Guernsey;³ also blueish green beryl in the Savage claim and crystals to 120 cm (4 ft) long in a pegmatite claim in center of Sec 35, T 28 N, R 65 W. In the same area, beryl was also found in the Minnie claim, New York claim, Torrington No. 1 claim, and elsewhere.² Hanley et al. limited this field to the area between Whalen Canyon (W), Cottonwood Canyon (E), McCanns Pass (N) and along an E-W line through Haystack Peak (S) and also reported beryl in the Denver, Chicago and Ruth prospects.⁴

Albany County. The Many Value pegmatite mine, SE ¼ Sec 32, T 13 N, R 78 W, produced 2 tons of ore beryl up to 1942 as corroded, pale blueish green or white crystals.^{2,4}

Carbon County. Some aquamarine has been reported from the SE part of Seminoe Range.¹

Natrona County. Catherine No. 1 mine produced 2 short tons ore beryl in 1956.²

Fremont County. McLaughlin describes simple and complex granitic pegmatites from the NE part of the county in an area centered about 24 km (15 mi) NNE of Shoshoni.⁵ The bodies intrude a fine-grained schist and those that appear younger are zoned and more complexly mineralized: feldspars, quartz, lepidolite, petalite, amblygonite, cleavelandite, tourmaline, braunite, apatite, beryl, columbite-tantalite, garnet, chalcopyrite, etc. Beryl is associated with lepidolite and muscovite and occurs in light green to pale blue elongated prisms to 20 cm (8 in) in diameter; a few crystals contained gemmy aquamarine areas. Beryl was produced in Whippet No. 1 and No. 8 prospects, and sold from the No. 1 between 1928-42.^{2,4}

1. Osterwald, F. W. and Osterwald, D. B. 1952. Wyoming mineral resources. *Wyoming Geological Survey Bulletin 45* (Laramie) 215 pp.
2. Osterwald, F. W.; Osterwald, D. B.; Long, J. S.; and Wilson, W. H. 1959. Mineral resources of Wyoming. *Geological Survey of Wyoming Bulletin 50*. 259 pp.
3. Ball, S. H. 1907. Mica in the Hartville uplift, Wyoming. *U.S. Geological Survey Bulletin 315*, pp. 423-5.
4. Hanley, J. B.; Heinrich, E. W.; and Page, L. R. 1950. Pegmatite investigations in Colorado, Wyoming and Utah, 1942-1944. *U.S. Geological Survey Professional Paper 227*. 125 pp.
5. McLaughlin, T. G. 1940. Pegmatite dikes of the Bridger Mountains, Wyoming. *American Mineralogist*, 25:46-68.

Colorado

Granitic pegmatites, some beryl-bearing, occur in Precambrian schists, gneisses, and igneous rocks throughout the Rocky Mountain region, with the largest number in a belt about 280 km (155 mi) long and 635 km (40 mi) wide, oriented N-S in the Front Range. The bodies are simple to complex, many are zoned, and range in size from mere stringers to some that are 2 km or more in length.¹ Pegmatite districts are shown on maps in Hanley,¹ Williamson,² and Galbraith.³ Brief descriptions of pegmatite features for a number of districts are given in Landes⁴ and Heinrich and Bever.⁵ Galbraith provides a list of occurrences

BERYL LOCALITIES

in 22 districts.³ Despite its common occurrence, beryl production has been modest, ranging annually from less than 100 tons to almost twice that figure during periods when a demand for ore beryl existed. Most of the production came from only several, particularly rich bodies. Some gem beryl has been found at times and also excellent mineral specimens, notably from the Mount Antero deposits in Chaffee County. Specific locality information on minerals may be found in Eckel⁶ and Pearl,⁷ the latter with field trip directions.

Larimer County. Beryl deposits occur in the Crystal Mountain district, which comprises townships 6 N and 7 N, Range 71 W and part of R 72 W, or centered ca 24 km (15 mi) WSW of Fort Collins; the N limit is due W of that city and the S limit is near Drake of about 22 km (14 mi) due W of Loveland. Beryl is in mica pegmatites of Buckhorn area, 27 km (17 mi) S 75° W of Ft. Collins⁸ and in Hyatt Ranch pegmatites.⁹ In this district Argall listed 10 beryl mines,¹⁰ Hanley et al. listed 12,¹¹ but Thurston mapped and described more than 1300 pegmatite bodies in the Hyatt Ranch area, N of the Big Thompson River, of which 350 were found to contain some beryl.¹² Wisdom Ranch prospect, 24.5 km (15.5 mi) W of Ft. Collins, produced 15 tons of mixed beryl and chrysoberyl, the last in tabular crystals 0.8 cm (0.5 in) thick and several cm across, also blueish beryl crystals to 20 cm (8 in) diameter. Beryl occurs in Tantalum prospect, 4.8 km (3 mi) NNE of Crystal Mountain; in Beryl No. 5, Mica Beryl and Humphrey Beryl prospects on Humphrey Ranch, Crystal Mt. area, ca 28 km (17.5 mi) WSW of Ft. Collins. Just E of Crystal Mt. white to light green masses of common beryl occur to 23 cm (10 in) diameter or as corroded crystals in Buckhorn (Emerald Gem claim), and nearby in Double Opening prospect, noted for "shell" crystals containing cores of albite-quartz up to 15 cm (6 in) diameter.¹¹ Pale green, blue, yellow crystals to 15 cm (6 in) diameter occur in Crystal Silica prospect 0.8 km (0.5 mi) W of Crystal Mountain. The Big Boulder prospect, 1.6 km (2 mi) SE of Crystal Mt. produced 10.5 tons or ore beryl from one crystal in 1936; a prism noted here measured 2.2 m (7 ft) long and 1.53 m (5.5 ft) in diameter and was tapered toward both ends; this deposit contains an estimated reserve of 450 tons of ore beryl.¹¹ Lewis Beryl prospect, S slope Storm Mountain, is ca 6.3 km (4 mi) NW of Drake. The Hyatt Ranch Beryl mine,

on Fred Hyatt Ranch, is about 2.35 km (1.5 mi) NNW of Drake, and recorded production is of at least 70 tons of ore beryl,¹¹ although Thurston gave a figure of about 49 tons for the period 1936–1948, with an estimated reserve of 2,000 tons for the district as a whole.¹²

Boulder County. Beryl may be found in Beryl No. 1 and No. 2 prospects, T 1 N, R 71 W, sections 5 and 6, in the Sunshine district.¹⁰ It also occurs in Beryl Lode (Lehman) and New Girl mines in Left Hand Creek district, about 11 km (7 mi) NNW of Boulder.¹¹

Grand County. Crystals to about 1 m long occur on Green Ridge, a short distance N of junction of Arapahoe Creek with Colorado River; also at a place called Highlonesome, located just S of a small lake at headwaters of Meadow Creek or about 6.3 km (4 mi) due S of Monarch Lake.^{6,13}

Clear Creek County. Blue and green crystals occur in Santa Fe Mountain Beryl prospect, about 4.8 km (3 mi) SE of Idaho Springs; in Brandt Beryl-Topaz prospect (Beaver Brook prospect) on S margin Beaver Brook valley, ca 7.1 km (4.5 mi) SE of Idaho Springs. Pale green crystals to 60 × 20 cm (24 × 8 in) occur in Grover mine on N side of the valley. Eckel mentions hundreds of greenish blue, pale blue, cloudy aquamarine crystals to 15 cm (6 in) long, loose in soil, from the Floyd Hill Beryl pegmatite.⁶

Summit County. Small crystals are found in Monte Cristo prospect, on the S slope of Quandary Peak above Monte Cristo Gulch.^{10,11}

Jefferson County. Here beryl occurs in: Roscoe Beryl prospect in the wall of Clear Creek Canyon, ca 12 km (8 mi) W of Golden;^{6,11} Centennial Cone Beryl-Monazite prospect 11 km (7 mi) W of Golden, where crystals to 50 × 10 cm (20 × 4 in) occur in complex pegmatite noted for rare-element minerals and several alteration products of the beryl.^{6,11,14} Beryl pegmatites outcrop in Cressman Gulch, Swede Gulch, and along Van Bibber Creek.^{6,10} The Bigger mine, ca 14 km (9 mi) SW of Morrison, contained beryl in crystals to 46 cm (18 in) diameter but later mining uncovered others even larger.⁸ Eckel mentions pale, greenish blue or greenish crystals to about 3 × 1 m (10 × 3 ft); well-formed bertrandite crystals were found on some altered beryl crystals.⁶

Park County. The Badger Flats beryllium deposits, ca 16 km (10 mi) NW of Lake George, are greisen-type veins, pipes, and irregular

World Sources of Ore and Gem Beryl / United States of America

masses containing quartz, muscovite, topaz, fluorite, betrandite, euclase, arsenopyrite, wolframite, molybdenite, galena, and sphalerite.^{15,16} Similar deposits outcrop in nearby Redskin Gulch. These were the largest producers of beryl in the U.S.A. in 1959. Beryl occurs as anhedral-subhedral grains to 25 mm (1 in) in diameter while well-formed crystals occur in siderite matrix or in small vugs, but these are usually less than 5 cm (2 in) long.^{6,7} Bright blue to olive-yellow common beryl crystals, generally to about 25 cm (10 in) diameter, occur in Meyers Ranch mine, 24 km (15 mi) SW of Guffey, but one crystal was large enough to have produced 11 tons alone; total production was 25 tons.^{7,11} Beryl is also found in Rose Dawn Mica mine, ca 0.4 km (0.25 mi) E of Mac Gulch very close to the border with Fremont County. In the Beryllium Lode prospect, on W side of Mac Gulch, pale blue crystals to 1.5 m (5 ft) long and 20 cm (8 in) diameter, have been found.

Lake County. One locality is listed by Argall.¹⁰

Teller County. Small crystals appear in Black Cloud pegmatite 3.7 km (2.3 mi) W of Divide.¹⁷

Chaffee County. This region is insignificant in terms of ore beryl, but the small area containing beryl deposits upon the Mount Antero-White Mountain granitic stock, near their summits, is a classic mineral collecting locality. While some of the bright blue aquamarine crystals found here provide gems, by far their greatest value lies in the beauty and perfection of the crystals and their associated minerals.

Mount Antero (4,432 m or 14,245 ft) and adjacent White Mountain (4,267 m or 13,900 ft) lie about 13 km (8 mi) W of Nathrop or 24 km (15 mi) NW of Salida, with the collecting areas now accessible via a steep vehicular road. Kunz remarked on the discovery of aquamarines in 1885, and noted that one crystal of 10 × 0.1 cm (4 × 0.36 in) contained gemmy areas and that smaller crystals had also been found;¹⁸ he compared them to the aquamarines of Mourne Mountains, Ireland. According to Cross, the discovery had been made by N. D. Wanamaker in 1885, and he further noted the habit of the crystals and the presence of small phenakite crystals.¹⁹ Work at the locality in 1888 succeeded in uncovering about 100 crystals, some with clear areas providing cut gems to 12 carats. The entire lot was valued at \$600-\$700.²⁰ Hills described etch fig-

ures and several associated minerals,²¹ while Penfield noted the predominance of crystal forms of *m* and *c* but also found {1120}, {2130}, the rare steep bipyramids {36.24.60.5} and {6.6.12.1}, and an etched bipyramid identified as {2021}.²²

During 1909-1910 the locality was worked with considerable success by J. D. Endicott, a Colorado collector and mineral dealer, according to Sterrett.²³ Thereafter little was accomplished until collecting was resumed by Over in 1928 and carried on intermittently for several years afterward.²⁴ Over worked alone or was sometimes joined by Montgomery.^{25,26} The first adequate mineralogical description of the deposits was provided by Switzer as a result of an extended visit.²⁷ A nearby beryl occurrence in pegmatite containing molybdenite on White Mountain was described in 1934 by Landes,²⁸ and more fully by Adams in 1953.²⁹ The best recent account of the Mount Antero deposits is by Jacobson.³⁰

The Mount Antero granite pluton is of Oligocene age and consists of intruded Precambrian gneisses and Paleozoic rocks.³¹ The beryls and other interesting species occur in openings of miarolitic character in pegmatitic phases, which often take the form of veins in the granite. A total of 33 species have been identified, including feldspars, colorless and smoky quartz, muscovite, beryl, sulfides, a number of rare-element species, and phenakite, the latter occurring in unusually fine crystals.³⁰ Beryl occurs frozen in matrix and only the crystals found in the vugs are in good quality. These may be single prisms or divergent groups, and often crystals corroded more or less severely. Switzer noted that the largest crystal found by Over in 1932 was 20 × 3.5 cm (7.9 × 1.4 in), gemmy in part, but the average was much smaller, generally not over several cm (ca 1 in) long.²⁷ An outstanding feature is the fine blue color of many of the crystals, reminiscent of the best hue of gem aquamarines, although such color ranges from nearly colorless to medium blue, and in other crystals, from colorless to greenish blue.

In the nearby molybdenite-quartz-beryl vein on White Mountain, known as the California mine, stubby prisms of transparent pale greenish beryl, generally less than 5 cm (2 in) long, have been found in vugs.^{28,29}

Elsewhere in the county, ore beryl was obtained in the Turret district, about 11 km (7 mi) N 10° E of Salida,¹¹ from the Combination pros-

BERYL LOCALITIES

pect, Last Chance (Old Glory) prospect, the Mica-Beryl mine located on the W wall of Railroad Gulch, ca 2.8 km (1.75 mi) N 20° W of Calumet Iron mine, as crystals to 30.5 × 15 cm (12 × 6 in), and in Rock King prospect nearby, from which over a ton of ore beryl was mined in 1943–44 as well-formed prisms to 2.4 m (8 ft) long and 30.5 cm (12 in) diameter.

Gunnison County. Important deposits of ore beryl outcrop in Quartz Creek district, named after the stream which bisects the area, and which lies immediately W, SW and S of Ohio City. The Brown Derby pegmatites were located in 1930 and led to intensive exploration and mining for feldspar, mica, and beryl.^{4,32} Argall listed active mines for 1949,¹⁰ others were described by Hanley et al.,¹¹ but the most thorough exploration was accomplished by Staatz and Trites who examined at least 1800 pegmatite bodies and found 232 containing beryl.³³ At this time, or up to 1955, the district produced 51 tons of ore beryl in subhedral to anhedral prisms, brown, white, pale green, greenish gray, or pale blue green in color, ranging from several cm across to as much as 60 cm (24 in) in diameter. Range of R.I.: $\sigma = 1.573\text{--}1.585$, average 1.578. In addition to the above, a little pink beryl was found in the Brown Derby pegmatite. The Bucky-New Anniversary mine, 1.6 km (1 mi) NNW of Ohio City and immediately E of Willow Creek, was mined in 1950 and produced 15 tons of ore beryl;³⁴ it was described by Wilson and Young, who found beryl irregularly distributed in pegmatite as crystals to 15 cm (6 in) long.³⁵ Beryl is also found in Buckhorn prospect, 1.3 km (0.8 mi) SW of Ohio City, and in White Spar prospects 2 km (1.25 mi) SSW of the town. The Brown Derby pegmatite itself, 3.2 km (2 mi) SSW of the town was examined by McLellan, who gave production statistics for lepidolite and beryl by the end of 1944.³⁶ It is mineralogically complex and in addition to beryl, produced commercial quantities of microlite. Other beryl localities are: Opportunity No. 1 mine, 7.4 km (4.7 mi) SW of Ohio City; Black Canyon of Gunnison River, 9.4 km (6 mi) E of Cimarron in the Black Canyon Beryl prospect.^{10,11}

Fremont County. Crystals to 12.5 cm (5 in) diameter were identified by Sterrett in pegmatite on E side of Mac Gulch in Micanite district,⁸ ca 40 km (25 mi) NW of Canon City, and later described by Hanley et al.¹¹ Important beryl peg-

matites occur in Canon City or Eight Mile Park district, lying in a belt of metamorphic rocks of the Idaho Springs Formation or in the adjacent Pikes Peak granite. They begin at a point about 6 km (3.8 mi) NNE of Canon City and extend along a ENE–WSW axis to a point about 8.6 km (5.4 mi) WNW of Canon City or 2.5 km (1.6 mi) due W of Royal Gorge Bridge. Heinrich plotted and described 18 mines.³⁷ Beryl occurs as blue-green, blue, pale blue, pale green and yellowish crystals, also some in white, orange-tinted, and pink, and occasionally color-zoned. "Shell" crystals also occur and rarely those transparent enough to afford small faceted gems. Green and blue crystals gave R.I. of $\sigma = 1.576\text{--}1.587$, average 1.581, while orange to white varieties from the Mica Lode mine gave $\sigma = 1.595$, probably due to higher alkali content. In Meyers quarry, crystals were found to 30.5 × 12.5 cm (12 × 5 in) but elsewhere to 45 cm (1.5 ft) in diameter. Eckel mentions some as large as 180 × 30 cm (6 × 1 ft).⁶

In the Texas Creek district, ca. 9.5 km (6 mi) N of the town, which lies about 42 km (26 mi) by highway W of Canon City, Sterrett reported discovery of gem aquamarine in mines of the Royal Gorge operated by C. A. Beghtol & Co.³⁸ Crystals, some with gemmy areas, were said to be plentiful in the Amazon claim of J. D. Endicott located 10 km (6.5 mi) N of Texas Creek in East Gulch.³⁹ Beryl-pegmatites in this district are also mentioned by Landes,⁴ Argall,¹⁰ and Hanley et al.¹¹ An important deposit is Devil's Hole Beryl mine or Wild Rose claim, 9.7 km (6.1 mi) N of Texas Creek by road. This mine produced 300 tons of ore beryl, mostly as euhedral crystals of greenish blue to pale blue color, also some deep brown, and some "shell" type crystals averaging ca 10 cm (4 in) diameter (although one was found of 60 cm [24 in] diameter).¹¹ Reserves were estimated in 1950 as 25–100 tons. The Chief Lithium pegmatite, ca. 7.8 km (5 mi) N of Texas Creek, also contains beryl as crystals to 8 cm (3 in) long in a cleavelandite-lepidolite rock.⁴⁰

1. Hanley, J. B. 1947. Pegmatites. In *Mineral Resources of Colorado*, edited by J. W. Vanderwilt. Denver: State of Colorado Mineral Resources Board, pp. 466–70.
2. Williamson, D. R. 1958. Beryllium. *Colorado School of Mines Mineral Industries Bulletin* (Golden) 1, no. 1, 12 pp.
3. Galbraith, D. S. 1960. Beryllium. Chapter in *Mineral*

World Sources of Ore and Gem Beryl / United States of America

- Resources of Colorado, First Sequel*, edited by S. M. del Rio. Denver: State of Colorado Mineral Resources Board. 764 pp.; beryllium pp. 399–421.
4. Landes, K. K. 1935. Colorado pegmatites. *American Mineralogist* 20:319–33.
 5. Heinrich, E. W., and Bever, J. 1957. Selected studies of Colorado pegmatites and sillimanites. Part I. *Colorado School of Mines Quarterly* (Golden) 52, no. 4.
 6. Eckel, E. B. 1961. Minerals of Colorado: a 100-year record. *U.S. Geological Survey Bulletin* 1114. 399 pp.
 7. Pearl, R. M. 1965. *Colorado Gem Trails and Mineral Guide*. Denver: Sage Books. 223 pp.
 8. Sterrett, D. B. 1923. Mica deposits of the United States. *U.S. Geol. Sur. Bull.* 740, 342 pp.
 9. Gilkey, M. M. 1960. Hyatt Ranch pegmatite, Larimer County, Colorado. *U.S. Bureau of Mines Report of Investigations* 5643. 18 pp.
 10. Argall, G. O. 1949. Industrial minerals of Colorado. *Colorado School of Mines Quarterly*, vol. 44, no. 2, pp. 48–69.
 11. Hanley, J. B.; Heinrich, E. W.; and Page, L. R. 1950. Pegmatite investigations in Colorado, Wyoming and Utah, 1942–1944. *U.S. Geological Survey Professional Paper* 227, 125 pp.
 12. Thurston, W. R. 1955. Pegmatites of the Crystal Mountain district, Larimer County, Colorado. *U.S. Geol. Sur. Bull.* 1011. 185 pp.
 13. Ives, R. L. 1941. The Green Ridge pegmatite, Grand County, Colorado. *Rocks & Minerals Magazine* (Peekskill, N.Y.) 16:12–17.
 14. Waldschmidt, W. A., and Adams, J. W. 1942. The beryl-monazite pegmatite dike at Centennial Cone, Colorado. *Colorado School of Mines Quarterly*, vol. 37, no. 3, pp. 29–38.
 15. Hawley, C. C. 1969. Geology and beryllium deposits of the Lake George (or Badger Flats) beryllium area, Park and Jefferson counties, Colorado. *U.S. Geol. Sur. Prof. Paper* 608-A. 44 pp.
 16. Siems, P. L. 1963. Beryllium. *Colorado School of Mines Indust. Bull.* vol. 6, no. 3, 15 pp.
 17. Heinrich, E. W., and Gross, E. B. 1960. Fluocerite and associated minerals from the Black Cloud pegmatite, Teller County, Colorado. *American Mineralogist* 45:455–9.
 18. Kunz, G. F. 1886. Precious stones. Chapter in *U.S. Geological Survey Mineral Resources of the United States for 1885*, pp. 437–44.
 19. Cross, R. T. 1887. Notes on aquamarine from Mount Antero, Colorado. *American Journal of Science* (New Haven) 33:161–2.
 20. Kunz, G. F. 1889. Precious stones. Chapter in *U.S. Geol. Sur. Min. Res. of the U.S. for 1888*, pp. 580–5.
 21. Hills, R. C. 1889. Etched beryls from Mount Antero, Colorado. *Proceedings of the Colorado Scientific Society* (Denver) 3:191–2.
 22. Penfield, S. L. 1890. Some observations on the beryllium minerals from Mt. Antero, Colorado. *American Journal of Science* 40:488–91.
 23. Sterrett, D. B. 1910. Gems and precious stones. Chapter in *U.S. Geol. Sur. Min. Res. of the U.S. for 1909*, pp. 739–808.
 24. Over, E. 1928. Mineral localities in Colorado—the Mt. Antero aquamarine locality. *Rocks & Minerals* 3:110–11.
 25. ———. 1935. Further explorations on Mt. Antero, Colorado. *Rocks & Minerals* 10:27–9.
 26. Montgomery, A. 1938. Storm over Antero. *Rocks & Minerals* 13:355–69.
 27. Switzer, G. 1939. Granite pegmatites of the Mt. Antero region, Colorado. *American Mineralogist* 24:791–809.
 28. Landes, K. K. 1934. The beryl-molybdenite deposit of Chaffee County, Colorado. *Economic Geology* (Lancaster, Pa.) 29:697–702.
 29. Adams, J. W. 1953. Beryllium deposits of the Mt. Antero region, Chaffee County, Colorado. *U.S. Geol. Sur. Bull.* 982-D, pp. 95–119.
 30. Jacobson, M. I. 1979. Mount Antero. *The Mineralogical Record*, 10:339–46.
 31. Sharp, W. N. 1964. Mt. Antero area, Colorado. *U.S. Geol. Sur. Prof. Paper* 401-A, cited in 30 above.
 32. Eckel, E. B. 1933. A new lepidolite deposit in Colorado. *Journal of the American Ceramic Society* (Columbus) 16:239–45.
 33. Staatz, M. H., and Trites, A. F. 1955. Geology of the Quartz Creek pegmatite district, Gunnison County, Colorado. *U.S. Geol. Sur. Prof. Paper* 265. 111 pp.
 34. Wemlinger, C. A. 1950. Colorado pegmatite deposit yields beryl and mica. *Engineering and Mining Journal* (New York) 151, no. 11, pp. 92–4.
 35. Wilson, S. R., and Young, W. A. 1953. Investigation of the New Anniversary—Bucky pegmatite, Gunnison County, Colorado. *U.S. Bureau of Mines Rept. Invest.* 4939. 7 pp.
 36. McLellan, R. R. 1956. Brown Derby pegmatites (Gunnison County, Colorado). *U.S. Bureau of Mines Rept. Invest.* 5204. 21 pp.
 37. Heinrich, E. W. 1948. Pegmatites of the Eight Mile Park, Fremont County, Colorado. *American Mineralogist* 33:420–48, 550–87.
 38. Sterrett, D. B. 1908. Precious stones. Chapter in *U.S. Geol. Sur. Min. Res. of the U.S. for 1907*, pp. 795–842.
 39. ———. 1909. Precious stones. *U.S. Geol. Sur. Min. Res. of the U.S. for 1908*, pp. 805–59.
 40. Heinrich, E. W., and Vian, R. W. 1965. The Chief lithium pegmatite, Devil's Hole, Fremont County, Colorado. *American Mineralogist* 50:96–104.

New Mexico

Numerous granitic pegmatite bodies intrude metamorphic rocks associated with granite masses in the mountainous regions of N central New Mexico, but ore beryl pegmatites are largely confined to a broad belt which extends SSE from near Tres Piedras (near the border between Taos and Rio Arriba counties) to a pegmatite district lying about 32 km (20 mi) SE of Pecos in San Miguel County. The bodies are not uniformly distributed but occur in well-defined districts. The principal pegmatite mineral of value has been mica, but beryl has been recovered as a by-product.

BERYL LOCALITIES

uct and in the Harding mine was the major mineral of value. For example, during 1951–1958, all districts produced 640 tons of ore beryl valued at \$260,000 while in 1948–1958 the Harding mine alone produced about 800 tons of ore beryl.¹ Scarcely any gem or mineral specimen beryls have been found, although an interesting occurrence of red beryl has recently been reported from Sierra County. The most complete treatment of the state mineralogy, including a substantial section on beryl, is in Northrop.²

Taos County. Crystals to 15 cm (6 in) long occur in pegmatite on a ridge W of the head of the southern branch of Rio de los Cedros, 8.3 km (5.2 mi) S of Costilla.² Beryl is found in Paul Birch claim, ca 5.6 km (3.6 mi) E of Pilar.¹ The important and productive Harding pegmatite body in the Picuris district is located 9.6 km (6 mi) E of Dixon and 1.2 km (0.75 mi) S of State Highway 75, or about 32 km (20 mi) SW of Taos. The pegmatite was known by 1900, but active mining for lepidolite and spodumene only began in 1920.³ Beryl production began sometime after 1942. Jahns and Wright reported a production of 20 tons by 1944,⁴ while Berliner reported 27.5 tons as of February 1946,⁵ the beryl assaying 12% BeO. In 1961, Redmon noted that nearly 800 tons had been produced during 1948–1958.¹ The pegmatite was investigated by Soule,⁶ also by Jahns,⁷ and briefly described by Schilling.⁸ The geology of the area is described by Just,³ Jahns,⁷ and Montgomery.⁹ Montgomery acquired the property in 1942 and began mining for microlite (tantalam ore).¹⁰ He discovered large amounts of beryl somewhat later. The pegmatite body is large, flat-lying, and well-zoned, and consists mainly of quartz, microcline, albite, and muscovite but with zones containing spodumene, lepidolite, microlite, and tantalite-columbite. Beryl occurs in large anhedral white to pale pink crystals or sometimes in small yellowish crystals that are generally less than 5 cm (2 in) in diameter; associates are albite and smoky quartz, muscovite, and apatite. None of the beryl is gem quality. E of the Harding mine on S side of State Highway 75, 4.8 km (3 mi) NW of Chamizal, the Roybal claims contain beryl.¹

Rio Arriba County. Numerous pegmatites outcrop in Petaca district emplaced in metamorphic rocks in a broad, curving belt that extends from Kiawa Mountain in the N, then passes SE and S to end near Ojo Caliente.³ Jahns gives de-

tailed geology and mineralogy of the pegmatites, of which at least 49 bodies were found to contain beryl.⁷ Wright describes the Globe pegmatite deposits, which contain a little beryl.¹¹ Redmon summarizes the information on these occurrences and notes that the Lonesome mine, ca 4.2 km (2.6 mi) WNW of Petaca produced 4,500 lb of ore beryl before 1944 while the Sunnyside mine on the W side of Alamos Canyon produced more than 2,500 lb.¹ According to Northrop, the Sandoval and Nambe deposits yielded a few crystals to 2.4 m (8 ft) long and the Apache No. 1 mine furnished pink beryl crystals.² The Sunnyside body also yielded "cigar-shaped" blue crystals to 17.5 cm (7 in) long enclosed in the schist surrounding the pegmatite, of which "many specimens should have value as gem and ornamental material."^{7, p. 227}

Mora County. Beryl is found in Lepidolite No. 2 mine at the headwaters of Sparks Creek, ca 7.2 km (4.5 mi) WNW of Rociado; also in nearby Pidlite pegmatite between the headwaters of this creek and Maesta Creek.^{1,12} Beryl from the latter deposit occurred in white to gray anhedral crystals in outer zones, very pale pink and equant subhedral in inner zones, and rarely as white tabular crystals in the lepidolite units; R.I. $\rho = 1.583$ (border zones), 1.595 (central units).¹²

Santa Fe County. Localities for beryl are: Rocking Chair claim, ca 3.6 km (2.25 mi) ESE of Cordova; Rocking Chair No. 2, where a crystal of 150 × 25 cm (60 × 10 in) was recorded²; and B.A.T. claims, ca 2.8 km (1.75 mi) SE of Cordova. Northrop noted two unconfirmed reports of emerald discoveries.

San Miguel County. About 24 tons of ore beryl were produced from Old Priest mine, Ribera area, Tecolote district, the mine located 12 km (7.7 mi) N of the junction of U.S. Highway 84–85 and Ribera–San Miguel road.¹ Sources exist also in pegmatites of El Porvenir district, in adjoining Youngs Canyon, along Burro Creek, and Gallinas Creek.²

Valencia County. In Grants district on E Grants Ridge, blueish green crystals of small size occur in cavities in rhyolite in a very rare type of occurrence²; see Sierra County below.

Sierra County. The extremely rare occurrence of red beryl in rhyolite in Utah was matched in 1979 by discovery of a similar occurrence in this county by P. E. Haynes.¹³ The locality is in Paramount Canyon on W side of Black Range in NW

World Sources of Ore and Gem Beryl / United States of America

part of the county, and the claim, Beryllium Virgin prospect, is further located in Sec 22, T 10 S, R 11 W. Regional rocks are mid-Tertiary or younger rhyolites, basalts and clastic sediments, with the minute red beryl crystals found in vesicles in the rhyolite associated with quartz, specularite and pseudobrookite. The crystals are simple, tabular forms *m* and *c*, pale pink to raspberry red, sometimes color-zoned parallel to the *c*-axis and only from 1 to 3 mm in size.

Luna County. In another unusual occurrence, Holser described beryl from a quartz-tungsten vein, with helvite and associated grossular and idocrase in marble-tactite of Victorio Mountains¹⁴; the beryl crystals are very pale green to colorless prisms up to 5 cm (2 in) long.

1. Redmon, D. E. 1961. Reconnaissance of selected pegmatite districts in north-central New Mexico. *U.S. Bureau of Mines Information Circular* 8013. 79 pp.
2. Northrop, S. A. 1959. *Minerals of New Mexico*. Rev. ed. Albuquerque: University of New Mexico Press. 665 pp.
3. Just, E. 1937. Geology and economic features of the pegmatites of Taos and Rio Arriba counties, New Mexico. *New Mexico School of Mines Bulletin* 13, (Socorro) 73 pp.
4. Jahns, R. H., and Wright, L. A. 1944. The Harding beryllium-tantalum-lithium pegmatites, Taos County, New Mexico. *Economic Geology* (Lancaster, Pa.) 39:96-7 (abstract).
5. Berliner, M. H. 1949. Investigation of the Harding tantalum-lithium deposits, Taos County, New Mexico. *U.S. Bureau of Mines Reports of Investigation* 4607. 7 pp.
6. Soule, J. H. 1946. Exploration of Harding tantalum-lithium deposits, Taos County, New Mexico. *U.S. Bureau of Mines Rept. Invest.* 3986. 10 pp.
7. Jahns, R. H. 1946. Mica deposits of the Petaca district, Rio Arriba County, New Mexico; with brief description of the Ojo Caliente district, Rio Arriba County, and the Elk Mountain district, San Miguel County. *New Mexico Bureau of Mines and Mineral Resources Bulletin* 25 (Socorro) 289 pp.
8. Schilling, J. H. 1960. Mineral resources of Taos County, New Mexico. *N.M. Bureau of Mines & Min. Res. Bull.* 71 124 pp.
9. Montgomery, A. 1953. Pre-Cambrian geology of the Picuris Range, north-central New Mexico. *N.M. Bureau of Mines & Min. Res. Bull.* 30. 89 pp.
10. ———. 1951. The Harding pegmatite, remarkable storehouse of massive white beryl. *Mining World* 13:32-5.
11. Wright, L. A. 1948. The Globe pegmatite, Rio Arriba County, New Mexico. *American Journal of Science* (New Haven) 11:665-88.
12. Jahns, R. H. 1953. The genesis of pegmatites. II. Quantitative analysis of lithium-bearing pegmatite, Mora County, New Mexico. *American Mineralogist* 38:1078-1112.
13. Kimbler, F. S., and Haynes, P. E. 1980. An occur-

rence of red beryl in the Black Range, New Mexico. *New Mexico Geology* (Socorro) 2, no. 1, p. 15.

14. Holser, W. T. 1953. Beryllium minerals in the Victorio Mountains, Luna County, New Mexico. *American Mineralogist* 38:599-611.

Idaho

Bonner County. Some beryl is found in Soldier Creek Beryl prospects, 5.6 km (3.5 mi) ENE of Coolin.¹

Latah County. Many granitic pegmatite bodies intrude schists and gneisses of a spur of Thattuna Range ca 4.7 km (3 mi) N of Avon or about 37 km (23 mi) NE of Moscow. Mica was discovered about 1885 and important quantities were mined.² A little beryl was mined from the Muscovite claims in about 1937.³ Geology is described by Anderson⁴ and in more detail by Stoll.¹ Reed estimated that about 0.5 tons of beryl had been mined from the Muscovite claims and noted a single sale in 1944 of 374.5 lb assaying 10.10% BeO.³ Beryl is found in other pegmatites of the group such as in Levi Anderson, Last Chance, Luella, and Steelsmith deposits, mostly as anhedral to euhedral crystals usually not over several inches across, although some large prisms were reported from the Steelsmith deposit. The beryl is transparent in spots, but extensively fractured and greenish or yellowish in hue. Some crystals from the Muscovite deposits were of the "shell" type with cores of gray quartz and muscovite.

Clearwater County. In 1964, Mr. Newton Curl reported discovery of a gem quality aquamarine crystal by Gladys Cramer on her property near Pierce (personal communication, 1964). It measured 3.5 cm (1.36 in) × 4 cm (1.7 in) × 10.5 cm (4.2 in) and weighed 350 carats; it is largely flawless.⁵

Nez Perce County. Sterrett reported discovery of two good blue beryl crystals at some undisclosed locality near Lewiston.⁶

Lemhi County. Common beryl occurs in many places in the Yellow Jacket Mountains along Cathedral Rock road, 24 km (15 mi) W of Cobalt, in pegmatite stringers in porphyritic granite and sometimes as small crystals in vugs.⁷

Boise County. An exceptional, transparent, and fine blue beryl crystal in the National Museum of National History, Washington, D.C. is recorded from an unspecified locality near Centerville (see fig. 14-68).⁵

SAWTOOTH MOUNTAINS PRIMITIVE AREA. This

BERYL LOCALITIES

ugged, mountainous area, largely underlain by granitic rocks of the Idaho batholith, straddles the meeting point of Boise, Custer, Blaine and Elmore counties and is centered about 21 km (13 mi) NNE of Atlanta or about 112 km (70 mi) NE of Boise. Reid and Choate⁷ and Reid⁸ describe beryllium deposits in the area as well as its local geology and mineralogy. The country rock is pink quartz monzonite "ranging from aplitic through granitic to pegmatitic" in texture and containing in many places small crystals of aquamarine, also anhedral grains, spherical aggregates of crystals, and fine crystals of beryl in openings in joints, veins and vugs in pegmatites. Associates are orthoclase, plagioclase, quartz, magnetite, apatite, zircon, allanite, fluorite, and garnet. Most of the beryl-rich areas are in Boise County: at headwaters of Pinchot, Fall and Benedict creeks, around Ardeth and Edna lakes, and in Custer County: around Imogene and Toxaway lakes. In Elmore County there is an area around the Spangle Lakes and another along Sheep Creek where quartz-beryl veins were found as well as beryl-bearing pegmatites. Blue beryl occurs in the smaller veins and greenish beryl in the larger, the latter sometimes reaching a thickness of 60 cm (24 in). These last deposits were discovered by Mr. George Ogden of Atlanta and probably are the same referred to by Beckwith, who noted that beryl was associated with crystals of feldspar, smoky quartz, and some topaz and rare element minerals, with "a substantial number of crystals two to six inches long and one-half to three-quarters of an inch in diameter."⁹ Furthermore, "the crystals are well formed, the faces smooth, but the terminations are incomplete . . . they are transparent and free from inclusions and flaws."⁹

1. Stoll, W. C. 1950. Mica and beryl pegmatites in Idaho and Montana. *U.S. Geological Survey Professional Paper* 229. 64 pp.
2. Sterrett, D. B. 1923. Mica deposits of the United States. *U.S. Geological Survey Bulletin* 740. 342 pp.
3. Reed, G. C. 1946. Exploration of the Avon mica district, Latah County, Idaho. *U.S. Bureau of Mines Reports of Investigation* 3898, 23 pp.
4. Anderson, A. L. 1933. Genesis of the mica pegmatite deposits of Latah County, Idaho. *Economic Geology* (Lancaster, Pa.) 28:41-58.
5. Sinkankas, J. 1976. *Gemstones of North America*. 2 vols. New York: Van Nostrand Reinhold Co. 675, 494 pp.
6. Sterrett, D. B. 1908. Precious stones. Chapter in *U.S. Geological Survey Mineral Resources of the United States for 1907*, pp. 795-842.
7. Reid, R. R., and Choate, R. 1960. Prospecting for

beryllium in Idaho. *Idaho Bureau of Mines and Geology Information Circular* 7 (Moscow) 17 pp.

8. Reid, R. R. 1963. Reconnaissance geology of the Sawtooth Range. *Idaho Bureau of Mines Geological Pamphlet* 129. 37 pp.
9. Beckwith, J. A. 1972. *Gem Minerals of Idaho*. Caldwell: The Caxton Printers. 123 pp.

Utah

Daggett County. Beryl is reported in the Red Creek complex.¹

Tooele County. Beryl is found in many vein-like pegmatite bodies in Granite Mountains in T 8 S, R 12 W, Salt Lake meridian, or about 90 km (57 mi) SW of Tooele.² Small disseminated grains of beryl were noted in a non-pegmatite occurrence in a white granite mass within a red granite intrusive in Sheeprock Mountains by Williams.³ There are also radiate nodular masses composed of long prismatic crystals which reach as much as 60 cm (24 in) in diameter. Further information on this remarkable occurrence was provided by Harris, who noted the principal deposit on Dutch Peak in the S part of the range about 14.5 km (9 mi) S slightly W of Vernon.⁴ Cohenour centers the area on Hard-to-Beat Canyon⁵ and furnishes further remarks on the geology and mineralogy of the deposit and its potential economic importance in a later paper.⁶ In addition to the beryl which occurs in the granite itself, crystals also occur in numerous small pegmatite bodies composed mainly of quartz and feldspar, with the beryl crystals formed as blue prisms to about 7.5 cm (3 in) long and 12 mm (0.5 in) thick. Elsewhere in the county, Bixby reported blue beryl in the Ibapah Mountains "near the Sheba mine,"⁷ but this locality appears to be placed in Juab County by Bullock (p. 35).¹

Juab County. Beryl may be found in pegmatites on Goshute Indian Reservation in the extreme W of the county.¹ Gem aquamarine occurs in Fifteenmile Canyon, Ibapah Mountains.^{1,8} Common beryl was reported in the Queen of Sheba mine, Spring Creek district, about 11 km (7 mi) SSE of Goshute¹ and in Apex mine, in Trout Creek district of Deep Creek Mountains, or about 22 km (14 mi) SE of Goshute.¹

One of the most remarkable beryl deposits in the world is that in the rhyolites of Dugway and Thomas mountains, where raspberry red crystals of small size occur in gas cavities along with splendid, brilliant topaz crystals, spessartine garnet, bixbyite, pseudobrookite, quartz, and other

minerals. The beryls were first noticed by Maynard Bixby, collector and dealer of Salt Lake City who supplied specimens to Hillebrand for examination in about 1904; the latter furnished the first mineralogical description, and presumed the vivid hue to be due to manganese, of which the crystals "contain an appreciable amount."⁹ Details on the locality and its minerals were furnished by Montgomery, who noted associates of orthoclase, quartz, topaz, hematite, spessartine, bixbyite, pseudobrookite, beryl, calcite, fluorite and hyalite.^{10,11} Specimens collected by Edwin Over were examined by Palache, who found R.I. $n_o = 1.570-1.580$, average 1.576, and average $n_e = 1.570$; $G = 2.67 \pm 0.01$.¹² Staatz studied 33 beryls spectroscopically and found the Thomas Mountain specimens most distinctive in terms of minor element content.¹³ Nassau and Wood noted absorption peaks probably due to Mn^{+2} and suggest that this element is responsible for the color.¹⁴ Absence of water and CO_2 spectra appear to confirm it as anhydrous beryl, perhaps formed between 870–1470°C. Lattice constants are $a = 9.23637 \pm 4 \text{ \AA}$ and $c = 9.1972 \pm 1 \text{ \AA}$. Fron del found the Sc content to be $0.53 \pm 0.003 \text{ wt } \%$.¹⁵ Further data on composition are in Staatz and Carr, who also noted that the crystals are usually tabular, forms m and c , and grow to 6 mm (0.25 in) diameter but only half that in thickness.¹⁶ However, an elongated habit was noted in red beryls from near Wildhorse Spring. "The largest known [crystal] from the Thomas Range, measured 13 mm across and 20 mm high."¹⁶

Collecting sites for topaz and beryl lie along walls of Topaz Valley at the extreme SE point of the Thomas Range, the entrance to the valley being about 2.4 km (1.5 mi) N of Sand Pass Road, which leads W from Nephi, or alternatively, via a paved road from Delta 52 km (35 mi) SE. Holfert and Ream provide detailed guides to the area, including specific sites productive of red beryl.^{17,18} In general, the crystals are found in the gas cavities or shrinkage cracks in pale gray porous rhyolite or sometimes wholly enclosed in the rock. Such beryls are also found near Wildhorse Spring located ca. 13 km (8 mi) NNW of Topaz Valley on the W side of the range.¹⁶ According to Ream "similar occurrences have been known for many years in the Dugway Range, north of the Thomas Range, and in the Keg Mountains, 12 miles [18 km] east of the Thomas Range."¹⁸ Staatz further states that rhyolites in

the Dell, an upland valley between Spor Mountain on the W and S portions of the Thomas Range, also commonly contain small topaz crystals in the rock groundmass and in some places, pink beryl.¹⁹

Beaver County. In terms of size, richness of color, and clear areas large enough to cut faceted gems, the recently found red beryls of this county far surpass those described above. Specimens first appeared in the market about 1976. Ream claims, however, that the occurrences were known since 1959, but little was done to exploit the deposits for either beryl or topaz. The deposits are located in the SE extremity of the Wah Wah Mountains, and recently the claims were acquired by Edward, Rex, and Robert Harris of Delta, who obtained Violet claims 1–8, located in sections 19, 30, T 29 S, R 14 W, which places them about 41 km (26 mi) WSW of Milford or about 69 km (43 mi) almost due W of Beaver. The deposits are similar to those of the Thomas Range, with the intense red beryl occurring as short prismatic crystals averaging about 10 mm (0.4 in) long and rarely up to 25 mm (1 in). They are enclosed in whitish kaolinite which can be easily scraped away or in a matrix of gray rhyolite. According to Barlow, the largest crystal found so far measured 26×13 mm, and the two largest faceted gems cut from a clear crystal weighed 2.93 carats and 2.42 carats.²⁰ These are virtually flawless, having been cut from a truly remarkable beryl. The color is rich, like fine dark ruby, with the ruby appearance further enhanced by a hint of blue (see color fig. 2).

1. Bullock, K. C. 1967. Minerals of Utah. *Utah Geological and Mineralogical Survey Bulletin* 76 (Salt Lake City) 237 pp.
2. Hanley, J. B.; Heinrich, E. W.; and Page, L. R. 1950. Pegmatite investigations in Colorado, Wyoming and Utah, 1942–1944. *U. S. Geological Survey Professional Paper* 227. 125 pp.
3. Williams, N. C. 1954. Nonpegmatite beryl occurrence, Sheeprock Mountains, Utah. *Geological Society of America Bulletin* 65, p. 1388 (abstract).
4. Harris, De V. 1958. The Geology of Dutch Peak Area, Sheeprock Range, Tooele County, Utah. *Brigham Young University Research Studies, Geological Series*, vol. 5, no. 1. Provo: Brigham Young University. 82 pp.
5. Cohenour, R. E. 1959. Sheeprock Mountains, Tooele and Juab counties. *Utah Geol. and Min. Sur. Bull.* 63. 201 pp.
6. ———. 1963. Beryllium and associated mineralization in the Sheeprock Mountains. In: Beryllium and uranium mineralization in western Juab County, Utah. *Utah Geological Society Guidebook to the Geology of Utah*, no. 17 (Salt Lake City) p. 8–13.

BERYL LOCALITIES

7. Bixby, M. 1916. *A Catalogue of Utah Minerals and Localities with Descriptive List and Notes for Collectors*. 4th ed. Salt Lake City: privately published. 32 pp.
8. Sterrett, D. B. 1909. Precious stones. Chapter in *U. S. Geological Survey Mineral Resources of the United States for 1908*, pp. 805-59.
9. Hillebrand, W. F. 1905. Red beryl from Utah. *American Journal of Science* (New Haven) 4:330-1.
10. Montgomery, A. 1934. A recent find of bixbyite and associated minerals in the Thomas Range, Utah. *American Mineralogist* 19:82-7.
11. ———. 1935. Minerals of the Thomas Range, Utah. *Rocks & Minerals* (Peekskill, N.Y.) 10:161-8.
12. Palache, C. 1934. Minerals from Topaz Mt., Utah. *American Mineralogist* 19:14-5.
13. Staatz, M. H.; Griffiths, W. R.; and Barnett, P. R. 1965. Differences in the minor element composition of beryl in various environments. *American Mineralogist* 50:1783-95.
14. Nassau, K. and Wood, D. L. 1968. An examination of red beryl from Utah. *American Mineralogist* 53:801-6.
15. Frondel, C. 1970. Scandium-rich minerals from rhyolite in the Thomas Range, Utah. *American Mineralogist* 55:1058-60.
16. Staatz, M. H. and Carr, W. J. 1964. Geology and mineral deposits of the Thomas and Dugway ranges, Juab and Tooele counties, Utah. *U. S. Geol. Sur. Prof. Paper 415*. 188 pp.
17. Holfert, J. 1977. *A Field Guide to Topaz and Associated Minerals of Topaz Mountain, Utah*. n.p.: privately published. 41 pp.
18. Ream, L. R. 1979. The Thomas Range, Wah Wah Mountains, and vicinity. *The Mineralogical Record* 10:261-78.
19. Staatz, M. H. 1963. Geology of the beryllium deposits in the Thomas Range, Juab County, Utah. *U. S. Geol. Sur. Bull. 1142-M*, pp. 1-36.
20. Barlow, J. F. 1979. Red beryl of the Wah Wahs. *Lapidary Journal* 32:2540-70, *passim*.

Nevada

Beryl was first mentioned in 1878 by Hoffmann, who noted crystals occurring "sparingly, ten miles north-northwest of Silver Peak . . . largest measuring .75 of an inch across. Color dull bluish-ash."¹ Presumably this is the same as the Silver Peak in Esmeralda County, but if so, the locality remains unconfirmed. A large map spotting both pegmatite and nonpegmatite occurrences of beryl in the state was compiled by Beal and is useful for quick reference.²

Elko County. Granitic pegmatites, some with small amounts of beryl in crystals usually less than 7.5 cm (3 in) long, are abundant in the Ruby Mountains in S-central part of the county. Beryl is reported from Robinson Creek mine at N end of the range; from Battle Creek mine on Battle Creek on E slope, and in about 100 other peg-

matite bodies in Dawley Canyon area.^{2,3,4} Just S of this area beryl is noted in Hankins Canyon.³ It also occurs on the W side of the range and to W of Dawley Creek area, or about 8 km (5 mi) E of Jiggs, in Gilbert Creek-McCutcheon Creek area.^{3,4} Ruby Range deposits are mentioned by Gianella.⁵

Pershing County. Here beryl is found in Lakeview scheelite-beryl deposit in Humboldt Canyon, near the N end of the local range or about 16 km (10 mi) SSW of Mill City.^{3,4} It occurs as colorless crystals to 5 cm (2 in) associated with quartz, muscovite, fluorite, dark blue tourmaline, and scheelite in a zone in limestone marked by numerous stringers of quartz and aggregates of the species mentioned; R.I. $\sigma = 1.590$ (associated with scheelite), 1.578 (associated with muscovite).³ A similar deposit, near Oreana, is located ca 35 km (22 mi) SSW of Mill City or about 9.6 km (6 mi) NNE of Oreana where pegmatites cut a mass of metadiorite in limestone and contain quartz, oligoclase, albite, fluorite, beryl, scheelite, phlogopite, K-feldspar, rutile, sphene, apatite, muscovite, sericite, calcite, chlorite, tourmaline, garnet, and zoisite.^{3,4,6} The beryl crystals are pale green and occur as anhedral masses or slender prisms to 10 cm (4 in) long, often doubly-terminated; R.I. $\sigma = 1.586-1.587$.⁶ In the same general area at Rye Patch, in 1938 Ball⁷ reported discovery of emerald as deep-colored outer zones on otherwise pale-colored beryl crystals in a pegmatite intruding limestone. The emerald portions were said to be small, mostly flawed and useless for gems. Nothing more has been heard of this discovery. On Beal's map, a beryl occurrence at the Hamilton Beryl mine appears about 11 km (7 mi) due S of the Oreana deposit,² but it is not mentioned either by Olson and Hinrichs³ or Holmes.⁴

White Pine County. Several deposits of scheelite-beryl and beryllium minerals occur in places where shales and limestones are intruded by granitic rocks on the W flank of the Snake Range in SE corner of the county. To the N, the Jeppson claims contain replacement ore bodies in limestone composed of bertrandite, phenakite, and beryl associated with fluorite and scheelite.⁴ Several km S is the Mt. Wheeler tungsten mine in Pole Canyon (or 63 km (40 mi) SE of Ely) in which a similar deposit in limestone contains phenakite and bertrandite as the principal beryllium species. Beryl is also present as pale-colored

World Sources of Ore and Gem Beryl / United States of America

crystals and veinlets; associates are quartz, calcite, mica, scheelite, pyrite, fluorite, sericite, siderite, galena, and sphalerite.⁸ Phenakite from this deposit was described by Lee and Erd.⁹

Lander County. Lynch Creek beryllium-tungsten deposits lie about 16 km (10 mi) SSE of Austin and contain beryl; some nearby granitic pegmatites do also.¹⁰

Eureka County. Minor beryl occurs in thin quartz veins cutting dolomite and quartzite formations in Fish Creek claims, 19 km (12 mi) SW of Eureka; associates include fluorite and sericite.⁴

Mineral County. Light blue beryl crystals, R.I. $\rho = 1.588$, are imbedded in quartz, wolframite-scheelite veins in the hills W of Teels Marsh about 6.2–13 km (4–8 mi) SW of Marietta (Pine Crow claims).

Esmeralda County. Beryl is found in pegmatites of Sylvania area, 40 km (25 mi) S of Silver Peak.³

Clark County. Just W of the Arizona state line, beryl occurs in granitic pegmatites in an area extending S and SW of Mesquite almost to Lake Mead.^{3,4} Moore mentions a beryl prospect on N slope Virgin Peak SE of Bunkerville with crystals to 2.5 cm (1 in) diameter.¹¹ Beryl-bearing granitic pegmatites are also among those mined principally for mica in Gold Butte district, an area enclosed by N arm of Lake Mead, its E–W arm, and the Arizona border.³ In an area ca 14 km (9 mi) NNE of Searchlight beryl is found on the Sunrise and Moonbeam claims located near the base of the W slope of Eldorado Mountains.^{3,4} A feldspar quarry 1.6 km (1 mi) N 5° W of Crescent Peak, or ca 21 km (13 mi) W of Searchlight contained small greenish crystals.³

1. Hoffmann, W. J. 1878. On the mineralogy of Nevada. *U. S. Geological and Geographical Survey (F. V. Hayden) Bulletin*, vol. 4, no. 3, art. 31, pp. 731–45.
2. Beal, L. H. 1964. Beryllium occurrences in Nevada. *Nevada Bureau of Mines Map 22* (Reno) 1 leaf.
3. Olson, J. C., and Hinrichs, E. N. 1960. Beryl-bearing pegmatites in the Ruby Mountains and other areas of Nevada and northwestern Arizona. *U. S. Geological Survey Bulletin 1082-D*, pp. 135–200.
4. Holmes, G. H. 1963. Beryllium investigations in California and Nevada. *U. S. Bureau of Mines Information Circular 8158*, 19 pp.
5. Gianella, V. P. 1941. Nevada's common minerals. *University of Nevada Bulletin*, vol. 35, no. 6 (Reno) 110 pp.
6. Kerr, P. F. 1938. Tungsten mineralization at Oreana, Nevada. *Economic Geology* (Lancaster, Pa.) 33:390, 407, 408.
7. Ball, S. H. 1939. Gem stones. Chapter in *U. S. Bureau of Mines Minerals Yearbook for 1938*, pp. 1385–96.
8. Stager, H. K. 1960. A new beryllium deposit at the Mount Wheeler mine, White Pine County, Nevada. *U. S. Geological Survey Professional Paper 300-B*, pp. 70–1.
9. Lee, D. E., and Erd, R. C. 1963. Phenakite from Mount Wheeler area, Snake Range, White Pine County, Nevada. *American Mineralogist* 48:189–93.
10. Hall, R. 1962. Samplings of Lynch Creek beryllium-tungsten prospect, Lander County, Nevada. *U. S. Bureau of Mines Reports of Investigation 6118*, 10 pp.
11. Moore, B. N. 1936. Arizona beryl. In *Mineral resources of the region around Boulder Dam*, by D. F. Hewett et al. *U. S. Geol. Sur. Bull.* 871 197 pp.

Arizona

Occurrences of beryl in granitic pegmatites and nonpegmatitic deposits were briefly described by Galbraith and Brennan¹ and superseded by the larger and more modern work of Anthony et al.²

Mohave County. Beryl is found in granitic pegmatites intruded in Precambrian schists and gneisses on Hummingbird (Fool's Gold) claims, N side Virgin Peak, ca 19 km (12 mi) SSE of Bunkerville, Nevada; blueish green anhedral grains and prisms not over 7.5 cm (3 in) long occur associated with tabular crystals of chrysoberyl; another body 60 m (200 ft) NW also contains beryl and chrysoberyl. It is also reported in pegmatites 3.2 km (2 mi) S of Painted Desert or ca 6.4 km (4 mi) E of Hoover Dam;³ in pegmatites 6.4 km (4 mi) ESE of Wright Creek Ranch about 24 km (15 mi) S of Peach Springs.⁴ A remarkable blue variety from this area was investigated by Schaller et al.,⁵ who found it to differ considerably from other beryls in physical properties and chemical composition. The R.I. is very high at $\rho = 1.610$; an analyzed sample gave $\rho = 1.608$, $e = 1.599$, exceeding the omega indices of all other recorded beryls; $G = 2.921$. In composition, it contains the lowest known percent of SiO_2 and Al_2O_3 , while its content of 6.68% of Cs_2O also is much greater than for any known beryl.

Elsewhere in the county beryl occurs sparingly in a quartz vein of the Borianna mine, central Hualpai Mountains about 32 km (20 mi) SE of Kingman, associated with fluorite, feldspar, wolframite, scheelite, molybdenite, pyrite, and arsenopyrite.⁶ Beryl also occurs in pegmatites of Aquarius Cliffs district, 24 km (15 mi) NE of Wikieup and in outcropping along Atchison, Topeka & Sante Fe railroad.⁴ Other sources are de-

1. Hoffmann, W. J. 1878. On the mineralogy of Nevada. *U. S. Geological and Geographical Survey (F. V. Hayden) Bulletin*, vol. 4, no. 3, art. 31, pp. 731–45.
2. Beal, L. H. 1964. Beryllium occurrences in Nevada. *Nevada Bureau of Mines Map 22* (Reno) 1 leaf.
3. Olson, J. C., and Hinrichs, E. N. 1960. Beryl-bearing pegmatites in the Ruby Mountains and other areas of Nevada and northwestern Arizona. *U. S. Geological Survey Bulletin 1082-D*, pp. 135–200.
4. Holmes, G. H. 1963. Beryllium investigations in California and Nevada. *U. S. Bureau of Mines Information Circular 8158*, 19 pp.
5. Gianella, V. P. 1941. Nevada's common minerals. *University of Nevada Bulletin*, vol. 35, no. 6 (Reno) 110 pp.
6. Kerr, P. F. 1938. Tungsten mineralization at Oreana, Nevada. *Economic Geology* (Lancaster, Pa.) 33:390, 407, 408.

BERYL LOCALITIES

scribed in Heinrich.⁷ Greenish blue crystals to 30.5 × 10 cm (12 × 4 in) occur in Beryl Wash near Kingman.^{1,2} In the G & M pegmatite, 24 km (15 mi) SW of Wikieup, beryl occurs as crystals to 2.7 m (9 ft) long and 45 cm (18 in) diameter.¹ It is also in pegmatites of Cerbat Range and in the Chloride district.²

Yavapai County. Sources of beryl are: Black Pearl mine, Eureka district;⁸ pegmatites around Bagdad; pegmatites 6.3 km (4 mi) SE of Wagoner in Bradshaw Mountains;² and in a pegmatite dike 4.8 km (3 mi) E of Crown King post office.² Beryl occurs in many pegmatite bodies of the White Picacho district, centered ca 16 km (10 mi) E of Wickenburg, such as in Lower Jumbo mine in the canyon portion of Mitchell Wash, where a little pale blueish gray beryl has been found. Pale blueish green to yellowish anhedral to euhedral crystals occur in Outpost mine in San Domingo Wash; abundant crystals to 28 cm (11 in) long occur in pegmatite of Midnight Owl (Lithia King) mine a little N of the divide between Trilby Wash and Buckhorn Wash, from which a production of 13 tons of ore beryl was recorded during 1947–1952. Other localities are Independence prospects S of the Midnight Owl, Long Dike mine just N of same, and the Lone Giant prospect on the walls of Independence Gulch;^{1,2,9} also in the quartz in Lawler Peak area.²

Maricopa County. Beryl is found near Aguila.²

Graham County. Beryl occurs in pegmatites at Goodwin Wash.²

Cochise County. Near Dragoon and in the Dragoon Mountains, small colorless crystals were found in Boericke tungsten deposit and in Gordon and Abril mines in tectite deposits. In the Beryl Hill claims exploiting tungsten minerals and in similar deposits nearby beryl also may be found. Euhedral crystals in vugs occur in quartz veins E of Elfrida in Swisshelm Mountains.^{1,2,8}

Pima County. Massive common beryl, also blue crystals, were found in quartz veins in granite on Bella Donna claim near Frielinger Feldspar mine in Sierrita Mountains. According to Anthony et al., "gem quality aquamarine crystals affording stones to 40 carats have been found in some quantity from pegmatites in the vicinity of Sierrita Mountains."² Beryl is also reported in Baoquiviri Mountains, at Agua Verde in veins in granite,^{2,8} and in quartz veins on Apache Peak, Santa Catalina Mountains.²

Yuma County. "Small, lavender, and rose-colored crystals in a matrix of yellowish quartz" were reported in the Gila Mountains about 2.4 km (1.5 mi) E of the Fortuna mine.²

- Galbraith, F. W., and Brennan, D. J. 1970. Minerals of Arizona. *Arizona Bureau of Mines Bulletin 181* (Tucson) 116 pp.
- Anthony, J. W.; Williams, S. A.; and Bideaux, R. A. 1977. *Mineralogy of Arizona*. Tucson: University of Arizona Press. 241 pp.
- Olson, J. C., and Hinrichs, E. N. 1960. Beryl-bearing pegmatites in the Ruby Mountains and other areas in Nevada and northwestern Arizona. *U. S. Geological Survey Bulletin 1082-D*, pp. 135–200.
- Moore, B. N. 1936. Arizona beryl. In *Mineral resources in the region around Boulder Dam*, by D. F. Hewett et al., *U. S. Geol. Surv. Bull.* 871, 197 pp.
- Schaller, W. T.; Stevens, R. E.; and Jahns, R. H. 1962. An unusual beryl from Arizona. *American Mineralogist* 47:672–99.
- Hobbs, S. W. 1944. Tungsten deposits in the Boriana district and the Aquarius Range, Mohave County, Arizona. *U. S. Geol. Surv. Bull.* 940-1, pp. 247–64.
- Heinrich, E. W. 1960. Some rare-earth mineral deposits in Mohave County, Arizona. *Ariz. Bureau of Mines Bull.* 167, Mining Technology Ser. 51. 22 pp.
- Stantz, M. H., Griffiths, W. R., and Barnett, P. R. 1965. Differences in minor element composition of beryl in various environments. *American Mineralogist* 50:1783–95.
- Jahns, R. H. 1952. Pegmatite deposits of the White Picacho district, Maricopa and Yavapai counties, Arizona. *Ariz. Bureau of Mines Bull.* 162, Mining Technology Ser. 46. 105 pp.

Alaska

Seward Peninsula. Beryl is found in quartz-muscovite veins in Lost River mine on Cassiterite Creek just above its confluence with Lost River in SW part of the peninsula; locally other Bessies as euclase, chrysoberyl, phenakite, and bertrandite occur in veins, but beryl is relatively rare.^{1,2} Stream sediments sometimes contain beryl.

Baranof Island. Beryl is a minor constituent in some granitic pegmatite veins exposed along W coast of the island.³

- Sainsbury, C. L.; Helz, A. W.; Ansell, C. S.; and Westley, H. 1961. Beryllium in stream sediments from tin-tungsten provinces of the Seward Peninsula, Alaska. *U. S. Geological Survey Professional Paper 424-C*, pp. 16–7.
- Sainsbury, C. L. 1963. Beryllium deposits of the western Seward Peninsula. *U. S. Geol. Survey Circular* 479. 18 pp.
- Sainsbury, C. L. 1957. Some pegmatite deposits in southeastern Alaska. *U. S. Geological Survey Bulletin* 1024-G, pp. 141–61.

World Sources of Ore and Gem Beryl / United States of America

Washington

The only comprehensive topographical mineralogy of the state is that of Cannon, in which a number of beryl occurrences appear.¹

Pend Oreille County. Crystals to 10 cm (4 in) long occur with smoky quartz and muscovite in Silver Plume prospect, North Skookum Lake.¹ "Excellent complex and skeletal, gem quality crystals" of green color, also opaque, are found in decomposed pegmatites on South Baldy Mountain, ca 16 km (10 mi) NE of Usk¹; associates are microcline, muscovite, smoky quartz, and chrysoberyl. Numerous granitic pegmatites, 67 known to contain beryl, occur WSW of Blueslide along Lost Creek on the SE side of Granite Peak.¹

Spokane County. Small crystals occur in granitic pegmatites of Mount Spokane area.¹ In Greenland prospect, Newman Lake area, a pegmatite produced a crystal 60 cm (24 in) long and 19 cm (7.5 in) diameter.¹ Very small crystals occur in quartz veins of Silver Hill Tin mine S of Spokane and in railroad cuts near Fish Lake about 14 km (9 mi) SSW of Spokane.²

Stevens County. The Railway Dike mine on a ridge ca 1.6 km (1 mi) S of Calispell Peak NE of Chewelah produced many crystals of common white, colorless or green beryl to 25.5 × 15 cm (10 × 6 in); a few hundred pounds of ore beryl were shipped from here.^{1,2} On the peak, the Eagleton prospect also yielded beryl in crystals to about one m long.^{1,2} Clear aquamarine crystals have been reported from a pegmatite prospect 24 km (15 mi) SW of Springdale.¹

Ferry County. Beryl has been reported in: pegmatites now under the waters of Franklin D. Roosevelt Lake (Columbia River) near Kettle Falls^{1,2}; pegmatite dikes on S and E slopes of Columbia Peak near Sherman Pass (State Route 30); Cedar Ridge farther W.² Gemini pegmatite prospect 18.5 km (11.7 mi) NE of Nespelem or about 24 km (15 mi) NNW of Keller contained beryl.²

Okanogan County. Aquamarine crystals were reported from the canyon wall of Tunk Creek 6.6 km (4.2 mi) E of Riverside¹ and near Nespelem.²

Whatcom County. Beryl was reported as crystals with quartz, orthoclase, and tourmaline in mirolitic cavities in Castle Peak area, close to Canadian border, or about 46 km (29 mi) NE of Newhalem.¹

Chelan County. Beryl was found in a road cut near Lake Creek campground, 21 km (13 mi)

WNW of Telma,^{1,2} and in pegmatite in a road cut along Icicle Creek, 6.3 km (4 mi) S of Leavenworth as small crystals.¹

Snohomish County. Two doubtful occurrences were reported by Valentine and Hunting,² one near Del Camp Peak, 6.3 km (4 mi) W of Monte Cristo and the other ca 11 km (7 mi) S of the peak. Two localities in the same general area are given by Cannon:¹ at head of Weden Creek, where several gem quality crystals were reported as found and sold, and at the Jones prospect, NW of Weden Creek, which appears to be the same as that previously mentioned in Valentine and Hunting above.²

1. Cannon, B. 1975. *Minerals of Washington*. Mercer Island: Cordilleran, 184 pp.

2. Valentine, G. M. and Hunting, M. T. 1960. Inventory of Washington minerals. Part I. Nonmetallic minerals. 2nd ed. 2 vols. *Washington Department of Conservation, Division of Mines and Geology Bulletin 37* (Olympia) 15 pp. text. 83 pp. maps.

California

W. P. Blake mentioned beryl from near Jamestown, Tuolumne County as early as 1853,¹ but neither the first formal mineralogy of the state by Blake in 1866 nor the second by H. G. Hanks in 1884 noticed beryl. The first state mineralogy to include beryl was that of Eakle,² which appeared in 1914. By that date the great discoveries of pegmatite minerals in the southern counties were already well known, but as Eakle stated "all the beryl known to occur in this state is limited to the series of feldspathic pegmatite veins of Riverside and San Diego counties." Other localities were added in other counties in subsequent editions of the state mineralogy, the last being in 1966 by Murdoch and Webb.³ Despite the very large size of California, it is surprising to find that beryl of importance, either as ore or as specimen or gem material, has come only from a few small areas in the counties mentioned by Eakle above.

Lassen County. Beryl occurs with tourmaline and mica in the Thompson Gem mine, NE of Milford.³

Trinity County. Pink crystals are reported in placer deposits near Hamburg.³

Tuolumne County. Small green crystals were found 4.8–6.3 km (3–4 mi) from Jamestown.³

Fresno County. Beryl was found with topaz in pegmatite (?), 8 km (5 mi) NE of Trimmer, and in pegmatite just E of Academy.³

BERYL LOCALITIES

Inyo County. Beryl occurs with fluorite 4.8 km (3 mi) W of Lone Pine. Nearby, small blue beryl prisms were found with amazonite in narrow pegmatite veins traversing granite about 2.35 km (1.5 mi) SE of Lone Pine; this is likely the same locality mentioned by Sterrett⁴ and repeated by Schaller⁵ as lying somewhere between Barstow and Lone Pine. The crystals were described as pale to deep blue and up to 1.3 cm (0.5 in) in diameter. Wright, however, gives the locality as 8–9.5 km (5–6 mi) E of Lone Pine.⁶ Benson described the occurrences as pegmatite stringers in the local biotite-granite country rock.⁷ The deposits are said to have yielded two tons of ore beryl.

Los Angeles County. A few greenish white euhedral beryl crystals, not over about 5 mm in size, occur in an allanite-bearing pegmatite in Sec. 17, T 3 N, R 13 W, San Bernardino meridian, in the San Gabriel Mountains.⁸

Granitic Pegmatites of the Peninsular Ranges

Simple to complex granitic pegmatites intrude igneous rocks and associated metamorphic rocks of the Southern California batholith, which extends from the Jurupa Mountains NW of the city of Riverside to the S tip of Lower (Baja) California in Mexico, a distance of over 1,600 km (1,000 mi). Jahns summarizes features of the batholith,⁹ discusses its pegmatites,¹⁰ and provides a field guide to typical occurrences of pegmatites.¹¹ Another useful guide was published in 1961 by Thomas and includes remarks on several of the most important gem-bearing pegmatite districts in San Diego County.¹² Gemstone occurrences in Riverside and San Diego counties were treated in considerable detail by Kunz¹³ and brought up to date with new information by Sinkankas.¹⁴

In general the pegmatite bodies in both counties, and in the extension of the rocks of the batholith into Baja California, largely assume vein-like or sheet-like shapes and occur in groups or swarms in gabbros and other igneous rocks or in schists and gneisses adjacent to igneous intrusives. In size, they range from mere stringers to some bodies that are dozens of meters wide and several kilometers long. Most are mineralogically simple, but others are complex and contain a number of zones and sometimes openings in which splendid crystallizations occur. Almost all

the beryl that has attracted the attention of collectors and mineralogists is that which occurs in or adjacent to such openings. Not enough common beryl has been found to make mining of that mineral for ore purposes economically attractive.

Riverside County. In 1908, common beryl of pale blue color was found on the F. D. Mears property ca 3.4 km (2 mi) E of Riverside at the base of Box Springs Mountain in a pegmatite cutting diorite or gabbro; about 9 kg (20 lb) of crystals were mined, some suitable for gems.¹⁵ Blue and green prisms to 12 mm (0.5 in) long were found in Jensen quarry, 6.4 km (4 mi) W of Riverside.³ Other beryl was found in an isolated pegmatite on a small hill on the Perris Plain near Winchester, Sec. 12, T 5 S, R 2 N, in Elsinore quadrangle.¹⁶ Common beryl and a little aquamarine were found in S. P. Silica quarry near Nuevo between Perris and Hemet.³ Near Hemet, Kunz reported discovery of rose beryl.¹⁷ The Fano mine, noted primarily for kunzite and colored tourmaline, was located in 1902 on the N side of Coahuila Mountains and produced 116 kg (250 lb) of beryl "but only about five percent of it available for gem purposes."¹³ Minor beryl occurrences in pegmatites appear elsewhere on this mountain¹⁶ and as yellowish common beryl in small prisms in pegmatite stringers on its E flank; see also Tucker and Sampson.¹⁸

San Diego County. References to the pegmatite mines and minerals are numerous, beginning with Kunz's report based on visits made shortly after the major deposits had been discovered and were being actively worked.¹³ Early surveys of mining activities and lists of mines appeared in Merrill¹⁹ and Tucker and Reed,²⁰ and lastly, in 1963, in the large report of Weber.²¹ Specific localities appear below, but many others may be found in Sterrett³ and Sinkankas,¹⁴ the last being especially complete. Much valuable historical detail appears in Rynerson's volume of reminiscences based on over five decades of mining for gemstones and specimens in San Diego County.²²

ELDER CANYON. A small quantity of gem beryl was mined from a tourmaline-pegmatite dike in Anza-Borrego State Park near Riverside Co, line, 17.5 km (11 mi) NE of Warner Springs.²¹

CHIHUAHUA VALLEY. At the Blue Bell claim, on the NE flank of the valley, 12 km (7.5 mi) N of Warner Springs, colorless to very pale, sharp, yellowish green terminated prisms of aquamarine

World Sources of Ore and Gem Beryl / United States of America

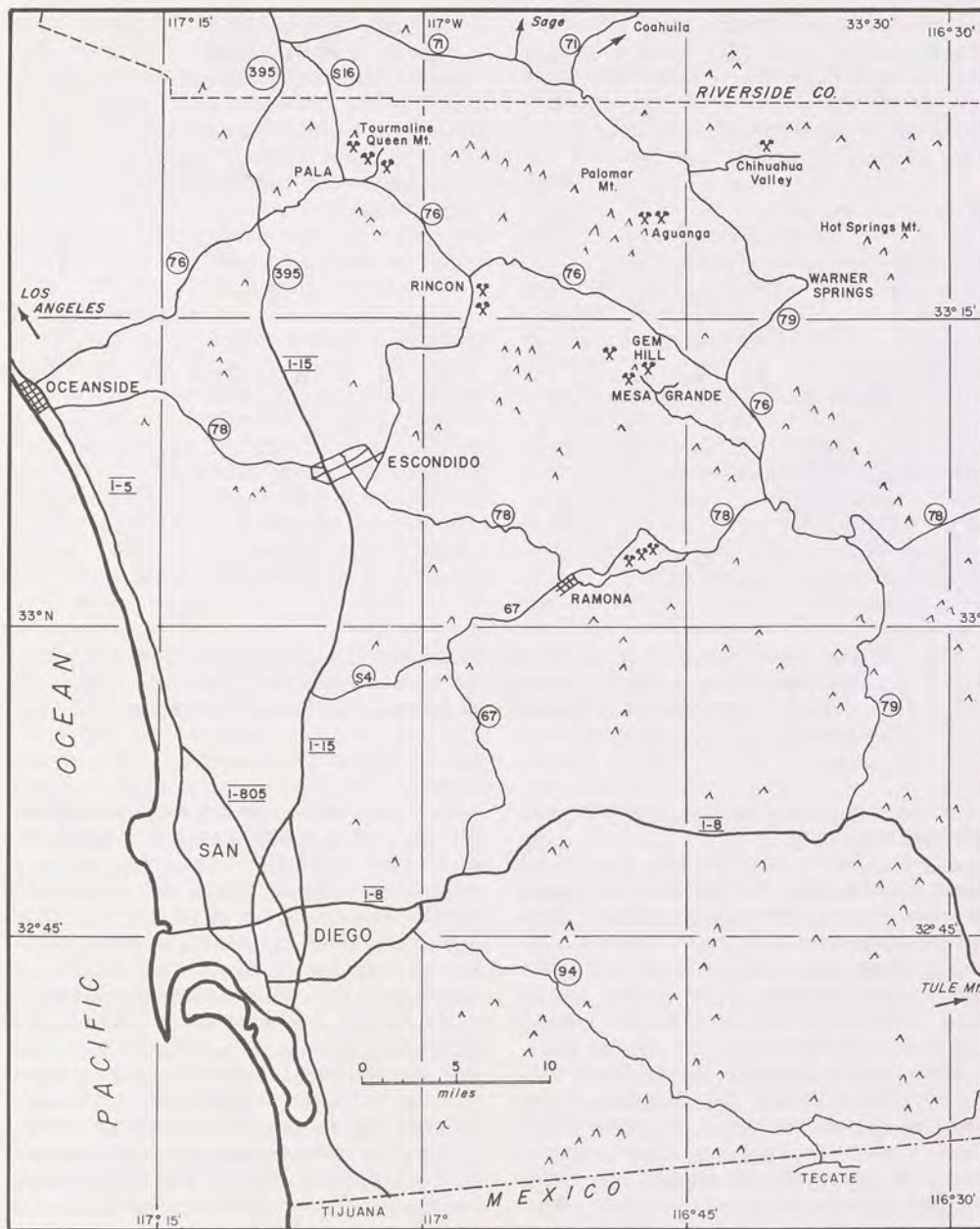

Fig. 14-74 Map of gem mines in San Diego Co. California showing the principal groups, namely, Pala, Aguanga, Rincon, Mesa Grande, and Ramona. To the north in Riverside Co., are the Sage mine and several on Coahuila Mountain and Red Mountain. A kunzite-morganite mine is also exploited on Tule Mountain, off the map at lower right.

BERYL LOCALITIES

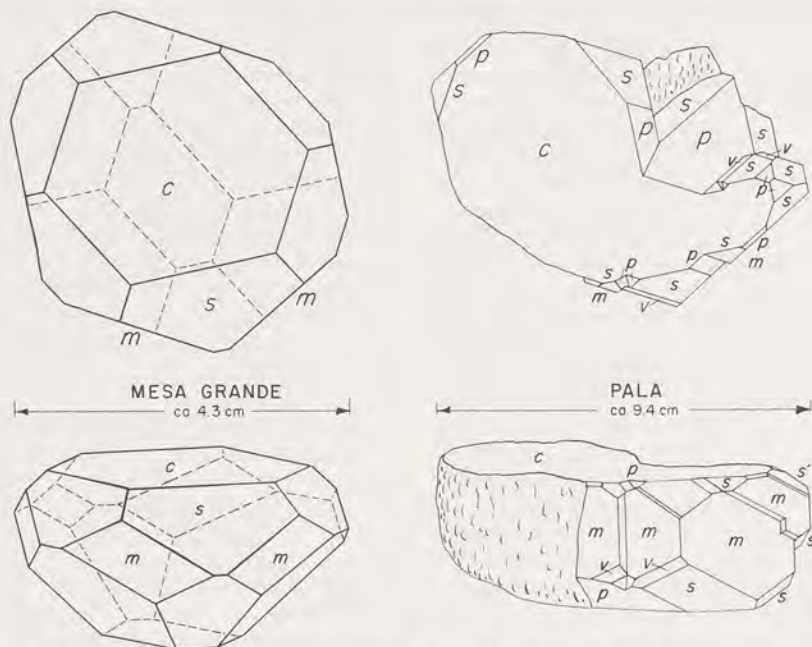

Fig. 14-75 Morganite beryl crystals from Southern California pegmatite localities. Forms: $c\{0001\}$, $m\{10\bar{1}0\}$, $s\{11\bar{2}1\}$, $p\{10\bar{1}1\}$, $v\{21\bar{3}1\}$. After W. E. Ford, "Some interesting beryl crystals and their associations," *American Journal of Science* 22 (1906).

associated with schorl, feldspar, and quartz crystals have been found.²¹

AGUANGA MOUNTAIN. This area is noted primarily for blue topaz, but Emeraldite No. 2 mine, in a flat-lying pegmatite sheet outcropping on the E edge of the crest of the narrow summit ridge, also produced pink, white, pale blue and golden beryl crystals but little of gem quality. It is located 15 km (9.25 mi) NW of Warner Springs²³ and is also described in refs. 13, 14, and 21.

MESA GRANDE DISTRICT. This is located about 6.8 km (4.25 mi) SW of Lake Henshaw Dam or about 16 km (10 mi) NW of the community of Santa Ysabel. The most important pegmatite mines, Himalaya and San Diego, exploit thin, pocket-rich bodies which are remarkably persistent for over 1.6 km (1 mi) in length but rarely exceed 60 cm (24 in) in thickness. Early history appears in Kunz¹³ and Sinkankas¹⁴; geology and mineralogy in Foord.^{24,25} Beryl crystals from the Himalaya dike are described by Ford²⁶ and Ungemach²⁷; Schaller and Fairchild describe a bay-

enite + remnant beryl pseudomorph after tabular rose beryl, giving R.I. for remnant beryl fragments of $o=1.585$, $e=1.578$.²⁸ According to Foord, morganite crystals are tabular in habit as a rule and seldom exceed $12.5 \times 10 \times 7.5$ cm ($5 \times 4 \times 3$ in).²⁵ Such crystals are commonly found as very deeply corroded glittering masses with scarcely any trace of original faces and may be of rich, apricot color, but this may fade to pink upon exposure to daylight. Thomson et al. estimate that close to \$3,000 worth of beryl was produced in 1952-1953.²⁹ Very little of it is useful for gems and it is prized mainly for specimens.

Elsewhere in the district, white and blue beryl were reported from slightly S of the Himalaya-San Diego mines, and some colorless to pink crystals were found in the Cota mine a short distance to the W.²¹ The most important beryl pegmatite in this district, however, is the Esmeralda, located ca. 2.4 km (1.5 mi) WNW of the Himalaya-San Diego mines, and noted for its fine morganite crystals and also some morganite fac-

World Sources of Ore and Gem Beryl / United States of America

eting material.^{13,14} In about 1905, some magnificent groups of tabular crystals were found up to 37 mm (1.5 in) in diameter attached to albite.³⁰ Larger crystals were found later, one of which, broken in two, and reassembled into a crystal of about 15 cm (6 in) in diameter, consisted of morganite at its termination and aquamarine below. Such crystals occur in pockets containing smoky quartz crystals, feldspar crystals, spodumene, and excellent blue tourmaline. Adjoining the Esmeralda to the S is the Trail mine, reported to have yielded aquamarine.¹⁵

PALA DISTRICT. Swarms of small to very large granitic pegmatites outcrop on three hills: Tourmaline Queen Mountain (W), Pala Chief Mountain (central) and Hiriart Hill (E), all located just N of the village of Pala and extending slightly to the NE. The area is centered about 29 km (18 mi) N of Escondido. Early mining is described by Kunz,¹³ geology and mineralogy by Jahns and Wright,³¹ and gemstones by Sinkankas.¹⁴ The district is famous for its production of superb colored tourmalines, kunzites, and more lately for fine morganites. Important mines, as well as others mentioned above, are described by Weber, including the Tourmaline King (Schuyler or Wilke) mine on NW upper flank of Tourmaline Queen Mountain.²¹ This mine provided morganite crystals from the same pockets that yielded the very large and fine pink tourmaline crystals for which this pegmatite is particularly noted. Some colorless, tabular, complexly-faced beryl crystals were also found in lower workings. High on the E side of the mountain is the Tourmaline Queen mine, noted in recent years for its exceptional terminated crystals of colored tourmaline of large size, some on matrix, and easily among the best tourmaline specimens ever found in the world. A considerable number of short prismatic to tabular morganite crystals were also found, some corroded but others with faces in excellent condition and at times reaching about 10 cm (4 in) in diameter. Rarely, such crystals were found attached to colored tourmaline on a matrix of albite-quartz. Low on the S side of the same mountain is the Stewart Lithia mine, which produced considerable pink tourmaline in small crystals and an occasional tabular pink beryl.

Some morganite was found in mines on the central hill of the group, Pala Chief Mountain, notably in the Pala Chief mine on its upper W edge, and also in the Hazel W. claim just to its

north. The latter yields considerable morganite, some of faceting grade, from pockets primarily filled with quartz crystals and feldspar crystals. Beryl was also obtained from the Ocean View claim on the NE flank, the Margarita mine on the W flank, and the Redwing prospect on the E flank.²¹

Hiriart Hill, the eastern prominence in the group, is noted mainly for production of kunzite, but large crystals of morganite were also found in pockets of the San Pedro mine, high on the NW flank, in the Senpe mine on the W flank, in the Anita claim adjacent to the S, the Katerina mine low on the SW flank, and in the Vanderburg mine on the upper S rim of the hill. However, all of these were overshadowed in importance when an enormous pocket was opened in the White Queen mine high on the SW flank which yielded the best morganite crystals ever found in North America. Notable were a series of matrix specimens comprising pale pink euhedrons of tabular to short prismatic habit perched on white to faint blue cleavelandite crystals, sometimes associated with quartz crystals and booklets of lepidolite.³² These crystals ranged in size from less than 25 mm (1 in) across to some over 12.5 cm (5 in) in diameter. Forms: large bright *c*, etched *m*, and prominent etched *s*{1121}. By 1962, about 80–120 kg (200–330 lb) of morganite crystals and fragments had been recovered, also deeply corroded, jagged masses of greenish blue aquamarine. Much of the morganite contained clear areas, and a 178 carat gem was faceted which is now in the U.S. Natural History Museum in Washington, D.C. Later work in the deposit uncovered more clear material from which a faceted gem, almost exactly 400 carats in weight, was cut, and is now the largest such gem cut from North American morganite.¹⁴ Previously, the record gem from Hiriart Hill morganite was a flawless, pale-hued gem of 50 carats, probably cut from Senpe mine material.³³ A little aquamarine was found in the El Molino mine low on the SE slope of Hiriart Hill.

RINCON DISTRICT. Swarms of narrow granitic pegmatite dikes outcrop on hills immediately N and E of the community of Rincon, located 25 km (14 mi) NNE of Escondido. The geology and mineralogy are described by Hanley,³⁴ some minerals of interest by Rogers,³⁵ and early history and production by Kunz.¹³ The Calac prospect, on a hill 3.7 km (2.3 mi) due E of Rincon) produced

BERYL LOCALITIES



Fig. 14-76 Morganite crystals, with quartz, in matrix of cleavelandite from San Pedro Mine, Hiriart Hill, Pala, San Diego Co., California. The crystal displays large faces of prism $m\{10\bar{1}0\}$, very narrow faces of prism $a\{11\bar{2}0\}$, large triangular faces of the bipyramid $s\{11\bar{2}1\}$, and traces of other forms. The morganite crystal is about 7.5 cm (3 in) long. Collection of Josephine L. Scripps. Photograph by O. D. Smith.

a number of very good prismatic crystals of pale blue, greenish blue and yellowish green to 13 mm (0.5 in) in diameter.^{21,34} The Mack mine, 2.4 km (1.5 mi) SE of Rincon, produced exceptionally fine, pale blue to pale yellowish green, short to long, prismatic crystals from a very narrow pegmatite dike only about 1 m (3 ft) thick. The prisms ranged in size from about 25 × 6 mm (1 × 0.25 in) to some that were about the same diameter but as much as 15 cm (6 in) long, with sharp, brilliant faces and excellent terminations (see fig. 9-9). Rincon beryl crystals were described by Eakle, who noted forms m and c and also $i\{21\bar{3}0\}$, $a\{11\bar{2}0\}$, $p\{10\bar{1}1\}$, $s\{11\bar{2}1\}$, and $\sigma\{11\bar{2}2\}$, and possibly $\gamma\{13.1.\bar{1}4.1\}$.³⁵ The Victor mine, 3.2 km (2 mi) SSE of Rincon also produced beryl crystals. Rogers noted forms c and m , also

$\{11\bar{2}1\}$, $\{21\bar{3}1\}$, and $\{10\bar{1}0\}$ on pale pink tabular crystals, one of which measured 25 × 18 mm (1 × 0.75 in).³⁶ Sterrett mentioned handsome aquamarine from this mine.³⁷ Morganite was also found in the Clark Extension prospect 3.5 km (2.2 mi) SSE of Rincon.¹⁵

RAMONA DISTRICT. Numerous elongated, sheet-like granitic pegmatite bodies occur in an area about 6.3 mi (4 mi) E of Ramona and are noted mainly for blue topaz, dark green tourmaline and gem spessartine. Aquamarine and pink beryl occur sparingly in some of the deposits as small morganite crystals in the A.B.C. mine, fine, etched clear crystals of greenish aquamarine in the Black Panther mine, some to 12.5 cm (5 in) long, also in the Hercules mine, Little Three, and others.^{13,14,21} Ford mentions etched yellow



Fig. 14-77 The pegmatite body of the Mack Mine, Rincon, San Diego Co., California, source of magnificent slender prisms of blue-green aquamarine.

beryl crystals from this district²⁶ while Eakle describes short prismatic doubly-terminated rose crystals displaying forms m and c , also $s\{11\bar{2}1\}$ and $p\{10\bar{1}1\}$.³⁵ Sterrett³⁷ reported production of about 8 kg (20 lb) of white beryl, along with some aquamarine crystals from the Hercules mine in 1909. The geology of the district was described by Simpson.³⁸ Recent mining in the Little Three mine, rewarded by discovery of outstanding blue topaz crystals on matrix and dark green tourmaline crystals, uncovered a few unusual pink beryl

crystals not over 5 cm (2 in) long that assumed a long prismatic rather than tabular habit. Aside from the aquamarine from the Black Panther mine mentioned above, none of the beryl has been cut into gems.

JACUMBA DISTRICT. The Crystal Gem mine, low on NW slope of Tule Mountain, 11 km (7 mi) NW of Jacumba, produced some pale green beryl crystals. Possibly this mine or one close to it was recently opened under the claim title of Beebe Hole, from which a considerable quantity

BERYL LOCALITIES

of gemmy spodumene crystals was recently extracted as well as some morganite.²¹ Common beryl, in prisms from less than 25 mm (1 in) to as much as 60 cm (24 in) long, was found in pegmatite about 0.8 km (0.5 mi) N of Tule Mountain.³⁹

1. Blake, W. P. 1853. Report on a geological reconnaissance in California. *American Journal of Science* (New Haven) ser. 2, vol. 17, p. 438.
2. Eakle, A. S. 1914. Minerals of California. *California State Mining Bureau Bulletin* 67 (San Francisco) 226 pp.
3. Murdoch, J., and Webb, R. W. 1966. Minerals of California: Centennial volume (1866-1966). *California Division of Mines and Geology Bulletin* 189. 559 pp.
4. Sterrett, D. B. 1915. Gems and precious stones. Chapter in *U.S. Geological Survey Mineral Resources of the United States for 1914*, pp. 307-46.
5. Schaller, W. T. 1916. Gems and precious stones. Chapter in *U.S. Geol. Min. Res. of the U.S. for 1915*, pp. 843-58.
6. Wright, L. A. 1957. Beryllium. Chapter in *Mineral commodities of California. California Division of Mines & Geology Bulletin* 176, pp. 75-8.
7. Benson, W. T. 1962. Inyo beryl deposit, Inyo County, California. *U.S. Bureau of Mines Reports of Investigation* 6013. 9 pp.
8. Neuerberg, G. J. 1954. Allanite pegmatite, San Gabriel Mountains, Los Angeles County, California. *American Mineralogist* 39:831-4.
9. Jahns, R. H. 1954. Geology of the Peninsula Range province, Southern California and Baja California. In: *Geology of Southern California. Calif. Div. of Mines Geol. Bull.* 170, pp. 29-52.
10. ———. 1954. Pegmatites of Southern California. In: *Geology of Southern California. Calif. Div. of Mines Geol. Bull.* 170, pp. 37-50.
11. ———. 1954. Geologic guide no. 5 Northern part of the Peninsular Range province. *California Division of Mines Geol. Bull.* 170. 59 pp.
12. Thomas, B. E. 1961. *Guidebook for Field Trips: Meeting at San Diego State, 1961*. Geological Society of America. San Diego: San Diego State College. 67 pp.
13. Kunz, G. F. 1905. Gems, jewelers' materials, and ornamental stones of California. 2nd ed. *Calif. State Min. Bur. Bull.* 37. 171 pp.
14. Sinkankas, J. 1976. *Gemstones of North America*. 2 vols. New York: Van Nostrand Reinhold Co. 675, 494 pp.
15. Sterrett, D. B. 1908. Precious stones. Chapter in *U.S. Geol. Sur. Min. Res. of the U.S. for 1907*, pp. 795-842.
16. Webb, R. W. 1943. Two andalusite pegmatites from Riverside County, California. *American Mineralogist* 28:581-93.
17. Kunz, G. F. 1905. Precious stones. Chapter in *U.S. Geol. Sur. Min. Res. of the U.S. for 1904*, pp. 941-87.
18. Tucker, W. B., and Sampson, R. J. 1945. Mineral resources of Riverside County. *California Division of Mines Report* 41, pp. 121-82.
19. Merrill, F. J. H. 1914. Geology and mineral resources of San Diego and Imperial counties. *Calif. State Mining Bureau State Mineralogist's Report*, vol. 14, no. 5. 113 pp.
20. Tucker, W. B., and Reed, C. H. 1939. Mineral resources of San Diego County. *Calif. Journal of Mines and Geology* 35:8-78.
21. Weber, F. H. 1963. Geology and mineral resources of San Diego County, California. *Calif. Division of Mines & Geology County Report* 3. 309 pp.
22. Rynerson, F. 1967. *Exploring and Mining for Gems and Gold in the West*. Healdsburg: Naturegraph Company. 204 pp.
23. Ware, J. W. 1935. Gem mining in San Diego County, California. *Gems & Gemology* 1:218-9.
24. Foord, E. E. 1976. *Mineralogy and Petrogenesis of Layered Pegmatite-Aplite Dikes in the Mesa Grande District, San Diego County, California*. Ph.D. Dissertation. Stanford University. 326 pp.
25. ———. 1977. The Himalaya dike system. *Mineralogical Record*, 8:461-74.
26. Ford, W. E. 1906. Some interesting beryl crystals and their associations. *American Journal of Science* 22:217-23.
27. Ungemach, H. 1912. Notes minéralogiques [beryl, Mesa Grande]. *Annales de la Société Géologique de Belgique* (Liège) sect. M, vol. 39, pp. 419-28.
28. Schaller, W. T., and Fairchild, J. G. 1932. Bavenite, a beryllium mineral, pseudomorphous after beryl, from California. *American Mineralogist* 17:409-22.
29. Thomson, R. D.; Switzer, G.; and Blankenbaker, E. V. 1954. Gem stones. Chapter in *U.S. Bureau of Mines Mineral Yearbook for 1953*, pp. 479-93.
30. Kunz, G. F. 1906. Precious stones. Chapter in *U.S. Geol. Sur. Min. Res. of the U. S. for 1905*, pp. 1323-58.
31. Jahns, R. H., and Wright, L. A. 1951. Gem- and lithium-bearing pegmatites of the Pala district, San Diego County, California. *Calif. Div. Mines Special Report* 7-A. 72 pp.
32. Dawson, N. E. 1963. The development of the White Queen mine. *Lapidary Journal* 17:522-25.
33. Everitt, A. 1945. Recent beryl finds near Pala, California. *Rocks & Minerals Magazine* (Peekskill, N.Y.) 20:263.
34. Hanley, J. B. 1951. Economic geology of the Rincon pegmatites. *Calif. Div. Mines Spec. Rept.* 7-B. 24 pp.
35. Eakle, A. S. 1907. Notes on lawsonite, columbite, beryl, barite, and calcite. *University of California Publications, Bulletin of the Department of Geology* (Berkeley) 5, no. 6, pp. 81-94.
36. Rogers, A. F. 1910. Minerals from the pegmatite veins of Rincon, San Diego County, California. *Columbia University School of Mines Quarterly* (New York) 31:208-18.
37. Sterrett, D. B. 1910. Gems and precious stones. Chapter in *U.S. Geol. Sur. Min. Res. of the U.S. for 1909*, pp. 739-808.
38. Simpson, D. R. 1965. Geology of the central part of the Ramona pegmatite district, San Diego County, California. *Calif. Div. Mines & Geol. Spec. Rept.* 86, pp. 3-23.
39. Weber, F. H. 1962. A beryl discovery in southeastern San Diego County, California. *Calif. Div. Mines & Geol. Mineral Information Service*, vol. 15, no. 2, pp. 8-11.

YUGOSLAVIA

Granitic pegmatites with beryl outcrop at Slavovski Kobaš, W of Slavovski Brod on Save River in Slavonia; species include quartz, muscovite, schorl, rare stilbite, talc, fluorite, pyrite and psilomelane. Beryl crystals occur to 10 cm (4 in) long, colorless or blue green, forms *m* and *c* also {1011}, {1121}, {1120}, and {3144}. Some crystals are multiples as shown by sectorial development and resulting slight biaxiality. Analyses are furnished in Koch.¹

Beryl occurs in Bosnia, at Montajica and in the neighborhood of Plana village, W of Mount Zeljin.²

1. Koch, F. 1905. Ein Beryll aus dem Gebirge Motajica Planina in Bosnien. *Zeitschrift für Kristallographie und Mineralogie* (Leipzig) 40:298.
2. Maksimovic, Z. D., and Divljan, S. V. 1953. [Geology and mineral deposits of the neighborhood of Plana village, west of Mt. Zeljin, Yugoslavia]. *Zbornik Radova Geoloski Institut N. R. Srbije* (Beograd) 33:223-56.

ZAIRE

Granitic pegmatites and cassiterite-quartz veins containing beryl occur in a broad belt running N-S in the extreme E and bordering Uganda, Rwanda, Burundi, Tanzania, and Zambia.

Oriental Province

In 1958, Compagnie Minière des Grands Lacs Africains exploited beryl pegmatites near Mapepe, located ca. 400 km (250 mi) NE of Kisangani (Stanleyville). Including production from Kobokobo district of Kivu Province (see below), 1,686 m tons of ore, averaging 10-13% BeO, were shipped to the U.S.A.

Kivu Province

Many pegmatite bodies outcrop in a broad N-S belt passing through the center of the province; these contain quartz, feldspar, mica, tourmaline, some spodumene, and a little beryl, the latter are found especially in pegmatites in the triangle Kabunga-Walikale-Mole in Kabuna region, ca. 120 km (75 mi) NW of Lake Kivu.¹ In N Lugulu region cassiterite-columbotantalite veins contain accessory beryl.² Minor beryl occurs in alluvial concentrates of cassiterite-columbite over the entire N Lugulu region, with richest beryl concentrations found near Lugulu. At Lusinko, W. of Kamituga in the S portion of the province, zoned pegmatites, partly albitized, contain columbite

and beryl. This area, also known as Maniema, is noted for many large and small pegmatites and associated quartz veins, the latter containing tourmaline, lithium and other micas, beryl, columbite, cassiterite, wolframite, topaz, fluorite, and sulfides, and mined for cassiterite.³ The Kobokobo pegmatite in this region was one of the world's largest producers of beryl and also produced columbite and cassiterite; it is further remarkable for an important content of U-Th.⁴ During 1957-58, 5,436 tons of beryl, 124 tons of columbite, and 23 tons of cassiterite were produced in the Kamituga region located approximately 115 km (65 mi) WNW of the N end of Lake Tanganyika. Much of the beryl was mined as large crystals from the complex Kobokobo pegmatite in a zone of albite-beryl-microcline. Small beryl crystals are noted in pegmatites at Twangitza near Kamituga.

Katanga Province

Granitic pegmatite bodies and cassiterite-quartz veins occur in a belt from Baudoinville on the W shore of Lake Tanganyika SE to Kiambi, Manono, and through the Kibara Mountains.^{5,6} The enormous Manono pegmatite body in these mountains has received special attention from geologists and has been traced over an outcrop length of 14 km (8.7 mi), widening in places to 700 m (2,300 ft), surely the largest such granitic pegmatite body so far discovered in the world! It is the most important source of cassiterite in Zaire.^{7,8,9,10} The pegmatite is emplaced in mica schist that covers a large granite body and shows strong alteration to a depth of 80 m (260 ft) where exposed in opencuts.⁶ Species include giant crystals of microcline-perthite, graphic granite, also albite-cleavelandite, cassiterite, niobates, tantalates, spodumene, beryl, black and colored tourmalines, apatite, zircon and garnet.⁸

Kasai Province.

Beryl is "fairly common" in the sands of the Kasai River and its tributaries the Tshikapa, Longatchimo, and Tshipumbu.¹¹

1. Legraye, M. 1954. Quelques observations sur les pegmatites de la région du Kabunga (Kivu, Congo Belge). *Annales de la Société Géologique de Belgique*, (Liège) 78:31-40.
2. De Kun, N. 1959. Les gisements de cassitérite, et de columbo-tantalites de Nord Lugulu, Kivu, Congo Belge. *Annales de la Société Géologique de Belgique* 82:m81-m196.

BERYL LOCALITIES

3. Varlamoff, N. 1948. Cassiterite deposits in the Kalamia region, Maniema, Belgian Congo. *Annales de la Société Géologique de Belgique* 70:B194-B237.
4. Safiannikoff, A., and Wambeke, L. Van 1967. La pegmatite radioactive à béryl de Kobokobo et les autres venues pegmatitiques et filoniennes de la région de Kamituga - Kivu, République du Congo. *Mineralium Deposita* (Berlin) 2:119-30.
5. Buttgenbach, H. 1925. *Minéralogie du Congo Belge*. Bruxelles: M. Hayez, 183 pp.
6. Aderca, B. 1955. La mine des Kibara (Katanga, Congo Belge). *Mémoires, Académie Royale des Sciences Coloniales, Classe des Sciences Naturelles et Médicales* (Brussels) n.s., vol. 3, fasc. 2, 77 pp.
7. Thoreau, J. 1948. Pegmatites et minéralisations connexes du Congo Belge Oriental et Ruanda-Urundi. *Reports, 18th International Geological Congress, London, 1948*, pp. 282-7.
8. ———. 1949-50. Pegmatites et minéralisations de l'Est du Congo. *Annales de la Société Géologique de Belgique, Mémoires*, 73, pp. 258-61.
9. ———. 1950. La pegmatite stannifère de Manono, Katanga. *Comptes Rendus Congress Scientifique Elizabethville, Comité Spécial du Katanga, Commémorative cinquantième Anniversaire*, 2, pp. 244-69.
10. ———. 1953. Minéraux lithiques de pegmatites du Congo Belge et du Ruanda. *Bulletin de l'Académie Royale de Belgique, Classe des Sciences*, (Brussels) ser. 5, vol. 39, pp. 684-7.
11. Edwards, M. G. 1917. Diamond-bearing gravel from Belgian Congo. *American Mineralogist* 2:88-9.

ZAMBIA

Beryl occurs in granitic pegmatites near the borders with Malawi, Mozambique and Zimbabwe. Only the mines around Lundazi produced commercial ore: 19 long tons in 1955, 2 long tons in 1960. The Lundazi pegmatites are generally small, intrude paragneisses and schists of the basement complex, and display well-defined quartz cores, along the margins of which occur the beryl crystals. The Aries mine near Lundazi is noted for mica but produced some beryl, while the nearby Aries II mine also produced beryl, some said to be "near gem quality."¹ Also in this area are the Libra mine, about 73 km (46 mi) N of Lundazi and the Lumimba mine, about 48 km (30 mi) WSW of Lundazi, both of which contained beryl.

A central group of pegmatites includes those around Kapiri Moshi, 40 km (25 mi) NNE of Kabwe (Broken Hill) and the Miku bodies about 48 km (30 mi) W of Ndola. The Kapiri Moshi bodies lie on the N side of a tributary of the Mulungshi River about 11 km (7 mi) SW of Kapiri Moshi.

A southern group of pegmatite bodies lies along the border with Mozambique and Zimbabwe and terminates at the W near Choma. The

Nyati and Naseka Hill bodies are ENE of Rufunsa about 135 km (85 mi) SE of Kabwe. Another group is in Lusita River valley about 142 km (90 mi) S of Kabwe and includes the Munyumwezi, Sachenga, and Siakalinda mines. The Phoenix mine is ESE of Choma about 40 km (25 mi).

Miku Emerald Deposit. This deposit is SSW of Kitwe, 13°04'01" S, 28°03'30" E and named after the nearby Miku River, a tributary of the Kufubu, the latter a tributary of the Kafue River. It was discovered in 1931 by G. J. Baker but no work was done until some time after 1962.^{2,3} The deposit was examined by Hickman and by 1973 some emeralds had been produced.⁴ These are mostly single prismatic crystals in biotite-phlogopite schist in which small crystals of tourmaline also occur. Associated rocks include talc-magnetite schist, quartz-amphibolite-chlorite schist with fine veinlets of quartz, and larger veins of quartz. Forms predominantly *m* and *c*; bipyramids have been noted on some crystals. Most are small but others reach 20 cm (8 in) long; in all crystals, clear areas are not large so that cut gems of satisfactory jewelry grade seldom exceed one-half carat. Inclusions are abundant: micas, rutile, and apatite. Colors range from milk-white beryl to pale green and thence into the fine green of good quality emeralds but with a greenish-yellowish tint reminiscent of Sandawana emeralds.

Table 14-52
ANALYSIS OF MIKU EMERALD³

	Percent		Percent		Percent
SiO ₂	62.23%	MnO	0.02	Cs ₂ O	tr.
Al ₂ O ₃	15.41	MgO	0.76	H ₂ O +	2.59
Cr ₂ O ₃	0.33	CaO	0.31	H ₂ O -	0.06
Fe ₂ O ₃	0.04	Na ₂ O	2.63	Total	99.24
FeO	0.07	K ₂ O	2.89		
BeO	11.90	Li ₂ O	nil		

Bank determined R.I. $d = 1.585-1.590$, $e = 1.580-1.583$, diff. 0.008-0.010, $G = 2.71-2.75$.³

In about 1978, according to Kanis, "vast" quantities of emeralds were being produced from the nearby Kafubu field which lies just to the SW of Miku in a roughly rectangular area lying between the Mtonda River to the SW, the Kafubu River to the NE, and the Kafue River to the SE.⁵ Deposits include Kamakanga (the first discovered), Pirala Diggings, W. Mtonda, Mtonda, S.

World Sources of Ore and Gem Beryl / Zimbabwe (Rhodesia)

Pirala, Chitanti, and Chief Nkana's mine. The deposits are schist-type, in micaceous schist adjacent to pegmatites, of which there are a large number. Not only are the emerald crystals abundant, they have been found to as much as 130 carats (Kamakanga) and quite clear. Emeralds also are reported from alluvial occurrences. The large production of substantial high-quality stones has made "Zambia the world's largest producer of fine quality emeralds during the last few years" and "therefore, the emerald potential of this large area appears to be enormous."⁵

Another remarkable feature of at least one specimen of the Zambian emeralds is the extremely high refractive indices recorded by Bank, for an exceptionally dark gem containing considerable iron in addition to chromium. Because of its unusually dark color its identity was verified by x-ray diffraction pattern.⁶ Tests gave R.I. $\alpha = 1.602$, $e = 1.592$, diff. 0.010, uniaxial negative, thus being "apparently the highest hitherto recognized [refractive indices] for natural emeralds," with the high values being attributed to a very high iron content in addition to normal chromium.⁶

1. Reeve, W. H. 1963. The geology and mineral resources of Northern Rhodesia. *Geological Survey of Northern Rhodesia Bulletin* 3, (Lusaka) pp. 142-4.
2. Bank, H. 1973. Ein neues Smaragdorkommen in Zambia (Miku-Deposit). *Zeitschrift der deutschen gemmologischen Gesellschaft* (Idar-Oberstein) 22, no. 2, p. 60.
3. ———. 1974. The emerald occurrence of Miku, Zambia. *Journal of Gemmology* 14:8-15.
4. Hickman, A. C. J. 1972. The Miku emerald deposit. *Republic of Zambia Geological Survey Department Economic Report* 27.
5. Kanis, J. 1980. Gemstone news from Southern Africa. *Zeits. der deutsch. gemmol. Ges.* 29, no. 1/2, pp. 55-7.
6. Bank, H. 1980. Sehr hochlichtbrechender Smaragd aus Sambia. *Zeits. der deutsch. gemmol. Ges.* 29, no. 1/2, pp. 101-3.

ZIMBABWE (Rhodesia)

Beryl-bearing pegmatites occur in a number of areas and have been mined for ore. For example, in the twelve-year period ended 1962, nearly 10,000 tons were produced.¹ Much of the beryl was recovered from dumps of mines previously worked for cassiterite, tantalite, and mica. The distribution and extents of the fields are shown in fig. 14-78. Except for the Miami-Urungwe field, all bodies lie within or close to metasedimentary schist belts which contain schists, greenstones, banded ironstones, and serpentines of Precambrian age lying upon and associated with base-

ment granites and granite-gneisses. Beryl pegmatites in the Miami-Urungwe field are emplaced in Precambrian high-grade metamorphics as granite paragneisses, amphibolites, and sillimanite schists. Recently emerald deposits of considerable importance have been found.

Miami Mica Field. This is in the Urungwe district, about 192 km (120 mi) NW of Salisbury centered in Karoi Township. Most pegmatite bodies are short, lenticular, usually contain well-developed quartz cores, and are commonly complex in mineralization.^{2,3} Beryl crystals are simple in form, and white, green, reddish, yellow, brown, and dark gray and up to 140 × 20.5 cm (48 × 8 in) in size. A single crystal from Queen Anne mine, Buffroi Farm, weighed 367 kg (807 lb). As of 1961, over 180 mines were recorded as producing a total of 1,186.83 tons, of which 20% came from mines on Ruwanzi Ranch. A minor schist-type emerald occurrence was recorded near Karoi.⁴

Mount Darwin. Rusambo mica field produced some ore beryl.

Mazoe Field. This is centered about 79 km (50 mi) NNE of Salisbury. Small crystals of several cm occur in greisenized pegmatite with albite and cassiterite on Hopedale Farm, 6.4-7.9 km (4-5 mi) due S of Avilin Siding on Bindura-Shamva railroad. On Ruia Falls Estate, 51 km (32 mi) N of Bindura, common beryl occurs. A locality for emerald "20 miles north of Salisbury" was recorded in 1961.⁵

Mrewa Field. Beryl has been found on Fungwe Gem claim near New Full Back Gold mine on W bank of Nyadiri River.

Mtoko Field. White beryl occurs in alluvial deposits on Mataka and Benson claims, Mtoko Reserve, 34 km (20 mi) N of Mtoko, the latter 130 km (80 mi) ENE of Salisbury. Attractive green to blue crystals have been found nearby on Rabbit Warren claims in a large massive quartz outcrop; the pegmatites are greisenized.⁶ A number of deposits in this field were described by Hornung and Knorring.⁷

Salisbury Area. Beryl found in pegmatites on Augustus claims, Willesden and Lichfield farms, 29 km (18 mi) NNE of the city. About 24 km (14 mi) NE of the city, beryl occurs on Hotspur, Mauve, and Ceander claims; on Chishawasha Farm, 19 km (14 mi) NE of Salisbury, a large greisenized body contains massive white beryl, some in pink hexagonal crystals, and noted primarily for large quantities of topaz associated

BERYL LOCALITIES

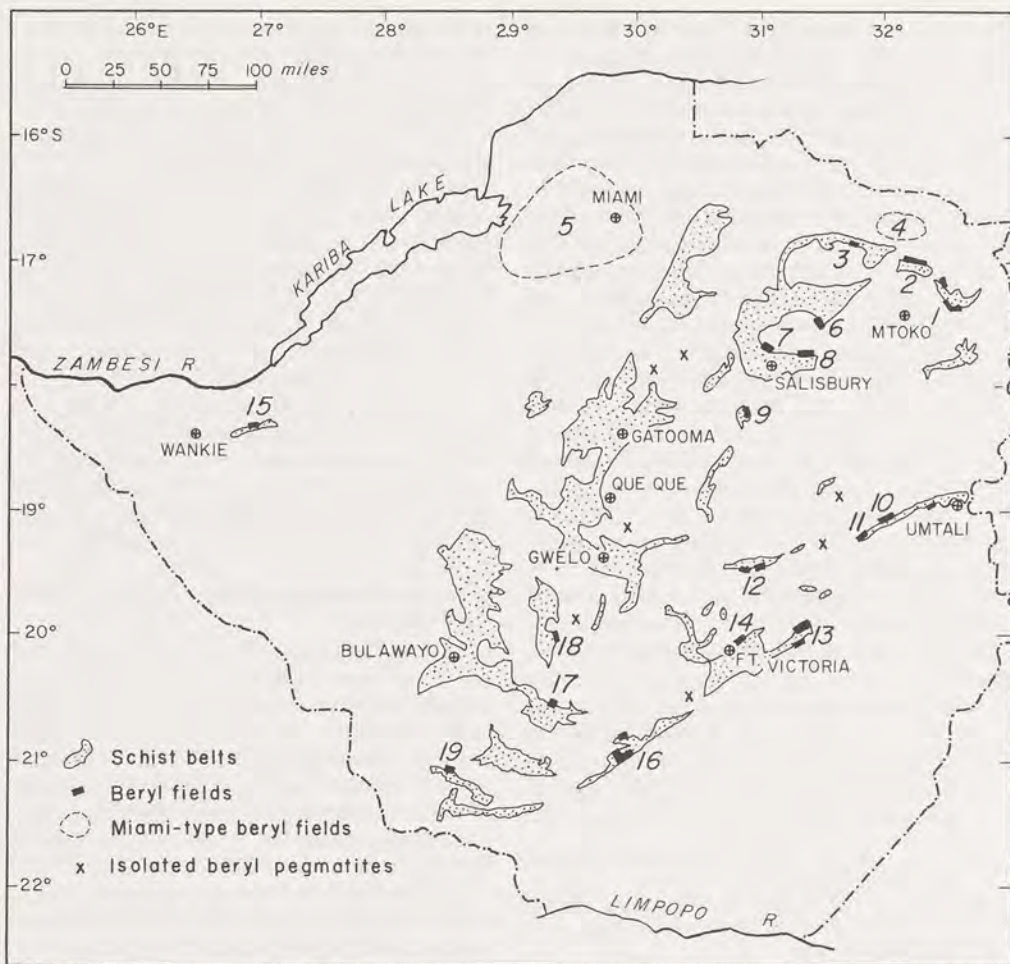

Fig. 14-78 Sketch map showing areas of granitic beryl-bearing pegmatites associated with schist belts of Shamvaian, Bulawayo, and Sebakwian ages. The specific fields are 1. Makaha, 2. Pfungwe, 3. Mt. Darwin, 4. Chimanda, 5. Urungwe, 6. Bindura, 7. Dombashawa, 8. Arcturus, 9. Beatrice, 10. Odzi, 11. Bepe, 12. Felixburg, 13. Bikita, 14. Ft. Victoria, 15. Lutope, 16. Sandawana, 17. Filabusi, 18. Ft. Rixon, 19. Antelope. After K. C. Branscombe, "Beryl in Southern Rhodesia," *Pegmatites in Southern Rhodesia, A Symposium*, Salisbury, Southern Rhodesian Section, Institute of Mining & Metallurgy (1963).

with coarsely-crystalline lepidolite and tantalite and microlite. Beryl occurs on Elizabeth claims, Rietpoort Farm, near the Salisbury-Domboshawa road. Small crystals occur in exposed pegmatite veins in quarries S of Salisbury.

Lutope. This area is near Wankie in the extreme W tip of the country where cassiterite peg-

matites in biotite-muscovite-quartz schists and gneisses contain very small crystals.^{8,9}

Odzi Field. About 160 km (100 mi) SE of Salisbury, W of Umtali, there are zoned, complex pegmatite bodies from which important amounts of ore beryl were mined at Bepe claims, and Corundum Blue claims near confluence Mwerahare

World Sources of Ore and Gem Beryl / Zimbabwe (Rhodesia)

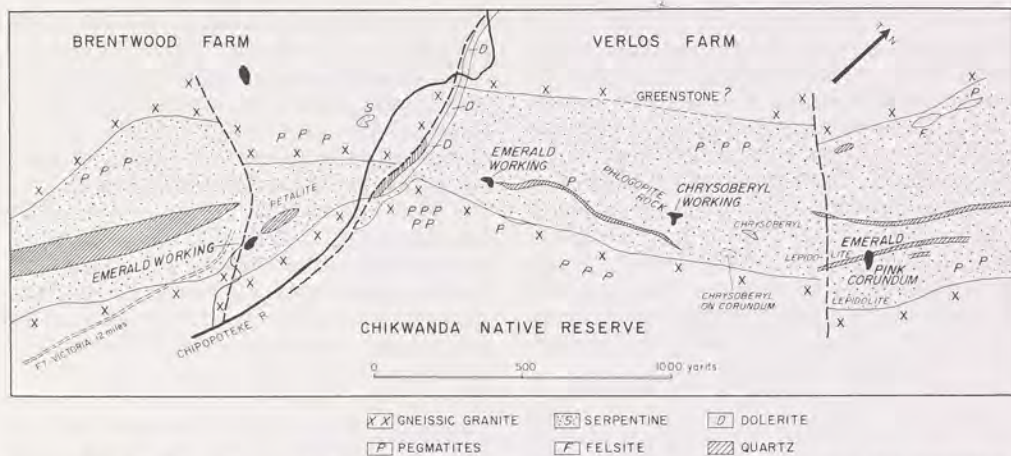

Fig. 14-79 The Novello emerald-chrysoberyl claims in the Victoria District, Zimbabwe. The serpentine mass containing the deposits is interrupted by three faults shown in heavy dashed lines. After a map of the Southern Rhodesia Geological Survey.

and Watanika rivers; small clear crystals of blue corundum in greisenized country rock xenoliths are found in pegmatites of the last claim.

Felixburg Field. An area about 48 km (30 mi) NNE of Fort Victoria. Beryl occurs in granitic pegmatites along the S margin of Felixburg schist belt from E end of Matesi Hills to Serima Native Reserve as well formed green crystals; during 1953-59 a total of 86.78 tons of ore beryl was produced from Brass mine, Centenary mine, and Serima claims.¹⁰ Other bodies also contain beryl crystals but these are too small for economical recovery.

MAYFIELD FARM EMERALD. Anderson described a new occurrence on this farm in 1976.¹¹ The claims are located in the NW corner of the tract, about 12 km (7.5 mi) NE of Fort Victoria and were first staked in 1970 but are now owned and operated by Callock (Pvt.) Ltd. The crystals occur in a "glassy quartz reef that is conformable with the country rocks [schists]" and exposed in an open-cut and several trenches.¹¹ Properties of the emerald are: $n_o = 1.589 \pm 0.001$, $n_e = 1.584 \pm 0.001$, $\text{diff.} = -0.005$; $G = 2.72$. Cr, Ni, Cu, Fe detected spectrographically; Cr estimated 0.20-0.25%; marked dichroism and color banding. Absorptions at 5202, 5206, 5208 Å strong; weaker at 5345, 5348, 5409 Å; strong band at 4289 Å. Small platelets of phlogopite occur as inclusions in addition to drop-shaped cavities,

thus giving the stones a "peppered" appearance; fine tubes penetrate the crystals parallel to the c -axis and other types of irregular cavities with or without gas-liquid also occur.

Bikita Field. An area about 80 km (50 mi) E of Fort Victoria. Mineralogically, these famous flat-lying granitic albitized pegmatite bodies contain muscovite, lepidolite, beryl, cassiterite, tourmaline, tantalum minerals, and lithium minerals.¹² Much white beryl was found on the surface along the W flank of a ridge nearly 1.6 km (1 mi) long, formed by a large greisenized pegmatite body. Beautiful mineral specimens include coarsely crystallized aggregates of lepidolite, also spodumene, some clear petalite, small sharp crystals of cassiterite, tantalite, and microcline.⁶ Beryl is also found in pegmatite of Mauve Kop on Mdara claims, and on Chakari claims about 24 km (15 mi) NE of the Bikita mines. A minor emerald occurrence was recorded at Chikwanda, about 6 km (3.8 mi) N of Bikita mines.⁴ Inclusions in the emeralds were described by Anderson.¹³

VICTORIA FIELD EMERALD. Among other prospects this area includes the well-known deposits of the Novello prospect and the abandoned Twin Star mine, both located about 17 km (10.6 mi) NW of Fort Victoria.¹⁴ Emeralds and chrysoberyls were discovered here in 1960 by Mrs. C. Girdlestone, with the deposit becoming primarily fa-

BERYL LOCALITIES

mous for twinned chrysoberyl crystals of very dark color, providing excellent mineral specimens.⁴ Some of the latter contain very small clear areas capable of cutting into faceted gems of the alexandrite variety. At the Novello deposit, the country rock is gneissic granite containing a large, elongated band of serpentinite intruded by numerous pegmatite bodies and several quartz veins; common beryl occurs in the pegmatites but the emeralds and chrysoberyls formed within phlogopite shells or lenticles, "the emeralds being in close proximity to the pegmatite, and are also found in the pegmatite walls."⁴ Cross sec-

tions of the Novello mines as well as of the Twin Star are given in Metson & Taylor, who also furnished information on the crystals of emerald and their properties.¹⁴ Two mines were worked on the Novello property, consisting of prospect pits and opencuts of no great depth in "an area of mica-rock intruded by numerous pegmatite stringers."¹⁴ The Twin Star workings are much more extensive, and during 1965-69 they recorded production of £ 2,650 of emeralds. Apparently few crystals from this field exceed several cm in length and the colors tend to be pale. Properties of the emeralds are summarized below:

Table 14-53
PROPERTIES OF VICTORIA FIELD EMERALDS

Deposit	<i>o</i>	<i>e</i>	<i>diff.</i>	SG	Reference
Novello emerald	1.576	1.572	-0.004	2.71-2.74	4
Novello beryl	1.576	1.570	0.006	2.66-2.67	14
Novello emerald	1.581	1.576	0.005	2.68-2.74	14
Novello emerald	1.572	1.576	0.004	—	13
Novello emerald	1.574	1.580	0.006	—	13
Twin Star emerald	1.586	1.580	0.006	2.67-2.71	14
Twin Star emerald	1.592	1.586	0.006	—	13

Inclusions are mica flakes, rarely tourmaline,⁴ also minute cavities which may contain bubbles which impart a "peppered" appearance; the latter are typical, angular cavities, with two-phase contents, and fine negative crystals. Detailed descriptions are given of inclusions in Anderson¹³ and Metson and Taylor.¹⁴

Belingwe-Sandawana Field. A small area of granitic pegmatites with minor occurrences of beryl is located ca. 105 km (65 mi) SW of Fort Victoria; claims include Jaka, Lucksy, and Sugar Lily; the Lucksy produced less than a ton of ore beryl in 1953.¹⁵ Of far greater interest is the most important emerald deposit of Zimbabwe, located near Sandawana or about 120 km (75 mi) SW of Fort Victoria, or ca. 20°55' S, 29°56' E.¹⁶ Martin gave the locality as the S side of the Mweza range of hills, 3.25 mi (5.2 km) WSW of the confluence of Nuanetsi and Sungai (Mutsume) rivers.⁴ Gem quality crystals of small size but beautiful intense green were found here in 1956 by prospectors L. J. Contat and C. J. Oosthuizen.^{4,17} When the im-

portance of the find became obvious, Sandawana Emeralds, S. A., a Geneva corporation, was formed to exploit the deposit and market the stones.¹⁷ Samples sent to the United States for evaluation comprised an initial shipment of 1.27 ounces. These produced 40 cut stones weighing together 6.54 carats and valued at \$375, but a second parcel, "weighing 5.6 ounces, produced 200 carats of cut gems valued at about \$6,000."¹⁸ By 1959, ownership of the property, now called the Zeus claims, passed to Rio Tinto (Rhodesia) Ltd., who formed Sandawana Mines (Pvt.) Ltd. to take over mining and distribution of the stones.⁴

The Mweza Range contains a core of metasediments with inclusions of banded ironstones, phyllites, sericite-quartz schists, and quartzites, all tightly folded. Very narrow peridotite sills, altered to serpentinites and allied rocks, intrude older rocks. The range rocks are flanked by basalts and dolerites metamorphosed into greenstones and epidiorites. Granites and associated

World Sources of Ore and Gem Beryl / Zimbabwe (Rhodesia)

pegmatites intrude the range rocks with emeralds occurring in tremolite schists adjacent to the granitic pegmatites.^{13,16} Many of the pegmatite bodies contain beryl, lepidolite, petalite, spodumene, and Ta-Nb species. Local metamorphism due to the granite intrusives is believed responsible for the formation of emeralds as in similar deposits in the Urals, Transvaal, Pakistan, etc.

Few of the emerald crystals are well developed; most are badly broken and near the surface, encrusted in limonite. Cut gems of one-quarter carat of reasonable clarity are therefore rarely produced, but the color is a "superb verdant green with a brightening yellow glint that renders the stones very vivid."¹⁶ Most of the small cut stones are quite clean, but they have been deliberately cut to make them so. Of 92 gems received by Gübelin in 1958, the largest was only 1.56 ct.¹⁶ Gübelin included an analysis but expressed doubts as to its accuracy due to the small size of the sample; his analysis is given in table 14-54, along with one by Martin.⁴

Table 14-54
CHEMICAL ANALYSES OF SANDAWANA
EMERALDS

Gübelin ¹⁶					
	Percent		Percent		Percent
SiO ₂	65.0	Cr ₂ O ₃	0.5	Na ₂ O	2.0
Al ₂ O ₃	14.2	Fe ₂ O ₃	0.5	Li ₂ O	0.15
BeO	13.6	MgO	3.0	Total	99.0
G = 2.744-2.768; mean 2.756					
Martin ⁴					
	Percent		Percent		Percent
*SiO ₂	63.84	FeO	0.30	K ₂ O	0.05
Al ₂ O ₃	19.00	MgO	0.75	H ₂ O +	1.07
BeO	13.28	Na ₂ O	2.03	Total	100.08
Cr ₂ O ₃	0.60	Li ₂ O	0.10		

*-Chingachura, near Sandawana

Table 14-55
REFRACTIVE INDEXES OF SANDAWANA EMERALDS¹⁶

Wave Length:	B	D	E	F	Dispersion	
	6870 Å	5890 Å	5270 Å	4860 Å	4550 Å	4550-6970 Å
<i>o</i>	1.590	1.593	1.596	1.599	1.601	0.011
<i>e</i>	1.583	1.586	1.589	1.592	1.594	0.011
diff.	0.007	0.007	0.007	0.007	0.007	

Table 14-56
REFRACTIVE INDEX DATA FROM
OTHER SOURCES

<i>o</i>	1.593	<i>e</i>	1.586	diff.	0.007
	1.5955		1.5884		0.007 ¹³
	1.5913		1.5843		0.007 ¹³

G = 2.74-2.77⁴

ciated with limonite-filled cracks and haloes, rarely hematite platelets, decomposed plagioclase, and small specks of magnetite. Anderson also identified rutile, negative crystals, and other internal features.¹³ In 1966, Maurice Shire, marketer of Sandawana emeralds, noted that while inclusions are present in many stones in the range 1-3 carats, rarely 4 carats, many stones are as clean as Muzo stones.¹⁹ The finest grades form about 5% of the production and are noted for a "velvety" green and remarkable brilliance. Cut sizes ranged from 0.05 to 7 carats, rarely to 10 carats, with retail prices being about U.S. \$70 for smaller, poorer quality gems to as much as \$4,000 to \$5,000 per carat for gems of the largest size and best quality.

Inclusions are abundant acicular tremolite crystals in poorer grade crystals while in the better stones these are shorter and slenderer. Compared to Habachtal emeralds, such inclusions tend to form bundles, somewhat like the "horsetail" inclusions in demantoid from the Urals.¹⁶ Other inclusions are brown garnet, limonitized and asso-

BERYL LOCALITIES

Table 14-57
PROPERTIES OF FILABUSI EMERALDS

Deposit	<i>o</i>	<i>e</i>	Diff.	SG	Reference
Mustard	1.582	1.577	-0.005	2.69-2.74	4
Mustard	1.584	1.580	0.004	—	13
Coen's Luck	1.587	1.583	0.004	—	13
Flame-Lily	1.5910	1.5885	0.004	—	13

Filabusi Field. This area is located ca. 88 km (55 mi) SE of Bulawayo. A small ore beryl production comes from Ireland claims, Huntley's Farm, 3.2 km (2 mi) E of Filabusi Post Office. In 1958, emerald was discovered by J. H. Oosthuizen in this area and soon afterwards L. F. Van Gruenen also found emerald while mining for scheelite.⁴ According to Leiper, however, the Oosthuizen mine was located as the Pepper mine, originally registered in 1952 as a molybdenite claim.²⁰ It is 17.8 km (11 mi) SE of Filabusi P.O. Van Gruenen's claim was also staked originally in 1952 for another mineral, namely scheelite, but emeralds were found on the property in 1957 and the mine dubbed the Mustard mine. It is ca. 16 km (10 mi) SE of Filabusi P.O. In 1958, it was reported that about 40 lb (18 kg) of beryl was produced, "of which a considerable amount is emeralds," and with crystals of 1.2-3.8 cm (0.05-1.5 in) of "high quality."²⁰ Anderson mentions the Flame-Lily and Coen's Luck as other mines for emerald in this area but without details.¹³

Inclusions in Mustard emerald are small muscovite flakes irregularly distributed, some to 2 mm in diameter, also small biotite flakes and rarely tourmaline.⁴ On the other hand, Anderson noted phlogopite but not biotite, and mentioned rutile as well as a "profuse peppering of an opaque euhedral mineral,"¹³ also ilmenite platelets and an acicular mineral that could be amphibole. Coen's Luck crystals commonly contain gas-liquid inclusions, also amphibole and rarely a colorless mica.¹³ Amphibole needles are common in Flame-Lily stones, also phlogopite, gas-liquid inclusions and iron-stained healing fissures, etc.¹³

MISCELLANEOUS NOTES. Despite the abundance of common beryl occurrences, very little gem aquamarine or other gem varieties of beryl have been found. Some gem aquamarine was

found by Nieuwenhaus of Salisbury on his Miami field claims,²¹ while Kanis, in an article on all Rhodesian gemstones, mentions gem beryls as being found from time to time.²² A number of miscellaneous references to Rhodesian beryl appear in Gallagher and Hawkes.²³

1. Branscombe, K. C. 1962. Beryl in Southern Rhodesia. *Chamber of Mines Journal* (Salisbury) 4, no. 7, pp. 32-7.
2. Wiles, J. W. 1961. The geology of the Miami mica field (Urungwe district). *Southern Rhodesia Geological Survey Bulletin* 51 (Salisbury) pp. 193-213.
3. Maufe, H. B. 1920. The geology of the Lomagundi mica deposits. *Southern Rhodesia Geological Survey Short Report* no. 10.
4. Martin, H. J. 1962. Some observations on Southern Rhodesian emeralds and chrysoberyl. *Chamber of Mines Journal* 4, no. 10, pp. 34-8.
5. Hartwell, J. W., and Brett, B. A. 1962. Gem stones. Chapter in *U.S. Bureau of Mines Minerals Yearbook for 1961*. 12 pp.
6. Southern Rhodesia Geological Survey 1952. *Beryl. Mineral Resources*, ser. 6 (Salisbury) 6 pp.
7. Hornung, G., and Knorring, O. v. 1962. The pegmatites of the north Mtoko region, Southern Rhodesia. *Transactions of the Geological Society of South Africa* (Johannesburg) 65, pt. 2, pp. 153-80.
8. Watson, R. L. A. 1962. The geology of the Kamativi and Lubimbi areas. *Southern Rhodesia Geol. Sur. Bull.* 57:22.
9. Rijks, H. R. P., and Van der Veen, A. H. 1972. The geology of the tin-bearing pegmatites in the eastern part of the Kamativi district, Rhodesia. *Mineral Deposita* (Berlin) 7:383-95.
10. Bliss, N. W. 1962. The geology of the country around Umvuma and Felixburg. *Southern Rhodesia Geol. Sur. Bull.* 56:93-5.
11. Anderson, A. 1976. A note on the occurrence of emerald at Mayfield Farm, Fort Victoria, Rhodesia. *Journal of Gemmology* 15:80-2.
12. Tynsdale-Biscoe, R. 1952. The geology of the Bikita tin-field, Southern Rhodesia. *Trans. of the Geol. Survey of S. Africa* 54(1951):11-23.
13. Anderson, S. M. 1978. Notes on the occurrence and mineralogy of emeralds in Rhodesia. *Journal of Gemmology* 16:177-85.
14. Metson, N. A., and Taylor, A. M. 1977. Observations on some Rhodesian emerald occurrences. *Journal of Gemmology* 15:422-34.

World Sources of Ore and Gem Beryl / Zimbabwe (Rhodesia)

15. Worst, B. G. 1962. The geology of the Buhwa iron ore deposits and adjoining country: Belingwe district. *Southern Rhodesia Geol. Sur. Bull.* 53:70-1.
16. Gübelin, E. J. 1958. Emeralds from Sandawana. *Journal of Gemmology* 6:340-54; similar articles in *Gems & Gemology* 9(1958):195-203 and *Zeitschrift der Deutschen Gemmologische Gesellschaft* 26(1958/59).
17. Mayers, D. E. 1958. The Sandawana emerald discovery. *The Gemmologist* 27, no. 320, pp. 39-40.
18. Hartwell, J. W., and Brett, B. A. 1959. Gem stones. Chapter in *U.S. Bureau of Mines Yearbook for 1958*. 12 pp.
19. Shire, M. 1966. *Personal communication*.
20. Leiper, H. 1959. New South African emerald find. *The Lapidary Journal* 12:722-8, *passim*.
21. [Note on occurrence of aquamarine]. 1962. *Chamber of Mines Journal* (Salisbury) 4, no. 7, pp. 22.
22. Kanis, J. 1962. Notes on Southern Rhodesian aquamarine and other gemstones. *Chamber of Mines Journal*, vol. 4, no. 10, pp. 39-41.
23. Gallagher, M. J., and Hawkes, J. R. 1966. Beryllium minerals from Rhodesia and Uganda. *Geological Survey of Great Britain Bulletin* 25, (London) pt. 7, pp. 59-75.

APPENDIX

THE NAMES OF BERYL

*A misapplied or misapprehended term is sufficient
to give rise to fierce and interminable disputes.*

Roget's Thesaurus, N. Y., 1932, p. xi.

It is axiomatic that the longer a mineral is known, the greater number of names it accumulates. Beryl, particularly emerald, is one of the oldest known minerals, and over several thousands of years it has had attached to it an enormous number of terms, all tangible evidence of the many countries where it was known and the many tongues that coined names for it. The only beryl names that have few variations are those of recently described varieties as *goshenite* and *morganite*, or the superfluous *davidsonite*.

The earliest terms applied to emerald must have been Egyptian because emerald was first recognized in that country. These names are *mafek*, *mafek-en-ma*, or *mafek-ma*, all basically signifying "green stone." Strangely, the root of the word seems not to have achieved much currency, even in Arabic lands, and it is to the Greek that we must turn for the form which persists today: *smaragdus*. From this word is derived directly the modern German name for emerald, *smaragd*, and by alterations with time, place, and language, such words as *esmaragd*, *esmerauld*, and *emerald*. If the pronunciation of the initial sibilant is altered, it is easy to detect the relationship between *smaragdus* and such Arabic terms as *zumurrud* or *zamuraud*, and, by dropping the initial sibilant altogether, such terms as the Sanskrit *marakat* or *marakata*. The similarity among the terms suggests a common origin. Although some claim that the Sanskrit *marakata* came first and others claim that

APPENDIX

honor for the Greek *smaragdos*, the word is incorporated in one form or another in the majority of modern terms for emerald.

Theophrastus's *Peri Lithon* (ca. 450 B.C.) and Pliny's *Natural History* (ca. 79 A.D.) said nothing about such derivations, merely furnishing the names with meager descriptions of the stones themselves. As noted in the early chapters of this book, it is doubtful that their terms for beryl varieties were affixed in every case to minerals that we now recognize as true beryls. The difficulty for establishing an origin for the basic emerald term, *smaragdos* (Greek) or *smaragdus* (Latin), is commented upon by Hill¹ (p. 104) in his translation of the *Peri Lithon*. He gives several equivalent words for emerald in Near East countries and notes that the emerald was called *zamarrut* by the Arabs, "from whence it is generally supposed the Word *Smaragdus* is derived: though in my Opinion, there is much more Probability that the Word was from the Greek Verb *σμαρασσω* [*smarasso*], *luceo*, or *splendeo*, as this Gem was ever in the great Esteem for its particularly vivid lustre."

King² (p. 35) was of the opinion that *smaragdos* was "the Greek corruption of the Sanscrit *Smarakata*, the gem and its name having been imported together from Bactria into Europe by the traders of that race." As has already been pointed out, it is by no means certain that any green stones found anciently in Bactria were indeed emeralds. An unidentified critic of King's book, writing in the *Edinburgh Review*,³ amplified King's remarks as follows: "the emerald, a term at first applied to the beryls or aquamarines of India, though afterwards given to other green stones, came to Europe under its Indian (Sanskrit) name 'marakat,' connected with *esmarak*, a sea monster, or *makara*, the sea. Transferred to Persian and Arabic, it became 'zabarjad,' and in the greek and latin *smaragdos* or *zmaragdos*, the Greek recognizing probably a Greek root to the word in *μαρμαρυγη* [*marmaruge*], a flashing, from *μαρμαυρω* [*marmairo*], to sparkle."

The origin of emerald's root was also briefly discussed by Ball⁴ in his study of Pliny's precious stones. He noted "that while the East largely received its emeralds from the West, the Greek *smaragdos* (more rarely *maragdos*) appears to come from the Sanskrit *marakata* or *marakta* (Makara is the sea) through the Persian *zabargat*," thus more or less agreeing with the writer in the *Edinburgh Review*. On the other hand, in his learned and very complete work on mineralogical nomenclature, Keferstein⁵ (p. 43) logically credited the home of the ancient emerald, Egypt, as also the source of the root word, stating that "because India had no emeralds, the ancients drawing these mainly from Egypt, so also the name stems from there." He then cited variants of the basic term *maragd* or *zamaragd* in Ethiopic, *smaragdos* in Coptic, and many others, proving to his own satisfaction that the root was *mara* + a hard consonant, and that it originated in an Arabic language, although that, in turn, may have been derived from Sanskrit in some still more distant period. However, derivation from Sanskrit is unlikely inasmuch as it seems clear that the

Appendix

original home of the emerald was Egypt, and almost certainly the home of the first term applied to that mineral. Only if the original Egyptian term had been exported to India, and somehow transformed there, could Sanskrit be considered as the origin of the root *marā*.

In his essays on Chinese contributions to ancient Iranian culture, Laufer⁶ (p. 519) remarked on a Chinese word for emerald and claimed that it "is a transcription of Persian *zumurrud*," and "the word itself is of Semitic origin." Further, "in Assyrian it has been traced in the form of *barraktu* in a Babylonian text dated in the thirty-fifth year of Ataxerxes I (464–424 B.C.). In Hebrew it is *bāreket* or *bārket*, in Syriac *borko*, in Arabic *zummurud*, in Armenian *zemruxt*; in Russian *izumrud*. The Greek *maragdos* or *smaragdos* is borrowed from Semitic; and Sanskrit *marakata* is derived from Greek, Tibetan *mar-gad* from Sanskrit. The Arabic-Persian *zummurud* appears to be based directly on the Greek form with initial sibilant."

In still another view, Haschmi⁷ (p. 102) examined old Arabic sources of information on gemstones and stated, with refreshing candor, that it is now impossible to accurately establish the term used in ancient Egypt for emerald, noting that old Arabic sources continually give two designations, namely *zummurud* and *zabargad*, which many authorities deem synonymous with emerald. He also cited E. Wiedemann as attempting to fix the name *zummurud* to emerald in his essays *Zur Mineralogie im Islam*, while Clément Mullet in his "Essai sur la Minéralogie arabe" (*Journal Asiatique* sr. 6, vol. 11, Paris, 1868) identified this term with beryl. Haschmi further noted that the term "Zabargad is also designated as the peridot" and it "is noteworthy that there is an island of the same name in the Red Sea from whence came peridots."

In regard to the etymology of *beryl*, neither Theophrastus's *Peri Lithon* nor Pliny's *Natural History* is helpful. However, Ball⁴ (pp. 267–8), in commenting on Pliny, noted that "the origin of the earliest examples of this gem is suggested by the Greek word *bn'pulos* [sic, i.e., *beryllos*] and the Latin *beryllus*, forms which Weber derives from the Sanskrit *vaidurya*. . . . the latter, in turn, appears to be of Dravidian origin." Keferstein⁵ merely stated that the "βηριλλος [berillos] of the Greeks apparently is our beryl, like the *berillus* of the Romans."

In contrast to these meager remarks, Wiener⁸ (pp. 114–20) provided a veritable etymological feast in his studies of Arabico-Gothic culture. He showed that beryl and pearl were derived from the same source word, namely the Pali *veluriya*, or Sanskrit *vaidurya*, defined in Sanskrit dictionaries as "beryl," "pearl," or sometimes "crystal." The Greek *beryllos* and Latin *beryllus* were believed to be derived from this word, and Wiener further showed that words generally pronounced *belūra* (Syriac), *būrla* or *bīrla* (Chaldaic), and Arabic *ballūr*, *billaur* or *bulūr*, mean "beryl" or "crystal." Variants taken from Medieval Latin glosses include *berillus*, *berolus*, *berulus*, *birillus*, and *byrillus*, with the stone in question conceived of

APPENDIX

simply as some kind of shining or white stone. Wiener also cited a codex of the 9th or 10th century in which variants appear as *berala*, *berulon*, *berre*, *berlin*, *berelon*, and *berle*, and if a "p" is substituted for the "b", such words easily become recognizable as synonyms for pearl.

Wiener also noted that since beryl was identified as a "shining" stone, it was later used in the abbreviated form *brill-*, from whence comes our term "brilliance," and still later, on account of beryl's transparency, and supposedly because such beryls could be used in aiding the eyesight when shaped into lenses, the lens itself came to be called a "beryl." "Thus it becomes clear," stated Wiener, "that ultimately *beryllus* was confounded with any crystal lens, hence *berillus*, *paryll*, *berillis*, *beril* are given . . . as forms for the modern German *Brille* "eyeglasses." Furthermore, in Old French appear "beric, bericle, baricle, all obviously from *beril* for *beryl*, and *berique*, *bezique* for 'a kind of ornament,' hence Fr. *besicles* 'eyeglasses.' On the other hand, the beryl was considered a cheap, flashy stone, as is evidenced in Old French *berique*, hence Italian *brillo* 'a cheap or false gem,' *brillare* 'to flash, scintillate, glitter,' and French *briller* 'to shine.' "

King⁹ (p. 55) noted that "it is a curious fact that *Beryllus* is the Low Latin term for a magnifying glass: hence the German 'Brille,' a pair of spectacles," and it was for this reason that "Nicolas de Cusa, bishop of Brixen . . . gave the name of 'Beryllus' to one of his works, 'because by its aid the mind would be able to penetrate into matters which otherwise it would be unable to pierce.'" However, unlike other authorities mentioned, King did not trace the derivation of beryl, but merely suggested that because medieval glass was "always tinged more or less with green, the resemblance as to colour and form of a lens in such a material to an actual Beryl was sufficiently obvious to induce the communication of the name to the new discovery."

The use of beryl or some similar word form to designate common glass was also noted by Ball⁴ (p. 268), especially in connection with window panes of 16th-century England, which were called by a writer of the time "berills." Also, "in the same century mirrors were called in England berral-glas. . . . this may well explain the statement that beryl globes were used in divination in the Middle Ages, for globes of beryl must have been rare . . . and I do not know that any such are preserved in the museums."

The term *aquamarine* seems to be a relatively modern invention. It cannot be found in Marbod or Albertus Magnus, and while these and even earlier authors describe the variety itself, the specific term, by which we know it now, apparently was first used in an important gemological work by Boetius de Boodt in his *Gemmarum et Lapidum Historia*.¹⁰ After this appearance, it quickly established itself as an accepted varietal name. Probably the first vulgar version was the Italian *acquamarina*. Other varietal names are even more recent, generally dating from the 18th

Appendix

century, while *morganite*, named after J. P. Morgan, the New York financier, was applied to the pink variety in the early part of this century.

The first systematic listings of beryl varieties appear in Pliny's *Natural History* and have been tabulated and annotated by Ball.⁴ The Latin names of gemstones, minerals, and rocks purporting to be members of the beryl family are taken from Book 37 of Pliny. Equivalent modern names are provided under the columns headed *certain*, *probable*, and *possible*. Ball believed that Pliny's Scythian emerald is probably sapphire, the Bactrian emerald is probably beryl, and the *limoniatus* probably emerald. Only the Egyptian and Ethiopian emeralds are listed as "certain."

Table A-1
BERYLS FROM PLINY'S NATURAL HISTORY (Book 37)

<i>Latin Name</i>	<i>Chapter</i>	<i>Certain</i>	<i>Probable</i>	<i>Possible</i>
<i>Smaragdus</i>	3		In part emerald	
Scythian	16-18		Green sapphire	
Bactrian	16-18		Emerald	
Egyptian	16-18	Emerald		
Cyprian	16-18		Chrysocolla, malachite in part	Copper-stained quartz
Aethiopian	16-18	Emerald		
Hermonian or Persian	16-18			Green Turquoise
Attican	16-18		Smithsonite	
Median	16-18		Malachite inter-grown with azurite	Turquoise
Chalcedonian, Sarcicon	16-18		Bornite "peacock ore"	
Cloras	16-18	Green alabaster		
<i>Tanos</i>	19		Green turquoise	
<i>Chalcosmaragdus</i>	19		Malachite + sulfide stringers	
<i>Pseudo-Smaragdus</i>	19		Jasper-malachite	
<i>Beryllus</i>	20	Beryl		
Sea Green	20	Aquamarine		
Chrysoberyllus	20	Golden beryl		
Chrysoprasus	20		Chrysoprase	Green beryl in part
Hyacinthozontes	20	Deep blue beryl		
Aeroides	20	Pale blue beryl		
Other varieties	20	Common Beryl		
<i>Limoniatis</i>	62		Emerald	

Source: S. H. Ball,⁴ p. 91 ff.

APPENDIX

DERIVATION OF NAMES AND TERMS

To save space, some related terms are placed together. Quotation marks indicate false or misleading terms.

- Abruki**—"Shade of smoke," in emerald, India¹¹ (vol. 2, p. 901)
- Acquamarine**—Aquamarine, Ital.; "a. **crisolide**"—peridot; "a. **del orientale**"—sapphire; "a. **de Siam**"—blue zircon; a. **Siberiana**—greenish-blue aquamarine from the Urals.¹²
- Aeroid** (Czech.), **Aeroide** (Span.), **Aeroides** (Engl., Ger., Ital., Port.)—Sky-blue aquamarine, from Pliny.^{4,13}
- "**African Emerald**," "African Smaragd," or "Africanischer Smaragd" (Ger.)—Green fluorite.
- Agmarine**—Aquamarine, O.Fr.¹⁴
- Aguamarina**—Aquamarine, Span.; "a. **de Siam**"—zircon; "a. **orientale**"—greenish-blue topaz.^{13,15}
- Agua-marinha**—Aquamarine, Port.; "a. **de São**"—zircon.¹³
- Aigue Marine**—Aquamarine, Fr.; "a. **chrysolithe**"—peridot; "a. **de Siam**"—zircon; "a. **orientale**"—sapphire.¹³
- Aku Vamarin** or **Ekmardin**—Aquamarine, Turk.^{15a}
- Amarantsteen**—Seldom used Dutch term for emerald.⁵
- Amaraud**—Emerald, O.Fr.¹⁴
- American Emerald**—Colombian emerald; briefly used in Europe ca. 1770.¹
- "**Amethyst Basaltine**" (Engl.), "Amethyste B." (Fr.), "Amethyst Basaltin" (Ger.)—Pale violet var. beryl, probably applied originally to apatite crystals mistaken for beryl.^{16,18}
- Apanica**—Emerald, Sanskr.⁵
- Aquamarijn**—Aquamarine, Dutch¹³
- Aquamarin**—Aquamarine, Ger.; "a. **chrysolith**"—peridot; "a. **achter**"—topaz¹⁸ (citing Mohs); "Aquamarin"—apatite¹⁸ (citing Brunnich); also rarely used to indicate pale blue topaz.
- "**Aquamarine Emerald**"—Rarely used trade term for triplet of genuine emerald and aquamarine; "a. **topaz**"—greenish topaz.¹⁶
- "**Aquamarinfluss**" (Ger.)—Apatite, fluorite;¹⁹ "Aquamarschörl"—gem beryl.¹⁹
- Aque Marine**—var. sp. Fr.¹⁴
- Arabijj**—Emerald from Arabia of very light color⁵ (p. 43)
- Asmagarba, Asmagarbham, Asmagarbham, Amajoni**—Emerald, Sanskr.¹¹ (vol. 2, p. 1021) and in Keferstein⁵
- Asmer, Smer**—Name of clear green stone of Egypt, suggested as root of Greek word for emerald, *smaragdos*.
- "**Augites**"—Mentioned by Pliny, sometimes thought to mean a variety of beryl.
- Bahani**—Natural flaw in emerald, cleverly hidden by gem cutters and setters, India¹¹ (vol. 2, p. 901)
- Bahia Emerald, B. Smaragd** (Ger.)—Genuine emerald from State of Bahia, Brazil.
- Bajhur**—"A stone of green color mixed with black . . . sometimes mistaken for the Zurbuzud," with the latter mistaken for the emerald, Egypt¹¹ (vol. 2, pp. 952-3).
- Ballur, Billaur, Bulur**—Arabic and Persian names for beryl, but also for rock crystal.^{5,8}
- Belur, Belura**—Hebrew, Pahlevi, Syriac⁸
- Bapabolam, Baprabalam**—Emerald, Sanskr.¹¹ (vol. 2, p. 1021).
- Baraket, Baraketh, Barekat, Bereketh, Barkat, Barket**—Possible beryl in Bible, Hebr.^{5,6,20}
- Barbara Beryl**—Beryl from Barbara mine, South Africa.
- Barille**—Beryl, Mid. High Ger.²¹
- Barkta, Barkan**—Emerald, Chaldaic.⁵
- Barragtu, Barraktu**—Emerald, Egypt. Assyr.^{6,66}
- Berakta**—Chald.⁵
- "**Basaltes Spatosus**"—Possible emerald, mentioned by A. F. Cronstedt in his *Mineralogie*, 2nd ed. (Stockholm, 1758).
- "**Basaltin Amethystov**" (Czech.), "Basaltina" (Span.), "B. Ametista" (Ital., Port.), "Basaltine Amethyste" (Fr.)—Pale violet beryl.¹³
- "**Bastard Emerald**"—Quartz colored to resemble emerald; also any green stone resembling emerald; rarely peridot as "Bastard-Smaragd" (Ger.).²²
- Bazzite**—Scandian analog of beryl with Sc substituting for Be.

Appendix

- Berala**—Beryl, early Ger.;⁸ **Berall**—beryl, early Ger.¹⁴
- Berel**—Beryl, Ethiopic.⁵
- Bericle**—Beryl, O. Fr.;²² possibly derived from *besicles*, O. Fr. "eyeglasses."
- "Berigem"**—Peridot-colored synthetic spinel.²³
- "Beril Azul"**—Kyanite;¹⁵ **"b. de oro"** (Span.)—golden beryl; **"b. de Saxe"** (Fr.)—apatite of Saxony, also called "agustit" or "agoustite";²⁴ **"b. feuilleté"** (Fr.)—kyanite¹⁸ (citing B. G. Sage).
- Berilio**—Beryl, Port.;¹³ **b. amarelo**—golden beryl; **b. olho de gato**—cat's-eye beryl; **b. rosa**—rose beryl ormorganite.¹³
- Berill, Berillis, Berial, Beril, Berille, Berillus, Berolus, Berre, Berulus, Beryall, Birillus, Birrall, Byral, Byrrall, Byralle, Byrillus, Bureall**—Various spellings used in Europe.
- Berillo**—Beryl, Ital.;⁴² **b. aureo**—golden beryl; **b. azzurro**—aquamarine; **b. giallo**—yellow beryl; **b. occhio di gatto**—cat's-eye beryl; **b. rosa**—rose beryl ormorganite.^{12,13}
- Berillos** (Gr.), **Berillus** (L.), **Beryllus** (Ger.), **Beryllus** (L.)—Beryl.
- Berillus Misnicus**—Beryl.²⁵
- Berilo**—Beryl, Span.; **b. amarillo**—golden beryl; **b. ojo de gato**—cat's-eye beryl; **b. rosado**—rose beryl ormorganite.¹³
- "Berilo"**—Falsely applied to apatite; **"b. alterado"**—pseudo-emerald or pseudosmaragdate.¹⁵
- Beruj**—Beryl, India, of a color much lighter than emerald¹¹ (vol. 2, p. 901).
- Berula, Berulo**—Beryl, Syriac;⁵ **Berulin**—Arab.⁶⁶
- "Beryl"**—Misapplied, according to King⁹ (p. 134), "to every variety of the Sard in which yellow predominated." "A term that designates amongst lapidaries and virtuosi a very rich deep brown diaphanous carnelian; it is frequently engraved into intaglios"²⁶ (vol. 3, p. 1037).
- Béryl de Barbara** (Fr.)—Beryl from Barbara mine, South Africa; **Béryl jaune**—yellow beryl; **Béryl rose**—rose beryl ormorganite. **Beryl Růžový** (Czech.)—rose beryl.¹³ **Béryl pierreux**—common beryl, Fr.
- "Beryl Schorlacé," "B. Schorliforme"**—In part true beryl, according to T. Bergman and A. G. Werner, but usually misnomer for topaz. variety pycnite¹⁸ (pp. 175, 192).
- Berylite**—Variety of beryl;²⁷ **"Berylite"**—trade name for synthetic rose spinel.²⁸
- "Beryll"**—Carnelian or apatite;¹⁹ **"Beryll, Unächtiger"**—rock crystal, fluorite;¹⁹ **Beryllcarneol**—carnelian;¹⁹ **"Beryllfluss"**—fluorite;¹⁹ **"Beryllkristall"**—rock crystal;¹⁹ **"Beryllschorl"**—schorlartiger Beryl.¹⁹
- Beryllion**—Beryl, Coptic.⁵
- Beryllium**—Beryl, rare;^{19,20} **Beryllium diadochus**—aquamarine; **b. omphax, b. scorilodes**—aquamarine.¹⁹
- Berylloid**—In crystallography, "the dihedral pyramid is often called a berylloid because a common form with the species beryl" (Dana-Ford, *Textbook of Mineralogy*, 4th ed., [New York: John Wiley, 1932] p. 114).
- "Beryllus Chitim"**—Chrysolite;¹⁹ **b. hexagonus**—rare name for beryl generally (J. D. Dana, *System of Mineralogy* [New Haven, 1837], p. 324); **b. oleaginus**—oil-colored beryl of Pliny.
- Besady**—Beryl, Persian.⁵
- Bilaur** (Arab.), **Birla, Birula** (Chaldaic), **Biurey** (Armenian)—Beryl.⁵
- Billurin**—Beryl, Aramaic.⁶⁶
- Bixbite**—Raspberry-red beryl, Utah, named by A. Eppler²⁹ but rarely used.
- "Bloagrün Topaz"**—Beryl, Swedish¹⁸ (citing A. F. Cronstedt).
- "Bohemian Emerald"**—Fluorite.
- Borko**—Emerald, Syriac.^{5,6}
- Brahmin Emerald**—Emerald the color of sirish flower (*Albizzia procera*), India.³⁰
- "Brasilianischer Aquamarin"** (Ger.)—Pale blue Brazilian topaz; **"Brasilsmaragd"**—green tourmaline, sometimes a misleading name for Brazilian beryl;²³ **"Brazil Emerald," "Brazilian E."**—green tourmaline.
- "Brighton Emerald"**—Green glass beach pebble, England.
- Brille**—Beryl, Mid. High Ger.²¹
- Brulo**—Beryl, Syriac.⁵
- Budharatnam**—Emerald, Sanskr.¹¹ (vol. 2, p. 1021).
- Burallu**—Beryl, Assyrian.⁶⁶
- Büreg** (Armenian), **Burl, Burla** (Chaldaic); **Burlo** (Syriac)—Beryl.^{5,8}
- Byrili, Byvrilioni**—Beryl, Georgian.³¹
- "Carneolberyll"**—Carnelian.¹⁹
- Cäsiumberyll** (Ger.), **Caesium Beryl**—Beryl containing Cs, usually colorless or pink.
- Canary Beryl**—Bright, pale yellow beryl.
- Canutillos**—Colombian emerald miner's term for

APPENDIX

- very thin and small prismatic crystals of high quality emerald.
- "Cape Emerald," "Capscher Smaragd"** (Ger.)—Prehnite from Cape of Good Hope, South Africa.¹⁹
- Catel**—A beryl of "obscure chrystal Colour."³²
- Ccomer Rumi**—Emerald, meaning literally a "green stone," Quichua of Peru.³³
- Cerinus**—Beryl, "similar in color to wax";³⁴ perhaps same as *cervinus* of C. Leonardus,³² i.e., a beryl of "tawny colour."
- "Chatham Emerald," "Chatham Cultured E.," "Chatham Created E.," Chatham-Zuchtsmaragd"** (Ger.)—Synthetic emerald made by C. F. Chatham, San Francisco.²³
- Chir**—Streaks in emerald, India.¹¹ (vol. 2, p. 901).
- Chispas**—Literally "sparks" in Span., used by Colombian emerald miners to designate gemmy bits of emerald too small to cut.
- Choaspites**—A variation of *chrysoberyllus* or golden beryl; from Choaspes River in Persia.³⁴
- Chrysoberyllus**—Golden beryl³⁴ from Pliny's *Natural History*; adopted by A. G. Werner for present chrysoberyl; rarely used as misnomer for greenish-yellow beryl from U.S.A.²³
- "Chrysolite der Alten"** (Ger.)—Topaz or emerald.¹⁹
- "Chrysolite du Brésil"**—Beryl from Brazil¹⁸ (citing Romé de L'Isle).
- Chrysolith, Blaulichgrüner** (Ger.)—Beryl.¹⁸
- Chrysolithus**—Golden beryl.²³
- Chrysopilon**—Pale golden beryl.³²
- Chrysoprasius**—Used by Pliny, possibly for beryl; Ball⁴ suggests it is chrysoprase quartz; the color is like "gold and the juice of a leek,"³⁴ (citing Agricola).
- Colam**—A kind of emerald used by Arabians to decorate their edifices.¹⁰
- "Congo Emerald," "Copper E."**—Diopside.
- Crisoberillus**—Variety of beryl; **Crisopassus**—beryl of golden color mixed with purple[*sic*]; **Crisopilon**—variety of beryl.³²
- "Cristallinus"**—Misleading name for beryl, "because it is colorless."³⁴
- "Cultured Emerald"**—"False name for synthetic emerald"²³ (p. 49).
- Ču-mu-la**—Emerald, 14th-century China.⁶
- Dabbhani**—Vivid green emeralds, like color of *Cantharides* insects, Arab.⁵
- Dánbhá**—Surface marks on emerald, "some-what like a spider's web," India¹¹ (vol. 2, p. 901).
- Davidsonit** (Czech., Ger.), **Davidsonita** (Span.), **Davidsonite** (Engl.)—Greenish-yellow beryl from vicinity of Aberdeen, Scotland, named after Dr. Davidson, discoverer, by T. Thomson (*Outlines of Mineralogy, Geology, and Mineral Analysis*, vol. 1, 1836, p. 247); see also Oelschagel¹³ and Bristow³⁵ (p. 105).
- Dhání**—Emeralds tinged with yellow, India¹¹ (vol. 2, p. 901).
- Diacodas, Diacodus, Diadochis, Diadochus**—"Is similar to, if not actually the same as, *beryllus* since the writers who describe this stone do not say in what way it differs from the latter"³⁴ (p. 127); "like beryl in colour"³² (p. 95).
- Dsobab**—Equivalent to *dabbhani* (which see).
- Edelberyll** (Ger.)—Superfluous name for precious beryl.²³
- Ekmarin**—Aquamarine, Turk.^{15a}
- Eliodoro**—Heliodor, golden beryl, Ital.¹²
- Ellipomacrostyla**—Beryl crystal name³⁶ (citing Dr. Hiller).
- "Emerada"**—Trade name, yellow-green synthetic spinel;²⁸ **"Emeralda"**—same.²³
- Emeral**—Emerald, J. G. Wallerius in his *Mineralogia, eller Mineralriket irdelt och Beskrifvet* (Stockholm, 1747).
- Emerald, Émeraude**—Commonly used in 18th and early 19th centuries as species name for beryl, forcing use of adjectives to distinguish emerald from other varieties.
- Emerald, Emeraude, Emraud, Emerald, Emeroyde, Emmorant, Emerant, Emeraldode, Emrade, Esmeralde, Esmeraldus, Esmeraude, Esmeraulde, Esmeragd, Esmeragde, Emeraud, Hemerauld, and others**—Variants used in Europe and England.^{14,22}
- "Emerald Copper"**—Diopside¹⁸ (citing R. Jameson.)
- "E. Malachite"**—Diopside.¹⁸
- Emerald Matrix**—Compact rock of albite, black tourmaline, mica, and emerald crystals, capable of cutting into cabochons.
- "Emerald Matrix"**—Also known as "mother-of-emerald," reflecting belief of the ancients that certain greenish stones, if allowed to "ripen," would turn eventually into emeralds, or the latter would be nourished by

Appendix

- such matrix and grow from same; applied mostly to green varieties of jasper, prase, fluorite, etc.
- "Emerald Nickel"**—Zaratite¹⁸ (citing B. Silliman).
- "Emerald Schörl, Shirl, Shorl"**—"Mother-of-emerald" according to Hill,³⁷ (p. 140-1), but his description clearly fits true Egyptian emerald.
- "Emerald Spodumene"**—Hiddenite.
- "Emeraldin"** (Ger.), **"Emeraldine"** (Engl.)—Green-dyed chalcidony;³⁸ also trade name for pale green synthetic spinel.²³
- "Emeraldit"** (Ger.), **"Emeraldite"** (Engl.)—Green tourmaline.²³
- "Emeralite"**—Pale green tourmaline, Ware mine, San Diego Co., Calif., sometimes spelled "emeraldite."²⁸
- "Emerandine"**—Diopside.¹⁶
- Émeraude**—Emerald, modern French; **"Émeraude batarde"** (Fr.)—peridot; **"é. cuivre"**—diopside; **"é. d'Afrique"**—green fluorite, rarely green tourmaline; **"é. de lithion"**—hiddenite; **"é. de nickel"**—zaratite; **"é. de nuit"**—peridot; **"é. d'Oural"**—demantoid garnet; **"é. de Sibérie"**—diopside;¹⁸ **"é. du Brésil"**—green tourmaline; **"é. du cap"**—prehnite; **"é. du Perou"**—emerald from Colombia; **"é. électrique"**—green glass; **"é. Espagnole"**—green glass; **"é. ferrer"**—green glass;²³ **"é. miellée"**—very pale honey-yellow beryl;³⁹ **"é. morillon"**—green fluorite;⁴⁰ **"é. orientale"**—green sapphire; **"é. soudée"**—doublet gem made of two pieces cemented together with green central layer;²³ **"é. tecla"**—emerald imitation.
- Émeraude de Bahia**—Genuine emerald, State of Bahia, Brazil.
- Émeraude de Colombie**—Emerald from Colombia.
- Émeraude Vert**—Used by R. J. Haüy (*Traité de Mineralogie* 1801) to designate emerald as distinguished from other beryls.
- "Émeraundine"**—Diopside¹⁸ (citing J. C. Delametherie).
- "Émeraundite"**—Diallage⁴⁰ (citing L. J. Daubenton); or pyroxene.¹⁸
- "Emerita," "Emerita-Smaragd"**—Trade name, Lechleitner synthetic emerald.²³
- "Emerita-Stein"**—Core of beryl overcoated with emerald.²³
- Equemarine**—Aquamarine, O. Fr.
- Esmeragda** (Old Catalan), **Esmeragdo, Esmeraldo** (Port.)—Emerald.⁵
- "Esmeragdita"**—Diallage, Span.¹⁵
- Esmeralda**—Emerald, mod. Span. and Port.; **"esmeralda"**—sometimes falsely applied to green tourmaline;²³ **"e. de Cartagena"**—green fluorite;¹⁵ **Esmeralda Falsa**—"false emerald," usually green fluorite.¹⁵
- "Esmeralda Cobre"** (Span., Port.)—Diopside; **e. de Colombia** (Span.)—Colombian emerald; **e. da Colombia** (Port.)—same; **e. de Bahia** (Span.)—Emerald, State of Bahia, Brazil; **e. da Bahia** (Port.)—same; **"e. del Brasil"** (Span.) and **"e. do Brasil"** (Port.)—green tourmaline; **"e. litio"** (Span.)—hiddenite; **"e. soldada"** (Span.)—doublet gem of two pieces with colored layer between.¹³
- Esmeraldas Meridionales**—Emeralds, probably Egyptian; **"e. viejas"**—green sapphires.⁴¹
- Esmeroud**—Emerald, Old Dutch.⁵
- "European Emerald"**—Beryls of Europe.¹
- "Evening Emerald"**—Peridot
- False Emerald, Fausse Émeraude** (Fr.)—Fluorite, sometimes malachite.
- Faz, Fozz, Fozzon**—Grains of emerald washed from sand, Arabic.⁵
- "Ferrer-Smaragd"** (Ger.)—Emerald-green glass.²³
- Feruza, Ferruzegi, Feruzegi, Firuza, Peruzegi**—Turquoise (Persian), sometimes misapplied to emerald.^{42,43}
- "Foliated Beryl"**—Pycnite variety of topaz.¹⁸
- Fortaleza Aquamarine**—Finest blue aquamarine from Brazil.²³
- Fustafi**—Emerald in which green is mixed with black, from the name of the pistachio nut, Arabic¹¹ (vol. 2, pp. 876-7).
- Galactites, Galactitis**—Possible smaragdus in Pliny, described as "a smaragdus surrounded with veins of white"⁴⁴ (p. 449).
- Gánjhá**—Loss of clarity in emerald due to inclusions, India¹¹ (vol. 2, p. 901).
- Garalári, Garalárih**—Emerald, meaning "enemy of poison," in allusion to reputation as antidote for all poisons and venoms, Sanskrit.^{11,45}
- Garamantica**—"Is like the Emerald, and has a cross white line; it is of great use in the Magic Art"³² (p. 109).

APPENDIX

- Garden or Jardin** (Fr.)—Host of filamentous inclusions in emerald resembling moss.
- Garuda**—Denotes very precious stone in Sanskrit, but also the "bird and vehicle of Vishnu;" Wilson's *Dictionary* defines it as emerald.⁵ Derived terms: **Garudmata**, **Garudodgara** (literally "vomit of Garuda"⁴⁶), **Garudottirna**, **Garudaçmen**, **Garuram**, **Garurankitam**, **Garurodgirnam**, **Garurottirnam**, **Garutmatam**—Emerald, Sanskrit.^{4,11}
- Gemelo**—Segmented emerald crystal of Colombia, originally thought to be a trilling by Bertrand (1879), but now called *trapiche* (which see).
- Geschenite**—Apple green beryl, rich in sodium.⁴⁷
- Gilson Emerald, Gilson Synthetischer Smaragd** (Ger.)—Synthetic emerald made by Pierre Gilson, France.²³
- Glatter Smaragd** (Ger.)—Emerald¹⁸ (citing D. L. G. Karsten).
- Goldberyll** (Ger.), **Golden Beryl**—Yellow beryl.²³
- "Golden Emerald"**—Golden beryl.¹⁴
- Gosenita** (Span.), **Goshenit** (Ger.) **Goshenite** (Engl., Fr.)—Colorless beryl named after deposit at Goshen, Massachusetts by C. U. Shepard (*A Treatise on Mineralogy*, 2nd ed. [New Haven, 1844], vol. 1, p. 143).
- Gota de Aceite** (Span.)—"Drop of oil," referring to rich color and clarity of fine emerald crystals of Colombia.²⁸
- Gyou**—Emerald, Tibetan.⁵⁵
- "Halbanita Aquamarine"**—Intense blue Maxixe-type beryl, named ca. 1973 after the Halba-Comércio e Industria de Pedras Preciosas, S.A., Belo Horizonte, Brazil.
- Harinmani, Harinmanih, Haritasman**—Emerald, Sanskrit.^{5,11}
- "Hartglas-Smaragd"** (Ger.)—Rapidly cooled, hardened emerald-color glass.²³
- Heliodor, Heliodoro** (Span.)—Golden beryl, S.W. Africa (Namibia), named by Lucas von Cranach;⁴⁸ suggested as general term all yellow beryls;⁴⁷ said to be "somewhat opalescent."²³ See also Oelschlagel¹³ and Pough et al.²⁸
- Hemerauld**—Emerald, O. Fr.¹⁴
- Heroides**—Variation of *aereoides*.³²
- Hesperus, Hesperus, Vesperugo**—The "Bohemian emerald," i.e., green fluorite.⁴⁹
- Hughes Emerald**—Synthetic made in Hughes Research Laboratory, Calif.²³
- Huzrul Haiya**—Emerald, Egypt.¹¹
- Hyacinthozontes, Hyacintozontes** (Ger.)—Deep blue beryl of Pliny;⁴ "similar in color to the hyacinthus"³⁴ (p. 127); "like Emeralds";³² (p. 76); "superfluous name for light sapphire-blue beryl in the USA"²³ (p. 79).
- Iaschpech, Iaschpeh, Iaspeh, Yashpneh**—Beryl in the Bible, Hebrew²⁰ (f.24 v.); aquamarine;¹⁰ jasper.⁵³
- "Igemerald"**—Synthetic emerald produced by I. G. Farbenindustrie, Germany.^{23,28}
- "Indian Emerald," "Indischer Smaragd"** (Ger.)—Cracked and dyed quartz.^{23,28}
- "Inkasmaragd"** (Ger.)—Emerald supposedly from Ecuador.²³
- Ismaragda, Ismaragdan, Ismaragdon, Ismoradh**—Emerald, Chaldaic.^{5,11,50}
- Isoumrode** (Polish)—Emerald.⁵
- Isumrud, Izoumrud, Izumrud** (Russ.)—Emerald, the last is current.
- Jahaji**—Emerald variety, India¹¹ (vol. 2, p. 901).
- Jardin**—See *Garden*.
- Junjari** (Arabic), **Jungari** (Persian)—Emeralds the color of pepper.¹¹ (vol. 2, pp. 876–7).
- Káhi**—Emeralds of a black tinge, India.¹¹ (vol. 2, p. 901).
- Kai-sui-shoku-ritoku-giyoku**—"Green gem of the color of the sea," i.e., aquamarine, Japanese.¹⁷
- "Kapsmaragd"** (Ger.)—Prehnite from Cape of Good Hope.²³
- Kashatriya Emerald**—A variety of deep green color, India.³⁰
- Kazab**—Crystals of emerald in matrix, Arabic.⁵
- Kerási**—Emeralds the color of the *keras* vegetable, Arabic¹¹ (vol. 2, pp. 876–7).
- "Kongo Emerald," "Kongosmaragd"** (Ger.)—Dioptase.²³
- "Kupfersmaragd"**—Dioptase.^{18,23}
- Lapis Mulieris, Lapis Virgineus**—Emerald, the "stone of women," because conferring special protection to.⁵¹
- "Lapis Smaragdinus"**—Serpentine.⁵²
- Lechleitner Emerald, Lechleitner Smaragd** (Ger.)—Synthetic emerald coating over

Appendix

- aquamarine core, made by Lechleitner in Austria.²³
- Lieu-pau-shih**—"Valuable or precious stones of green color," possible emerald, Chinese.¹⁷
- Limoniates, Limoniatus**—"Would appear to be the same as smaragdus"⁴⁴; an emerald, like "a mist green pasture"³⁴ (p. 124); "is a green stone in the similitude of an Emerald, but not so much Greenness and Transparency"³² (p. 118); S. H. Ball (see Table A-1) classes it as emerald.
- Linde Emerald, Linde Smaragd** (Ger.)—Synthetic emerald made on aquamarine wafer seed by Linde Air Products Co. of U.S.A.^{23,38}
- "Lithia Emerald," "Lithionsmaragd"** (Ger.)—Hiddenite.
- Lithium Beryl, Lithiumberyll** (Ger.)—Beryl containing Li.²³
- Liu Lu**—Beryl, Chinese.
- Lomasarara**—Emerald, Sanskrit.⁵
- Lou-soung-chi**—Emerald, Chinese.⁵⁵
- Luk-syak, Luksyák**—Emerald, Cantonese.^{11,53}
- Madagascar Aquamarine**—Trade designation of fine blue beryl.^{28,38}
- Mafek, Mafek-en-ma, Mafek-ma**—Emerald, Egypt; Kunz believed the name denoted primarily malachite but could have meant emerald also.⁵³
- Mahá Marakata**—An emerald, which when placed on the palm and exposed to the sun, scattered light all around; the term literally means "great emerald"¹¹ (vol. 1, p. 391).
- Maragda** (Prakrit), **Maragd** (Ethiopic), **Maragde** (Provençal Fr.), **Maragdos** (Gr.), **Maragdus** (Lat.), **Marakata** (Sanskrit, Bengali), **Marakatam, Markat** (Sanskrit)^{5,43}—Emerald; according to Garbe⁴⁵ (p. 76), the root "marakata" is possibly derived from açmagarbhaya, or "sprung from the rock," perhaps alluding to crystals found embedded in schist or protruding from cavity walls.
- Mar-gad**—Emerald, Tibetan.⁶
- "Mascot Emerald"**—Trade name for a triplet gem made from three pieces of genuine beryl.²⁸
- "Mass-aqua"**—Hard glass imitation of beryl.²³
- Maxixe Aquamarin** (Ger.), **Maxixe Aquamarine, Maxixeberyll** (Ger.), **Maxixe Beryl**—Deep blue aquamarine from Maxixe mine, Brazil.^{23,28}
- "Medina Emerald," "Medina Smaragd"** (Ger.)—Emerald-green glass.^{23,28}
- Miya**—Emerald, Burmese¹¹ (vol. 2, p. 941).
- Modravec**—Aquamarine, Czech; also given as *Akvamarin*.¹³
- Mo-lo-k'ie-to**—Emerald, Chinese.⁶
- Morallas**—Translucent to opaque beryls, which may or may not be emerald color, of the emerald mines of Colombia; Webster³⁸ (p. 71) gives spelling as *Morallons*; Oelschlagel¹³ as *Morallión*. See also Pough et al.²⁸
- Morganiet** (Dutch), **Morganit** (Ger.), **Morganita** (Span.), **Morganite** (Engl., Fr., Port.)¹³—Name given to pink beryl by G. F. Kunz to honor J. P. Morgan in 1910.
- "Mother-of-Emerald"**—Prase or green jasper, rarely green fluorite; "the Jasper is often the Matrix of the Prasius, and that of the Emerald"¹¹ (pp. 120-1).
- Mujá**—Emerald, Burmese.⁵³
- Murguj, Murgujká**—Variety of emerald, India¹¹ (vol. 2, p. 901).
- Muzo Emerald**—Trade designation of top quality emerald, after the deposit in Colombia.
- Nayá**—Variety of emerald, India¹¹ (vol. 2, p. 901).
- Neronian Emerald**—An emerald improved in color by dyeing according to an ancient recipe.⁵⁴
- "Nertschinsk-Aquamarin"** (Ger.)—False name for topaz.²³
- New Granada Emerald**—Term used for locality of Colombian emeralds soon after discovery.
- "Nickel Emerald," "Nickel Emeraude"** (Fr.)—Zaratite.¹⁸
- "Night Emerald"**—Peridot.²⁸
- Nophech, Nophek**—Possible Biblical emerald.⁵⁰
- Occidental Emerald**—Term used to distinguish true emerald from green sapphire or "oriental emerald."
- Oleagenus**—Beryl "similar [in color] to that of oil"³⁴ (p. 127).
- Omphax**—Possibly identical to Pliny's *Beryllus oleaginus*.¹
- "Oriental Aquamarine," "Orientalischer Aquamarin"** (Ger.)—Pale blue sapphire; the designation "oriental" was used as early as 1667 by Pierre de Rosnel in his *Mercurie Indien*.

APPENDIX

- “**Oriental Emerald**,” “**Orientalischer Smaragd**” (Ger.)—Green sapphire.
- Oukiou** (Mongolian), **Ouyou** (Manchu)—Emerald.⁵⁵
- Pacha** (Peruvian Indian, Persian, Asiatic Indian), **Pachae** (Persian, Indian), **Pachee** (Hindi, Persian, Indian), **Pachel** (Peruvian Indian, Hindi)—Emerald.^{1,5,10,42}
- Pánná**—Emerald, Hindustani¹¹ (vol. 2, p. 876).
- Pantaura**, **Pantaure**—Emerald, Old Fr., according to Cornelius Agrippa⁵⁶ (p. 96), and so named because its figure resembles that of a panther; also called “**Pierre Solaire**.” *Pantaure*, meaning emerald, used by Jean De Taille de Bondaroy in 16th century.⁵⁷
- Param Puchche**—Emerald, Singhalese¹¹ (vol. 2, pp. 960–1).
- Párivadra**—Aquamarine, Sanskrit¹¹ (vol. 2, p. 509).
- Paryll**—Variant of beryl.⁸
- “**Peruanischer Smaragd**” (Ger.)—Apatite.¹⁹
- “**Peruvian Emerald**”—Misnomer for Colombian emerald, used when exact source unknown.
- Peruza**, **Peruzegi**, **Feruzegi**—Emerald, Arabic.⁴²
- Peyáleká**—Emerald variety, India¹¹ (vol. 2, p. 901).
- Pinga**—Emerald, Brazilian Portuguese.⁵
- “**Piro-esmeralda**” (Span., Port.), “**Piro-smeralda**” (Ital.)—Fluorite.
- “**Plasma di Smeraldo**”—Prase, Ital.⁵²
- “**Prasine Domiciane**,” “**Prasine Neomane**,” “**Prasino Domiziano**,” “**Praisino Neroniano**,” “**Prasinus**”—Emerald⁵⁸; a kind of emerald improved in color by dyeing⁴²; the terms Domitian and Neronian were first used by Epiphanius^{20,31} and repeated by de Boott.¹⁰
- “**Prassius**”—Equivalent to “**mother-of-emerald**” (which see); “they say that the *Prassius* is the House of the Emerald . . . and has all the virtues of the Emerald tho diminutively”³² (p. 218).
- “**Praxini**”—Term used for emeralds in inventory of Papal jewels in 1295.⁵⁹
- “**Prime d’Émeraude**,” “**Prisme d’Émeraude**” (Fr.), “**Prime of Emerald**”—Fluorite or other green stone and equivalent to “**mother-of-emerald**” (which see); King⁵⁴ believed the term was derived from “*prassius*.”
- “**Prismatic Emerald**”—Euclase¹⁸ (citing Mohs).
- “**Prismatic Emerald Malachite**”—Euchroite¹⁸ (citing Mohs).
- “**Pseudosmaragd**” (Ger.), “**Pseudosmaragdus**”—Applied to materials resembling emerald in color, e.g., green fluorite, jasper.
- Puchche**, **Puchche Marakatam**, **Pudu Puchche**—Emerald, emerald-like green stone, and “new” emerald respectively, Singhalese¹¹ (vol. 2, pp. 960–1).
- Puráni**—Variety of emerald, India¹¹ (vol. 2, p. 901).
- “**Pyro-Emerald**,” “**Pyro Émeraude**” (Fr.), “**Pyrosmaragdus**”—Chlorophane variety of fluorite.¹⁸
- Quetzalitzí**—“Stone of the quetzal,” Mexican Indian, green jadeite sometimes mistaken for emerald.⁶⁰
- Ra-e-hání**—Emerald colored like the flower of the same name, India.¹¹ (vol. 2, pp. 876–7).
- Raichanijj**, **Rihani**—Emerald of basil-green color, Arabic, Persian.⁵
- Rájanilam**, **Rauhenayam**—Emerald, Sanskrit¹¹ (vol. 2, p. 1021); **Rajavaral**—“king beryl,” Gujarati.⁸
- Rekha**—Streaks in emerald, India¹¹ (vol. 2, p. 901).
- Riyoku-giyoku**, **Riyoku-ho-seki**, **Riyoku-giyoku-seki**—“Green gem” or “green gemstone,” commonly applied to emerald, also **So-giyoku**, Japanese.¹⁷
- “**Root-of-emerald**”—“Mother-of-emerald” (which see).
- Rosaberyll** (Ger.), **Rose Beryl** (Engl.), **Rozeberil** (Dutch)—Rose or morganite beryl.¹³
- Rosterit** (Ger.), **Rosterita** (Ital.), **Rosterite**—Slightly altered beryl from Elba named after G. Roster by A. Grattarola in 1880.
- Sabardschah**—Emerald, Arabic.⁵
- Sábouní**, **Sabuni**, **Zabunijj**—Emerald of a mixture of white and green, Persian, Arabic¹¹ (vol. 2, pp. 876–77).
- “**Sächsischer Beryll**” (Ger.)—Apatite¹⁸ (citing Trommsdorf).
- Salaki**, **Saluki**—Emerald, Arabic.⁵
- Samarrud** (Pers.), **Samurat** (Turk.), **Samurod** (Arab.)—Emerald.⁵
- “**Sandwich Smaragd**” (Ger.)—Layered synthetic emerald of Lechleitner.²³

Appendix

- Saupurnam**—Emerald, Sanskrit¹¹ (vol. 2, p. 1021).
- Sayadi**—An emerald that when gazed upon shows the image of a man with eyes shut¹¹ (vol. 2, pp. 876–7).
- Sbaragd**—Emerald, variant of smaragd, Arabic.⁵
- Schmaragd**—Emerald, Old Ger.
- “Schmaragd Spath”** (Ger.)—Smaragdite (which see).
- “Schmelzflussmaragd”** (Ger.)—Synthetic melt-process emerald.²³
- Schohan, Schoham**—Beryl, Hebrew.⁵
- “Schorlartiger Beryll”** (Ger.)—Pycnite variety of topaz¹⁸ (citing A. G. Werner).
- “Schorl Agua Marina”** (Span.), **“Schorl Aigue-Marine”** (Fr.)—Epidote.^{14,18}
- “Schorlous Beryl”**—Pycnite variety of topaz.¹⁸
- “Scientific Emerald”**—Fused green beryl glass²⁸; also sometimes applied to green synthetic corundum or spinel, or green glass paste.
- Scythian Emerald**—Emerald from Scythia, according to Pliny.⁴
- Seberdsched**—Stone of green and yellow color, possibly emerald, Persian, Turkish.⁵
- Semargad** (Chaldaic), **Semerid** (Arab.), **Semerud**, **Smerud** (Pers.)—Emerald.⁵ See also *Samarrud*.
- Shudra**—Emerald of dark green color, Hindi.³⁰
- “Siam Aquamarine”**—Blue zircon or greenish spinel.²⁸
- Siberget**—Possibly emerald.⁵
- Siberian Aquamarine**—Trade name for pale greenish-blue aquamarine from Russia.²⁸
- “Siberischer Smaragd”** (Ger.)—Green tourmaline.²³
- Silkijj, Selongi**—Leaf-green emerald, Arabic.⁵
- “Sinaraydoprase”**—A variety of emerald.⁵⁸
- “Sklo Berylové”**—Green glass, Czech.¹³
- “Skythischer Smaragd”** (Ger.)—Apparently diopside and not the Scythian emerald of Pliny.²³
- Smarag** (Scot. Gaelic), **Smaragd** (Ger., Bohemian, Czech, Magyar, Swed., Dan., Dutch), **Smaragdes** (O. Ger.), **Smaragdo** (Pers.), **Smaragdos** (Gr., Coptic), **Smaragdu** (Wallachian), **Smaragdus** (L., O. High Ger.), **Smarakata** (Sanskrit), **Smaraldus** (O. Swed., O. Ger.), **Smarall** (Ger., 16th c.), **Smarat** (Mid. High Ger.), **Smareit** (Mid. High Ger.), **Smargdo** (Syriac), **Smerald** (Dalmatian, Wendic), **Smeraldo** (Span., Ital.), **Smiraldus** (Europe, Middle Ages), **Smruucht** (Armenian)—Emerald.^{5,21,42,61}
- Smaragd Bahjský**—Emerald, State of Bahia, Brazil; **s. Brasilský**—Brazilian emerald; **s. Kolumbijský**—Colombian emerald; **“s. lithový”**—hiddenite; **“s. medený”**—diopside; **“s. soudé”**—doublet emerald; **s. syntetický**—synthetic emerald, all Czech designations.¹³
- “Smaragdine”**—Green chlorophane variety of fluorite.⁴⁹
- “Smaragdite”**—Greenish massive amphibole¹⁶; actinolite pseudo after hornblende, also foliated hornblende or emerald-green diallage, or jadeite-like zoisite, or beryl glass imitation which is chemically analogous to beryl.²³
- “Smaragdfluss”** (Ger.)—Rock crystal, fluorite; **“Smaragdkrystall”**—rock crystal¹⁹; **“Smaragdmatrix,”** **“Smaragdmutter”**—fluorite, also a green stone actually the matrix of emerald²¹; matrix of emerald crystals consisting of feldspar and quartz, but also a false name for prase²³; **“Smaragdochalcit,”** **“Smaragdochalzite”**—atacamite or diopside.¹⁸ **“Smaragdolin”**—fused beryl glass^{23,28}; **“Smaragdoprasem”**—prase, plasma¹⁹; **“Smaragdo-Prase,”** **“S.-Praseus”**—various green stones, usually some green massive variety of quartz, but none emerald⁴⁰; **“Smaragdospath”**—feldspar.¹⁹ All German terms.
- “Smaragdus Calcedonius”**—Amazonite⁵²; **“S. Cyprius”**—“mother-of-emerald”⁵² (which see); **“S. medicus”**—malachite²⁸; **S. Scythicus**—Scythian emerald of Pliny,⁴ but King⁵⁴ (p. 311) deems it “green ruby,” i.e., green sapphire.
- “Smaryl”** (Ger.)—Composite gem of two layers of pale emerald or beryl cemented with colored plastic layer.^{23,28}
- Smeraldo**—emerald; **“s. Africano”**—green fluorite; **“s. degli Urali”**—demantoid garnet; **s. di Bahia**—emerald, State of Bahia, Brazil; **“s. del Brasile”**—green tourmaline; **“s. del Capo”**—prehnite; **s. di Colombia**—Colombian emerald; **“s. di litio”**—hiddenite; **“s. lition”**—hiddenite; **“s. matrice”**—green fluorite; **“s. orientale”**—green sapphire; **“s. di rame”**—diopside; **“s. ricostituito”**—green glass; **“s. saldato”**—com-

APPENDIX

- posite gem; s. **syntetico**—synthetic emerald, sometimes applied to green glass. All Italian terms.¹³
- So-bo-riyoku**—"Sea-green gem," aquamarine, Chinese.
- So-ko**—Emerald, Japanese.¹⁷
- "Soldered Emerald"**—See *Soudé Emerald*.
- Sommorod, Somorods, Sümrud**—Emerald, Arab.⁵
- "Soudé Emerald," "Soudé Émeraude"** (Fr.), **"Soudé Smaragd"** (Ger.)—Composite gem made from two pieces of quartz with emerald-colored layer of plastic between.^{23,38}
- "Spanish Emerald"**—Green glass; in older periods sometimes designating finest quality Colombian emerald.²⁸
- Star Beryl, Sternberyll** (Ger.)—Brown or black beryl from Brazil displaying six-legged star;²³ **Sternaquamarine** (Ger.)—same, ilmenite inclusions.²³
- Sulki**—Emerald partaking of color of *Chekundur*, the Persian curry¹¹ (vol. 2, pp. 876–7).
- "Symerald"**—Name given to later Lechleitner synthetic emerald.²³
- "Synthetic Aquamarine," "Synthetic Aquamarin"** (Ger.)—Blue synthetic corundum or spinel.
- Synthetic Emerald**—Artificially grown equivalent of natural emerald.
- "Synthetic Rosaberyll"** (Ger.)—Synthetic rose spinel.²³
- Szmaragd**—Emerald, Polish.⁵
- S'zmulu**—Oriental name for emerald derived from the name of Island of Sumatra according to Pumpelly, cited in Geerts.¹⁷
- Tabarget**—Emerald, Arabic.¹⁰
- Taperzeta**—A stone sometimes given as equivalent to emerald in Middle Ages literature.⁵
- Tap-y-acar**—"Green stone," used by Muzo Indians of Colombia to designate emerald.⁶²
- Tarkshya**—Emerald, Sanskrit.³⁰
- Tarshish**—Biblical name for possible beryl, Hebrew.^{28,53}
- "Tecla Emerald," "Teclasmargd"** (Ger.)—Three-layered emerald imitation made from quartz or glass with green central layer.²³
- Thalassus Marinus** (Gr.)—Aquamarine, probably coined in Middle Ages.⁶³
- To-hi-sui**—Emerald, Japanese.¹⁷
- Torá**—Beryl tinged with yellow.¹¹
- Toréka**—Variant of emerald¹¹ (vol. 2, p. 901).
- Trapiche Emerald, Trapiche Smaragd** (Ger.)—Emerald crystal containing radial inclusions or growth sectors of pale color, somewhat resembling the cogs of the Spanish *trapiche* gear used in crushing sugar cane.²³
- "Tripletin"** (Ger.)—Emerald-green triplet imitation gem.²³
- Tsu-mu-lu, Tsie-mu-lu**—Emerald, 17th-century China.⁶
- Tsung-yu** (Chin.)—"Valuable or precious stone of green color," sometimes applied to the emerald.¹⁷
- Tsuni** (Bengali)—Emerald.⁵
- Umiña**—Emerald, Quichua of Peru.³³
- Vaidhurya, Vaidurya** (Sanskrit, Hindi, Cananese), **Vaidugra** (Marathi), **Vayaja** (Cananese), **Veluriya** (Pali), **Veruliyam** (Prakrit), **Weluriya** (Singhalese)—Beryl, also identified with lapis-lazuli in some Sanskrit dictionaries⁸; *vaidurya* identified as emerald by Ball⁶⁴ (p. 719–20), and the word may be of Dravidian origin²¹ (p. 189).
- Vaishya Emerald**—Yellowish-green variety, Hindustani.³⁰
- Vetro di Berillo** (Ital.), **Vidrio de Berilo** (Span.), **Vidro de Berilium** (Port.)—Glass.¹³
- Vorobeyevite, Vorobyevite, Vorobievite** (Engl.), **Worobieffit, Worobiewit** (Ger.)—Cesium beryl, white or pink, named after mineral collector V. I. Vorobyev, who first exhibited specimens from Lipovka, Urals⁶⁵ (citing Vernadsky).
- "White Emerald"**—Goshenite.
- Yashpeh, Yashpneh**—See *iaschpech*.
- Yemerarudo**—Emerald in cursive Japanese.¹⁷
- Ysoberillus**—"A species of the Beril."³²
- Zabargad** (Arab.), **Zabargat** (Pers.), **Zabergad** (Hindi), **Zeberjed, Sabardschad** (Arab.)—Emerald^{4,5,6}; one or more of these terms may also apply to the peridot of St. Johns Island or Zebirget, in the Red Sea, and Keferstein⁵ claims that this is the case most of the time.
- Záhábí**—Emeralds that have the "color of gold"¹¹ (vol. 2, pp. 876–7).
- Zamargad** (Ethiopic), **Zamardun** (Europe)⁴³, **Zamarut, Zamarrute, Zamorat** (Arab.), **Zamrud** (Malayan)—Emerald.^{1,5,10,11,42}
- Zemeroud Mesri** (Persian)—Egyptian emerald⁵;

Appendix

- zemerud** (Turk., Malay.), **zemrukht, zemruxt** (Armenian)—emerald.^{5,6}
- Zerfass Emerald, Zerfass Smaragd** (Ger.)—Hydrothermal synthetic emerald made by W. Zerfass of Germany.^{23,38}
- Zmeroud** (Polish, Persian), **Zmeroud Misrai** (Egypt. = "first class emeralds"), **Zmerud** (Persian), **Zmroukt, Zmrukht, Zmrroud** (Armenian), **Zmuri** (Georgian)—Emerald.^{5,31}
- Zobabi**—Vivid green emeralds, like *Cantharides* flies in color, Arabic.⁵
- Zubara Emerald**—Egyptian emerald.²⁸
- Zuburzud**—"A stone sometimes mistaken for the emerald," Egypt.¹¹ (vol. 2, pp. 952–3).
- Zucht-Smaragd** (Ger.)—Synthetic emerald.²³
- Zumarrud** (Arab., Persian), **Zumurud** (Egypt., Arab.), **Zumurrud** (Arab., Persian, Syriac), **Zumurid, Zumird, Zümürüt, Zimbrut** (Turk.)—Emerald.^{5-7,11,15a,53}
1. Hill, J. 1774. *Theophrastus's History of Stones*. 2nd ed. London: 342 pp.
 2. King, C. W. 1866. *Amique Gems, Their Origin, Uses and Value*. 2nd ed. London: J. Murray. 498 pp.
 3. *Edinburgh Review* 1866. vol. 124, no. 253, pp. 228–60.
 4. Ball, S. H. 1950. *A Roman Book on Precious Stones*. Los Angeles: Gemological Institute of America. 338 pp.
 5. Keferstein, C. 1849. *Mineralogia polyglotta*. Halle: Eduard Anton. 248 pp.
 6. Laufer, B. 1919. *Sino-Iranica, Chinese contributions to the history of civilization in ancient Iran*. Field Museum of Natural History Publication 201, Anthropological Series vol. 15, no. 3. Chicago: Field Museum of Natural History. pp. 185–630.
 7. Haschmi, M. Y. 1956. Der ägyptische Smaragd. *Der Aufschluss* (Heidelberg) 7:100–2.
 8. Wiener, L. 1921. *Contributions Toward a History of Arabico-Gothic Culture*. Vol. 4; *Physiologus Studies*. New York: Neale Publishing Co. 388 pp.
 9. King, C. W. 1867. *The Natural History of Gems or Decorative Stones*. London: Bell & Daldy. 377 pp.
 10. Boodt, A. B. de 1609. *Gemmarum et Lapidum Historia*. Hanover: Typis Wechelianiis. 294 pp.
 11. Tagore, S. M. 1879. *Mañi-Mälä, or a Treatise on Gems*. 2 vols. Calcutta: Stanhope Press. 1046 pp.
 12. Aloisi, P., and Baldasseroni, V. 1932. *Trattato sulle Pietre Preziose con un' Appendice sulle Perle e sui Coralli di Vincenzo Baldasseroni*. Florence: Felice Le Monnier. 405 pp.
 13. Oelschlagel, H. 1939. *Dictionnaire Technique des Métaux Précieux, des Pierres Fines* The Hague: Mouton & Co. 836 pp.
 14. Kozminsky, I. 1922. *The Magic and Science of Jewels and Stones*. New York and London: G. P. Putnam's Sons. 434 pp.
 15. Apolinar Maria, H. 1947. Apuntes sobre las esmeraldas. *Academia Colombiana de Ciencias Exactas Físicas Naturales Revista* (Bogota) 7:324–7.
 - 15a. Sayar, M. 1955. *Mineraloji v. jeoloji*. Istanbul: Teknik U. Matbaasi. 762 pp.
 16. Schaller, W. T. 1918. Gems and precious stones. Chapter in *U.S. Geological Survey Minerals Resources of the United States for 1917*, pp. 145–68.
 17. Geerts, A. J. C. 1878–83. *Les Produits de la Nature Japonaise et Chinoise*, 2 pts. Yokohama: C. Lévy. 662 pp.
 18. Egleston, T. 1889. Catalogue of minerals and synonyms. *U.S. National Museum Bulletin* 33 (Washington, D.C.). 198 pp.
 19. Reuss, F. A. 1798. *Neues mineralogisches Wörterbuch*. Hof: G. A. Grau. 503 pp.
 20. Epiphanius. 1565. *De XII. Gemmis*. Zürich: Conrad Gesner. 56 pp.
 21. Lüschen, H. 1968. *Die Namen der Steine*. Thun & Munich: Ott Verlag. 384 pp.
 22. Pannier, L. C. A. 1882. *Les Lapidaires français du Moyen Âge*. Paris: F. Vieweg. 340 pp.
 23. Chudoba, K. F., and Gübelin, E. J. 1974. *Edelsteinkundliches Handbuch*. 3rd ed. Bonn: Wilhelm Stollfuss. 408 pp.
 24. Gallitzin, D. 1801. *De Recueil de Noms . . . en Minéralogie*. Brunsvik: Orphelins. 320 pp.
 25. Spener, J. J. 1687. *De Gemmis Errores Vulgaris*. Leipzig: Typis Christophori Fleischeri. 40 pp.
 26. Holtzapffel, C. 1850. *Turning and Mechanical Manipulation*. Vol. 3. London: Holtzapffel & Co. pp. 1026–1477.
 27. Chester, A. H. 1886. *A Catalogue of Minerals, Alphabetically Arranged*. New York: John Wiley. 52 pp.
 28. Pough, F. H.; Bowman, J. J.; and Hoke, C. M. 1950. *The Jewelers' Dictionary*. 2nd ed. New York: 230 pp.
 29. Eppler, A. 1912. *Die Schmuck- und Edelsteine*. Stuttgart: P. Kraiss. 464 pp.
 30. Tank, R. R. ca. 1968. *Indian Gemmology*. Jaipur: Dulichand Tank. 171 pp.
 31. Blake, R. P. and De Vis, H. *Epiphanius De Gemmis, The Old Georgian Version*. London: Christophers. 335 pp.
 32. Leonardus Camillus 1750. *The Mirror of Stones*. London: Printed for J. Freeman. 240 pp.
 33. Olden, C. 1911. Emeralds: their mode of occurrence and methods of mining and extraction in Colombia. *Transactions of the Institution of Mining and Metallurgy* (London) 21:194–203.
 34. Bandy, M. C., and Bandy, J. A. trans. 1955. *De natura fossilium (Textbook of Mineralogy)*, by Georgius Agricola. Geological Society of America Special Paper 63. New York: Geological Society of America. 240 pp.
 35. Bristow, H. W. 1861. *A Glossary of Mineralogy*. London: Longman, Green, Longman, and Roberts. 420 pp.
 36. Harris, T. M. 1833. *A Dictionary of the Natural History of the Bible*. Rev. ed. London: T. T. and J. Tegg. 350 pp.
 37. Hill, J. 1771. *Fossils Arranged according to their Obvious Characters*. London: Printed for R. Baldwin. 420 pp.
 38. Webster, R. 1970. *The Gemmologists' Compendium*. 5th ed. London: Wehman 235 pp.
 39. Mangin, A. 1875. *Earth and Its Treasures* Translated

APPENDIX

- by W. H. D. Adams. London: T. Nelson and Sons. 405 pp.
40. Landrin 1852. *Dictionnaire de Minéralogie*. Paris: Firmin Didot Frères. 506 pp.
 41. Arphe de Villafañe, J. 1572. *Quitlatador de la Plata, Oro y Piedras*. Valladolid: privately published. ca. 142 pp.
 42. Gimma, G. 1730. *Della Storia Naturale delle Gemme*. 2 vols. Naples: Gennaro Muzio. 551, 603 pp.
 43. Laet, J. de. 1647. *De Gemmis et Lapidibus . . . Theophrasti Liber de Lapidibus*. Lugduni Batavorum. Also Leiden: J. Maire. 210 pp.
 44. Bostock, J., and Riley, H. T. 1855-7. *The Natural History of Pliny*. Vol. 6. London: Henry G. Bohn. 529 pp.
 45. Garbe, R. 1882. *Die indischen Mineralien*. Leipzig: Verlag von S. Hirzel. 104 pp.
 46. Ray, P. C. 1904. *A History of Hindu Chemistry*. 2nd ed. 2 vols. Calcutta: Chuckerverty, Chatterjee & Co. 312, 70 pp.; 290, 152 pp.
 47. Vlasov, K. A. 1966. *Geochemistry and Mineralogy of Rare Elements and Genetic Types of their Deposits*. Vol. 2.: *Mineralogy of the Rare Elements*. Jerusalem: Israel Program for Scientific Translations. pp. 67-169.
 48. Eppler, A. 1920. Der Heliodor. *Die Umschau* 24, no. 33, pp. 497-500.
 49. Beckmann, J. 1846. *A History of Inventions*. 4th ed. 2 vols. London: Henry G. Bohn. 519, 548 pp.
 50. Clapton, E. 1899. *The Precious Stones of the Bible*. 2nd ed. London: Simpkin, Marshall, Hamilton, Kent & Co. 231 pp.
 51. Neuhauser, W. E. 1621. *Coronae Gemma Nobilissima*. Frankfurt ? privately published. 164 pp.
 52. Corsi, F. 1845. *Delle Pietre Antiche*. 3rd ed. Rome: Gaetano Puccinelli. 448 pp.
 53. Kunz, G. F. 1913. *The Curious Lore of Precious Stones*. Philadelphia and London: J. B. Lippincott. 406 pp.
 54. King, C. W. 1865. *The Natural History, Ancient and Modern, of Precious Stones and Gems*. London: Bell and Daldy. 442 pp.
 55. Abel-Rémusat, J. P. 1820. *Histoire de la Ville de Khotan*. Paris: Imprimerie De Doublet. 239 pp.
 56. Santini De Riols, E. N. 1905. *Les Pierres Magiques*. Paris: Bibliothèque Chacornac. 173 pp.
 57. Taille De Bondaroy, J. de la. 1574. *La Geomance . . . Ensemble le Blason des Pierres Precieuses*. Paris: Lucas Breyer. 68 pp.
 58. D, M.D.L.S.D. 1667. *Le Denombrement, Facultez et Origine des Pierres Precieuses*. Paris: Chez André Boutonné, 71 pp.
 59. Twining, Lord. 1960. *A History of the Crown Jewels of Europe*. London: B. T. Batsford. 707 pp.
 60. Kunz, G. F. 1915. *The Magic of Jewels and Charms*. Philadelphia and London: J. B. Lippincott. 422 pp.
 61. Feldhaus, F. M. 1954. Imitation emerald problems in the 16th century. *The Gemmologist* (London) 23:174-6.
 62. Morello, T. 1956. The gem of Colombia. *Américas* 8, no. 10, pp. 21-4.
 63. Brückmann, U. F. B. 1757. *Abhandlung von Edelsteinen . . . Braunschweig: Waysenhausbuchhandlung*. 143 pp.
 64. Ball, S. H. 1931. Historical notes on gem mining. *Economic Geology* 26:681-738.
 65. Vernadsky, V. I. 1908. O vorob'evite. *Trudy Geologicheskoy Akademiyi Nauk* (St. Petersburg) 2, no. 5, pp. 81-102.
 66. Thompson, R. Campbell. 1936. *A Dictionary of Assyrian Chemistry and Geology*. Oxford: Clarendon Press. 266 pp.

GENERAL AND LOCALITY INDEX

Page numbers followed by the letter "t" indicate information found in tables.

- A.B.C. mine, California, 598
Aaron, 81
Abdul Hamid I, 124
Abdul Hamid II jewels, 124, 125, 140
Abenzoar, 77
Aberdeen Shire, Scotland, 548, 549
Abolays, 27
Abrasives, 325, 326
Absorption spectra
 aquamarine, 219
 aquamarine filter, 221
 bazzite, 224
 beryl, curves, 223
 causes, 206–213 *passim*
 Chatham emerald, 306
 chromium, 209–213 *passim*, 219, 222, 224
 coefficients, 216
 curves, 211, 215, 218, 223
 emerald, 209
 curves 211, 212–213t
 emerald filter, 217
 Habachtal emerald, 375
 I. G. Farbenindustrie emerald, 302
 infrared, 224
 iron, 218, 221, 222
 Lechleitner emerald, 317
 Linares emerald, 307
 Linde emerald, 319
 Mampang emerald, 445
 manganese, 219, 222, 224
 Manyara emerald, 512
 Absorption spectra (continued)
 Maxixe beryl, 220, 221t
 Mayfield Farm emerald, 605
 Mingaora emerald, 489
 morganite, 222
 Rajasthan emerald, 452
 red beryl, 224
 scandium, 224
 titanium, 219
 vanadium, 209–214 *passim*, 219, 222
 Acetate of copper dye, 293
 Achard, F.C., fusion, 50
 Achmed I, 127
 Acosta, José de, on emerald "growth", 44
 Adui River district, USSR, 524, 525
 Adun Chilon, USSR, 53, 55, 208, 271, 286, 514–517,
 515 *map*, color fig. 7
 Aepinus, F.U., 49
 Aeroides, 20
 Afghanistan, 19, 359–361
 Agastimata, 446
 Agate, 88
 Agilulf, 130
 Agricola, George, 27, 30, 31
 Aguacate cut, 36
 Aguanga, California, 595, 596
 Ahlahmah, 81
 Ahmed I, 124
 Ahmed Ben Abdalaziz, 77
 Aigrette jewel, 12
 Ajmer-Merwara emerald field, Pakistan, 451

INDEX

- Akerhus, Norway, 487
 Alabama, 576, 577
 Alabashka-Mursinka-Shaytansk region, USSR, 519,
 521, 522 *map*, 524
 Alagoas, Brazil, 383
 Alaric, 99
 Alaska, 592
 Al-Beruni, 542
 Al-Kindi, 542
 Albertus Magnus, 67–80 *passim*, 281
 Alexander Co., North Carolina, 566–570
 Alexander the Great, 20, 99
 Alexandrian hoard of gems, 547
 Alexandrite
 Manyara, 512, 513
 Urals, 350, 536, 537
 Zimbabwe, 606
 Alfonso X, 26
 Alger mine, New Hampshire, 555
 Algeria, 361
 Alkali beryls
 color varieties, 222
 corrosion, 244, 247
 environment, 349
 forms and habits, 242, 244, 255–257 *passim*, color
 figs. 11, 14
 goshenite, 3, 218, 558, 564, 611
 heat treatment, 228
 Madagascar type, 256, 467
 morganite, *which see*
 optical properties, 198–200, 368, 459, 475, 478,
 553, 584, 696
 specific gravities, 190, 191, 368, 459, 469, 475,
 478, 553
 Alkali etchants, 266, 268
 Alkalinity test, 177, 178
 Alkalis
 channel, 166–172 *passim*
 in formulas, 172, 175
 influence on density, 190
 influence on habit, 256
 influence on refraction, 199, 200
 maximum reported, 167
 ranges in content, 167, 168
 solvents, 176, 177
 Allier, France, 440
 Alluvial deposits, 21, 354, 355
 Alpine clefts, 353, 354, 568
 Altay (Altai) Mountains, USSR, 50, 518
 Alteration, 173–175
 Alto Adige, Italy, 456, 457
 Alto do Giz, Brazil, 383
 Alto Ligonha, Mozambique, 275, 482
 Aluminum (alumina)
 content, 164
 early determination, 47
 structural site, 158, 159, 162, 171
 substitution and replacement, 172
 Amazonite, 83, 469, 475, 537
 Ambatolampy, Madagascar, 475
 Amber, 23
 Ambositra region, Madagascar, 479
 Ameib, South West Africa, 501
 Amelia Co., Virginia, 564
 Amenophis I, 292
 Amenophis III, 5, 542
 American Gem and Pearl Co., 571
 American Gem Mining Syndicate, 567
 American Gems, Inc., 568, 569
 American Museum of Natural History, 112, 141, 142
 Amethyst, 15, 521
 Ampandramaika-Malakalina region, Madagascar, 472
 map, 479
 Ampangabe, Madagascar, 465
 Amstutz, A., and A. Borloz, synthesis, 296
 Amulets, 4, 9, 106
 Egyptian, 61, 62, 106
 epilepsy prevention, 77, 78
 powers of, 65, 73
 protective in childbirth, 78
 protective of seamen, 96, 97
 scarabs, 95
 snake bites, 77
 Anacreon, carving, 108
 Analava-Isakeley field, Madagascar, 474
 Analyses
 bazzite, Kazakhstan, 169, 170, 519
 Bondasco, Italy, beryl, 510
 Chatham emerald, partial, 306
 Chivor emerald, 425
 Habachtal emerald, 376
 Hagendorf-Süd, Germany, beryl, 444
 Indian beryls, 449, 450
 Italian beryls, 457
 Lyndoch, Ontario, beryl, 403
 Maxixe beryl, partial, 220
 Miku, Zambia, emerald, 602
 Montescheno, Italy, beryl, 457
 Mount Mica, Maine, alkali beryls, 553
 Muzo emerald, 419
 Muzo matrix rock, 417
 Poona, W. Australia, emerald, partial, 368
 Rila, Bulgaria, emerald, 400
 Rössing, South West Africa, heliodor, 506
 Sandawana, Zimbabwe, emerald, 607
 South African emerald, 498
 Tsilaisina, Madagascar, morganite, 478
 Uralian emerald and beryl, 535
 Vauquelin emerald and beryl, 54, 164
 Analytical methods, 50, 51, 53, 163, 175–177
 Andreas, Bishop of Caesarea, 86
 Andrew, Apostle, 86
 Andrews quarry, Connecticut, 560
 Andhra Pradesh, India, 449
 Andriamena region, Madagascar, 469
 Androscoggin Co., Maine, 553

Index

- Angles
 facet gem, 333–335
 interfacial, 258, 260–261t
 supplementary (interior), 259
- Angola, 361
- Ankazobe-Vohambohitra region, Madagascar, 469,
 470 map, 471
- Anomalies, optical, 201–204, 272
- Antaboaka, Madagascar, 476
- Antarctica, 361
- Anthony, Wayne, 568
- Anthrax, 84, 85
- Antidotes, 77
- Apatite
 Mount Apatite, Maine, 553
 Mozambique, 484
 Ural emerald deposits, 537
- Apocalypse gems, 39
- Apostle stones, 86
- Aquamarine
 absorption spectra, 218
 curves, 223
 asterism, 195, 196, 285, 518
 birthstone, 88
 breastplate stone, 85
 carvings, 11, 119, 120
 cat's-eye, 194, 479, color fig. 13
 chromium, 216
 color, 44, 217–221
 color filters, 221
 color zoning, 208, 210, 517, color fig. 8
 composition. *See* Analyses
 crystal forms, 244–246, 256, 257
 deposit types, 340, 341, 342, 352, 353
 dichroism, 208t, 219
 early sources, 11
 Elizabeth II jewels, 135–137
 engraved gems, 106, 108, 109
 etch pits, 244, 245, color figs. 7, 9, 17
 fiber optics effect, 195
 Fortaleza, 292
 gems, important, 127, 129, 141–144 *passim*, color
 figs. 15, 19
 gems, U.S. material, 142, 143
 heat treatment, 228, 230
 imitations, 49, 294
 infrared luminescence, 232
 irradiation, 229, 230
 lapidary treatment, 326
 large crystals, 55, 142, 388, 390, 391, 394, 396,
 517, color fig. 17
 Lucia, 391
 luminescence, 232
 Marat sword handle, 138, 139
 Marta Rocha, 391
 Maxixe. *See* Maxixe beryl
 naming of, 614
 Nero's eyeglass, 99
- Aquamarine (continued)
 netsuke, 120
 optical anomalies, 203, 204
 patriotic wear, 90
 refractive index, 197, 198t, 199, 200, 364, 368,
 370, 399, 400, 436, 439, 448, 449, 450, 456,
 457, 459, 463, 475, 488, 491, 508, 517, 534,
 538, 548, 557, 584
 seal stones, 119, 120
 specific gravity, 190, 191, 368, 399, 400, 403, 436,
 439, 448, 449, 450, 455, 456, 457, 459, 463,
 475, 476, 497, 506, 508, 534, 538, 548
 star, 195, 196. *See also* Asterism
 snuff bottles, 11, 119
 Townshend collection, 137, 138
- Arabic inscriptions, 95, 107, 112–115, 121, 126
- Arabic lore, 74, 77, 79
- Arassuahy, Brazil, 392
- Archer's rings, 114
- Argentina, 361, 362
- Argon, 170
- Ariège, France, 441
- Aries, 87, 88
- Aristotle, 13, 70, 72, 76, 77
- Arizona, 591, 592
- Artemisia dracunculus, 72
- Artificial beryls, 292–295
- Artificial coloration, 293
- Asher, tribal patriarch, 89
- Asterism, 194, 196
 heat treatment causing, 226
 inclusions causing, 285
 orientation of rough, 330, 331
- Astrology, 27, 60
 birthstones, 87, 88
 lore, 64, 69, 90–93
- Atahualpa emerald, 144
- Atharva-veda, 64
- Atkinson, T.W., 525
- Aubrey's Miscellanies, 73
- Augustus the Strong, 127
- Aura of energy, 74, 91
- Aureus color, 89
- Australia, 363–370
- Austria
 deposits, 371–377
 Habachtal emerald, 371–376
 treasures, 127
- Aventurescence, 331
- Avocado cut, 36
- Avon, Idaho, 587
- Avondale, Pennsylvania, 563
- Axes, 237–240
 intercepts, 243
 ratios, 160, 161t
 rotational, 240
 symmetry, 240

INDEX

- Babylon, 27
 Backings, gem, 293, 294
 Bactria, 19, 30, 66
 Baden, Germany, 444
 Badger Flats, Colorado, 582, 583
 Bahia, Brazil, 383–386, 387 *map*
 Baja California, Mexico, 480, 481, 594
 Bajoobund, 113
 Baker, G.J., 602
 Balas ruby, 41
 Ball, S.H., beryl names, 611, 614, 615t (Pliny)
 Baltistan, Pakistan, 488
 Baltzley, W.D., 568
 Banff Shire, Scotland, 548
 Barbara Farm, Republic of S. Africa, 492
 Bareketh, baraket, 81, 83, 84, 85
 Bariel, 89
 Barium, 168, 172
 Barlowe emeralds, color fig. 21
 Baroque emeralds, 146, 147, 332, color fig. 24
 Barra de Salinas, Brazil, 392
 Bartoli, P.S., 17
 Basal cleavage, 185
 Basal plane or pinacoid, 242, 243
 Basic rocks, 349, 350
 Basse-Pyrénées, France, 442
 Bastard smaragde, 40
 Bavarian imperial treasures, 129, 130
 Bayerischen Wald, Germany, 444
 Bazzite, 169, 170, 339
 analysis, Kazakhstan, 519
 color, 218, 224
 optical properties, 199, 519
 specific gravity, 519
 Switzerland, 510
 synthesis, 224, 321
 Bazu band, 113, 114
 Bdelium, 86
 Beaver Co., Utah, 589
 Bedford, New York, 562
 Beebe Hole mine, California, 599
 Beghtol & Co., 584
 Beira Alta Province, Portugal, 490, 491
 Bekisopa region, Madagascar, 480
 Belingwe-Sandawana field, Zimbabwe, 606, 607
 Belzoni, G.B., 543
 Bement, C.S., hiddenite crystal, 567
 Bench mining, 427–429
 Benedictine Abbey, Reichenau emerald, 100
 Bennett quarry, Maine, 553
 Berenice, United Arab Republic, 65
 Berere-Tsaratananana field, Madagascar, 467, 468
 Bergman, T., fusion, 50
 Beryl chemical color tests, 178, 179
 Beryl Hill, New Hampshire, 555
 Beryl mine group, Republic of S. Africa, 498
 Beryl Mining Co., Ltd., Republic of S. Africa, 492, 493
 Beryl Mountain, New Hampshire, 556
 Beryllia (beryllium oxide), 51, 53, 163, 164, 209
 Beryllion, beryllios birthstones, 83–86 *passim*
 Beryllium, 47
 content in beryl, 164
 content in crust, 338
 structural position, 171, 172
 tests for, 177–179
 Beryllonite, 553
 Beryllus of Pliny, 19, 20
 Berylmeter, 179
 Betafo-Antsirabe region, Madagascar, 474–476
 Betsiriry region, Madagascar, 472, 474
 Bey, Helekyon, 543
 Bezoars, 23, 37
 Bhasma, 92
 Biaxiality, 202, 203, 204
 Biblical gemstones, 32, 37, 80, 86
 Biblical lapidaries, 24–27
 Bic'c'haya, 63
 Bihar, India, 448, 449
 Bikita field, Zimbabwe, 605
 Bipyramids
 dihexagonal, 254t
 etch marks, 270
 first order, 250, 252t
 interfacial angles, 260, 261
 second order, 252, 253t
 Birefringence, 197
 Birthstones, 87–97 *passim*
 alternate, 90
 engraved, 97
 origin of use, 87
 Polish use, 87
 table, 88
 Bishfota, 63
 Bithur-Chat mines, India, 451, 453
 Bity (Mount), Madagascar, 476, 477 *map*
 Bixbite, 223
 Bixby, Maynard, 223, 589
 Black beryl, 483, 484
 Black Hills, South Dakota, 577
 Black Mountain, Maine, 551
 Black Panther mine, California, 598
 Blanche of Anjou, 132
 Bloodstone, 74, 88
 Bob Ingersoll mine, South Dakota, 275, 579
 Bogdanovich emerald mine, Urals, USSR, 537
 Bohemia, Czechoslovakia, 38, 40, 48, 436
 Bolivia, 377, 378
 Bolshoi Refit, Urals, USSR, 526
 Bomba aquamarine, 391
 Bom Jesus das Meiras, Brazil, 384–386
 Bonds, 157
 Boniface VIII, 130
 Borborema, Brazil, 381, 383
 Bordonaro quarry, Connecticut, 560
 Borschchovochnoi Khrebet, USSR, 514
 Bowman, D.A., 570
 Boyle, Robert, 44, 75, 206

Index

- Bracciano, Duke of*, 17
Bragg, W.H. and W.L. Bragg, 57
Branchville Mica mine, Connecticut, 561
Brandberg, South West Africa, 501
Bravais, A., 243
Bravais-Miller symbols, 241, 243
Brazil, 21, 55, 378–397
 aquamarine exports, 389
 Bahia, 383–386
 emerald deposits, 384–386, 389, 396
 emerald production, 381
 history, 378, 381
 large gem beryls, 390, 391, color fig. 17
 Minas Gerais, 389–396
 ore beryl production, 381, 389
Brazilian emerald, 32, 34, 38, 49, 378
Breastplate of High Priest, 24, 81–86
Breathing disorders, 80
Brejaúba emerald, Brazil, 396
Brewster, David, 281
Brilliance, 325, 327, 335
Brisson, Mathurin, 50, 51, 53t
British Columbia, 406, 407
British Museum gems and jewelry, 8, 106, 107
British Museum (Natural History) morganite gem, 137, 465, color fig. 12
Brittany, 38, 48, 439
Brocchi, G.B., 543, 546
Brodbo, Sweden, 509
Broken Hill, Australia, 364
Bromell, M. v., fusion, 47
Bromoform, 179, 329
Bronkie, Willis F., 412
Brown Derby pegmatites, Colorado, 584
Bruce, James, 542
Brusch, Heinrich, 61
Brumado, Brazil, 384
Brunswick, Maine, 554
Brush, George B., 561
Bubani mines, India, 451, 453
Buddha, Emerald, 101, 102
Buddha's Tooth, 192
BVD mine, Republic of S. Africa, 495
Buenavista, Colombia, 412, 423 *map*, 426, 433
Buganda, Uganda, 513
Bulgaria, 399, 400
Bumpus quarry, Maine, 275, 551
Burdy, H.A., 109
Burman, 49, 400
Buryat ASSR, USSR, 518
Bussy, A.A.B., 53

Cabinet des Médailles, Paris, 108
Cabochons, 325, 330–332 *passim*
Cacique of Guatavita, 93
Cailliaud, F., 5, 542, 546, 547
Cairngorm, Scotland, 548
Calac prospect, California, 597
Calcium, 167, 172

Calculi, 23
California, 593–600
California mine, Colorado, 583
Caliph al-Musta, 25
Calls, 72
Cama, 417–419 *passim*
Cambiado, 416–419 *passim*
Cameo, 106
 Kaiser Leopold I, 112
 South African emerald, 494
Canada, 400–407
Cancer, 69, 88, 89
Cangagem, India, 446
Cantharides, 547
Canton, John, 49
Capas buenas, 416, 417
Capas esmeraldíferas, 416, 417
Caplan, Allan, emerald, 112–113
Carbonate veins, 353
Carbon dioxide
 channel, 172
 inclusion, 281, 285
Carbonate color center, 220
Carbuncle, 84, 85
Carchedonian emerald, 66
Carinthia, Austria, 371
Carnaiba emerald, Brazil, 384, 385 *map*
Carnelian, 10
Cartesian coordinates, 237
Carved beryls and emeralds, 115–118, 119, 494, 518, color fig. 21
Carving, 332
Case quarries, Connecticut, 560
Cathedral of Mainz emerald, 100
Cathedral of San Giovanni, 100
Catherine the Great, 110, 125, 126
Cathodoluminescence, 232
Cat's-eye beryl
 Brazil, 330, color fig. 13
 emerald, 330
 Madagascar, 194, 465, 478, 479
 morganite, 195
 orientation of rough, 330
Cat's-eye chrysoberyl, 10, 63, 88, 90, 330
Caucasus Mountains, USSR, 540
Ceará, Brazil, 381
Cell, 161–163 *passim*
Cellini, Benvenuto, 293
Cenicero, 417–419 *passim*, 428
Centenario IV, 391
Center of symmetry, 239
Ceremony of the Beetle, 95
Cesium
 channel, 171
 content, 167
 synthetic beryl, 222
Cesium beryl. *See* Alkali beryls
Ceylon (Sri Lanka)
 emerald, 49

INDEX

- Ceylon (Sri Lanka) (continued)
 localities, 507, 508
 mythical origin of gems, 65
 Chaffee Co., Colorado, 583, 584
 Chalcedony, 84, 85, 88, 95
 Channels
 ions in, 162–172 *passim*
 structural orientation, 158, 159, 160
 water in, 165–167
 Charlemagne, 100
 Charles I, 127
 Chastity, 70
 Chat mines, India, 453
 Chatham emerald
 absorption spectra, 215, 306
 description and properties, 306
 production data, 296, 304–306
 Chatoyancy, 194–196 *passim*, 330, 331. *See also*
 Cat's-eye
 Cheapside hoard, 117
 Chelsea filter, 217, 221, 320
 Chester Co., Pennsylvania, 563
 Chibcha Indian lore, 93
 Chihuahua Valley, California, 594, 596
 Chikwanda emerald, Zimbabwe, 605
 Childbirth, 78
 Chile, 407
 China
 beryl names, 11–13
 localities, 489
 lore, 13, 72
 Chita Subdivision, USSR, 513–518
 Chitny mine, Urals, USSR, 526
 Chivor, Colombia
 emerald
 absorption spectra, 212, 215
 analysis, 425
 properties, 425
 refractive index changes, 200
 geology, local, 421, 424
 geology, regional, 413
 history, 29, 30, 408–412 *passim*
 Klein's column, 421
 maps, 422, 423, 424
 mineralogy, 424, 425
 mines, 423
 origin of deposits, 421
 production data, 432
 Cholera, 78
 Chrisawn, A., 571
 Christ, engraved gem, 110, 111
 Christian lapidaries, 24
 Chromium chloride, 318
 Chromium ion
 absorption peaks, 214
 aquamarine, 216
 bazzite, 224
 blue beryl, 219
 Chromium ion (continued)
 content, 168, 169
 emerald, 53, 54, 168, 169, 172, 208–214 *passim*
 glass, 209
 green beryl, 219
 structural position, 172, 213
 Chromium oxide, 298, 299, 307, 308
 Chrysoberillus, 48
 Chrysoberyl, 10, 51, 63, 308, 350, 439, 469, 471,
 536, 537. *See also* Alexandrite
 Chrysoberyl of Pliny, 20, 615
 Chrysoberyllus, foiling, 31
 Chrysoberyllus in medicine, 79
 Chrysolite, 48, 85, 88
 Chrysolite of Brazil, 53
 Chrysolithos, 84
 Chrysoprase, 20, 50, 84, 88, 101
 Cipolin, 463, 474, 476
 Clark Extension prospect, California, 598
 Classification schemes, 32, 38, 39
 Cleavage, 184, 185, 186
 Cleft deposits, 353, 354
 Cleveland Co., North Carolina, 570
 Coahuila Mountain, California, 594
 Cobalt, 170, 172, 222
 Cobb, C.M., et al synthesis, 297
 Cobra group mines, Republic of S. Africa, 493
 Cobra Hill, Republic of S. Africa, 496, *map*
 Coclé, Panama, 21
 Coefficients
 absorption, 216
 elasticity, 186, 187
 thermal expansion, 187, 190
 Coen's Luck mine, Zimbabwe, 608
 Coëken lu, 11
 Colburn Brothers, 568
 Colic, 79
 Collins Hill, Connecticut, 558, 560
 Colombia, 13, 21, 29, 30, 407–434. *See also* Chivor
 and Muzo
 chronology, 408–413
 emerald belt, 414 *map*
 erroneous localities, 38
 geology, 413
 large emeralds, 53, 54, 426, 427, color fig. 20
 lore, 93, 94
 maps, 414, 415, 416, 422, 423, 424
 mine locations, 415t
 production, 431–434
 thefts, 433–434
 Color
 absorption, 206, 209
 curves, 215, 223
 coefficients, 216
 aquamarine group, 217–222
 bazzite, 224
 bleaching, 48, 222, 476
 causes, 48, 206

Index

- Color (continued)
centers, 220
compositional relationship, 199, 200
dichroic, 207, 208
dyes, 206, 293
emerald, 208–217
filters, 217, 221
goshenite, 217, 218, 219
heat induced, 224–227
heliodor, 221, 222
ions, 53, 209–216 *passim*
irradiation induced, 225, 226, 228–230, 555
luminescent, 231, 232
Maxixe beryl, 220
morganite, 222
Muzo emerald, 420
red beryl, 223, 224
yellow beryl, 217, 218, 219
zoning, 207–209, 286, 328, 517
- Color field test, 178, 179
Color rays in astrology, 91
Color in therapy, 74
Colorado, 581–584
Columbia mine, New Hampshire, 555
Complex pegmatite, 348, 349
Composite gems, 294, 295
Composition, 163–173
alteration, 173–175
decomposition and analysis, 175–177, 189
early determinations, 47, 50–53, 163, 164
field tests, 177–179
formulas, 172, 173
ranges, 164–172 *passim*
relationships to biaxiality, 203
relationships to density, 190
relationships to refractive indexes, 199, 200
Vauquelin's analysis, 54
Compressibility, 186, 187
Conductivity
electrical, 189
thermal, 187, 188
Confection of hyacinth, 46, 75
Connecticut, 558–561
Connelly, Stewart, 438
Conselheiro Pena area, Brazil, 395
Contagious diseases, 78
Contat, L.J., 606
Copper, 170, 172
Coptos, United Arab Republic, 19
Coral, 10, 23, 63, 75, 92
Cored crystals. *See* Shell crystals
Cornwall, United Kingdom, 549
Corporal dangers, 69, 70
Corrosion
aquamarine, 269, color fig. 9
crystal face, 244–248 *passim*, 252, 254
morganite, 270, color fig. 4
tubes, 244, 245
Cortés, Hernan, 115, 116
Cortés emeralds, 29, 102, 408, 427
Corundum, 51, 85, 90, 295, 604, 605
Coscuez, Colombia, 409, 413–419 *passim*
Cosmology, Hindu, 91, 92
Costa ben Luca, 25
Costanzi, Carlo, 110
Cota mine, California, 596
Coxe, William, 100
Crabtree emerald, North Carolina, 570, 571
Cranach, Lucas von, 222
Creuse, France, 441
Crisoberillus, 29
Crisopilon, 29
Crissopassus, 27
Crossing line pegmatites, 350
Crown jewels
Austria, 127
England, 134, 135
France, 131, 132
Germany, 127–130
Iran, 118, 120–122
Italy, 130, 131
Portugal, 134
Russia, 124, 125
Spain, 30, 132
Turkey, 121, 122
Crown of the Andes, 144, 145
Crown of Virgen del Sagrario, 132, 133, 134
Cruzeiro mine, Brazil, 395
Crystal forms. *See* Forms
Crystal-gazing, 26, 73
Crystallography, 236–276
axes and symmetry, 237–240
deformed crystals, 275
etch figures, 263–268
faces and forms, 240–258
form tables, 242, 248, 252, 253, 254
interfacial angles, 258–262, 260–261t
polygonal growth, 272
record size crystals, 275. *See also* Record-size crystals
shell crystals, 272–275
surface features, 268–272
trapiches, 262–264
twinning, 262. *See also* Twinning
x-ray data and table, 276
Crystallomancy. *See* Crystal-gazing
Crystal Mountain district, Colorado, 582
Cullinan gems, 135
Curious lore. *See* Lore
Curves of absorption, 215, 218, 223
Custer Co., South Dakota, 579, 580
Cutting. *See* Lapidary treatment
Cyclosilicates, 158
Cyprus, 48
Cythia (Scythia), 66
Czechoslovakia, 435–437

INDEX

- Dakka, United Arab Republic, 4
 Damaraland, South West Africa, 503
Damigeron, 26
Dana, Edward S., 561
 Danburite, Madagascar, 476
 Darya-i Nur, 121
 Daso, Pakistan, 488
 Dauria, 513
 Davidsonite, 548, 611
 Davila collection, 49
Davy, Humphrey, 281
 Decomposition, 175–177, 189
 Decrepitation, 185, 186, 188
 Deformed crystals, 275
 Delaware Co., Pennsylvania, 563
Democritus of Thrace, 292
 Demons and evil spirits, 71, 72
 Density. *See* Specific gravity
 Deposit types, 338–355, 340–341t
 Deshong's quarry, Pennsylvania, 563
 Desilicated pegmatites, 350, 530
 Devil, 72
 Devonshire emerald, 427
 Diadocos, diadochus, 26, 29
 Diamond
 Cullinan gems, 135
 Darya-i Nur, 121
 dispersion, 201
 Hindu lore, 10, 63, 65, 91, 92
 rank and value, 33, 47, 48
 Diamond abrasive, 325
 Diamond Fund, USSR, 112, 125, 126
 Dichroism, 207
 aquamarine, 219
 emerald, 216, 302, 306, 319, 375
 Maxixe beryl, 220
 table of colors, 208
 Dichroscope, 207, 216, 245, 328
Dickinson, William, 561
Diego Alejo de Montoya, 132
 Diffusion column, 179, 191
Di-graha yogas, 92
 Dihexagonal bipyramids, 254
 Dihexagonal prisms, 248
 Dimorphism, 203
Dionysius, 96
Dioscorides, 74
 Directions, gem lore, 90, 91
 Diseases, 78–80
 Dispersion, 201, 202t
 Displacements, ionic, 172
 Disseminated deposits, 339
 Divination, 72, 73
 Domitian emeralds, 24
Doña Juan de Zuniga, 29
 Donegal, Ireland, 456
 Donkerhuk district, South West Africa, 503, 504
 Doppie, 293
 Double refraction, 54, 196, 197
 Doublets, 293, 294
 Douro Litoral Province, Portugal, 490
Dragsted, O., cited, 80
 Dreams, 72
 Dugway, Utah, 588
Duke of Devonshire
 emerald, 427
 engraved gems, 107
Duleep Singh, 115, 427
 Dunglow, Ireland, 456
 Dunton mine, Maine, 551
 Dutch Guiana, 508
 Dyeing, 206, 293
 Dysentery, 78
 Dzierzniów, Poland

Earle, E.P., 570
Ebelman, J.J., synthesis, 295, 299
 ECOMINAS, 412
 Ecuador, 29, 438
Edinburgh Review cited, 612
 Egyptian emeralds
 deposits, 543, 544 map
 geology and mineralogy, 543, 546
 history and lore, 4–9, 61, 62, 70, 78, 80, 95, 542,
 543
 large crystals, 546, 547
 mining, 8, 547, 548
 qualities, terminology, 5, 547
 use in jewelry, 8, 9, 131
 Ehrenfriedersdorf, German Democratic Republic, 443
 Eidsvoll emerald, Norway, 487
 Eight Mile Park, Colorado, 584
 Ekaterinburg, USSR, 525, 526
 Elasticity, 186, 187
 Elba, Italy, 53, 458–461
 El can mayor, 89
 Elder Canyon, California, 594
El Dorado, 93
 Electrical properties, 189, 190
 Electromagnetic influence, lore, 74
 Elements, beryl, 164–172
Elizabeth II jewels, 134, 135
 Ellis mine, North Carolina, 567, 568
 El Molino mine, California, 597
 Eluvial deposits, 354, 355
Emelyanova, E.N., et al synthesis, 297, 321
 Emerald
 absorption spectra, 209–217, 212–213t
 curves, 215, 302, 306, 307, 317, 319, 375, 445,
 452, 489, 512, 605
 analysis. *See* Analyses
 asterism, 195
 astrological lore, 27, 89–92 *passim*
 birthstones, 87, 88

Index

Emerald (continued)

- breastplate stone, 80–86 *passim*
- carvings, 29, 30, 98–102, 108, 115–119 *passim*, 494, color fig. 21
- cat's-eye, 195
- chromium content, 53, 54, 168, 169, 172, 208–214 *passim*, 298, 299, 307, 308
- cleavage, 185
- color, 208–217
- color filters, 217
- color zoning, 207, 209, 425
- commerce, 11, 21, 29, 30
- crystal forms, 242, 244, 246, 248, 249, 252, 255, 385, 399, 419
- deposits
 - Australia, 364, 368, 369
 - Austria, 371–376
 - Bolivia, 377
 - Brazil, 384–386, 388, 389, 396
 - Bulgaria, 399
 - Colombia, 29, 407–433
 - Ecuador, 29, 438
 - Ghana, 445
 - India, 9–11, 450–454
 - Madagascar, 479
 - Norway, 487
 - Pakistan, 488, 489
 - Peru, 489
 - Republic of South Africa, 492–499
 - Tanzania, 511–513
 - United Arab Republic (Egypt), 4–9, 542–548
 - United States of America, 562, 566–568, 570, 571, 572, 590
 - USSR, 55, 525–537, 538, 540
 - Zambia, 602, 603
 - Zimbabwe, 603, 605–608
- deposit types, 340–341t, 349–351, 353, 354
- dichroism, 207, 208t, 375, 376, 452, 475, 476, 489, 512, 605
- dispersion, 202t
- domitian var., 24
- dyed, 24, 294
- engraved, inscription, 30, 95, 96, 106–115 *passim*, 118, 121, 126
- fluorescence, 224, 231, 232, 306–308 *passim*, 313, 317, 319, 320t, 321, 375, 452, 453, 489, 512, 568
- foiled gems, 31, 33
- foundation stones, 86, 87
- fusion, 50
- heat treatment, 225
- imitation, 29, 31, 292–295
- inclusions, 54, 55, 281, 285, 399, 420, 425, 489, 606, 607, color fig. 14
- infrared luminescence, 232
- irradiation, 228
- jewelry, 10–12, 16, 127, 132, 146–151, 318, color figs. 18, 20–24

Emerald (continued)

- lapidary treatment, 8–20 *passim*, 32–34, 49, 216, 217, 324–336 *passim*
- large crystals, 29, 38, 93, 296, 426, 525, 529, 530, 567, 568
- large cut gems, 114, 120–151 *passim*, 143, 144, 525, 546, color fig. 20
- lore, 13, 15, 44, 45, 61–65 *passim*, 77, 80, 89–95 *passim*, 97–102
 - medical, 37, 62, 75, 77, 79, 80, 92
- maser, 190
- naming of, 12, 611–615
- neronian var., 24
- Nero's eyeglass, 99
- Pliny's varieties, 19, 20, 615
- production data
 - Australia, 364, 369
 - Austria, 372, 373
 - Brazil, 381, 384, 396
 - Colombia, 430–433
 - India, 452–453 *passim*
 - Pakistan, 488
 - Republic of South Africa, 494, 495
 - Tanzania, 511
 - USA, 567, 568, 572
 - USSR, 529
 - Zambia, 603
 - Zimbabwe, 607, 608
- refractive index range, 198, 202, 369, 375, 376, 399, 400, 420, 425, 445, 453, 489, 497, 498, 511, 512, 533, 534, 568, 602, 605, 606, 607
- specific gravity, 50, 51, 53, 190, 191, 369, 375, 399, 400, 419, 420, 425, 445, 453, 489, 497, 498, 512, 534, 538, 568, 602, 605, 606, 607
- star, 138
- synthesis, 295–321
 - chronology, 295–298
 - properties table, 320
- tests, 31, 64
- valuation, 32–37, 38, 47–49, 54, 55
- vanadium in, 209–214 *passim*, 219, 222
- Vauquelin's analysis, 53, 54
- Emerald and Hiddenite Mine, North Carolina, 566, 567
- Emerald Buddha, 101, 102
- Emerald Goddess, 94
- Emerald of Brazil, 53
- Emerald of Texcoco, 427
- Emerald Table, 99, 100
- Emerald Valley, North Carolina, 568
- Emerald Valley, Republic of South Africa, 499
- Emerald Vernicle, 110, 111
- Emerita, 297, 316
- Emerson, Ralph Waldo, beryl tombstone, 556
- Emmaville emerald, Australia, 364
- Emmet, Robert, 109
- Endicott, J.D., 583, 584
- England, 549

INDEX

- English, George L.*, 570
 Engraved gems, 9, 15, 16, 17, 20, 27, 30, 38, 56, 106, 494
 apparatus, 56
 collections, 106–112 *passim*
 inscribed, 95, 97, 107, 112–115, 121, 126
 Shah diamond, 112
 talismans, 96, 97, 98
 Epigenetic inclusions, 282, 287
 Epilepsy, 25, 77, 78
Epiphanius, 24, 32, 84
 Epitaxy, 195, 285, 287, 331
Eppler, W.F., facet angles, 334
Eppler, W.F., synthesis, 297, 306, 307
 Erongo area, South West Africa, 503
 Erzgebirge, German Democratic Republic, 443
Eschwege, W.L.v., 378
 Escorial Library, 27
 Esmeralda dos Ferros emerald, Brazil, 396
 Esmeralda mine, California, 596, 597
 Esmeraldas nuevas, vicjas, 33
Espig, H., apparatus, 301
 Espírito Santo, Brazil, 396, 397
 Etch figures, 244, 245, 264–268, 270t, 342, color
 figs. 1, 9
 Ethiopia, 438
 Ethiopian emerald, 19
Etymologiae of Isidore 24
 Euclase, 538
Eugenie, Empress, 132
Evans, Joan, cited, 77
 Evil spirits, 71, 72
Exodus, 81, 86
 Exometamorphism, 349
 Exsolution, 287
 Eyes, eyesight, 15, 20, 29, 62, 76

Fabergé, Carl, 121, 126
 Faces, 238, 240, 242. *See also* Forms
 Facet cutting, 325, 333–336
 Fairfield, Connecticut, 561
Fallon, Thomas, 410
Farah, Empress, 117, 118
 Farm, Barbara, Republic of South Africa, 492
 Fano mine, California, 594
 Fazenda das Lages, Brazil, 389
 Fazenda Sossego emerald, Brazil, 396
 Fefena, Madagascar, 465, 474
 Felixburg field, Zimbabwe, 605
Ferdinand Maximilian Joseph, 140
 Ferrojinoso, 421
Fersman, A.E., 532, 537
 Fertility, 78
 Fevers, 78
 Fianarantsoa region, Madagascar, 479
 Fiber optics, 195
 Fichtelgebirge, Germany, 443
 Field Museum of Natural History gems, 142, 553

 Field tests, 177–179
 Filabusi emerald, Zimbabwe, 608
Fillov, A.N., 561
Finger, Michael, 568
 Fingerprint inclusions, 287
 Finistère, France, 440
 Finland, 438, 439
 First order bipyramids, 250–252t
 First order prism, 242, 246, 247
Firth, C.M., 4
 Fisher quarry, Maine, 554
 Fitzwilliam Museum, 15
 Fixed star beryl, 138, 195
 Flame fusion synthesis, 189, 295, 298
 Flame-Lily mine, Zimbabwe, 608
 Flammeus color, 89
Flanigen, E.M., et al synthesis, 317
Flavius Josephus, 83, 87
Floyer, E.A., 543
 Fluorescence, 224, 231, 308–321 *passim*, 320t, 375, 452, 453, 489, 512, 568
 Fluorescence tests, 178
 Flux-fusion synthesis, 295–313 *passim*
 Foils, 31, 33, 39, 55, 293, 294
 Foley mine, Georgia, 575
 Forêt of Burgundy, France, 53
 Forms, 238–257
 alkali beryl, 242, 256, 257, 348, 596, 597
 beryls, miscellaneous, 436, 439, 440, 441, 455, 456, 457, 459–463 *passim*, 474, 476, 478, 479, 483, 490, 491, 504, 506, 518, 524, 562, 583, 598, 599
 bipyramid, 242, 250–254
 emerald, 385, 419, 425, 532, 546, 568
 etch figure, 265, 267
 frequent and predominant, 255–257
 fundamental, 242t
 indexes and symbols, 243
 letters, 237, 242 ff.
 pinacoid, 242, 243–245
 prism, 238, 241, 242, 246–250
 synthetic emerald, 302, 306, 308, 309
 Formulas, 160, 162, 172, 173
 Fortaleza aquamarine, Brazil, 392
 Fossils, 23, 34
 Foundation stones, 24, 86
 Fracture, 184, 186, 419, 469
 France, 439–442
Francis I, 102
Franz Josef, 127
Fraser, Lovat, 570
 Fremont Co., Colorado, 584
 French Guiana, 442
 French Morocco, 482
Freyra, 89
Frondele, C., and *J. Ito* bazzite synthesis, 321
Fühner, H., 74
 Fusion, 47, 49, 50, 176, 177, 189

Index

- Gachalá, Colombia, 412, 422, 426, 427, 433
Gachalá emerald crystal, 140
Galílea, Brazil, 395
Gall bladder, 79
Gamma rays, 228
Ganguli, D., and *P. Saha* synthesis, 297, 298
Garci-Perez, 27
Garden, 285, 419
Garimpeiros, 389
Garnet, 10, 83, 85
Garura, 65
Gas, stomach, 79
Gebel Sikait, United Arab Republic, 19, 543, 544
 map, 546, 547
Gebel Zabara, United Arab Republic, 543, 547
Gemelo, 262
Gemini, 70, 88, 89, 97
Genetic deposits, 340–341
Genoa, 100
Gentile, A.L., et al synthesis, 297, 298
Geological Museum (London), 137
George III, 71
Georgia, USA, 574–576
Germania Hills (Koppies), Republic of South Africa, 493, 496
German Democratic Republic, 442, 443
German imperial crown, 130
Germany, 443–444
Gesner, Conrad, 32, 378
Ghana, 445
Giant crystals. *See* Record-size crystals
Giesecke, Charles, 485
Gillette quarry, Connecticut, 560
Gilson, Pierre, synthesis, 215, 296, 297, 308–313
Girdlestone, C., 605
Glass
 beryl melt, 189, 299
 Cr-doped, 209
 crystal-gazing spheres, 73
 formulas, 294
 imitation gem, 31, 49, 292–295
 Sacra Catina, 100
 Tabula Smaragdina, 99
Globe of the World, 115
Glossary, beryl terms, 616–624
Glucina, glucinum, 53, 163
Goddess of Emeralds, 427
Goiás, Brazil, 386, 389
Golconda mine, Brazil, 395
Gold, 75, 76, 91, 92, 96, 98, 99
Golden beryl, 13, 48
 cat's-eye, 194, 465, 478, 479
 heliodor, 221, 222, 505, 506
 largest gem, 141, color fig. 15
 patriotic wear, 90
 snuff-bottles, 119
Goniometer, 258
Goodhouse area, Republic of South Africa, 491
Goshen, Massachusetts, 558
Goshenite, 3, 218, 558, 564, 611. *See also* Alkali beryls
Gotta-Walden quarry, Connecticut, 560
Governador Valadares, Brazil, 395
Graeco-Roman gems, 13, 15, 16
Grafton, New Hampshire, 555
Granitic pegmatites, 338, 342–349
Graphic granite, 342
Graubünden, Switzerland, 510
Gravelotte district, Republic of South Africa, 492, 495, 498, 499
Great Globe, 121
Great Mogul emerald, 118, 119
Greek and Etruscan engraved gems, 15, 16
Greek lore, 61–62, 69
Greenland, 445
Green Vaults, 127
Gregory XIII, 130
Greisens, 351–353
Grijalva, Juan de, 408
Grosse Spitzkopje, South West Africa, 504
Grotta d'Oggi, Elba, Italy, 458, 459
Groton Township, New Hampshire, 555
Growth accessories, 271, 272
Grüne Gewölbe, 127
Guarruceros, 417
Guatavita Lagoon, 93, 408
Gum Gurha mines, India, 451, 453
Gunnison Co., Colorado, 584

Habachtal emerald, Austria
 absorption spectra, 211, 215
 geology and mineralogy, 373, 375, 376
 history, 371–373
 inclusions, 281, 288, 289, 376
 optical and physical properties, 202, 375, 376
Habits, 242–259 *passim*, 302, 306, 309
Haddam Neck, Connecticut, 560
Hagendorf, Germany, 444
Hale quarry, Connecticut, 560
Hale-Walker quarry, Connecticut, 560
Hamachal Pradesh, India, 446
Hambegite, Madagascar, 476
Han period, 12
Hapsburg jewels, 127
Harding mine, New Mexico, 586
Hardness, 186
Harpy, 80
Hartford Co., Connecticut, 559
Harun-al-Rashid, 116
Haryana, India, 446
Haschmi, M.Y., cited, 613
Hautefeuille, P.G., and *A.J.E. Perrey* synthesis, 295, 296, 299, 300
Haute-Garonne, France, 441
Haute-Loire, France, 441
Haute-Pyrénées, France, 441

INDEX

- Haute-Savoie, France, 441
 Haute Vienne, France, 441
 Häüy, R.J., 51, 52
 Hazara, Pakistan, 489
 Hazel W. mine, California
 Head and neck disorders, 80
 Healing of crystal fissures, 282, 287
 Heart disease, 80
 Heart talisman, 61, 62
 Heat treatment, 48, 224–228, 264, 293, 469
 Helicon, South West Africa, 503
 Heliodor, 221, 222, 506. *See also* Golden beryl
 Helium, 170, 370
 Hematite, 85
 Hemet, California, 594
 Hemorrhoids, 79
 Henkries area, Republic of South Africa, 491
 Henry IV engraved gem, 109
 Hercules mine, California, 598, 599
 Hermann-Mauguin notation, 159
 Hermes Trismegetus, 78, 79, 99
 Herod, 100
 Herodotus, 97, 98
 Hiccoughs, 79
 Hidden, William R., 566, 567
 Hiddenite, 566–570 *passim*
 High Priest's breastplate, 39, 81–86
 Hildegard von Bingen, cited, 79
 Hill, John, cited, 611
 Hillocks, 268, 271, 272
 Himalaya mine, California, 596, 597
 Hiriart Hill, California, 597
 Hitchen, C.S., synthesis, 296
 Hogg mine, Georgia, 575
 Hollow crystals. *See* Shell crystals.
 Holohedral, holosymmetric class, 239
 Holy Grail, 100
 Holy Roman Empire jewels, 127
 Hong Kong, 489
 Hooker emerald, 140, color fig. 20
 Hope diamond, 138
 Hope, H.P. gems, 107, 108, 137–140, 142
 Hoppeskaya Gora, USSR, 517
 Howe quarries, Connecticut, 559
 Humdigams, South West Africa, 501
 Hunza, Pakistan, 488
 Hyacinth confection, 46, 75
 Hyacinthozontes, 20, 615
 Hyatt Ranch, Colorado, 582
 Hydrofluoric acid, 175, 268
 Hydromancy, 26, 72, 73
 Hydrothermal alteration, 352
 Hydrothermal deposits, 353
 Hydrothermal synthesis, 313, 316–321
 Hydroxyl, 172
- Ib-Badja*, 79
 Ibity, Madagascar, 476, 477 *map*
- Ibn-Massouih*, 79
Ibnu'l Baitar, 77
 Idaho, 21, 550, 586, 587
 Igmerald, 296, 300
 I.G. Farbenindustrie emerald, 300–302
 Ilha Alegre, Brazil, 392
 Ilmen Mountains, USSR, 537
 Imitation gems, 31, 39, 49, 292–295
 Immersion fluids, 328, 329
 Imperial Crown of England, 134
Imperial Dictionary of Four Languages, 12
 Inclusions, 280–290
 cat's-eye, 194, 195, 330, 465, 478, 479, color
 fig. 13
 early notices of, 20, 31, 39, 49, 54, 55, 280, 281
 effects of, in cut gems, 329, 330
 fingerprint, 287
 flux-fusion, 307
 ghost, 245
 liquid, 164, 281
 natural examples, 376, 420, 425, 481, 512, 533,
 606, 607, 608
 origin, 281
 Pliny's descripton, 281
 productive of phenomena, 194–196
 related to biaxiality, 203
 related to cleavage, 185
 shell crystal, 273, 274
 simulated in glass, 292
 solid, 287–290, 288–289†
 star, 331
 synthetic emerald, 302, 303, 306, 313, 317, 321
 trapiche, 263
 zoning, 296, 481, 517
 Indentation hardness, 186
 India
 astrological lore, 90–93
 early knowledge, 3, 9, 11
 emerald, 445, 446, 450–454
 emerald terms, 63, 64
 jewelry, 9–11, 12, 63, 64, color fig. 21
 localities, 445–454
 lore, 63–65, 446
 medical lore, 64, 74, 91, 92
India, Francesco, 74, 75
 Indigo dye, 293
 Indre, France, 440
 Infrared absorption, 224
 Infrared luminescence, 232
 Inner Mongolia, 455
Innocent XI, 17
 Inro, 120
 Inscribed gems, 95, 97, 107, 112–115, 121, 126
 Insomnia, 80
Instruction of Ptah-Hotep, 4
 Intaglios. *See* Engraved gems
 Intercourse, 70
 Interfacial angles, 258, 259, 260–261†

Index

- Interior angles, 259
Inverness Shire, Scotland, 548
Inyo Co., California, 594
Iranian royal treasures, 115, 117, 118
Ireland, 456
Ireland claims, Zimbabwe, 608
Irish Creek, Virginia, 564
Irkutsk-Sayan, USSR, 518
Iron
 coloring ion, 54, 214, 218, 219t, 220
 content, 164, 168
 lore, 73
 role in heat treatment, 225, 226, 227
 role in irradiation, 229
 structural position, 172
Irradiation, 225, 226, 228–230, 555
Isaac Lea Collection, 141
Isère, France, 441
Isidore of Seville, 24, 26, 66
Isis, 69, 95
Isle of Man, United Kingdom, 549
Israeli tribes, 86
István Bocskay, 127
Itabira area, Brazil, 395
Italian treasures, 130, 131
Italy, 456–459
Itongafeno, Madagascar, 474
Iveland district, Norway, 486
Ivory Coast, 462
- Jackalswater area, Republic of South Africa, 491
Jacobina, Brazil, 386
Jacob's Well, 127, 128
Jacumba area, California, 599, 600
Jade, 13, 83, 86, 102
Jaeger, M., and *H. Espig* synthesis, 296, 300–302
Japan, 3, 11, 13, 462, 463
Jaqueto aquamarine crystal, Brazil, 388, color fig. 17
Jardin, 286, 329, 419
Jargoon, 75
Jasper, 62, 82, 83, 84, 86, 99
Jathara, 64
Jeaune d'Evreux, 131
Jebel Sikait, Jebel Zabara. *See* Gebel S., Gebel Z.
Jefferson Co., Colorado, 582
Jehangir 113, 115
Jequinhonha, Brazil, 392, 393
Jet, 23
Jewellery Cave, Australia, 366
Jewels and jewelry
 beryl, 40, color figs. 10, 13, 15, 18–24
 birthstone, 87–90
 Canada, 142, 143
 Chatham crystal, 305, 312
 early types, 4, 8, 9, 11, 12, 15, 16
 Egyptian, 8, 9
 emerald, 30, 32, 33, 35, 36, 49, color figs. 18, 20–24
 England, 134–140
 engraved, inscribed gem, 106–110, 111, 112, 113
 French, 131, 132
 German, 127–130
 Hope Collection, 137–140
 India, 11, 63, 90, 91, 110, 111, 113, 114, 115, color fig. 21
 Iran, 120, 121, 122
 Italy, 130, 131
 Linde emerald, 318
 magical, 61, 63, 95–97
 modern, 146–151, color figs. 18, 19, 23
 Russia, 124–127
 South America, 144–146
 Spain, 132–134
 Turkey, 121–124
 United States, 140–142, 143, 144, color figs. 18–24
 Jiqua, 121, 122
 Jiménez de Quesada, 29
 Johanngeorgenstadt, German Democratic Republic, 443
 John the Evangelist, 86
 Josephus, 83, 87
 Juab Co., Utah, 588
 Juan de Mariana, 29, 116
 Julia, engraved gem, 108
 Julius II, 130, 546
 Julius Caesar, engraved gem, 109
 Junot, Andoche, 132, 134
 Jupiter, 89, 92
- Kafubu emerald, Zambia, 602, 603
Kaiser Leopold I engraved gem, 111–112
Kakamas area, Republic of South Africa, 491, 492
Kalahari Desert emerald, Republic of South Africa, 499
Kaliguman area, India, 450, 453, 454
Kara-Kara, 63
Karelia, Finland, 439
Karibib, South West Africa, 501, 503
Karma puraná, 91
Kashmir, India, 446
Katanga Province, Zaire, 601
Katerina mine, California, 597
Kazakh ASSR (Kazakhstan), USSR, 518, 519
Kenya, 463, 464
Keora water, 79, 80
Kerala, India, 450
Ketu, 91
Kidney disease, 79
Killinite, 456
King, C.W., 65–67, 612, 614
Kingdom of Caliphs, 13
King Juba, 19
King of Hungary, 70
Kircher, A., 87
Kivu Province, Zaire, 601

INDEX

- Klein, Fritz*
 Brazil travels, 390
 Chivor column, 421
 Colombian mining, 410, 411, 425
 Patrizius emerald, 427
- Kleine Spitzkopje, South West Africa, 504, 505, color fig. 8
- Kobokobo mine, Zaire, 601
- Kochkar-Sanarka region, USSR, 537, 538
- Koh-i-Nur, 115
- Kola Peninsula, USSR, 538
- Königshain, German Democratic Republic, 442
- Konitomi, M.*, and *H. Saito* synthesis, 297
- Kopparberg, Sweden, 509
- Koran*, 78
- Kornilova, Urals, USSR, 521
- Kosseir, United Arab Republic, 542
- Kranzberg, South West Africa, 501
- Krasnobolotsky mine, Urals, USSR, 526, 535
- Krasnoyarsk-Yenesei Mountains, USSR, 518
- Krestovik mine, Urals, USSR, 525
- Kulgee, 115
- Kunitomi, M.* and *Y. Arino* synthesis patents, 298
- Kunsthistorische Museum, Vienna, 111, 116, 127
- Kunzite, 474, 476, 594, 597
- Kyanides*, 96
- Labrador, 400
- Lac Alaotra region, Madagascar, 469
- Lac Itasy region, Madagascar, 471, 472
- Lackey, J.O.*, 566, 567
- La Grange, Georgia, 575, 576
- Lahore treasury gems, 114, 115
- Lake Guatavita, *see* Guatavita Lagoon
- Lake Manyara emerald, Tanzania, 511-513
- La Lechuga monstrose, 145, 146
- Lamprey eel, 80
- Lanchero, Luis*, 408
- Lapidaries, 23, 24-27
- Lapidarium of Marbodus*, 66-67
- Lapidary treatment
 abrasives, 55, 325, 326
 cabochons, 331, 332
 carvings, 332
 cutting styles, 32-37 *passim*, 305, 312, 314, 315, 325, 335, 336
 early techniques, 20, 30-34 *passim*, 55, 56, 106
 emerald cut, 332, 333
 facet gem angles, 333-335, 335t
 gemstones features, 327t
 historical review, 324-326
 inclusions, 329-331
 immersion fluids, 328, 329
 parabolic cut, 335, 336
 polishing, 55, 336
 rough orientation, 216, 217, 327, 328, 329
- Lapis lazuli, 72, 74, 95, 97
- Laranjeiras, Brazil, 392, 395
- Larimer Co., Colorado, 582
- La spica turginis, 89
- Latah Co., Idaho, 587
- Laufer, B.*, 613
- Lausitz region, German Democratic Republic, 442
- Laue, Max v.*, 57
- Lava flux, 309
- Leaf gold, 75
- Lechleitner, J.*, emerald, 215, 297, 316, 317
- Lefever, R.A.*, et al synthesis, 297, 307, 308
- Leo, 89
- Leonardo da Vinci*, 110
- Leprosy, 78
- Leshem, 81
- Leucoderma, 79
- Lévy, B.* Muzo rock analysis, 417
- Leysdorp emerald, Republic of South Africa, 209, 492, 493
- L'Hote, N.*, 543
- Libra, 88, 89
- Limoges, France, 441
- Limoniatis, 19, 615
- Linares, R.C.*, et al synthesis, 297, 307
- Linde emerald, 215, 297, 317-319, 321
- Lipovska, Urals, USSR, 521
- Liquid inclusions. *See* Inclusions
- Litchfield Co., Connecticut, 560, 561
- Lithium, 167, 168, 172, 222
- Little Switzerland Emerald Mines, Inc., 571
- Little Three mine, California, 598, 599
- Liver diseases, 79
- Livio, Duke of Bracciano*, 17
- Localities, 357-609
- Loire Atlantique, France, 440
- Loire, France, 441
- Lombardy, Italy, 457
- Lone Hand mine group, Republic of South Africa, 493, 498
- Lonicer, A.*, 78, 79
- Lonso Luis (Luiz Alfonso de Lugo)*, 408
- Lord Auckland*, 113
- Lord Rayleigh*, 370
- Lore, 60-102
 amuletic and talismanic, 4, 9, 23, 61, 62, 65, 67, 77, 78, 95, 96, 97, 106
 Arabic, 74, 77, 79
 astrologic, 27, 60, 61, 64, 69, 87-93 *passim*
 Biblical, 24, 37, 39, 79, 81-86, 88, 89
 birthstone, 84, 85, 87-97 *passim*
 demonic, 71, 72
 divination and dreams, 26, 72, 73
 Egyptian and Greek, 61, 62
 European, 65-67
 Indian, 9, 63, 64, 74, 91, 92, 446
 Marbod's poem, 66, 67
 medicinal and therapeutic, 44, 46, 64, 73-80
 personal, 67-69
 South American, 93, 94, 408, 427

Index

- Los Angeles County Museum, 142
Louvre collections, 131, 132
Love and marriage, 70
Lubinskaya mine, Urals, USSR, 525, 535
Lucia aquamarine, 391
Lucretius, 155
Luminescence, 231, 232, *See also* Fluorescence
Lundy Island, United Kingdom, 549
Luster, 194
Lyndoch, Ontario, 402, 403
Lyons emerald, 101
- Mack mine, California, 249, 598, 599
Madagascar, 463–480
Madhyama, 92
Madhya Pradesh, India, 448
Mafek and related terms, 4, 611
Magdeburg emerald, 101
Magmatic deposits, 339–349
Magnesium, 167, 168, 172
Magnetism, 190
Mahabharata, India, 446
Maharitra, Madagascar, 476, 477
Maine, 142, 143, 551–554
Makrisi, Maqrizi, 546
Malachite, 83, 84
Malagasy Republic, 463–480
Malaria, 78
Malawi, 480
Malaya, 13
Maldonado de Mendoza, Francisco, 409
Mampong, Ghana, 445
Manandona River, Madagascar, 477
Mananjary emerald, Madagascar, 479
Mananjary-Ifanadiania region, Madagascar, 479
Mancheho, Alonso Ramirez Gasco, 409
Mandeville cited, 67–72 *passim*, 76, 79
Mandoto-Antsirabe region, Madagascar, 473
Mandrarivo area, Madagascar, 475
Manganese, 168, 219, 222
Mangualde, Portugal, 490, 491
Manhattan Island, 562
Maniema, Zaire, 601
Máni Málá necklace, 10
Manitoba, 403, 404
Manono pegmatite, Zaire, 601
Manta, Peru, 38, 93
Manyara emerald, Tanzania, 511–513
Marakata and related terms, 12, 611
Marambainha (Marambaia), Brazil, 390, 391
Marat, Joachim, 138
Marbod cited, 65–67, 68–72 *passim*, 76, 78, 80
Mar-gad, 12
Maria Anna of Austria, 134
Maria Theresa emeralds, 127, 371
Marie-Louise of Austria, 127, 131
Marijao, Madagascar, 465, 471
Marinsky mines, Urals, USSR, 525, 526, 533, 534
Markat, 12
Marriage, 70
Mars, 92
Marta Rocha, 391
Maryland, 563
Maser, 190
Mashakalai, 64
Masora, 85, 86
Massachusetts, 557, 558
Masudi, 546, 547
Mathew, 86
Matsuo, T., and *S. Marusato* synthesis, 298
Mawe, John, 378
Maximilian emerald, 140
Maxixe beryl, 218
 absorption spectrum, 221, 223
 color center, 220
 dichroism, 208, 220, 221
 irradiation, 229, 230
 locality, 393
 properties, 220, 221
Mayfield Farm emerald, Zimbabwe, 605
Mazoe field, Zimbabwe, 603
Medicinal gemstones
 criticisms, 44, 46, 74, 75
 emerald and beryl, 9, 27, 37, 73–80
 lore, 63, 64, 74
 preparations, 75, 76, 79
 substitutes, 75
Medusa engraved emerald, 106
Mehemet Ali, 542
Melancholia, 80
Melon cut, 117, 121
Melting, 48, 189, 298, 299
Menge, I.N., 537
Mercury (planet), 89–92 *passim*
Meridional emerald, 35
Merryall mine, Connecticut, 560, 561
Mesa Grande district, California, 596, 597
Metamorphic-hydrothermal deposits, 349–351
Metropolitan Museum of Art gems, 109
Mexico, 21, 29, 480, 481
Miami Mica field, Zimbabwe, 603
Mirolitic deposits, 339, 342
Miass, USSR, 55, 537
Micanite district, Colorado, 584
Mica schist, 349–351 *passim*
Middlesex Co., Connecticut, 559, 560
Middletown area, Connecticut, 558, 559
Miku emerald, Zambia, 602, 603
Miller, I.W., 566
Miller, R.P., and *R.A. Mercer* beryl melts, 298, 299
Miller, W.H., 243
Millionaya vein, USSR, 517
Minas Gerais, Brazil, 389–396
Minas Novas, Lufa, Capelinha area, Brazil, 395
Mineral assemblages table, 468
Minerals Processing mine, Georgia, 575

INDEX

- Mingaora emerald, Pakistan, 488, 489
 Minho, Portugal, 490
 Mirror planes, 239
Miseroni, Dionysio, 116, 371, 427
 Missouri, 577
 Mitchell Co., North Carolina, 570–572
 Mogul jewelry, 12, 13, 112, 113, 114, 118, color figs. 21, 24
Mohammed ibn Ishak el-Washcha, 97
 Mohs scale, 186
 Monetnaya Dacha, Urals, USSR, 525
 Mongolian Republic, 481, 482
 Montana, 580, 581
Montezuma, 29
 Monumental smaragdi, 19, 98
 Moon, 92
 Moonstone, 92
 Moralla, 419, 431, 432
 Moravia, Czechoslovakia, 437
 Morbihan, France, 440
 Morganite. *See also* Alkali beryls
 carved, 119, 465
 color, 222
 crystal features, 242–247 *passim*, 255, 256, 257, 596, color fig. 14
 faceted gems, 137, 143, 465, 597, color figs. 10, 12
 fluorescence, 231
 heat treatment, 228
 major sources, 391, 476, 524, 551, 560
 name, 611, 615
 vorobeyevite, 514
 Morin, 178
 Morocco, 482
 Mother-of-emerald, 5, 542
Motoo S., et al synthesis, 297
 Mount Antero, Colorado, 343, 583
 Mount Apatite, Maine, 553
 Mount Bity, Madagascar, 476, 477 *map*
 Mount Mica, Maine, 553
 Mountain of Green Jewels, 371
 Mourne Mountains, Northern Ireland, 485
 Mozambique, 482–484, 483 *map*
 Mtoko field, Zimbabwe, 603
 Muiâne, Mozambique, 275, 482
Mullet, C., 613
 Murchison Range, Republic of South Africa, 493, 495, 498, 499
Muriel, 89
 Mursinka, Urals, USSR, 519, 521, 524
Musca, 99
 Muscovy glass, 343
 Museum Odeschalum, 17
Mussi, David, 390
 Mustard mine, Zimbabwe, 608
 Muzo-Coscuez, Colombia
 emerald
 absorption spectra, 212, 215
 analyses, 53, 54, 163, 164, 168, 209, 419
 Muzo-Coscuez, Colombia (continued)
 cleavage, 185, 186, 419, 420
 crystal forms, 255, 419, color fig. 16
 etch figures, 265, 267
 grading, 430
 inclusions, 49, 285, 287, 288, 420
 properties, 419, 420
 trapiche, 262–264 *passim*, 419
 geology, local, 413, 416, 419
 geology, regional, 413
 history, 21, 29, 30, 49, 408–412 *passim*
 lore, 93, 94
 maps, 414, 415
 mineralogy, 419–421
 mines, 21, 413, 415, 416
 origin of deposits, 421
 production, 430, 431
 rock analysis, 417
 Mysore, India, 449

Nacken, R., synthesis, 296, 302, 303, 304, 316
Nadir Shah, 115, 122
 Nagelsteen, 84, 85
 Nailhead inclusions, 303
 Nail-stone, 85
 Namaqualand, Republic of South Africa, 491, 492
 Names of emerald and beryl, 4, 12, 13, 19, 32–41
 passim, 48, 49, 62–64 *passim*, 80–86 *passim*, 611–624
 Namibia (South West Africa), 501–506
 Namivo mine, Mozambique, 275
 Nantes, France, 440
 Nao-ratan, nava-ratna, 9, 63, 90
Napoleon, 130, 131, 132
 Narwhal tusk, 37
 National Museum of Naples, 16, 20
 National Museum of Natural History collection, 140, 141, color figs. 10, 13, 15, 20–22, 24
Nawab of Dacca, 113
 Negative crystals, 286
 Nemocón, Colombia, 426
 Nepal, 485
 Nephrite, 84, 86
 Nerchinsk, USSR, 55, 515
Neri, Antonio, 294
Nero, 62, 66, 99
 Neronian emerald, 24
 Netsuke, 120
 Nevada, 590, 591
 New Brunswick, Canada, 400, 401
 New emeralds, 33, 35
 Newfoundland, 400
 New Granada, 29
 New Guinea, 485
 New Hampshire, 555, 556
 New Hope mine group, Republic of South Africa, 493, 498
 New Jersey, 562

Index

- New Jerusalem, 24, 86
New Mexico, 585–587
New South Wales, 363–365
New World emerald, 21, 29, 30
New York, 562
New Zealand, 366
Nicholas II, 132, 144
Nickel, 170, 172
Nigeria, 485
Niowarimbu wehe, 12
Nitrogen oxide, 220
Noble gases, 170
Nomenclature of beryl, 616–624
Nophak, 81, 83, 84, 85
Nordland, Norway, 486
Normal class, 239
North Carolina, 21, 143, 550, 565–572
Northern Ireland, 485, 486
Northern Territory, Australia, 366
North-West Frontier Province, Pakistan, 488, 489
Northwest Territories, Canada, 404, 405, 406
Norway, 486, 487
Nova Scotia, 401
Novello prospect, Zimbabwe, 605 *map*, 606
Nuristan, Afghanistan, 359, 360
- Obelisk of Zeus, 98
Oberpfalzer Wald, Germany, 443
Occidental appellation, 38
Occidental aquamarine, 53
Occidental emerald, 32, 35, 37, 50
Occult properties. *See* Lore
Ocean View claim, California, 597
Odem, 81
Odzi field, Zimbabwe, 604
Oiling of stones, 293
Old emeralds, 33
Olivine (peridot), 4, 51, 88
Omararu area, South West Africa, 501, 503
Onon-Borzinskaya Mountains, USSR, 516–518
Ontario, 402, 403, 404
Onychion, 84, 86
Onyx, 84, 85, 86, 88
Oosthuizen, C.J., 606
Oosthuizen, J.H., 608
Opal, 88, 232
Optical anomalies, 201–204
Optical sign, 197
Oracular use of beryl, 72
Oratorium of Charlemagne, 108
Order of St. George jewels, 130
Ore beryl production
 Argentina, 361
 Australia, 363, 365, 367, 368, 369, 370
 Brazil, 381, 383
 Canada, 402
 Hong Kong, 489
 India, 446, 448
 Kenya, 463
 Madagascar, 467, 469, 471, 472, 476, 479
 Morocco, 482
 Mozambique, 484
 Republic of S. Africa, 491, 499
 Somali Republic, 501
 South West Africa, 501
 United States of America, 560, 576, 577, 582, 584, 586, 592
 Zaire, 601
 Zambia, 602
 Zimbabwe, 603, 605
Oriental appellation, 38, 39, 41
Oriental aquamarine, 53
Oriental emerald, 32, 33, 37, 48, 50, 85, 236
Oriental topaz, 13
Orientation of rough, 327–330 *passim*
Orissa, India, 449
Orne, France, 440
Oroetes, 98
Orthoclase, 469
Orthorhombic structure, 203
Osborne-Lackey place, North Carolina, 567
Oscillatory combination, 271
Østfold, Norway, 487
Ostrovsky mine, Urals, USSR, 526, 535
Over, Edwin, 589
Oxford Co., Maine, 551–553
Oxygen, 171
- Padparadschah, 92
Pakistan (West), 488
Pala Chief mine, California, 597
Pala district, California, 595, 597
Palermo quarry, New Hampshire, 555
Pallas, P.S., 50
Panama, 21
Papamel aquamarine, Brazil, 393
Parabolic cut, 335, 336
Paraíba, Brazil, 382, 383
Paraná, Brazil, 397
Paris, José Ignacio, 410
Parasite, 420
Park Co., Colorado, 582, 583
Paste, 294
Patricia, Patrizius emerald, 141, 142, 427
Patriotic wear of beryl, 90
Pausanias, 98
Pearl, 10, 15, 23, 37, 63, 65, 74, 75, 86, 88, 91, 92
Pearse emerald, 116
Pedrarias (Pedro Arias de Avila), 29, 408
Pedro II, 116
Peerless mine, South Dakota, 579
Pegmatite mineral assemblages, Madagascar, 467, 468
Pegmatites, 338, 342–349
Pegmatite Valley, Republic of South Africa, 491, 492
Pegu (Burma), 49

INDEX

- Penagos, Juan de*, 408
 Peninsular Ranges, California, 594
 Pennington Co., South Dakota, 579
 Pennsylvania, 562, 563
 Peoples Republic of China, 489
 Pepper mine, Zimbabwe, 608
 Peridot, 48, 51
 Peridot of Brazil, 50
 Pernambuco, Brazil, 383
 Persian inscriptions, 95, 113, 126
 Persian lore, 71, 77, 78, 79
 Personal traits, 67-69
 Peru, 489
 Peruvian emerald, 37, 38, 49
 Pervomaysky mine, Urals, USSR, 529
 Petalite, 605
Peter the Great, 126
Pharmacopeia Augustana, 75
 Pharmaceutical preparations, 73, 75
 Phenakite, 373, 504, 505, 535, 536
 Philippines, 13, 30
 Piedmont, Italy, 457
 Pinacoid, 242, 243, 244, 245, 270
Piper, Warren J., 144
 Pisek, Czechoslovakia, 436
 Pitdah, 81
Pius VI, 131
Pizarro, Francisco, 408
 Planalto do Borborema, Brazil, 381
 Planes of symmetry, 239, 240
 Planetary influences, 87, 90-93 *passim*
 Plasma, 8, 15, 86
 Platinum, 89
 Playter mine, New Hampshire, 555
 Pleystein-Hagendorf, Germany, 444
Pliny, citations
 artificial coloration, 293
 inclusions in emerald, 280, 281
 names of beryls, 612, 615t
 Nero's eyeglass, 62
 Scythian emerald, 525
 Plumbago Mountain, Maine, 551
 Pneumatolysis, 352
 Poisons and venomous bites, 77
 Poland, 490
 Polaroid, 207
 Polishing gems. *See* Lapidary treatment
 Pollucite, 560
Polycrates' ring, 97, 98
 Polygonal texture, 203, 204, 272
 Pompeian jewelry, 20
 Poona, Australia, 368-370
Pope Alexander VI, 110
Pope Benedict gem, 110
Pope Innocent VIII, 110
Pope Innocent XI, 17
 Popoyán, Colombia, 144
 Portugal, 490, 491
Poseidon, 69, 97
Post, M.M., gems, 140
 Potassic pegmatites, 467
 Potassium, 167, 168, 171
Pott, J.H., fusions, 47
 Powhatan Co., Virginia, 564
 Prasiolite, 39
Pratt, Lillian Thomas, collection, 126, 127
 Pratt quarry, Connecticut, 560
 Pravoshilkinski Khrebet, USSR, 514
 Praxini, 130
 Precious Stones Trust, USSR, 526, 529
 Predominance of forms, 255-257
 Pregnancy, childbirth, fertility, 78
 Prime d'éméraude, 542
 Prisms
 dihexagonal, 248-250, 248t
 etch marks, 244, 270
 interfacial angles, 260, 261
 orders, 242-250 *passim*
 Production data. *See* Emerald production data; Ore
 beryl production
 Promontory of Helen, 38
 Protogenetic inclusions, 282-284
Psellus, 76, 78
 Pseudosmaragd, 174
 Pseudomorphs, 174
Ptah-Hotep, 4, 542
Ptolemy, 445
 Punjab, India, 11
Puranás, 63, 64, 91
 Pusparaga, 92
 Puy-de-Dôme, France, 441
 Pyrénées Orientales, France
Pyrgoteles, 20
 Pyroelectricity, 49, 54, 190
 Pyrope, 50

 Qift, 19
 Quartain fever, 78
 Quartz Creek district, Colorado, 584
 Quebec, 401, 402
 Queensland, 363
Queen of Sheba, 100
Queen Victoria, 134
Quesada, Gonzalo Jiménez de, 29, 30, 408
 Quinalizarin, 178, 179
 Quinsy, 80
 Quintessa jewelry, 318
 Quseir, 452
Qusta ibn Luqa, 25

Rabanus Maurus, 71
 Radioactivity in heliodor, 222
 Radium fluorescence, 231
 Radium irradiation, 228
Ragiel, 97
Ráhu, 91

Index

- Rainier, Peter W.*, 412
Rajasthan, India, 11, 446
Rajgarh mines, India, 451, 453, 454
Raman effect, 224
Ramona district, California, 595, 598, 599
Ranjit Singh, 115, 134
Record-size crystals
 alexandrite, 536
 aquamarine, 386, 388, 390, 391, 392, 471, 521,
 553, color fig. 17
 emerald, 124, 140–143 *passim*, 296, 372, 396, 426,
 427, 498, 529, 530, 546, 547, 567, 568
 golden beryl, 404
 morganite, 391, 476, 483, 484, 551
 ore beryl, 275, 383, 479, 483, 491, 507, 551, 555,
 556, 577, 579, 583
Red beryl, 166, 208, 223, 224, 586–589 *passim*, color
 fig. 2
Red Mountain, California, 595
Red Sea, 19
Refractive index, 196–204. *See also* Alkali beryls;
 Aquamarine; Emerald
 alkalis influencing, 199, 200
 anomalies, 201–204
 bazzite, 199, 519
 beryl ranges, 197, 198t
 common gemstones, 197t
 dispersion, 201, 202t
 double refraction, 54, 196
 versus color, 200
 versus facet gem angles, 334, 335
 versus temperature, 201
 versus wavelengths, 201
Reichenau Abbey emerald, 100
Reichenbach, Poland, 490
Republic of South Africa, 491–499
Residenz Museum collection, Munich, 129, 130
Restrepo, Francisco, 410, 411
Revelation, 86
Reynolds mine, New Hampshire, 555
Rhode Island, 558
Rhodesia. *See* Zimbabwe
Rhodizite, 479
Riebling, E.F., and *D.A. Duke* beryl glasses, 299
Riera, J.F., synthesis, 296
Rig-Veda, 9
Rila emerald, Bulgaria, 399
Rincon district, California, 249, 595, 597, 598
Ring structure, 157, 158
Rio Arriba Co., New Mexico, 586
Rio de Janeiro, Brazil, 397
Rio Grande do Norte, Brazil, 381–383
Rio Tinto (Rhodesia) Ltd., 606
Rist, C.G., 568
Riverside Co., California, 594, 595, color fig. 1
Rock crystal, 10, 15, 26
Rockefeller, Nelson A., necklace, 148
Roebing quarry, Connecticut, 550, 560, 561
Roedder, E., 281
Rollstone Hill quarry, Massachusetts, 557
Roman jewelry and gems, 20
Romania, 500
Romé de Lisle, 49, 50
Röntgen, W.K., 57
Roosevelt, F.D., aquamarine, 144, 392
Rorison, J.L., 570
Rose Quartz mine, South Dakota, 579
Rose water, 79, 80
Rosicrucian lore, 77
Rössing, South West Africa, 505, 506
Rosterite, 459
Rowland, Dr., cited, 79
Royal fifth, 409
Royal Ontario Museum collection, 142, 143
Royalston quarry, Massachusetts, 557
Rubellite, 465, 475, 476–482 *passim*
Rubicon, South West Africa, 503
Rubidium, 167, 168, 171
Ruby, 10, 12, 13, 33, 41, 50, 63, 75, 84, 89, 91, 92
Rudolf II, 38
Rueus, Franciscus, 32, 77
Rukshma, 63, 80
Russian (tsarist) jewels, 124, 125
Rutherford mines, Virginia, 564
Rwanda-Burundi, 500
Rye Patch, Nevada, 590

Sacra Catino, 100, 101
Sagadahoc Co., Maine, 553, 554
Saggitarius, 89
Sahanivotry, Madagascar, 465, 478, 479
Sahatany River valley, Madagascar, 476, 477 *map*,
 478
St. George and Dragon, 129, 130
St. Jerome, 87
St. Michael's Mount, England, 549
Sakamoto, C., synthesis, 298
Salinas, Brazil, 392
Salisbury field, Zimbabwe, 603, 604
Salzburg, Austria, 55, 371
Sanarka, Urals, USSR, 537, 538
Sandawana emerald, Zimbabwe, 606, 607
Sandawana Mines (Pvt.) Ltd., 606
San Diego Co., California, 594–600
San Diego mine, California, 596
Sandwich stones, 316, 317
San Ignacio church, 144
San Ilario, Elba, Italy, 458
San Luis Potosí, Mexico, 481
San Pedro mine, California, 597, 598
San Piero, Elba, Italy, 458, 459
Santa Marta, Colombia, 29
Saône-et-Loire, France, 440
São Paulo, Brazil, 397
Sapphire, 10, 32, 33, 48, 50, 63, 72, 74, 75, 89, 91,
 95, 97, 236

INDEX

- Sappir, 81
 Sapucaia, Brazil, 395
 Saraiel, 70, 89, 97
 Sarapulka, Urals, USSR, 521
 Sardonyx, 84, 86, 97
 Saskatchewan, 404
 Saturn, 92
 Savatevo, USSR, 514
 Sawtooth Mountains, Idaho, 587, 588
 Saxony, German Democratic Republic, 443
 Scandium
 bazzite, 224
 coloring ion, 218
 content, 169, 170
 substitution, 172
 Scapolite, Madagascar, 471
 Scarabs, 5, 8, 61, 78, 95, 106
 Schettler emerald, 112
 Schist type deposits, 349-351
 Schlaggenwald, Czechoslovakia, 436
 Schlieren deposits, 339, 342
 Schoenflies notation, 159
 Schorl Mountain, USSR, 516, 517
 Schweidnitz, Poland, 490
 Scintillometer, 179
 Scorpio, 88, 89
 Scotland, 55, 548, 549
 Scott mine, South Dakota, 579
 Scratch test, 54, 293
 Screw dislocations, 271
 Scythian emerald, 19, 20, 525
 Seals, 119
 Seasonal beryl wear, 89
 Seats of precious stones, 91
 Secondary inclusions, 282, 286
 Second order bipyramids, 252, 253t
 Second order prism, 242, 247, 248
 Sedimentary deposits, 354, 355
 Seed plate, 308, 309, 318, 319
 Semi-tertiary fever, 78
 Seneca, Marcus, 292
 Senpe mine, California, 597
 Septuagint, 83
 Sepulveda, Antonio, 93
 Serra das Lages emerald, Brazil, 386, 388
 Serro, Sabinópolis, Guanhães area, Brazil, 395
 Sessa, 65
 Sesortis II, 4, 542
 Sex of gems, 92
 Shah Abbas, 120
 Shah diamond, 112
 Shah of Persia, 70
 Shah Shuja, 113
 Shastas, 63
 Shaytansk, Urals, USSR, 521, 524
 Shebo, 81
 Shell crystals, 272-275, 283, 447, 476, 579, 580, 582, 584, 587
 Sherlovaya Gora, USSR, 515, 516, 517
 Shire, Maurice, 607
 Shoham, 81, 83, 84, 85
 Siberia. *See* USSR
 Sikait, United Arab Republic, 543, 544 map, 546
 Silicon
 content, 164
 exchange with beryllium, 172
 in formulas, 172, 173
 tetrahedra, 157, 158, 159, 166, 171
 Silk inclusions, 284
 Simeon, 89
 Simon the Zealous, 89
 Simple pegmatites, 346
 Simpsonite, 383
 Sirius, 89
 Skarns, 353
 Skin diseases, 79
 Sleep and insomnia, 80
 Slocum quarry, Connecticut, 559
 Smaragd Bresilicus, 378
 Smaragdo-prassius, 39
 Smaragdos and variants, 4, 8, 12, 15, 19, 20, 29
 bastard, 40
 Biblical, 83, 84
 medical lore, 76
 monuments, 98
 Nero's, 62, 99
 origin of root, 611-613
 varieties, 83, 615
 Smithsonian synthetic emerald, 296
 Snake bite and poisons, 77, 95
 Snuff bottles, 119
 Socrates, 96
 Sodalithic pegmatites, 467
 Sodium, 167, 171
 Sodium beryl, 348
 Solar finger, 77
 Solinus, 26, 27
 Solomon, 100
 Somali Republic, 500, 501
 Somerset mine, Republic of South Africa, 492, 493, 494, 498
 Somondoco, 408, 422
 Sonora, Mexico, 481
 Sopeithes, 445
 Sorby, Henry Clifton, 281
 Sore throat, 80
 South African beryls. *See* Republic of South Africa
 South American Indian lore, 77, 93, 94, 408, 427
 South Australia, 366, 367
 South Carolina, 574
 South Dakota, 577-580
 Southern California batholith, 594
 South West Africa, 501-506
 Space group, 159
 Spain, 21, 63, 132, 507
 Spanish Inquisition necklace, 140, color fig. 22

Index

- Specific gravity, 50, 51, 53, 190, 191. *See also* Alkali beryls; Aquamarine; Emerald
- Specific heat, 188
- Spectral absorption, 206, 209–244. *See also* Absorption spectra
- Spencer, L.J.*, 55, 56
- Speranza quarry, Elba, Italy, 459
- Sperisen, F.J.*, 304
- Spessartine, 478, 598
- Spica virginis, 89
- Spinel, 90, 295
- Spiral dislocations, 271
- Spitzkopje, South West Africa, 504
- Spodumene, 359, 478, 479, 566, 567
- Spontaneous decrepitation, 186
- Spruce Pine, North Carolina, 571
- Sri Lanka, 507, 508
- Staining beryl, 178, 179
- Star beryl, 194, 195, 196, 285, 330, 331, 486, 525, 535
- Starzevsky mine, Urals, USSR, 521
- Stephenson, J.A.D.*, 566, 567
- Step mining. *See* Benching
- Stern, Hans*, 388, 391
- Stewart Lithia mine, California, 597
- Stiepelmannite, 504
- Stockholm, Sweden, 509
- Stomach ailments, 79
- Stoneham, Maine, aquamarines, 551, 552
- Strabo*, 11, 445
- Strass, 294
- Streeter and Company, 8, 543
- Stretensky mine, Urals, USSR, 525, 528
- Strickland-Cramer quarry, Connecticut, 560
- Striegau, Poland, 490
- Strontium, 168, 172
- Structure of beryl, 58, 157, 159, 163, 170, 171, 173
- Strzegom, Poland, 490
- Stuffed crystals. *See* Shell crystals
- Styria, Austria, 371
- Substitutions, 162, 170, 171
- Sudan, 508
- Suleiman, Emir*, 13
- Sullivan Co., New Hampshire, 555, 556
- Sultan al-Kamel*, 5
- Sultan Bajazet II*, 110
- Sultan Mahmud I*, 122
- Sun lore, 92
- Supplementary angles, 259
- Surface growths, 268, 271
- Surinam, 508
- Surmá, 76
- Swan egg, 126
- Swat emerald, Pakistan, 488, 489
- Swaziland, 508
- Sweden, 508, 509
- Swedenborg, E.*, cited, 67, 68
- Swidnica, Poland, 490
- Switzerland, 510, 511
- Symerald, 297
- Symmetry, 57, 157, 237–240
- Sympathy, 61
- Syngenetic deposits, 339
- Syngenetic inclusions, 282, 285–287
- Synthetic bazzite, 224, 321
- Synthetic beryl
- chronology, 295–298
 - emerald
 - absorption spectra, 306, 307, 308
 - flame-fusion, 298, 299
 - flux-fusion, 299–313
 - hydrothermal, 313, 316–321
 - inclusions, 302, 306, 313
 - properties, 302–321 *passim*, 320t
- Synthetic corundum and spinel, 90, 210, 295
- Table of Solomon, 98, 99
- Tabula Smaragdina, 99, 100
- Tactite, 353
- Tadzhik SSR, USSR, 519
- Takovaya Brook, Urals, USSR, 525, 527
- Takovskaya mine, Urals, USSR, 525, 535
- Takubo, H., et al* synthesis, 298
- Talismans. *See* Amulets
- Tamil Nadu, India, 450
- Tananarive region, Madagascar, 471
- Tanganyika. *See* Tanzania
- Tanuri Brothers*, 390
- Tanzania, 511–513
- Taos Co., New Mexico, 586
- Tarn, France, 441
- Tarshish, 81, 83, 84, 85
- Tasmania, 366
- Taurus, 77
- Taxila, 11
- Teifaschi*. *See* Tifaschi
- Tekhi, India, 451, 453
- Tektosilicate, 158
- Telemark, Norway, 487
- Temple of Concord, 98
- Tenochtitlan, 29
- Téofilo Otoni region, Brazil, 393–395
- Tertian-ague, 78
- Tessin, Switzerland, 510, 511
- Tetehina, Madagascar, 476
- Texas Creek district, Colorado, 584
- Texcoco emerald, 102
- Thebes, 293
- Thefts, 433, 434
- Theodorus of Samos*, 98
- Theophrastus*, 13, 15, 61, 62, 98, 612
- Therapeutic powers, 73–80, 91, 92, 96
- Thermal conductivity, 187, 188
- Thermal destruction, 188
- Thermal expansion, 187, 190
- Thomas*, 86, 89

INDEX

- Thomas Mountains, Utah, 588, 589
Thompson, William Boyce, 120
Thotmes III, 542
 Thortveitite, 169
 Thorvaldsen Museum, 111
 Thuringia, German Democratic Republic, 443
 Ticino, Switzerland, 510, 511
Tifaschi, 77, 542, 546, 547
 Tigrersk, USSR, 518
 Tin, 97
 Tin-spodumene belt, North Carolina, 566, 567
Tippoo Satiib, 140
 Titanium, 169, 172, 219
 Todgarh, India, 451
 Tomana valley, Colombia, 49
 Tongafeno, Madagascar, 474
 Tooele Co., Utah, 588
 Toothaches, 80
 Topaz, 10, 49, 63, 88, 92, 317, 397, 455, 469, 472, 486, 504, 521, 535, 537, 538, 554, 561, 588, 589, 598, 599
 Topkapi dagger, 122, 123
 Topkapi Palace Museum, 120–124 *passim*, 408
 Topsham, Maine, 554, 555
Toth, Thoth, 99
 Tourmaline, 32, 49, 51, 88, 359, 378, 458, 459, 474, 479, 514, 521, 551, 553, 560, 594, 597, 598, 599. *See also* Rubellite
 Townshend collection, 107, 108, 137, 138
 Traits, 67–69
 Transbaikalia, USSR, 53, 55, 513–518, 515 *map*
 Transition elements, 168–170, 206, 220
 Transvaal emerald, Republic of South Africa, 492–497, color fig. 5
 Trapiche, 195, 214, 262–264 *passim*, 419
Traube, H., synthesis, 296, 300
 Treasury of St. Petronio engraved gem, 110
Treaty of Lahore, 115
 Trentino-Alto Adige, Italy, 456, 457
 Tres Barras, Brazil, 393, 394
 Tribes of Israel, 81, 86
 Triboluminescence, 231
 Tribunal of God emerald, 102
 Triplet, 295
 Troitsky mine, Urals, USSR, 525, 529, 535
 Troup Co., Georgia, 575, 576
 Troyes Cathedral gems, 108
 Trumbull, Connecticut, 561
Tsar Alexander II emerald necklace, 143
Tsar Feodor Alexeivich, 124
Tsar Mikhail, 124
Tsar Nicholas II, 144
 Tsie-mu-lu, 12
 Tsilaisina, Madagascar, 477, 478
 Tule Mountain, California, 595, 599, 600
 Tunia (Tunja) valley, Colombia, 30, 49
 Turkey, 513
 Turner Emerald mine, North Carolina, 570, 571
 Turquoise, 4, 19, 84, 85, 88, 97
 Tuscany, Italy, 457
 Twinning, 262, 439, 449
 Twin Star mine, Zimbabwe, 606
 Tyrol, Austria, 376, 377
 Ubala, Colombia, 422
 Udinskoe-Gazimurskii Khrebet, USSR, 514, 516
 Uganda, 513
 Ukraine, USSR, 538, 539
 Ultraviolet, 231
 Um Harba mines, United Arab Republic, 546
 Umiña emerald, 94
 Uniaxiality, 201
 Unicorn horn, 37
 Union of Soviet Socialist Republics, 513–540
 Unit cell, 158–163 *passim*
 United Arab Republic, 542–548
 United Irishmen gem, 110
 United Kingdom, 548, 549
 United States of America, 549–600
 University of Pennsylvania museum gems, 109
 Untersulzbachtal, Austria, 371
 Upper Merryall, Connecticut, 560
 Ural Mountains, USSR, 19, 519–537
 emerald deposits, 525–537
 analyses of beryls, 535
 chrysoberyl (alexandrite), 536
 geology, 530–532
 history, 525, 526, 529
 large emeralds, 529, 530
 mineralogy, 532, 533, 534t
 mines, 525, 533–535, 537
 mining methods, 529
 origin, 530
 paragenesis, 531, 532, 533
 properties of emeralds and beryls, 533, 534
 pegmatite deposits, 519–525, 537
 Adui River, 524, 525
 Alabashka-Mursinka, 521, 522, 524
 Ilmen Mountains, 537
 Urim and thummim, 63, 81
 Urulga River, USSR, 514, 524
 Urungwe district, Zimbabwe, 603
Ushio, M., and *Y. Sumiyoshi* synthesis, 298
 Utah, 588, 589
 Uzbek SSR, USSR, 519
 Vala, 64
Valenzuela, Pedro Fernández, 29, 30, 408, 409
 Valle d'Aosta, Italy, 457
 Vanadium, 169, 172, 209, 211, 213, 214, 219
 Vandrey filter, 217, 221
Van Gruenen, L.F., 608
Van Walkenburg, W., and *E. Weir* synthesis, 297, 316
 Västerbotten, Sweden, 508
 Vatican treasures, 131
Vauquelin, N.L., emerald analysis, 51–54 *passim*

Index

- Vedas*, 9
Vega, Garcilaso de la, 93, 94
Vegas de San Juan, Colombia, 412, 433
Venus, 89
Verdigris dye, 293
Vermont, 557
Vespasian, 98
Vest-Agder, Norway, 486
Vickers hardness, 186
Victoria, Australia, 365
Victoria and Albert Museum, 107, 137, 138
Victoria field, Zimbabwe, 605, 606
Victoria Regina, 134
Vienna unguent jar, 427
Viitaniemi mine, Finland, 438
Vikramaditya, 63
Virgen del Sagrario, 132, 133
Virginia, 563–565
Vitória da Conquista, Brazil, 386
Vladimir Monomakh, 124
Vogt, Daniel, 111
Vogtland, German Democratic Republic, 443
Vohidahy, Madagascar, 477 *map*, 478
Volcanic beryl, 339
Volhynia, USSR, 538
Vorobeyevite, 514
Vosges, France, 440
Vulgate, 83
- Wadi Nugrus, United Arab Republic, 544
Wadi Sikait, United Arab Republic, 5, 6, 7, 19, 544
Wah Wah Mountains, Utah, 589
Walbrzych, Poland, 490
Walden Gem mine, Connecticut, 560
Walska, Ganna, emerald, 118
Wanamaker, N.D., 583
Warmbad district, South West Africa, 504
Washington State, 593
Water in beryl, 164, 167, 172, 173
Weekday stones, 90
Weltliche Schatzkammer, Vienna, 127, 129
Wenceslaus emerald, 101
West, J., 58
Westchester Co., New York, 562
Western Australia, 267–370
White Mountain, Colorado, 583
White Picacho district, Arizona, 592
White Queen mine, California, 597
Wiedemann, E., 613
Wilkinson, J.G., 542, 543
Wilson, W.B. and H.B. Hall synthesis, 297, 299
Windhuk district, South West Africa, 503
Winston, Harry, 427
Wittelsbach treasure, 129
Wodgina, Australia, 368
Wöhler, F., 53
Wyart, J. and S. Šćávníčář synthesis, 297
Wyoming, 581
- X-rays
 early use of, 57, 58
 inducing color, 228, 229
 powder diffraction data, 276
- Yahalom, 81
Yashpneh, 81, 83–86 *passim*
Yavapai Co., Arizona, 592
Yogananda, P., 74
Yogas, 92
Ytterby, Sweden, 509
Yukon Territory, 406
- Zabara, United Arab Republic, 543, 547
Zabkowice Śląskie, Poland
Zaire, 601
Zambia, 602, 603
Zeeman effect, 224
Zerfass, W., synthesis, 215, 297, 308
Zeus claims, Zimbabwe, 606
Zimbabwe (Rhodesia), 603–608
Zircon, 10, 50, 63, 75
Zodiacal gems, 27
Zodiacal periods, 87, 88
Zodiacal signs, 87
Zolotoy Otrog, USSR, 517
Zoning
 color, 207–209 *passim*, 286
 inclusions, 286
 pegmatite, 343–349 *passim*
 synthetic emerald, 307
Zuburzud, 77
Zumurrud, 12

The first part of the report deals with the
 general situation of the country and the
 progress of the work done during the
 year. It is followed by a detailed
 account of the various projects and
 the results achieved. The report
 concludes with a summary of the
 work done and a list of the
 members of the committee.

The second part of the report deals with the
 financial statement of the organization
 for the year. It shows the income
 and expenditure and the balance
 sheet. The report also contains a
 list of the donors and the amount
 contributed by each. The report
 concludes with a statement of the
 committee's appreciation of the
 donors and a list of the members
 of the committee.

AUTHOR INDEX

Page numbers followed by the letter *c* indicate literature citations; only substantive text discussions of an author's work are included.

- Abdul Hamid, 152c
Abel-Rémusat, J. P., 626c
Achard, F. C., 50, 59c, 180c
Achiardi, G. d', 459, 462c
Acosta, J., 434c
Adams, F. D., 22c, 23, 25, 26, 31, 41, 58c, 103c
Adams, J. W., 199, 200, 585c
Adams, J. W. H., 462c
Adams, W. H. D., 625c
Adamski, J. A., 322c
Adamson, O. J., 487c
Aderca, B., 602c
Agricola, Georgius, 30, 31, 58c, 105c, 625c
Ahlfeld, F., 361, 362c, 378c
Albertus Magnus, 281
Alcott, T., 103c
Aldrovandi, Ulyssis, 41, 42, 43, 58c, 104c, 277c
Alexander, A. E., 235c, 322c
Alfonso, X., 58c, 104c
Almeida Rolff, P. A. M., 381, 384, 397c, 398c, 399c
Almeida, S. C. de, 347, 398c
Aloisi, P., 625c
Althausen, M. N., 540c
Ampian, S. G., 179, 183c
Amstutz, A., 322c
Amstutz, G. C., 513c
Anderson, A., 608c
Anderson, A. L., 588c
Anderson, B. W., 53, 208, 212, 217, 233c, 302, 322c
Anderson, C., 365c
Anderson, S. M., 608c
Andersson, L. O., 220, 233c
Anderton, R., 435c
Andres, F. H., 322c
Angel, F., 291c, 377c
Angelelli, V., 361, 362c
Annell, C. S., 592c
Anthony, J. W., 592c
Apolinar Maria, H., 625c
Arfe y Villafañe, Juan de (*see* Arphe de Villafañe, Juan)
Argall, G. O., 585c
Aristarain, L. F., 362c
Arlt, H., 398c
Arnaudov, V., 400c
Arphe de Villafañe, Juan (*also* Arfe y Villafañe), 32, 35, 36, 58c, 625c
Arsандаux, H., 442c
Artini, E., 181c
Arzruni, A., 277c
Ashbee, C. R., 321c
Astbury, 180c
Athavale, V. T., 182c
Atkinson, T. W., 525, 541c
Aubert, G., 442c
Auerbach, F., 186, 192c
Autran, A., 442c
Averyanova, I. M., 541c
Babinet, 195
Bacci, A., 58c, 104c

INDEX

- Backlund, H., 510c
 Baerwald, M., 151c
 Baier, E., 205c
 Bakakin, V. V., 162, 165, 166, 171, 173, 180c, 181c
 Baldasseroni, V., 625c
 Ball, S. H., 11, 21c, 58c, 105c, 152c, 321c, 377c, 626c
 Ball, V., 58c
 Ballman, A. A., 233c, 322c
 Bamberger, C. L., 182c
 Bancroft, Peter, 6, 7, 435c
 Bandy, J. A., 30, 58c, 105c, 625c
 Bandy, M. C., 30, 58c, 105c, 484c, 625c
 Bank, H., 198, 200, 205c, 233c, 234c, 291c, 317, 323c, 399c, 513c, 603c
 Bannatyne, B. B., 407c
 Bannerman, H. M., 556c
 Barbeaut-de-Marny, N., 541c
 Barbier, P., 442c
 Barbosa, A. L. M., 399c
 Barbot, C., 322c
 Bardwell, D. C., 228, 234c
 Baret, C., 442c
 Bariand, P., 359
 Barlow, J. F., 590c
 Barnes, D. F., 232, 235c
 Barnes, J. W., 513c
 Barnett, P. R., 590c, 592c
 Barrie, J., 363c, 365c, 370c
 Barriga del Diestro, A. M., 335, 336, 337c, 430, 435c
 Barriga Villalba, A. M., 58c, 169, 181c, 193c, 216, 232c, 279c, 335, 336, 337c, 417, 419, 428, 430, 434c, 435c
 Barry, G. S., 407c
 Bartoli, P. S., 17
 Barton, W. R., 554c, 556c, 558c, 561c
 Bartoshinskii, Z. B. (*also* Bartoshinsky), 245, 269, 541c
 Bartsch, R. C. B., 557c
 Baskerville, C., 235c
 Bassett, A. M., 485c
 Basta, E. Z., 5, 22c, 279c, 548c
 Bastin, E. S., 554c
 Bastos, F. M., 228, 234c, 398c, 399c
 Bauer, M. H., 55, 59c, 377c, 540c
 Beal, L. H., 591c
 Bebiano, J. B., 361c
 Beck, H. C., 11, 22c
 Beck, L. C., 562c
 Beckmann, J., 321c, 626c
 Beckwith, J. A., 588c
 Behier, J., 480c, 484c
 Belov, N. V., 165, 166, 171, 173, 180c, 181c
 Belzoni, G. B., 548c
 Benoit, J. R., 192c
 Benson, W. T., 600c
 Berdesinski, W., 233c, 234c
 Bergman, T. O., 59c, 180c
 Berliner, M. H., 587c
 Berman, H., 275, 278c, 554c
 Bernauer, F., 262, 263, 264, 277c, 435c
 Bernheim, L. C., 573c
 Berquen, R., de, 103c
 Bertolio, S., 461c
 Bertossa, A., 500c
 Bertrand, E., 262, 277c, 435c
 Berwerth, F., 377c
 Besairie, H., 480c
 Bettencourt Dias, M., 484c
 Beus, A. A., 167, 170, 180c, 274, 346, 350, 352, 355c, 540c
 Bever, J., 585c
 Bhattacharyya, B., 103c
 Bhushan, B. J., 11, 22c
 Bideaux, R. A., 592c
 Biegel, H., 211, 212, 233c
 Biegel, K. H., 216, 233c
 Bingen, H. von, 104c
 Birch, F., 192c
 Birdwood, G. C. M., 9, 11, 22c, 103c
 Bisby, H., 183c
 Bixby, M., 590c
 Bjørlykke, H., 487c
 Black, J. A., 152c
 Blake, R. P., 58c, 625c
 Blake, W. P., 580c, 600c
 Blakemore, J., 554c
 Blankenbaker, E. V., 600c
 Bliss, N. W., 180c
 Bloche, A., 152c
 Blum, J. R., 54, 55, 56, 59c, 104c, 326, 337c
 Boardman, J., 22c
 Bodenlos, A. J., 385, 386, 398c
 Bøggild, O. B., 445c
 Boldryev, A. K., 540c
 Bolman, J., 84, 104c
 Bölsche, R., 291c, 376, 377c
 Bonner, C., 103c
 Boodt, A. B. de (*see* DeBoodt, Anselm Boetius)
 Boos, M. F., 554c, 561c
 Booyens, B., 180, 183c, 346, 356c, 500c
 Borges, A., 484c
 Borloz, A., 322c
 Borovik-Romanova, T. F., 541c
 Borovik, S. A., 169, 181c, 218, 224, 233c, 234c
 Böse, R., 192c, 200, 204c, 291c
 Bostock, J., 22c, 103c, 277c, 321c, 625c
 Bouillet, J. B., 442c
 Bouladon, J., 482c
 Boulanger, J., 480c
 Boutin, H., 165, 181c
 Bowie, S. H. U., 183c
 Bowley, H., 370c
 Bowman, H. L., 291c
 Bowman, J. J., 625c
 Boyle, R., 1, 44, 45, 59c, 104c, 206, 232c

Index

- Bragg, W. H., 57, 59c
Bragg, W. L., 57, 59c, 159, 160, 161, 180c, 193c
Brandt, J. W., 499c
Brannock, K. C., 573c
Branscombe, K. C., 608c
Bratley, G. H., 103c
Brauns, R., 194, 204c
Brennan, D. J., 592c
Breskovska, V., 400c
Brett, B. A., 499c, 608c, 609c
Brewer, P. I., 182c
Brewster, D., 205c, 281, 290c
Brezina, J., 445c
Briand, P., 361c
Bridgman, P. W., 192c
Brière, Y., 480c
Brisson, M. J., 50, 51, 59c
Bristow, H. W., 625c
Britton, H. T. S., 182c
Brocchi, G. B., 548c
Brögger, W. C., 488c
Bronder, O., 234c
Bronkie, Willis F., 432
Brooks, J. H., 363c
Bropst, D. A., 572c, 580c
Brotzen, O., 509c
Brown, C. E., 565c
Brown, J. C., 454c
Brown, W. R., 565c
Brownell, G. M., 183c
Brückmann, U. F. B., 48, 49, 50, 59c, 540c, 626c
Brugnatelli, L., 291c, 460c
Brun, A., 192c, 205c
Brunner, H., 152c
Bryan, B., 580c
Buchanan, R. A., 165, 181c
Buchester, K. J., 366c
Buchi, S., 355c
Buchi, S. D. H., 181c
Buckeley, A., 182c
Bücking, H., 205c
Budge, E. A. W., 103c, 104c
Bullock, K. C., 589c
Burbank, B. B., 555c
Bürg, G., 506c
Bürgl, H., 413, 435c
Burkart, E., 437c
Burke, J. G., 277c
Burke, K. C., 183c, 456c
Burnol, L., 442c
Buryanova, E. Z., 541c
Busatti, L., 462c
Busz, K., 277c
Butler, P. J., 281, 290c
Buttgenbach, H., 602c

Cahn, J. P., 323c
Cailliaud, F., 6, 7, 21c, 548c
Calderon, S., 491c, 507c
Caley, E. R., 15, 22c, 103c
Calmbach, W. F., 397c
Cameron, E. N., 346, 355c, 506c, 554c, 556c, 561c
Camillus, Leonardus (*see* Leonardus Camillus)
Campbell, F. A., 163, 180c, 193c, 278c, 407c
Cannon, B., 593c
Canova, L. J., 58c, 104c, 429, 434c
Caplan, A., 152c
Carbognell, J. P., 489c, 507c
Cardeza, J. T. M., 563c
Cardoso, G. M., 507c
Carr, W. J., 590c
Carron, M. K., 183c
Catalano, L. R., 362c
Catriu, L., 398c
Cellini, Benvenuto, 293
Cerný, P., 182c, 199, 437c
Cesi, B., 58c
Chabouillet, P. M. A., 151c
Chamberlin, B. B., 562c
Chancey, C. N., 576c
Chapman, A., 573c
Charrin, V., 442c
Charubel, 103c
Chase, A. B., 307, 322c
Chatham C. F., 304
Chatham, T., 323c
Chattopadhyay, 455c
Chaudhari, M. W., 264, 278c, 455c
Chauris, L., 442c
Chayes, F., 557c
Chester, A. H., 625c
Chhibber, H. L., 400c, 455c
Chistyakova, M. B., 181c, 541c
Chmyrev, V. M., 361c
Choate, R., 588c
Choubert, B., 442c
Chudoba, K. F., 625c
Chukrov, F. V., 541c
Clapton, E., 104c, 626c
Clark, G. H., 577c
Clarke, W. B., 365c
Claus, R. J., 484c
Cloud, P. E., 554c
Coates, J. S., 508c
Cobb, C. M., 322c
Coche de la Ferte, E., 152c
Cochrane, R. S., 435c
Codazzi, R. L., 58c, 262, 277c, 434c, 435c
Cohenour, R. E., 589c
Colasso, T., 461c
Collins, J. H., 549c
Comba, A., 507c
Combe, A. D., 513c
Conley, J. F., 572c
Connolly, J. P., 580c
Cook, R. B., 576c

INDEX

- Cooper, C. W., 104c
 Copaux, H., 176, 182c
 Copeland, L. L., 152c
 Correia Neves, J. M., 484c, 491c
 Corsi, F., 625c
 Cossa, A., 462c
 Cotelo Neiva, J. M., 491c
 Cotton, W. L., 398c
 Coughlin, E. D., 182c
 Couyat, J., 548c
 Cripe, D. M., 322c
 Crooke, W., 13, 22c, 58c
 Crookshank, H., 273, 278c, 446, 447, 448, 454c, 455c
 Cross, R. T., 585c
 Crowningshield, C. R., 153c, 317, 322c, 573c
 Cullen, Edward, 59c
 Curie, J., 192c
- D'Achiardi, G. (*see* Achiardi, G. d')
- Da Cunha, O. L., 399c
 Dahlberg, E. H., 508c
 Dalton, O. M., 151c
 Damour, A., 181c, 480c
 Dana, E. S., 180c, 277c
 Dana, J. D., 237, 277c
 Daniels, J. L., 501c
 Dathe, J. H. E., 490c
 Dave, A. S., 455c
 Davenport, C., 151c
 David, T. W. E., 365c
 Davidson, S. C., 573c
 Davies, D. N., 508c
 Davies, J. F., 407c
 Davies, R. G., 489c
 Davis, A. P., 84
 Davis, S. G., 490c
 Dawson, J., 549c
 Dawson, N. E., 600c
 De Almeida, S. C. (*see* Almeida, S. C. de)
 De Kun, N., 601c
 De Laet, J. (*see* Laet, J. de)
 de Lisle, Rome (*see* Rome de Lisle)
 De Ment, J., 231, 235c
 de Michele, V., 182c, 356c, 461c
 De Morales, G. (*see* Morales, G. de)
 De Mosquera, D. (*see* Mosquera, D. de)
 De Smid, H. S., 407c
 De Vis, H., 58c, 625c
 Dearnley, R., 549c
 deBoodt, Anselm Boetius, 37, 38, 58c, 104c, 337c, 625c
 Deer, W. A., 180c, 193c, 205c
 Deicha, G., 290c
 deLaet, Joannes, 38
 Delesse, A. E. O. J., 486c
 Dellwig, L. F., 554c
 Dennis, J. G., 506c
 deRosnel, Pierre (*see* Rosnel, P. de)
- Desautels, P. E., 153c
 Descloizeaux, A., 205c
 Destombes, J., 482c
 Deveze de Chabriol, J. S., 442c
 Dey, A. K., 454c
 Dickinson, S. B., 367c
 Diehl, R., 309, 310, 311, 313, 323c
 Dietrich, R. V., 565c
 Dimitrescu, R., 500c
 Diniz Gonsalves, A., 397c
 Dittler, E., 460c, 500c
 Divljan, S. V., 601c
 Dixon, S. S., 434c
 Doberer, K. K., 99, 105c
 Dodson, R. G., 463c
 Doelter, C., 180c, 193c, 225, 228, 229, 234c
 Dohmen, H., 373, 377c
 Döll, E., 181c, 437c
 Dominguez, A., 433
 Dominguez, A. R. A., 434c
 Dragsted, A., 104c
 Draper, T., 398c
 Dreher, O., 398c
 Dressel, W. M., 178, 183c
 Duclos, P., 181c
 Duguat, Abbe, 59c
 Duke, D. A., 189, 192c, 299, 323c
 Duleep Singh, Maharajah, 152c
 Dumas, M., 480c
 Duncan, D. D., 152c
 Dunn, P. J., 153c
 Dunstan, B., 363c, 485c
 Duparc, L., 204c, 256, 277c, 442c, 474, 478, 480c, 491c
 Durden, C. J., 407c
- Eakle, A. S., 600c
 Ebelman, J. J., 299, 322c
 Eberl, R., 377c
 Eckel, E. B., 585c
 Edwards, J. W., 183c
 Edwards, M. G., 602c
 Egleston, T., 625c
 Eichholz, D. E., 15, 19, 22c, 105c, 337c
 Eichler, F., 152c
 Eichhoff, H. J., 213, 222, 233c
 Ellsworth, H. V., 407c
 Emberger, A., 480c
 Embrey, P. G., 549c
 Emelyanova, E. N., 321, 323c
 Emerson, B. K., 558c
 Emiliani, F., 460c
 Engelhardt, E., 231, 235c
 Engle, E. A., 176, 182c
 Epiphanius, 103c, 625c
 Eppler, A., 234c, 507c, 625c, 626c
 Eppler, W. F., 152c, 195, 204c, 291c, 302, 306, 307, 322c, 323c, 334, 337c, 435c, 541c

Index

- Erd, R. C., 591c
Erichsen, A. I., 398c
Ernst, V. E., 268, 278c
Eschwege, W. L., 378, 397c
Espig, H., 300, 301, 302, 322c
Etereo, Ardente, 104c
Evans, H. T., 181c
Evans, J., 58c, 104c
Everitt, A., 600c
- Fairchild, J. G., 182c, 600c
Fairholt, F. W., 103c
Falconer, J. D., 485c
Farquharson, R. A., 501c
Farrant, J. R., 445c
Farrington, O. C., 398c
Feininger, T., 435c
Feklichev, V. G., 173, 180c, 181c, 268, 278c, 283, 284
Feldhaus, F. M., 321c, 626c
Fellinger, R., 192c
Fernandes, X. P., 398c
Fernando, L. J. D., 508c
Ferne, W. T., 96, 104c
Ferrari, M., 461c
Ferraz, L. C., 397c
Ferrer, A. A., 177, 182c
Fersman, A. E., 152c, 210, 233c, 351, 355c, 356c, 523, 527, 528, 530, 533, 535, 540c, 541c
Fiedler, H., 490c
Finot, L., 103c
Firth, C. M., 4
Fischer, H., 182c
Fischer, W., 443c
Fisher, D. J., 580c
Fizeau, H., 187, 192c
Flanigen, E. M., 234c, 306, 308, 313, 323c
Flink, G., 509c
Flint, G. M., 557c
Flores, T., 481c
Floyer, E. A., 548c
Fobes, H. K., 103c
Fogg, H. C., 182c
Fontaine, W. M., 565c
Foord, E. E., 204, 205c, 600c
Forbes, B. G., 367c
Ford, W. E., 193c, 204c, 249, 255, 277c, 561c, 596, 600c
Forster, A., 444c
Foshag, W. F., 302, 322c, 481c
Fossing, P., 152c
Foye, W. G., 561c
Franco, R. R., 398c
Frank-Kamenetskii, V. A., 162, 180c
Fraser, H. J., 554c
Fraser, L. M., 363c
Frenzel, A., 443c
Frere, G., 480c
- Frey, E., 500c
Freyberg, B. Von, 398c
Fries, C., 481c
Froes Abreau, S., 398c
Frommurze, H. F., 506c
Frondel, C., 224, 226, 228, 234c, 321, 323c, 590c
Fryer, C. W., 313, 323c
Fuchs, G., 361c
Fuchs, R., 192c
Fujiwara, S., 181c
Furbish, W. J., 573c
Furcron, A. S., 576c
Fürtwängler, A., 15, 16, 22c, 152c
- Gaal, R. A. P., 152c
Gabelchovero, Wolfgang, 58c
Galbraith, D. S., 584c
Galbraith, F. W., 592c
Galia, W., 323c
Gallagher, M. J., 175, 182c, 186, 192c, 513c, 549c, 609c
Gallitzin, D., 625c
Galpin, S. A., 576c
Ganguli, D., 323c
Gansser, A., 435c
Garbe, R., 104c, 625c
Garboe, A., 104c
Gaudefroy, C., 482c
Gavrusevich, B. A., 226, 234c, 540c, 541c
Gedney, E. K., 275, 278c, 554c
Geehan, R. W., 565c
Geerts, A. J. C., 625c
Geffroy, 442c
Geissler, H., 282, 290c
Geller, R. F., 187, 192c
Genth, F. A., 563c, 572c
Gentile, A. L., 298, 322c
Gesbaud, 442c
Gesner, Conrad, 32, 33, 34, 58c, 103c, 105c, 378, 397c
Gevers, T. W., 492, 499c, 506c
Gianella, V. P., 591c
Giesecke, C. L., 445c, 456c, 485, 486c
Gilkey, M. M., 585c
Gillain, P. R., 407c
Gilliams, T. F., 541c
Gilman, J. J., 323c
Gimma, G., 103c, 625c
Ginsburg, A. I., 540c
Ginzburg, A. I., 165, 172, 180c
Giraud, P., 480c
Giulio, V. Di, 291c
Glass, J. J., 264, 565c
Gleason, S., 235c
Gliszczynski, S. von, 233c
Goldich, S. S., 577c
Goldman, D. S., 218, 233c
Goldschmidt, V., 194, 204c, 237, 277c, 355c

INDEX

- Goldsmith, C. E., 554c, 556c, 558c, 561c
 Gonnard, F., 442c
 Gonyer, F. A., 554c
 Gonzalez, P., 481c
 Gonzalez, R. R. L., 363c
 Goodwin, F. E., 193c
 Goranson, E. A., 573c
 Gordienko, V. V., 541c
 Gordon, S. G., 563c
 Gosse, R. C., 562c
 Grant, R. W., 557c
 Grattarola, G., 459, 462c
 Graziani, G., 291c
 Greg, R. P., 195, 204c, 456c, 486c, 549c
 Gregorietti, G., 8, 22c
 Grevink, C., 541c
 Gries, J. P., 580c
 Griffin, L. J., 268, 278c
 Griffiths, W. R., 565c, 572c, 574c, 576c, 590c, 592c
 Griffon, J. C., 384
 Grigoriev, D. P., 271, 274, 278c
 Grill, E., 462c
 Gross, E. B., 585c
 Grubb, P. L. C., 180c, 291c, 371c
 Grum-Grzhimailo, S. V., 211, 233c
 Gübelin, E. J., 193c, 204c, 282, 283, 284, 285, 287, 290c, 291c, 306, 316, 317, 322c, 375, 377c, 435c, 455c, 489c, 508c, 513c, 607, 609c, 625c
 Guidi, G., 291c
 Guigues, J., 480c
 Guillemin, C., 484c
 Guimares, D., 399c
 Guimin, L., 442c
 Gürich, G., 506c
 Gutierrez, M., 435c
 Gysin, M., 491c

 Haapala, I., 180c, 439c
 Haberlandt, H., 377c
 Hahn, M., 390, 398c
 Hale, F. H., 183c
 Hall, A., 456c
 Hall, H., 323c
 Hall, L. R., 178, 183c
 Hall, R., 591c
 Hall, T. C. F., 549c
 Hall, T. M., 456c, 486c, 549c
 Haller, J., 445c
 Hamid, Abdul (*see* Abdul Hamid)
 Hamlin, A. C., 554c
 Hankel, W. G., 190, 192c
 Hanley, J. B., 581c, 584c, 585c, 589c, 600c
 Hänni, H. A., 181c
 Hansmann, L., 103c
 Harger, H. S., 500c
 Harris, De V., 589c
 Harris, J. F., 513c
 Harris, T. M., 104c, 625c

 Hartwell, J. W., 499c, 608c, 609c
 Haschmi, M. Y., 548c, 613, 625c
 Hatton, J., 152c
 Haughton, S., 456c
 Haughton, S. H., 506c
 Hautefeuille, P., 299, 300, 322c
 Häyry, R. J., 53, 54, 59c, 180c, 236, 237, 277c
 Hawkes, J. R., 175, 182c, 513c, 609c
 Hawley, C. C., 585c
 Hawthorne, F. C., 199
 Haynes, P. E., 587c
 Heaps, W., 104c
 Heck, E. T., 482c
 Heckroodt, R. O., 182c
 Heddle, M. F., 549c
 Heide, F., 443c
 Heiniger, E. A., 152c
 Heiniger, J., 152c
 Heinrich, E. W., 576c, 577c, 581c, 585c, 589c, 592c
 Helz, A. W., 592c
 Henderson, E. P., 195, 204c
 Henderson, W. A., 182c
 Hendley, T. H., 11, 22c, 114, 152c, 434c
 Herman, F., 398c, 434c, 541c
 Hermann, W., 225, 234c
 Hernandez, L. H., 264, 278c
 Heron, A. M., 488, 489c
 Herrera, A. de, 434c
 Herrera, A. O., 362c
 Hertz, B., 138, 139, 140, 151c
 Hervo, P., 323c
 Hess, F. L., 554c, 558c, 580c, 583c
 Heusser, J. C., 205c
 Hewett, D. F., 591c, 592c
 Hickman, A. C. J., 603c
 Hidden, W. E., 253, 277c, 566, 567, 573c
 Higgins, R. A., 15, 22c
 Hill, J., 22c, 612, 625c
 Hillebrand, W. F., 590c
 Hiller, J., 561c
 Hills, R. C., 585c
 Himmel, H., 271, 272, 277c
 Hindmarsh, Robert, 82
 Hinrichs, E. N., 591c, 592c
 Hintze, C., 180c, 192c, 205c, 277c
 Hintze, J., 434c
 Hitchcock, E., 558c, 561c
 Hitchen, C. S., 322c, 558c
 Hobbs, S. W., 592c
 Hodge-Smith, T., 366
 Hoffman, D. L., 337c
 Hoffmann, W. J., 591c
 Högbom, A. G., 182c, 273, 278c, 510c
 Hoke, C. M., 625c
 Holden, E. F., 557c
 Holfert, J., 590c
 Holland, Philemon, 18, 22c
 Höller, H., 377c

Index

- Holmes, G. H., 591c
Holmes, R. J., 317, 322c
Holmyard, E. J., 99, 105c
Holser, W. T., 587c
Holstein, O., 103c
Holtzapffel, C., 625c
Honest, A. P., 265, 266, 267, 268, 278c
Hopkins, B. S., 176, 182c
Hornung, G., 608c
Hosenfeld, M., 182c
Howie, R. A., 180c, 193c, 205c
Hughes, C. J., 445c
Hughes, G., 152c
Hügi, T., 181c, 511c
Huguet, J. L., 182c
Hume, W. F., 548c
Hunting, M. T., 593c
Hunty, L. E. de la, 371c
Huré, J., 182c
Hurlbut, C. S., 346, 356c, 362c, 554c
Hutchinson, R. W., 484c
Huttenlocher, H., 181c

Ikornikova, N. Y., 205c, 540c
Illig, K., 182c
Insley, H., 187, 192c
Ismalun, M., 543, 548c
Ito, J., 224, 234c, 321, 323c
Ivanov, I. M., 400c
Ives, R. L., 585c
Iyer, L. A. N., 452, 455c, 489c

Jackson, K. A., 178c, 214, 233c, 263, 264, 435c
Jacobson, M. I., 585c
Jacobson, R., 485c
Jaeger, M., 322c
Jahns, R. H., 180c, 278c, 554c, 565c, 576c, 587c, 592c, 600c
Jakob, J., 193c, 511c
James, C., 182c
Jannettaz, E., 12, 187, 188, 192c, 209, 233c
Januzzi, R. E., 561c, 562c
Jarman, D. F., 81
Jaroš, Z., 437c
Jayaraman, N., 218, 225, 226, 233c
Jedwab, J., 178, 183c, 346, 356c
Jefferis, W. W., 563c
Jenks, W. F., 561c
Jensen, D. E., 562c
Jeremeyev, P. V., 277c, 540c, 541c
Jesus, A. M. de, 491c
Ježek, B., 437c
Jimbo, K., 463c
Jobbins, E. A., 153c
Johnson, J. E., 365c
Johnson, P. W., 432, 434c
Johnson, W., 370c
Johnston, W. D., 273, 278c, 397c, 398c
Johnston, W. D., Jr., 274
Johnstrup, F., 445c
Joklik, G. F., 366c
Joliffe, A. W., 407c
Joly, J., 192c, 225, 234c
Jomard, E. F., 22c
Jones, R. H., 445c
Jones, W., 104c, 481c
Jonin, N., 541c
Jorgensen, N., 554c
Josephson, G. W., 499c
Joubert, G. K., 499c
Jouravsky, G., 482c
Joy, Charles H., 176
Just, E., 398c, 587c

Kabesh, M. L., 508c
Kaiser, E., 506c
Kalita, A. P., 541c
Kalix, Z., 363c, 365c, 370c
Kalugin, P., 541c
Kanis, J., 603c, 609c
Karabacek, J., 104c, 152c
Kargin, W., 225, 234c
Karnozhitsky, A., 205c
Keane, A., 152c
Keferstein, C., 612, 625c
Kenngott, A., 183c
Kent, L. E., 499c
Kerr, P. F., 182c, 591c
Kerr, W. C., 572c
Kesler, T. L., 573c
Khan, S. N., 489c
Kibaltchitch, T. W., 152c
Kiilsgaard, T. H., 565c
Kilpady, S., 455c
Kimbauer, F., 500c
Kimbler, F. S., 587c
King, B. C., 513c
King, C. W., 15, 22c, 58c, 66, 103c, 108, 111, 151c, 322c, 325, 337c, 612, 614, 625c, 626c
King, R. H., 581c
Kinoshuto, S., 192c
Kirnbauer, F., 437c
Kirov, G. N., 400c
Kjellgren, B. R., 182c
Klang, H., 218, 233c, 399c
Kleeman, A. W., 181c, 367c
Klein, August, 390, 391
Klein, F., 104c, 232c, 337c, 398c, 421, 425, 434c
Klemm, R., 209, 210, 233c
Klepper, M. R., 399c, 576c
Kluge, K. E., 55, 59c
Knapp, W. J., 192c
Knoblauch, H., 192c
Knorring, O., 275, 278c, 484c, 608c
Knorring, O. V., 506c, 513c, 549c
Knox, T. W., 526

INDEX

- Kobysheva, M. M., 542c
 Koch, F., 601c
 Koch, W., 103c
 Kohlmann, H., 204c, 265, 266, 267, 277c
 Koksharov, N., 180c, 251, 257, 258, 259, 514, 524, 536, 540c
 Kolbe, E., 211, 233c
 König, G. A., 565c
 Königsberger, J., 511c
 Kontrus, K., 377c
 Kopcewicz, T., 234c
 Koschmann, A. H., 565c
 Kostov, I., 400c
 Kouřimský, J., 437c
 Kovaloff, P., 498, 499c
 Kozminsky, I., 103c, 625c
 Krajicek, E., 377c
 Kranck, E. H., 291c
 Kratochvil, F., 437c
 Kratzert, J., 481c
 Krauck, E. H., 439c
 Kraus, P. D., 337c
 Krejčí, A., 437c
 Kremer, M., 182c
 Kretz, R., 407c
 Krianovsky, V. (*also* Krianovski), 482c, 541c
 Krippene, K., 438c
 Kris, E., 152c
 Krishnan, M. S., 452, 455c
 Kris-Rettenbeck, L., 103c
 Kruta, T., 437c
 Kun, N. de (*see* DeKun, N.)
 Kunz, G. F., 21, 22c, 58c, 74, 75, 83, 84, 87, 103c, 104c, 152c, 231, 235c, 377c, 391, 398c, 434c, 435c, 480c, 487, 499c, 541c, 554c, 556c, 557c, 558c, 562c, 563c, 572c, 573c, 585c, 600c, 626c
 Kurbatov, J., 225, 234c
 Kutakova, E. I., 278c, 291c, 356c, 530, 541c
 Kuznetsov, S., 540c
 Kuznetsova, E., 542c
- La Touche, T. H. D., 454c
 Laars, R. H., 103c
 Lachman, F., 180c, 355c, 540c
 Lacroix, A., 193c, 204c, 256, 277c, 279c, 345, 356c, 361c, 442c, 465, 467, 480c
 Laemmlein, G., 282, 286, 290c
 Laet, J. de, 625c
 Lagercrantz, O., 321c
 Lambrecht, W., 444c
 Landes, K. K., 407c, 554c, 585c
 Lane, A. C., 191c
 Lang, A. J., 580c
 Laplaine, L., 480c
 Lapparent, A., 540c
 Larrabee, D. M., 399c, 556c
- Latham, E. B., 434c
 Laubmann, H., 444c
 Laufer, B., 11, 12, 22c, 613, 625c
 Laus, H., 438c
 Lautel, R., 480c
 Lavila, L., 480c
 Lavrinenko, L. F., 542c
 Lavrov, S. E., 541c
 Lawrence, L. J., 365c
 Le Berquier, F., 182c
 Le Grange, J. M., 499c
 Le Mesurier, C. R., 371c
 Lea, Isaac, 281, 290c
 Lebedeva, S. I., 186, 192c
 LeBrun-Dalbanne, 151c
 Lechleitner, Johann, 316, 317
 Lecomte, J., 234c
 Lee, D. E., 591c
 Lefever, R. A., 307, 322c
 Lefraye, M., 601c
 Lehmann, J., 185, 191c, 282, 290c
 Leinz, V., 291c, 398c
 Leiper, H., 337c, 500c, 609c
 Leitmeier, H., 168, 169, 181c, 255, 256, 277c, 291c, 373, 375, 376, 377c
 Lemberg, J. T., 176, 182c
 Lemke, R. W., 565c
 Leonardos, O. H., 291c, 397, 398c, 399c
 Leonardus Camillus, 27, 28, 58c, 103c, 292, 321c, 625c
 Lernoux, P., 104c, 434c
 Lesley, P., 152c
 Lesure, F. G., 565c, 576c
 Lettsom, W. G., 195, 204c, 456c, 486c, 549c
 Levenshtein, M. L., 542c
 Levin, S. B., 557c
 Levine, V., 434c
 Lévy, B., 181c, 209, 233c, 435c
 Liberi, G., 438c
 Lieber, W., 235c
 Liesegang, R. E., 234c
 Linares, R. C., 213, 233c, 307, 322c, 323c
 Lincio, G., 461c
 Lind, S. C., 228, 234c
 Lindberg, M. L., 399c
 Lindert, W., 443c
 Lisle, T. O., 231, 235c, 556c, 580c
 L'Isle, Rome de (*see* Rome deLisle)
 Little, H. P., 4, 21c, 548c
 Liversidge, M. A., 365c
 Long, J. S., 581c
 Lonicer, A., 104c
 Lorz, O., 444c
 Lothrop, S. K., 21, 22c, 29, 58c, 434c
 Lucas, A., 4, 21c, 292, 321c, 324, 325, 337c, 542, 548c
 Lucas, J. A. H., 52
 Lucchesi, S., 291c

Index

- Lupton, H., 235c
Lüschen, H., 625c
- MacAlister, D., 548c
MacAlister, D. A., 22c
MacFadden, C. K., 430, 435c
MacFall, R. P., 153c
Machatschki, F., 182c, 437c
MacKague, H. L., 264
Macquart, L. C. H., 540c
Maddalena, L., 459, 462c
Madelung, E., 192c
Magistretti, L., 461c
Magnus, Albertus (*see* Albertus Magnus)
Mahoney, T., 151c
Maier, W., 334, 337c
Maijer, C., 491c
Maillot, E. E., 554c, 561c
Makinen, E., 439c
Maksimovic, Z. D., 601c
Mallard, E., 205c
Manchester, J. G., 562c
Mangin, A., 625c
Marianne, P. J., 109
Markham, N. L., 365c
Marshall, F. H., 8, 22c, 151c
Martensson, C., 509c
Martin, H. J., 607, 608c
Martinenghi, M., 277c, 461c
Martyanov, N. N., 540c
Masahisa, T., 463c
Mason, B., 338, 355c
Mason, F., 400c
Maspero, G., 8, 22c
Mathur, S. M., 274, 278c, 455c
Matkovsky, O. I., 541c
Matossi, F., 234c
Matura, A., 361c
Maufe, H. B., 608c
Maurice, C. S., 572c
Mawe, John, 378, 380, 397c
Mawson, D., 361c, 367c
Mayers, D. E., 609c
McCabe, H. R., 407c
McCallie, S. W., 576c
McKague, H. L., 278c
McKenzie, B. J., 572c
McLaren, D. C., 407c
McLaughlin, T. G., 581c
McLellan, R. R., 585c
McLintock, W. F. P., 549c
McVay, T. N., 178, 183c
Meen, V. B., 120, 121, 152c, 153c, 407c, 434c
Megenberg, K. von, 103c
Meixner, H., 377c
Melion, J., 438c
Mellor, J. W., 180c, 192c
Melnikov, M. P., 541c
Melville, J., 104c
Ment, J. de (*see* de Ment, J.)
Mentzel, C., 424, 435c
Menzhausen, J., 152c
Mercer, R. A., 189, 192c, 298, 323c
Mercier, M. Le, 442c
Merrill, F. J. H., 600c
Merrill, G. P., 573c
Metson, N. A., 608c
Mezhetsky, 541c
Michalke, H., 234c
Michel, H., 282, 290c, 398c
Michele, V. de (*see* DeMichele, V.)
Michell, W. D., 490c
Middlemiss, C. S., 447, 454c, 489c
Middleton, J. H., 15, 22c, 151c
Miethe, A., 228, 234c
Millard, W. J., 399c
Miller, B. L., 398c
Miller, C. E., 558c
Miller, R. P., 189, 192c, 298, 323c
Millosevich, F., 277c, 460c, 461, 462c
Mills, B. A., 204, 205c
Millson, H. E., 235c
Milner, G. W. C., 183c
Mincheva-Stephanova, Y., 400c
Miro, J. I., 104c, 133, 152c
Mitchell, K., 278c, 484c
Mobus, G., 443c
Modell, D., 557c
Moir, J., 209, 233c
Moleva, V. A., 181c, 541c
Montgomery, A., 563c, 585c, 587c, 590c
Moore, B. N., 591c, 592c
Moraes, L. J. de, 399c
Morales, G. de, 37, 58c, 104c
Morana, S. J., 177, 182c
Morefield, S. V., 565c
Morello, T., 435c, 626c
Morgan, P. G., 366c
Morgante, S., 460c
Morin, P., 482c
Morrill, P., 556c, 557c, 558c, 565c
Moser, M., 561c
Mosier, M., 554c, 557c
Mosquera, D., de, 36, 58c
Mountain, E. D., 499c
Mrose, M. E., 181c, 565c
Muir, Alex, 355c
Mukherjee, B., 218, 229, 233c
Muller, F., 460c
Müller, H., 163, 180c, 444c
Mulligan, R., 407c
Munoz Reyes, J., 378c
Munson, R. A., 189, 192c, 299, 323c
Murdoch, J., 398c, 600c
Murdock, T. G., 361c, 480c

INDEX

- Murray, A. S., 151c
 Murray, J., 625c
 Mushketov, I. V., 542c
 Mutis Jurado, V., 435c
 Myers, A. T., 399c
 Myers, T. R., 556c
- Nadkarni, M. N., 182c
 Nagashima, K., 181c
 Nakatsukasa, M., 463c
 Nassau, K., 165, 166, 181c, 208, 213, 214, 216, 219,
 220, 221, 222, 229, 233c, 234c, 235c, 263, 264,
 278c, 299, 301, 303, 306, 308, 318, 322c, 323c,
 399c, 435c, 590c
 Nefedov, E. I., 540c
 Neminar, E., 377c
 Neri, Antonio, 294, 322c
 Neuerberg, G. J., 600c
 Neuhauser, W. E., 626c
 Neumann, G. L., 554c
 Neumann, H., 169, 181c, 487c, 488c
 Newberry, E., 235c
 Newman, E. G., 363c, 365c, 366c, 367c, 370c, 445c,
 463c
 Nicols, Thomas, 39, 40, 58c, 104c
 Niedermayr, G., 377c
 Niggli, P., 356c, 511c
 Nisi, H., 234c
 Nordenskiöld, I., 510c
 Norman, G. W. H., 407c
 Norrish, H., 278c
 Norrish, K., 180c, 193c
 Northrop, S. A., 587c
 Norton, J. J., 580c
 Notton, C., 105c
 Nowacki, W., 181c
- Oakenfull, J. C., 391, 393, 398c
 Öberg, P. E. W., 192c
 O'Donoghue, M. J., 151c
 Oelschlagel, H., 625c
 Oen, I. S., 491c
 Offret, A., 201, 205c
 Oftedahl, I., 487c, 488c
 Ogawa, T., 463c
 O'Hara, C. C., 580c
 Olden, C., 186, 191c, 434c, 625c
 Oliveira, A. I. de, 398c
 Olsacher, J., 362
 Olson, J. C., 572c, 574c, 576c, 577c, 591c, 592c
 Omori, K., 234c, 279c, 456c, 463c
 Orlov, N., 540c
 Osann, A., 444c
 Osterwald, D. B., 581c
 Osterwald, F. W., 581c
 Ostrander, C. W., 563c
- Otero Muñoz, G., 58, 181c, 193c, 232c, 417, 428,
 434c
 Over, E., 585c
- Pachinger, A. M., 104c
 Page, L. R., 180c, 199, 205c, 273, 274, 275, 278c,
 355c, 554c, 556c, 580c, 581c, 585c, 589c
 Page, T. E., 22c, 105c
 Pagliani, G., 277c, 461c
 Paine, L. G., 506c
 Paiva, G. de, 397c
 Pak, C., 22c
 Palache, C., 555c, 573c, 590c
 Pallister, H. D., 577c
 Pallister, J. W., 501c
 Panebianco, H., 193c
 Panebianco, R., 291c
 Pannier, L. C. A., 625c
 Pant, L. M., 235c
 Paré, X., 181c
 Parga-Pondal, J., 507c
 Parker, R. L., 511c
 Parkin, K., 233c
 Parshad, L. J., 489c
 Parsons, A. L., 277c, 403, 407c
 Parsons, C. J., 337c
 Parsons, C. L., 176, 182c
 Partridge, F. C., 499c
 Pastore, F., 363c
 Patkar, A. J., 177, 182c
 Patrin, E. M. L., 516
 Paulose, C. V., 450, 455c
 Pavitt, K., 103c
 Pavitt, W. T., 103c
 Pavlova, I. G., 175, 182c, 200, 205c
 Payne, C. J., 217, 322c
 Pearl, J., 369
 Pearl, R. M., 585c
 Peco, G., 461c
 Pecora, W. T., 389, 397c, 399c
 Pegau, A. A., 565c
 Pehrman, G., 277c, 439c
 Pelloux, A., 438c
 Penfield, S. L., 165, 167, 180c, 266, 268, 278c, 585c
 Peretti, L., 461c
 Perrey, A., 299, 300, 322c
 Perry, L. S., 152c
 Petersson, G. W., 266, 278c
 Petrie, W. M. F., 61, 103c
 Petrusenko, S., 400c
 Petterd, W. F., 366c
 Pezzoli, E., 457
 Phan, K. D., 181c
 Phemister, J., 182c, 549c
 Phillips, F. C., 153c
 Phillips, W., 237, 277c
 Pickup, R., 178, 183c
 Piedrahita, L. F., 434c

Index

- Pierrot, R., 442c
Pilipenko, P. P., 540c
Pitcher, W. A., 456c
Pitt, Robert, 45, 46, 47, 59c
Pittman, E. F., 364, 365c
Piutti, A., 170, 181c, 193c
Plechanov, S. S., 540c
Pliny, 17, 18, 19, 20, 22c, 103, 104c, 277, 293, 321, 625
Plücker, J., 192c
Plyusnina, I. L., 234c
Pockels, F., 205c, 540c
Pogue, J. E., 186, 191c, 262, 277c, 419, 435c
Poirot, J. P., 285, 290c
Pokorný, J., 437c, 438c
Polynovsky, R. M., 542c
Popley, A. R., 217, 233c
Pott, J. H., 47, 59c
Pough, F. H., 152c, 228, 229, 234c, 323c, 394, 398c, 399c, 562c, 573c, 625c
Poullen, J. F., 359, 361c
Prask, H., 181c
Pratt, J. H., 573c
Price, W. E., 563c
Pulfrey, W., 463c
Putzer, H., 389, 397c, 398c, 437c
Pye, E. G., 407c

Quensel, P., 509c
Quick, L., 337c

Raade, G., 488c
Radcliffe, D., 163, 180c, 193c, 278c, 407c
Radelescu, D., 500c
Rādhakrishna, B. P., 449, 450, 455c
Raimondi, A., 489c
Rainier, P. W., 435c
Ramaswamy, C., 449, 455c
Ramdohr, P., 365c, 506c
Ramsay, S., 549c
Rand, T. D., 563c
Rao, K. B., 455c
Rao, M. B. R., 455c
Rapp, G., 580c
Rath, G. vom, 277c, 462c, 573c
Rawson, R. I., 363c
Ray, P. C., 625c
Rayleigh, Lord, 371c
Rayner, E. O., 178, 183c, 365c
Razina, L. S., 181c
Razmanova, Z. P., 181c, 541c
Read, B. E., 13, 22c
Ream, L. R., 590c
Redden, J. A., 580c
Redmon, D. E., 587c
Reed, C. H., 600c
Reed, G. C., 588c
Reeve, W. H., 603c

Reid, R. R., 588c
Reiss, W., 435c
Remick, J. H., 407c
Rengade, 193c
Renovantz, H. M., 540c
Restropo, H., 435c
Reuning, E., 506c
Reuss, F. A., 625c
Reyna, J. G., 481c
Richards, J. F. C., 15, 22c, 103c
Richter, G. M. A., 16, 20, 22c, 151c
Riebling, E. F., 189, 192c, 299, 323c
Riera, J. F., 322c
Ries, H., 562c
Rigal, R., 363c
Rijks, H. R. P., 608c
Riley, H. T., 22c, 103c, 277c, 321c, 625c
Riley, J. M., 580c
Ristic, S., 213, 222, 233c
Ritchey, R. A., 178, 183c
Roadifer, R. E., 580c
Roberts, R. O., 513c
Roberts, W. L., 580c
Robinson, S., 554c, 561c, 562c, 563c
Roebing, W., 233c, 399c
Roedder, E., 281, 290c
Roering, C., 182c, 506c
Rogers, A. F., 181c, 306, 322c, 600c
Rogers, A. W., 499c
Rogers, T. H., 228, 229, 234c
Romanovsky, E., 541c
Romé deLisle, 50, 51, 59c, 180cc, 236, 277c
Roos, G., 277c
Rose, G., 209, 233c, 365c, 435c, 541c
Rosenmüller, E. F. C., 104c
Rosenqvist, I. T., 487c
Rosnel, P. de, 43, 44, 58c, 104c
Rossman, G. R., 233c
Rossovskij, L. N., 361c
Rost, R., 437c
Rotmann, D., 500c
Roulet, B., 290c
Roush, G. A., 499c
Roussouw, P. J., 506c
Rowan, F., 151c
Rowe, R. B., 407c
Roy, B. C., 452, 454c, 455c
Roy, S. K., 455c
Rozanov, K. I., 542c
Rozenberg, D. S., 542c
Rudler, F. W., 456c, 486c
Rueus, F., 104c
Runke, S. M., 580c
Rutland, E. H., 195, 204c
Ruxton, B. P., 490c
Ryan, C. W., 513c
Rybakova, B. A., 152c
Ryerson, K. H., 561c

INDEX

- Rylov, G. M., 180c
 Rynerson, F., 600c
- Sabina, A. P., 407c
 Sabot, R., 204c, 277c, 480c
 Safford, G. J., 181c
 Safiannikoff, A., 602c
 Saha, N. N., 92, 93, 104c, 105c
 Saha, P., 323c
 Sahama, T. G., 180c, 203, 205c, 272, 273, 278c
 Sainsbury, C. L., 592c
 Saint Ours, J. de, 278c, 480c
 Saksena, B. D., 234c, 235c
 Salakh, A., 361c
 Sampson, D. N., 513c
 Sampson, R. J., 600c
 Sampter, E. L., 557c
 Sanchez, G. G., 507c
 Sandrea, A., 442c
 Sankar Das, M., 182c
 Santillan, M., 481c
 Santini de Riols, E. N., 103c, 626c
 Santos Munsuri, A., 291c
 Sarapulov, T. J., 226, 234c
 Sawyer, C. B., 182c
 Sayar, M., 626c
 Scavnicar, S., 316, 322c
 Schadler, J., 500c
 Schafarzik, F., 500c
 Schairer, J. F., 561c
 Schaller, W. T., 162, 167, 173, 180c, 182c, 558c,
 574c, 576c, 592c, 600c, 625c
 Scharizer, R., 377c
 Scheibe, R., 264, 277c, 418, 434c
 Scherillo, A., 460c
 Scherman, O., 361c
 Schetelig, J., 488c
 Schiebold, E., 180c, 322c
 Schilling, J. H., 587c
 Schincaglia, J., 235c
 Schlossmacher, K., 59c, 233c, 399c
 Schmetzer, K., 214, 219, 222, 223, 224, 227, 228,
 229, 233c, 234c, 445c
 Schmetzer, K. A., 214, 233c
 Schmid, H., 444c
 Schmidt, P., 74, 103c
 Schmidt, W., 205c
 Schmidt-Zittel, H., 271, 272, 277c
 Schneider, O., 4, 21c, 103c, 548c
 Schneiderhöhn, H., 346, 356c, 398c, 407c, 437c,
 442c, 487c, 506c, 510, 511c, 541c
 Schooner, R., 561c
 Schopper, J., 84, 104c
 Schrauf, A., 204c, 250
 Schumacher, H. A., 58c, 434c
 Schupp, K., 398c
 Schuster, M., 460c
 Schwantke, A., 490c
- Schwartz, G. M., 580c
 Schwellnus, C. M., 506c
 Scorza, E. P., 398c
 Scott, E. M., 580c
 Scott, R. H., 456c
 Seager, A. F., 271, 278c
 Seaman, D. M., 561c
 Selig, B. L., 398c
 Sellner, F., 437c
 Selset, R., 488c
 Sen Gupta, A. K., 177, 182c
 Sesana, F. L., 363c
 Shainin, V. E., 554c, 561c, 562c
 Shams, F. A., 489c
 Shannon, E. V., 561c, 563c
 Sharma, N. L., 455c
 Sharp, W. N., 585c
 Shaub, B. M., 273, 278c, 558c
 Shcherbakov, D. I., 540c
 Shepard, C. U., 561c
 Sheridan, D. M., 580c
 Shibata, H., 463c
 Shipley, R. M., 306, 322c
 Shipway, C. H., 363c
 Shire, M., 609c
 Siedel, P., 398c
 Siems, P. L., 585c
 Simon, Fray, 434c
 Simons, G. F., 177, 182c
 Simpson, D. R., 600c
 Simpson, E. S., 181c, 370c
 Singewald, J. T., 398c
 Sinkankas, J., 182c, 204c, 337c, 346, 356c, 481c,
 554c, 556c, 561c, 563c, 565c, 572c, 588c, 600c
 Siviero, R., 16, 22c
 Slavin, M., 554c
 Sloan, E., 574c
 Smid, H. S. de (*see de Smid, H. S.*)
 Smith, A., 580c
 Smith, A. H., 151c
 Smith, G., 365c
 Smith, G. F. H., 153c, 434c
 Smith, W. C., 580c
 Smolyaninov, N. A., 540c
 Smolyaninova, N. N., 541c
 Snowman, A. K., 152c
 Sobon, L. E., 307, 322c
 Sobrino-Buhigas, R., 507c
 Söchting, E., 281, 290c
 Sofoulis, J., 371c
 Sohnke, L., 235c
 Sohon, J. A., 561c
 Solodov, N. A., 344, 541c
 Sommerville, M., 151c
 Sorby, H. C., 281, 290c
 Sosedko, A. F., 541c
 Sosedko, T. A., 162, 180c, 182c
 Sotto, I. del, 103c

Index

- Soule, J. H., 587c
Souza, A. J. A. de, 397c
Spence, H. S., 554c
Spence, H. W., 407c
Spencer, L. J., 55, 57, 59c
Spener, J. J., 44, 59c, 625c
Sperisen, F. J., 181c, 306, 322c
Sperry, E. S., 266, 278c
Springer, G. D., 407c
Srebrodolsky, B. I., 541c
Srinivasan, N. R., 226, 234c
Staatz, M. H., 274, 278c, 580c, 585c, 590c, 592c
Stager, H. K., 591c
Stalder, H. A., 181c, 204c, 511c
Stanek, J., 437c, 438c
Staub, R., 510, 511c
Steberl, G., 491c
Steel, W. G., 573c
Steinmann, G., 489c
Steinmetz, H., 398c, 444c
Stella, A., 548c
Stella, E., 105c
Stephenson, J. A. D., 566, 573c
Sterrett, D. B., 434c, 554c, 557c, 558c, 562c, 563c, 565c, 572c, 573c, 574c, 576c, 577c, 580c, 585c, 588c, 590c, 600c
Stevens, J. P., 554c
Stevens, R. E., 180c, 183c, 573c, 592c
Stewart, G. W., 556c
Stobbe, H., 561c, 580c
Stockwell, C. H., 407c
Stoll, W. C., 581c, 588c
Stone, D., 365c
Stopford, F., 103c, 152c
Strand, R., 487c
Strand, T., 182c
Streeter, E. W., 152c
Strunz, H., 159, 291c, 444c
Strutt, R., 170, 181c
Strüver, G., 291c, 462c
Stübel, A., 435c
Stuckey, J. L., 572c
Stugard, F., 561c
Strunz, H., 158
Sugitani, Y., 165, 181c
Sun, C. C., 455, 456c
Sunagawa, I., 306, 323c
Sundius, N., 509c, 510c
Supercceanu, C., 500c
Sushchinsky, P. P., 540c
Sverdrup, T. L., 488c
Swaminathan, V. S., 449, 455c
Switzer, G., 306, 323c, 399c, 557c, 585c, 600c
Taddei, C., 511c
Tagore, S. M., 9, 10, 22c, 103c, 185, 191c, 294, 322c, 435c, 454c, 625c
Taille de Bondaroy, J. de la, 103c, 626c
Takubo, J., 192c, 463c
Talent, J. A., 366c
Tan, Li-Pin, 562c
Tank, R. R., 103c, 625c
Tarasov, E. P., 540c
Tavernier, J. B., 13, 14, 22c, 30, 58c
Taylor, A. M., 608c
Taylor, I. G., 104c
Teague, K. H., 576c
Tenne, C. A., 491c, 507c
Tennyson, C., 158, 159, 182c, 291c, 444c
Theophrastus, 13, 15, 22, 103, 337
Thiagarajan, R., 452, 455c
Thoma, H., 152c
Thomas, B. E., 600c
Thomas, N. W., 104c
Thommen, E., 377c
Thompson, A., 377c
Thompson, R. Campbell, 626c
Thomson, R. D., 600c
Thomson, T., 59c
Thoreau, J., 602c
Thorndike, L., 22c, 24, 25, 38, 58c, 103c
Thurm, R. E., 513c
Thurston, W. R., 585c
Tilden, W. A., 281, 290c
Tissot, F., 442c
Titov, A., 541c
Tolman, C., 577c
Tomich, S. A., 371c
Tornquist, A., 377c
Touray, J. C., 285, 290c
Traill, R. J., 407c
Trapp, F. W., 153c, 435c, 573c
Traube, H., 265, 266, 267, 278c, 322c, 443c, 490c
Trefethan, J., 554c
Trillo-Figueroa, A., 507c
Tripp, E. J., 264, 278c
Trites, A. F., 585c
Tromnau, H. W., 233c, 399c
Tronquay, R., 442c
Tucker, W. B., 600c
Tullis, E. L., 580c
Tushingham, A. D., 120, 121, 152c, 434c
Tutton, A. E. H., 187, 188, 192c
Twining, Lord, 130, 131, 152c, 434c, 626c
Tynsdale-Biscoe, R., 608c
Tzchorn, G., 186, 192c
Uebel, P. J., 291c
Uhlig, J., 398c
Ungemach, H., 600c
Ungemach, M. H., 480c
Valentine, G. M., 593c
Van der Veen, A. H., 608c
Van Eeden, O. R., 291c, 493, 498, 499c

INDEX

- Van Praagh, G., 322c
 Van Uitert, L. G., 233c, 322c
 Van Walkenburgh, W., 322c
 Varde, M. S., 177, 182c
 Vargas, G., 337c
 Vargas, M., 337c
 Varlamoff, N., 500c, 602c
 Vauquelin, N. L., 51, 53, 59c, 163, 180c, 232c
 Vega, G. de la, 93, 104c
 Veltheim, A. F., von, 105c
 Vermeule, C. C., 151c
 Vernadsky, V. I., 626c
 Vernadsky, W., 235c
 Verneuil, A., 295, 322c
 Verrow, H. J., 556c
 Vhay, J. S., 565c
 Vian, R. W., 585c
 Victor, I., 407c
 Vicuña, P. C., 507c
 Vilimkova, M., 22c
 Ville, L., 361c
 Villiers, E., 103c
 Vincent-Geisse, J., 234c
 Viswanath, N., 452, 455c
 Vlasov, K. A., 173, 181c, 278c, 291c, 355c, 356c,
 530, 535, 541c, 626c
 Vogel, P., 193c, 202, 204c, 210, 211, 233c, 420, 435c,
 497, 500c
 Vogelsang, H., 282, 290c
 Vogt, T., 488c
 Voigt, J. H., 186, 192c
 Voigt, W., 192c
 Volborth, A., 439c
 Vollstadt, H., 443c
 Vorma, A., 180c
 Vrba, C., 181c, 277c, 435c, 437c

 Wachter, F., 377c
 Wada, T., 463c
 Wadia, D. N., 508c
 Wagner, P. A., 507c
 Waldschmidt, W. A., 580c, 585c
 Walker, T. W., 403, 407c
 Wallerius, J. G., 47, 48, 59c
 Wallis, E. B., 322c
 Walsh, J. N., 456c
 Walters, D. R., 366
 Walters, H. B., 151c
 Wambeke, L. Van, 602c
 Wang, S. W., 456c
 Ware, J. W., 600c
 Washington, H. S., 277c, 573c
 Watson, R. L. A., 608c
 Watters, W. A., 366c
 Webb, J. S., 485c
 Webb, R. W., 600c
 Weber, F. H., 600c
 Websky, M., 487c

 Webster, R., 193c, 208, 212, 214, 217, 218, 219,
 233c, 313, 322c, 435c, 455c, 625c
 Weeks, M. E., 59c, 163, 180c
 Wegener, C. F., 367c
 Weir, E., 322c
 Weisbach, K., 376, 377c
 Weiss, L., 377c
 Welling, A. H., 581c
 Wemlinger, C. A., 585c
 Wenden, H. E., 554c
 West, J., 59c, 159, 160, 161, 180c, 193c
 Westley, H., 592c
 Wheeler, R. E. M., 152c
 Whitlock, H. P., 562c
 Whitney, R. J., 554c
 Wickersheim, K. A., 165, 181c
 Wiener, L., 613, 614, 625c
 Wiik, F. J., 180c, 203, 205c, 265, 278c
 Wild, G. O., 209, 211, 212, 216, 217, 225, 233c,
 234c
 Wiles, J. W., 608c
 Wilke, K. T., 300, 322c
 Wilkerson, A. S., 562c
 Wilkinson, J. G., 21c, 548c
 Willems, J. D., 337c
 Williams, N. C., 589c
 Williams, S. A., 592c
 Williamson, D. R., 584c
 Willman, L. D., 576c
 Wilson, P. T., 506c
 Wilson, S. R., 585c
 Wilson, W., 299, 323c
 Wilson, W. F., 572c
 Wilson, W. H., 581c
 Winchell, A. N., 205c
 Winchell, H., 205c
 Winslow, W. S., 558c
 Winspear, A. D., 155
 Winton, L. J., 367c
 Wittich, E., 481c
 Wöhler, F., 209, 233c, 435c
 Woitschach, G., 443c
 Wokittel, R., 433, 434c, 435c
 Woldrich, J. N., 437c
 Wolf, B., 153c, 435c
 Wollin, J. C., 499c
 Wood, D. L., 165, 166, 181c, 213, 214, 216, 219, 220,
 221, 222, 233c, 234c, 306, 323c, 399c, 590c
 Woodard, H. H., 554c
 Woodward, H. P., 369, 371c
 Worst, B. G., 609c
 Wright, L. A., 587c, 600c
 Wright, W. J., 407c
 Wunder, M., 204c, 277c, 480c
 Wussow, D., 398c, 434c, 541c
 Wyart, J., 316, 322c
 Wyckoff, D., 24, 58c, 103c, 290c
 Wynn, D. W., 365c

Index

Yokoyama, K., 463c
Yoshimura, J., 463c
Young, S., 153c
Young, W. A., 585c

Zaki, M., 5, 22c, 279c, 548c
Zavaritsky, A. N., 541c
Zedlitz, O., 268, 278c
Zeitner, J. C., 565c, 572c

Zemyatchensky, P. A., 541c
Zepharovich, V. von, 377c, 437c, 460c
Zerfass, 308
Zermatten, H. L. J., 178, 183c
Ziegler, V., 580c
Zimmermann, M., 176, 182c
Zodac, P., 562c
Zussman, J., 180c, 193c, 205c
Zwierlein-Diehl, E., 152c

[The text on this page is extremely faint and illegible. It appears to be a list or index of names and dates, possibly organized in two columns. The text is too light to transcribe accurately.]







(Continued from front flap)

of information into a readily accessible reference for mineralogists, geologists, mineral collectors, and gem cutters. Superbly rendered maps by the author augment the locality data.

In addition to photographs in color and black and white, the text is enhanced by line drawings and a series of unique watercolor paintings of actual crystal specimens done expressly for this book by the author.

JOHN SINKANKAS has published eleven books on mineralogy, gemology, prospecting, and lapidary art. He has written more than 100 articles for popular and scientific journals, contributing regularly to *Gems and Gemology*, *Journal of Gemmology*, *Rocks and Minerals*, *Lapidary Journal*, and *American Mineralogist*.

Since retirement from the U.S. Navy in 1961, Captain Sinkankas spent five years as research assistant in mineralogy at Scripps Institution of Oceanography, served for a time as editor of *Lapidary Journal*, and established Peri Lithon Books, ABAA, antiquarian booksellers in the earth sciences. He is a Fellow of the Mineralogical Society of America and a member of the Board of Editorial Review for *Gems and Gemology*.

With 15 years' research on beryl completed, Captain Sinkankas is working on a monumental bibliography of the world's gemological literature.

The jacket photos have been graciously provided by Harold and Erica Van Pelt and are used with their permission.

Upper:

Emerald crystal, Muzo Mine, Columbia.

© 1989 by Harold and Erica Van Pelt, Photographers.

Lower left:

Helidor Beryl crystal, Russia. Courtesy of Pala Int'l.

© 1988 by Harold and Erica Van Pelt, Photographers.

Lower center:

Beryl, var. Morganite, San Diego County, CA.

© 1981 by Harold and Erica Van Pelt, Photographers.

Lower right:

Aquamarine spray and cut stone, Afghanistan.

Courtesy of Bill Larson.

© 1987 by Harold and Erica Van Pelt, Photographers.

GEOSCIENCE PRESS
Prescott, Arizona

Partial Contents

I. History and Lore

EMERALD AND BERYL IN ANTIQUITY: Egypt, India, and ancient East and the Americas; Graeco-Roman times; Pliny's *Natural History*

EMERALD AND BERYL IN MEDIEVAL AND MODERN EUROPE: Biblical and other early lapidaries; *The Speculum Lapidum*; Agricola, Gesner, DeBoodt and Nicol; Boyle, Bruckmann, and Haüy

BERYL IN MAGIC, MYSTERY AND MEDICINE: Egyptian, Greek, Indian and early European lore; Occult properties and therapeutic uses of beryl; Fables, legends, talismans, and astrology

BERYL IN ART AND ORNAMENT: Engraved and carved beryl; Inscribed emeralds of Islam; Emerald and beryl in the world's finest museum and crown jewel collections

II. Chemical and Physical Properties

STRUCTURE AND COMPOSITION: Space group and symmetry elements; Composition, substitutions and formulas; Alterations and pseudomorphs; Decomposition and analysis; Field tests

PHYSICAL PROPERTIES: Fracture and cleavage; Hardness; Elasticity and compressibility; Thermal expansion and conductivity; Electrical and magnetic properties

OPTICAL PROPERTIES: Luster, chatoyancy and asterism; Refractive indexes; Color, dispersion, and optical anomalies

COLOR AND LUMINESCENCE: Dichroism; Color zoning; Infrared absorption, heat treatment, and irradiation

CRYSTALLOGRAPHY: Axes and symmetry; Faces and forms; Twinning and etch figures; "Shell" and deformed crystals; X-ray data

INCLUSIONS: Historical notes; Protogenetic, epigenetic, syngentic and solid inclusions

ARTIFICIAL AND SYNTHETIC BERYLS: Glass and other imitations; Composite gems; Simple fusion, flux-fusion, and hydrothermal synthesis; Properties of synthetic emerald

CUTTING AND POLISHING BERYL: Lapidary features; Rough selection; Immersion fluids; Cabochons, carvings and faceted gems

BERYL DEPOSITS: Characteristics of volcanic, early and late magmatic, metamorphic-hydrothermal, hydrothermal and sedimentary deposits

III. Beryl Localities

WORLD SOURCES OF ORE AND GEM BERYL: A guide to known locations of beryl deposits from Afghanistan to Zimbabwe, with notes on fine crystal specimens and unusual geological features; detailed maps

Cover design by Repro Art Service

GEOSCIENCE PRESS Prescott, Arizona

ISBN 0-945005-03-2