

# **Differences Between US Standards and Other Standards**

**Alex Krulikowski  
Scott DeRaad**

**Alex Krulikowski  
General Motors Corporation  
Westland, Michigan**

*A Standards manager at General Motors and a member of SME and AQC, Mr. Krulikowski has written articles for several magazines and speaks frequently at public seminars and in-house training programs. He has written 12 books on dimensioning and tolerancing, produced videotapes, computer based training, and other instructional materials. He serves on several corporate and national committees on dimensioning and tolerancing.*

**Scott DeRaad  
General Motors Corporation  
Ann Arbor, Michigan**

*A co-author of *Quick Comparison of Dimensioning Standards - 1997 Edition*, Mr. DeRaad is an instructor of the ASME Y14.5M-1994 GD&T standard with international teaching experience. He is an automotive automatic transmission design and development engineer for GM Powertrain. Mr. DeRaad is a cum laude graduate of the University of Michigan holding a B.S.E. Engineering-Physics.*

## **6.1 Dimensioning Standards**

Dimensioning standards play a critical role in the creation and interpretation of engineering drawings. They provide a uniform set of symbols, definitions, rules, and conventions for dimensioning. Without standards, drawings would not be able to consistently communicate the design intent. A symbol or note

## 6-2 Chapter Six

could be interpreted differently by each person reading the drawing. It is very important that the drawing user understands which standards apply to a drawing before interpreting the drawing.

Most dimensioning standards used in industry are based on either the American Society of Mechanical Engineers (ASME) or International Organization for Standardization (ISO) standards. Although these two standards have emerged as the primary dimensioning standards, there are also several other standards worldwide that are in use to a lesser degree. There is increasing pressure to migrate toward a common international standard as the world evolves toward a global marketplace. (Reference 5)

This chapter introduces the various standards, briefly describes their contents, provides an overview of the originating bodies, and compares the Y14.5M-1994 and ISO dimensioning standards.

### 6.1.1 US Standards

In the United States, the most common standard for dimensioning is ASME Y14.5M-1994. The ASME standards are established by the American Society of Mechanical Engineers, which publishes hundreds of standards on various topics. A list of the ASME standards that are related to dimensioning is shown in Table 6-1.

**Table 6-1** ASME standards that are related to dimensioning

<b>STD Number</b>	<b>Title</b>	<b>STD Date</b>
Y14.5M	Dimensioning and Tolerancing	1994
Y14.5.1M	Mathematical Definition of Dimensioning and Tolerancing Principles	1994
Y14.8M	Castings and Forgings	1996
Y14.32.1	Chassis Dimensioning Practices	1994

The ASME Y14.5M-1994 Dimensioning and Tolerancing Standard covers all the topics of dimensioning and tolerancing. The Y14.5 standard is 232 pages long and is updated about once every ten years. The other Y14 standards in Table 6-1 are ASME standards that provide terminology and examples for the interpretation of dimensioning and tolerancing of specific applications.

Subcommittees of ASME create ASME standards. Each subcommittee consists of representatives from industry, government organizations, academia, and consultants. There are typically 8 to 25 members on a subcommittee. Once the subcommittee creates a draft of a standard, it goes through an approval process that includes a public review. (Reference 5)

### 6.1.2 International Standards

Outside the United States, the most common standards for dimensioning are established by the International Organization for Standardization (ISO). ISO is a worldwide federation of 40 to 50 national standards bodies (ISO member countries). The ISO federation publishes hundreds of standards on various topics. A list of the ISO standards that are related to dimensioning is shown in Table 6-2.

**Table 6-2** ISO standards that are related to dimensioning

<b>STD Number</b>	<b>Title</b>	<b>STD Date</b>
128	Technical Drawings - General principles of presentation	1982
129	Technical Drawings - Dimensioning - General principles, definitions, methods of execution and special indications	1985
406	Technical Drawings - Tolerancing of linear and angular dimensions	1987
1101	Technical drawings - Geometrical tolerancing - Tolerances of form, orientation, location and runout - Generalities, definitions, symbols, indications on drawings	1983
1660	Technical drawings - Dimensioning and tolerancing of profiles	1987
2692	Technical drawings - Geometrical tolerancing - Maximum material principle	1988
2768-1	General tolerances - Part 1: Tolerances for linear and angular dimensions without individual tolerance indications	1989
2768-2	General tolerances - Part 2: Tolerances for features without individual tolerance indications	1989
2692	Amendment 1: Least material requirement	1992
3040	Technical drawings - Dimensioning and tolerancing - Cones	1990
5458	Technical drawings - Geometrical tolerancing - Positional tolerancing	1987
5459	Technical drawings - Geometrical tolerancing - Datums and datum system for geometrical tolerances	1981
7083	Technical drawings - Symbols for geometrical tolerancing - Proportions and dimensions	1983
8015	Technical drawings - Fundamental tolerancing principle	1985
10209-1	Technical product documentation vocabulary - Part 1: Terms relating to technical drawings - General and types of drawings	1992
10578	Technical drawings - Tolerancing of orientation and location - Projected tolerance zone	1992
10579	Technical drawings - Dimensioning and tolerancing - Non-rigid parts	1993
13715	Technical drawings - Corners of undefined shape - Vocabulary and indication on drawings	1997

The ISO standards divide dimensioning and tolerancing into topic subsets. A separate ISO standard covers each dimensioning topic. The standards are typically short, approximately 10 to 20 pages in length. When using the ISO standards for dimensioning and tolerancing, it takes 15 to 20 standards to cover all the topics involved.

The work of preparing international standards is normally carried out through ISO technical committees. Each country interested in a subject for which a technical committee has been established has the right to be represented on that committee. International organizations, governmental and nongovernmental, in liaison with ISO, also take part in the work. The ISO standards are an agreement of major points among countries. Many companies (or countries) that use the ISO dimensioning standards also have additional dimensioning standards to supplement the ISO standards.

A Draft International Standard is prepared by the technical committee and circulated to the member countries for approval before acceptance as an international standard by the ISO Council. Draft Standards are approved in accordance with ISO procedures requiring at least 75% approval by the member countries voting. Each member country has one vote. (Reference 5)

### 6.1.2.1 ISO Geometrical Product Specification Masterplan

Many of the ISO standards that are related to dimensioning contain duplications, contradictions and gaps in the definition of particular topics. For instance, Tolerance of Position is described in at least four ISO standards (#1101, 2692, 5458, 10578).

The ISO technical report (#TR 14638), *Geometrical Product Specification (GPS) - Masterplan*, was published in 1995 as a guideline for the organization of the ISO standards and the proper usage of the standards at the appropriate stage in product development. The report contains a matrix model that defines the relationship among standards for particular geometric characteristics (e.g., size, distance, datums, and orientation) in the context of the product development process. The product development process is defined as a chain of six links (Chain Link 1-6) that progresses through design, manufacturing, inspection and quality assurance for each geometric characteristic. The intent of the matrix model is to ensure a common understanding and eliminate any ambiguity between standards. The general organization of the matrix model is shown in Table 6-3. (Reference 3)

**Table 6-3** Organization of the matrix model from ISO technical report (#TR 14638)

<b>The Fundamental GPS Standards</b>	<b>The Global GPS Standards</b>  GPS standards or related standards that deal with or influence several or all General GPS chains of standards.
	<b>General GPS Matrix</b>  18 General GPS Chains of Standards
	<b>Complementary GPS Matrix</b>  Complementary GPS Chains of Standards  A. Process Specific Tolerance Standards  B. Machine Element Geometry Standards

## 6.2 Comparison of ASME and ISO Standards

Most worldwide dimensioning standards used in industry are based on either the ASME or ISO dimensioning standards. These two standards have emerged as the primary dimensioning standards. In the United States, the ASME standard is used in an estimated 90% of major corporations.

The ASME and ISO standards organizations are continually making revisions that bring the two standards closer together. Currently the ASME and ISO dimensioning standards are 60 to 70% common. It is predicted that in the next five years the two standards will be 80 to 90% common. Some industry experts predict that the two dimensioning standards will be merged into a single common standard sometime in the future. (Reference 5)

### 6.2.1 Organization and Logistics

An area of difference between ASME and ISO standards is in the organization and logistics of documentation. With regards to the approach to dimensioning in the ASME and ISO standards, the ASME standard uses product function as the primary basis for establishing tolerances. This is supported with numerous illustrated examples of tolerancing applications throughout the ASME standard. The ISO dimensioning standard is more theoretical in its explanation of tolerancing. It contains a limited number of generic examples that explain the interpretation of tolerances, with functional application a lesser consideration. Table 6-4 summarizes the differences between standards. (Reference 5)

**Table 6-4** Differences between ASME and ISO standards

Item	ASME Y14.5M-1994	ISO
Approach to dimensioning	Functional	Theoretical
Level of explanation	Thorough explanation and complementary illustrations	Minimal explanations, select examples
Number of standards	Single standard	Multiple Standards (15-20 separate publications)
Revision frequency	About every ten years	Select individual standards change yearly
Cost of standards	Less than \$100 USD	\$700 - \$1000 USD

### 6.2.2 Number of Standards

The ASME and ISO organizations have a significantly different approach to documenting dimensioning and tolerancing standards. ASME publishes a single standard that explains all dimensioning and tolerancing topics. ISO publishes multiple standards on subsets of dimensioning and tolerancing topics. The relative advantages and disadvantages of each approach are presented in Table 6-5. (Reference 5)

### 6.2.3 Interpretation and Application

The differences in drawing interpretation and application as defined by the ASME and ISO standards are important to the user of dimensioning and tolerancing standards. Differences between the two standards, summarized in Tables 6-6 through 6-13, are organized into the following eight categories:

1. General: Tables 6-6 A through 6-6 F
2. Form: Tables 6-7 A through 6-7 B
3. Datums: Tables 6-8 A through 6-8 D
4. Orientation: Tables 6-9
5. Tolerance of Position: Tables 6-10 A through 6-10 D
6. Symmetry: Table 6-11
7. Concentricity: Table 6-12
8. Profile: Tables 6-13 A through 6-13 B

**Table 6-5** Advantages and disadvantages of the number of ASME and ISO standards

Standard	Advantages	Disadvantages
ASME Y14.5M-1994 <i>Single Standard</i>	All the information on dimensioning and tolerancing is contained in one document.	A larger document takes more time to create and revise than does a shorter document.
	Relatively infrequent revisions allow industry to thoroughly integrate the standard into the workforce.	If an error is in the document, it will be around for a long time.
	Ensures that the terms and concepts are at the same revision level at the time of publication.	
	Easy to specify and understand which standards apply to a drawing for dimensioning and tolerancing.	
ISO <i>Multiple Standards</i>	Shorter documents can be created and revised in less time than a longer document.	Industry needs adequate time to integrate new standards into the workforce. Training, software development, and multiple standards all require time to address.
	Additional topics can be added without revising all the existing standards.	New or revised standards may introduce terms or concepts that conflict with other existing standards.
		Multiple standards have multiple revision dates.
		Can be difficult to determine which standards apply to a drawing.  One belief is the ISO standards that are in effect on the date of the drawing are the versions that apply to the drawing. This method is indirect, and many drawing users do not know which standards are in effect for a given date.

Differences include those of interpretation, items or allowances in one standard that are not allowed in the other, differences in terminology and drawing conventions.

### 6.2.3.1 ASME

The ASME standard referenced in Tables 6-6 through 6-13 is ASME Y14.5M-1994. The number in the parentheses represents the paragraph number from Y14.5M-1994. For example, (3.3.11) refers to paragraph 3.3.11 in ASME Y14.5M-1994.

### 6.2.3.2 ISO

The ISO standards referenced in Tables 6-6 through 6-13 are:







ISO 1101-1983	ISO 8015-1985	ISO 10578-1992	ISO 1660-1987
ISO 5458-1987	ISO 10579-1993	ISO 2692-1988	ISO 5460-1985
ISO 129-1985	ISO 2768-1989	ISO 5459-1981	

The numbers in the parentheses represent the standard and paragraph number. For example, (#1101.14.6) refers to ISO 1101, paragraph 14.6.

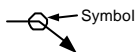
Table 6-6A General

# General

Reprinted by permission of Effective Training Inc.

Concept / Term	ASME Y14.5M-1994		ISO	
	SYMBOL OR EXAMPLE		SYMBOL OR EXAMPLE	
All around	 Symbol	Symbolic means of indicating that a tolerance applies to surfaces all around the part in the view shown. (3.3.18)	None	Use a note
Basic dimension		Basic dimension (1.3.9)		Theoretically exact dimension (#1101,10)
Between		Symbolic means of indicating that a tolerance applies to a limited segment of a surface between designated extremities. (3.3.11)	None	Use a note
Controlled radius	CR	Tolerance zone defined by two arcs ( the minimum and maximum radii) that are tangent to the adjacent surfaces. The part contour must be a fair curve without reversals. Radii taken at all points on the part contour must be within size limits. (2.15.2)	None	Use a note
Counterbore / Spotface		Symbolic means of indicating a counterbore or spotface. The symbol precedes, with no space, the dimension of the counterbore or spotface. (3.3.12)	None	Use a note
Countersink		Symbolic means of indicating a countersink. The symbol precedes, with no space, the dimension of the countersink. (3.3.13)	None	Dimensioned by showing either the required diametral dimension at the surface and the included angle, or the depth and the included angle. (#129, 6.4.2)

# General

Reprinted by permission of Effective Training Inc.





Concept / Term	ASME Y14.5M-1994		ISO	
	SYMBOL OR EXAMPLE		SYMBOL OR EXAMPLE	
Depth / Deep		Symbolic means of indicating that a dimension applies to the depth of a feature. (3.3.14)	None	Use a note
Diameter symbol usage		Diameter symbol precedes all diametral values. (1.8.1)		Diameter symbol may be omitted where the shape is clearly defined. (#129, 4.4.4)
Extension (Projection) lines		Extension lines start with a short visible gap from the outline of the part (1.7.2)		Extension lines start from the outline of the part without any gap. (#129,4.2)
Feature control frame		Feature control frame (3.4)		Tolerance frame (#1101, 5.1)
Feature control frame placement		Feature: leader line drawn to the surface of the tolerated feature. (6.4.1.1.1)		Feature: Tolerance frame connection to the tolerated feature by a leader line drawn to tolerated feature or extension of the feature outline. (#1101,6)
		Feature of size: (To control axis or median plane) feature control frame is associated with the feature of size dimension. (6.4.1.1.2)		Feature of size: (To control axis or median plane) Tolerance frame connection to the tolerated feature as an extension of a dimension line. (#1101,6)
Feature control frame placement		Common nominal axis or median plane: Each individual feature of size is tolerated separately.  Note: Direction of arrow of leader line is not important.		Common nominal axis or median plane: Tolerance applies to the axis or median plane of all features common to the tolerated axis or median plane.  Note: Direction of arrow of leader line defines the direction of the tolerance zone width. (#1101, 7)



Table 6-6C General

# General

Reprinted by permission of Effective Training Inc.

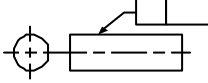
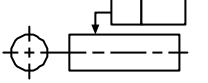
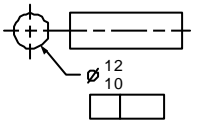
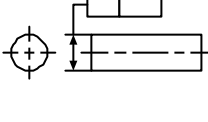
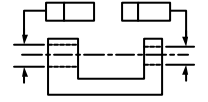
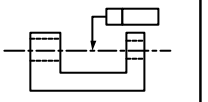
Concept / Term	ASME Y14.5M-1994		ISO	
	SYMBOL OR EXAMPLE		SYMBOL OR EXAMPLE	
<b>General tolerances</b>		General tolerances are not covered in Y14.5.	ISO 2768-(*)  * M, F, C, V	When the note "ISO-2768-(*)" appears on a drawing a set of general tolerances are invoked for linear and angular dimensions without individual tolerances shown. (#2768,4,5)  Unless otherwise stated, workpieces exceeding the general tolerance shall not lead to automatic rejection provided that the ability of the workpiece to function is not impaired. (#2768,6)  * A letter is shown to denote which set of tolerances apply from the standard.
<b>Non-rigid part</b>	None	Non-rigid parts do not require a designation. (6.8)  Restraint note may be used for measurement of tolerances. (6.8.2)  "AVG" denotes average diameter for a form control verified in the free state. (6.8.3)  A $\text{\textcircled{F}}$ free state symbol may be used to denote a tolerance is checked in the free state (6.8.1)	ISO 10579-NR	Non-rigid parts shall include the following indications as appropriate: A. "ISO 10579-NR" designation in or near the title block. B. In a note, the conditions under which the part shall be restrained to meet the drawing requirements. C. Geometric variations allowed in the free state (by using $\text{\textcircled{F}}$ ) D. The conditions under which the geometric tolerances in this free state are achieved, such as direction of gravity, orientation of the part, etc.
<b>Numerical notation</b>	X.X	Decimal point (.) separates the whole number from the decimal fraction (1.6.3)	X,X	Comma (,) separates the whole number from the decimal fraction.

Table 6-6D General

# General

Reprinted by permission of Effective Training Inc.

Concept / Term	ASME Y14.5M-1994		ISO	
	SYMBOL OR EXAMPLE		SYMBOL OR EXAMPLE	
<b>Radius</b>	R	A radius is any straight line extending from the center to the periphery of a circle or sphere (2.15)  Flats and reversals are allowed on the surface of a radius.	R	No formal definition in ISO standards.
<b>Reference dimension</b>	( )	Reference dimension (1.3.10)	( )	Auxiliary dimension (#129,3.1.1.3)
<b>Regardless of feature size (RFS)</b>	None Default per Rule #1	Rule #2, All applicable geometric tolerances: RFS applies, with respect to the individual tolerance, datum reference, or both, where no modifying symbol is specified. (by default) (2.8)	None Default	RFS by default (no exceptions) (#8015,5.2)
		Rule #2a, For a tolerance of position, RFS may be specified on the drawing with respect to the individual tolerance, datum reference, or both, as applicable. (2.8)		
<b>Screw threads</b>	None	Pitch diameter rule: Each tolerance of orientation or position and datum reference specified for a screw thread applies to the axis of the thread derived from the pitch cylinder. (2.9, 2.10, 4.5.9)	None	None

Table 6-6E General

# General

Reprinted by permission of Effective Training Inc.





Concept / Term	ASME Y14.5M-1994		ISO	
	SYMBOL OR EXAMPLE		SYMBOL OR EXAMPLE	
<b>Size / form control</b>	None Default per Rule #1	Rule #1 (Taylor Principle): Controls both size and form simultaneously. The surface or surfaces of a feature shall not extend beyond a boundary (envelope) of perfect form at MMC. Exceptions: stock, such as bars, sheets, tubing, etc. produced to established standards; parts subject to free state variation in the unrestrained condition. Rule #1 holds for all engineering drawings specifying ANSI/ASME standards unless explicitly stated that Rule #1 is not required (2.7.1 - 2.7.2)		Principle of Independency: (ISO Default) Size control only - no form control. Form tolerance is additive to size tolerance. (#8015,4) Envelope Principle: Optional ISO specification with note/symbol equals ASME Rule #1. Envelope principle can be invoked for entire engineering drawings by stating such in a general note or title block; envelope principle can be applied to individual dimensions with the application of the appropriate symbol: an encircled capital letter (E). (#8015,6)
<b>Square symbol usage</b>		Symbol precedes the dimension with no space. (3.3.15)		Square symbol may be omitted where the shape is clearly defined. (#129, 4.4.4)
<b>Statistical tolerance</b>		Assigning of tolerances to related components of an assembly on the basis of sound statistics. (2.16) Symbolic means of indicating that a tolerance is based on statistical tolerancing. An additional note is required on the drawing referencing SPC. (3.3.10)	None	None

Table 6-6F General

# General

Reprinted by permission of Effective Training Inc.

Concept / Term	ASME Y14.5M-1994		ISO	
	SYMBOL OR EXAMPLE		SYMBOL OR EXAMPLE	
Tangent plane modifier		Where it is desired to control a feature surface established by the contacting points of that surface, the tangent plane symbol is added in the feature control frame after the stated tolerance. (6.6.1.3)	None	None
Tolerance zones	 <p>Part</p> <p>Tolerance zone</p>	The direction of the width of the tolerance zone is <u>always</u> normal to the nominal geometry of the part.		<p>The width of the tolerance zone is in the direction of the arrow of the leader line joining the tolerance frame to the tolerated feature, unless the tolerance value is preceded by the sign <math>\varnothing</math>. (#1101, 7.1)</p> <p>The <u>default</u> direction of the width of the tolerance zone is always normal to the nominal geometry of the part. The direction and width of the tolerance zone can be specified (#1101, 7.2-7.3)</p>
View projection		Third angle projection (1.2)		First angle projection (#128)

Table 6-7A Form

# Form

Reprinted by permission of Effective Training Inc.

Concept / Term	ASME Y14.5M-1994		ISO	
	SYMBOL OR EXAMPLE		SYMBOL OR EXAMPLE	
Flatness		<p>Flatness can only be applied to a single surface. (6.4.2)</p> <p>(Profile is used to control flatness / coplanarity of multiple surfaces (6.5.6.1))</p>		<p>Flatness can be applied to a single surface or flatness can have a single tolerance frame applied to multiple surfaces simultaneously. (#1101, 7.4)</p>
				<p>Flatness can have a single tolerance frame with tolerated feature indicators. (#1101, 7.4)</p>
				<p>Use of COMMON ZONE above the tolerance frame is used to indicate that a common tolerance zone is applied to several separate features. (#1101, 7.5)</p>
				

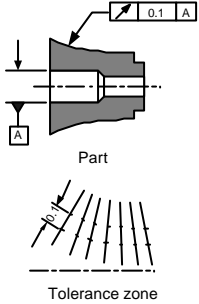
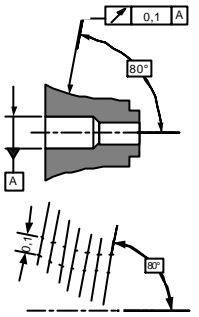
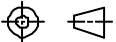
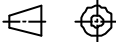
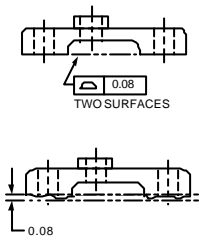
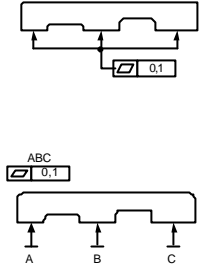
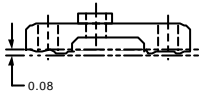
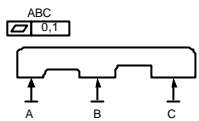
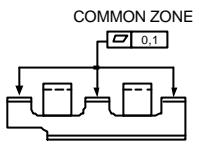
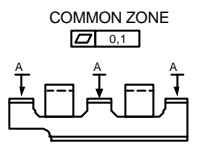
# Form

Reprinted by permission of Effective Training Inc.

Concept / Term	ASME Y14.5M-1994		ISO	
	SYMBOL OR EXAMPLE		SYMBOL OR EXAMPLE	
Form qualifying notes		No examples shown	 NOT CONVEX   NOT CONVEX	NOT CONVEX / NOT CONCAVE: Indications qualifying the form of the feature within the tolerance zone shall be written near the tolerance frame and may be connected by a leader line (#1101, 5.3)
Restrictive tolerance		Only allowed for geometrical tolerances without datum references. Straightness (6.4.1.1.4)  Flatness (6.4.2.1.1)		If a smaller tolerance of the same type is added to the tolerance on the whole feature, but restricted over a limited length, the restrictive tolerance shall be indicated in the lower compartment. (#1101,9.2)  Restrictive tolerances are <u>allowed</u> for geometrical tolerances <u>with</u> datum references.
Straightness applied to a planar feature of size		Straightness can be applied to a planar feature of size. The tolerance zone is two parallel planes. Each line element of the centerplane of the toleranced feature of size must lie within the tolerance zone. (6.4.1.1)	None	None

Table 6-8A Datums

# Datums

Reprinted by permission of Effective Training Inc.

Concept / Term	ASME Y14.5M-1994		ISO	
	SYMBOL OR EXAMPLE		SYMBOL OR EXAMPLE	
Centerpoint of a circle as a datum	None	None		A line element of the cylinder is used as the datum. (#5460, 5.3.1)
Common axis formed by two features		A single datum axis may be established by two coaxial diameters. Each diameter is designated as a datum feature and the datum axis applies when they are referenced as co-datums (A-B). (4.5.7.2)		A common axis can be formed by two features by placing the datum symbol on the centerline of the features. (#1101, 8.2)  (The Y14.5 method shown may also be used.)

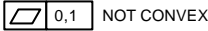
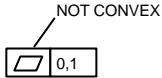
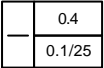
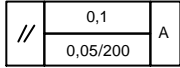
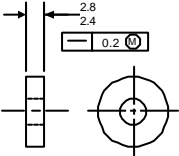
Table 6-8B Datums

# Datums

Reprinted by permission of Effective Training Inc.

Concept / Term	ASME Y14.5M-1994		ISO	
	SYMBOL OR EXAMPLE		SYMBOL OR EXAMPLE	
Datum axis	 <p>Diagram showing a datum symbol (a circle with a crosshair) placed on the extension line of a feature of size. The feature is a cylinder with diameter <math>\varnothing X.X</math>. The datum symbol is labeled 'A'.</p>	<p>Datum symbol is placed on the extension line of a feature of size.</p>	 <p>Diagram showing a datum symbol (a circle with a crosshair) placed on the centerline of a feature of size. The feature is a cylinder with diameter <math>\varnothing X</math>. The datum symbol is labeled 'A'.</p>	<p>Datum symbol is placed on the centerline of a feature of size.</p>
	 <p>Diagram showing a datum symbol (a circle with a crosshair) placed on the outline of a cylindrical feature surface or an extension line of the feature outline, separated from the size dimension. The feature is a cylinder with diameter <math>\varnothing X.X</math>. The datum symbol is labeled 'A'.</p>	<p>OR</p> <p>Placed on the outline of a cylindrical feature surface or an extension line of the feature outline, separated from the size dimension.</p>	 <p>Diagram showing a datum symbol (a circle with a crosshair) placed on the outline of a cylindrical feature surface or an extension line of the feature outline, separated from the size dimension. The feature is a cylinder with diameter <math>\varnothing X</math>. The datum symbol is labeled 'A'.</p>	<p>OR</p> <p>Placed on the outline of a cylindrical feature surface or an extension line of the feature outline, separated from the size dimension.</p>
	 <p>Diagram showing a datum symbol (a circle with a crosshair) placed on a dimension leader line to the feature of size dimension where no geometrical tolerance is used. The feature is a cylinder with diameter <math>\varnothing X.X</math>. The datum symbol is labeled 'A'.</p>	<p>OR</p> <p>Placed on a dimension leader line to the feature of size dimension where no geometrical tolerance is used.</p>		
	 <p>Diagram showing a datum symbol (a circle with a crosshair) attached above or below the feature control frame for a feature or group of features. The feature is a cylinder with diameter <math>\varnothing X.X</math>. The datum symbol is labeled 'A'.</p>	<p>OR</p> <p>Attached above or below the feature control frame for a feature or group of features.</p>		
	 <p>Diagram showing a datum symbol (a circle with a crosshair) placed within the feature control frame for a feature or group of features. The feature is a cylinder with diameter <math>\varnothing 0.1</math>. The datum symbol is labeled 'A'.</p>			

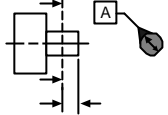
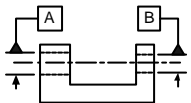
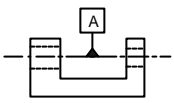

Table 6-8C Datums

# Datums

Reprinted by permission of Effective Training Inc.

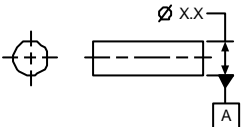
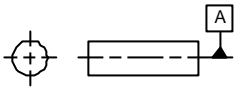
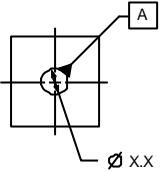
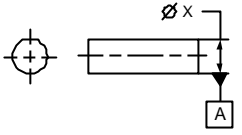
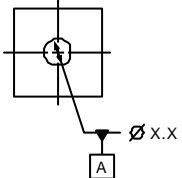
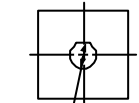
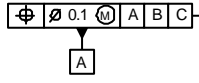



Concept / Term	ASME Y14.5M-1994		ISO	
	SYMBOL OR EXAMPLE		SYMBOL OR EXAMPLE	
Datum letter specified / implied		Datum letter must be specified. (3.3.2)		If the tolerance frame can be directly connected with the datum feature by a leader line, the datum letter may be omitted. (#1101, 8.3)
Datum sequence		Primary, Secondary, or Tertiary must be specified. (4.4)		Primary, Secondary, Tertiary Ambiguous order allowed when datum sequence not important. (#1101, 8.4)
Datum target line		Phantom line on direct view. Target point symbol on edge view. Both applications can be used in conjunction for clarity. (4.6.1.2)		Target point symbol on edge view. Two crosses connected by a thin continuous line (direct view). (#5459, 7.1.2)
Generating line as a datum	None	None		A line element of the cylinder is used as the datum. (#5460, 5.3.1)
Mathematically defined surface as a datum	None	Any compound geometry that can be mathematically defined and related to a three plane datum reference frame. (4.5.10.1)	None	None

Table 6-8D Datums

# Datums

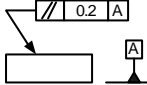
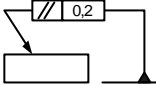
Reprinted by permission of Effective Training Inc.

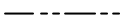
Concept / Term	ASME Y14.5M-1994		ISO	
	SYMBOL OR EXAMPLE		SYMBOL OR EXAMPLE	
Median plane	 <p>Datum symbol placed on the extension line of a feature of size.</p>	OR	 <p>Datum symbol is placed on the median plane. (#1101, 8.2)</p>	OR
	 <p>Placed on a dimension leader line to the feature of size dimension where no geometrical tolerance is used.</p>		 <p>Placed on the extension line of a feature of size. (#1101, 8.2)</p>	
	 <p>Attached above or below the feature control frame for a feature or group of features. (3.3.2)</p>		 <p>Attached to the tolerance frame for a group of features as the datum. (#5459, 9)</p>	
Virtual condition datum		In Y14.5, the virtual condition of the datum axes includes the geometrical tolerance at MMC by default even though the MMC symbol is not explicitly applied. (4.5.4)		ISO practices that the datum axes should be interpreted as specified. Therefore if the virtual condition of the datum axes is to include the affect of the geometrical tolerance at MMC, the symbol must be explicitly applied to the tolerance.

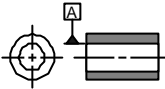
Table 6-9 Orientation

# Orientation

Reprinted by permission of Effective Training Inc.

Concept / Term	ASME Y14.5M-1994		ISO	
	SYMBOL OR EXAMPLE		SYMBOL OR EXAMPLE	
Angular tolerances		Angular tolerance controls both the general orientation of lines or line elements of surfaces and their form. All points of the actual lines or surface must lie within the tolerance zone defined by the angular tolerance. (2.12)		Angular tolerance controls only the general orientation of line elements of surfaces but not their form. The general orientation of the line derived from the actual surface is the orientation of the contacting line of ideal geometrical form. The maximum distance between the contacting line and the actual line shall be the least possible. (#8015, 5.1.2)
		All surface elements must be within the tolerance zone. (2.12)		Plane formed by the high points of the surface must be within the tolerance zone. (#8015, 5.1.2)

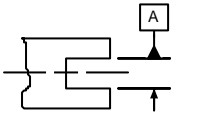
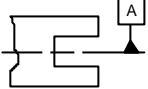
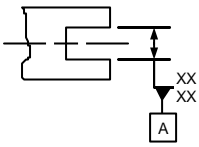
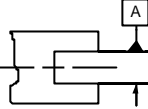
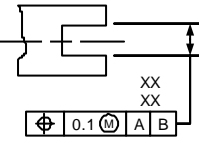
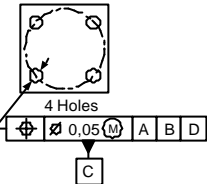
Table 6-10A Tolerance of Position

# Tolerance of Position

Reprinted by permission of Effective Training Inc.

Concept / Term	ASME Y14.5M-1994		ISO	
	SYMBOL OR EXAMPLE		SYMBOL OR EXAMPLE	
<b>Composite positional tolerance</b>		<p>A composite application of positional tolerancing for the location of feature patterns as well as the interrelation (position and orientation) of features within these patterns. (5.4.1)</p> <p>The upper segment controls the location of the toleranced pattern. The lower segment controls the orientation and spacing within the pattern.</p>		<p>When a tolerance frame is as shown, it is interpreted as two separate requirements.</p>
<b>Extremities of long holes</b>	<p>8X <math>\varnothing</math> 12.8 12.5</p>  <p>AT SURFACE C</p>  <p>AT SURFACE D</p>	<p>Different positional tolerances may be specified for the extremities of long holes; this establishes a conical rather than a cylindrical tolerance zone.</p>	<p>None</p>	<p>None</p>
<b>Flat surface</b>	<p>None</p>	<p>None</p>		<p>Tolerance zone is limited by two parallel planes 0,05 apart and disposed symmetrically with respect to the theoretically exact position of the considered surface. (#1101, 14.10)</p>

Table 6-10B Tolerance of Position

# Tolerance of Position

Reprinted by permission of Effective Training Inc.

Concept / Term	ASME Y14.5M-1994		ISO	
	SYMBOL OR EXAMPLE		SYMBOL OR EXAMPLE	
Line	None	None		Tolerance zone is limited by two parallel straight lines 0,05 apart and disposed symmetrically with respect to the theoretically exact position of the considered line if the tolerance is specified only in one direction (#1101, 14.10)
Point		<p>Only when applied to control a spherical feature. (5.2)</p> <p>Spherical tolerance zone. (5.15)</p>		Tolerance zone is limited by two parallel straight lines 0,3 apart and disposed symmetrically with respect to the theoretically exact position of the considered line if the tolerance is specified only in one direction (#1101, 14.10)
Projected tolerance zone		<p>The projected tolerance zone symbol is placed in the feature control frame along with the dimension indicating the minimum height of the tolerance zone. (3.4.7)</p> <p>For clarification, the projected tolerance zone symbol may be shown in the feature control frame and a zone height dimension indicated with a chain line on a drawing view. The height dimension may then be omitted from the feature control frame. (2.4.7)</p>		The projected tolerance zone is indicated on a drawing view with the $\text{P}$ symbol followed by the projected dimension: represented by a chain thin double-dashed line in the corresponding drawing view, and indicated in the tolerance frame by the symbol $\text{P}$ placed after the tolerance value. (#1101,11;#10578,4)

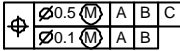
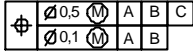
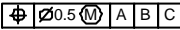
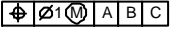
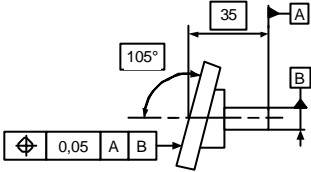
Table 6-10C Tolerance of Position

# Tolerance of Position

Reprinted by permission of Effective Training Inc.

Concept / Term	ASME Y14.5M-1994		ISO	
	SYMBOL OR EXAMPLE		SYMBOL OR EXAMPLE	
Simultaneous gaging requirement		<p>Where two or more features or patterns of features are located by basic dimensions related to common datum features referenced in the same order of precedence and the same material condition, as applicable, they are considered as a composite pattern with the geometric tolerances applied simultaneously (4.5.12)</p>		<p>Groups of features shown on same axis to be a single pattern (example has same datum references) (#5458, 3.4)</p>
			<p>Angular location optional</p>	

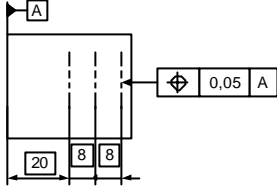
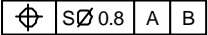
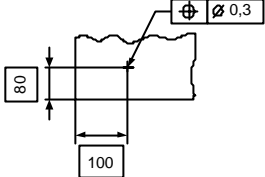
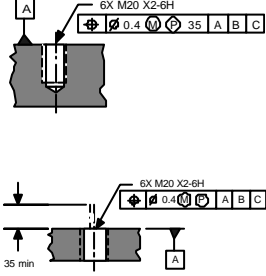
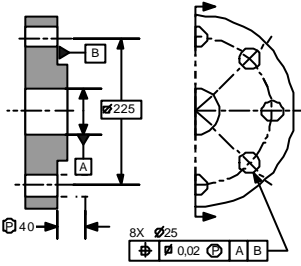
Table 6-10D Tolerance of Position

# Tolerance of Position

Reprinted by permission of Effective Training Inc.



Concept / Term	ASME Y14.5M-1994		ISO	
	SYMBOL OR EXAMPLE		SYMBOL OR EXAMPLE	
<b>Requirements for application</b>		Basic dimensions to specified datums, position symbol, tolerance value, applicable material condition modifiers, applicable datum references (5.2)		Theoretically exact dimensions locate features in relation to each other or in relation to one or more datums. (#5458, 3.2) (No chain basic of dimensions necessary to datums.)
<b>Tolerance of position for a group of features</b>	<p>None</p> 	<p>None</p> <p>Separately-specified feature-relating tolerance, using a second single-segment feature control frame is used when each requirement is to be met independently. (5.4.1)</p> <p>Do not use composite positional tolerancing method for independent requirements.</p>		<p>When the group of features is individually located by positional tolerancing and the pattern location by coordinate tolerances, each requirement shall be met independently. (#5458, 4.1)</p> <p>When the group of features is individually located by positional tolerancing and the pattern location by positional tolerancing, each requirement shall be met independently. (#5458, 4.2)</p>
<b>True position</b>	None	True position (1.3.36)	None	Theoretical exact position (#5458, 3.2)

Table 6-11 Symmetry

# Symmetry

Reprinted by permission of Effective Training Inc.

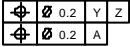
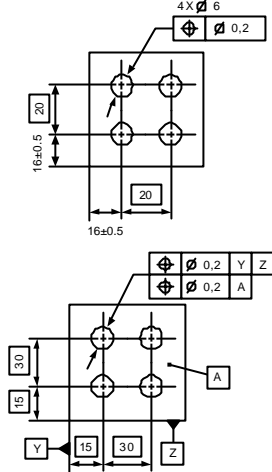

Concept / Term	ASME Y14.5M-1994		ISO	
	SYMBOL OR EXAMPLE		SYMBOL OR EXAMPLE	
Symmetry		<p>Can be applied to planar features of size. The tolerance zone is two parallel planes that control median points of opposed or correspondingly-located elements of two or more feature surfaces. (5.14)</p> <p>Symmetry tolerance and the datum reference can only apply RFS.</p>		<p>Can be applied to planar <u>or</u> diametrical features of size. (#1101, 14.12)</p> <p>The tolerance zone is two parallel planes. Controls the median plane of the tolerated feature. (#1101 14.12.1) (Equivalent to Y14.5 tolerance of position RFS)</p> <p style="text-align: center;">OR</p> <p>The tolerance zone is two parallel straight lines (when symmetry is applied to a diameter in only one direction) (#1101, 14.12.2)</p> <p style="text-align: center;">OR</p> <p>The tolerance zone is a parallelepiped (when symmetry is applied to a diameter in two directions) (#1101, 14.12.2)</p> <p>Can be applied at MMC , LMC, or RFS.</p>



Table 6-12 Concentricity

# Concentricity

Reprinted by permission of Effective Training Inc.



Concept / Term	ASME Y14.5M-1994		ISO	
	SYMBOL OR EXAMPLE		SYMBOL OR EXAMPLE	
<b>Concentricity (Y14.5)</b> <b>Coaxiality (ISO)</b>		Can be applied to a surface of revolution about a datum axis. (5.12)  Controls median points of the toleranced feature. (5.12)  Can only apply RFS		Can be applied to a surface of revolution or circular elements about a datum axis.  Controls the axis or centerpoint of the toleranced feature. (#1101, 14.11.1)  Can apply at RFS, MMC, or LMC. (#1101, 14.11.2, #2692, 8.2, #2692 Amd. 1, 4, fig B.4)

Table 6-13A Profile

# Profile

Reprinted by permission of Effective Training Inc.

Concept / Term	ASME Y14.5M-1994		ISO	
	SYMBOL OR EXAMPLE		SYMBOL OR EXAMPLE	
<b>Composite profile tolerance</b>		Application to control location of a profile feature as well as the requirement of form, orientation, and in some instances, the size of the feature within the larger profile location tolerance zone. (6.5.9.1)	None	Use a note
<b>Direction of profile tolerance zone</b>		The tolerance zone is always normal to the true profile (6.5.3)		The default direction of the width of the tolerance zone is normal to the true profile, however the direction can be specified. (#1101, 7.2 - 7.3 see <i>General: tolerance zones</i> , p.7)

Table 6-13B Profile

# Profile

Reprinted by permission of Effective Training Inc.

Concept / Term	ASME Y14.5M-1994		ISO		
	SYMBOL OR EXAMPLE		SYMBOL OR EXAMPLE		
Profile tolerance zone	 <p>Bilateral tolerance zone equal distribution</p>	<p>For profile of a surface and line, the tolerance value represents the distance between two boundaries equally or unequally disposed about the true profile or entirely disposed on one side of the profile (6.5.3)</p>		<p>For profile of a surface - the tolerance zone is limited by two surfaces enveloping spheres of diameter <math>t</math>, the centers of which are situated on a surface having the true geometric form (#1101, 14.6)</p>	
	 <p>Bilateral tolerance zone unequal distribution</p>				<p>For profile of a line - the tolerance zone is limited by two lines enveloping circles of diameter <math>t</math>, the centers of which are situated on a line having the true geometric form (#1101, 14.5)</p>
	 <p>Unilateral tolerance zone</p>				

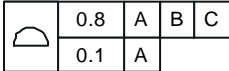
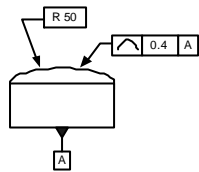
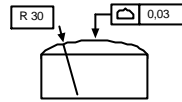
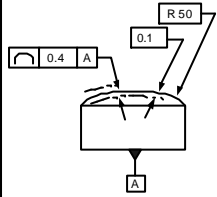
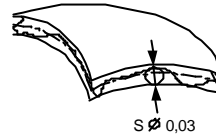
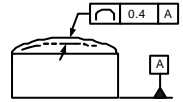
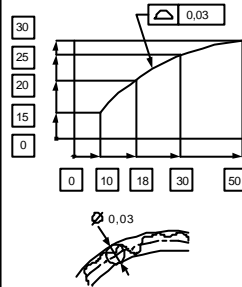
The information contained in Tables 6-6 through 6-13 is intended to be a quick reference for drawing interpretation. Many of the tables are incomplete by intent and should not be used as a basis for design criteria or part acceptance. (References 2,3,4,5,7)

**6.3 Other Standards**

Although most dimensioning standards used in industry are based on either ASME or ISO standards, there are several other dimensioning and tolerancing standards in use worldwide. These include national standards based on ISO or ASME, US government standards, and corporate standards.

**6.3.1 National Standards Based on ISO or ASME Standards**

There are more than 20 national standards bodies (Table 6-14) and three international standardizing organizations (Table 6-15) that publish technical standards. (Reference 6) Many of these groups have developed geometrical standards based on the ISO standards. For example, the German Standards (DIN) have adopted several ISO standards directly (ISO 1101, ISO 5458, ISO 5459, ISO 3040, ISO 2692, and ISO 8015), in addition to creating their own standards such as DIN 7167. (Reference 2)

**Table 6-14** A sample of the national standards bodies that exist

Country	National Standards Body
Australia	Standards Australia (SAA)
Canada	Standards Council of Canada (SCC)
Finland	Finnish Standards Association (SFS)
France	Association Française de Normalisation (AFNOR)
Germany	Deutsches Institut für Normung (DIN)
Greece	Hellenic Organization for Standardization (ELOT)
Ireland	National Standards Authority of Ireland (NSAI)
Iceland	Icelandic Council for Standardization (STRI)
Italy	Ente Nazionale Italiano di Unificazione (UNI)
Japan	Japanese Industrial Standards Committee (JISC)
Malaysia	Standards and Industrial Research of Malaysia (SIRIM)
Netherlands	Nederlands Normalisatie-instituut (NNI)
New Zealand	Standards New Zealand
Norway	Norges Standardiseringsforbund (NSF)
Portugal	Instituto Portugues da Qualidade (IPQ)
Saudi Arabia	Saudi Arabian Standards Organization (SASO)
Slovenia	Standards and Metrology Institute (SMIS)
Sweden	SIS - Standardiseringen i Sverige (SIS)
United Kingdom	British Standards Institute (BSI)
United States	American Society of Mechanical Engineers (ASME)

**Table 6-15** International standardizing organizations

Abbreviation	Organization Name
ISO	International Organization for Standardization
IEC	International Electrotechnical Commission
ITU	International Telecommunication Union

### 6.3.2 US Government Standards

The United States government is a very large organization with many suppliers. Therefore, using common standards is a critical part of being able to conduct business. The United States government creates and maintains standards for use with companies supplying parts to the government.

The Department of Defense Standard is approved for use by departments and agencies of the Department of Defense (DoD). The *Department of Defense Standard Practice for Engineering Drawing Practices* is created and maintained by the US Army Armament Research Group in Picatinny Arsenal, New Jersey. This standard is called MIL-STD-100G. The “G” is the revision level. This revision was issued on June 9, 1997. The standard is used on all government projects.

The *Department of Defense Standard Practice for Engineering Drawings Practices* (MIL-STD-100G) references ASME and other national standards to cover a topic wherever possible. The ASME Y14.5M-1994 standard is referenced for dimensioning and tolerancing of engineering drawings that reference MIL-STD-100G. (Reference 5)

The MIL-STD-100G contains a number of topics in addition to dimensioning and tolerancing:

- Standard practices for the preparation of engineering drawings, drawing format and media for delivery
- Requirements for drawings derived from or maintained by Computer Aided Design (CAD)
- Definitions and examples of types of engineering drawings to be prepared for the DoD
- Procedures for the creation of titles for engineering drawings
- Numbering, coding and identification procedures for engineering drawings, associated lists and documents referenced on these associated lists
- Locations for marking on engineering drawings
- Methods for revision of engineering drawings and methods for recording such revisions
- Requirements for preparation of associated lists

### 6.3.3 Corporate Standards

US and International standards are comprehensive documents. However, they are created as general standards to cover the needs of many industries. The standards contain information that is used by all types of industries and is presented in a way that is useful to most of industry. However, many corporations have found the need to supplement or amend the standards to make it more useful for their particular industry.

Often corporate dimensioning standards are supplements based on an existing standard (e.g., ASME, ISO) with additions or exceptions described. Typically, corporate supplements include four types of information:

- Choose an option when the standard offers several ways to specify a tolerance.
- Discourage the use of certain tolerancing specifications that may be too costly for the types of products produced in a corporation.

- Include a special dimensioning specification that is unique to the corporation.
- Clarify a concept, which is new or needs further explanation from the standard.

Often the Standards default condition for tolerances is to a more restrictive condition regardless of product function. Corporate standards can be used to revise the standards defaults to reduce cost based on product function. An example of this is the simultaneous tolerancing requirement in ASME Y14.5M-1994 (4.5.12). The rule creates simultaneous tolerancing as a default condition for geometric controls with identical datum references regardless of the product function. Simultaneous tolerancing reduces manufacturing tolerances which adds cost to produce the part. Although, in some cases it may be necessary to have this type of requirement, it is often not required by the function of the part. Some corporate dimensioning standards amend the ASME Y14.5M-1994 standard so that the simultaneous tolerancing rule is not the default condition.

Another example of a corporate standard is the Auto Industry addendum to ASME Y14.5M-1994. In 1994, representatives from General Motors, Ford and Chrysler formed a working group sanctioned by USCAR to create an Auto Industry addendum to Y14.5M-1994. The Auto Industry addendum amends the Y14.5M-1994 standard to create dimensioning conventions to be used by the auto industry.

Many corporations are moving from using corporate standards to using national or international standards. An addendum is often used to cover special needs of the corporation. The corporate dimensioning addendums are often only a few pages long, in place of several hundred pages the corporate standards used to be. (Reference 5)

### 6.3.4 Multiple Dimensioning Standards

Multiple dimensioning standards are problematic in industry for three reasons:

- Because there are several dimensioning standards used in industry, the drawing user must be cautious to understand which standards apply to each drawing. Drawing users need to be skilled in interpreting several dimensioning standards.
- The dimensioning standards appear to be similar, so differences are often subtle, but significant. Drawing users need to have the skills to recognize the differences among the various standards and how they affect the interpretation of the drawing.
- Not only are there different standards, but there are multiple revision dates for each standard. Drawing users need to be familiar with each version of a standard and how it affects the interpretation of a drawing.

There are four steps that can be taken to reduce confusion on dimensioning standards. (Reference 5)

1. Maintain or have immediate access to a library of the various dimensioning standards. This applies to both current and past versions of standards.
2. Ensure each drawing used is clearly identified for the dimensioning standards that apply.
3. Develop several employees to be fluent in the various dimensioning standards. These employees will be the company experts for drawing interpretation issues. They should also keep abreast of new developments in the standards field.
4. Train all employees who use drawings to recognize which standard applies to each drawing.

## 6.4 Future of Dimensioning Standards

As the world evolves toward a global marketplace, there is a greater need to create common dimensioning standards. The authors predict a single global dimensioning standard will evolve in the future.

Product development is becoming an international collaboration among engineers, manufacturers, and suppliers. Members of a product development team used to be located in close proximity to one another, working together to produce a product. In the global marketplace, collaborating parties geographically separated by thousands of miles, several time zones, and different languages, must effectively define and/or interpret product specifications. Therefore it is becoming important to create a common dimensioning and tolerancing standard to firmly anchor product specifications as drawings are shared and used throughout the product lifecycle.

## 6.5 Effects of Technology

Technology has infiltrated all aspects of product development, from product design and development to the inspection of manufactured parts. Computer Aided Design (CAD) helps engineers design products as well as document and check their specifications. Coordinate Measuring Machines (CMMs) help inspect geometric characteristics of parts with respect to their dimensions and tolerances while reducing the subjectivity of hand gaging.

A single dimensioning standard would effectively increase the use and accuracy of automated tools such as CAD and CMM. CAD software with automated GD&T checkers would require less maintenance by computer programmers to keep standards information current if they were able to concentrate on a single common standard.

To increase the use of automated inspection equipment such as a CMM, a more math-based dimensioning and tolerancing standard is required. Only math-based standards are defined to the degree necessary to eliminate ambiguity during the inspection process.

## 6.6 New Dimensioning Standards

One possible future for Geometric Dimensioning and Tolerancing is a new standard for defining product specifications without symbols, feature control frames, dimensions or tolerances that can be read from a blueprint. Instead, there may come a time when all current GD&T information can be incorporated into a 3-D computer model of the part. The computer model would be used directly to design, manufacture and inspect the product. An ASME subcommittee is currently working on standard Y14.41 that would define just such a standard.

## 6.7 References

1. DeRaad, Scott, and Alex Krulikowski. 1997. *Quick Comparison of Dimensioning Standards - 1997 Edition*. Wayne, Michigan: Effective Training Inc.
2. Henzold, G. 1995. *Handbook of Geometrical Tolerancing - Design, Manufacturing and Inspection*. Chichester, England: John Wiley & Sons Ltd.
3. International Standards Organization. 1981-1995. "Various GD&T Standards" International Standards Organization: Switzerland.

ISO 1101-1983	ISO 8015-1985	ISO 10578-1992
ISO 1660-1987	ISO 5458-1987	ISO 10579-1993
ISO 2692-1988	ISO 5460-1985	ISO 129-1985
ISO 2768-1989	ISO 5459-1981	ISO TR 14638-1995
4. Krulikowski, Alex. 1998. *Fundamentals of Geometric Dimensioning and Tolerancing, 2ed*. Detroit, Michigan: Delmar Publishers.

5. Krulikowski, Alex. 1998. *Advanced Concepts of GD&T*. Wayne, Michigan: Effective Training Inc.
6. Other Web Servers Providing Standards Information. June 17, 1998. In <http://www.iso.ch/infoe/stbodies.html>. Internet.
7. The American Society of Mechanical Engineers. 1995. *ASME Y14.5M-1994, Dimensioning and Tolerancing*. New York, New York: The American Society of Mechanical Engineers.