

Preface

The present volume is an outgrowth of a Conference on Mathematical Tables held at Cambridge, Mass., on September 15-16, 1954, under the auspices of the National Science Foundation and the Massachusetts Institute of Technology. The purpose of the meeting was to evaluate the need for mathematical tables in the light of the availability of large scale computing machines. It was the consensus of opinion that in spite of the increasing use of the new machines the basic need for tables would continue to exist.

Numerical tables of mathematical functions are in continual demand by scientists and engineers. A greater variety of functions and higher accuracy of tabulation are now required as a result of scientific advances and, especially, of the increasing use of automatic computers. In the latter connection, the tables serve mainly for preliminary surveys of problems before programming for machine operation. For those without easy access to machines, such tables are, of course, indispensable.

Consequently, the Conference recognized that there was a pressing need for a modernized version of the classical tables of functions of Jahnke-Emde. To implement the project, the National Science Foundation requested the National Bureau of Standards to prepare such a volume and established an Ad Hoc Advisory Committee, with Professor Philip M. Morse of the Massachusetts Institute of Technology as chairman, to advise the staff of the National Bureau of Standards during the course of its preparation. In addition to the Chairman, the Committee consisted of A. Erdélyi, M. C. Gray, N. Metropolis, J. B. Rosser, H. C. Thacher, Jr., John Todd, C. B. Tompkins, and J. W. Tukey.

The primary aim has been to include a maximum of useful information within the limits of a moderately large volume, with particular attention to the needs of scientists in all fields. An attempt has been made to cover the entire field of special functions. To carry out the goal set forth by the Ad Hoc Committee, it has been necessary to supplement the tables by including the mathematical properties that are important in computation work, as well as by providing numerical methods which demonstrate the use and extension of the tables.

The Handbook was prepared under the direction of the late Milton Abramowitz, and Irene A. Stegun. Its success has depended greatly upon the cooperation of many mathematicians. Their efforts together with the cooperation of the Ad Hoc Committee are greatly appreciated. The particular contributions of these and other individuals are acknowledged at appropriate places in the text. The sponsorship of the National Science Foundation for the preparation of the material is gratefully recognized.

It is hoped that this volume will not only meet the needs of all table users but will in many cases acquaint its users with new functions.

ALLEN V. ASTIN, *Director.*

Washington, D.C.

Preface to the Ninth Printing

The enthusiastic reception accorded the "Handbook of Mathematical Functions" is little short of unprecedented in the long history of mathematical tables that began when John Napier published his tables of logarithms in 1614. Only four and one-half years after the first copy came from the press in 1964, Myron Tribus, the Assistant Secretary of Commerce for Science and Technology, presented the 100,000th copy of the Handbook to Lee A. DuBridge, then Science Advisor to the President. Today, total distribution is approaching the 150,000 mark at a scarcely diminished rate.

The success of the Handbook has not ended our interest in the subject. On the contrary, we continue our close watch over the growing and changing world of computation and to discuss with outside experts and among ourselves the various proposals for possible extension or supplementation of the formulas, methods and tables that make up the Handbook.

In keeping with previous policy, a number of errors discovered since the last printing have been corrected. Aside from this, the mathematical tables and accompanying text are unaltered. However, some noteworthy changes have been made in Chapter 2: Physical Constants and Conversion Factors, pp. 6-8. The table on page 7 has been revised to give the values of physical constants obtained in a recent reevaluation; and pages 6 and 8 have been modified to reflect changes in definition and nomenclature of physical units and in the values adopted for the acceleration due to gravity in the revised Potsdam system.

The record of continuing acceptance of the Handbook, the praise that has come from all quarters, and the fact that it is one of the most-quoted scientific publications in recent years are evidence that the hope expressed by Dr. Astin in his Preface is being amply fulfilled.

LEWIS M. BRANSCOMB, *Director*
National Bureau of Standards

November 1970

Foreword

This volume is the result of the cooperative effort of many persons and a number of organizations. The National Bureau of Standards has long been turning out mathematical tables and has had under consideration, for at least 10 years, the production of a compendium like the present one. During a Conference on Tables, called by the NBS Applied Mathematics Division on May 15, 1952, Dr. Abramowitz of that Division mentioned preliminary plans for such an undertaking, but indicated the need for technical advice and financial support.

The Mathematics Division of the National Research Council has also had an active interest in tables; since 1943 it has published the quarterly journal, "Mathematical Tables and Aids to Computation" (MTAC), editorial supervision being exercised by a Committee of the Division.

Subsequent to the NBS Conference on Tables in 1952 the attention of the National Science Foundation was drawn to the desirability of financing activity in table production. With its support a 2-day Conference on Tables was called at the Massachusetts Institute of Technology on September 15-16, 1954, to discuss the needs for tables of various kinds. Twenty-eight persons attended, representing scientists and engineers using tables as well as table producers. This conference reached consensus on several conclusions and recommendations, which were set forth in the published Report of the Conference. There was general agreement, for example, "that the advent of high-speed computing equipment changed the task of table making but definitely did not remove the need for tables". It was also agreed that "an outstanding need is for a Handbook of Tables for the Occasional Computer, with tables of usually encountered functions and a set of formulas and tables for interpolation and other techniques useful to the occasional computer". The Report suggested that the NBS undertake the production of such a Handbook and that the NSF contribute financial assistance. The Conference elected, from its participants, the following Committee: P. M. Morse (Chairman), M. Abramowitz, J. H. Curtiss, R. W. Hamming, D. H. Lehmer, C. B. Tompkins, J. W. Tukey, to help implement these and other recommendations.

The Bureau of Standards undertook to produce the recommended tables and the National Science Foundation made funds available. To provide technical guidance to the Mathematics Division of the Bureau, which carried out the work, and to provide the NSF with independent judgments on grants for the work, the Conference Committee was reconstituted as the Committee on Revision of Mathematical Tables of the Mathematics Division of the National Research Council. This, after some changes of membership, became the Committee which is signing this Foreword. The present volume is evidence that Conferences can sometimes reach conclusions and that their recommendations sometimes get acted on.

Active work was started at the Bureau in 1956. The overall plan, the selection of authors for the various chapters, and the enthusiasm required to begin the task were contributions of Dr. Abramowitz. Since his untimely death, the effort has continued under the general direction of Irene A. Stegun. The workers at the Bureau and the members of the Committee have had many discussions about content, style and layout. Though many details have had to be argued out as they came up, the basic specifications of the volume have remained the same as were outlined by the Massachusetts Institute of Technology Conference of 1954.

The Committee wishes here to register its commendation of the magnitude and quality of the task carried out by the staff of the NBS Computing Section and their expert collaborators in planning, collecting and editing these Tables, and its appreciation of the willingness with which its various suggestions were incorporated into the plans. We hope this resulting volume will be judged by its users to be a worthy memorial to the vision and industry of its chief architect, Milton Abramowitz. We regret he did not live to see its publication.

P. M. MORSE, *Chairman.*
A. ERDÉLYI
M. C. GRAY
N. C. METROPOLIS
J. B. ROSSER
H. C. THACHER, JR.
JOHN TODD
C. B. TOMPKINS
J. W. TUKEY.

Handbook of Mathematical Functions

with

Formulas, Graphs, and Mathematical Tables

Edited by Milton Abramowitz and Irene A. Stegun

1. Introduction

The present Handbook has been designed to provide scientific investigators with a comprehensive and self-contained summary of the mathematical functions that arise in physical and engineering problems. The well-known Tables of Functions by E. Jahnke and F. Emde has been invaluable to workers in these fields in its many editions¹ during the past half-century. The present volume extends the work of these authors by giving more extensive and more accurate numerical tables, and by giving larger collections of mathematical properties of the tabulated functions. The number of functions covered has also been increased.

The classification of functions and organization of the chapters in this Handbook is similar to that of *An Index of Mathematical Tables* by A. Fletcher, J. C. P. Miller, and L. Rosenhead.² In general, the chapters contain numerical tables, graphs, polynomial or rational approximations for automatic computers, and statements of the principal mathematical properties of the tabulated functions, particularly those of computa-

tional importance. Many numerical examples are given to illustrate the use of the tables and also the computation of function values which lie outside their range. At the end of the text in each chapter there is a short bibliography giving books and papers in which proofs of the mathematical properties stated in the chapter may be found. Also listed in the bibliographies are the more important numerical tables. Comprehensive lists of tables are given in the Index mentioned above, and current information on new tables is to be found in the National Research Council quarterly *Mathematics of Computation* (formerly *Mathematical Tables and Other Aids to Computation*).

The mathematical notations used in this Handbook are those commonly adopted in standard texts, particularly *Higher Transcendental Functions*, Volumes 1-3, by A. Erdélyi, W. Magnus, F. Oberhettinger and F. G. Tricomi (McGraw-Hill, 1953-55). Some alternative notations have also been listed. The introduction of new symbols has been kept to a minimum, and an effort has been made to avoid the use of conflicting notation.

2. Accuracy of the Tables

The number of significant figures given in each table has depended to some extent on the number available in existing tabulations. There has been no attempt to make it uniform throughout the Handbook, which would have been a costly and laborious undertaking. In most tables at least five significant figures have been provided, and the tabular intervals have generally been chosen to ensure that linear interpolation will yield four- or five-figure accuracy, which suffices in most physical applications. Users requiring higher

precision in their interpolates may obtain them by use of higher-order interpolation procedures, described below.

In certain tables many-figured function values are given at irregular intervals in the argument. An example is provided by Table 9.4. The purpose of these tables is to furnish "key values" for the checking of programs for automatic computers; no question of interpolation arises.

The maximum end-figure error, or "tolerance" in the tables in this Handbook is $\frac{1}{10}$ of 1 unit everywhere in the case of the elementary functions, and 1 unit in the case of the higher functions except in a few cases where it has been permitted to rise to 2 units.

¹ The most recent, the sixth, with F. Loesch added as co-author, was published in 1960 by McGraw-Hill, U.S.A., and Teubner, Germany.

² The second edition, with L. J. Comrie added as co-author, was published in two volumes in 1962 by Addison-Wesley, U.S.A., and Scientific Computing Service Ltd., Great Britain.

3. Auxiliary Functions and Arguments

One of the objects of this Handbook is to provide tables or computing methods which enable the user to evaluate the tabulated functions over complete ranges of real values of their parameters. In order to achieve this object, frequent use has been made of auxiliary functions to remove the infinite part of the original functions at their singularities, and auxiliary arguments to cope with infinite ranges. An example will make the procedure clear.

The exponential integral of positive argument is given by

$$\begin{aligned}
 \text{Ei}(x) &= \int_{-\infty}^x \frac{e^u}{u} du \\
 &= \gamma + \ln x + \frac{x}{1 \cdot 1!} + \frac{x^2}{2 \cdot 2!} + \frac{x^3}{3 \cdot 3!} + \dots \\
 &\sim \frac{e^x}{x} \left[1 + \frac{1!}{x} + \frac{2!}{x^2} + \frac{3!}{x^3} + \dots \right] (x \rightarrow \infty)
 \end{aligned}$$

The logarithmic singularity precludes direct interpolation near $x=0$. The functions $\text{Ei}(x) - \ln x$ and $x^{-1}[\text{Ei}(x) - \ln x - \gamma]$, however, are well-behaved and readily interpolable in this region. Either will do as an auxiliary function; the latter was in fact selected as it yields slightly higher accuracy when $\text{Ei}(x)$ is recovered. The function $x^{-1}[\text{Ei}(x) - \ln x - \gamma]$ has been tabulated to nine decimals for the range $0 \leq x \leq \frac{1}{2}$. For $\frac{1}{2} \leq x \leq 2$, $\text{Ei}(x)$ is sufficiently well-behaved to admit direct tabulation, but for larger values of x , its exponential character predominates. A smoother and more readily interpolable function for large x is $xe^{-x}\text{Ei}(x)$; this has been tabulated for $2 \leq x \leq 10$. Finally, the range $10 \leq x \leq \infty$ is covered by use of the inverse argument x^{-1} . Twenty-one entries of $xe^{-x}\text{Ei}(x)$, corresponding to $x^{-1} = .1(-.005)0$, suffice to produce an interpolable table.

4. Interpolation

The tables in this Handbook are not provided with differences or other aids to interpolation, because it was felt that the space they require could be better employed by the tabulation of additional functions. Admittedly aids could have been given without consuming extra space by increasing the intervals of tabulation, but this would have conflicted with the requirement that linear interpolation is accurate to four or five figures.

For applications in which linear interpolation is insufficiently accurate it is intended that Lagrange's formula or Aitken's method of iterative linear interpolation³ be used. To help the user, there is a statement at the foot of most tables of the maximum error in a linear interpolate, and the number of function values needed in Lagrange's formula or Aitken's method to interpolate to full tabular accuracy.

As an example, consider the following extract from Table 5.1.

x	$xe^xE_1(x)$	x	$xe^xE_1(x)$
7.5	.89268 7854	8.0	.89823 7113
7.6	.89384 6312	8.1	.89927 7888
7.7	.89497 9666	8.2	.90029 7306
7.8	.89608 8737	8.3	.90129 6073
7.9	.89717 4302	8.4	.90227 4695

$$\left[\begin{matrix} (-6)3 \\ 5 \end{matrix} \right]$$

The numbers in the square brackets mean that the maximum error in a linear interpolate is 3×10^{-6} , and that to interpolate to the full tabular accuracy five points must be used in Lagrange's and Aitken's methods.

Let us suppose that we wish to compute the value of $xe^xE_1(x)$ for $x=7.9527$ from this table. We describe in turn the application of the methods of linear interpolation, Lagrange and Aitken, and of alternative methods based on differences and Taylor's series.

(1) Linear interpolation. The formula for this process is given by

$$f_p = (1-p)f_0 + pf_1$$

where f_0, f_1 are consecutive tabular values of the function, corresponding to arguments x_0, x_1 , respectively; p is the given fraction of the argument interval

$$p = (x - x_0)/(x_1 - x_0)$$

and f_p the required interpolate. In the present instance, we have

$$f_0 = .89717 \ 4302 \quad f_1 = .89823 \ 7113 \quad p = .527$$

The most convenient way to evaluate the formula on a desk calculating machine is to set f_0 and f_1 in turn on the keyboard, and carry out the multiplications by $1-p$ and p cumulatively; a partial check is then provided by the multiplier dial reading unity. We obtain

$$\begin{aligned}
 f_{.527} &= (1-.527)(.89717 \ 4302) + .527(.89823 \ 7113) \\
 &= .89773 \ 4403.
 \end{aligned}$$

Since it is known that there is a possible error of 3×10^{-6} in the linear formula, we round off this result to .89773. The maximum possible error in this answer is composed of the error committed

³ A. C. Aitken, On interpolation by iteration of proportional parts, without the use of differences, Proc. Edinburgh Math. Soc. 3, 56-76 (1932).

by the last rounding, that is, $.4403 \times 10^{-5}$, plus 3×10^{-6} , and so certainly cannot exceed $.8 \times 10^{-5}$.

(2) Lagrange's formula. In this example, the relevant formula is the 5-point one, given by

$$f = A_{-2}(p)f_{-2} + A_{-1}(p)f_{-1} + A_0(p)f_0 + A_1(p)f_1 + A_2(p)f_2$$

Tables of the coefficients $A_k(p)$ are given in chapter 25 for the range $p=0(.01)1$. We evaluate the formula for $p=.52, .53$ and $.54$ in turn. Again, in each evaluation we accumulate the $A_k(p)$ in the multiplier register since their sum is unity. We now have the following subtable.

x	$xe^x E_1(x)$		
7.952	.89772 9757	10622	
7.953	.89774 0379	10620	-2
7.954	.89775 0999		

The numbers in the third and fourth columns are the first and second differences of the values of $xe^x E_1(x)$ (see below); the smallness of the second difference provides a check on the three interpolations. The required value is now obtained by linear interpolation:

$$f_p = .3(.89772 9757) + .7(.89774 0379) = .89773 7192.$$

In cases where the correct order of the Lagrange polynomial is not known, one of the preliminary interpolations may have to be performed with polynomials of two or more different orders as a check on their adequacy.

(3) Aitken's method of iterative linear interpolation. The scheme for carrying out this process in the present example is as follows:

n	x_n	$y_n = xe^x E_1(x)$	$y_{0,n}$	$y_{0,1,n}$	$y_{0,1,2,n}$	$y_{0,1,2,3,n}$	$x_n - x$
0	8.0	.89823 7113					.0473
1	7.9	.89717 4302	.89773 44034				-.0527
2	8.1	.89927 7888	.89774 48264	.89773 71499			.1473
3	7.8	.89608 8737	2 90220	2394	.89773 71938		-.1527
4	8.2	.90029 7306	4 98773	1216	16	.89773 71930	.2473
5	7.7	.89497 9666	2 35221	2706	43	30	-.2527

Here

$$y_{0,n} = \frac{1}{x_n - x_0} \begin{vmatrix} y_0 & x_0 - x \\ y_n & x_n - x \end{vmatrix}$$

$$y_{0,1,n} = \frac{1}{x_n - x_1} \begin{vmatrix} y_{0,1} & x_1 - x \\ y_n & x_n - x \end{vmatrix}$$

$$y_{0,1,\dots,m-1,n} = \frac{1}{x_n - x_m} \begin{vmatrix} y_{0,1,\dots,m-1} & x_m - x \\ y_n & x_n - x \end{vmatrix}$$

If the quantities $x_n - x$ and $x_m - x$ are used as multipliers when forming the cross-product on a desk machine, their accumulation $(x_n - x) - (x_m - x)$ in the multiplier register is the divisor to be used at that stage. An extra decimal place is usually carried in the intermediate interpolates to safeguard against accumulation of rounding errors.

The order in which the tabular values are used is immaterial to some extent, but to achieve the maximum rate of convergence and at the same time minimize accumulation of rounding errors, we begin, as in this example, with the tabular argument nearest to the given argument, then take the nearest of the remaining tabular arguments, and so on.

The number of tabular values required to achieve a given precision emerges naturally in the course of the iterations. Thus in the present example six values were used, even though it was known in advance that five would suffice. The extra row confirms the convergence and provides a valuable check.

(4) Difference formulas. We use the central difference notation (chapter 25),

x_0	f_0				
x_1	f_1	$\delta f_{1/2}$	$\delta^2 f_1$		
x_2	f_2	$\delta f_{3/2}$	$\delta^2 f_2$	$\delta^2 f_{3/2}$	$\delta^4 f_2$
x_3	f_3	$\delta f_{5/2}$	$\delta^2 f_3$	$\delta^2 f_{5/2}$	
x_4	f_4	$\delta f_{7/2}$			

Here

$$\begin{aligned} \delta f_{1/2} &= f_1 - f_0, \delta f_{3/2} = f_2 - f_1, \dots, \\ \delta^2 f_1 &= \delta f_{3/2} - \delta f_{1/2} = f_2 - 2f_1 + f_0 \\ \delta^2 f_{3/2} &= \delta^2 f_2 - \delta^2 f_1 = f_3 - 3f_2 + 3f_1 - f_0 \\ \delta^4 f_2 &= \delta^2 f_{5/2} - \delta^2 f_{3/2} = f_4 - 4f_3 + 6f_2 - 4f_1 + f_0 \end{aligned}$$

and so on.

In the present example the relevant part of the difference table is as follows, the differences being written in units of the last decimal place of the function, as is customary. The smallness of the high differences provides a check on the function values

x	$xe^x E_1(x)$	$\delta^2 f$	$\delta^4 f$
7.9	.89717 4302	-2 2754	-34
8.0	.89823 7113	-2 2036	-39

Applying, for example, Everett's interpolation formula

$$f_p = (1-p)f_0 + E_2(p)\delta^2 f_0 + E_4(p)\delta^4 f_0 + \dots + pf_1 + F_2(p)\delta^2 f_1 + F_4(p)\delta^4 f_1 + \dots$$

and taking the numerical values of the interpolation coefficients $E_2(p), E_4(p), F_2(p)$ and $F_4(p)$ from Table 25.1, we find that

$$10^9 f_{.527} = .473(89717\ 4302) + .061196(2\ 2754) - .012(34) \\ + .527(89823\ 7113) + .063439(2\ 2036) - .012(39) \\ = 89773\ 7193.$$

We may notice in passing that Everett's formula shows that the error in a linear interpolate is approximately

$$E_2(p)\delta^2 f_0 + F_2(p)\delta^2 f_1 \approx \frac{1}{2}[E_2(p) + F_2(p)][\delta^2 f_0 + \delta^2 f_1]$$

Since the maximum value of $|E_2(p) + F_2(p)|$ in the range $0 < p < 1$ is $\frac{1}{8}$, the maximum error in a linear interpolate is approximately

$$\frac{1}{16} |\delta^2 f_0 + \delta^2 f_1|, \text{ that is, } \frac{1}{16} |f_2 - f_1 - f_0 + f_{-1}|.$$

(5) Taylor's series. In cases where the successive derivatives of the tabulated function can be computed fairly easily, Taylor's expansion

$$f(x) = f(x_0) + (x-x_0)\frac{f'(x_0)}{1!} + (x-x_0)^2\frac{f''(x_0)}{2!} \\ + (x-x_0)^3\frac{f'''(x_0)}{3!} + \dots$$

can be used. We first compute as many of the derivatives $f^{(n)}(x_0)$ as are significant, and then evaluate the series for the given value of x . An advisable check on the computed values of the derivatives is to reproduce the adjacent tabular values by evaluating the series for $x=x_{-1}$ and x_1 .

In the present example, we have

$$f(x) = xe^x E_1(x) \\ f'(x) = (1+x^{-1})f(x) - 1 \\ f''(x) = (1+x^{-1})f'(x) - x^{-2}f(x) \\ f'''(x) = (1+x^{-1})f''(x) - 2x^{-2}f'(x) + 2x^{-3}f(x).$$

With $x_0=7.9$ and $x-x_0=.0527$ our computations are as follows; an extra decimal has been retained in the values of the terms in the series to safeguard against accumulation of rounding errors.

k	$f^{(k)}(x_0)/k!$	$(x-x_0)^k f^{(k)}(x_0)/k!$
0	.89717 4302	.89717 4302
1	.01074 0669	.00056 6033 3
2	-.00113 7621	-.00000 3159 5
3	.00012 1987	.00000 0017 9
		<hr/>
		.89773 7194

5. Inverse Interpolation

With linear interpolation there is no difference in principle between direct and inverse interpolation. In cases where the linear formula provides an insufficiently accurate answer, two methods are available. We may interpolate directly, for example, by Lagrange's formula to prepare a new table at a fine interval in the neighborhood of the approximate value, and then apply accurate inverse linear interpolation to the subtabulated values. Alternatively, we may use Aitken's method or even possibly the Taylor's series method, with the roles of function and argument interchanged.

It is important to realize that the accuracy of an inverse interpolate may be very different from that of a direct interpolate. This is particularly true in regions where the function is slowly varying, for example, near a maximum or minimum. The maximum precision attainable in an inverse interpolate can be estimated with the aid of the formula

$$\Delta x \approx \Delta f \frac{df}{dx}$$

in which Δf is the maximum possible error in the function values.

Example. Given $xe^x E_1(x) = .9$, find x from the table on page X.

(i) Inverse linear interpolation. The formula for p is

$$p = (f_p - f_0)/(f_1 - f_0).$$

In the present example, we have

$$p = \frac{.9 - .89927\ 7888}{.90029\ 7306 - .89927\ 7888} = \frac{.72\ 2112}{101\ 9418} = .708357.$$

The desired x is therefore

$$x = x_0 + p(x_1 - x_0) = 8.1 + .708357(.1) = 8.17083\ 57$$

To estimate the possible error in this answer, we recall that the maximum error of direct linear interpolation in this table is $\Delta f = 3 \times 10^{-6}$. An approximate value for df/dx is the ratio of the first difference to the argument interval (chapter 25), in this case .010. Hence the maximum error in x is approximately $3 \times 10^{-6}/(.010)$, that is, .0003.

(ii) Subtabulation method. To improve the approximate value of x just obtained, we interpolate directly for $p = .70, .71$ and $.72$ with the aid of Lagrange's 5-point formula,

x	$xe^x E_1(x)$	δ	δ^2
8.170	.89999 3683		
8.171	.90000 3834	1 0151	
8.172	.90001 3983	1 0149	-2

Inverse linear interpolation in the new table gives

$$p = \frac{.9 - .89999\ 3683}{.00001\ 0151} = .6223$$

Hence $x = 8.17062\ 23$.

An estimate of the maximum error in this result is

$$\Delta f \frac{df}{dx} \approx \frac{1 \times 10^{-9}}{.010} = 1 \times 10^{-7}$$

(iii) Aitken's method. This is carried out in the same manner as in direct interpolation.

n	$y_n = xe^x E_1(x)$	x_n	$x_{0,n}$	$x_{0,1,n}$	$x_{0,1,2,n}$	$x_{0,1,2,3,n}$	$y_n - y$
0	.90029 7306	8.2					.00029 7306
1	.89927 7888	8.1	8.17083 5712				-.00072 2112
2	.90129 6033	8.3	8.17023 1505	8.17061 9521			.00129 6033
3	.89823 7113	8.0	8.17113 8043	2 5948	8.17062 2244		-.00176 2887
4	.90227 4695	8.4	8.16992 9437	1 7335	415	8.17062 2318	.00227 4695
5	.89717 4302	7.9	8.17144 0382	2 8142	231	265	-.00282 5698

The estimate of the maximum error in this result is the same as in the subtabulation method. An indication of the error is also provided by the

discrepancy in the highest interpolates, in this case $x_{0,1,2,3,4}$, and $x_{0,1,2,3,5}$.

6. Bivariate Interpolation

Bivariate interpolation is generally most simply performed as a sequence of univariate interpolations. We carry out the interpolation in one direction, by one of the methods already described, for several tabular values of the second argument in the neighborhood of its given value. The interpolates are differenced as a check, and

interpolation is then carried out in the second direction.

An alternative procedure in the case of functions of a complex variable is to use the Taylor's series expansion, provided that successive derivatives of the function can be computed without much difficulty.

7. Generation of Functions from Recurrence Relations

Many of the special mathematical functions which depend on a parameter, called their index, order or degree, satisfy a linear difference equation (or recurrence relation) with respect to this parameter. Examples are furnished by the Legendre function $P_n(x)$, the Bessel function $J_n(x)$ and the exponential integral $E_n(x)$, for which we have the respective recurrence relations

$$(n+1)P_{n+1} - (2n+1)xP_n + nP_{n-1} = 0$$

$$J_{n+1} - \frac{2n}{x} J_n + J_{n-1} = 0$$

$$nE_{n+1} + xE_n = e^{-x}$$

Particularly for automatic work, recurrence relations provide an important and powerful computing tool. If the values of $P_n(x)$ or $J_n(x)$ are known for two consecutive values of n , or $E_n(x)$ is known for one value of n , then the function may be computed for other values of n by successive applications of the relation. Since generation is carried out perforce with rounded values, it is vital to know how errors may be propagated in the recurrence process. If the errors do not grow relative to the size of the wanted function, the process is said to be stable. If, however, the relative errors grow and will eventually overwhelm the wanted function, the process is unstable.

It is important to realize that stability may depend on (i) the particular solution of the difference equation being computed; (ii) the values of x or other parameters in the difference equation;

(iii) the direction in which the recurrence is being applied. Examples are as follows.

Stability—increasing n

$$P_n(x), P_n''(x)$$

$$Q_n(x), Q_n''(x) \quad (x < 1)$$

$$Y_n(x), K_n(x)$$

$$J_{-n-\frac{1}{2}}(x), I_{-n-\frac{1}{2}}(x)$$

$$E_n(x) \quad (n < x)$$

Stability—decreasing n

$$P_n(x), P_n''(x) \quad (x < 1)$$

$$Q_n(x), Q_n''(x)$$

$$J_n(x), I_n(x)$$

$$J_{n+\frac{1}{2}}(x), I_{n+\frac{1}{2}}(x)$$

$$E_n(x) \quad (n > x)$$

$$F_n(\eta, \rho) \quad (\text{Coulomb wave function})$$

Illustrations of the generation of functions from their recurrence relations are given in the pertinent chapters. It is also shown that even in cases where the recurrence process is unstable, it may still be used when the starting values are known to sufficient accuracy.

Mention must also be made here of a refinement, due to J. C. P. Miller, which enables a recurrence process which is stable for decreasing n to be applied without any knowledge of starting values for large n . Miller's algorithm, which is well-suited to automatic work, is described in 19.28, Example 1.

8. Acknowledgments

The production of this volume has been the result of the unrelenting efforts of many persons, all of whose contributions have been instrumental in accomplishing the task. The Editor expresses his thanks to each and every one.

The Ad Hoc Advisory Committee individually and together were instrumental in establishing the basic tenets that served as a guide in the formation of the entire work. In particular, special thanks are due to Professor Philip M. Morse for his continuous encouragement and support. Professors J. Todd and A. Erdélyi, panel members of the Conferences on Tables and members of the Advisory Committee have maintained an undiminished interest, offered many suggestions and carefully read all the chapters.

Irene A. Stegun has served effectively as associate editor, sharing in each stage of the planning of the volume. Without her untiring efforts, completion would never have been possible.

Appreciation is expressed for the generous cooperation of publishers and authors in granting permission for the use of their source material. Acknowledgments for tabular material taken wholly or in part from published works are given on the first page of each table. Myrtle R. Kellington corresponded with authors and publishers to obtain formal permission for including their material, maintained uniformity throughout the

bibliographic references and assisted in preparing the introductory material.

Valuable assistance in the preparation, checking and editing of the tabular material was received from Ruth E. Capuano, Elizabeth F. Godefroy, David S. Liepman, Kermit Nelson, Bertha H. Walter and Ruth Zucker.

Equally important has been the untiring cooperation, assistance, and patience of the members of the NBS staff in handling the myriad of detail necessarily attending the publication of a volume of this magnitude. Especially appreciated have been the helpful discussions and services from the members of the Office of Technical Information in the areas of editorial format, graphic art layout, printing detail, preprinting reproduction needs, as well as attention to promotional detail and financial support. In addition, the clerical and typing staff of the Applied Mathematics Division merit commendation for their efficient and patient production of manuscript copy involving complicated technical notation.

Finally, the continued support of Dr. E. W. Cannon, chief of the Applied Mathematics Division, and the advice of Dr. F. L. Alt, assistant chief, as well as of the many mathematicians in the Division, is gratefully acknowledged.

M. ABRAMOWITZ.

1. Mathematical Constants

DAVID S. LIEPMAN¹

Contents

	Page
Table 1.1. Mathematical Constants	2
\sqrt{n} , n prime < 100 , 20S	2
Some roots of 2, 3, 5, 10, 100, 1000, e , 20S	2
$e^{\pm n}$, $n=1(1)10$, 25S	2
$e^{\pm n\pi}$, $n=1(1)10$, 20S	2
$e^{\pm e}$, $e^{\pm \gamma}$, 20S	2
$\ln n$, $\log_{10} n$, $n=2(1)10$, primes < 100 , 26, 25S	2
$\ln \pi$, $\ln \sqrt{2\pi}$, $\log_{10} \pi$, $\log_{10} e$, 25S	3
$n \ln 10$, $n=1(1)9$, 25S	3
$n\pi$, $n=1(1)9$, 25S	3
$\pi^{\pm n}$, $n=1(1)10$, 25S	3
Fractions of π , powers and roots involving π , 25S	3
1 radian in degrees, 26S	3
1° , $1'$, $1''$ in radians, 24D	3
γ , $\ln \gamma$, 24D	3
$\Gamma(\frac{1}{2})$, $1/\Gamma(\frac{1}{2})$, 15D	3
$\Gamma(x)$, $1/\Gamma(x)$, $\ln \Gamma(x)$, $x=\frac{1}{2}, \frac{1}{4}, \frac{2}{3}, \frac{3}{4}, \frac{4}{3}, \frac{5}{3}, \frac{5}{4}, \frac{7}{4}$, 15D	3

¹ National Bureau of Standards.

TABLE I. 1. MATHEMATICAL CONSTANTS

$n(\text{prime})$		\sqrt{n}							
2	1. 4142	13562	37309	50488	$10^{1/2}$	3. 1622	77660	16837	93320
3	1. 7320	50807	56887	72935	$10^{1/3}$	2. 1544	34690	03188	37219
5	2. 2360	67977	49978	96964	$10^{1/4}$	1. 7782	79410	03892	28012
7	2. 6457	51311	06459	05905	$10^{1/5}$	1. 5848	93192	46111	34853
11	3. 3166	24790	35539	98491	$100^{1/3}$	4. 6415	88833	61277	88924 *
13	3. 6055	51275	46398	92931	$100^{1/5}$	2. 5118	86431	50958	01112
17	4. 1231	05625	61766	05498	$1000^{1/4}$	5. 6234	13251	90349	08040
19	4. 3588	98943	54067	35522	$1000^{1/5}$	3. 9810	71705	53497	25077 *
23	4. 7958	31523	31271	95416	$2^{1/3}$	1. 2599	21049	89487	31648
29	5. 3851	64807	13450	40313	$3^{1/3}$	1. 4422	49570	30740	83823
31	5. 5677	64362	83002	19221	$2^{1/4}$	1. 1892	07115	00272	10667
37	6. 0827	62530	29821	96890	$3^{1/4}$	1. 3160	74012	95249	24608 *
41	6. 4031	24237	43284	86865	$2^{-1/2}$ (- 1)	7. 0710	67811	86547	52440
43	6. 5574	38524	30200	06523	$3^{-1/2}$ (- 1)	5. 7735	02691	89625	76451
47	6. 8556	54600	40104	41249	$5^{-1/2}$ (- 1)	4. 4721	35954	99957	93928
53	7. 2801	09889	28051	82711					
59	7. 6811	45747	86860	81758					
61	7. 8102	49675	90665	43941	$e^{\pi/2}$	4. 8104	77380	96535	16555
67	8. 1853	52771	87244	99700	$e^{\pi/4}$	2. 1932	80050	73801	54566
71	8. 4261	49773	17635	86306	$e^{-\pi/2}$ (- 1)	2. 0787	95763	50761	90855
73	8. 5440	03745	31753	11679	$e^{-\pi/4}$ (- 1)	4. 5593	81277	65996	23677
79	8. 8881	94417	31558	88501	$e^{1/2}$	1. 6487	21270	70012	81468
83	9. 1104	33579	14429	88819	$e^{-1/2}$ (- 1)	6. 0653	06597	12633	42360
89	9. 4339	81132	05660	38113	$e^{1/3}$	1. 3956	12425	08608	95286
97	9. 8488	57801	79610	47217	$e^{-1/3}$ (- 1)	7. 1653	13105	73789	25043

n		e^n			n		e^{-n}		
1		2. 7182	81828	45904	52353	60287	1	(- 1)	3. 6787 94411 71442 32159 55238
2		7. 3890	56098	93065	02272	30427	2	(- 1)	1. 3533 52832 36612 69189 39995
3	(1)	2. 0085	53692	31876	67740	92853	3	(- 2)	4. 9787 06836 78639 42979 34242
4	(1)	5. 4598	15003	31442	39078	11026	4	(- 2)	1. 8315 63888 87341 80293 71802
5	(2)	1. 4841	31591	02576	60342	11156	5	(- 3)	6. 7379 46999 08546 70966 36048
6	(2)	4. 0342	87934	92735	12260	83872	6	(- 3)	2. 4787 52176 66635 84230 45167
7	(3)	1. 0966	33158	42845	85992	63720	7	(- 4)	9. 1188 19655 54516 20800 31361
8	(3)	2. 9809	57987	04172	82747	43592	8	(- 4)	3. 3546 26279 02511 83882 13891
9	(3)	8. 1030	83927	57538	40077	09997	9	(- 4)	1. 2340 98040 86679 54949 76367
10	(4)	2. 2026	46579	48067	16516	95790	10	(- 5)	4. 5399 92976 24848 51535 59152

n		e^{n^*}			n		e^{-n^*}		
1	(1)	2. 3140	69263	27792	69006	1	(- 2)	4. 3213 91826 37722 49774	
2	(2)	5. 3549	16555	24764	73650	2	(- 3)	1. 8674 42731 70798 88144	
3	(4)	1. 2391	64780	79166	97482	3	(- 5)	8. 0699 51757 03045 99239	
4	(5)	2. 8675	13131	36653	29975	4	(- 6)	3. 4873 42356 20899 54918	
5	(6)	6. 6356	23999	34113	42333	5	(- 7)	1. 5070 17275 39006 46107	
6	(8)	1. 5355	29353	95446	69392	6	(- 9)	6. 5124 12136 07990 07282	
7	(9)	3. 5533	21280	84704	43597	7	(- 10)	2. 8142 68457 48555 27211	
8	(10)	8. 2226	31558	55949	95275	8	(- 11)	1. 2161 55670 94093 08397	
9	(12)	1. 9027	73895	29216	12917	9	(- 13)	5. 2554 85176 00644 85552	
10	(13)	4. 4031	50586	06320	29011	10	(- 14)	2. 2711 01068 32409 38387	

e^e	(1)	1. 5154	26224	14792	64190
e^γ		1. 7810	72417	99019	79852

n		$\ln n$			n		$\log_{10} n$		
2		0. 6931	47180	55994	53094	172321	2	(- 1)	3. 0102 99956 63981 19521 37389
3		1. 0986	12288	66810	96913	952452	3	(- 1)	4. 7712 12547 19662 43729 50279
4		1. 3862	94361	11989	06188	344642	4	(- 1)	6. 0205 99913 27962 39042 74778
5		1. 6094	37912	43410	03746	007593	5	(- 1)	6. 9897 00043 36018 80478 62611
6		1. 7917	59469	22805	50008	124774	6	(- 1)	7. 7815 12503 83643 63250 87668
7		1. 9459	10149	05531	33051	053527	7	(- 1)	8. 4509 80400 14256 83071 22163
8		2. 0794	41541	67983	59282	516964	8	(- 1)	9. 0308 99869 91943 58564 12167
9		2. 1972	24577	33621	93827	904905	9	(- 1)	9. 5424 25094 39324 87459 00558
10		2. 3025	85092	99404	56840	179915	10		1. 0000 00000 00000 00000 00000
11		2. 3978	95272	79837	05440	619436	11		1. 0413 92685 15822 50407 50200
13		2. 5649	49357	46153	67360	534874	13		1. 1139 43352 30683 67692 06505
17		2. 8332	13344	05621	60802	495346	17		1. 2304 48921 37827 39285 40170
19		2. 9444	38979	16644	04600	090274	19		1. 2787 53600 95282 89615 36333
23		3. 1354	94215	92914	96908	067528	23		1. 3617 27836 01759 28788 67777
29		3. 3672	95829	98647	40271	832720	29		1. 4623 97997 89895 60873 32847
31		3. 4339	87204	48514	62459	291643	31		1. 4913 61693 83427 26796 66704
37		3. 6109	17912	64422	44443	680957	37		1. 5682 01724 06699 49968 08451
41		3. 7135	72066	70430	78038	667634	41		1. 6127 83856 71973 54945 09412
43		3. 7612	00115	69356	24234	728425	43		1. 6334 68455 57958 65264 05088

*See page II.

TABLE I.1. MATHEMATICAL CONSTANTS—Continued

n		$\ln n$		n		$\log_{10} n$				
47	3. 8501	47601	71005	85868	209507	47	1. 6720	97857	93571	74644 14219
53	3. 9702	91913	55212	18341	444691	53	1. 7242	75869	60078	90456 32992
59	4. 0775	37443	90571	94506	160504	59	1. 7708	52011	64214	41902 60656
61	4. 1108	73864	17331	12487	513891	61	1. 7853	29835	01076	70338 85749
67	4. 2046	92619	39096	60596	700720	67	1. 8260	74802	70082	64341 49132
71	4. 2626	79877	04131	54213	294545	71	1. 8512	58348	71907	52860 92829
73	4. 2904	59441	14839	11290	921089	73	1. 8633	22860	12045	59010 74387
79	4. 3694	47852	46702	14941	729455	79	1. 8976	27091	29044	14279 94821
83	4. 4188	40607	79659	79234	754722	83	1. 9190	78092	37607	39038 32760
89	4. 4886	36369	73213	98383	178155	89	1. 9493	90006	64491	27847 23543
97	4. 5747	10978	50338	28221	167216	97	1. 9867	71734	53624	48517 84362
$\ln \pi$	1. 1447	29885	84940	01741	43427	$\log_{10} \pi$	(-1) 4. 9714	98726	94133	85435 12683
$\ln \sqrt{2} \pi$	(-1) 9. 1893	85332	04672	74178	03296	$\log_{10} e$	(-1) 4. 3429	44819	03251	82765 11289
n		$n \ln 10$		n		$n\pi$				
1	2. 3025	85092	99404	56840	17991	1	3. 1415	92653	58979	32384 62643
2	4. 6051	70185	98809	13680	35983	2	6. 2831	85307	17958	64769 25287
3	6. 9077	55278	98213	70520	53974	3	9. 4247	77960	76937	97153 87930
4	9. 2103	40371	97618	27360	71966	4	(1) 1. 2566	37061	43591	72953 85057
5	(1) 1. 1512	92546	49702	28420	08996	5	(1) 1. 5707	96326	79489	66192 31322
6	(1) 1. 3815	51055	79642	74104	10795	6	(1) 1. 8849	55592	15387	59430 77586
7	(1) 1. 6118	09565	09583	19788	12594	7	(1) 2. 1991	14857	51285	52669 23850
8	(1) 1. 8420	68074	39523	65472	14393	8	(1) 2. 5132	74122	87183	45907 70115
9	(1) 2. 0723	26583	69464	11156	16192	9	(1) 2. 8274	33388	23081	39146 16379
n		π^n		n		π^{-n}				
1	3. 1415	92653	58979	32384	62643	1	(-1) 3. 1830	98861	83790	67153 77675
2	9. 8696	04401	08935	86188	34491	2	(-1) 1. 0132	11836	42337	77144 38795
3	(1) 3. 1006	27668	02998	20175	47632	3	(-2) 3. 2251	53443	31994	89184 42205
4	(1) 9. 7409	09103	40024	37236	44033	4	(-2) 1. 0265	98225	46843	35189 15278
5	(2) 3. 0601	96847	85281	45326	27413	5	(-3) 3. 2677	63643	05338	54726 28250
6	(2) 9. 6138	91935	75304	43703	02194	6	(-3) 1. 0401	61473	29585	22960 89838
7	(3) 3. 0202	93227	77679	20675	14206	7	(-4) 3. 3109	36801	77566	76432 59528
8	(3) 9. 4885	31016	07057	40071	28576	8	(-4) 1. 0539	03916	53493	66633 17287
9	(4) 2. 9809	09933	34462	11666	50940	9	(-5) 3. 3546	80357	20886	91287 39854
10	(4) 9. 3648	04747	60830	20973	71669	10	(-5) 1. 0678	27922	68615	33662 04078
$\pi/2$	1. 5707	96326	79489	66192	31322	$3\pi/2$	4. 7123	88980	38468	98576 93965
$\pi/3$	1. 0471	97551	19659	77461	54214	$4\pi/3$	4. 1887	90204	78639	09846 16858
$\pi/4$	(-1) 7. 8539	81633	97448	30961	56608	$\pi(2)^{1/2}$	4. 4428	82938	15836	62470 15881
$\pi^{1/2}$	1. 7724	53850	90551	60272	98167	$\pi^{-1/2}$	(-1) 5. 6418	95835	47756	28694 80795
$\pi^{1/3}$	1. 4645	91887	56152	32630	20143	$\pi^{-1/3}$	(-1) 6. 8278	40632	55295	68146 70208
$\pi^{1/4}$	1. 3313	35363	80038	97127	97535	$\pi^{-1/4}$	(-1) 7. 5112	55444	64942	48285 87030
$\pi^{2/3}$	2. 1450	29397	11102	56000	77444	$\pi^{-2/3}$	(-1) 4. 6619	40770	35411	61438 19885
$\pi^{3/4}$	2. 3597	30492	41469	68875	78474	$\pi^{-3/4}$	(-1) 4. 2377	72081	23757	59679 10077
$\pi^{3/2}$	5. 5683	27996	83170	78452	84818	$\pi^{-3/2}$	(-1) 1. 7958	71221	25166	56168 90820
π^e	(1) 2. 2459	15771	83610	45473	42715	π^{-e}	(-2) 4. 4525	26726	69229	06151 35273
$(2\pi)^{1/2}$	2. 5066	28274	63100	05024	15765	$(2\pi)^{-1/2}$	(-1) 3. 9894	22804	01432	67793 99461
$(\pi/2)^{1/2}$	1. 2533	14137	31550	02512	07883	$(2/\pi)^{1/2}$	(-1) 7. 9788	45608	02865	35587 98921
$\pi(2)^{-1/2}$	2. 2214	41469	07918	31235	07940	$2^{1/2}/\pi$	(-1) 4. 5015	81580	78553	03477 75996
$1r$	57. 2957	79513	08232	08767	98155°	$1'$	0. 0002	90888	20866	57215 96154r
1°	0. 0174	53292	51994	32957	69237r	$1''$	0. 0000	04848	13681	10953 59936r
γ	0. 5772	15664	90153	28606	06512	$\ln \gamma$	-0. 5495	39312	98164	48223 37662
$\Gamma(1/2)$	1. 7724	53850	905516			$1/\Gamma(1/2)$	0. 5641	89583	547756	
$\Gamma(1/3)$	2. 6789	38534	707748			$1/\Gamma(1/3)$	0. 3732	82173	907395	
$\Gamma(2/3)$	1. 3541	17939	426400			$1/\Gamma(2/3)$	0. 7384	88111	621648	
$\Gamma(1/4)$	3. 6256	09908	221908			$1/\Gamma(1/4)$	0. 2758	15662	830209	
$\Gamma(3/4)$	1. 2254	16702	465178			$1/\Gamma(3/4)$	0. 8160	48939	098263	
$\Gamma(4/3)$	0. 8929	79511	569249			$1/\Gamma(4/3)$	1. 1198	46521	722186	
$\Gamma(5/3)$	0. 9027	45292	950934			$1/\Gamma(5/3)$	1. 1077	32167	432472	
$\Gamma(5/4)$	0. 9064	02477	055477			$1/\Gamma(5/4)$	1. 1032	62651	320837	
$\Gamma(7/4)$	0. 9190	62526	848883			$1/\Gamma(7/4)$	1. 0880	65252	131017	
$\ln \Gamma(1/3)$	0. 9854	20646	927767			$\ln \Gamma(4/3)$	-0. 1131	91641	740343	
$\ln \Gamma(2/3)$	0. 3031	50275	147523			$\ln \Gamma(5/3)$	-0. 1023	14832	960640	
$\ln \Gamma(1/4)$	1. 2880	22524	698077			$\ln \Gamma(5/4)$	-0. 0982	71836	421813	
$\ln \Gamma(3/4)$	0. 2032	80951	431296			$\ln \Gamma(7/4)$	-0. 0844	01121	020486	

*See page 11.



2. Physical Constants and Conversion Factors

A. G. McNISH¹

Contents

	Page
Table 2.1. Common Units and Conversion Factors	6
Table 2.2. Names and Conversion Factors for Electric and Magnetic Units	6
Table 2.3. Adjusted Values of Constants	7
Table 2.4. Miscellaneous Conversion Factors	8
Table 2.5. Conversion Factors for Customary U.S. Units to Metric Units	8
Table 2.6. Geodetic Constants	8

¹ National Bureau of Standards.

2. Physical Constants and Conversion Factors

The tables in this chapter supply some of the more commonly needed physical constants and conversion factors.

All scientific measurements in the fields of mechanics and heat are based upon four international arbitrarily adopted units, the magnitudes of which are fixed by four agreed on standards:

Length—the meter—fixed by the vacuum wavelength of radiation corresponding to the transition $2P_{10} - 5D_5$ of krypton 86

$$(1 \text{ meter} - 1650763.73\lambda).$$

Mass—the kilogram—fixed by the international kilogram at Sèvres, France.

Time—the second—fixed as $1/31,556,925.9747$ of the tropical year 1900 at 12^h ephemeris time, or the duration of 9,192,631,770 cycles of the hyperfine transition frequency of cesium 133.

Temperature—the degree—fixed on a thermodynamic basis by taking the temperature for the triple point of natural water as 273.16 °K. (The Celsius scale is obtained by adding -273.15 to the Kelvin scale.)

Other units are defined in terms of them by assigning the value unity to the proportionality constant in each defining equation. The entire system, including electricity units, is called the *Système International d'Unités* (SI). Taking the $1/100$ part of the meter as the unit of length and the $1/1000$ part of the kilogram as the unit of mass, similarly, gives

rise to the CGS system, often used in physics and chemistry.

Table 2.1. Common Units and Conversion Factors

Quantity	SI name	CGS name	SI unit/CGS unit
Force, F	newton	dyne	10^5
Energy, W	joule	erg	10^7
Power, P	watt	10^7

The SI unit of electric current is the ampere defined by the equation $2\Gamma_m I_1 I_2 / 4\pi = F$ giving the force in vacuo per unit length between two infinitely long parallel conductors of infinitesimal cross-section. If F is in newtons, and Γ_m has the numerical value $4\pi \times 10^{-7}$, then I_1 and I_2 are in amperes. The customary equations define the other electric and magnetic units of SI such as the volt, ohm, farad, henry, etc. The force between electric charges in a vacuum in this system is given by $Q_1 Q_2 / 4\pi \Gamma_e r^2 = F$, Γ_e having the numerical value $10^7 / 4\pi c^2$ where c is the speed of light in meters per second ($\Gamma_e = 8.854 \times 10^{-12}$).

The CGS unrationalized system is obtained by deleting 4π in the denominators in these equations and expressing F in dynes, and r in centimeters. Setting Γ_m equal to unity defines the CGS unrationalized electromagnetic system (emu), Γ_e then taking the numerical value of $1/c^2$. Setting Γ_e equal to unity defines the CGS unrationalized electrostatic system (esu), Γ_m then taking the numerical value of $1/c^2$.

Table 2.2. Names and Conversion Factors for Electric and Magnetic Units

Quantity	SI name	emu name	esu name	SI unit/emu unit	SI unit/esu unit
Current	ampere	abampere	statampere	10^{-1}	$\sim 3 \times 10^9$
Charge	coulomb	abcoulomb	statecoulomb	10^{-1}	$\sim 3 \times 10^9$
Potential	volt	abvolt	statvolt	10^8	$\sim (1/3) \times 10^{-2}$
Resistance	ohm	abohm	statohm	10^9	$\sim (1/9) \times 10^{-11}$
Inductance	henry	centimeter	-----	10^9	$\sim (1/9) \times 10^{-11}$
Capacitance	farad	-----	centimeter	10^{-9}	$\sim 9 \times 10^{11}$
Magnetizing force	amp. turns/meter	oersted	-----	$4\pi \times 10^{-3*}$	$\sim 3 \times 10^{9*}$
Magnetomotive force	amp. turns	gilbert	-----	$4\pi \times 10^{-1*}$	$\sim 3/10^{9*}$
Magnetic flux	weber	maxwell	-----	10^8	$\sim (1/3) \times 10^{-2}$
Magnetic flux density	tesla	gauss	-----	10^4	$\sim (1/3) \times 10^{-6}$
Electric displacement	-----	-----	-----	10^{-5*}	$\sim 3 \times 10^{5*}$

Example: If the value assigned to a current is 100 amperes its value in abamperes is $100 \times 10^{-1} = 10$.

*Divide this number by 4π if unrationalized system is involved; other numbers are unchanged.

3. Elementary Analytical Methods

MILTON ABRAMOWITZ ¹

Contents

	Page
Elementary Analytical Methods	10
3.1. Binomial Theorem and Binomial Coefficients; Arithmetic and Geometric Progressions; Arithmetic, Geometric, Harmonic and Generalized Means	10
3.2. Inequalities	10
3.3. Rules for Differentiation and Integration	11
3.4. Limits, Maxima and Minima	13
3.5. Absolute and Relative Errors	14
3.6. Infinite Series	14
3.7. Complex Numbers and Functions	16
3.8. Algebraic Equations	17
3.9. Successive Approximation Methods	18
3.10. Theorems on Continued Fractions	19
Numerical Methods	19
3.11. Use and Extension of the Tables	19
3.12. Computing Techniques	19
References	23
Table 3.1. Powers and Roots	24
$n^k, k=1(1)10, 24, 1/2, 1/3, 1/4, 1/5$	
$n=2(1)999, \text{Exact or } 10S$	

The author acknowledges the assistance of Peter J. O'Hara and Kermit C. Nelson in the preparation and checking of the table of powers and roots.

¹ National Bureau of Standards. (Deceased.)

3. Elementary Analytical Methods

3.1. Binomial Theorem and Binomial Coefficients; Arithmetic and Geometric Progressions; Arithmetic, Geometric, Harmonic and Generalized Means

Binomial Theorem

3.1.1

$$(a+b)^n = a^n + \binom{n}{1} a^{n-1} b + \binom{n}{2} a^{n-2} b^2 + \binom{n}{3} a^{n-3} b^3 + \dots + b^n$$

(n a positive integer)

Binomial Coefficients (see chapter 24)

3.1.2

$$* \binom{n}{k} = {}_n C_k = \frac{n(n-1)\dots(n-k+1)}{k!} = \frac{n!}{(n-k)!k!}$$

3.1.3 $\binom{n}{k} = \binom{n}{n-k} = (-1)^k \binom{k-n-1}{k}$

3.1.4 $\binom{n+1}{k} = \binom{n}{k} + \binom{n}{k-1}$

3.1.5 $\binom{n}{0} = \binom{n}{n} = 1$

3.1.6 $1 + \binom{n}{1} + \binom{n}{2} + \dots + \binom{n}{n} = 2^n$

3.1.7 $1 - \binom{n}{1} + \binom{n}{2} - \dots + (-1)^n \binom{n}{n} = 0$

Table of Binomial Coefficients $\binom{n}{k}$

3.1.8

$n \backslash k$	0	1	2	3	4	5	6	7	8	9	10	11	12
1	1	1											
2	1	2	1										
3	1	3	3	1									
4	1	4	6	4	1								
5	1	5	10	10	5	1							
6	1	6	15	20	15	6	1						
7	1	7	21	35	35	21	7	1					
8	1	8	28	56	70	56	28	8	1				
9	1	9	36	84	126	126	84	36	9	1			
10	1	10	45	120	210	252	210	120	45	10	1		
11	1	11	55	165	330	462	462	330	165	55	11	1	
12	1	12	66	220	495	792	924	792	495	220	66	12	1

For a more extensive table see chapter 24.

*See page 11.

3.1.9

Sum of Arithmetic Progression to n Terms

$$a + (a+d) + (a+2d) + \dots + (a+(n-1)d)$$

$$= na + \frac{1}{2} n(n-1)d = \frac{n}{2} (a+l),$$

last term in series = $l = a + (n-1)d$

Sum of Geometric Progression to n Terms

3.1.10

$$s_n = a + ar + ar^2 + \dots + ar^{n-1} = \frac{a(1-r^n)}{1-r}$$

$$\lim_{n \rightarrow \infty} s_n = a/(1-r) \quad (-1 < r < 1)$$

Arithmetic Mean of n Quantities A

3.1.11

$$A = \frac{a_1 + a_2 + \dots + a_n}{n}$$

Geometric Mean of n Quantities G

3.1.12 $G = (a_1 a_2 \dots a_n)^{1/n} \quad (a_k > 0, k=1, 2, \dots, n)$

Harmonic Mean of n Quantities H

3.1.13

$$\frac{1}{H} = \frac{1}{n} \left(\frac{1}{a_1} + \frac{1}{a_2} + \dots + \frac{1}{a_n} \right) \quad (a_k > 0, k=1, 2, \dots, n)$$

Generalized Mean

3.1.14

$$M(t) = \left(\frac{1}{n} \sum_{k=1}^n a_k^t \right)^{1/t}$$

3.1.15

$$M(t) = 0 \quad (t < 0, \text{ some } a_k \text{ zero})$$

3.1.16

$$\lim_{t \rightarrow \infty} M(t) = \max. \quad (a_1, a_2, \dots, a_n) = \max. a$$

3.1.17

$$\lim_{t \rightarrow -\infty} M(t) = \min. \quad (a_1, a_2, \dots, a_n) = \min. a$$

3.1.18

$$\lim_{t \rightarrow 0} M(t) = G$$

3.1.19

$$M(1) = A$$

3.1.20

$$M(-1) = H$$

3.2. Inequalities

Relation Between Arithmetic, Geometric, Harmonic and Generalized Means

3.2.1

$$A \geq G \geq H, \text{ equality if and only if } a_1 = a_2 = \dots = a_n$$

3.2.2

$$\min. a < M(t) < \max. a$$

3.2.3 $\min. a < G < \max. a$
equality holds if all a_k are equal, or $t < 0$
and an a_k is zero

3.2.4 $M(t) < M(s)$ if $t < s$ unless all a_k are equal,
or $s < 0$ and an a_k is zero.

Triangle Inequalities

3.2.5 $|a_1| - |a_2| \leq |a_1 + a_2| \leq |a_1| + |a_2|$

3.2.6 $\left| \sum_{k=1}^n a_k \right| \leq \sum_{k=1}^n |a_k|$

Chebyshev's Inequality

If $a_1 \geq a_2 \geq a_3 \geq \dots \geq a_n$
 $b_1 \geq b_2 \geq b_3 \geq \dots \geq b_n$

3.2.7 $n \sum_{k=1}^n a_k b_k \geq \left(\sum_{k=1}^n a_k \right) \left(\sum_{k=1}^n b_k \right)$

Hölder's Inequality for Sums

If $\frac{1}{p} + \frac{1}{q} = 1, p > 1, q > 1$

3.2.8 $\sum_{k=1}^n |a_k b_k| \leq \left(\sum_{k=1}^n |a_k|^p \right)^{1/p} \left(\sum_{k=1}^n |b_k|^q \right)^{1/q}$;

equality holds if and only if $|b_k| = c|a_k|^{p-1}$ ($c = \text{constant} > 0$). If $p = q = 2$ we get

Cauchy's Inequality

3.2.9 $\left[\sum_{k=1}^n a_k b_k \right]^2 \leq \sum_{k=1}^n a_k^2 \sum_{k=1}^n b_k^2$ (equality for $a_k = c b_k$,
 c constant).

Hölder's Inequality for Integrals

If $\frac{1}{p} + \frac{1}{q} = 1, p > 1, q > 1$

3.2.10 $\int_a^b |f(x)g(x)| dx \leq \left[\int_a^b |f(x)|^p dx \right]^{1/p} \left[\int_a^b |g(x)|^q dx \right]^{1/q}$

equality holds if and only if $|g(x)| = c|f(x)|^{p-1}$
($c = \text{constant} > 0$).

If $p = q = 2$ we get

Schwarz's Inequality

3.2.11 $\left[\int_a^b f(x)g(x) dx \right]^2 \leq \int_a^b [f(x)]^2 dx \int_a^b [g(x)]^2 dx$

Minkowski's Inequality for Sums

If $p > 1$ and $a_k, b_k > 0$ for all k ,

3.2.12

$$\left(\sum_{k=1}^n (a_k + b_k)^p \right)^{1/p} \leq \left(\sum_{k=1}^n a_k^p \right)^{1/p} + \left(\sum_{k=1}^n b_k^p \right)^{1/p},$$

equality holds if and only if $b_k = c a_k$ ($c = \text{constant} > 0$).

Minkowski's Inequality for Integrals

If $p > 1$,

3.2.13

$$\left(\int_a^b |f(x) + g(x)|^p dx \right)^{1/p} \leq \left(\int_a^b |f(x)|^p dx \right)^{1/p} + \left(\int_a^b |g(x)|^p dx \right)^{1/p}$$

equality holds if and only if $g(x) = c f(x)$ ($c = \text{constant} > 0$).

3.3. Rules for Differentiation and Integration Derivatives

3.3.1 $\frac{d}{dx} (cu) = c \frac{du}{dx}, c$ constant

3.3.2 $\frac{d}{dx} (u+v) = \frac{du}{dx} + \frac{dv}{dx}$

3.3.3 $\frac{d}{dx} (uv) = u \frac{dv}{dx} + v \frac{du}{dx}$

3.3.4 $\frac{d}{dx} (u/v) = \frac{v du/dx - u dv/dx}{v^2}$

3.3.5 $\frac{d}{dx} u(v) = \frac{du}{dv} \frac{dv}{dx}$

3.3.6 $\frac{d}{dx} (u^v) = u^v \left(\frac{v}{u} \frac{du}{dx} + \ln u \frac{dv}{dx} \right)$

Leibniz's Theorem for Differentiation of an Integral

3.3.7

$$\frac{d}{dc} \int_{a(c)}^{b(c)} f(x, c) dx = \int_{a(c)}^{b(c)} \frac{\partial}{\partial c} f(x, c) dx + f(b, c) \frac{db}{dc} - f(a, c) \frac{da}{dc}$$

Leibniz's Theorem for Differentiation of a Product

3.3.8

$$\frac{d^n}{dx^n}(uv) = \frac{d^n u}{dx^n} v + \binom{n}{1} \frac{d^{n-1} u}{dx^{n-1}} \frac{dv}{dx} + \binom{n}{2} \frac{d^{n-2} u}{dx^{n-2}} \frac{d^2 v}{dx^2} + \dots + \binom{n}{r} \frac{d^{n-r} u}{dx^{n-r}} \frac{d^r v}{dx^r} + \dots + u \frac{d^n v}{dx^n}$$

3.3.9

$$\frac{dx}{dy} = 1 / \frac{dy}{dx}$$

3.3.10

$$\frac{d^2 x}{dy^2} = -\frac{d^2 y}{dx^2} \left(\frac{dy}{dx}\right)^{-3}$$

3.3.11

$$\frac{d^3 x}{dy^3} = -\left[\frac{d^3 y}{dx^3} \frac{dy}{dx} - 3 \left(\frac{d^2 y}{dx^2}\right)^2\right] \left(\frac{dy}{dx}\right)^{-6}$$

Integration by Parts

3.3.12

$$\int u dv = uv - \int v du$$

3.3.13

$$\int u v dx = \left(\int u dx\right) v - \int \left(\int u dx\right) \frac{dv}{dx} dx$$

Integrals of Rational Algebraic Functions

(Integration constants are omitted)

3.3.14

$$\int (ax+b)^n dx = \frac{(ax+b)^{n+1}}{a(n+1)} \quad (n \neq -1)$$

3.3.15

$$\int \frac{dx}{ax+b} = \frac{1}{a} \ln |ax+b|$$

The following formulas are useful for evaluating $\int \frac{P(x)dx}{(ax^2+bx+c)^n}$ where $P(x)$ is a polynomial and $n > 1$ is an integer.

3.3.16

$$\int \frac{dx}{(ax^2+bx+c)} = \frac{2}{(4ac-b^2)^{1/2}} \arctan \frac{2ax+b}{(4ac-b^2)^{1/2}} \quad (b^2-4ac < 0)$$

3.3.17

$$= \frac{1}{(b^2-4ac)^{1/2}} \ln \left| \frac{2ax+b-(b^2-4ac)^{1/2}}{2ax+b+(b^2-4ac)^{1/2}} \right| \quad (b^2-4ac > 0)$$

3.3.18

$$= \frac{-2}{2ax+b} \quad (b^2-4ac=0)$$

3.3.19

$$\int \frac{xdx}{ax^2+bx+c} = \frac{1}{2a} \ln |ax^2+bx+c| - \frac{b}{2a} \int \frac{dx}{ax^2+bx+c}$$

3.3.20

$$\int \frac{dx}{(a+bx)(c+dx)} = \frac{1}{ad-bc} \ln \left| \frac{c+dx}{a+bx} \right| \quad (ad \neq bc)$$

3.3.21

$$\int \frac{dx}{a^2+b^2x^2} = \frac{1}{ab} \arctan \frac{bx}{a}$$

3.3.22

$$\int \frac{xdx}{a^2+b^2x^2} = \frac{1}{2b^2} \ln |a^2+b^2x^2|$$

3.3.23

$$\int \frac{dx}{a^2-b^2x^2} = \frac{1}{2ab} \ln \left| \frac{a+bx}{a-bx} \right|$$

3.3.24

$$\int \frac{dx}{(x^2+a^2)^2} = \frac{1}{2a^3} \arctan \frac{x}{a} + \frac{x}{2a^2(x^2+a^2)}$$

3.3.25

$$\int \frac{dx}{(x^2-a^2)^2} = \frac{-x}{2a^2(x^2-a^2)} + \frac{1}{4a^3} \ln \left| \frac{a+x}{a-x} \right|$$

Integrals of Irrational Algebraic Functions

3.3.26

$$\int \frac{dx}{[(a+bx)(c+dx)]^{1/2}} = \frac{2}{(-bd)^{1/2}} \arctan \left[\frac{-d(a+bx)}{b(c+dx)} \right]^{1/2} \quad (bd < 0)$$

3.3.27

$$= \frac{-1}{(-bd)^{1/2}} \arcsin \left(\frac{2bdx+ad+bc}{bc-ad} \right) \quad (b > 0, d < 0)$$

3.3.28

$$= \frac{2}{(bd)^{1/2}} \ln |[bd(a+bx)]^{1/2} + b(c+dx)^{1/2}| \quad (bd > 0)$$

3.3.29

$$\int \frac{dx}{(a+bx)^{1/2}(c+dx)} = \frac{2}{[d(bc-ad)]^{1/2}} \arctan \left[\frac{d(a+bx)}{bc-ad} \right]^{1/2} \quad (d(ad-bc) < 0)$$

3.3.30

$$= \frac{1}{[d(ad-bc)]^{1/2}} \ln \left| \frac{d(a+bx)^{1/2} - [d(ad-bc)]^{1/2}}{d(a+bx)^{1/2} + [d(ad-bc)]^{1/2}} \right| \quad (d(ad-bc) > 0)$$

If $z^n = u_n + iv_n$, then $z^{n+1} = u_{n+1} + iv_{n+1}$ where

3.7.23 $u_{n+1} = xu_n - yv_n$; $v_{n+1} = xv_n + yu_n$
 $\Re z^n$ and $\Im z^n$ are called harmonic polynomials.

3.7.24
$$\frac{1}{z} = \frac{\bar{z}}{|z|^2} = \frac{x-iy}{x^2+y^2}$$

3.7.25
$$\frac{1}{z^n} = \frac{\bar{z}^n}{|z|^{2n}} = (z^{-1})^n$$

Roots

3.7.26 $z^{\frac{1}{n}} = \sqrt[n]{z} = r^{\frac{1}{n}} e^{i\theta/n} = r^{\frac{1}{n}} \cos \frac{1}{n}\theta + ir^{\frac{1}{n}} \sin \frac{1}{n}\theta$

If $-\pi < \theta \leq \pi$ this is the principal root. The other root has the opposite sign. The principal root is given by

3.7.27 $z^{\frac{1}{n}} = [\frac{1}{2}(r+x)]^{\frac{1}{n}} \pm i[\frac{1}{2}(r-x)]^{\frac{1}{n}} = u \pm iv$ where $2uv = y$ and where the ambiguous sign is taken to be the same as the sign of y .

3.7.28 $z^{1/n} = r^{1/n} e^{i\theta/n}$, (principal root if $-\pi < \theta \leq \pi$). Other roots are $r^{1/n} e^{i(\theta+2\pi k)/n}$ ($k=1, 2, 3, \dots, n-1$).

Inequalities

3.7.29
$$\left| |z_1| - |z_2| \right| \leq |z_1 \pm z_2| \leq |z_1| + |z_2|$$

Complex Functions, Cauchy-Riemann Equations

$f(z) = f(x+iy) = u(x, y) + iv(x, y)$ where $u(x, y), v(x, y)$ are real, is *analytic* at those points $z = x+iy$ at which

3.7.30
$$\frac{\partial u}{\partial x} = \frac{\partial v}{\partial y}, \quad \frac{\partial u}{\partial y} = -\frac{\partial v}{\partial x}$$

If $z = re^{i\theta}$,

3.7.31
$$\frac{\partial u}{\partial r} = \frac{1}{r} \frac{\partial v}{\partial \theta}, \quad \frac{1}{r} \frac{\partial u}{\partial \theta} = -\frac{\partial v}{\partial r}$$

Laplace's Equation

The functions $u(x, y)$ and $v(x, y)$ are called harmonic functions and satisfy Laplace's equation:

Cartesian Coordinates

3.7.32
$$\frac{\partial^2 u}{\partial x^2} + \frac{\partial^2 u}{\partial y^2} = \frac{\partial^2 v}{\partial x^2} + \frac{\partial^2 v}{\partial y^2} = 0$$

Polar Coordinates

3.7.33
$$r \frac{\partial}{\partial r} \left(r \frac{\partial u}{\partial r} \right) + \frac{\partial^2 u}{\partial \theta^2} = r \frac{\partial}{\partial r} \left(r \frac{\partial v}{\partial r} \right) + \frac{\partial^2 v}{\partial \theta^2} = 0$$

3.8. Algebraic Equations

Solution of Quadratic Equations

3.8.1 Given $az^2 + bz + c = 0$,

$$z_{1,2} = -\left(\frac{b}{2a}\right) \pm \frac{1}{2a} q^{\frac{1}{2}}, \quad q = b^2 - 4ac,$$

$$z_1 + z_2 = -b/a, \quad z_1 z_2 = c/a$$

If $q > 0$, two real roots,
 $q = 0$, two equal roots,
 $q < 0$, pair of complex conjugate roots.

Solution of Cubic Equations

3.8.2 Given $z^3 + a_2 z^2 + a_1 z + a_0 = 0$, let

$$q = \frac{1}{3} a_1 - \frac{1}{9} a_2^2; \quad r = \frac{1}{6} (a_1 a_2 - 3a_0) - \frac{1}{27} a_2^3.$$

If $q^3 + r^2 > 0$, one real root and a pair of complex conjugate roots,

$q^3 + r^2 = 0$, all roots real and at least two are equal,

$q^3 + r^2 < 0$, all roots real (irreducible case).

Let

$$s_1 = [r + (q^3 + r^2)^{\frac{1}{2}}]^{\frac{1}{3}}, \quad s_2 = [r - (q^3 + r^2)^{\frac{1}{2}}]^{\frac{1}{3}}$$

then

$$z_1 = (s_1 + s_2) - \frac{a_2}{3}$$

$$z_2 = -\frac{1}{2} (s_1 + s_2) - \frac{a_2}{3} + \frac{i\sqrt{3}}{2} (s_1 - s_2)$$

$$z_3 = -\frac{1}{2} (s_1 + s_2) - \frac{a_2}{3} - \frac{i\sqrt{3}}{2} (s_1 - s_2).$$

If z_1, z_2, z_3 are the roots of the cubic equation

$$z_1 + z_2 + z_3 = -a_2$$

$$z_1 z_2 + z_1 z_3 + z_2 z_3 = a_1$$

$$z_1 z_2 z_3 = -a_0$$

Solution of Quartic Equations

3.8.3 Given $z^4 + a_3 z^3 + a_2 z^2 + a_1 z + a_0 = 0$, find the real root u_1 of the cubic equation

$$u^3 - a_2 u^2 + (a_1 a_3 - 4a_0)u - (a_1^2 + a_0 a_3^2 - 4a_0 a_2) = 0$$

and determine the four roots of the quartic as solutions of the two quadratic equations

$$v^2 + \left[\frac{a_3}{2} \mp \left(\frac{a_3^2}{4} + u_1 - a_2 \right)^{\frac{1}{2}} \right] v + \frac{u_1}{2} \mp \left[\left(\frac{u_1}{2} \right)^2 - a_0 \right]^{\frac{1}{2}} = 0$$

If all roots of the cubic equation are real, use the value of u_1 which gives real coefficients in the *quadratic equation and select signs so that if

$$z^4 + a_3z^3 + a_2z^2 + a_1z + a_0 = (z^2 + p_1z + q_1)(z^2 + p_2z + q_2),$$

then

$$p_1 + p_2 = a_3, p_1p_2 + q_1 + q_2 = a_2, p_1q_2 + p_2q_1 = a_1, q_1q_2 = a_0.$$

If z_1, z_2, z_3, z_4 are the roots,

$$\Sigma z_i = -a_3, \Sigma z_i z_j = -a_2,$$

$$\Sigma z_i z_j z_k = a_1, \Sigma z_i z_j z_k z_l = a_0.$$

3.9. Successive Approximation Methods

General Comments

3.9.1 Let $x = x_1$ be an approximation to $x = \xi$ where $f(\xi) = 0$ and both x_1 and ξ are in the interval $a \leq x \leq b$. We define

$$x_{n+1} = x_n + c_n f(x_n) \quad (n=1, 2, \dots).$$

Then, if $f'(x) \geq 0$ and the constants c_n are negative and bounded, the sequence x_n converges monotonically to the root ξ .

If $c_n = c = \text{constant} < 0$ and $f'(x) > 0$, then the process converges but not necessarily monotonically.

Degree of Convergence of an Approximation Process

3.9.2 Let x_1, x_2, x_3, \dots be an infinite sequence of approximations to a number ξ . Then, if

$$|x_{n+1} - \xi| < A|x_n - \xi|^k, \quad (n=1, 2, \dots)$$

where A and k are independent of n , the sequence is said to have convergence of at most the k th degree (or order or index) to ξ . If $k=1$ and $A < 1$ the convergence is linear; if $k=2$ the convergence is quadratic.

Regula Falsi (False Position)

3.9.3 Given $y=f(x)$ to find ξ such that $f(\xi)=0$, choose x_0 and x_1 such that $f(x_0)$ and $f(x_1)$ have opposite signs and compute

$$x_2 = x_1 - \frac{(x_1 - x_0)}{(f_1 - f_0)} f_1 = \frac{f_1 x_0 - f_0 x_1}{f_1 - f_0}.$$

Then continue with x_2 and either of x_0 or x_1 for which $f(x_0)$ or $f(x_1)$ is of opposite sign to $f(x_2)$.

Regula falsi is equivalent to inverse linear interpolation.

*See page 11.

Method of Iteration (Successive Substitution)

3.9.4 The iteration scheme $x_{k+1} = F(x_k)$ will converge to a zero of $x = F(x)$ if

$$(1) |F'(x)| \leq q < 1 \text{ for } a \leq x \leq b,$$

$$(2) a \leq x_0 \pm \frac{|F(x_0) - x_0|}{1 - q} \leq b.$$

Newton's Method of Successive Approximations

3.9.5

Newton's Rule

If $x = x_k$ is an approximation to the solution $x = \xi$ of $f(x) = 0$ then the sequence

$$x_{k+1} = x_k - \frac{f(x_k)}{f'(x_k)}$$

will converge quadratically to $x = \xi$: (if instead of the condition (2) above),

(1) *Monotonic convergence*, $f(x_0)f''(x_0) > 0$ and $f'(x), f''(x)$ do not change sign in the interval (x_0, ξ) , or

(2) *Oscillatory convergence*, $f(x_0)f''(x_0) < 0$ and $f'(x), f''(x)$ do not change sign in the interval (x_0, x_1) , $x_0 \leq \xi \leq x_1$.

Newton's Method Applied to Real n th Roots

3.9.6 Given $x^n = N$, if x_k is an approximation $x = N^{1/n}$ then the sequence

$$x_{k+1} = \frac{1}{n} \left[\frac{N}{x_k^{n-1}} + (n-1)x_k \right]$$

will converge quadratically to x .

$$\text{If } n=2, x_{k+1} = \frac{1}{2} \left(\frac{N}{x_k} + x_k \right),$$

$$\text{If } n=3, x_{k+1} = \frac{1}{3} \left(\frac{N}{x_k^2} + 2x_k \right).$$

Aitken's δ^2 -Process for Acceleration of Sequences

3.9.7 If x_k, x_{k+1}, x_{k+2} are three successive iterates in a sequence converging with an error which is approximately in geometric progression, then

$$\bar{x}_k = x_k - \frac{(x_k - x_{k+1})^2}{\Delta^2 x_k} = \frac{x_k x_{k+2} - x_{k+1}^2}{\Delta^2 x_k},$$

$$\Delta^2 x_k = x_k - 2x_{k+1} + x_{k+2}$$

is an improved estimate of x . In fact, if $x_k = x + O(\lambda^k)$ then $\bar{x} = x + O(\lambda^k)$, $|\lambda| < 1$.

3.10. Theorems on Continued Fractions

Definitions

3.10.1

(1) Let
$$f = b_0 + \frac{a_1}{b_1 + \frac{a_2}{b_2 + \frac{a_3}{b_3 + \dots}}}$$

$$= b_0 + \frac{a_1}{b_1 +} \frac{a_2}{b_2 +} \frac{a_3}{b_3 +} \dots$$

If the number of terms is finite, f is called a terminating continued fraction. If the number of terms is infinite, f is called an infinite continued fraction and the terminating fraction

$$f_n = \frac{A_n}{B_n} = b_0 + \frac{a_1}{b_1 +} \frac{a_2}{b_2 +} \dots \frac{a_n}{b_n}$$

is called the n th convergent of f .

(2) If $\lim_{n \rightarrow \infty} \frac{A_n}{B_n}$ exists, the infinite continued fraction f is said to be convergent. If $a_i = 1$ and the b_i are integers there is always convergence.

Theorems

(1) If a_i and b_i are positive then $f_{2n} < f_{2n+2}$, $f_{2n-1} > f_{2n+1}$.

(2) If $f_n = \frac{A_n}{B_n}$,

$$A_n = b_n A_{n-1} + a_n A_{n-2}$$

$$B_n = b_n B_{n-1} + a_n B_{n-2}$$

where $A_{-1} = 1, A_0 = b_0, B_{-1} = 0, B_0 = 1$.

(3)
$$\begin{bmatrix} A_n \\ B_n \end{bmatrix} = \begin{bmatrix} A_{n-1} & A_{n-2} \\ B_{n-1} & B_{n-2} \end{bmatrix} \begin{bmatrix} b_n \\ a_n \end{bmatrix}$$

(4)
$$A_n B_{n-1} - A_{n-1} B_n = (-1)^{n-1} \prod_{k=1}^n a_k$$

(5) For every $n \geq 0$,

$$f_n = b_0 + \frac{c_1 a_1}{c_1 b_1 +} \frac{c_1 c_2 a_2}{c_2 b_2 +} \frac{c_2 c_3 a_3}{c_3 b_3 +} \dots \frac{c_{n-1} c_n a_n}{c_n b_n}$$

(6)
$$1 + \frac{b_2}{b_2 +} \frac{b_3}{b_3 +} \dots \frac{b_n}{b_n +}$$

$$= \frac{1}{1 -} \frac{b_2}{b_2 + 1 -} \frac{b_3}{b_3 + 1 -} \dots \frac{b_n}{b_n + 1 -}$$

$$\frac{1}{u_1 +} \frac{1}{u_2 +} \dots + \frac{1}{u_n} = \frac{1}{u_1 -} \frac{u_1^2}{u_1 + u_2 -} \dots \frac{u_{n-1}^2}{-u_{n-1} + u_n}$$

$$\frac{1}{a_0} \frac{x}{a_0 a_1} + \frac{x^2}{a_0 a_1 a_2} \dots + (-1)^n \frac{x^n}{a_0 a_1 a_2 \dots a_n}$$

$$= \frac{1}{a_0 +} \frac{a_0 x}{a_1 - x +} \frac{a_1 x}{a_2 - x +} \dots \frac{a_{n-1} x}{+ a_n - x}$$

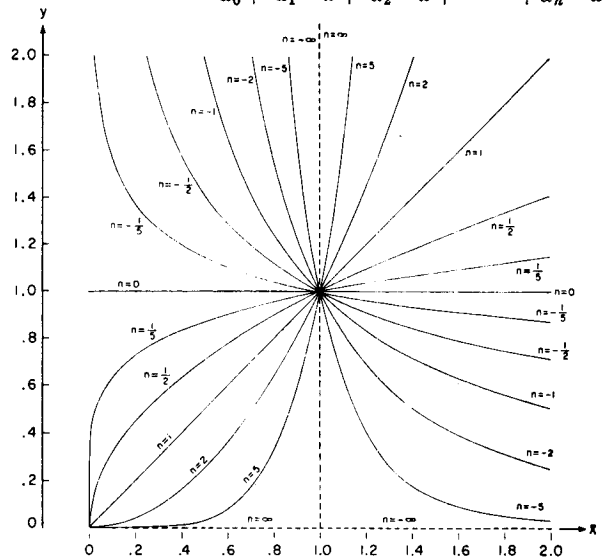

FIGURE 3.1. $y = x^n$.
 $\pm n = 0, \frac{1}{5}, \frac{1}{2}, 1, 2, 5$.

Numerical Methods

3.11. Use and Extension of the Tables

Example 1. Compute x^{19} and x^{47} for $x=29$ using Table 3.1.

$$x^{19} = x^9 \cdot x^{10}$$

$$= (1.45071 4598 \cdot 10^{13})(4.20707 2333 \cdot 10^{14})$$

$$= 6.10326 1248 \cdot 10^{27}$$

$$x^{47} = (x^{24})^2 / x$$

$$= (1.25184 9008 \cdot 10^{35})^2 / 29$$

$$= 5.40388 2547 \cdot 10^{68}$$

Example 2. Compute $x^{-3/4}$ for $x=9.19826$.

$$(9.19826)^{1/4} = (919.826/100)^{1/4} = (919.826)^{1/4} / 10^{1/4}$$

Linear interpolation in Table 3.1 gives $(919.826)^{1/4} \approx 5.507144$.

By Newton's method for fourth roots with $N=919.826$,

$$\frac{1}{4} \left[\frac{919.826}{(5.507144)^3} + 3(5.507144) \right] = 5.50714 3845$$

Repetition yields the same result. Thus,

$$x^{1/4} = 5.50714 3845 / 10^{1/4} = 1.74151 1796,$$

$$x^{-3/4} = x^{1/4} / x = .18933 05683.$$

3.12. Computing Techniques

Example 3. Solve the quadratic equation $x^2 - 18.2x + .056$ given the coefficients as $18.2 \pm .1$,

*See page 11.

.056 ± .001. From 3.8.1 the solution is

$$\begin{aligned} x &= \frac{1}{2}(18.2 \pm [(18.2)^2 - 4(.056)]^{\frac{1}{2}}) \\ &= \frac{1}{2}(18.2 \pm [331.016]^{\frac{1}{2}}) = \frac{1}{2}(18.2 \pm 18.1939) \\ &= 18.1969, .003 \end{aligned}$$

The smaller root may be obtained more accurately from

$$* \quad .056/18.1969 = .0031 \pm .0001.$$

Example 4. Compute $(-3 + .0076i)^{\frac{1}{2}}$.

From 3.7.26, $(-3 + .0076i)^{\frac{1}{2}} = u + iv$ where

$$u = \frac{y}{2v}, v = \left(\frac{r-x}{2}\right)^{\frac{1}{2}}, r = (x^2 + y^2)^{\frac{1}{2}}$$

Thus

$$r = [(-3)^2 + (.0076)^2]^{\frac{1}{2}} = (9.00005776)^{\frac{1}{2}} = 3.000009627$$

$$v = \left[\frac{3.000009627 - (-3)}{2} \right]^{\frac{1}{2}} = 1.732052196$$

$$u = \frac{y}{2v} = \frac{.0076}{2(1.732052196)} = .00219392926$$

We note that the principal square root has been computed.

Example 6. Solve the quartic equation

$$\begin{aligned} x^4 - 2.377524922x^3 + 6.073505741x^2 \\ - 11.17938023x + 9.052655259 = 0. \end{aligned}$$

Resolution Into Quadratic Factors

$$(x^2 + p_1x + q_1)(x^2 + p_2x + q_2)$$

by Inverse Interpolation

Starting with the trial value $q_1 = 1$ we compute successively

q_1	$q_2 = \frac{a_0}{q_1}$	$p_1 = \frac{a_1 - a_3q_1}{q_2 - q_1}$	$p_2 = a_3 - p_1$	$y(q_1) = q_1 + q_2 + p_1p_2 - a_2$
1	9.053	-1.093	-1.284	5.383
2	4.526	-2.543	.165	.032
2.2	4.115	-3.106	.729	-2.023

q_1	q_2	p_1	p_2	$y(q_1)$
2.0041	4.517067640	-2.55259257	.17506765	.00078552
2.0042	4.516842260	-2.55282851	.17530358	.00001655
2.0043	4.516616903	-2.55306447	.17553955	-.00075263

Inverse interpolation gives $q_1 = 2.004202152$, and we get finally,

q_1	q_2	p_1	p_2	$y(q_1)$
2.004202152	4.516837410	-2.55283358	.175308659	-.000000011

Example 5. Solve the cubic equation $x^3 - 18.1x - 34.8 = 0$.

To use Newton's method we first form the table of $f(x) = x^3 - 18.1x - 34.8$

x	$f(x)$
4	-43.2
5	-.3
6	72.6
7	181.5

We obtain by linear inverse interpolation:

$$x_0 = 5 + \frac{0 - (-0.3)}{72.6 - (-0.3)} = 5.004.$$

Using Newton's method, $f'(x) = 3x^2 - 18.1$ we get

$$\begin{aligned} x_1 &\approx x_0 - f(x_0)/f'(x_0) \\ &\approx 5.004 - \frac{(-.072159936)}{57.020048} \approx 5.00526. \end{aligned}$$

Repetition yields $x_1 = 5.005265097$. Dividing $f(x)$ by $x - 5.005265097$ gives $x^2 + 5.005265097x + 6.95267869$ the zeros of which are $-2.502632549 \pm .83036800i$.

We seek that value of q_1 for which $y(q_1) = 0$. Inverse interpolation in $y(q_1)$ gives $y(q_1) \approx 0$ for $q_1 \approx 2.003$. Then,

q_1	q_2	p_1	p_2	$y(q_1)$
2.003	4.520	-2.550	.172	.011

Inverse interpolation between $q_1 = 2.2$ and $q_1 = 2.003$ gives $q_1 = 2.0041$, and thus,

Double Precision Multiplication and Division on a Desk Calculator

Example 7. Multiply $M=20243\ 97459\ 71664\ 32102$ by $m=69732\ 82428\ 43662\ 95023$ on a $10 \times 10 \times 20$ desk calculating machine.

Let $M_0=20243\ 97459$, $M_1=71664\ 32102$, $m_0=69732\ 82428$, $m_1=43662\ 95023$. Then $Mm=M_0m_010^{20}+(M_0m_1+M_1m_0)10^{10}+M_1m_1$.

(1) Multiply $M_1m_1=31290\ 75681\ 96300\ 28346$ and record the digits 96300 28346 appearing in positions 1 to 10 of the product dial.

(2) Transfer the digits 31290 75681 from positions 11 to 20 of the product dial to positions 1 to 10 of the product dial.

(3) Multiply cumulatively $M_1m_0+M_0m_1+31290\ 75681=58812\ 67160\ 12663\ 25894$ and record the digits 12663 25894 in positions 1 to 10.

(4) Transfer the digits 58812 67160 from positions 11 to 20 to positions 1 to 10.

(5) Multiply cumulatively $M_0m_0+58812\ 67160=14116\ 69523\ 40138\ 17612$. The results as obtained are shown below,

$$\begin{array}{r} 96300\ 28346 \\ 12663\ 25894 \\ \hline 14116\ 69523\ 40138\ 17612 \\ 14116\ 69523\ 40138\ 17612\ 12663\ 25894\ 96300\ 28346 \end{array}$$

If the product Mm is wanted to 20 digits, only the result obtained in step 5 need be recorded. Further, if the allowable error in the 20th place is a unit, the operation M_1m_1 may be omitted. When either of the factors M or m contains less than 20 digits it is convenient to position the numbers as if they both had 20 digits. This multiplication process may be extended to any higher accuracy desired.

Example 8. Divide $N=14116\ 69523\ 40138\ 17612$ by $d=20243\ 97459\ 71664\ 32102$.

Method (1)—*linear interpolation.*

$$\begin{array}{l} N/20243\ 97459 \cdot 10^{10} = .69732\ 82430\ 90519\ 39054 \\ N/20243\ 97460 \cdot 10^{10} = .69732\ 82427\ 46057\ 26941 \\ \hline \text{Difference} = 3\ 44462\ 12113. \end{array}$$

Difference $\times .71664\ 32102 = 24685\ 644028 \cdot 10^{-20}$ (note this is an 11×10 multiplication).

$$\begin{array}{l} \text{Quotient} = \\ (69732\ 82430\ 90519\ 39054 - 246856\ 44028) \cdot 10^{-20} \\ = .69732\ 82428\ 43662\ 95026 \end{array}$$

There is an error of 3 units in the 20th place due to neglect of the contribution from second differences.

Method (2)—If N and d are numbers each not more than 19 digits let $N=N_1+N_010^9$, $d=d_1+d_010^9$ where N_0 and d_0 contain 10 digits and N_1 and d_1 not more than 9 digits. Then

$$\frac{N}{d} = \frac{N_010^9 + N_1}{d_010^9 + d_1} \approx \frac{1}{d_010^9} \left[N - \frac{N_0d_1}{d_0} \right]$$

Here

$$\begin{array}{l} N = 14116\ 69523\ 40138\ 1761, \\ d = 20243\ 97459\ 71664\ 3210 \\ N_0 = 14116\ 69523, d_0 = 20243\ 97459, \\ d_1 = 71664\ 3210 \end{array}$$

- (1) $N_0d_1 = 10116\ 63378\ 42188\ 8830$ (product dial).
- (2) $(N_0d_1)/d_0 = 49973\ 55504$ (quotient dial).
- (3) $N - (N_0d_1)/d_0 = 14116\ 69522\ 90164\ 62106$ (product dial).
- (4) $[N - (N_0d_1)/d_0]/d_010^9 = .69732\ 82428$ = first 10 digits of quotient in quotient dial. Remainder $= r = 08839\ 11654$, in positions 1 to 10 of product dial.

(5) $r/(d_010^9) = .43662\ 9502 \cdot 10^{-10}$ = next 9 digits of quotient. $N/d = .69732\ 82428\ 43662\ 9502$. This method may be modified to give the quotient of 20 digit numbers. Method (1) may be extended to quotients of numbers containing more than 20 digits by employing higher order interpolation.

Example 9. Sum the series $S = 1 - \frac{1}{2} + \frac{1}{3} - \frac{1}{4} + \dots$ to 5D using the Euler transform.

The sum of the first 8 terms is .634524 to 6D. If $u_n = 1/n$ we get

n	u_n	Δu_n	$\Delta^2 u_n$	$\Delta^3 u_n$	$\Delta^4 u_n$
9	.111111	-11111			
10	.100000	-9091	2020		
11	.090909	-7576	1515	-505	156
12	.083333	-6410	1166	-349	
13	.076923				

From 3.6.27 we then obtain

$$\begin{aligned} S &= .634524 + \frac{.111111}{2} - \frac{(-.011111)}{2^2} + \frac{.002020}{2^3} \\ &\quad - \frac{(-.000505)}{2^4} + \frac{.000156}{2^5} \\ &= .634524 + .055556 + .002778 + .000253 \\ &\quad + .000032 + .000005 \\ &= .693148 \\ (S = \ln 2 = .6931472 \text{ to } 7D). \end{aligned}$$

Example 10. Evaluate the integral $\int_0^\infty \frac{\sin x}{x} dx = \frac{\pi}{2}$ to 4D using the Euler transform.

$$\int_0^\infty \frac{\sin x}{x} dx = \sum_{k=0}^\infty \int_{k\pi}^{(k+1)\pi} \frac{\sin x}{x} dx$$

$$= \sum_{k=0}^\infty \int_0^\pi \frac{\sin(k\pi+t)}{k\pi+t} dt = \sum_{k=0}^\infty (-1)^k \int_0^\pi \frac{\sin t}{k\pi+t} dt.$$

Evaluating the integrals in the last sum by numerical integration we get

k	$\int_0^\pi \frac{\sin t}{k\pi+t} dt$				
0	1.85194				
1	.43379				
2	.25661				
3	.18260	Δ	Δ^2	Δ^3	Δ^4
4	.14180				
5	.11593	-2587	799		
6	.09805	-1788	478	-321	153
7	.08495	-1310	310	-168	
8	.07495	-1000			

The sum to $k=3$ is 1.49216. Applying the Euler transform to the remainder we obtain

$$\frac{1}{2} (.14180) - \frac{1}{2^2} (-.02587) + \frac{1}{2^3} (.00799)$$

$$- \frac{1}{2^4} (-.00321) + \frac{1}{2^5} (.00153)$$

$$= .07090 + .00647 + .00100 + .00020$$

$$+ .00005$$

$$= .07862$$

We obtain the value of the integral as 1.57078 as compared with 1.57080.

Example 11. Sum the series $\sum_{k=1}^\infty k^{-2} = \frac{\pi^2}{6}$ using the Euler-Maclaurin summation formula. From 3.6.28 we have for $n = \infty$,

$$\sum_{k=1}^\infty k^{-2} = \sum_{k=1}^{10} k^{-2} + \sum_{k=1}^\infty (k+10)^{-2}$$

$$= \sum_{k=1}^{10} k^{-2} + \int_0^\infty f(k) dk - \frac{1}{2} f_0 - \frac{1}{12} f'_0$$

$$+ \frac{1}{720} f''_0 - \dots$$

where $f(k) = (k+10)^{-2}$. Thus,

$$\sum_{k=1}^{10} k^{-2} = 1.549767731 + 1$$

$$- .005 + .000166667 - .000000333$$

$$= 1.644934065,$$

as compared with $\frac{\pi^2}{6} = 1.644934067$.

Example 12. Compute

$$\arctan x = \frac{x}{1+} \frac{x^2}{3+} \frac{4x^2}{5+} \frac{9x^2}{7+} \dots$$

to 5D for $x = .2$. Here $a_1 = x$, $a_n = (n-1)^2 x^2$ for $n > 1$, $b_0 = 0$, $b_n = 2n-1$, $A_{-1} = 1$, $B_{-1} = 0$, $A_0 = 0$, $B_0 = 1$.

For $n \geq 1$

$$\begin{bmatrix} A_n \\ B_n \end{bmatrix} = \begin{bmatrix} A_{n-1} A_{n-2} \\ B_{n-1} B_{n-2} \end{bmatrix} \begin{bmatrix} 2n-1 \\ (n-1)^2 x^2 \end{bmatrix} \frac{A_0}{B_0} = 0$$

$$\begin{bmatrix} A_1 \\ B_1 \end{bmatrix} = \begin{bmatrix} 0 & 1 \\ 1 & 0 \end{bmatrix} \begin{bmatrix} 1 \\ .2 \end{bmatrix} = \begin{bmatrix} .2 \\ 1 \end{bmatrix} \frac{A_1}{B_1} = .2$$

$$\begin{bmatrix} A_2 \\ B_2 \end{bmatrix} = \begin{bmatrix} .2 & 0 \\ 1 & 1 \end{bmatrix} \begin{bmatrix} 3 \\ .04 \end{bmatrix} = \begin{bmatrix} .6 \\ 3.04 \end{bmatrix} \frac{A_2}{B_2} = .197368$$

$$\begin{bmatrix} A_3 \\ B_3 \end{bmatrix} = \begin{bmatrix} .6 & .2 \\ 3.04 & 1 \end{bmatrix} \begin{bmatrix} 5 \\ .16 \end{bmatrix} = \begin{bmatrix} 3.032 \\ 15.36 \end{bmatrix} \frac{A_3}{B_3} = .197396$$

$$\begin{bmatrix} A_4 \\ B_4 \end{bmatrix} = \begin{bmatrix} 3.032 & .6 \\ 15.36 & 3.04 \end{bmatrix} \begin{bmatrix} 7 \\ .36 \end{bmatrix} = \begin{bmatrix} 21.440 \\ 108.6144 \end{bmatrix} \frac{A_4}{B_4} = .197396$$

Note that in carrying out the recurrence method for computing continued fractions the numerators A_n and the denominators B_n must be used as originally computed. The numerators and denominators obtained by reducing A_n/B_n to lower terms must not be used.

References

Texts

- [3.1] R. A. Buckingham, Numerical methods (Pitman Publishing Corp., New York, N.Y., 1957).
- [3.2] T. Fort, Finite differences (Clarendon Press, Oxford, England, 1948).
- [3.3] L. Fox, The use and construction of mathematical tables, *Mathematical Tables*, vol. 1, National Physical Laboratory (Her Majesty's Stationery Office, London, England, 1956).
- [3.4] G. H. Hardy, A course of pure mathematics, 9th ed. (Cambridge Univ. Press, Cambridge, England, and The Macmillan Co., New York, N.Y., 1947).
- [3.5] D. R. Hartree, Numerical analysis (Clarendon Press, Oxford, England, 1952).
- [3.6] F. B. Hildebrand, Introduction to numerical analysis (McGraw-Hill Book Co., Inc., New York, N.Y., 1956).
- [3.7] A. S. Householder, Principles of numerical analysis (McGraw-Hill Book Co., Inc., New York, N.Y., 1953).
- [3.8] L. V. Kantorowitsch and V. I. Krylow, Näherungsmethoden der Höheren Analysis (VEB Deutscher Verlag der Wissenschaften, Berlin, Germany, 1956; translated from Russian, Moscow, U.S.S.R., 1952).
- [3.9] K. Knopp, Theory and application of infinite series (Blackie and Son, Ltd., London, England, 1951).
- [3.10] Z. Kopal, Numerical analysis (John Wiley & Sons, Inc., New York, N.Y., 1955).
- [3.11] G. Kowalewski, Interpolation und genäherte Quadratur (B. G. Teubner, Leipzig, Germany, 1932).
- [3.12] K. S. Kunz, Numerical analysis (McGraw-Hill Book Co., Inc., New York, N.Y., 1957).
- [3.13] C. Lanczos, Applied analysis (Prentice-Hall, Inc., Englewood Cliffs, N.J., 1956).
- [3.14] I. M. Longman, Note on a method for computing infinite integrals of oscillatory functions, *Proc. Cambridge Philos. Soc.* **52**, 764 (1956).
- [3.15] S. E. Mikeladze, Numerical methods of mathematical analysis (Russian) (Gos. Izdat. Tehn.-Teor. Lit., Moscow, U.S.S.R., 1953).
- [3.16] W. E. Milne, Numerical calculus (Princeton Univ. Press, Princeton, N.J., 1949).
- [3.17] L. M. Milne-Thomson, The calculus of finite differences (Macmillan and Co., Ltd., London, England, 1951).
- [3.18] H. Mineur, Techniques de calcul numérique (Librairie Polytechnique Ch. Béranger, Paris, France, 1952).
- [3.19] National Physical Laboratory, Modern computing methods, Notes on Applied Science No. 16 (Her Majesty's Stationery Office, London, England, 1957).
- [3.20] J. B. Rosser, Transformations to speed the convergence of series, *J. Research NBS* **46**, 56-64 (1951).
- [3.21] J. B. Scarborough, Numerical mathematical analysis, 3d ed. (The Johns Hopkins Press, Baltimore, Md.; Oxford Univ. Press, London, England, 1955).
- [3.22] J. F. Steffensen, Interpolation (Chelsea Publishing Co., New York, N.Y., 1950).
- [3.23] H. S. Wall, Analytic theory of continued fractions (D. Van Nostrand Co., Inc., New York, N.Y., 1948).
- [3.24] E. T. Whittaker and G. Robinson, The calculus of observations, 4th ed. (Blackie and Son, Ltd., London, England, 1944).
- [3.25] R. Zurmühl, Praktische Mathematik (Springer-Verlag, Berlin, Germany, 1953).

Mathematical Tables and Collections of Formulas

- [3.26] E. P. Adams, Smithsonian mathematical formulae and tables of elliptic functions, 3d reprint (The Smithsonian Institution, Washington, D.C., 1957).
- [3.27] L. J. Comrie, Barlow's tables of squares, cubes, square roots, cube roots and reciprocals of all integers up to 12,500 (Chemical Publishing Co., Inc., New York, N.Y., 1954).
- [3.28] H. B. Dwight, Tables of integrals and other mathematical data, 3d ed. (The Macmillan Co., New York, N.Y., 1957).
- [3.29] Gt. Britain H.M. Nautical Almanac Office, Interpolation and allied tables (Her Majesty's Stationery Office, London, England, 1956).
- [3.30] B. O. Peirce, A short table of integrals, 4th ed. (Ginn and Co., Boston, Mass., 1956).
- [3.31] G. Schulz, Formelsammlung zur praktischen Mathematik (de Gruyter and Co., Berlin, Germany, 1945).

Table 3.1 POWERS AND ROOTS n^k

k						
1	See Examples 1-5 for use	$n^1 =$	2		3	4
2	of the table.	$n^2 =$	4		9	16
3		$n^3 =$	8		27	64
4		$n^4 =$	16		81	256
5		$n^5 =$	32		243	1024
6	Floating decimal notation:	$n^6 =$	64		729	4096
7		$n^7 =$	128		2187	16384
8	$9^{10} = 34867\ 84401$	$n^8 =$	256		6561	65536
9		$n^9 =$	512		19683	2 62144
10	$= (9)3.4867\ 84401$	$n^{10} =$	1024		59049	10 48576
24		$n^{24} =$	167 77216	(11)2.8242 95365		(14)2.8147 49767
1/2		$n^{1/2} =$	1.4142 13562	1.7320 50808		2.0000 00000
1/3		$n^{1/3} =$	1.2599 21050	1.4422 49570		1.5874 01052
1/4		$n^{1/4} =$	1.1892 07115	1.3160 74013		1.4142 13562
1/5		$n^{1/5} =$	1.1486 98355	1.2457 30940		1.3195 07911
1	5	6	7	8	9	
2	25	36	49	64	81	
3	125	216	343	512	729	
4	625	1296	2401	4096	6561	
5	3125	7776	16807	32768	59049	
6	15625	46656	1 17649	2 62144	5 31441	
7	78125	2 79936	8 23543	20 97152	47 82969	
8	3 90625	16 79616	57 64801	167 77216	430 46721	
9	19 53125	100 77696	403 53607	1342 17728	3874 20489	
10	97 65625	604 66176	2824 75249	(9)1.0737 41824	(9)3.4867 84401	
24	(16)5.9604 64478	(18)4.7383 81338	(20)1.9158 12314	(21)4.7223 66483	(22)7.9766 44308	
1/2	2.2360 67977	2.4494 89743	2.6457 51311	2.8284 27125	3.0000 00000	
1/3	1.7099 75947	1.8171 20593	1.9129 31183	2.0000 00000	2.0800 83823	
1/4	1.4953 48781	1.5650 84580	1.6265 76562	1.6817 92831	1.7320 50808	
1/5	1.3797 29662	1.4309 69081	1.4757 73162	1.5157 16567	1.5518 45574	
1	10	11	12	13	14	
2	100	121	144	169	196	
3	1000	1331	1728	2197	2744	
4	10000	14641	20736	28561	38416	
5	1 00000	1 61051	2 48832	3 71293	5 37824	
6	10 00000	17 71561	29 85984	48 26809	75 29536	
7	100 00000	194 87171	358 31808	627 48517	1054 13504	
8	1000 00000	2143 58881	4299 81696	8157 30721	(9)1.4757 89056	
9	(9)1.0000 00000	(9)2.3579 47691	(9)5.1597 80352	(10)1.0604 49937	(10)2.0661 04678	
10	(10)1.0000 00000	(10)2.5937 42460	(10)6.1917 36422	(11)1.3785 84918	(11)2.8925 46550	
24	(24)1.0000 00000	(24)9.8497 32676	(25)7.9496 84720	(26)5.4280 07704	(27)3.2141 99700	
1/2	3.1622 77660	3.3166 24790	3.4641 01615	3.6055 51275	3.7416 57387	
1/3	2.1544 34690	2.2239 80091	2.2894 28485	2.3513 34688	2.4101 42264	
1/4	1.7782 79410	1.8211 60287	1.8612 09718	1.8988 28922	1.9343 66420	
1/5	1.5848 93192	1.6153 94266	1.6437 51830	1.6702 77652	1.6952 18203	
1	15	16	17	18	19	
2	225	256	289	324	361	
3	3375	4096	4913	5832	6859	
4	50625	65536	83521	1 04976	1 30321	
5	7 59375	10 48576	14 19857	18 89568	24 76099	
6	113 90625	167 77216	241 37569	340 12224	470 45881	
7	1708 59375	2684 35456	4103 38673	6122 20032	8938 71739	
8	(9)2.5628 90625	(9)4.2949 67296	(9)6.9757 57441	(10)1.1019 96058	(10)1.6983 56304	
9	(10)3.8443 35938	(10)6.8719 47674	(11)1.1858 78765	(11)1.9835 92904	(11)3.2268 76978	
10	(11)5.7665 03906	(12)1.0995 11628	(12)2.0159 93900	(12)3.5704 67227	(12)6.1310 66258	
24	(28)1.6834 11220	(28)7.9228 16251	(29)3.3944 86713	(30)1.3382 58845	(30)4.8987 62931	
1/2	3.8729 83346	4.0000 00000	4.1231 05626	4.2426 40687	4.3588 98944	
1/3	2.4662 12074	2.5198 42100	2.5712 81591	2.6207 41394	2.6684 01649	
1/4	1.9679 89671	2.0000 00000	2.0305 43185	2.0597 67144	2.0877 97630	
1/5	1.7187 71928	1.7411 01127	1.7623 40348	1.7826 02458	1.8019 83127	
1	20	21	22	23	24	
2	400	441	484	529	576	
3	8000	9261	10648	12167	13824	
4	1 60000	1 94481	2 34256	2 79841	3 31776	
5	32 00000	40 84101	51 53632	64 36343	79 62624	
6	640 00000	857 66121	1133 79904	1480 35889	1911 02976	
7	(9)1.2800 00000	(9)1.8010 88541	(9)2.4943 57888	(9)3.4048 25447	(9)4.5864 71424	
8	(10)2.5600 00000	(10)3.7822 85936	(10)5.4875 87354	(10)7.8310 98528	(11)1.1007 53142	
9	(11)5.1200 00000	(11)7.9428 00466	(12)1.2072 69218	(12)1.8011 52661	(12)2.6418 07540	
10	(13)1.0240 00000	(13)1.6679 88098	(13)2.6559 92279	(13)4.1426 51121	(13)6.3403 38097	
24	(31)1.6777 21600	(31)5.4108 19838	(32)1.6525 10926	(32)4.8025 07640	(33)1.3337 35777	
1/2	4.4721 35955	4.5825 75695	4.6904 15760	4.7958 31523	4.8989 79486	
1/3	2.7144 17617	2.7589 24176	2.8020 39331	2.8438 66980	2.8844 99141	
1/4	2.1147 42527	2.1406 95143	2.1657 36771	2.1899 38703	2.2133 63839	
1/5	1.8205 64203	1.8384 16287	1.8556 00736	1.8721 71231	1.8881 75023	

ELEMENTARY ANALYTICAL METHODS

POWERS AND ROOTS n^k

Table 3.1

k	25	26	27	28	29
1	625	676	729	784	841
2	15625	17576	19683	21952	24389
3	3 90625	4 56976	5 31441	6 14656	7 07281
4	97 65625	118 81376	143 48907	172 10368	205 11149
5	2441 40625	3089 15776	3874 20489	4818 90304	5948 23321
6	(9) 6.1035 15625	(9) 8.0318 10176	(10) 1.0460 35320	(10) 1.3492 92851	(10) 1.7249 87631
7	(11) 1.5258 78906	(11) 2.0882 70646	(11) 2.8242 95365	(11) 3.7780 19983	(11) 5.0024 64130
8	(12) 3.8146 97266	(12) 5.4295 03679	(12) 7.6255 97485	(12) 1.0578 45595	(12) 1.4507 14598
9	(13) 9.5367 43164	(13) 1.4116 70957	(14) 2.0589 11321	(13) 2.9619 67667	(13) 4.2070 72333
10	(33) 3.5527 13679	(33) 9.1066 85770	(34) 2.2528 39954	(34) 5.3925 32264	(35) 1.2518 49008
1/2	5.0000 00000	5.0990 19514	5.1961 52423	5.2915 02622	5.3851 64807
1/3	2.9240 17738	2.9624 96068	3.0000 00000	3.0365 88972	3.0723 16826
1/4	2.2360 67977	2.2581 00864	2.2795 07057	2.3003 26634	2.3205 95787
1/5	1.9036 53939	1.9186 45192	1.9331 82045	1.9472 94361	1.9610 09057
1	30	31	32	33	34
2	900	961	1024	1089	1156
3	27000	29791	32768	35937	39304
4	8 10000	9 23521	10 48576	11 85921	13 36336
5	243 00000	286 29151	335 54432	391 35393	454 35424
6	7290 00000	8875 03681	(9) 1.0737 41824	(9) 1.2914 67969	(9) 1.5448 04416
7	(10) 2.1870 00000	(10) 2.7512 61411	(10) 3.4359 73837	(10) 4.2618 44298	(10) 5.2523 35014
8	(11) 6.5610 00000	(11) 8.5289 10374	(11) 1.0995 11628	(11) 1.4064 08618	(11) 1.7857 93905
9	(12) 1.9683 00000	(12) 2.6439 62216	(12) 3.5184 37209	(12) 4.6411 48440	(12) 6.0716 99277
10	(13) 5.9049 00000	(13) 8.1962 82870	(14) 1.1258 99907	(13) 1.5315 78985	(14) 2.0643 77754
24	(35) 2.8242 95365	(35) 6.2041 26610	(36) 1.3292 27996	(36) 2.7818 55434	(36) 5.6950 03680
1/2	5.4772 25575	5.5677 64363	5.6568 54249	5.7445 62647	5.8309 51895
1/3	3.1072 32506	3.1413 80652	3.1748 02104	3.2075 34330	3.2396 11801
1/4	2.3403 47319	2.3596 11062	2.3784 14230	2.3967 81727	2.4147 36403
1/5	1.9743 50486	1.9873 40755	2.0000 00000	2.0123 46617	2.0243 97459
1	35	36	37	38	39
2	1225	1296	1369	1444	1521
3	42875	46656	50653	54872	59319
4	15 00625	16 79616	18 74161	20 85136	23 13441
5	525 21875	604 66176	693 43957	792 35168	902 24199
6	(9) 1.8382 65625	(9) 2.1767 82336	(9) 2.5657 26409	(9) 3.0109 36384	(9) 3.5187 43761
7	(10) 6.4339 29688	(10) 7.8364 16410	(10) 9.4931 87713	(10) 1.1441 55826	(10) 1.3723 10067
8	(12) 2.2518 75391	(12) 2.8211 09907	(12) 3.5124 79454	(12) 4.3477 92138	(12) 5.3520 09260
9	(13) 7.8815 63867	(13) 1.0155 99567	(13) 1.2996 17398	(13) 1.6521 61013	(13) 2.0872 83612
10	(15) 2.7585 47354	(15) 3.6561 58440	(15) 4.8085 84372	(15) 6.2782 11848	(15) 8.1404 06085
24	(37) 1.1419 13124	(37) 2.2452 25771	(37) 4.3335 25711	(37) 8.2187 60383	(38) 1.5330 29700
1/2	5.9160 79783	6.0000 00000	6.0827 62530	6.1644 14003	6.2449 97998
1/3	3.2710 66310	3.3019 27249	3.3322 21852	3.3619 75407	3.3912 11443
1/4	2.4322 99279	2.4494 89743	2.4663 25715	2.4828 23796	2.4989 99399
1/5	2.0361 68005	2.0476 72511	2.0589 24137	2.0699 35054	2.0807 16549
1	40	41	42	43	44
2	1600	1681	1764	1849	1936
3	64000	68921	74088	79507	85184
4	25 60000	28 25761	31 11696	34 18801	37 48096
5	1024 00000	1158 56201	1306 91232	1470 08443	1649 16224
6	(9) 4.0960 00000	(9) 4.7501 04241	(9) 5.4890 31744	(9) 6.3213 63049	(9) 7.2563 13856
7	(11) 1.6384 00000	(11) 1.9475 42739	(11) 2.3053 93332	(11) 2.7181 86111	(11) 3.1927 78097
8	(12) 6.5536 00000	(12) 7.9849 25229	(12) 9.6826 51996	(12) 1.1688 20028	(12) 1.4048 22363
9	(14) 2.6214 40000	(14) 3.2738 19344	(14) 4.0667 13838	(14) 5.0259 26119	(14) 6.1812 18395
10	(16) 1.0485 76000	(16) 1.3422 65931	(16) 1.7080 19812	(16) 2.1611 48231	(16) 2.7197 36094
24	(38) 2.8147 49767	(38) 5.0911 10945	(38) 9.0778 49315	(39) 1.5967 72093	(39) 2.7724 53276
1/2	6.3245 55320	6.4031 24237	6.4807 40698	6.5574 38524	6.6334 49581
1/3	3.4199 51893	3.4482 17240	3.4760 26645	3.5033 98060	3.5303 48335
1/4	2.5148 66859	2.5304 39534	2.5457 29895	2.5607 49602	2.5755 09577
1/5	2.0912 79105	2.1016 32478	2.1117 85765	2.1217 47461	2.1315 25513
1	45	46	47	48	49
2	2025	2116	2209	2304	2401
3	91125	97336	1 03823	1 10592	1 17649
4	41 00625	44 77456	48 79681	53 08416	57 64801
5	1845 28125	2059 62976	2293 45007	2548 03968	2824 75249
6	(9) 8.3037 65625	(9) 9.4742 96896	(10) 1.0779 21533	(10) 1.2230 59046	(10) 1.3841 28720
7	(11) 3.7366 94531	(11) 4.3581 76572	(11) 5.0662 31205	(11) 5.8706 83423	(11) 6.7822 30728
8	(13) 1.6815 12539	(13) 2.0047 61223	(13) 2.3811 28666	(13) 2.8179 28043	(13) 3.3232 93057
9	(14) 7.5668 06426	(14) 9.2219 01627	(15) 1.1191 30473	(15) 1.3526 05461	(15) 1.6284 13598
10	(16) 3.4050 62892	(16) 4.2420 74748	(16) 5.2599 13224	(16) 6.4925 06211	(16) 7.9792 26630
24	(39) 4.7544 50505	(39) 8.0572 70802	(40) 1.3500 46075	(40) 2.2376 37322	(40) 3.6703 36822
1/2	6.7082 03932	6.7823 29983	6.8556 54600	6.9282 03230	7.0000 00000
1/3	3.5568 93304	3.5830 47871	3.6088 26080	3.6342 41186	3.6593 05710
1/4	2.5900 20064	2.6042 90687	2.6183 30499	2.6321 48026	2.6457 51311
1/5	2.1411 27368	2.1505 60013	2.1598 30012	2.1689 43542	2.1779 06425

$$\frac{1}{n^2} \left[\begin{matrix} (-4) \\ 8 \end{matrix} \right] \quad \frac{1}{n^3} \left[\begin{matrix} (-4) \\ 7 \end{matrix} \right] \quad \frac{1}{n^4} \left[\begin{matrix} (-5) \\ 8 \end{matrix} \right] \quad \frac{1}{n^5} \left[\begin{matrix} (-5) \\ 6 \end{matrix} \right]$$

The numbers in square brackets at the bottom of the page mean that the maximum error in a linear interpolate is $a \times 10^{-p}$ (p in parentheses), and that to interpolate to the full tabular accuracy m points must be used in Lagrange's and Aitken's methods for the respective functions $n^{1/2}$.

*See page II.

Table 3.1

POWERS AND ROOTS n^k

k	50	51	52	53	54
1	50	51	52	53	54
2	2500	2601	2704	2809	2916
3	1 25000	1 32651	1 40608	1 48877	1 57464
4	62 50000	67 65201	73 11616	78 90481	85 03056
5	3125 00000	3450 25251	3802 04032	4181 95493	4591 65024
6	(10) 1.5625 00000	(10) 1.7596 28780	(10) 1.9770 60966	(10) 2.2164 36113	(10) 2.4794 91130
7	(11) 7.8125 00000	(11) 8.9741 06779	(12) 1.0280 71703	(12) 1.1747 11140	(12) 1.3389 25210
8	(13) 3.9062 50000	(13) 4.5767 94457	(13) 5.3459 72853	(13) 6.2259 69041	(13) 7.2301 96134
9	(15) 1.9531 25000	(15) 2.3341 65173	(15) 2.7799 05884	(15) 3.2997 63592	(15) 3.9043 05912
10	(16) 9.7656 25000	(17) 1.1904 24238	(17) 1.4455 51059	(17) 1.7488 74704	(17) 2.1083 25193
24	(40) 5.9604 64478	(40) 9.5870 33090	(41) 1.5278 48342	(41) 2.4133 53110	(41) 3.7796 38253
1/2	7.0710 67812	7.1414 28429	7.2111 02551	7.2801 09889	7.3484 69228
1/3	3.6840 31499	3.7084 29769	3.7325 11157	3.7562 85754	3.7797 63150
1/4	2.6591 47948	2.6723 45118	2.6853 49614	2.6981 67876	2.7108 06011
1/5	2.1867 24148	2.1954 01897	2.2039 44575	2.2123 56822	2.2206 43055
1	55	56	57	58	59
2	3025	3136	3249	3364	3481
3	1 66375	1 75616	1 85193	1 95112	2 05379
4	91 50625	98 34496	105 56001	113 16496	121 17361
5	5032 84375	5507 31776	6016 92057	6563 56768	7149 24299
6	(10) 2.7680 64063	(10) 3.0840 97946	(10) 3.4296 44725	(10) 3.8068 69254	(10) 4.2180 53364
7	(12) 1.5224 35234	(12) 1.7270 94850	(12) 1.9548 97493	(12) 2.2079 84168	(12) 2.4886 51485
8	(13) 8.3733 93789	(13) 9.6717 31157	(14) 1.1142 91571	(14) 1.2806 30817	(14) 1.4683 04376
9	(15) 4.6053 66584	(15) 5.4161 69448	(15) 6.3514 61955	(15) 7.4276 58740	(15) 8.6629 95819
10	(17) 2.5329 51621	(17) 3.0330 54891	(17) 3.6203 33315	(17) 4.3080 42069	(17) 5.1111 67533
24	(41) 5.8708 98173	(41) 9.0471 67858	(42) 1.3835 55344	(42) 2.1002 54121	(42) 3.1655 43453
1/2	7.4161 98487	7.4833 14774	7.5498 34435	7.6157 73106	7.6811 45748
1/3	3.8029 52461	3.8258 62366	3.8485 01131	3.8708 76641	3.8929 96416
1/4	2.7232 69815	2.7355 64800	2.7476 96205	2.7596 69021	2.7714 88002
1/5	2.2288 07384	2.2368 53829	2.2447 86134	2.2526 07878	2.2603 22470
1	60	61	62	63	64
2	3600	3721	3844	3969	4096
3	2 16000	2 26981	2 38328	2 50047	2 62144
4	129 60000	138 45841	147 76336	157 52961	167 77216
5	7776 00000	8445 96301	9161 32832	9924 36543	(9) 1.0737 41824
6	(10) 4.6656 00000	(10) 5.1520 37436	(10) 5.6800 23558	(10) 6.2523 50221	(10) 6.8719 46774
7	(12) 2.7993 60000	(12) 3.1427 42836	(12) 3.5216 14606	(12) 3.9389 80639	(12) 4.3980 46511
8	(14) 1.6796 16000	(14) 1.9170 73130	(14) 2.1834 01056	(14) 2.4815 57803	(14) 2.8147 49767
9	(16) 1.0077 69600	(16) 1.1694 14609	(16) 1.3537 08655	(16) 1.5633 81416	(16) 1.8014 39851
10	(17) 6.0466 17600	(17) 7.1334 29117	(17) 8.3929 93659	(17) 9.8493 02919	(18) 1.1529 21505
24	(42) 4.7383 81338	(42) 7.0455 68477	(43) 1.0408 79722	(43) 1.5281 75339	(43) 2.2300 74520
1/2	7.7459 66692	7.8102 49676	7.8740 07874	7.9372 53933	8.0000 00000
1/3	3.9148 67641	3.9364 97183	3.9578 91610	3.9790 57208	4.0000 00000
1/4	2.7831 57684	2.7946 82393	2.8060 66263	2.8173 13247	2.8284 27125
1/5	2.2679 33155	2.2754 43032	2.2828 55056	2.2901 72049	2.2973 96710
1	65	66	67	68	69
2	4225	4356	4489	4624	4761
3	2 74625	2 87496	3 00763	3 14432	3 28509
4	178 50625	189 74736	201 51121	213 81376	226 67121
5	(9) 1.1602 90625	(9) 1.2523 32576	(9) 1.3501 25107	(9) 1.4539 33568	(9) 1.5640 31349
6	(10) 7.5418 89063	(10) 8.2653 95002	(10) 9.0458 38217	(10) 9.8867 48262	(11) 1.0791 81631
7	(12) 4.9022 27891	(12) 5.4551 60701	(12) 6.0607 11605	(12) 6.7229 88818	(12) 7.4463 53253
8	(14) 3.1864 48129	(14) 3.6004 06063	(14) 4.0606 76776	(14) 4.5716 32397	(14) 5.1379 83744
9	(16) 2.0711 91284	(16) 2.3762 68001	(16) 2.7206 53440	(16) 3.1087 10030	(16) 3.5452 08784
10	(18) 1.3462 74334	(18) 1.5683 36881	(18) 1.8228 37805	(18) 2.1139 22820	(18) 2.4461 94061
24	(43) 3.2353 44710	(43) 4.6671 78950	(43) 6.6956 88867	(43) 9.5546 30685	(44) 1.3563 70007
1/2	8.0622 57748	8.1240 38405	8.1853 52772	8.2462 11251	8.3066 23863
1/3	4.0207 25759	4.0412 40021	4.0615 48100	4.0816 55102	4.1015 65930
1/4	2.8394 11514	2.8502 69883	2.8610 05553	2.8716 21711	2.8821 21417
1/5	2.3045 33152	2.3115 79249	2.3185 41963	2.3254 22030	2.3322 21626
1	70	71	72	73	74
2	4900	5041	5184	5329	5476
3	3 43000	3 57911	3 73248	3 89017	4 05224
4	240 10000	254 11681	268 73856	283 98241	299 86576
5	(9) 1.6807 00000	(9) 1.8042 29351	(9) 1.9349 17632	(9) 2.0730 71593	(9) 2.2190 06624
6	(11) 1.1764 90000	(11) 1.2810 02839	(11) 1.3931 40695	(11) 1.5133 42263	(11) 1.6420 64902
7	(12) 8.2354 30000	(12) 9.0951 20158	(13) 1.0030 61300	(13) 1.1047 39852	(13) 1.2151 28027
8	(14) 5.7648 01000	(14) 6.4575 35312	(14) 7.2220 41363	(14) 8.0646 00919	(14) 8.9919 47402
9	(16) 4.0353 60700	(16) 4.5848 50072	(16) 5.1998 69781	(16) 5.8871 58671	(16) 6.6540 41078
10	(18) 2.8247 52490	(18) 3.2552 43551	(18) 3.7439 06243	(18) 4.2976 25830	(18) 4.9239 90397
24	(44) 1.9158 12314	(44) 2.6927 76876	(44) 3.7668 63772	(44) 5.2450 38047	(44) 7.2704 49690
1/2	8.3666 00265	8.4261 49773	8.4852 81374	8.5440 03745	8.6023 25267
1/3	4.1212 85300	4.1408 17749	4.1601 67646	4.1793 39196	4.1983 36454
1/4	2.8925 07608	2.9027 83108	2.9129 50630	2.9230 12786	2.9329 72088
1/5	2.3389 48237	2.3455 87669	2.3521 58045	2.3586 55818	2.3650 82769
	$\frac{1}{n^2} \left[\begin{matrix} (-5) \\ 6 \end{matrix} \right]$	$\frac{1}{n^3} \left[\begin{matrix} (-5) \\ 6 \end{matrix} \right]$	$\frac{1}{n^4} \left[\begin{matrix} (-5) \\ 5 \end{matrix} \right]$	$\frac{1}{n^5} \left[\begin{matrix} (-5) \\ 5 \end{matrix} \right]$	

ELEMENTARY ANALYTICAL METHODS

POWERS AND ROOTS n^k

Table 3.1

1							
2	75	76	77	78	79		
3	5625	5776	5929	6084	6241		
4	4 21875	4 38976	4 56533	4 74552	4 93039		
5	316 40625	333 62176	351 53041	370 15056	389 50081		
6	(9) 2.3730 46875	(9) 2.5355 25376	(9) 2.7067 84157	(9) 2.8871 74368	(9) 3.0770 56399		
7	(11) 1.7797 85156	(11) 1.9269 99286	(11) 2.0842 23801	(11) 2.2519 96007	(11) 2.4308 74555		
8	(13) 1.3348 38867	(13) 1.4645 19457	(13) 1.6048 52327	(13) 1.7565 56885	(13) 1.9203 90899		
9	(15) 1.0011 29150	(15) 1.1130 34787	(15) 1.2357 36292	(15) 1.3701 14371	(15) 1.5171 08810		
10	(16) 7.5084 68628	(16) 8.4590 64385	(16) 9.5151 69445	(17) 1.0686 89209	(17) 1.1985 15960		
	(18) 5.6313 51471	(18) 6.4288 88932	(18) 7.3266 80473	(18) 8.3357 75831	(18) 9.4682 76083		
24	(45) 1.0033 91278	(45) 1.3788 79182	(45) 1.8870 23915	(45) 2.5719 97041	(45) 3.4918 06676		
1/2	8.6602 54038	8.7177 97887	8.7749 64387	8.8317 60866	8.8881 94417		
1/3	4.2171 63326	4.2358 23584	4.2543 20865	4.2726 58682	4.2908 40427		
1/4	2.9428 30956	2.9525 91724	2.9622 56638	2.9718 27866	2.9813 07501		
1/5	2.3714 40610	2.3777 30992	2.3839 55503	2.3901 15677	2.3962 12991		
1							
2	80	81	82	83	84		
3	6400	6561	6724	6889	7056		
4	5 12000	5 31441	5 51368	5 71787	5 92704		
5	409 60000	430 46721	452 12176	474 58321	497 87136		
6	(9) 3.2768 00000	(9) 3.4867 84401	(9) 3.7073 98432	(9) 3.9390 40643	(9) 4.1821 19424		
7	(11) 2.6214 40000	(11) 2.8242 95365	(11) 3.0400 66714	(11) 3.2694 03734	(11) 3.5129 80316		
8	(13) 2.0971 52000	(13) 2.2876 79245	(13) 2.4928 54706	(13) 2.7136 05099	(13) 2.9509 03466		
9	(15) 1.6777 21600	(15) 1.8530 20189	(15) 2.0441 40859	(15) 2.2522 92232	(15) 2.4787 58911		
10	(17) 1.3421 77280	(17) 1.5009 46353	(17) 1.6761 95504	(17) 1.8694 02553	(17) 2.0821 57485		
	(19) 1.0737 41824	(19) 1.2157 66546	(19) 1.3744 80313	(19) 1.5516 04119	(19) 1.7490 12288		
24	(45) 4.7223 66483	(45) 6.3626 85441	(45) 8.5414 66801	(46) 1.1425 47375	(46) 1.5230 10388		
1/2	8.9442 71910	9.0000 00000	9.0553 85138	9.1104 33579	9.1651 51390		
1/3	4.3088 69380	4.3267 48711	4.3444 81486	4.3620 70671	4.3795 19140		
1/4	2.9906 97562	3.0000 00000	3.0092 16698	3.0183 49479	3.0274 00104		
1/5	2.4022 48868	2.4082 24685	2.4141 41771	2.4200 01407	2.4258 04834		
1							
2	85	86	87	88	89		
3	7225	7396	7569	7744	7921		
4	6 14125	6 36056	6 58503	6 81472	7 04969		
5	522 00625	547 00816	572 89761	599 69536	627 42241		
6	(9) 4.4370 53125	(9) 4.7042 70176	(9) 4.9842 09207	(9) 5.2773 19168	(9) 5.5840 59449		
7	(11) 3.7714 95156	(11) 4.0456 72351	(11) 4.3362 62010	(11) 4.6440 40868	(11) 4.9698 12910		
8	(13) 3.2057 70883	(13) 3.4792 78222	(13) 3.7725 47949	(13) 4.0867 55964	(13) 4.4231 33490		
9	(15) 2.7249 05250	(15) 2.9921 79271	(15) 3.2821 16715	(15) 3.5963 45248	(15) 3.9365 88806		
10	(17) 2.3161 69463	(17) 2.5732 74173	(17) 2.8554 41542	(17) 3.1647 83818	(17) 3.5035 64037		
	(19) 1.9687 44043	(19) 2.2130 15789	(19) 2.4842 34142	(19) 2.7850 09760	(19) 3.1181 71993		
24	(46) 2.0232 71747	(46) 2.6789 39031	(46) 3.5355 91351	(46) 4.6514 04745	(46) 6.1004 25945		
1/2	9.2195 44457	9.2736 18495	9.3273 79053	9.3808 31520	9.4339 81132		
1/3	4.3968 29672	4.4140 04962	4.4310 47622	4.4479 60181	4.4647 45096		
1/4	3.0363 70277	3.0452 61646	3.0540 75810	3.0628 14314	3.0714 78656		
1/5	2.4315 53252	2.4372 47818	2.4428 89656	2.4484 79851	2.4540 19455		
1							
2	90	91	92	93	94		
3	8100	8281	8464	8649	8836		
4	7 29000	7 53571	7 78688	8 04357	8 30584		
5	656 10000	685 74961	716 39296	748 05201	780 74896		
6	(9) 5.9049 00000	(9) 6.2403 21451	(9) 6.5908 15232	(9) 6.9568 83693	(9) 7.3390 40224		
7	(11) 5.3144 10000	(11) 5.6786 92520	(11) 6.0635 50013	(11) 6.4699 01834	(11) 6.8986 97811		
8	(13) 4.7829 69000	(13) 5.1676 10194	(13) 5.5784 66012	(13) 6.0170 08706	(13) 6.4847 75942		
9	(15) 4.3046 72100	(15) 4.7025 25276	(15) 5.1321 88731	(15) 5.5958 18097	(15) 6.0956 89385		
10	(17) 3.8742 04890	(17) 4.2792 98001	(17) 4.7216 13633	(17) 5.2041 10830	(17) 5.7299 48022		
	(19) 3.4867 84401	(19) 3.8941 61181	(19) 4.3438 84542	(19) 4.8398 23072	(19) 5.3861 51141		
24	(46) 7.9766 44308	(47) 1.0399 04400	(47) 1.3517 85726	(47) 1.7522 28603	(47) 2.2650 01461		
1/2	9.4868 32981	9.5393 92014	9.5916 63047	9.6436 50761	9.6953 59715		
1/3	4.4814 04747	4.4979 41445	4.5143 57435	4.5306 54896	4.5468 35944		
1/4	3.0800 70288	3.0885 90619	3.0970 41015	3.1054 22799	3.1137 37258		
1/5	2.4595 09486	2.4649 50932	2.4703 44749	2.4756 91866	2.4809 93182		
1							
2	95	96	97	98	99		
3	9025	9216	9409	9604	9801		
4	8 57375	8 84736	9 12673	9 41192	9 70299		
5	814 50625	849 34656	885 29281	922 36816	960 59601		
6	(9) 7.7378 09375	(9) 8.1537 26976	(9) 8.5873 40257	(9) 9.0392 07968	(9) 9.5099 00499		
7	(11) 7.3509 18906	(11) 7.8275 77897	(11) 8.3297 20049	(11) 8.8584 23809	(11) 9.4148 01494		
8	(13) 6.9833 72961	(13) 7.5144 74781	(13) 8.0798 28448	(13) 8.6812 55332	(13) 9.3206 53479		
9	(15) 6.6342 04313	(15) 7.2138 95790	(15) 7.8374 33594	(15) 8.5076 30226	(15) 9.2274 46944		
10	(17) 6.3024 94097	(17) 6.9253 39958	(17) 7.6023 10587	(17) 8.3374 77621	(17) 9.1351 72475		
	(19) 5.9873 69392	(19) 6.6483 26360	(19) 7.3742 41269	(19) 8.1707 28069	(19) 9.0438 20750		
24	(47) 2.9198 90243	(47) 3.7541 32467	(47) 4.8141 72219	(47) 6.1578 03365	(47) 7.8567 81408		
1/2	9.7467 94345	9.7979 58971	9.8488 57802	9.8994 94937	9.9498 74371		
1/3	4.5629 02635	4.5788 56970	4.5947 00892	4.6104 36292	4.6260 65009		
1/4	3.1219 85641	3.1301 69160	3.1382 88993	3.1463 46284	3.1543 42146		
1/5	2.4862 49570	2.4914 61879	2.4966 30932	2.5017 57227	2.5068 42442		
	$\frac{1}{n^2} \left[\binom{-5}{5} \right]$	$\frac{1}{n^3} \left[\binom{-5}{5} \right]$	$\frac{1}{n^4} \left[\binom{-5}{5} \right]$	$\frac{1}{n^5} \left[\binom{-6}{5} \right]$			

Table 3.1 POWERS AND ROOTS n^k

k						
1		100	101	102	103	
2		10000	10201	10404	10609	
3		10 00000	10 30301	10 61208	10 92727	
4		1000 00000	1040 60401	1082 43216	1125 50881	
5	(10)	1.0000 00000	(10) 1.0510 10050	(10) 1.1040 80803	(10) 1.1592 74074	(10) 1.2166 52902
6	(12)	1.0000 00000	(12) 1.0615 20151	(12) 1.1261 62419	(12) 1.1940 52297	(12) 1.2653 19018
7	(14)	1.0000 00000	(14) 1.0721 35352	(14) 1.1486 85668	(14) 1.2298 73865	(14) 1.3159 31779
8	(16)	1.0000 00000	(16) 1.0828 56706	(16) 1.1716 59381	(16) 1.2667 70081	(16) 1.3685 69050
9	(18)	1.0000 00000	(18) 1.0936 85273	(18) 1.1950 92569	(18) 1.3047 73184	(18) 1.4233 11812
10	(20)	1.0000 00000	(20) 1.1046 22125	(20) 1.2189 94420	(20) 1.3439 16379	(20) 1.4802 44285
24	(48)	1.0000 00000	(48) 1.2697 34649	(48) 1.6084 37249	(48) 2.0327 94106	(48) 2.5633 04165
1/2	(1)	1.0000 00000	(1) 1.0049 87562	(1) 1.0099 50494	(1) 1.0148 89157	(1) 1.0198 03903
1/3		4.6415 88834	4.6570 09508	4.6723 28728	4.6875 48148	4.7026 69375
1/4		3.1622 77660	3.1701 53880	3.1779 71828	3.1857 32501	3.1934 36868
1/5		2.5118 86432	2.5168 90229	2.5218 54548	2.5267 80083	2.5316 67508
1		105	106	107	108	109
2		11025	11236	11449	11664	11881
3		11 57625	11 91016	12 25043	12 59712	12 95029
4		1215 50625	1262 47696	1310 79601	1360 48896	1411 58161
5	(10)	1.2762 81563	(10) 1.3382 25578	(10) 1.4025 51731	(10) 1.4693 28977	(10) 1.5386 23955
6	(12)	1.3400 95641	(12) 1.4185 19112	(12) 1.5007 30352	(12) 1.5868 74323	(12) 1.6771 00111
7	(14)	1.4071 00423	(14) 1.5036 30259	(14) 1.6057 81476	(14) 1.7138 24269	(14) 1.8280 39121
8	(16)	1.4774 55444	(16) 1.5938 48075	(16) 1.7181 86180	(16) 1.8509 30210	(16) 1.9925 62642
9	(18)	1.5513 28216	(18) 1.6894 78959	(18) 1.8384 59212	(18) 1.9990 04627	(18) 2.1718 93279
10	(20)	1.6288 94627	(20) 1.7908 47697	(20) 1.9671 51357	(20) 2.1589 24997	(20) 2.3673 63675
24	(48)	3.2250 99944	(48) 4.0489 34641	(48) 5.0723 66953	(48) 6.3411 80737	(48) 7.9110 83175
1/2	(1)	1.0246 95077	(1) 1.0295 63014	(1) 1.0344 08043	(1) 1.0392 30485	(1) 1.0440 30651
1/3		4.7176 93980	4.7326 23491	4.7474 59398	4.7622 03156	4.7768 56181
1/4		3.2010 85873	3.2086 80436	3.2162 21453	3.2237 09795	3.2311 46315
1/5		2.5365 17482	2.5413 30642	2.5461 07613	2.5508 49001	2.5555 55397
1		110	111	112	113	114
2		12100	12321	12544	12769	12996
3		13 31000	13 67631	14 04928	14 42897	14 81544
4		1464 10000	1518 07041	1573 51936	1630 47361	1688 96016
5	(10)	1.6105 10000	(10) 1.6850 58155	(10) 1.7623 41683	(10) 1.8424 35179	(10) 1.9254 14582
6	(12)	1.7715 61000	(12) 1.8704 14552	(12) 1.9738 22685	(12) 2.0819 51753	(12) 2.1949 72624
7	(14)	1.9487 17100	(14) 2.0761 60153	(14) 2.2106 81407	(14) 2.3526 05480	(14) 2.5022 68791
8	(16)	2.1435 88810	(16) 2.3045 37770	(16) 2.4759 63176	(16) 2.6584 44193	(16) 2.8525 86422
9	(18)	2.3579 47691	(18) 2.5580 36924	(18) 2.7730 78757	(18) 3.0040 41938	(18) 3.2519 48521
10	(20)	2.5937 42460	(20) 2.8394 20986	(20) 3.1058 48208	(20) 3.3945 67390	(20) 3.7072 21314
24	(48)	9.8497 32676	(48) 1.2239 15658	(48) 1.5178 62893	(48) 1.8788 09051	(48) 2.3212 20685
1/2	(1)	1.0488 08848	(1) 1.0535 65375	(1) 1.0583 00524	(1) 1.0630 14581	(1) 1.0677 07825
1/3		4.7914 19857	4.8058 95534	4.8202 84528	4.8345 88127	4.8488 07586
1/4		3.2385 31840	3.2458 67180	3.2531 53123	3.2603 90439	3.2675 79877
1/5		2.5602 27376	2.5648 65499	2.5694 70314	2.5740 42354	2.5785 82140
1		115	116	117	118	119
2		13225	13456	13689	13924	14161
3		15 20875	15 60896	16 01613	16 43032	16 85159
4		1749 00625	1810 63936	1873 88721	1938 77776	2005 33921
5	(10)	2.0113 57188	(10) 2.1003 41658	(10) 2.1924 48036	(10) 2.2877 57757	(10) 2.3863 53660
6	(12)	2.3130 60766	(12) 2.4363 96323	(12) 2.5651 64202	(12) 2.6995 54153	(12) 2.8397 60855
7	(14)	2.6600 19880	(14) 2.8262 19734	(14) 3.0012 42116	(14) 3.1854 73901	(14) 3.3793 15418
8	(16)	3.0590 22863	(16) 3.2784 14892	(16) 3.5114 53276	(16) 3.7588 59203	(16) 4.0213 85347
9	(18)	3.5178 76292	(18) 3.8029 61275	(18) 4.1084 00333	(18) 4.4354 53859	(18) 4.7854 48563
10	(20)	4.0455 57736	(20) 4.4114 35079	(20) 4.8068 28389	(20) 5.2338 35554	(20) 5.6946 83790
24	(49)	2.8625 17619	(49) 3.5236 41704	(49) 4.3297 28675	(49) 5.3109 00627	(49) 6.5031 99444
1/2	(1)	1.0723 80529	(1) 1.0770 32961	(1) 1.0816 65383	(1) 1.0862 78049	(1) 1.0908 71211
1/3		4.8629 44131	4.8769 98961	4.8909 73246	4.9048 68131	4.9186 84734
1/4		3.2747 22171	3.2818 18035	3.2888 68168	3.2958 73252	3.3028 33952
1/5		2.5830 90178	2.5875 66964	2.5920 12982	2.5964 28703	2.6008 14587
1		120	121	122	123	124
2		14400	14641	14884	15129	15376
3		17 28000	17 71561	18 15848	18 60867	19 06624
4		2073 60000	2143 58881	2215 33456	2288 86641	2364 21376
5	(10)	2.4883 20000	(10) 2.5937 42460	(10) 2.7027 08163	(10) 2.8153 05684	(10) 2.9316 25062
6	(12)	2.9859 84000	(12) 3.1384 28377	(12) 3.2973 03959	(12) 3.4628 25992	(12) 3.6352 15077
7	(14)	3.5831 80800	(14) 3.7974 98336	(14) 4.0227 10830	(14) 4.2592 75970	(14) 4.5076 66696
8	(16)	4.2998 16960	(16) 4.5949 72986	(16) 4.9077 07213	(16) 5.2389 09443	(16) 5.5895 06703
9	(18)	5.1597 80352	(18) 5.5599 17313	(18) 5.9874 02800	(18) 6.4438 58615	(18) 6.9309 88312
10	(20)	6.1917 36422	(20) 6.7274 99949	(20) 7.3046 31415	(20) 7.9259 46096	(20) 8.5944 25506
24	(49)	7.9496 84720	(49) 9.7017 23378	(50) 1.1820 50242	(50) 1.4378 80104	(50) 1.7463 06393
1/2	(1)	1.0954 45115	(1) 1.1000 00000	(1) 1.1045 36102	(1) 1.1090 53651	(1) 1.1135 52873
1/3		4.9324 24149	4.9460 87443	4.9596 75664	4.9731 89833	4.9866 30952
1/4		3.3097 50920	3.3166 24790	3.3234 56186	3.3302 45713	3.3369 93965
1/5		2.6051 71085	2.6094 98635	2.6137 97668	2.6180 68602	2.6223 11847

$$n^2 \left[\begin{matrix} (-5) 3 \\ 4 \end{matrix} \right]$$

$$n^3 \left[\begin{matrix} (-5) 1 \\ 5 \end{matrix} \right]$$

$$n^4 \left[\begin{matrix} (-6) 8 \\ 5 \end{matrix} \right]$$

$$n^5 \left[\begin{matrix} (-6) 5 \\ 4 \end{matrix} \right]$$

POWERS AND ROOTS n^k

Table 3.1

k					
1	125	126	127	128	129
2	15625	15876	16129	16384	16641
3	19 53125	20 00376	20 48383	20 97152	21 46689
4	2441 40625	2520 47376	2601 44641	2684 35456	2769 22881
5	(10) 3. 0517 57813	(10) 3. 1757 96938	(10) 3. 3038 36941	(10) 3. 4359 73837	(10) 3. 5723 05165
6	(12) 3. 8146 97266	(12) 4. 0015 04141	(12) 4. 1958 72915	(12) 4. 3980 46511	(12) 4. 6082 73663
7	(14) 4. 7683 71582	(14) 5. 0418 95218	(14) 5. 3287 58602	(14) 5. 6294 99534	(14) 5. 9446 73025
8	(16) 5. 9604 64478	(16) 6. 3527 87975	(16) 6. 7675 23424	(16) 7. 2057 59404	(16) 7. 6686 28202
9	(18) 7. 4505 80597	(18) 8. 0045 12848	(18) 8. 5947 54749	(18) 9. 2233 72037	(18) 9. 8925 30381
10	(20) 9. 3132 25746	(21) 1. 0085 68619	(21) 1. 0915 33853	(21) 1. 1805 91621	(21) 1. 2761 36419
24	(50) 2. 1175 82368	(50) 2. 5638 52774	(50) 3. 0994 83316	(50) 3. 7414 44192	(50) 4. 5097 56022
1/2	(1) 1. 1180 33989	(1) 1. 1224 97216	(1) 1. 1269 42767	(1) 1. 1313 70850	(1) 1. 1357 81669
1/3	5. 0000 00000	5. 0152 97935	5. 0265 25695	5. 0396 84200	5. 0527 74347
1/4	3. 3437 01525	3. 3503 68959	3. 3569 96823	3. 3635 85661	3. 3701 36005
1/5	2. 6265 27804	2. 6307 16865	2. 6348 79413	2. 6390 15822	2. 6431 26458
1	130	131	132	133	134
2	16900	17161	17424	17689	17956
3	21 97000	22 48091	22 99968	23 52637	24 06104
4	2856 10000	2944 99921	3035 95776	3129 00721	3224 17936
5	(10) 3. 7129 30000	(10) 3. 8579 48965	(10) 4. 0074 64243	(10) 4. 1615 79589	(10) 4. 3204 00342
6	(12) 4. 8268 09000	(12) 5. 0539 13144	(12) 5. 2898 52801	(12) 5. 5349 00854	(12) 5. 7893 36459
7	(14) 6. 2748 51700	(14) 6. 6206 26219	(14) 6. 9826 05697	(14) 7. 3614 18136	(14) 7. 7577 10855
8	(16) 8. 1573 07210	(16) 8. 6730 20347	(16) 9. 2170 39521	(16) 9. 7906 86120	(17) 1. 0395 33255
9	(19) 1. 0604 49937	(19) 1. 1361 65665	(19) 1. 2166 49217	(19) 1. 3021 61254	(19) 1. 3929 74561
10	(21) 1. 3785 84918	(21) 1. 4883 77022	(21) 1. 6059 76966	(21) 1. 7318 74468	(21) 1. 8665 85912
24	(50) 5. 4280 07704	(50) 6. 5239 57088	(50) 7. 8302 26935	(50) 9. 3851 10346	(51) 1. 1233 50184
1/2	(1) 1. 1401 75425	(1) 1. 1445 52314	(1) 1. 1489 12529	(1) 1. 1532 56259	(1) 1. 1575 83690
1/3	5. 0657 97019	5. 0787 53078	5. 0916 43370	5. 1044 68722	5. 1172 29947
1/4	3. 3766 48375	3. 3831 23282	3. 3895 61224	3. 3959 62690	3. 4023 28159
1/5	2. 6472 11681	2. 6512 71840	2. 6553 07280	2. 6593 18337	2. 6633 05339
1	135	136	137	138	139
2	18225	18496	18769	19044	19321
3	24 60375	25 15456	25 71353	26 28072	26 85619
4	3321 50625	3421 02016	3522 75361	3626 73936	3733 01041
5	(10) 4. 4840 33438	(10) 4. 6525 87418	(10) 4. 8261 72446	(10) 5. 0049 00317	(10) 5. 1888 84470
6	(12) 6. 0534 45141	(12) 6. 3275 18888	(12) 6. 6118 56251	(12) 6. 9067 62437	(12) 7. 2125 49413
7	(14) 8. 1721 50940	(14) 8. 6054 25688	(14) 9. 0582 43063	(14) 9. 5313 32163	(15) 1. 0025 44368
8	(17) 1. 1032 40377	(17) 1. 1703 37894	(17) 1. 2409 79300	(17) 1. 3153 23839	(17) 1. 3935 36672
9	(19) 1. 4893 74509	(19) 1. 5916 59535	(19) 1. 7001 41641	(19) 1. 8151 46897	(19) 1. 9370 15974
10	(21) 2. 0106 55587	(21) 2. 1646 56968	(21) 2. 3291 94048	(21) 2. 5049 02718	(21) 2. 6924 52204
24	(51) 1. 3427 97252	(51) 1. 6030 01028	(51) 1. 9111 44882	(51) 2. 2756 11258	(51) 2. 7061 70815
1/2	(1) 1. 1618 95004	(1) 1. 1661 90379	(1) 1. 1704 69991	(1) 1. 1747 34012	(1) 1. 1789 82612
1/3	5. 1299 27840	5. 1425 63181	5. 1551 36735	5. 1676 49252	5. 1801 01467
1/4	3. 4086 58099	3. 4149 52970	3. 4212 13222	3. 4274 39296	3. 4336 31623
1/5	2. 6672 68608	2. 6712 08461	2. 6751 25206	2. 6790 19145	2. 6828 90577
1	140	141	142	143	144
2	19600	19881	20164	20449	20736
3	27 44000	28 03221	28 63288	29 24207	29 85984
4	3841 60000	3952 54161	4065 86896	4181 61601	4299 81696
5	(10) 5. 3782 40000	(10) 5. 5730 83670	(10) 5. 7735 33923	(10) 5. 9797 10894	(10) 6. 1917 36422
6	(12) 7. 5295 36000	(12) 7. 8580 47975	(12) 8. 1984 18171	(12) 8. 5509 86579	(12) 8. 9161 00448
7	(15) 1. 0541 35040	(15) 1. 1079 84764	(15) 1. 1641 75380	(15) 1. 2227 91081	(15) 1. 2839 18465
8	(17) 1. 4757 89056	(17) 1. 5622 58518	(17) 1. 6531 29040	(17) 1. 7485 91246	(17) 1. 8488 42589
9	(19) 2. 0661 04678	(19) 2. 2027 84510	(19) 2. 3474 43237	(19) 2. 5004 85481	(19) 2. 6623 33328
10	(21) 2. 8925 46550	(21) 3. 1059 26159	(21) 3. 3333 69396	(21) 3. 5756 94238	(21) 3. 8337 59992
24	(51) 3. 2141 99700	(51) 3. 8129 28871	(51) 4. 5177 29930	(51) 5. 3464 42484	(51) 6. 3197 48715
1/2	(1) 1. 1832 15957	(1) 1. 1874 34209	(1) 1. 1916 37529	(1) 1. 1958 26074	(1) 1. 2000 00000
1/3	5. 1924 94102	5. 2048 27863	5. 2171 03446	5. 2293 21532	5. 2414 82788
1/4	3. 4397 90628	3. 4459 16727	3. 4520 10326	3. 4580 71824	3. 4641 01615
1/5	2. 6867 39790	2. 6905 67070	2. 6943 72696	2. 6981 56943	2. 7019 20077
1	145	146	147	148	149
2	21025	21316	21609	21904	22201
3	30 48625	31 12136	31 76523	32 41792	33 07949
4	4420 50625	4543 71856	4669 48881	4797 85216	4928 84401
5	(10) 6. 4097 34063	(10) 6. 6338 23098	(10) 6. 8641 48551	(10) 7. 1008 21197	(10) 7. 3439 77575
6	(12) 9. 2941 14391	(12) 9. 6853 90482	(13) 1. 0090 29837	(13) 1. 0509 21537	(13) 1. 0942 52659
7	(15) 1. 3476 46587	(15) 1. 4140 67010	(15) 1. 4832 73860	(15) 1. 5553 63875	(15) 1. 6304 36461
8	(17) 1. 9540 87551	(17) 2. 0645 37835	(17) 2. 1804 12575	(17) 2. 3019 38535	(17) 2. 4293 50327
9	(19) 2. 8334 26948	(19) 3. 0142 25239	(19) 3. 2052 06485	(19) 3. 4068 69032	(19) 3. 6197 31988
10	(21) 4. 1084 69075	(21) 4. 4007 68850	(21) 4. 7116 53533	(21) 5. 0421 66167	(21) 5. 3934 00662
24	(51) 7. 4616 01544	(51) 8. 7997 13625	(52) 1. 0366 11527	(52) 1. 2197 79049	(52) 1. 4337 40132
1/2	(1) 1. 2041 59458	(1) 1. 2083 04597	(1) 1. 2124 35565	(1) 1. 2165 52506	(1) 1. 2206 55562
1/3	5. 2535 87872	5. 2656 37428	5. 2776 32088	5. 2895 72473	5. 3014 59192
1/4	3. 4701 00082	3. 4760 67602	3. 4820 04545	3. 4879 11275	3. 4937 88147
1/5	2. 7056 62363	2. 7093 84058	2. 7130 85417	2. 7167 66686	2. 7204 28110

$$n^2 \binom{-5}{4} \quad n^3 \binom{-6}{5} \quad n^4 \binom{-6}{4} \quad n^5 \binom{-6}{4}$$

Table 3.1 POWERS AND ROOTS n^k

k					
1		150	151	152	153
2		22500	22801	23104	23409
3		33 75000	34 42951	35 11808	35 81577
4		5062 50000	5198 85601	5337 94816	5479 81281
5	(10)	7.5937 50000	(10) 7.8502 72575	(10) 8.1136 81203	(10) 8.3841 13599
6	(13)	1.1390 62500	(13) 1.1853 91159	(13) 1.2332 79543	(13) 1.2827 69381
7	(15)	1.7085 93750	(15) 1.7899 40650	(15) 1.8745 84905	(15) 1.9626 37152
8	(17)	2.5628 90625	(17) 2.7028 10381	(17) 2.8493 69056	(17) 3.0028 34843
9	(19)	3.8443 35938	(19) 4.0812 43676	(19) 4.3310 40965	(19) 4.5943 37310
10	(21)	5.7665 03906	(21) 6.1626 77950	(21) 6.5831 82267	(21) 7.0293 36085
24	(52)	1.6834 11220	(52) 1.9744 52704	(52) 2.3133 75387	(52) 2.7076 61312
1/2	(1)	1.2247 44871	(1) 1.2288 20573	(1) 1.2328 82801	(1) 1.2369 31688
1/3		5.3132 92846	5.3250 74022	5.3368 03297	5.3484 81241
1/4		3.4996 35512	3.5054 53712	3.5112 43086	3.5170 03963
1/5		2.7240 69927	2.7276 92374	2.7312 95679	2.7348 80069
1		155	156	157	158
2		24025	24336	24649	24964
3		37 23875	37 96416	38 69893	39 44312
4		5772 00625	5922 40896	6075 73201	6232 01296
5	(10)	8.9466 09688	(10) 9.2389 57978	(10) 9.5388 99256	(10) 9.8465 80477
6	(13)	1.3867 24502	(13) 1.4412 77445	(13) 1.4976 07183	(13) 1.5557 59715
7	(15)	2.1494 22977	(15) 2.2483 92813	(15) 2.3512 43278	(15) 2.4581 00350
8	(17)	3.3316 05615	(17) 3.5074 92789	(17) 3.6914 51946	(17) 3.8837 98553
9	(19)	5.1639 88703	(19) 5.4716 88751	(19) 5.7955 79555	(19) 6.1364 01714
10	(21)	8.0041 82490	(21) 8.5358 34451	(21) 9.0990 59901	(21) 9.6955 14709
24	(52)	3.6979 47627	(52) 4.3150 94990	(52) 5.0302 74186	(52) 5.8582 79483
1/2	(1)	1.2449 89960	(1) 1.2489 99600	(1) 1.2529 96409	(1) 1.2569 80509
1/3		5.3716 85355	5.3832 12612	5.3946 90712	5.4061 20176
1/4		3.5284 41525	3.5341 18843	3.5397 68931	3.5453 92093
1/5		2.7419 92987	2.7455 21947	2.7490 32856	2.7525 25920
1		160	161	162	163
2		25600	25921	26244	26569
3		40 96000	41 73281	42 51528	43 30747
4		6553 60000	6718 98241	6887 47536	7059 11761
5	(11)	1.0485 76000	(11) 1.0817 56168	(11) 1.1157 71008	(11) 1.1506 36170
6	(13)	1.6777 21600	(13) 1.7416 27430	(13) 1.8075 49033	(13) 1.8755 36958
7	(15)	2.6843 54560	(15) 2.8040 20163	(15) 2.9282 29434	(15) 3.0571 25241
8	(17)	4.2949 67296	(17) 4.5144 72463	(17) 4.7437 31683	(17) 4.9831 14143
9	(19)	6.8719 47674	(19) 7.2683 00665	(19) 7.6848 45327	(19) 8.1224 76053
10	(22)	1.0995 11628	(22) 1.1701 96407	(22) 1.2449 44943	(22) 1.3239 63597
24	(52)	7.9228 16251	(52) 9.2007 03274	(53) 1.0674 81480	(53) 1.2373 78329
1/2	(1)	1.2649 11064	(1) 1.2688 57754	(1) 1.2727 92206	(1) 1.2767 14533
1/3		5.4288 35233	5.4401 21825	5.4513 61778	5.4625 55571
1/4		3.5565 58820	3.5621 02966	3.5676 21345	3.5731 14235
1/5		2.7594 59323	2.7629 00056	2.7663 23734	2.7697 30547
1		165	166	167	168
2		27225	27556	27889	28224
3		44 92125	45 74296	46 57463	47 41632
4		7412 00625	7593 33136	7777 96321	7965 94176
5	(11)	1.2229 81031	(11) 1.2604 93006	(11) 1.2989 19856	(11) 1.3382 78216
6	(13)	2.0179 18702	(13) 2.0924 18390	(13) 2.1691 96160	(13) 2.2483 07402
7	(15)	3.3295 65858	(15) 3.4734 14527	(15) 3.6225 57587	(15) 3.7771 56436
8	(17)	5.4937 83665	(17) 5.7658 68114	(17) 6.0496 71170	(17) 6.3456 22812
9	(19)	9.0647 43047	(19) 9.5713 41070	(19) 1.0102 95085	(20) 1.0660 64632
10	(22)	1.4956 82603	(22) 1.5888 42618	(22) 1.6871 92792	(22) 1.7909 88583
24	(53)	1.6581 15050	(53) 1.9168 76411	(53) 2.2140 90189	(53) 2.5551 87425
1/2	(1)	1.2845 23258	(1) 1.2884 09873	(1) 1.2922 84798	(1) 1.2961 48140
1/3		5.4848 06552	5.4958 64660	5.5068 78446	5.5178 48353
1/4		3.5840 24634	3.5894 42676	3.5948 36294	3.6002 05744
1/5		2.7764 94317	2.7798 51635	2.7831 92813	2.7865 18023
1		170	171	172	173
2		28900	29241	29584	29929
3		49 13000	50 00211	50 88448	51 77717
4		8352 10000	8550 36081	8752 13056	8957 45041
5	(11)	1.4198 57000	(11) 1.4621 11699	(11) 1.5053 66456	(11) 1.5496 38921
6	(13)	2.4137 56900	(13) 2.5002 11004	(13) 2.5892 30305	(13) 2.6808 75333
7	(15)	4.1033 86730	(15) 4.2753 60818	(15) 4.4534 76124	(15) 4.6379 14326
8	(17)	6.9757 57441	(17) 7.3108 66998	(17) 7.6599 78934	(17) 8.0235 91785
9	(20)	1.1858 78765	(20) 1.2501 58257	(20) 1.3175 16377	(20) 1.3880 81379
10	(22)	2.0159 93900	(22) 2.1377 70619	(22) 2.2661 28168	(22) 2.4013 80785
24	(53)	3.3944 86713	(53) 3.9075 68945	(53) 4.4945 13878	(53) 5.1654 29935
1/2	(1)	1.3038 40481	(1) 1.3076 69683	(1) 1.3114 87705	(1) 1.3152 94644
1/3		5.5396 58257	5.5504 99103	5.5612 97766	5.5720 54656
1/4		3.6108 73137	3.6161 71571	3.6214 46817	3.6266 99110
1/5		2.7931 21220	2.7963 99540	2.7996 62559	2.8029 10436
		$\frac{1}{n^2} \binom{-5}{4} 2$	$\frac{1}{n^3} \binom{-6}{4} 7$	$\frac{1}{n^4} \binom{-6}{4} 4$	$\frac{1}{n^5} \binom{-6}{4} 3$

POWERS AND ROOTS n^k

Table 3.1

k							
1		175	176	177	178	179	
2		30625	30976	31329	31684	32041	
3		53 59375	54 51776	55 45233	56 39752	57 35339	
4		9378 90625	9595 12576	9815 06241	(9)1.0038 75856	(9)1.0266 25681	
5	(11)1.6413 08594	(11)1.6887 42134	(11)1.7372 66047	(11)1.7868 99024	(11)1.8376 59669	(11)1.8911 13444	
6	(13)2.8722 90039	(13)2.9721 86155	(13)3.0749 60902	(13)3.1806 80262	(13)3.2884 11344	(13)3.3989 46307	
7	(15)5.0265 07568	(15)5.2310 47634	(15)5.4426 10879	(15)5.6616 10867	(15)5.8890 46307	(15)6.1268 88917	
8	(17)8.7963 88245	(17)9.2066 43835	(17)9.6335 45011	(17)10.0777 66734	(17)10.5399 60289	(17)11.0200 60289	
9	(20)1.5393 67943	(20)1.6203 69315	(20)1.7051 37467	(20)1.7938 24787	(20)1.8865 88917	(20)1.9849 94162	
10	(22)2.6938 93900	(22)2.8518 49994	(22)3.0180 93317	(22)3.1930 08121	(22)3.3769 94162	(22)3.5712 32041	
24	(53)6.8063 32613	(53)7.8037 62212	(53)8.9404 29702	(53)10.2344 81638	(53)11.6806 08816	(53)13.2812 32041	
1/2	(1)1.3228 75656	(1)1.3266 49916	(1)1.3304 13470	(1)1.3341 66406	(1)1.3379 08816	(1)1.3417 32041	
1/3	5.5934 44710	5.6040 78661	5.6146 72408	5.6252 26328	5.6357 40794	5.6462 55260	
1/4	3.6371 35763	3.6423 20574	3.6474 83337	3.6526 24271	3.6577 43589	3.6628 62907	
1/5	2.8093 61392	2.8125 64777	2.8157 53634	2.8189 28111	2.8220 88352	2.8252 32041	
1		180	181	182	183	184	
2		32400	32761	33124	33489	33856	
3		58 32000	59 29741	60 28568	61 28487	62 29504	
4	(9)1.0497 60000	(9)1.0732 83121	(9)1.0971 99376	(9)1.1215 13121	(9)1.1462 28736	(9)1.1713 60000	
5	(11)1.8895 68000	(11)1.9426 42449	(11)1.9969 02864	(11)2.0523 69011	(11)2.1090 60874	(11)2.1672 28736	
6	(13)3.4012 22400	(13)3.5161 82833	(13)3.6343 63213	(13)3.7558 35291	(13)3.8806 72009	(13)4.0098 08816	
7	(15)6.1222 00320	(15)6.3642 90927	(15)6.6145 41048	(15)6.8731 78582	(15)7.1404 36496	(15)7.4162 08816	
8	(18)1.1019 96058	(18)1.1519 36658	(18)1.2038 46471	(18)1.2577 91681	(18)1.3138 40315	(18)1.3719 84062	
9	(20)1.9835 92904	(20)2.0850 05351	(20)2.1910 00577	(20)2.3017 58775	(20)2.4174 66180	(20)2.5382 24000	
10	(22)3.5704 67227	(22)3.7738 59685	(22)3.9876 21050	(22)4.2122 18559	(22)4.4481 37771	(22)4.6958 31716	
24	(54)1.3382 58845	(54)1.5285 71637	(54)1.7446 70074	(54)1.9898 76639	(54)2.2679 20111	(54)2.5829 82606	
1/2	(1)1.3416 40786	(1)1.3453 62405	(1)1.3490 73756	(1)1.3527 74926	(1)1.3564 65997	(1)1.3601 57208	
1/3	5.6462 16173	5.6566 52826	5.6670 51108	5.6774 11371	5.6877 33960	5.6980 19215	
1/4	3.6628 41501	3.6679 18217	3.6729 73940	3.6780 08871	3.6830 23210	3.6880 17151	
1/5	2.8252 34501	2.8283 66697	2.8314 85080	2.8345 89786	2.8376 80950	2.8407 58702	
1		185	186	187	188	189	
2		34225	34596	34969	35344	35721	
3		63 31625	64 34856	65 39203	66 44672	67 51269	
4	(9)1.1713 50625	(9)1.1968 83216	(9)1.2228 30961	(9)1.2491 98336	(9)1.2759 89841	(9)1.3032 10000	
5	(11)2.1669 98656	(11)2.2262 02782	(11)2.2866 93897	(11)2.3484 92872	(11)2.4116 20799	(11)2.4760 99000	
6	(13)4.0889 47514	(13)4.1407 37174	(13)4.2761 17588	(13)4.4151 66599	(13)4.5579 63311	(13)4.7045 88100	
7	(15)7.4165 52901	(15)7.7017 71144	(15)7.9963 39889	(15)8.3005 13206	(15)8.6145 50658	(15)8.9387 17390	
8	(18)1.3720 62287	(18)1.4325 29433	(18)1.4953 15559	(18)1.5604 96483	(18)1.6281 50074	(18)1.6983 56304	
9	(20)2.5383 15230	(20)2.6645 04745	(20)2.7962 40096	(20)2.9337 33387	(20)3.0772 03640	(20)3.2268 76978	
10	(22)4.6958 83176	(22)4.9559 78826	(22)5.2289 68979	(22)5.5154 18768	(22)5.8112 14881	(22)6.1130 66258	
24	(54)2.5829 82606	(54)2.9397 51775	(54)3.3434 78670	(54)3.8000 41874	(54)4.3160 18526	(54)4.8987 62931	
1/2	(1)1.3601 47051	(1)1.3638 18170	(1)1.3674 79433	(1)1.3711 30920	(1)1.3747 72708	(1)1.3784 04875	
1/3	5.6980 19215	5.7082 67473	5.7184 79065	5.7286 54316	5.7387 93548	5.7488 97079	
1/4	3.6880 17151	3.6929 90888	3.6979 44609	3.7028 78502	3.7077 92751	3.7126 87538	
1/5	2.8407 58702	2.8438 23174	2.8468 74493	2.8499 12786	2.8529 38178	2.8559 50791	
1		190	191	192	193	194	
2		36100	36481	36864	37249	37636	
3		68 59000	69 67871	70 77888	71 89057	73 01384	
4	(9)1.3032 10000	(9)1.3308 63361	(9)1.3589 54496	(9)1.3874 88001	(9)1.4164 68496	(9)1.4459 00625	
5	(11)2.4760 99000	(11)2.5419 49020	(11)2.6091 92632	(11)2.6778 51842	(11)2.7479 48882	(11)2.8195 06219	
6	(13)4.7045 88100	(13)4.8551 22627	(13)5.0096 49854	(13)5.1682 54055	(13)5.3310 20832	(13)5.4980 37127	
7	(15)8.9387 17390	(15)9.2732 84218	(15)9.6185 27720	(15)9.9747 30326	(15)10.3426 30326	(15)10.7126 30326	
8	(18)1.6983 56304	(18)1.7711 97286	(18)1.8467 57322	(18)1.9251 22953	(18)2.0063 83000	(18)2.0906 28617	
9	(20)3.2268 76978	(20)3.3829 86816	(20)3.5457 74059	(20)3.7154 87299	(20)3.8923 83020	(20)4.0767 25804	
10	(22)6.1310 66258	(22)6.4615 04818	(22)6.8078 86193	(22)7.1708 90487	(22)7.5512 23059	(22)7.9496 15318	
24	(54)4.8987 62931	(54)5.5564 93542	(54)6.2983 89130	(54)7.1346 95065	(54)8.0768 40718	(54)9.1375 69069	
1/2	(1)1.3784 04875	(1)1.3820 27496	(1)1.3856 40646	(1)1.3892 44399	(1)1.3928 38828	(1)1.3964 24004	
1/3	5.7488 97079	5.7589 65220	5.7689 98281	5.7789 96565	5.7889 60372	5.7988 89998	
1/4	3.7126 87538	3.7175 63041	3.7224 19436	3.7272 56899	3.7320 75599	3.7368 75706	
1/5	2.8559 50791	2.8589 50746	2.8619 38162	2.8649 13156	2.8678 75844	2.8708 26340	
1		195	196	197	198	199	
2		38025	38416	38809	39204	39601	
3		74 14875	75 29536	76 45373	77 62392	78 80599	
4	(9)1.4459 00625	(9)1.4757 89056	(9)1.5061 38481	(9)1.5369 53616	(9)1.5682 39201	(9)1.6000 10000	
5	(11)2.8195 06219	(11)2.8925 46550	(11)2.9670 92808	(11)3.0431 68160	(11)3.1207 96010	(11)3.2000 10000	
6	(13)5.4980 37127	(13)5.6693 91238	(13)5.8451 72831	(13)6.0254 72956	(13)6.2103 84060	(13)6.3989 46307	
7	(16)1.0721 17240	(16)1.1112 00683	(16)1.1514 99048	(16)1.1930 43645	(16)1.2358 66428	(16)1.2800 10000	
8	(18)2.0906 28617	(18)2.1779 53338	(18)2.2684 53124	(18)2.3622 26418	(18)2.4593 74192	(18)2.5583 24000	
9	(20)4.0767 25804	(20)4.2687 88542	(20)4.4688 52654	(20)4.6772 08307	(20)4.8941 54641	(20)5.1226 32041	
10	(22)7.9496 15318	(22)8.3668 25543	(22)8.8036 39729	(22)9.2608 72448	(22)9.7393 67736	(22)10.2400 10000	
24	(54)9.1375 69069	(54)10.0331 07971	(54)11.1673 18660	(54)12.4918 49187	(54)14.0278 24728	(54)15.7746 57746	
1/2	(1)1.3964 24004	(1)1.4000 00000	(1)1.4035 66885	(1)1.4071 24728	(1)1.4106 73598	(1)1.4141 32041	
1/3	5.7988 89998	5.8087 85734	5.8186 47867	5.8284 76683	5.8382 72461	5.8480 75706	
1/4	3.7368 75706	3.7416 57387	3.7464 20805	3.7511 66123	3.7558 93499	3.7605 26340	
1/5	2.8708 26340	2.8737 64756	2.8766 91203	2.8795 05790	2.8824 08624	2.8853 01384	

$$n^2 \left[\begin{matrix} (-5) \\ 4 \end{matrix} \right]$$

$$n^3 \left[\begin{matrix} (-6) \\ 4 \end{matrix} \right]$$

$$n^4 \left[\begin{matrix} (-6) \\ 4 \end{matrix} \right]$$

$$n^5 \left[\begin{matrix} (-6) \\ 4 \end{matrix} \right]$$

Table 3.1

POWERS AND ROOTS n^k

k	200	201	202	203	204
1	200	201	202	203	204
2	40000	40401	40804	41209	41616
3	80 00000	81 20601	82 42408	83 65427	84 89664
4	(9) 1.6000 00000 (9) 1.6322 40801 (9) 1.6649 66416 (9) 1.6981 81681 (9) 1.7318 91456				
5	(11) 3.2000 00000 (11) 3.2808 04010 (11) 3.3632 32160 (11) 3.4473 08812 (11) 3.5330 58570				
6	(13) 6.4000 00000 (13) 6.5944 16060 (13) 6.7937 28964 (13) 6.9980 36889 (13) 7.2074 39483				
7	(16) 1.2800 00000 (16) 1.3254 77628 (16) 1.3723 33251 (16) 1.4206 01489 (16) 1.4703 17655				
8	(18) 2.5600 00000 (18) 2.6642 10032 (18) 2.7721 13166 (18) 2.8838 21022 (18) 2.9994 48015				
9	(20) 5.1200 00000 (20) 5.3550 62165 (20) 5.5996 68596 (20) 5.8541 56674 (20) 6.1188 73951				
10	(23) 1.0240 00000 (23) 1.0763 67495 (23) 1.1311 33056 (23) 1.1883 93805 (23) 1.2482 50286				
24	(55) 1.6777 21600 (55) 1.8910 60303 (55) 2.1302 61246 (55) 2.3983 07745 (55) 2.6985 09916				
1/2	(1) 1.4142 13562 (1) 1.4177 44688 (1) 1.4212 67040 (1) 1.4247 80685 (1) 1.4282 85686				
1/3	5.8480 35476 5.8577 66003 5.8674 64308 5.8771 30659 5.8867 65317				
1/4	3.7606 03093 3.7652 95059 3.7699 69549 3.7746 26716 3.7792 66709				
1/5	2.8853 99812 2.8882 79458 2.8911 47666 2.8940 04537 2.8968 50171				
1	205	206	207	208	209
2	42025	42436	42849	43264	43681
3	86 15125	87 41816	88 69743	89 98912	91 29329
4	(9) 1.7661 00625 (9) 1.8008 14096 (9) 1.8360 36801 (9) 1.8717 73696 (9) 1.9080 29761				
5	(11) 3.6205 06281 (11) 3.7096 77038 (11) 3.8005 96178 (11) 3.8932 89288 (11) 3.9877 82200				
6	(13) 7.4220 37877 (13) 7.6419 34698 (13) 7.8672 34089 (13) 8.0980 41718 (13) 8.3344 64799				
7	(16) 1.5215 17765 (16) 1.5742 38548 (16) 1.6285 17456 (16) 1.6843 92677 (16) 1.7419 03143				
8	(18) 3.1191 11418 (18) 3.2429 31408 (18) 3.3710 31135 (18) 3.5035 36769 (18) 3.6405 77569				
9	(20) 6.3941 78406 (20) 6.6804 38701 (20) 6.9780 34449 (20) 7.2873 56480 (20) 7.6088 07119				
10	(23) 1.3108 06573 (23) 1.3761 70372 (23) 1.4444 53131 (23) 1.5157 70148 (23) 1.5902 40688				
24	(55) 3.0345 38594 (55) 3.4104 62581 (55) 3.8307 89523 (55) 4.3005 10765 (55) 4.8251 50531				
1/2	(1) 1.4317 82106 (1) 1.4352 70009 (1) 1.4387 49457 (1) 1.4422 20510 (1) 1.4456 83229				
1/3	5.8963 68540 5.9059 40584 5.9154 81700 5.9249 92137 5.9344 72140				
1/4	3.7838 89674 3.7884 95756 3.7930 85099 3.7976 57844 3.8022 14131				
1/5	2.8996 84668 2.9025 08125 2.9053 20638 2.9081 22302 2.9109 13212				
1	210	211	212	213	214
2	44100	44521	44944	45369	45796
3	92 61000	93 93931	95 28128	96 63597	98 00344
4	(9) 1.9448 10000 (9) 1.9821 19441 (9) 2.0199 63136 (9) 2.0583 46161 (9) 2.0972 73616				
5	(11) 4.0841 01000 (11) 4.1822 72021 (11) 4.2823 21848 (11) 4.3842 77323 (11) 4.4881 65538				
6	(13) 8.5766 12100 (13) 8.8245 93963 (13) 9.0785 22318 (13) 9.3385 10698 (13) 9.6046 74252				
7	(16) 1.8010 88541 (16) 1.8619 89326 (16) 1.9246 46732 (16) 1.9891 02779 (16) 2.0554 00290				
8	(18) 3.7822 85936 (18) 3.9287 97478 (18) 4.0802 51071 (18) 4.2367 88919 (18) 4.3985 56620				
9	(20) 7.9428 00466 (20) 8.2897 62679 (20) 8.6501 32270 (20) 9.0243 60396 (20) 9.4129 11168				
10	(23) 1.6679 88098 (23) 1.7491 39925 (23) 1.8338 28041 (23) 1.9221 88764 (23) 2.0143 62990				
24	(55) 5.4108 19838 (55) 6.0642 75557 (55) 6.7929 85105 (55) 7.6051 97251 (55) 8.5100 19601				
1/2	(1) 1.4491 37675 (1) 1.4525 83905 (1) 1.4560 21978 (1) 1.4594 51952 (1) 1.4628 73884				
1/3	5.9439 21953 5.9533 41813 5.9627 31958 5.9720 92620 5.9814 24030				
1/4	3.8067 54096 3.8112 77876 3.8157 85604 3.8202 77414 3.8247 53435				
1/5	2.9136 93459 2.9164 63134 2.9192 22328 2.9219 71130 2.9247 09627				
1	215	216	217	218	219
2	46225	46656	47089	47524	47961
3	99 38375	100 77696	102 18313	103 60232	105 03459
4	(9) 2.1367 50625 (9) 2.1767 82336 (9) 2.2173 73921 (9) 2.2585 30576 (9) 2.3002 57521				
5	(11) 4.5940 13844 (11) 4.7018 49846 (11) 4.8117 01409 (11) 4.9235 96656 (11) 5.0375 63971				
6	(13) 9.8771 29764 (14) 1.0155 99567 (14) 1.0441 39206 (14) 1.0733 44071 (14) 1.1032 26510				
7	(16) 2.1235 82899 (16) 2.1936 95064 (16) 2.2657 82076 (16) 2.3398 90075 (16) 2.4160 66056				
8	(18) 4.5657 03233 (18) 4.7383 81338 (18) 4.9167 47106 (18) 5.1009 60363 (18) 5.2911 84663				
9	(20) 9.8162 61952 (21) 1.0234 90369 (21) 1.0669 34122 (21) 1.1120 09359 (21) 1.1587 69441				
10	(23) 2.1104 96320 (23) 2.2107 39197 (23) 2.3152 47045 (23) 2.4241 80403 (23) 2.5377 05076				
24	(55) 9.5175 03342 (56) 1.0638 73589 (56) 1.1885 94216 (56) 1.3272 59512 (56) 1.4813 53665				
1/2	(1) 1.4662 87830 (1) 1.4696 93846 (1) 1.4730 91986 (1) 1.4764 82306 (1) 1.4798 64859				
1/3	5.9907 26415 6.0000 00000 6.0092 45007 6.0184 61655 6.0276 50160				
1/4	3.8292 13796 3.8336 58625 3.8380 88048 3.8425 02187 3.8469 01167				
1/5	2.9274 37906 2.9301 56052 2.9328 64149 2.9355 62280 2.9382 50529				
1	220	221	222	223	224
2	48400	48841	49284	49729	50176
3	106 48000	107 93861	109 41048	110 89567	112 39424
4	(9) 2.3425 60000 (9) 2.3854 43281 (9) 2.4289 12656 (9) 2.4729 73441 (9) 2.5176 30976				
5	(11) 5.1536 32000 (11) 5.2718 29651 (11) 5.3921 86096 (11) 5.5147 30773 (11) 5.6394 93386				
6	(14) 1.1337 99040 (14) 1.1650 74353 (14) 1.1970 65313 (14) 1.2297 84962 (14) 1.2632 46519				
7	(16) 2.4943 57888 (16) 2.5748 14320 (16) 2.6574 84996 (16) 2.7424 20466 (16) 2.8296 72201				
8	(18) 5.4875 87354 (18) 5.6903 39647 (18) 5.8996 16690 (18) 6.1155 97640 (18) 6.3384 65731				
9	(21) 1.2072 69218 (21) 1.2575 65062 (21) 1.3097 14905 (21) 1.3637 78274 (21) 1.4198 16324				
10	(23) 2.6559 92279 (23) 2.7792 18787 (23) 2.9075 67090 (23) 3.0412 25550 (23) 3.1803 88565				
24	(56) 1.6525 10926 (56) 1.8425 30003 (56) 2.0533 89736 (56) 2.2872 66205 (56) 2.5465 51362				
1/2	(1) 1.4832 39697 (1) 1.4866 06875 (1) 1.4899 66443 (1) 1.4933 18452 (1) 1.4966 62955				
1/3	6.0368 10737 6.0459 43596 6.0550 48947 6.0641 26994 6.0731 77944				
1/4	3.8512 85107 3.8556 54127 3.8600 08345 3.8643 47878 3.8686 72841				
1/5	2.9409 28975 2.9435 97699 2.9462 56780 2.9489 06295 2.9515 46323				

$$n^{\frac{1}{2}} \left[\begin{matrix} (-5) \\ 4 \end{matrix} \right] \quad n^{\frac{1}{3}} \left[\begin{matrix} (-6) \\ 4 \end{matrix} \right] \quad n^{\frac{1}{4}} \left[\begin{matrix} (-6) \\ 4 \end{matrix} \right] \quad n^{\frac{1}{5}} \left[\begin{matrix} (-6) \\ 4 \end{matrix} \right]$$

POWERS AND ROOTS n^k

Table 3.1

k							
1		225	226	227	228		229
2		50625	51076	51529	51984		52441
3		113 90625	115 43176	116 97083	118 52352		120 08989
4	(9) 2. 5628 90625	(9) 2. 6087 57776	(9) 2. 6552 37841	(9) 2. 7023 36256	(9) 2. 7500 58481		
5	(11) 5. 7665 03906	(11) 5. 8957 92574	(11) 6. 0273 89899	(11) 6. 1613 26664	(11) 6. 2976 33921		
6	(14) 1. 2974 63379	(14) 1. 3324 49122	(14) 1. 3682 17507	(14) 1. 4047 82479	(14) 1. 4421 58168		
7	(16) 2. 9192 92603	(16) 3. 0113 35015	(16) 3. 1058 53741	(16) 3. 2029 04053	(16) 3. 3025 42205		
8	(18) 6. 5684 08356	(18) 6. 8056 17134	(18) 7. 0502 87992	(18) 7. 3026 21240	(18) 7. 5628 21649		
9	(21) 1. 4778 91880	(21) 1. 5380 69472	(21) 1. 6004 15374	(21) 1. 6649 97643	(21) 1. 7318 86158		
10	(23) 3. 3252 56730	(23) 3. 4760 37007	(23) 3. 6329 42900	(23) 3. 7961 94626	(23) 3. 9660 19301		
24	(56) 2. 8338 73334	(56) 3. 1521 18526	(56) 3. 5044 55686	(56) 3. 8943 62082	(56) 4. 3256 51988		
1/2	(1) 1. 5000 00000	(1) 1. 5033 29638	(1) 1. 5066 51917	(1) 1. 5099 66887	(1) 1. 5132 74595		
1/3	6. 0822 01996	6. 0911 99349	6. 1001 70200	6. 1091 14744	6. 1180 33173		
1/4	3. 8729 83346	3. 8772 79507	3. 8815 61435	3. 8858 29258	3. 8900 83026		
1/5	2. 9541 76939	2. 9567 98218	2. 9594 10235	2. 9620 13062	2. 9646 06773		
1		230	231	232	233		234
2		52900	53361	53824	54289		54756
3		121 67000	123 26391	124 87168	126 49337		128 12904
4	(9) 2. 7984 10000	(9) 2. 8473 96321	(9) 2. 8970 22976	(9) 2. 9472 95521	(9) 2. 9982 19536		
5	(11) 6. 4363 43000	(11) 6. 5774 85502	(11) 6. 7210 93304	(11) 6. 8671 98564	(11) 7. 0158 33714		
6	(14) 1. 4803 58890	(14) 1. 5193 99151	(14) 1. 5592 93647	(14) 1. 6000 57265	(14) 1. 6417 05089		
7	(16) 3. 4048 25447	(16) 3. 5098 12038	(16) 3. 6175 61260	(16) 3. 7281 33428	(16) 3. 8415 89909		
8	(18) 7. 8310 98528	(18) 8. 1076 65809	(18) 8. 3927 42123	(18) 8. 6865 50888	(18) 8. 9893 20386		
9	(21) 1. 8011 52661	(21) 1. 8728 70802	(21) 1. 9471 16173	(21) 2. 0239 66357	(21) 2. 1035 00970		
10	(23) 4. 1426 51121	(23) 4. 3263 31552	(23) 4. 5173 09521	(23) 4. 7158 41612	(23) 4. 9221 92271		
24	(56) 4. 8025 07640	(56) 5. 3295 12896	(56) 5. 9116 89798	(56) 6. 5545 38287	(56) 7. 2640 79321		
1/2	(1) 1. 5165 75089	(1) 1. 5198 68415	(1) 1. 5231 54621	(1) 1. 5264 33752	(1) 1. 5297 05854		
1/3	6. 1269 25675	6. 1357 92440	6. 1446 33651	6. 1534 49494	6. 1622 40148		
1/4	3. 8943 22905	3. 8985 48980	3. 9027 61357	3. 9069 60138	3. 9111 45426		
1/5	2. 9671 91438	2. 9697 67129	2. 9723 33915	2. 9748 91866	2. 9774 41049		
1		235	236	237	238		239
2		55225	55696	56169	56644		57121
3		129 77875	131 44256	133 12053	134 81272		136 51919
4	(9) 3. 0498 00625	(9) 3. 1020 44416	(9) 3. 1549 56561	(9) 3. 2085 42736	(9) 3. 2628 08641		
5	(11) 7. 1670 31469	(11) 7. 3208 24822	(11) 7. 4772 47050	(11) 7. 6363 31712	(11) 7. 7981 12652		
6	(14) 1. 6842 52395	(14) 1. 7277 14658	(14) 1. 7721 07551	(14) 1. 8174 46947	(14) 1. 8637 48924		
7	(16) 3. 9579 93129	(16) 4. 0774 06593	(16) 4. 1998 94895	(16) 4. 3255 23735	(16) 4. 4543 59928		
8	(18) 9. 3012 83852	(18) 9. 6226 79559	(18) 9. 9537 50902	(18) 1. 0294 74649	(18) 1. 0645 92023		
9	(21) 2. 1858 01705	(21) 2. 2709 52376	(21) 2. 3590 38964	(21) 2. 4501 49664	(21) 2. 5443 74934		
10	(23) 5. 1366 34007	(23) 5. 3594 47607	(23) 5. 5909 22344	(23) 5. 8313 56201	(23) 6. 0810 56093		
24	(56) 8. 0469 01671	(56) 8. 9102 12697	(56) 9. 8618 93410	(57) 1. 0910 55818	(57) 1. 2065 61943		
1/2	(1) 1. 5329 70972	(1) 1. 5362 29150	(1) 1. 5394 80432	(1) 1. 5427 24862	(1) 1. 5459 62483		
1/3	6. 1710 05793	6. 1797 46606	6. 1884 62762	6. 1971 54435	6. 2058 21795		
1/4	3. 9153 17320	3. 9194 75921	3. 9236 21327	3. 9277 53635	3. 9318 72942		
1/5	2. 9799 81531	2. 9825 13380	2. 9850 36660	2. 9875 51438	2. 9900 57776		
1		240	241	242	243		244
2		57600	58081	58564	59049		59536
3		138 24000	139 97521	141 72488	143 48907		145 26784
4	(9) 3. 3177 60000	(9) 3. 3734 02561	(9) 3. 4297 42096	(9) 3. 4867 84401	(9) 3. 5445 35296		
5	(11) 7. 9626 24000	(11) 8. 1299 00172	(11) 8. 2999 75872	(11) 8. 4728 86094	(11) 8. 6486 66122		
6	(14) 1. 9110 29760	(14) 1. 9593 05941	(14) 2. 0085 94161	(14) 2. 0589 11321	(14) 2. 1102 74534		
7	(16) 4. 5864 71424	(16) 4. 7219 27319	(16) 4. 8607 97870	(16) 5. 0031 54510	(16) 5. 1490 69863		
8	(19) 1. 1007 53142	(19) 1. 1379 84484	(19) 1. 1763 13085	(19) 1. 2157 66546	(19) 1. 2563 73046		
9	(21) 2. 6418 07540	(21) 2. 7425 42606	(21) 2. 8466 77665	(21) 2. 9543 12707	(21) 3. 0655 50233		
10	(23) 6. 3403 38097	(23) 6. 6095 27681	(23) 6. 8889 59948	(23) 7. 1789 79877	(23) 7. 4799 42569		
24	(57) 1. 3337 35777	(57) 1. 4736 99791	(57) 1. 6276 79087	(57) 1. 7970 10300	(57) 1. 9831 51223		
1/2	(1) 1. 5491 93338	(1) 1. 5524 17470	(1) 1. 5556 34919	(1) 1. 5588 45727	(1) 1. 5620 49935		
1/3	6. 2144 65012	6. 2230 84253	6. 2316 79684	6. 2402 51469	6. 2487 99770		
1/4	3. 9359 79343	3. 9400 72930	3. 9441 53798	3. 9482 22039	3. 9522 77742		
1/5	2. 9925 55740	2. 9950 45390	2. 9975 26790	2. 9999 00000	3. 0024 65081		
1		245	246	247	248		249
2		60025	60516	61009	61504		62001
3		147 06125	148 86936	150 69223	152 52992		154 38249
4	(9) 3. 6030 00625	(9) 3. 6621 86256	(9) 3. 7220 98081	(9) 3. 7827 42016	(9) 3. 8441 24001		
5	(11) 8. 8273 51531	(11) 9. 0089 78190	(11) 9. 1935 82260	(11) 9. 3812 00200	(11) 9. 5718 68762		
6	(14) 2. 1627 01125	(14) 2. 2162 08635	(14) 2. 2708 14818	(14) 2. 3265 37650	(14) 2. 3833 95322		
7	(16) 5. 2986 17757	(16) 5. 4518 73241	(16) 5. 6089 12601	(16) 5. 7698 13371	(16) 5. 9346 54351		
8	(19) 1. 2981 61350	(19) 1. 3411 60817	(19) 1. 3854 01412	(19) 1. 4309 13716	(19) 1. 4777 28934		
9	(21) 3. 1804 95308	(21) 3. 2992 55611	(21) 3. 4219 41489	(21) 3. 5486 66016	(21) 3. 6795 45044		
10	(23) 7. 7922 13506	(23) 8. 1161 68802	(23) 8. 4521 95477	(23) 8. 8006 91719	(23) 9. 1620 67161		
24	(57) 2. 1876 91225	(57) 2. 4123 62509	(57) 2. 6590 52293	(57) 2. 9298 15956	(57) 3. 2268 91257		
1/2	(1) 1. 5652 47584	(1) 1. 5684 38714	(1) 1. 5716 23365	(1) 1. 5748 01575	(1) 1. 5779 73384		
1/3	6. 2573 24746	6. 2658 26556	6. 2743 05357	6. 2827 61305	6. 2911 94552		
1/4	3. 9563 20998	3. 9603 51896	3. 9643 70523	3. 9683 76966	3. 9723 71312		
1/5	3. 0049 22094	3. 0073 71096	3. 0098 12147	3. 0122 45305	3. 0146 70627		

$$n^2 \sqrt[4]{(-6)9} \quad n^3 \sqrt[4]{(-6)3} \quad n^4 \sqrt[4]{(-6)2} \quad n^5 \sqrt[4]{(-6)1}$$

Table 3.1 POWERS AND ROOTS n^k

k					
1	250	251	252	253	254
2	62500	63001	63504	64009	64516
3	156 25000	158 13251	160 03008	161 94277	163 87064
4	(9) 3. 9062 50000	(9) 3. 9691 26001	(9) 4. 0327 58016	(9) 4. 0971 52081	(9) 4. 1623 14256
5	(11) 9. 7656 25000	(11) 9. 9625 06263	(12) 1. 0162 55020	(12) 1. 0365 79476	(12) 1. 0572 27821
6	(14) 2. 4414 06250	(14) 2. 5005 89072	(14) 2. 5609 62650	(14) 2. 6225 46076	(14) 2. 6853 58665
7	(16) 6. 1035 15625	(16) 6. 2764 78570	(16) 6. 4536 25879	(16) 6. 6350 41571	(16) 6. 8208 11010
8	(19) 1. 5258 78906	(19) 1. 5753 96121	(19) 1. 6263 13722	(19) 1. 6786 65517	(19) 1. 7324 85997
9	(21) 3. 8146 97266	(21) 3. 9542 44264	(21) 4. 0983 10578	(21) 4. 2470 23759	(21) 4. 4005 14431
10	(23) 9. 5367 43164	(23) 9. 9251 53103	(24) 1. 0327 74266	(24) 1. 0744 97011	(24) 1. 1177 30666
24	(57) 3. 5527 13679	(57) 3. 9099 33001	(57) 4. 3014 31179	(57) 4. 7303 41643	(57) 5. 2000 70108
1/2	(1) 1. 5811 38830	(1) 1. 5842 97952	(1) 1. 5874 50787	(1) 1. 5905 97372	(1) 1. 5937 37745
1/3	6. 2996 05249	6. 3079 93549	6. 3163 59598	6. 3247 03543	6. 3330 25531
1/4	3. 9763 53644	3. 9803 24047	3. 9842 82604	3. 9882 29397	3. 9921 64507
1/5	3. 0170 88168	3. 0194 97986	3. 0219 00136	3. 0242 94671	3. 0266 81647
1	255	256	257	258	259
2	65025	65536	66049	66564	67081
3	165 81375	167 77216	169 74593	171 73512	173 73979
4	(9) 4. 2282 50625	(9) 4. 2949 67296	(9) 4. 3624 70401	(9) 4. 4307 66096	(9) 4. 4998 60561
5	(12) 1. 0782 03909	(12) 1. 0995 11628	(12) 1. 1211 54893	(12) 1. 1431 37653	(12) 1. 1654 63886
6	(14) 2. 7494 19969	(14) 2. 8147 49767	(14) 2. 8813 68075	(14) 2. 9492 95144	(14) 3. 0185 51463
7	(16) 7. 0110 20921	(16) 7. 2057 59404	(16) 7. 4051 15953	(16) 7. 6091 81472	(16) 7. 8180 48289
8	(19) 1. 7878 10335	(19) 1. 8446 74407	(19) 1. 9031 14800	(19) 1. 9631 68820	(19) 2. 0248 74507
9	(21) 4. 5589 16354	(21) 4. 7223 66483	(21) 4. 8910 05036	(21) 5. 0649 75555	(21) 5. 2444 24973
10	(24) 1. 1625 23670	(24) 1. 2089 25820	(24) 1. 2569 88294	(24) 1. 3067 63693	(24) 1. 3583 06068
24	(57) 5. 7143 17018	(57) 6. 2771 01735	(57) 6. 8927 88615	(57) 7. 5661 15089	(57) 8. 3022 21920
1/2	(1) 1. 5968 71942	(1) 1. 6000 00000	(1) 1. 6031 21954	(1) 1. 6062 37840	(1) 1. 6093 47694
1/3	6. 3413 25705	6. 3496 04208	6. 3578 61180	6. 3660 96760	6. 3743 11088
1/4	3. 9960 88015	4. 0000 00000	4. 0039 00541	4. 0077 89716	4. 0116 67601
1/5	3. 0290 61117	3. 0314 33133	3. 0337 97748	3. 0361 55014	3. 0385 04982
1	260	261	262	263	264
2	67600	68121	68644	69169	69696
3	175 76000	177 79581	179 84728	181 91447	183 99744
4	(9) 4. 5697 60000	(9) 4. 6404 70641	(9) 4. 7119 98736	(9) 4. 7843 50561	(9) 4. 8575 32416
5	(12) 1. 1881 37600	(12) 1. 2111 62837	(12) 1. 2345 43669	(12) 1. 2582 84198	(12) 1. 2823 88558
6	(14) 3. 0891 57760	(14) 3. 1611 35005	(14) 3. 2345 04412	(14) 3. 3092 87440	(14) 3. 3855 05793
7	(16) 8. 0318 10176	(16) 8. 2505 62364	(16) 8. 4744 01560	(16) 8. 7034 25966	(16) 8. 9377 35293
8	(19) 2. 0882 70646	(19) 2. 1533 96777	(19) 2. 2202 93209	(19) 2. 2890 01029	(19) 2. 3595 62117
9	(21) 5. 4295 03679	(21) 5. 6203 65588	(21) 5. 8171 68207	(21) 6. 0200 72706	(21) 6. 2292 43990
10	(24) 1. 4116 70957	(24) 1. 4669 15418	(24) 1. 5240 98070	(24) 1. 5832 79122	(24) 1. 6445 20413
24	(57) 9. 1066 85770	(57) 9. 9855 54265	(58) 1. 0945 38372	(58) 1. 1993 27974	(58) 1. 3136 94086
1/2	(1) 1. 6124 51550	(1) 1. 6155 49442	(1) 1. 6186 41406	(1) 1. 6217 27474	(1) 1. 6248 07681
1/3	6. 3825 04299	6. 3906 76528	6. 3988 27910	6. 4069 58577	6. 4150 88660
1/4	4. 0155 34273	4. 0193 89807	4. 0232 34278	4. 0270 67760	4. 0308 90325
1/5	3. 0408 47703	3. 0431 83226	3. 0455 11602	3. 0478 32879	3. 0501 47105
1	265	266	267	268	269
2	70225	70756	71289	71824	72361
3	186 09625	188 21096	190 34163	192 48832	194 65109
4	(9) 4. 9315 50625	(9) 5. 0064 11536	(9) 5. 0821 21521	(9) 5. 1586 86976	(9) 5. 2361 14321
5	(12) 1. 3068 60916	(12) 1. 3317 05469	(12) 1. 3569 26446	(12) 1. 3825 28110	(12) 1. 4085 14752
6	(14) 3. 4631 81426	(14) 3. 5423 36546	(14) 3. 6229 93611	(14) 3. 7051 75334	(14) 3. 7889 04684
7	(16) 9. 1774 30780	(16) 9. 4226 15213	(16) 9. 6733 92942	(16) 9. 9298 69894	(17) 1. 0192 15360
8	(19) 2. 4320 19157	(19) 2. 5064 15647	(19) 2. 5827 95915	(19) 2. 6612 05132	(19) 2. 7416 89318
9	(21) 6. 4448 50765	(21) 6. 6670 65620	(21) 6. 8960 65094	(21) 7. 1320 29753	(21) 7. 3751 44266
10	(24) 1. 7078 85453	(24) 1. 7734 39455	(24) 1. 8412 49380	(24) 1. 9113 83974	(24) 1. 9839 13808
24	(58) 1. 4384 70548	(58) 1. 5745 60235	(58) 1. 7229 40472	(58) 1. 8846 68868	(58) 2. 0608 89564
1/2	(1) 1. 6278 82060	(1) 1. 6309 50643	(1) 1. 6340 13464	(1) 1. 6370 70554	(1) 1. 6401 21947
1/3	6. 4231 58289	6. 4312 27591	6. 4392 76696	6. 4473 05727	6. 4553 14811
1/4	4. 0347 02045	4. 0385 02994	4. 0422 93240	4. 0460 72854	4. 0498 41906
1/5	3. 0524 54329	3. 0547 54599	3. 0570 47961	3. 0593 34462	3. 0616 14147
1	270	271	272	273	274
2	72900	73441	73984	74529	75076
3	196 83000	199 02511	201 23648	203 46417	205 70824
4	(9) 5. 3144 10000	(9) 5. 3935 80481	(9) 5. 4736 32256	(9) 5. 5545 71841	(9) 5. 6364 05776
5	(12) 1. 4348 90700	(12) 1. 4616 60310	(12) 1. 4888 27974	(12) 1. 5163 98113	(12) 1. 5443 75183
6	(14) 3. 8742 04890	(14) 3. 9610 99441	(14) 4. 0496 12088	(14) 4. 1397 66847	(14) 4. 2315 88000
7	(17) 1. 0460 35320	(17) 1. 0734 57949	(17) 1. 1014 94488	(17) 1. 1301 56349	(17) 1. 1594 55112
8	(19) 2. 8242 95365	(19) 2. 9090 71041	(19) 2. 9960 65007	(19) 3. 0853 26834	(19) 3. 1769 07007
9	(21) 7. 6255 97485	(21) 7. 8835 82520	(21) 8. 1492 96820	(21) 8. 4229 42256	(21) 8. 7047 25200
10	(24) 2. 0589 11321	(24) 2. 1364 50863	(24) 2. 2166 08735	(24) 2. 2994 63236	(24) 2. 3850 94705
24	(58) 2. 2528 39954	(58) 2. 4618 57897	(58) 2. 6893 89450	(58) 2. 9369 97176	(58) 3. 2063 69049
1/2	(1) 1. 6431 67673	(1) 1. 6462 07763	(1) 1. 6492 42250	(1) 1. 6522 71164	(1) 1. 6552 94536
1/3	6. 4693 04070	6. 4712 73627	6. 4792 23603	6. 4871 54117	6. 4950 65288
1/4	4. 0536 00464	4. 0573 48596	4. 0610 86370	4. 0648 13851	4. 0685 31106
1/5	3. 0638 87063	3. 0661 53254	3. 0684 12765	3. 0706 65640	3. 0729 11923
	$\frac{1}{n^2} \left[\begin{smallmatrix} (-6) 8 \\ 4 \end{smallmatrix} \right]$	$\frac{1}{n^3} \left[\begin{smallmatrix} (-6) 3 \\ 4 \end{smallmatrix} \right]$	$\frac{1}{n^4} \left[\begin{smallmatrix} (-6) 2 \\ 4 \end{smallmatrix} \right]$	$\frac{1}{n^5} \left[\begin{smallmatrix} (-6) 1 \\ 4 \end{smallmatrix} \right]$	

POWERS AND ROOTS n^k

Table 3.1

k					
1	275	276	277	278	279
2	75625	76176	76729	77284	77841
3	207 96875	210 24576	212 53933	214 84952	217 17639
4	(9) 5.7191 40625 (9) 5.8027 82976 (9) 5.8873 39441 (9) 5.9728 16656 (9) 6.0592 21281	(12) 1.5727 63672 (12) 1.6015 68101 (12) 1.6307 93025 (12) 1.6604 43030 (12) 1.6905 22737	(14) 4.3251 00098 (14) 4.4203 27960 (14) 4.5172 96680 (14) 4.6160 31624 (14) 4.7165 58437	(17) 1.1894 02527 (17) 1.2200 10517 (17) 1.2512 91180 (17) 1.2832 56792 (17) 1.3159 19804	(19) 3.2708 56949 (19) 3.3672 29027 (19) 3.4660 76569 (19) 3.5674 53881 (19) 3.6714 16253
5	(21) 8.9948 56609 (21) 9.2935 52114 (21) 9.6010 32097 (21) 9.9175 21788 (21) 1.0243 25135	(24) 2.4735 85568 (24) 2.5650 20383 (24) 2.6594 85891 (24) 2.7570 71057 (24) 2.8578 67126	(58) 3.4993 28001 (58) 3.8178 42160 (58) 4.1640 35828 (58) 4.5402 01230 (58) 4.9488 11121	(1) 1.6583 12395 (1) 1.6613 24773 (1) 1.6643 31698 (1) 1.6673 33200 (1) 1.6703 29309	6.5029 57234 6.5108 30071 6.5186 83915 6.5265 18879 6.5343 35077
1/2	4.0722 38199 3.0751 51657	4.0759 35196 3.0773 84885	4.0796 22161 3.0796 11650	4.0832 99156 3.0818 11992	4.0869 66245 3.0840 45954
1/3					
1/4					
1/5					
1	280	281	282	283	284
2	78400	78961	79524	80089	80656
3	219 52000	221 88041	224 25768	226 65187	229 06304
4	(9) 6.1465 60000 (9) 6.2348 39521 (9) 6.3240 66576 (9) 6.4142 47921 (9) 6.5053 90336	(12) 1.7210 36800 (12) 1.7519 89905 (12) 1.7833 86774 (12) 1.8152 32162 (12) 1.8475 30855	(14) 4.8189 03040 (14) 4.9230 91634 (14) 5.0291 50704 (14) 5.1371 07017 (14) 5.2469 87629	(17) 1.3492 92851 (17) 1.3833 88749 (17) 1.4182 20498 (17) 1.4538 01286 (17) 1.4901 44487	(19) 3.7780 19983 (19) 3.8873 23285 (19) 3.9993 81806 (19) 4.1142 57639 (19) 4.2320 10342
5	(22) 1.0578 45595 (22) 1.0923 37590 (22) 1.1278 25669 (22) 1.1643 34912 (22) 1.2018 90937	(24) 2.9619 67667 (24) 3.0694 68629 (24) 3.1804 68387 (24) 3.2950 67801 (24) 3.4133 70262	(58) 5.3925 32264 (58) 5.8742 39885 (58) 6.3970 33126 (58) 6.9642 51599 (58) 7.5794 93086	(1) 1.6733 20053 (1) 1.6763 05461 (1) 1.6792 85562 (1) 1.6822 60384 (1) 1.6852 29955	6.5421 32620 6.5499 11620 6.5576 72186 6.5654 14427 6.5731 38451
1/2	4.0906 23489 3.0862 53577	4.0942 70950 3.0884 54901	4.0979 08689 3.0906 49967	4.1015 36766 3.0928 38815	4.1051 55240 3.0950 21484
1/3					
1/4					
1/5					
1	285	286	287	288	289
2	81225	81796	82369	82944	83521
3	231 49125	233 93656	236 39903	238 87872	241 37569
4	(9) 6.5975 00625 (9) 6.6905 85616 (9) 6.7846 52161 (9) 6.8797 07136 (9) 6.9757 57441	(12) 1.8802 87678 (12) 1.9135 07486 (12) 1.9471 95170 (12) 1.9813 55655 (12) 2.0159 93900	(14) 5.3588 19883 (14) 5.4726 31410 (14) 5.5884 50138 (14) 5.7063 04287 (14) 5.8262 22372	(17) 1.5272 63667 (17) 1.5651 72583 (17) 1.6038 85190 (17) 1.6434 15635 (17) 1.6837 78266	(19) 4.3527 101450 (19) 4.4763 93589 (19) 4.6031 50495 (19) 4.7330 37028 (19) 4.8661 19188
5	(22) 1.2405 19913 (22) 1.2802 48566 (22) 1.3211 04192 (22) 1.3631 14664 (22) 1.4063 08445	(24) 3.5354 81753 (24) 3.6615 10900 (24) 3.7915 69031 (24) 3.9257 70232 (24) 4.0642 31407	(58) 8.2466 32480 (58) 8.9698 42039 (58) 9.7536 13040 (58) 1.0622 77893 (58) 1.1522 54005	(1) 1.6881 94302 (1) 1.6911 53453 (1) 1.6941 07435 (1) 1.6970 56275 (1) 1.7000 00000	6.5808 44365 6.5885 32275 6.5962 02284 6.6038 54498 6.6114 89018
1/2	4.1087 64171 3.0971 98013	4.1123 63618 3.0993 68441	4.1159 53637 3.1015 32807	4.1231 34288 3.1036 91148	4.1291 05626 3.1058 43502
1/3					
1/4					
1/5					
1	290	291	292	293	294
2	84100	84681	85264	85849	86436
3	243 89000	246 42171	248 97088	251 53757	254 12184
4	(9) 7.0728 10000 (9) 7.1708 71761 (9) 7.2699 49696 (9) 7.3700 50801 (9) 7.4711 82096	(12) 2.0511 14900 (12) 2.0867 23682 (12) 2.1228 25311 (12) 2.1594 24885 (12) 2.1965 27536	(14) 5.9482 33210 (14) 6.0723 65916 (14) 6.1986 49909 (14) 6.3271 14912 (14) 6.4577 90956	(17) 1.7249 87631 (17) 1.7670 58482 (17) 1.8100 05773 (17) 1.8538 44669 (17) 1.8985 90541	(19) 5.0024 64130 (19) 5.1421 40181 (19) 5.2852 16858 (19) 5.4317 64881 (19) 5.5818 56191
5	(22) 1.4507 14598 (22) 1.4963 62793 (22) 1.5432 83323 (22) 1.5915 07110 (22) 1.6418 65720	(24) 4.2070 72333 (24) 4.3544 15727 (24) 4.5063 87302 (24) 4.6631 15833 (24) 4.8247 33217	(59) 1.2518 49008 (59) 1.3596 64428 (59) 1.4763 46962 (59) 1.6025 91698 (59) 1.7391 45550	(1) 1.7029 38637 (1) 1.7058 72211 (1) 1.7088 00749 (1) 1.7117 24277 (1) 1.7146 42820	6.6191 05948 6.6267 05387 6.6342 87437 6.6418 52195 6.6493 99761
1/2	4.1266 67707 3.1079 89906	4.1302 20588 3.1101 30396	4.1337 64325 3.1122 65011	4.1372 98970 3.1143 93785	4.1408 24580 3.1165 16755
1/3					
1/4					
1/5					
1	295	296	297	298	299
2	87025	87616	88209	88804	89401
3	256 72375	259 34336	261 98073	264 63592	267 30899
4	(9) 7.5733 50625 (9) 7.6765 63456 (9) 7.7808 27681 (9) 7.8861 50416 (9) 7.9925 38801	(12) 2.2341 38434 (12) 2.2722 62783 (12) 2.3109 05821 (12) 2.3500 72824 (12) 2.3897 69101	(14) 6.5907 08381 (14) 6.7258 97838 (14) 6.8633 90289 (14) 7.0032 17015 (14) 7.1454 09613	(17) 1.9442 58973 (17) 1.9908 65760 (17) 2.0384 26916 (17) 2.0869 58671 (17) 2.1364 74774	(19) 5.7355 63969 (19) 5.8929 62649 (19) 6.0541 27940 (19) 6.2191 36838 (19) 6.3880 67649
5	(22) 1.6919 91371 (22) 1.7443 16944 (22) 1.7980 75998 (22) 1.8533 02278 (22) 1.9100 32227	(24) 4.9913 74544 (24) 5.1631 78155 (24) 5.3402 85715 (24) 5.5228 42278 (24) 5.7109 96358	(59) 2.0464 49657 (59) 2.2189 87131 (59) 2.4189 87131 (59) 2.6405 16789 (59) 2.9068 04847	(1) 1.7175 56404 (1) 1.7204 65053 (1) 1.7233 68794 (1) 1.7262 67650 (1) 1.7291 61647	6.6569 30232 6.6644 43703 6.6719 40272 6.6794 20032 6.6868 83077
1/2	4.1443 41207 3.1186 33956	4.1478 48904 3.1207 45423	4.1513 47726 3.1228 51191	4.1548 37723 3.1249 51295	4.1583 18947 3.1270 45768
1/3					
1/4					
1/5					

$$n^{\frac{1}{2}} \left[\begin{matrix} (-6) \\ 4 \end{matrix} \right]$$

$$n^{\frac{1}{3}} \left[\begin{matrix} (-6) \\ 4 \end{matrix} \right]$$

$$n^{\frac{1}{4}} \left[\begin{matrix} (-6) \\ 4 \end{matrix} \right]$$

$$n^{\frac{1}{5}} \left[\begin{matrix} (-7) \\ 4 \end{matrix} \right]$$

Table 3.1 POWERS AND ROOTS n^k

k					
1		300	301	302	303
2		90000	90601	91204	91809
3		270 00000	272 70901	275 43608	278 18127
4	(9) 8.1000 00000	(9) 8.2085 41201	(9) 8.3181 69616	(9) 8.4288 92481	(9) 8.5407 17056
5	(12) 2.4300 00000	(12) 2.4707 70902	(12) 2.5120 87224	(12) 2.5539 54422	(12) 2.5963 77985
6	(14) 7.2900 00000	(14) 7.4370 20414	(14) 7.5865 03417	(14) 7.7384 81898	(14) 7.8929 89074
7	(17) 2.1870 00000	(17) 2.2385 43144	(17) 2.2911 24032	(17) 2.3447 60015	(17) 2.3994 68679
8	(19) 6.5610 00000	(19) 6.7380 14865	(19) 6.9191 94576	(19) 7.1046 22846	(19) 7.2943 84783
9	(22) 1.9683 00000	(22) 2.0281 42474	(22) 2.0895 96762	(22) 2.1527 00722	(22) 2.2174 92974
10	(24) 5.9049 00000	(24) 6.1047 08848	(24) 6.3105 82221	(24) 6.5226 83188	(24) 6.7411 78641
24	(59) 2.8242 95365	(59) 3.0591 15639	(59) 3.3125 81949	(59) 3.5861 05682	(59) 3.8811 99856
1/2	(1) 1.7320 50808	(1) 1.7349 35157	(1) 1.7378 14720	(1) 1.7406 89519	(1) 1.7435 59577
1/3	6.6943 29501	6.7017 59395	6.7091 72852	6.7165 69962	6.7239 50814
1/4	4.1617 91450	4.1652 55283	4.1687 10496	4.1721 57138	4.1755 95260
1/5	3.1291 34645	3.1312 17958	3.1332 95743	3.1353 68030	3.1374 34853
1		305	306	307	308
2		93025	93636	94249	94864
3		283 72625	286 52616	289 34443	292 18112
4	(9) 8.6536 50625	(9) 8.7677 00496	(9) 8.8828 74001	(9) 8.9991 78496	(9) 9.1166 21361
5	(12) 2.6393 63441	(12) 2.6829 16352	(12) 2.7270 42318	(12) 2.7717 46977	(12) 2.8170 36001
6	(14) 8.0500 58494	(14) 8.2097 24036	(14) 8.3720 19917	(14) 8.5369 80688	(14) 8.7046 41242
7	(17) 2.4552 67841	(17) 2.5127 75555	(17) 2.5702 10115	(17) 2.6293 90052	(17) 2.6897 34144
8	(19) 7.4885 66914	(19) 7.6872 57199	(19) 7.8905 45052	(19) 8.0985 21360	(19) 8.3112 78504
9	(22) 2.2840 12909	(22) 2.3523 00703	(22) 2.4223 97331	(22) 2.4943 44579	(22) 2.5681 85058
10	(24) 6.9662 39372	(24) 7.1980 40151	(24) 7.4367 59806	(24) 7.6825 81303	(24) 7.9356 91828
24	(59) 4.1994 86063	(59) 4.5427 01868	(59) 4.9127 08679	(59) 5.3115 00125	(59) 5.7412 10972
1/2	(1) 1.7464 24920	(1) 1.7492 85568	(1) 1.7521 41547	(1) 1.7549 32877	(1) 1.7578 39583
1/3	6.7313 15497	6.7386 64101	6.7459 96712	6.7533 13417	6.7606 14302
1/4	4.1790 24910	4.1824 46136	4.1858 58988	4.1892 63512	4.1926 59756
1/5	3.1394 96244	3.1415 52236	3.1436 02859	3.1456 48146	3.1476 88127
1		310	311	312	313
2		96100	96721	97344	97969
3		297 91000	303 80231	303 71328	306 64297
4	(9) 9.2352 10000	(9) 9.3543 51841	(9) 9.4758 54336	(9) 9.5979 24961	(9) 9.7211 71216
5	(12) 2.8629 15100	(12) 2.9093 90023	(12) 2.9564 66553	(12) 3.0041 50513	(12) 3.0524 47762
6	(14) 8.8750 36810	(14) 9.0482 02970	(14) 9.2241 75645	(14) 9.4029 91105	(14) 9.5846 85972
7	(17) 2.7512 61411	(17) 2.8139 91124	(17) 2.8779 42801	(17) 2.9431 36216	(17) 3.0095 91395
8	(19) 8.5289 10374	(19) 8.7515 12395	(19) 8.9791 81540	(19) 9.2120 16356	(19) 9.4501 16981
9	(22) 2.6439 62216	(22) 2.7217 20355	(22) 2.8015 04640	(22) 2.8833 61119	(22) 2.9673 36732
10	(24) 8.1962 82870	(24) 8.4645 50303	(24) 8.7406 94478	(24) 9.0249 20304	(24) 9.3174 37339
24	(59) 6.2041 26610	(59) 6.7026 93132	(59) 7.2395 28072	(59) 7.8174 31800	(59) 8.4393 99655
1/2	(1) 1.7606 81686	(1) 1.7635 19209	(1) 1.7663 52173	(1) 1.7691 80601	(1) 1.7720 04515
1/3	6.7678 99452	6.7751 68952	6.7824 22886	6.7896 61336	6.7968 84386
1/4	4.1960 47767	4.1994 27591	4.2027 99273	4.2061 62861	4.2095 18398
1/5	3.1497 22833	3.1517 52295	3.1537 76544	3.1557 95609	3.1578 09519
1		315	316	317	318
2		99225	99856	1 00489	1 01124
3		312 55875	315 54496	318 55013	321 57432
4	(9) 9.8456 00625	(9) 9.9712 20736	(10) 1.0098 03912	(10) 1.0226 06338	(10) 1.0355 30112
5	(12) 3.1013 64197	(12) 3.1509 05753	(12) 3.2010 78401	(12) 3.2518 88154	(12) 3.3033 41058
6	(14) 9.7692 97220	(14) 9.9568 62178	(15) 1.0147 41853	(15) 1.0341 00433	(15) 1.0537 65797
7	(17) 3.0773 28624	(17) 3.1463 68448	(17) 3.2167 31675	(17) 3.2884 39376	(17) 3.3615 12894
8	(19) 9.6935 85167	(19) 9.9425 24297	(20) 1.0197 03941	(20) 1.0457 23722	(20) 1.0723 22613
9	(22) 3.0534 79328	(22) 3.1418 37678	(22) 3.2324 61493	(22) 3.3254 01435	(22) 3.4207 09136
10	(24) 9.6184 59882	(24) 9.9282 07062	(25) 1.0246 90293	(25) 1.0574 77656	(25) 1.0912 06214
24	(59) 9.1086 34822	(59) 9.8285 62028	(60) 1.0602 84208	(60) 1.1435 38734	(60) 1.2330 37808
1/2	(1) 1.7748 23935	(1) 1.7776 38883	(1) 1.7804 49381	(1) 1.7832 55450	(1) 1.7860 57110
1/3	6.8040 92116	6.8112 84608	6.8184 61941	6.8256 24197	6.8327 71452
1/4	4.2128 65931	4.2162 05502	4.2195 37156	4.2228 60938	4.2261 76889
1/5	3.1598 18306	3.1618 21997	3.1638 20622	3.1658 14209	3.1678 02787
1		320	321	322	323
2		1 02400	1 03041	1 03684	1 04329
3		327 68000	330 76161	333 86248	336 98267
4	(10) 1.0485 76000	(10) 1.0617 44768	(10) 1.0750 37186	(10) 1.0884 54024	(10) 1.1019 96058
5	(12) 3.3554 43200	(12) 3.4082 00706	(12) 3.4616 19738	(12) 3.5157 06498	(12) 3.5704 67227
6	(15) 1.0737 41824	(15) 1.0940 32426	(15) 1.1146 41556	(15) 1.1355 73199	(15) 1.1568 31381
7	(17) 3.4359 73837	(17) 3.5118 44089	(17) 3.5891 45809	(17) 3.6679 01432	(17) 3.7481 33676
8	(20) 1.0995 11628	(20) 1.1273 01953	(20) 1.1557 04950	(20) 1.1847 32163	(20) 1.2143 95311
9	(22) 3.5184 37209	(22) 3.6186 39268	(22) 3.7213 69940	(22) 3.8266 84885	(22) 3.9346 40808
10	(25) 1.1258 99907	(25) 1.1615 83205	(25) 1.1982 81121	(25) 1.2360 19218	(25) 1.2748 23622
24	(60) 1.3292 27996	(60) 1.4325 86248	(60) 1.5436 21862	(60) 1.6628 78568	(60) 1.7909 36736
1/2	(1) 1.7888 54382	(1) 1.7916 47287	(1) 1.7944 35844	(1) 1.7972 20076	(1) 1.8000 00000
1/3	6.8399 03787	6.8470 21278	6.8541 24002	6.8612 12036	6.8682 85455
1/4	4.2294 85054	4.2327 85474	4.2360 78192	4.2393 63249	4.2426 40687
1/5	3.1697 86385	3.1717 65030	3.1737 38749	3.1757 07571	3.1776 71523

$$n^2 \begin{bmatrix} (-6) 6 \\ 4 \end{bmatrix}$$

$$n^3 \begin{bmatrix} (-6) 2 \\ 4 \end{bmatrix}$$

$$n^4 \begin{bmatrix} (-6) 1 \\ 4 \end{bmatrix}$$

$$n^5 \begin{bmatrix} (-7) 7 \\ 4 \end{bmatrix}$$

POWERS AND ROOTS n^k

Table 3.1

k					
1		325	326	327	328
2		1 05625	1 06276	1 06929	1 07584
3		343 28125	346 45976	349 65783	352 87552
4	(10)	1.1156 64063	(10) 1.1294 58818	(10) 1.1433 81104	(10) 1.1574 31706
5	(12)	3.6259 08203	(12) 3.6820 35745	(12) 3.7388 56210	(12) 3.7963 75994
6	(15)	1.1784 20166	(15) 1.2003 43653	(15) 1.2226 05981	(15) 1.2452 11326
7	(17)	3.8298 65540	(17) 3.9131 20309	(17) 3.9979 21557	(17) 4.0842 93150
8	(20)	1.2447 06300	(20) 1.2756 77221	(20) 1.3073 20349	(20) 1.3396 48153
9	(22)	4.0452 95476	(22) 4.1587 07739	(22) 4.2749 37542	(22) 4.3940 45942
10	(25)	1.3147 21030	(25) 1.3557 38723	(25) 1.3979 04576	(25) 1.4412 47069
24	(60)	1.9284 15722	(60) 2.0759 76350	(60) 2.2343 23554	(60) 2.4042 09169
1/2	(1)	1.8027 75638	(1) 1.8055 47009	(1) 1.8083 14132	(1) 1.8110 77028
1/3		6.8753 44335	6.8823 88750	6.8894 18774	6.8964 34481
1/4		4.2459 10547	4.2491 72871	4.2524 27697	4.2556 75067
1/5		3.1796 30632	3.1815 84924	3.1835 34426	3.1854 79164
1		330	331	332	333
2		1 08900	1 09561	1 10224	1 10889
3		359 37000	362 64691	365 94368	369 26037
4	(10)	1.1859 21000	(10) 1.2003 61272	(10) 1.2149 33018	(10) 1.2296 37032
5	(12)	3.9135 39300	(12) 3.9731 95811	(12) 4.0335 77618	(12) 4.0946 91317
6	(15)	1.2914 67969	(15) 1.3151 27813	(15) 1.3391 47769	(15) 1.3635 32209
7	(17)	4.2618 44298	(17) 4.3530 73062	(17) 4.4459 70594	(17) 4.5405 62254
8	(20)	1.4064 08618	(20) 1.4408 67184	(20) 1.4760 62237	(20) 1.5120 07231
9	(22)	4.6411 48440	(22) 4.7692 70378	(22) 4.9005 26628	(22) 5.0349 84078
10	(25)	1.5315 78985	(25) 1.5786 28495	(25) 1.6269 74840	(25) 1.6766 49698
24	(60)	2.7818 55434	(60) 2.9913 81825	(60) 3.2159 84959	(60) 3.4566 99320
1/2	(1)	1.8165 90212	(1) 1.8193 40540	(1) 1.8220 86716	(1) 1.8248 28759
1/3		6.9104 23230	6.9173 96417	6.9243 55573	6.9313 00768
1/4		4.2621 47595	4.2653 72832	4.2685 90770	4.2718 01446
1/5		3.1893 54454	3.1912 85058	3.1932 11001	3.1951 32308
1		335	336	337	338
2		1 12225	1 12896	1 13569	1 14244
3		375 95375	379 33056	382 72753	386 14472
4	(10)	1.2594 45063	(10) 1.2745 50682	(10) 1.2897 91776	(10) 1.3051 69154
5	(12)	4.2191 40959	(12) 4.2824 90290	(12) 4.3465 98285	(12) 4.4114 71739
6	(15)	1.4134 12221	(15) 1.4389 16737	(15) 1.4648 03622	(15) 1.4910 77448
7	(17)	4.7349 30942	(17) 4.8347 60238	(17) 4.9363 88207	(17) 5.0398 41774
8	(20)	1.5862 01865	(20) 1.6244 79440	(20) 1.6635 62826	(20) 1.7034 66520
9	(22)	5.3137 76249	(22) 5.4582 50918	(22) 5.6062 06723	(22) 5.7577 16836
10	(25)	1.7801 15044	(25) 1.8339 72309	(25) 1.8892 91666	(25) 1.9461 08291
24	(60)	3.9909 41565	(60) 4.2868 93134	(60) 4.6038 12427	(60) 4.9431 16051
1/2	(1)	1.8303 00522	(1) 1.8330 30278	(1) 1.8357 55975	(1) 1.8384 77631
1/3		6.9451 49558	6.9520 53290	6.9589 43337	6.9658 19768
1/4		4.2782 01166	4.2813 90286	4.2845 72295	4.2877 47230
1/5		3.1989 61118	3.2008 68669	3.2027 71684	3.2046 70186
1		340	341	342	343
2		1 15600	1 16281	1 16964	1 17649
3		393 04000	396 51821	400 01688	403 53607
4	(10)	1.3363 36000	(10) 1.3521 27096	(10) 1.3680 57730	(10) 1.3841 28720
5	(12)	4.5435 42400	(12) 4.6107 53398	(12) 4.6787 57435	(12) 4.7475 61510
6	(15)	1.5448 04416	(15) 1.5722 66909	(15) 1.6001 35043	(15) 1.6284 13598
7	(17)	5.2523 35014	(17) 5.3614 30158	(17) 5.4724 61847	(17) 5.5854 58641
8	(20)	1.7857 93905	(20) 1.8282 47684	(20) 1.8715 81952	(20) 1.9158 12314
9	(22)	6.0716 99277	(22) 6.2343 24602	(22) 6.4008 10274	(22) 6.5712 36236
10	(25)	2.0643 77754	(25) 2.1259 04689	(25) 2.1890 77114	(25) 2.2539 34029
24	(60)	5.6950 03680	(60) 6.1108 98859	(60) 6.5558 12822	(60) 7.0316 76479
1/2	(1)	1.8439 08891	(1) 1.8466 18531	(1) 1.8493 24201	(1) 1.8520 25918
1/3		6.9795 32047	6.9863 68028	6.9931 90657	7.0000 00000
1/4		4.2940 76026	4.2972 29958	4.3003 76961	4.3035 17071
1/5		3.2084 53751	3.2103 38860	3.2122 19552	3.2140 95850
1		345	346	347	348
2		1 19025	1 19716	1 20409	1 21104
3		410 63625	414 21736	417 81923	421 44192
4	(10)	1.4166 95063	(10) 1.4331 92066	(10) 1.4498 32728	(10) 1.4666 17882
5	(12)	4.8875 97966	(12) 4.9588 44547	(12) 5.0309 19567	(12) 5.1038 30228
6	(15)	1.6862 21298	(15) 1.7157 60213	(15) 1.7457 29090	(15) 1.7761 32919
7	(17)	5.8174 63479	(17) 5.9365 30338	(17) 6.0576 79941	(17) 6.1809 42559
8	(20)	2.0070 24900	(20) 2.0540 39497	(20) 2.1020 14939	(20) 2.1509 68011
9	(22)	6.9242 35905	(22) 7.1069 76659	(22) 7.2939 91840	(22) 7.4853 68677
10	(25)	2.3888 61387	(25) 2.4590 13924	(25) 2.5310 15168	(25) 2.6049 08300
24	(60)	8.0845 95243	(60) 8.6661 53376	(60) 9.2876 83235	(60) 9.9518 04932
1/2	(1)	1.8574 17562	(1) 1.8601 07524	(1) 1.8627 93601	(1) 1.8654 75811
1/3		7.0135 79083	7.0203 48952	7.0271 05788	7.0338 49656
1/4		4.3097 76748	4.3128 96386	4.3160 09269	4.3191 15431
1/5		3.2178 35355	3.2196 98608	3.2215 57557	3.2234 12226
		$\frac{1}{n^2} \left[\binom{-6}{4} 5 \right]$	$\frac{1}{n^3} \left[\binom{-6}{4} 2 \right]$	$\frac{1}{n^4} \left[\binom{-6}{4} 1 \right]$	$\frac{1}{n^5} \left[\binom{-7}{4} 6 \right]$

Table 3.1

POWERS AND ROOTS n^k

k	350	351	352	353	354
1	1 22500	1 23201	1 23904	1 24609	1 25316
2	428 75000	432 43551	436 14208	439 86977	443 61864
3	(10) 1.5006 25000	(10) 1.5178 48640	(10) 1.5352 20122	(10) 1.5527 40288	(10) 1.5704 09986
4	(12) 5.2521 87500	(12) 5.3276 48727	(12) 5.4039 74828	(12) 5.4811 73217	(12) 5.5592 51349
5	(15) 1.8382 65625	(15) 1.8700 04703	(15) 1.9021 99139	(15) 1.9348 54146	(15) 1.9679 74978
6	(17) 6.4339 29688	(17) 6.5637 16508	(17) 6.6957 40971	(17) 6.8300 35134	(17) 6.9666 31421
7	(20) 2.2518 75391	(20) 2.3038 64494	(20) 2.3569 00822	(20) 2.4110 02402	(20) 2.4661 87523
8	(22) 7.8815 63867	(22) 8.0865 64375	(22) 8.2962 90893	(22) 8.5108 38480	(22) 8.7303 03831
9	(25) 2.7585 47354	(25) 2.8383 84096	(25) 2.9202 94394	(25) 3.0043 25983	(25) 3.0905 27556
10	(61) 1.1419 13124	(61) 1.2228 43263	(61) 1.3092 54042	(61) 1.4014 99442	(61) 1.4999 55202
1/2	(1) 1.8708 28693	(1) 1.8734 99400	(1) 1.8761 66304	(1) 1.8788 29423	(1) 1.8814 88772
1/3	7.0472 98732	7.0540 40463	7.0606 96671	7.0673 76615	7.0740 43955
1/4	4.3253 07727	4.3283 93928	4.3314 73541	4.3345 46600	4.3376 13137
1/5	3.2271 08809	3.2289 50768	3.2307 88532	3.2326 22125	3.2344 51567
1	355	356	357	358	359
2	1 26025	1 26736	1 27449	1 28164	1 28881
3	447 38875	451 18016	454 99293	458 82712	462 68279
4	(10) 1.5882 30063	(10) 1.6062 01370	(10) 1.6243 24760	(10) 1.6426 01900	(10) 1.6610 31216
5	(12) 5.6382 16722	(12) 5.7180 76876	(12) 5.7988 39394	(12) 5.8805 11901	(12) 5.9631 02066
6	(15) 2.0015 66936	(15) 2.0356 35368	(15) 2.0701 85663	(15) 2.1052 23260	(15) 2.1407 53642
7	(17) 7.1055 62624	(17) 7.2468 61909	(17) 7.3905 62819	(17) 7.5366 99273	(17) 7.6853 05573
8	(20) 2.5224 74731	(20) 2.5798 82840	(20) 2.6384 30926	(20) 2.6981 38340	(20) 2.7590 24701
9	(22) 8.9547 85297	(22) 9.1843 82909	(22) 9.4191 98407	(22) 9.6593 35256	(22) 9.9048 98676
10	(25) 3.1789 48780	(25) 3.2696 40316	(25) 3.3626 53831	(25) 3.4580 42022	(25) 3.5558 58625
24	(61) 1.6050 20092	(61) 1.7171 17251	(61) 1.8366 95605	(61) 1.9642 31355	(61) 2.1002 29556
1/2	(1) 1.8841 44368	(1) 1.8867 96226	(1) 1.8894 44363	(1) 1.8920 88793	(1) 1.8947 29532
1/3	7.0806 98751	7.0873 41061	7.0939 70945	7.1005 88459	7.1071 93661
1/4	4.3406 73183	4.3437 26771	4.3467 73933	4.3498 14700	4.3528 49104
1/5	3.2362 76880	3.2380 98084	3.2399 15199	3.2417 28247	3.2435 37249
1	360	361	362	363	364
2	1 29600	1 30321	1 31044	1 31769	1 32496
3	466 56000	470 45881	474 37928	478 32147	482 28544
4	(10) 1.6796 16000	(10) 1.6983 56304	(10) 1.7172 52994	(10) 1.7363 06936	(10) 1.7555 19002
5	(12) 6.0466 17600	(12) 6.1310 66258	(12) 6.2164 55837	(12) 6.3027 94178	(12) 6.3900 89166
6	(15) 2.1767 82336	(15) 2.2133 14919	(15) 2.2503 57013	(15) 2.2879 14287	(15) 2.3259 92456
7	(17) 7.8364 16410	(17) 7.9900 66858	(17) 8.1462 92387	(17) 8.3051 28860	(17) 8.4666 12541
8	(20) 2.8211 09907	(20) 2.8844 14136	(20) 2.9489 57844	(20) 3.0147 61776	(20) 3.0818 46965
9	(23) 1.0155 99567	(23) 1.0412 73503	(23) 1.0675 22740	(23) 1.0943 58525	(23) 1.1217 92295
10	(25) 3.6561 58440	(25) 3.7589 97346	(25) 3.8644 32317	(25) 3.9725 21445	(25) 4.0833 23955
24	(61) 2.2452 25771	(61) 2.3997 87825	(61) 2.5645 17652	(61) 2.7400 53237	(61) 2.9270 70667
1/2	(1) 1.8973 66596	(1) 1.9000 00000	(1) 1.9026 29759	(1) 1.9052 55888	(1) 1.9078 78403
1/3	7.1137 86609	7.1203 67359	7.1269 35967	7.1334 92490	7.1400 36982
1/4	4.3558 77175	4.3588 98944	4.3619 14441	4.3649 23697	4.3679 26743
1/5	3.2453 42223	3.2471 43191	3.2489 40172	3.2507 33187	3.2525 22254
1	365	366	367	368	369
2	1 33225	1 33956	1 34689	1 35424	1 36161
3	486 27125	490 27896	494 30863	498 36032	502 43409
4	(10) 1.7748 90063	(10) 1.7944 20994	(10) 1.8141 12672	(10) 1.8339 65978	(10) 1.8539 81792
5	(12) 6.4783 48728	(12) 6.5675 80837	(12) 6.6577 93507	(12) 6.7489 94798	(12) 6.8411 92813
6	(15) 2.3645 97286	(15) 2.4037 34586	(15) 2.4434 10217	(15) 2.4836 30086	(15) 2.5244 00148
7	(17) 8.6307 80093	(17) 8.7976 68585	(17) 8.9673 15496	(17) 9.1397 58715	(17) 9.3150 36546
8	(20) 3.1502 34734	(20) 3.2199 46702	(20) 3.2910 04787	(20) 3.3634 31207	(20) 3.4372 48485
9	(23) 1.1498 35678	(23) 1.1785 00493	(23) 1.2077 98757	(23) 1.2377 42684	(23) 1.2683 44691
10	(25) 4.1969 00224	(25) 4.3133 11804	(25) 4.4326 21438	(25) 4.5548 93078	(25) 4.6801 91910
24	(61) 3.1262 86296	(61) 3.3384 59019	(61) 3.5643 92671	(61) 3.8049 38558	(61) 4.0609 98114
1/2	(1) 1.9104 97317	(1) 1.9131 12647	(1) 1.9157 24406	(1) 1.9183 32609	(1) 1.9209 37271
1/3	7.1465 69499	7.1530 90095	7.1595 98825	7.1660 95742	7.1725 80900
1/4	4.3709 23607	4.3739 14319	4.3768 98909	4.3798 77406	4.3828 49839
1/5	3.2543 07394	3.2560 88625	3.2578 65967	3.2596 39439	3.2614 09059
1	370	371	372	373	374
2	1 36900	1 37641	1 38384	1 39129	1 39876
3	506 53000	510 64811	514 78848	518 95117	523 13624
4	(10) 1.8741 61000	(10) 1.8945 04488	(10) 1.9150 13146	(10) 1.9356 87864	(10) 1.9565 29538
5	(12) 6.9343 95700	(12) 7.0286 11651	(12) 7.1238 48902	(12) 7.2201 15733	(12) 7.3174 20471
6	(15) 2.5657 26409	(15) 2.6076 14922	(15) 2.6500 71791	(15) 2.6931 03168	(15) 2.7367 15256
7	(17) 9.4931 87713	(17) 9.6742 51362	(17) 9.8582 67064	(17) 10.0455 27482	(17) 10.2355 31506
8	(20) 3.5124 79454	(20) 3.5891 47255	(20) 3.6672 75348	(20) 3.7468 87507	(20) 3.8280 07832
9	(23) 1.2996 17398	(23) 1.3315 73632	(23) 1.3642 26429	(23) 1.3975 89040	(23) 1.4316 74929
10	(25) 4.8085 84372	(25) 4.9401 38174	(25) 5.0749 22317	(25) 5.2130 07120	(25) 5.3544 64234
24	(61) 4.3335 25711	(61) 4.6235 31606	(61) 4.9320 85051	(61) 5.2603 17567	(61) 5.6094 26383
1/2	(1) 1.9235 38406	(1) 1.9261 36028	(1) 1.9287 30152	(1) 1.9313 20792	(1) 1.9339 07961
1/3	7.1790 54352	7.1855 16151	7.1919 66348	7.1984 04996	7.2048 32147
1/4	4.3858 16237	4.3887 76627	4.3917 31039	4.3946 79501	4.3976 22040
1/5	3.2631 74848	3.2649 36822	3.2666 95001	3.2684 49404	3.2702 00047

$$n^2 \left[\begin{matrix} (-6) 5 \\ 4 \end{matrix} \right] \quad n^3 \left[\begin{matrix} (-6) 2 \\ 4 \end{matrix} \right] \quad n^4 \left[\begin{matrix} (-7) 8 \\ 4 \end{matrix} \right] \quad n^5 \left[\begin{matrix} (-7) 5 \\ 4 \end{matrix} \right]$$

POWERS AND ROOTS n^k

Table 3.1

k					
1		375	376	377	378
2		1 40625	1 41376	1 42129	1 42884
3		527 34375	531 57376	535 82633	540 10152
4	(10)	1.9775 39063	(10)1.9987 17338	(10)2.0200 65264	(10)2.0415 83746
5	(12)	7.4157 71484	(12)7.5151 77189	(12)7.6156 46046	(12)7.7171 86558
6	(15)	2.7809 14307	(15)2.8257 06623	(15)2.8710 98559	(15)2.9170 96519
7	(18)	1.0428 42865	(18)1.0624 65690	(18)1.0824 04157	(18)1.1026 62484
8	(20)	3.9106 60744	(20)3.9948 70996	(20)4.0806 63671	(20)4.1680 64190
9	(23)	1.4664 97779	(23)1.5020 71494	(23)1.5384 10204	(23)1.5755 28264
10	(25)	5.4993 66671	(25)5.6477 88819	(25)5.7998 06469	(25)5.9554 96838
24	(61)	5.9806 78067	(61)6.3754 12334	(61)6.7950 46060	(61)7.2410 77507
1/2	(1)	1.9364 91673	(1)1.9390 71943	(1)1.9416 48784	(1)1.9442 22210
1/3		7.2112 47852	7.2176 52160	7.2240 45124	7.2304 26792
1/4		4.4005 58684	4.4034 89461	4.4064 14397	4.4093 33520
1/5		3.2719 46950	3.2736 90130	3.2754 29605	3.2771 65392
1		380	381	382	383
2		1 44400	1 45161	1 45924	1 46689
3		548 72000	553 06341	557 42968	561 81887
4	(10)	2.0851 36000	(10)2.1071 71592	(10)2.1293 81378	(10)2.1517 66272
5	(12)	7.9235 16800	(12)8.0283 23766	(12)8.1342 36862	(12)8.2412 64822
6	(15)	3.0109 36384	(15)3.0587 91355	(15)3.1072 78481	(15)3.1564 04427
7	(18)	1.1441 55826	(18)1.1653 99506	(18)1.1869 80380	(18)1.2089 02895
8	(20)	4.3477 92158	(20)4.4401 72119	(20)4.5342 65051	(20)4.6300 98090
9	(23)	1.6521 61013	(23)1.6917 05577	(23)1.7320 89250	(23)1.7733 27568
10	(25)	6.2782 11848	(25)6.4453 98249	(25)6.6165 80933	(25)6.7918 44587
24	(61)	8.2187 60383	(61)8.7538 56362	(61)9.3222 49236	(61)9.9259 15535
1/2	(1)	1.9493 58869	(1)1.9519 22130	(1)1.9544 82029	(1)1.9570 38579
1/3		7.2431 56443	7.2495 04524	7.2558 41507	7.2621 67440
1/4		4.4151 54436	4.4180 56280	4.4209 52418	4.4238 42876
1/5		3.2806 25976	3.2823 50807	3.2840 72019	3.2857 89631
1		385	386	387	388
2		1 48225	1 48996	1 49769	1 50544
3		570 66625	575 12456	579 60603	584 11072
4	(10)	2.1970 65063	(10)2.2199 80802	(10)2.2430 75336	(10)2.2663 49594
5	(12)	8.4587 00491	(12)8.5691 25894	(12)8.6807 01551	(12)8.7934 36423
6	(15)	3.2565 99689	(15)3.3076 82595	(15)3.3594 31500	(15)3.4118 53332
7	(18)	1.2537 90880	(18)1.2767 65482	(18)1.3000 99991	(18)1.3237 99093
8	(20)	4.8270 94889	(20)4.9283 14759	(20)5.0313 86963	(20)5.1363 40480
9	(23)	1.8584 31532	(23)1.9023 29497	(23)1.9471 46755	(23)1.9929 00106
10	(25)	7.1549 61399	(25)7.3429 91859	(25)7.5354 57941	(25)7.7324 52413
24	(62)	1.1247 53901	(62)1.1970 03202	(62)1.2736 88303	(62)1.3550 69013
1/2	(1)	1.9621 41687	(1)1.9646 88270	(1)1.9672 31557	(1)1.9697 71560
1/3		7.2747 86349	7.2810 79420	7.2873 61631	7.2936 33030
1/4		4.4296 06853	4.4324 80423	4.4353 48416	4.4382 10856
1/5		3.2892 14120	3.2909 21030	3.2926 24406	3.2943 24265
1		390	391	392	393
2		1 52100	1 52881	1 53664	1 54449
3		593 19000	597 76471	602 36288	606 98457
4	(10)	2.3134 41000	(10)2.3372 60016	(10)2.3612 62490	(10)2.3854 49360
5	(12)	9.0224 19900	(12)9.1386 86663	(12)9.2561 48959	(12)9.3748 15985
6	(15)	3.5187 43761	(15)3.5732 26485	(15)3.6284 10392	(15)3.6843 02682
7	(18)	1.3723 10267	(18)1.3971 31556	(18)1.4223 36874	(18)1.4479 30954
8	(20)	5.3520 09260	(20)5.4627 84383	(20)5.5755 60545	(20)5.6903 68650
9	(23)	2.0872 83612	(23)2.1359 48694	(23)2.1856 19734	(23)2.2363 14879
10	(25)	8.1404 06085	(25)8.3515 59392	(25)8.5676 29356	(25)8.7887 17476
24	(62)	1.5330 29700	(62)1.6302 04837	(62)1.7332 67559	(62)1.8425 58176
1/2	(1)	1.9748 41766	(1)1.9773 71993	(1)1.9798 98987	(1)1.9824 22760
1/3		7.3061 43574	7.3123 82812	7.3186 11420	7.3248 29445
1/4		4.4439 19178	4.4467 65109	4.4496 05586	4.4524 40634
1/5		3.2977 13494	3.2994 02898	3.3010 88848	3.3027 71361
1		395	396	397	398
2		1 56025	1 56816	1 57609	1 58404
3		616 29875	620 99136	625 70773	630 44792
4	(10)	2.4343 80063	(10)2.4591 25786	(10)2.4840 59688	(10)2.5091 82722
5	(12)	9.6158 01247	(12)9.7381 38111	(12)9.8617 16962	(12)9.9865 47232
6	(15)	3.7982 41493	(15)3.8563 02692	(15)3.9151 01634	(15)3.9746 45798
7	(18)	1.5003 05390	(18)1.5270 95866	(18)1.5542 95349	(18)1.5819 90208
8	(20)	5.9262 06289	(20)6.0472 99629	(20)6.1705 52534	(20)6.2959 97930
9	(23)	2.3408 51484	(23)2.3947 30653	(23)2.4497 09356	(23)2.5058 07176
10	(25)	9.2463 63362	(25)9.4831 33387	(25)9.7253 46143	(25)9.9731 12562
24	(62)	2.0812 78965	(62)2.2114 87364	(62)2.3494 82217	(62)2.4957 07762
1/2	(1)	1.9874 60691	(1)1.9899 74874	(1)1.9924 85885	(1)1.9949 93734
1/3		7.3372 33921	7.3434 20462	7.3495 96597	7.3557 62368
1/4		4.4580 94538	4.4609 13443	4.4637 27013	4.4665 35273
1/5		3.3061 26138	3.3077 98433	3.3094 67354	3.3111 32914

$$n^2 \binom{-6}{4} \quad n^3 \binom{-6}{4} \quad n^4 \binom{-7}{4} \quad n^5 \binom{-7}{4}$$

Table 3.1 POWERS AND ROOTS n^k

k	400	401	402	403	404
1	400	401	402	403	404
2	1 60000	1 60801	1 61604	1 62409	1 63216
3	640 00000	644 81201	649 64808	654 50827	659 39264
4	(10) 2.5600 00000	(10) 2.5856 96160	(10) 2.6115 85282	(10) 2.6376 68328	(10) 2.6639 46266
5	(13) 1.0240 00000	(13) 1.0368 64160	(13) 1.0498 57283	(13) 1.0629 80336	(13) 1.0762 34291
6	(15) 4.0960 00000	(15) 4.1578 25282	(15) 4.2204 26278	(15) 4.2838 10755	(15) 4.3479 86537
7	(18) 1.6384 00000	(18) 1.6672 87938	(18) 1.6965 11364	(18) 1.7263 75734	(18) 1.7565 86561
8	(20) 6.5536 00000	(20) 6.6858 24632	(20) 6.8203 77683	(20) 6.9572 94209	(20) 7.0966 09706
9	(23) 2.6214 40000	(23) 2.6810 15678	(23) 2.7417 91829	(23) 2.8037 89566	(23) 2.8670 30321
10	(26) 1.0485 76000	(26) 1.0750 87287	(26) 1.1022 00315	(26) 1.1299 27195	(26) 1.1582 80250
24	(62) 2.8147 49767	(62) 2.9885 80393	(62) 3.1728 72718	(62) 3.3676 04703	(62) 3.5739 85306
1/2	(1) 2.0000 00000	(1) 2.0024 98439	(1) 2.0049 93766	(1) 2.0074 85990	(1) 2.0099 75124
1/3	7.3680 62997	7.3741 97940	7.3803 22692	7.3864 37295	7.3925 41792
1/4	4.4721 35955	4.4749 28423	4.4777 15674	4.4804 97729	4.4832 74611
1/5	3.3144 54017	3.3161 09590	3.3177 61862	3.3194 10850	3.3210 56568
1	405	406	407	408	409
2	1 64025	1 64836	1 65649	1 66464	1 67281
3	664 30125	669 23416	674 19143	679 17312	684 17929
4	(10) 2.6904 20063	(10) 2.7170 90690	(10) 2.7439 59120	(10) 2.7710 26330	(10) 2.7982 93296
5	(13) 1.0896 20125	(13) 1.1031 38820	(13) 1.1167 91362	(13) 1.1305 78742	(13) 1.1445 01958
6	(15) 4.4129 61508	(15) 4.4787 43609	(15) 4.5453 40843	(15) 4.6127 61269	(15) 4.6810 13009
7	(18) 1.7872 49411	(18) 1.8183 69905	(18) 1.8499 53723	(18) 1.8820 06598	(18) 1.9145 34321
8	(20) 7.2383 60113	(20) 7.3825 81816	(20) 7.5293 11653	(20) 7.6785 86919	(20) 7.8304 45371
9	(23) 2.9315 35846	(23) 2.9973 28217	(23) 3.0644 29843	(23) 3.1328 63463	(23) 3.2026 52157
10	(26) 1.1872 72017	(26) 1.2169 15256	(26) 1.2472 22946	(26) 1.2782 08293	(26) 1.3098 84732
24	(62) 3.7924 56055	(62) 4.0236 92707	(62) 4.2684 06980	(62) 4.5273 48373	(62) 4.8013 06073
1/2	(1) 2.0124 61180	(1) 2.0149 44168	(1) 2.0174 24100	(1) 2.0199 00988	(1) 2.0223 74842
1/3	7.3986 36223	7.4047 20630	7.4107 95055	7.4168 59539	7.4229 14120
1/4	4.4860 46344	4.4888 12948	4.4915 74446	4.4943 30860	4.4970 82211
1/5	3.3226 99030	3.3243 38251	3.3259 74245	3.3276 07026	3.3292 36609
1	410	411	412	413	414
2	1 68100	1 68921	1 69744	1 70569	1 71396
3	689 21000	694 26531	699 34528	704 44997	709 57944
4	(10) 2.8257 61000	(10) 2.8534 30424	(10) 2.8813 02554	(10) 2.9093 78376	(10) 2.9376 58882
5	(13) 1.1585 62010	(13) 1.1727 59904	(13) 1.1870 96652	(13) 1.2015 73269	(13) 1.2161 90777
6	(15) 4.7501 04241	(15) 4.8200 43207	(15) 4.8908 38207	(15) 4.9624 97602	(15) 5.0350 29817
7	(18) 1.9475 42739	(18) 1.9810 37758	(18) 2.0150 25341	(18) 2.0495 11510	(18) 2.0845 02344
8	(20) 7.9849 25229	(20) 8.1420 65185	(20) 8.3019 04405	(20) 8.4644 82535	(20) 8.6298 39705
9	(23) 3.2738 19344	(23) 3.3463 88791	(23) 3.4203 84615	(23) 3.4958 31287	(23) 3.5727 53638
10	(26) 1.3422 65931	(26) 1.3753 65793	(26) 1.4091 98461	(26) 1.4437 78322	(26) 1.4791 20006
24	(62) 5.0911 10945	(62) 5.3976 37632	(62) 5.7218 06738	(62) 6.0645 87127	(62) 6.4269 98328
1/2	(1) 2.0248 45673	(1) 2.0273 13493	(1) 2.0297 78313	(1) 2.0322 40143	(1) 2.0346 98995
1/3	7.4289 58841	7.4349 93742	7.4410 18861	7.4470 34238	7.4530 39914
1/4	4.4998 28522	4.5025 69814	4.5053 06108	4.5080 37426	4.5107 63788
1/5	3.3308 63008	3.3324 86236	3.3341 06308	3.3357 23237	3.3373 37037
1	415	416	417	418	419
2	1 72225	1 73056	1 73889	1 74724	1 75561
3	714 73375	719 91296	725 11713	730 34632	735 60059
4	(10) 2.9661 45063	(10) 2.9948 37914	(10) 3.0237 38432	(10) 3.0528 47618	(10) 3.0821 66472
5	(13) 1.2309 50201	(13) 1.2458 52572	(13) 1.2608 98926	(13) 1.2760 90304	(13) 1.2914 27752
6	(15) 5.1084 43334	(15) 5.1827 46700	(15) 5.2579 48522	(15) 5.3340 57471	(15) 5.4110 82280
7	(18) 2.1200 03984	(18) 2.1560 22627	(18) 2.1925 64534	(18) 2.2296 36023	(18) 2.2672 43475
8	(20) 8.7980 16532	(20) 8.9690 54129	(20) 9.1429 94106	(20) 9.3198 78576	(20) 9.4997 50162
9	(23) 3.6511 76861	(23) 3.7311 26518	(23) 3.8126 28542	(23) 3.8957 09245	(23) 3.9803 95318
10	(26) 1.5152 38397	(26) 1.5521 48631	(26) 1.5898 66102	(26) 1.6284 06464	(26) 1.6677 85638
24	(62) 6.8101 13045	(62) 7.2150 59801	(62) 7.6430 25690	(62) 8.0952 59269	(62) 8.5730 73581
1/2	(1) 2.0371 54879	(1) 2.0396 07805	(1) 2.0420 57786	(1) 2.0445 04830	(1) 2.0469 48949
1/3	7.4590 35926	7.4650 22314	7.4709 99115	7.4769 66370	7.4829 24114
1/4	4.5134 85215	4.5162 01729	4.5189 13349	4.5216 20097	4.5243 21992
1/5	3.3389 47722	3.3405 55305	3.3421 59799	3.3437 61218	3.3453 59575
1	420	421	422	423	424
2	1 76400	1 77241	1 78084	1 78929	1 79776
3	740 88000	746 18461	751 51448	756 86967	762 25024
4	(10) 3.1116 96000	(10) 3.1414 37208	(10) 3.1713 91106	(10) 3.2015 58704	(10) 3.2319 41018
5	(13) 1.3069 12320	(13) 1.3225 45065	(13) 1.3383 27047	(13) 1.3542 59332	(13) 1.3703 42991
6	(15) 5.4890 31744	(15) 5.5679 14722	(15) 5.6477 40136	(15) 5.7285 16974	(15) 5.8102 54284
7	(18) 2.3053 93332	(18) 2.3440 92098	(18) 2.3833 46338	(18) 2.4231 62680	(18) 2.4635 47816
8	(20) 9.6826 51996	(20) 9.8686 27732	(20) 10.0557 72154	(20) 10.2449 97814	(20) 10.4357 44274
9	(23) 4.0667 13838	(23) 4.1546 92275	(23) 4.2443 58492	(23) 4.3357 40751	(23) 4.4288 67722
10	(26) 1.7080 19812	(26) 1.7491 25448	(26) 1.7911 19284	(26) 1.8340 18338	(26) 1.8778 39914
24	(62) 9.0778 49315	(62) 9.6110 38126	(63) 1.0174 16609	(63) 1.0768 83734	(63) 1.1396 73784
1/2	(1) 2.0493 90153	(1) 2.0518 28453	(1) 2.0542 63858	(1) 2.0566 96380	(1) 2.0591 26028
1/3	7.4888 72387	7.4948 11226	7.5007 40668	7.5066 60749	7.5125 71508
1/4	4.5270 19056	4.5297 11307	4.5323 98767	4.5350 81455	4.5377 59390
1/5	3.3469 54883	3.3485 47155	3.3501 36405	3.3517 22644	3.3533 05887

$$n^2 \sqrt[4]{(-6)4} \quad n^3 \sqrt[4]{(-6)1} \quad n^4 \sqrt[4]{(-7)7} \quad n^5 \sqrt[4]{(-7)4}$$

POWERS AND ROOTS n^k

Table 3.1

k					
1	425	426	427	428	429
2	1 80625	1 81476	1 82329	1 83184	1 84041
3	767 65625	773 08776	778 54483	784 02752	789 53589
4	(10) 3.2625 39063	(10) 3.2933 53858	(10) 3.3243 86424	(10) 3.3556 37786	(10) 3.3871 08968
5	(13) 1.3865 79102	(13) 1.4029 68743	(13) 1.4195 13003	(13) 1.4362 12972	(13) 1.4530 69747
6	(15) 5.8929 61182	(15) 5.9766 46847	(15) 6.0613 20523	(15) 6.1469 91521	(15) 6.2336 69216
7	(18) 2.5045 08502	(18) 2.5460 51557	(18) 2.5881 83863	(18) 2.6309 12371	(18) 2.6742 44094
8	(21) 1.0644 16113	(21) 1.0846 17963	(21) 1.1051 54510	(21) 1.1260 30495	(21) 1.1472 50716
9	(23) 4.5237 68482	(23) 4.6204 72523	(23) 4.7190 09756	(23) 4.8194 10518	(23) 4.9217 05572
10	(26) 1.9226 01605	(26) 1.9683 21295	(26) 2.0150 17166	(26) 2.0627 07702	(26) 2.1114 11691
24	(63) 1.2059 63938	(63) 1.2759 40370	(63) 1.3497 98685	(63) 1.4277 44370	(63) 1.5099 93273
1/2	(1) 2.0615 52813	(1) 2.0639 76744	(1) 2.0663 97832	(1) 2.0688 16087	(1) 2.0712 31518
1/3	7.5184 72981	7.5243 65204	7.5302 48212	7.5361 22043	7.5419 86732
1/4	4.5404 32593	4.5431 01082	4.5457 64877	4.5484 23998	4.5510 78463
1/5	3.3548 86145	3.3564 63431	3.3580 37758	3.3596 09138	3.3611 77583
1	430	431	432	433	434
2	1 84900	1 85761	1 86624	1 87489	1 88356
3	795 07000	800 62991	806 21568	811 82737	817 46504
4	(10) 3.4188 01000	(10) 3.4507 14912	(10) 3.4828 51738	(10) 3.5152 12512	(10) 3.5477 98274
5	(13) 1.4700 84430	(13) 1.4872 58127	(13) 1.5045 91951	(13) 1.5220 87018	(13) 1.5397 44451
6	(15) 6.3213 63049	(15) 6.4100 82528	(15) 6.4998 37227	(15) 6.5906 36787	(15) 6.6824 90916
7	(18) 2.7181 86111	(18) 2.7627 45570	(18) 2.8079 29682	(18) 2.8537 45729	(18) 2.9002 01058
8	(21) 1.1688 20028	(21) 1.1907 43340	(21) 1.2130 25623	(21) 1.2356 71901	(21) 1.2586 87259
9	(23) 5.0259 26119	(23) 5.1321 03797	(23) 5.2402 70690	(23) 5.3504 59329	(23) 5.4627 02704
10	(26) 2.1611 48231	(26) 2.2119 36737	(26) 2.2637 96938	(26) 2.3167 48890	(26) 2.3708 12974
24	(63) 1.5967 72093	(63) 1.6883 18906	(63) 1.7848 83700	(63) 1.8867 28946	(63) 1.9941 30189
1/2	(1) 2.0736 44135	(1) 2.0760 53949	(1) 2.0784 60969	(1) 2.0808 65205	(1) 2.0832 66666
1/3	7.5478 42314	7.5536 88825	7.5595 26299	7.5653 54772	7.5711 74278
1/4	4.5537 28292	4.5563 73502	4.5590 14114	4.5616 50145	4.5642 81614
1/5	3.3627 43107	3.3643 05720	3.3658 65436	3.3674 22267	3.3689 76223
1	435	436	437	438	439
2	1 89225	1 90096	1 90969	1 91844	1 92721
3	823 12875	828 81856	834 53453	840 27672	846 04519
4	(10) 3.5806 10063	(10) 3.6136 48922	(10) 3.6469 15896	(10) 3.6804 12034	(10) 3.7141 38384
5	(13) 1.5575 65377	(13) 1.5755 50930	(13) 1.5937 02247	(13) 1.6120 20471	(13) 1.6305 06751
6	(15) 6.7754 09391	(15) 6.8694 02054	(15) 6.9644 78818	(15) 7.0606 49662	(15) 7.1579 24635
7	(18) 2.9473 03085	(18) 2.9950 59296	(18) 3.0434 77243	(18) 3.0925 64552	(18) 3.1423 28915
8	(21) 1.2820 76842	(21) 1.3058 45853	(21) 1.3299 99555	(21) 1.3545 43274	(21) 1.3794 82394
9	(23) 5.5770 34263	(23) 5.6934 87918	(23) 5.8120 98057	(23) 5.9328 99539	(23) 6.0559 27708
10	(26) 2.4260 09904	(26) 2.4823 60732	(26) 2.5398 86851	(26) 2.5986 09998	(26) 2.6585 52264
24	(63) 2.1073 76666	(63) 2.2267 71952	(63) 2.3526 34640	(63) 2.4852 99040	(63) 2.6251 15920
1/2	(1) 2.0856 65361	(1) 2.0880 61302	(1) 2.0904 54496	(1) 2.0928 44954	(1) 2.0952 32684
1/3	7.5769 84852	7.5827 86527	7.5885 79338	7.5943 63318	7.6001 38502
1/4	4.5669 08540	4.5695 30941	4.5721 48834	4.5747 62238	4.5773 71171
1/5	3.3705 37218	3.3720 75562	3.3736 20969	3.3751 63549	3.3767 03314
1	440	441	442	443	444
2	1 93600	1 94481	1 95364	1 96249	1 97136
3	851 84000	857 66121	863 50888	869 38307	875 28384
4	(10) 3.7480 96000	(10) 3.7822 85936	(10) 3.8167 09250	(10) 3.8513 67000	(10) 3.8862 60250
5	(13) 1.6491 62240	(13) 1.6679 88098	(13) 1.6869 85488	(13) 1.7061 55581	(13) 1.7254 99551
6	(15) 7.2563 13856	(15) 7.3558 27511	(15) 7.4564 75858	(15) 7.5582 69224	(15) 7.6612 18006
7	(18) 3.1927 78097	(18) 3.2439 19933	(18) 3.2957 62329	(18) 3.3483 13266	(18) 3.4015 80795
8	(21) 1.4048 22363	(21) 1.4305 68690	(21) 1.4567 26950	(21) 1.4833 02777	(21) 1.5103 01873
9	(23) 6.1812 18395	(23) 6.3088 07924	(23) 6.4387 33117	(23) 6.5710 31302	(23) 6.7057 40315
10	(26) 2.7197 36094	(26) 2.7821 84294	(26) 2.8459 20038	(26) 2.9109 66867	(26) 2.9773 48700
24	(63) 2.7724 53276	(63) 2.9276 97132	(63) 3.0912 52385	(63) 3.2635 43677	(63) 3.4450 16313
1/2	(1) 2.0976 17696	(1) 2.1000 00000	(1) 2.1023 79604	(1) 2.1047 56518	(1) 2.1071 30751
1/3	7.6059 04922	7.6116 62611	7.6174 11603	7.6231 51930	7.6288 83626
1/4	4.5799 75651	4.5825 75695	4.5851 71321	4.5877 62546	4.5903 49388
1/5	3.3782 40276	3.3797 74445	3.3813 05834	3.3828 34454	3.3843 60316
1	445	446	447	448	449
2	1 98025	1 98916	1 99809	2 00704	2 01601
3	881 21125	887 16536	893 14623	899 15392	905 18849
4	(10) 3.9213 90063	(10) 3.9567 57506	(10) 3.9923 63648	(10) 4.0282 09562	(10) 4.0642 96320
5	(13) 1.7450 18578	(13) 1.7647 13847	(13) 1.7845 86551	(13) 1.8046 37884	(13) 1.8248 69048
6	(15) 7.7653 32671	(15) 7.8706 23760	(15) 7.9771 01882	(15) 8.0847 77119	(15) 8.1936 62024
7	(18) 3.4555 73039	(18) 3.5102 98197	(18) 3.5657 64541	(18) 3.6219 80418	(18) 3.6789 54249
8	(21) 1.5377 30002	(21) 1.5655 92996	(21) 1.5938 96750	(21) 1.6226 47227	(21) 1.6518 50458
9	(23) 6.8428 98510	(23) 6.9825 44761	(23) 7.1247 18472	(23) 7.2694 59578	(23) 7.4168 08555
10	(26) 3.0450 89837	(26) 3.1142 14964	(26) 3.1847 49157	(26) 3.2567 17891	(26) 3.3301 47041
24	(63) 3.6361 37215	(63) 3.8373 95917	(63) 4.0493 05610	(63) 4.2724 04226	(63) 4.5072 55570
1/2	(1) 2.1095 02311	(1) 2.1118 71208	(1) 2.1142 37451	(1) 2.1166 01049	(1) 2.1189 62010
1/3	7.6346 06721	7.6403 21250	7.6460 27242	7.6517 24731	7.6574 13748
1/4	4.5929 81864	4.5955 09991	4.5980 83787	4.6006 53268	4.6032 18450
1/5	3.3858 38431	3.3874 03811	3.3889 21465	3.3904 36406	3.3919 48644

$$n^{\frac{1}{2}} \left[\begin{matrix} (-6) \\ 4 \end{matrix} \right] \quad n^{\frac{1}{3}} \left[\begin{matrix} (-6) \\ 4 \end{matrix} \right] \quad n^{\frac{1}{4}} \left[\begin{matrix} (-7) \\ 4 \end{matrix} \right] \quad n^{\frac{1}{5}} \left[\begin{matrix} (-7) \\ 4 \end{matrix} \right]$$

Table 3.1 POWERS AND ROOTS n^k

k	450	451	452	453	454
1	450	451	452	453	454
2	2 02500	2 03401	2 04304	2 05209	2 06116
3	911 25000	917 33851	923 45408	929 59677	935 76664
4	(10) 4. 1006 25000	(10) 4. 1371 96680	(10) 4. 1740 12442	(10) 4. 2110 73368	(10) 4. 2483 80546
5	(13) 1. 8452 81250	(13) 1. 8658 75703	(13) 1. 8866 53624	(13) 1. 9076 16236	(13) 1. 9287 64768
6	(15) 8. 3037 65625	(15) 8. 4150 99419	(15) 8. 5276 74379	(15) 8. 6415 01548	(15) 8. 7565 92045
7	(18) 3. 7366 94531	(18) 3. 7952 09838	(18) 3. 8545 08819	(18) 3. 9146 00201	(18) 3. 9754 92789
8	(21) 1. 6815 12539	(21) 1. 7116 39637	(21) 1. 7422 37986	(21) 1. 7733 13891	(21) 1. 8048 73726
9	(23) 7. 5668 06426	(23) 7. 7194 94763	(23) 7. 8749 15698	(23) 8. 0331 11927	(23) 8. 1941 26716
10	(26) 3. 4050 62892	(26) 3. 4814 92138	(26) 3. 5594 61895	(26) 3. 6389 99703	(26) 3. 7201 33529
24	(63) 4. 7544 50505	(63) 5. 0146 08183	(63) 5. 2883 77338	(63) 5. 5764 37619	(63) 5. 8795 01000
1/2	(1) 2. 1213 20344	(1) 2. 1236 76058	(1) 2. 1260 29163	(1) 2. 1283 79665	(1) 2. 1307 27575
1/3	7. 6630 94324	7. 6687 66491	7. 6744 30279	7. 6800 85719	7. 6857 32843
1/4	4. 6057 79352	4. 6083 35988	4. 6108 88377	4. 6134 36534	4. 6159 80476
1/5	3. 3934 58190	3. 3949 65055	3. 3964 69249	3. 3979 70784	3. 3994 69669
1	455	456	457	458	459
2	2 07025	2 07936	2 08849	2 09764	2 10681
3	941 96375	948 18816	954 43993	960 71912	967 02579
4	(10) 4. 2859 35063	(10) 4. 3237 38010	(10) 4. 3617 90480	(10) 4. 4000 93570	(10) 4. 4386 48376
5	(13) 1. 9501 00453	(13) 1. 9716 24532	(13) 1. 9933 38249	(13) 2. 0152 42855	(13) 2. 0373 39605
6	(15) 8. 8729 57063	(15) 8. 9906 07868	(15) 9. 1095 55800	(15) 9. 2298 12275	(15) 9. 3513 88785
7	(18) 4. 0371 95464	(18) 4. 0997 17188	(18) 4. 1630 67001	(18) 4. 2272 54022	(18) 4. 2922 87452
8	(21) 1. 8369 23936	(21) 1. 8694 71038	(21) 1. 9025 21619	(21) 1. 9360 82342	(21) 1. 9701 59941
9	(23) 8. 3580 03909	(23) 8. 5247 87931	(23) 8. 6945 23800	(23) 8. 8672 57127	(23) 9. 0430 34128
10	(26) 3. 8028 91778	(26) 3. 8873 03297	(26) 3. 9733 97377	(26) 4. 0612 03764	(26) 4. 1507 52665
24	(63) 6. 1983 13235	(63) 6. 5336 55383	(63) 6. 8863 45396	(63) 7. 2572 39774	(63) 7. 6472 35292
1/2	(1) 2. 1330 72901	(1) 2. 1354 15650	(1) 2. 1377 55833	(1) 2. 1400 93456	(1) 2. 1424 28529
1/3	7. 6913 71681	7. 6970 02263	7. 7026 24618	7. 7082 38778	7. 7138 44772
1/4	4. 6185 20218	4. 6210 55778	4. 6235 87171	4. 6261 14413	4. 6286 37519
1/5	3. 4009 65915	3. 4024 59532	3. 4039 50532	3. 4054 38923	3. 4069 24718
1	460	461	462	463	464
2	2 11600	2 12521	2 13444	2 14369	2 15296
3	973 36000	979 72181	986 11128	992 52847	998 97344
4	(10) 4. 4774 56000	(10) 4. 5165 17544	(10) 4. 5558 34114	(10) 4. 5954 06816	(10) 4. 6352 36762
5	(13) 2. 0596 29760	(13) 2. 0821 14588	(13) 2. 1047 95360	(13) 2. 1276 73356	(13) 2. 1507 49857
6	(15) 9. 4742 96896	(15) 9. 5985 48250	(15) 9. 7241 54565	(15) 9. 8511 27638	(15) 9. 9794 79338
7	(18) 4. 3581 76572	(18) 4. 4249 30743	(18) 4. 4925 59409	(18) 4. 5610 72096	(18) 4. 6304 78413
8	(21) 2. 0047 61223	(21) 2. 0398 93073	(21) 2. 0755 62447	(21) 2. 1117 76381	(21) 2. 1485 41984
9	(23) 9. 2219 01627	(23) 9. 4039 07065	(23) 9. 5890 98505	(23) 9. 7775 24642	(23) 9. 9692 34804
10	(26) 4. 2420 74748	(26) 4. 3352 01157	(26) 4. 4301 63510	(26) 4. 5269 93909	(26) 4. 6257 24949
24	(63) 8. 0572 70802	(63) 8. 4883 29103	(63) 8. 9414 38903	(63) 9. 4176 76852	(63) 9. 9181 69666
1/2	(1) 2. 1447 61059	(1) 2. 1470 91055	(1) 2. 1494 18526	(1) 2. 1517 43479	(1) 2. 1540 65923
1/3	7. 7194 42629	7. 7250 32380	7. 7306 14052	7. 7361 87677	7. 7417 53281
1/4	4. 6311 56507	4. 6336 71390	4. 6361 82186	4. 6386 88909	4. 6411 91574
1/5	3. 4084 07924	3. 4098 88554	3. 4113 66616	3. 4128 42121	3. 4143 15079
1	465	466	467	468	469
2	2 16225	2 17156	2 18089	2 19024	2 19961
3	1005 44625	1011 94696	1018 47563	1025 03232	1031 61709
4	(10) 4. 6753 25063	(10) 4. 7156 72834	(10) 4. 7562 81192	(10) 4. 7971 51258	(10) 4. 8382 84152
5	(13) 2. 1740 26154	(13) 2. 1975 03540	(13) 2. 2211 83317	(13) 2. 2450 66789	(13) 2. 2691 55267
6	(16) 1. 0109 22162	(16) 1. 0240 36650	(16) 1. 0372 92609	(16) 1. 0506 91257	(16) 1. 0642 33820
7	(18) 4. 7007 88052	(18) 4. 7720 10788	(18) 4. 8441 56484	(18) 4. 9172 35083	(18) 4. 9912 56618
8	(21) 2. 1858 66444	(21) 2. 2237 57027	(21) 2. 2622 21078	(21) 2. 3012 66019	(21) 2. 3408 99354
9	(24) 1. 0164 27896	(24) 1. 0362 70775	(24) 1. 0564 57243	(24) 1. 0769 92497	(24) 1. 0978 81797
10	(26) 4. 7263 89719	(26) 4. 8290 21810	(26) 4. 9336 55326	(26) 5. 0403 24885	(26) 5. 1490 65627
24	(64) 1. 0444 09634	(64) 1. 0996 69046	(64) 1. 1577 24259	(64) 1. 2187 10278	(64) 1. 2827 68318
1/2	(1) 2. 1563 85865	(1) 2. 1587 03314	(1) 2. 1610 18278	(1) 2. 1633 30765	(1) 2. 1656 40783
1/3	7. 7473 10895	7. 7528 60547	7. 7584 02264	7. 7639 36077	7. 7694 62012
1/4	4. 6436 90198	4. 6461 84795	4. 6486 75380	4. 6511 61968	4. 6536 44575
1/5	3. 4157 85500	3. 4172 53393	3. 4187 18768	3. 4201 81635	3. 4216 42003
1	470	471	472	473	474
2	2 20900	2 21841	2 22784	2 23729	2 24676
3	1038 23000	1044 87111	1051 54048	1058 23817	1064 96424
4	(10) 4. 8796 81000	(10) 4. 9213 42928	(10) 4. 9632 71066	(10) 5. 0054 66544	(10) 5. 0479 30498
5	(13) 2. 2934 50070	(13) 2. 3179 52519	(13) 2. 3426 63943	(13) 2. 3675 85675	(13) 2. 3927 19056
6	(16) 1. 0779 21533	(16) 1. 0917 55637	(16) 1. 1057 37381	(16) 1. 1198 68024	(16) 1. 1341 48832
7	(18) 5. 0662 31205	(18) 5. 1421 69048	(18) 5. 2190 80439	(18) 5. 2969 75756	(18) 5. 3758 65466
8	(21) 2. 3811 28666	(21) 2. 4219 61622	(21) 2. 4634 05967	(21) 2. 5054 69532	(21) 2. 5481 60231
9	(24) 1. 1191 30473	(24) 1. 1407 43924	(24) 1. 1627 27616	(24) 1. 1850 87089	(24) 1. 2078 27949
10	(26) 5. 2599 13224	(26) 5. 3729 03881	(26) 5. 4880 74350	(26) 5. 6054 61930	(26) 5. 7251 04480
24	(64) 1. 3500 46075	(64) 1. 4206 98007	(64) 1. 4948 85630	(64) 1. 5727 77826	(64) 1. 6545 51159
1/2	(1) 2. 1679 48339	(1) 2. 1702 53441	(1) 2. 1725 56098	(1) 2. 1748 56317	(1) 2. 1771 54106
1/3	7. 7749 80097	7. 7804 90361	7. 7859 92832	7. 7914 87536	7. 7969 74500
1/4	4. 6561 23215	4. 6585 97902	4. 6610 68652	4. 6635 35480	4. 6659 98399
1/5	3. 4230 99883	3. 4245 55283	3. 4260 08213	3. 4274 58683	3. 4289 06701

$$n^2 \begin{bmatrix} (-6) 3 \\ 4 \end{bmatrix} \quad n^3 \begin{bmatrix} (-6) 1 \\ 4 \end{bmatrix} \quad n^4 \begin{bmatrix} (-7) 5 \\ 4 \end{bmatrix} \quad n^5 \begin{bmatrix} (-7) 3 \\ 3 \end{bmatrix}$$

POWERS AND ROOTS n^k

Table 3.1

1						
2	2	475	476	477	478	479
3	1071	71875	1078	50176	1085	31333
4	(10) 5.0906	64063	(10) 5.1336	68378	(10) 5.1769	44584
5	(13) 2.4180	65430	(13) 2.4436	26148	(13) 2.4694	02567
6	(16) 1.1485	81079	(16) 1.1631	66046	(16) 1.1779	05024
7	(18) 5.4557	60126	(18) 5.5366	70380	(18) 5.6186	06966
8	(21) 2.5914	86060	(21) 2.6354	55101	(21) 2.6800	75523
9	(24) 1.2309	55878	(24) 1.2544	76628	(24) 1.2783	96024
10	(26) 5.8470	40422	(26) 5.9713	08750	(26) 6.0979	49036
24	(64) 1.7403	90207	(64) 1.8304	87912	(64) 1.9250	45935
1/2	(1) 2.1794	49472	(1) 2.1817	42423	(1) 2.1840	32967
1/3	7.8024	53753	7.8079	25322	7.8133	89232
1/4	4.6684	57424	4.6709	12569	4.6733	63849
1/5	3.4303	52278	3.4317	95422	3.4332	36143
3.4346						74449
3.4361						10350
2		480	481	482	483	484
3	1105	92000	1112	84641	1119	80168
4	(10) 5.3084	16000	(10) 5.3527	91232	(10) 5.3974	44098
5	(13) 2.5480	39680	(13) 2.5746	92583	(13) 2.6015	68055
6	(16) 1.2230	59046	(16) 1.2384	27132	(16) 1.2539	55803
7	(18) 5.8706	83423	(18) 5.9568	34506	(18) 6.0440	66968
8	(21) 2.8179	28043	(21) 2.8652	37397	(21) 2.9132	40279
9	(24) 1.3526	05461	(24) 1.3781	79188	(24) 1.4041	81814
10	(26) 6.4925	06211	(26) 6.6290	41895	(26) 6.7681	56345
24	(64) 2.2376	37322	(64) 2.3522	41094	(64) 2.4724	57971
1/2	(1) 2.1908	90230	(1) 2.1931	71220	(1) 2.1954	49840
1/3	7.8297	35282	7.8351	68827	7.8405	94846
1/4	4.6806	94639	4.6831	30598	4.6855	62762
1/5	3.4375	43855	3.4389	74973	3.4404	03713
3.4418						30083
3.4432						54092
1		485	486	487	488	489
2	2	35225	2	36196	2	37169
3	1140	84125	1147	91256	1155	01303
4	(10) 5.5330	80063	(10) 5.5788	55042	(10) 5.6249	13456
5	(13) 2.6835	43830	(13) 2.7113	23550	(13) 2.7393	32853
6	(16) 1.3015	18758	(16) 1.3177	03245	(16) 1.3340	55099
7	(18) 6.3123	65975	(18) 6.4047	37773	(18) 6.4968	48334
8	(21) 3.0614	97498	(21) 3.1123	62358	(21) 3.1639	65139
9	(24) 1.4848	26286	(24) 1.5126	08106	(24) 1.5408	51023
10	(26) 7.2014	07489	(26) 7.3512	75394	(26) 7.5039	44480
24	(64) 2.8694	70250	(64) 3.0148	82996	(64) 3.1673	42798
1/2	(1) 2.2022	71555	(1) 2.2045	40769	(1) 2.2068	07649
1/3	7.8568	28008	7.8622	24183	7.8676	12960
1/4	4.6928	36620	4.6952	53740	4.6976	67133
1/5	3.4446	75750	3.4460	95065	3.4475	12045
3.4489						26700
3.4503						39037
1		490	491	492	493	494
2	2	40100	2	41081	2	42064
3	1176	49000	1183	70771	1190	95488
4	(10) 5.7648	01000	(10) 5.8120	04856	(10) 5.8594	98010
5	(13) 2.8247	52490	(13) 2.8536	94384	(13) 2.8828	73021
6	(16) 1.3841	28720	(16) 1.4011	63943	(16) 1.4183	73526
7	(18) 6.7822	30728	(18) 6.8797	14959	(18) 6.9783	97749
8	(21) 3.3232	93057	(21) 3.3779	40045	(21) 3.4333	71692
9	(24) 1.6284	13598	(24) 1.6585	68562	(24) 1.6892	18873
10	(26) 7.9792	26630	(26) 8.1435	71639	(26) 8.3109	56854
24	(64) 3.6703	36822	(64) 3.8543	91376	(64) 4.0472	72689
1/2	(1) 2.2135	94362	(1) 2.2158	51981	(1) 2.2181	07301
1/3	7.8837	35163	7.8890	94604	7.8944	46773
1/4	4.7048	85081	4.7072	83697	4.7096	78653
1/5	3.4517	49066	3.4531	56794	3.4545	62231
3.4559						65384
3.4573						66263
1		495	496	497	498	499
2	2	45025	2	46016	2	47009
3	1212	87375	1220	23936	1227	63473
4	(10) 6.0037	25063	(10) 6.0523	87226	(10) 6.1013	44608
5	(13) 2.9718	43906	(13) 3.0019	84064	(13) 3.0323	68270
6	(16) 1.4710	62733	(16) 1.4889	84096	(16) 1.5070	87030
7	(18) 7.2817	60531	(18) 7.3853	61115	(18) 7.4902	22541
8	(21) 3.6044	71463	(21) 3.6631	39113	(21) 3.7226	40603
9	(24) 1.7842	13374	(24) 1.8169	17000	(24) 1.8501	52380
10	(26) 8.8318	56201	(26) 9.0119	08320	(26) 9.1952	57326
24	(64) 4.6830	06649	(64) 4.9154	15513	(64) 5.1588	55098
1/2	(1) 2.2248	59546	(1) 2.2271	05745	(1) 2.2293	49681
1/3	7.9104	59893	7.9157	83219	7.9210	99395
1/4	4.7168	41683	4.7192	22124	4.7215	98967
1/5	3.4587	64874	3.4601	61227	3.4615	55329
3.4629						47190
3.4643						36816
$\frac{1}{n^2} \left[\begin{smallmatrix} (-6) \\ 3 \end{smallmatrix} \right]$			$\frac{1}{n^3} \left[\begin{smallmatrix} (-6) \\ 4 \end{smallmatrix} \right]$		$\frac{1}{n^4} \left[\begin{smallmatrix} (-7) \\ 4 \end{smallmatrix} \right]$	$\frac{1}{n^5} \left[\begin{smallmatrix} (-7) \\ 3 \end{smallmatrix} \right]$

Table 3.1

POWERS AND ROOTS n^k

k	500	501	502	503	504
1					
2	2 50000	2 51001	2 52004	2 53009	2 54016
3	1250 00000	1257 51501	1265 06008	1272 63527	1280 24064
4	(10) 6. 2500 00000	(10) 6. 3001 50200	(10) 6. 3506 01602	(10) 6. 4013 55408	(10) 6. 4524 12826
5	(13) 3. 1250 00000	(13) 3. 1563 75250	(13) 3. 1880 02004	(13) 3. 2198 81770	(13) 3. 2520 16064
6	(16) 1. 5625 00000	(16) 1. 5813 44000	(16) 1. 6003 77006	(16) 1. 6196 00530	(16) 1. 6390 16096
7	(18) 7. 8125 00000	(18) 7. 9225 33442	(18) 8. 0338 92570	(18) 8. 1465 90668	(18) 8. 2606 41125
8	(21) 3. 9062 50000	(21) 3. 9691 89254	(21) 4. 0330 14070	(21) 4. 0977 35106	(21) 4. 1633 63127
9	(24) 1. 9531 25000	(24) 1. 9885 63816	(24) 2. 0245 73063	(24) 2. 0611 60758	(24) 2. 0983 35016
10	(26) 9. 7656 25000	(26) 9. 9627 04720	(27) 1. 0163 35678	(27) 1. 0367 63861	(27) 1. 0575 60848
24	(64) 5. 9604 64478	(64) 6. 2532 44659	(64) 6. 5597 79050	(64) 6. 8806 84448	(64) 7. 2166 04000
1/2	(1) 2. 2360 67977	(1) 2. 2383 02929	(1) 2. 2405 35650	(1) 2. 2427 66149	(1) 2. 2449 94432
1/3	7. 9370 05260	7. 9422 93073	7. 9475 73855	7. 9528 47628	7. 9581 14416
1/4	4. 7287 08045	4. 7310 70628	4. 7334 29676	4. 7357 85203	4. 7381 37221
1/5	3. 4657 24216	3. 4671 09398	3. 4684 92370	3. 4698 73139	3. 4712 51715
1					
2	2 55025	2 56036	2 57049	2 58064	2 59081
3	1287 87625	1295 54216	1303 23843	1310 96512	1318 72229
4	(10) 6. 5037 75063	(10) 6. 5554 43330	(10) 6. 6074 18840	(10) 6. 6597 02810	(10) 6. 7122 96456
5	(13) 3. 2844 06407	(13) 3. 3170 54325	(13) 3. 3499 61352	(13) 3. 3831 29027	(13) 3. 4165 58896
6	(16) 1. 6586 25235	(16) 1. 6784 29488	(16) 1. 6984 30405	(16) 1. 7186 29546	(16) 1. 7390 28478
7	(18) 8. 3760 57438	(18) 8. 4928 53211	(18) 8. 6110 42156	(18) 8. 7306 38093	(18) 8. 8516 54954
8	(21) 4. 2299 09006	(21) 4. 2973 83725	(21) 4. 3657 98373	(21) 4. 4351 64151	(21) 4. 5054 92371
9	(24) 2. 1361 04048	(24) 2. 1744 76165	(24) 2. 2134 59775	(24) 2. 2530 63389	(24) 2. 2932 95617
10	(27) 1. 0787 32544	(27) 1. 1002 84939	(27) 1. 1222 24106	(27) 1. 1445 56202	(27) 1. 1672 87469
24	(64) 7. 5682 08268	(64) 7. 9361 96349	(64) 8. 3212 97020	(64) 8. 7242 69942	(64) 9. 1459 06897
1/2	(1) 2. 2472 20505	(1) 2. 2494 44376	(1) 2. 2516 66050	(1) 2. 2538 85534	(1) 2. 2561 02835
1/3	7. 9633 74242	7. 9686 27129	7. 9738 73099	7. 9791 12176	7. 9843 44383
1/4	4. 7404 85740	4. 7428 30775	4. 7451 72336	4. 7475 10436	4. 7498 45086
1/5	3. 4726 28104	3. 4740 02314	3. 4753 74353	3. 4767 44229	3. 4781 11950
1					
2	2 60100	2 61121	2 62144	2 63169	2 64196
3	1326 51000	1334 32831	1342 17728	1350 05697	1357 96744
4	(10) 6. 7652 01000	(10) 6. 8184 17664	(10) 6. 8719 47674	(10) 6. 9257 92256	(10) 6. 9799 52642
5	(13) 3. 4502 52510	(13) 3. 4842 11426	(13) 3. 5184 37209	(13) 3. 5529 31427	(13) 3. 5876 95658
6	(16) 1. 7596 28780	(16) 1. 7804 32039	(16) 1. 8014 39851	(16) 1. 8226 53822	(16) 1. 8440 75568
7	(18) 8. 9741 06779	(18) 9. 0980 07199	(18) 9. 2233 72037	(18) 9. 3502 14108	(18) 9. 4785 48420
8	(21) 4. 5767 94457	(21) 4. 6490 81944	(21) 4. 7223 66483	(21) 4. 7966 59837	(21) 4. 8719 73888
9	(24) 2. 3341 65173	(24) 2. 3756 80873	(24) 2. 4178 51639	(24) 2. 4606 86497	(24) 2. 5041 94578
10	(27) 1. 1904 24238	(27) 1. 2139 72926	(27) 1. 2379 40039	(27) 1. 2623 32173	(27) 1. 2871 56013
24	(64) 9. 5870 33090	(65) 1. 0048 50848	(65) 1. 0531 22917	(65) 1. 1036 12886	(65) 1. 1564 18034
1/2	(1) 2. 2583 17958	(1) 2. 2605 30911	(1) 2. 2627 41700	(1) 2. 2649 50331	(1) 2. 2671 56810
1/3	7. 9895 69740	7. 9947 88272	8. 0000 00000	8. 0052 04946	8. 0104 03133
1/4	4. 7521 76299	4. 7545 04087	4. 7568 28460	4. 7591 49431	4. 7614 67011
1/5	3. 4794 77522	3. 4808 40954	3. 4822 02253	3. 4835 61427	3. 4849 18483
1					
2	2 65225	2 66256	2 67289	2 68324	2 69361
3	1365 90875	1373 88096	1381 88413	1389 91832	1397 98359
4	(10) 7. 0344 30063	(10) 7. 0892 25754	(10) 7. 1443 40952	(10) 7. 1997 76898	(10) 7. 2555 34832
5	(13) 3. 6227 31482	(13) 3. 6580 40489	(13) 3. 6936 24272	(13) 3. 7294 84433	(13) 3. 7656 22578
6	(16) 1. 8657 06713	(16) 1. 8875 48892	(16) 1. 9096 03749	(16) 1. 9318 72936	(16) 1. 9543 58118
7	(18) 9. 6083 89574	(18) 9. 7397 52284	(18) 9. 8726 51381	(18) 10. 0077 10181	(18) 10. 1413 11863
8	(21) 4. 9483 20630	(21) 5. 0257 12179	(21) 5. 1041 60764	(21) 5. 1836 78738	(21) 5. 2642 78570
9	(24) 2. 5483 85125	(24) 2. 5932 67484	(24) 2. 6388 51115	(24) 2. 6851 45586	(24) 2. 7321 60578
10	(27) 1. 3124 18339	(27) 1. 3381 26022	(27) 1. 3642 86026	(27) 1. 3909 05414	(27) 1. 4179 91340
24	(65) 1. 2116 39706	(65) 1. 2693 83471	(65) 1. 3297 59294	(65) 1. 3928 81704	(65) 1. 4588 69982
1/2	(1) 2. 2693 61144	(1) 2. 2715 63338	(1) 2. 2737 63400	(1) 2. 2759 61335	(1) 2. 2781 57150
1/3	8. 0155 94581	8. 0207 79314	8. 0259 57353	8. 0311 28718	8. 0362 93433
1/4	4. 7637 81212	4. 7660 92045	4. 7683 99522	4. 7707 03654	4. 7730 04452
1/5	3. 4862 73428	3. 4876 26271	3. 4889 77017	3. 4903 25675	3. 4916 72252
1					
2	2 70400	2 71441	2 72484	2 73529	2 74576
3	1406 08000	1414 20761	1422 36648	1430 55667	1438 77824
4	(10) 7. 3116 16000	(10) 7. 3680 21648	(10) 7. 4247 53026	(10) 7. 4818 11384	(10) 7. 5391 97978
5	(13) 3. 8020 40320	(13) 3. 8387 39279	(13) 3. 8757 21079	(13) 3. 9129 87354	(13) 3. 9505 39740
6	(16) 1. 9770 60966	(16) 1. 9999 83164	(16) 2. 0231 26403	(16) 2. 0464 92386	(16) 2. 0700 82824
7	(19) 1. 0280 71703	(19) 1. 0419 91229	(19) 1. 0560 71983	(19) 1. 0703 15518	(19) 1. 0847 23400
8	(21) 5. 3459 72853	(21) 5. 4287 74301	(21) 5. 5126 95749	(21) 5. 5977 50159	(21) 5. 6839 50615
9	(24) 2. 7799 05884	(24) 2. 8283 91411	(24) 2. 8776 27181	(24) 2. 9276 23333	(24) 2. 9783 90122
10	(27) 1. 4455 51059	(27) 1. 4735 91925	(27) 1. 5021 21389	(27) 1. 5311 47003	(27) 1. 5606 76424
24	(65) 1. 5278 48342	(65) 1. 5999 46126	(65) 1. 6752 98008	(65) 1. 7540 44200	(65) 1. 8363 30669
1/2	(1) 2. 2803 50850	(1) 2. 2825 42442	(1) 2. 2847 31932	(1) 2. 2869 19325	(1) 2. 2891 04628
1/3	8. 0414 51517	8. 0466 02993	8. 0517 47881	8. 0568 86203	8. 0620 17979
1/4	4. 7753 01928	4. 7775 96092	4. 7798 86957	4. 7821 74532	4. 7844 58829
1/5	3. 4930 16754	3. 4943 59190	3. 4956 99566	3. 4970 37889	3. 4983 74167

$$n^2 \left[\begin{matrix} (-6) \\ 3 \end{matrix} \right] \quad n^3 \left[\begin{matrix} (-7) \\ 4 \end{matrix} \right] \quad n^4 \left[\begin{matrix} (-7) \\ 3 \end{matrix} \right] \quad n^5 \left[\begin{matrix} (-7) \\ 3 \end{matrix} \right]$$

POWERS AND ROOTS n^k

Table 3.1

k					
1		525	526	527	528
2		2 75625	2 76676	2 77729	2 78784
3		1447 03125	1455 31576	1463 63183	1471 97952
4	(10)	7.5969 14063	7.6549 60898	7.7133 39744	7.7720 51866
5	(13)	3.9883 79883	4.0265 09432	4.0649 30045	4.1036 43385
6	(16)	2.0938 99438	2.1179 43961	2.1422 18134	2.1667 23707
7	(19)	1.0992 97205	1.1140 38524	1.1289 48957	1.1440 30117
8	(21)	5.7713 10327	5.8598 42634	5.9495 61001	6.0404 79020
9	(24)	3.0299 37922	3.0822 77226	3.1354 18647	3.1893 72923
10	(27)	1.5907 17409	1.6212 77821	1.6523 65627	1.6839 88903
24	(65)	1.9223 09365	2.0121 38448	2.1059 82534	2.2040 12944
1/2	(1)	2.2912 87847	2.2934 68988	2.2956 48057	2.2978 25059
1/3		8.0671 43230	8.0722 61977	8.0773 74241	8.0824 80041
1/4		4.7867 39859	4.7890 17632	4.7912 92160	4.7935 63454
1/5		3.4997 08406	3.5010 40614	3.5023 70797	3.5036 98962
1		530	531	532	533
2		2 80900	2 81961	2 83024	2 84089
3		1488 77000	1497 21291	1505 68768	1514 19437
4	(10)	7.8904 81000	7.9502 00552	8.0102 58458	8.0706 55992
5	(13)	4.1819 54930	4.2215 56493	4.2614 57499	4.3016 59644
6	(16)	2.2164 36113	2.2416 46498	2.2670 95390	2.2927 85490
7	(19)	1.1747 11140	1.1903 14290	1.2060 94747	1.2220 54187
8	(21)	6.2259 69041	6.3205 68882	6.4164 24056	6.5135 48814
9	(24)	3.2997 63592	3.3562 22076	3.4135 37598	3.4717 21518
10	(27)	1.7488 74704	1.7821 53922	1.8160 02002	1.8504 27569
24	(65)	2.4133 53110	2.5250 41417	2.6416 73716	2.7634 58943
1/2	(1)	2.3021 72887	2.3043 43724	2.3065 12519	2.3086 79276
1/3		8.0926 72335	8.0977 58868	8.1028 39019	8.1079 12808
1/4		4.7980 96379	4.8003 58033	4.8026 16494	4.8048 71774
1/5		3.5063 49267	3.5076 71420	3.5089 91583	3.5103 09762
1		535	536	537	538
2		2 86225	2 87296	2 88369	2 89444
3		1531 30575	1539 90656	1548 54153	1557 20872
4	(10)	8.1924 75063	8.2538 99162	8.3156 68016	8.3777 82914
5	(13)	4.3829 74158	4.4240 89951	4.4655 13725	4.5072 47208
6	(16)	2.3448 91175	2.3713 12214	2.3979 80870	2.4248 89998
7	(19)	1.2545 16778	1.2710 23346	1.2877 15727	1.3045 95661
8	(21)	6.7116 64765	6.8126 85137	6.9150 33455	7.0187 24655
9	(24)	3.5907 40649	3.6515 99233	3.7133 72966	3.7760 73864
10	(27)	1.9210 46247	1.9572 57189	1.9940 81282	2.0315 27739
24	(65)	3.0233 66304	3.1619 49669	3.3066 09101	3.4575 98937
1/2	(1)	2.3130 06701	2.3151 67381	2.3173 26045	2.3194 82701
1/3		8.1180 41379	8.1230 96201	8.1281 44739	8.1331 87014
1/4		4.8093 78289	4.8116 18626	4.8138 61283	4.8161 00810
1/5		3.5129 40196	3.5142 52463	3.5155 62774	3.5168 71134
1		540	541	542	543
2		2 91600	2 92681	2 93764	2 94849
3		1574 64000	1583 40421	1592 20088	1601 03007
4	(10)	8.5030 56000	8.5662 16776	8.6297 28770	8.6935 93280
5	(13)	4.5916 50240	4.6343 23276	4.6773 12993	4.7206 21151
6	(16)	2.4794 91130	2.5071 68892	2.5351 03642	2.5632 97285
7	(19)	1.3389 25210	1.3563 78371	1.3740 26174	1.3918 70426
8	(21)	7.2301 96134	7.3380 06986	7.4472 21864	7.5578 56412
9	(24)	3.9043 05912	3.9698 61779	4.0363 94250	4.1039 16032
10	(27)	2.1083 25193	2.1476 95223	2.1877 25684	2.2284 26405
24	(65)	3.7796 38253	3.9512 48669	4.1303 12169	4.3171 37789
1/2	(1)	2.3237 90008	2.3259 40670	2.3280 89345	2.3302 36040
1/3		8.1432 52850	8.1482 76449	8.1532 93862	8.1583 05107
1/4		4.8205 70514	4.8228 00711	4.8250 27819	4.8272 51847
1/5		3.5194 82029	3.5207 84576	3.5220 85199	3.5233 83903
1		545	546	547	548
2		2 97025	2 98116	2 99209	3 00304
3		1618 78625	1627 71336	1636 67323	1645 66592
4	(10)	8.8223 85063	8.8873 14946	8.9526 02568	9.0182 49242
5	(13)	4.8081 99859	4.8524 73960	4.8970 73605	4.9420 00584
6	(16)	2.6204 68923	2.6494 50782	2.6786 99262	2.7082 16320
7	(19)	1.4281 55563	1.4466 00127	1.4652 48496	1.4841 02543
8	(21)	7.7834 47819	7.8984 36694	8.0149 09274	8.1328 81938
9	(24)	4.2419 79061	4.3125 46435	4.3841 55373	4.4568 19302
10	(27)	2.3118 78588	2.3546 50354	2.3981 32989	2.4423 36978
24	(65)	4.7153 73024	4.9274 63602	5.1486 79188	5.3793 94612
1/2	(1)	2.3345 23506	2.3366 64289	2.3388 03113	2.3409 39982
1/3		8.1683 09170	8.1733 02026	8.1782 88788	8.1832 69477
1/4		4.8316 90704	4.8339 05553	4.8361 17361	4.8383 26138
1/5		3.5259 75582	3.5272 68570	3.5285 59664	3.5298 48871

$$n^2 \left[\begin{matrix} (-6) \\ 3 \end{matrix} \right] \quad n^3 \left[\begin{matrix} (-7) \\ 4 \end{matrix} \right] \quad n^4 \left[\begin{matrix} (-7) \\ 3 \end{matrix} \right] \quad n^5 \left[\begin{matrix} (-7) \\ 3 \end{matrix} \right]$$

Table 3.1 POWERS AND ROOTS n^k

k					
1	550	551	552	553	554
2	3 02500	3 03601	3 04704	3 05809	3 06916
3	1663 75000	1672 84151	1681 96608	1691 12377	1700 31464
4	(10) 9.1506 25000	(10) 9.2173 56720	(10) 9.2844 52762	(10) 9.3519 14448	(10) 9.4197 43106
5	(13) 5.0328 43750	(13) 5.0787 63553	(13) 5.1250 17924	(13) 5.1716 08690	(13) 5.2185 37681
6	(16) 2.7680 64063	(16) 2.7983 98718	(16) 2.8290 09894	(16) 2.8598 99605	(16) 2.8910 69875
7	(19) 1.5224 35234	(19) 1.5419 17693	(19) 1.5616 13462	(19) 1.5815 24482	(19) 1.6016 52711
8	(21) 8.3733 93789	(21) 8.4959 66491	(21) 8.6201 06308	(21) 8.7458 30384	(21) 8.8731 56018
9	(24) 4.6053 66584	(24) 4.6812 77536	(24) 4.7582 98682	(24) 4.8364 44203	(24) 4.9157 28434
10	(27) 2.5329 51621	(27) 2.5793 83922	(27) 2.6265 80873	(27) 2.6745 53644	(27) 2.7233 13552
24	(65) 5.8708 98173	(65) 6.1325 11516	(65) 6.4052 76258	(65) 6.6896 46227	(65) 6.9860 92851
1/2	(1) 2.3452 07880	(1) 2.3473 38919	(1) 2.3494 68025	(1) 2.3515 95203	(1) 2.3537 20459
1/3	8.1932 12706	8.1981 75283	8.2031 31859	8.2080 82453	8.2130 27082
1/4	4.8427 34641	4.8449 34384	4.8471 31136	4.8493 24905	4.8515 15700
1/5	3.5324 21650	3.5337 05234	3.5349 86956	3.5362 66821	3.5375 44836
1	555	556	557	558	559
2	3 08025	3 09136	3 10249	3 11364	3 12481
3	1709 53875	1718 79616	1728 08693	1737 41112	1746 76879
4	(10) 9.4879 40063	(10) 9.5565 06650	(10) 9.6254 44200	(10) 9.6947 54050	(10) 9.7644 37536
5	(13) 5.2658 06735	(13) 5.3134 17697	(13) 5.3613 72419	(13) 5.4096 72760	(13) 5.4583 20583
6	(16) 2.9225 22738	(16) 2.9542 60240	(16) 2.9862 84438	(16) 3.0185 97400	(16) 3.0512 01206
7	(19) 1.6220 00119	(19) 1.6425 68693	(19) 1.6633 60432	(19) 1.6843 77349	(19) 1.7056 21474
8	(21) 9.0021 00663	(21) 9.1326 81934	(21) 9.2649 17605	(21) 9.3988 25608	(21) 9.5344 24040
9	(24) 4.9961 65868	(24) 5.0777 71156	(24) 5.1605 59106	(24) 5.2445 44689	(24) 5.3297 43038
10	(27) 2.7728 72057	(27) 2.8232 40762	(27) 2.8744 31422	(27) 2.9264 55937	(27) 2.9793 26358
24	(65) 7.2951 05803	(65) 7.6171 93672	(65) 7.9528 84664	(65) 8.3027 27311	(65) 8.6672 91224
1/2	(1) 2.3558 43798	(1) 2.3579 65225	(1) 2.3600 84744	(1) 2.3622 02362	(1) 2.3643 18084
1/3	8.2179 65765	8.2228 98519	8.2278 25361	8.2327 46311	8.2376 61384
1/4	4.8537 03532	4.8558 88409	4.8580 70341	4.8602 49337	4.8624 25407
1/5	3.5388 21007	3.5400 95340	3.5413 67840	3.5426 38514	3.5439 07368
1	560	561	562	563	564
2	3 13600	3 14721	3 15844	3 16969	3 18096
3	1756 16000	1765 58481	1775 04328	1784 53547	1794 06144
4	(10) 9.8344 96000	(10) 9.9049 30784	(10) 9.9757 43234	(11) 1.0046 93470	(11) 1.0118 50652
5	(13) 5.5073 17760	(13) 5.5566 66170	(13) 5.6063 67697	(13) 5.6564 24234	(13) 5.7068 37678
6	(16) 3.0840 97946	(16) 3.1172 89721	(16) 3.1507 78646	(16) 3.1845 66844	(16) 3.2186 56450
7	(19) 1.7270 94850	(19) 1.7487 99534	(19) 1.7707 37599	(19) 1.7929 11133	(19) 1.8153 22238
8	(21) 9.6717 31157	(21) 9.8107 65384	(21) 9.9515 45306	(22) 1.0094 08968	(22) 1.0238 41742
9	(24) 5.4161 69448	(24) 5.5038 39380	(24) 5.5927 68462	(24) 5.6829 72489	(24) 5.7744 67426
10	(27) 3.0330 54891	(27) 3.0876 53892	(27) 3.1431 35876	(27) 3.1995 13511	(27) 3.2567 99629
24	(65) 9.0471 67858	(65) 9.4429 71309	(65) 9.8553 39138	(66) 1.0284 93323	(66) 1.0732 44065
1/2	(1) 2.3664 31913	(1) 2.3685 43856	(1) 2.3706 53918	(1) 2.3727 62104	(1) 2.3748 68417
1/3	8.2425 70600	8.2474 73974	8.2523 71525	8.2572 63270	8.2621 49226
1/4	4.8645 98558	4.8667 68801	4.8689 36145	4.8711 00598	4.8732 62170
1/5	3.5451 74407	3.5464 39637	3.5477 03064	3.5489 64695	3.5502 24533
1	565	566	567	568	569
2	3 19225	3 20356	3 21489	3 22624	3 23761
3	1803 62125	1813 21496	1822 84263	1832 50432	1842 20009
4	(11) 1.0190 46006	(11) 1.0262 79667	(11) 1.0335 51771	(11) 1.0408 62454	(11) 1.0482 11851
5	(13) 5.7576 09935	(13) 5.8087 42917	(13) 5.8602 38543	(13) 5.9120 98737	(13) 5.9643 25433
6	(16) 3.2530 49613	(16) 3.2877 48491	(16) 3.3227 55254	(16) 3.3580 72083	(16) 3.3937 01172
7	(19) 1.8379 73032	(19) 1.8608 65646	(19) 1.8840 02229	(19) 1.9073 84943	(19) 1.9310 15967
8	(22) 1.0384 54763	(22) 1.0532 49956	(22) 1.0682 29264	(22) 1.0833 94648	(22) 1.0987 48085
9	(24) 5.8672 69410	(24) 5.9613 94749	(24) 6.0568 59926	(24) 6.1536 81599	(24) 6.2518 76604
10	(27) 3.3150 07217	(27) 3.3741 49428	(27) 3.4342 39578	(27) 3.4952 91148	(27) 3.5573 17788
24	(66) 1.1198 57461	(66) 1.1684 07534	(66) 1.2189 71112	(66) 1.2716 27927	(66) 1.3264 60719
1/2	(1) 2.3769 72865	(1) 2.3790 75451	(1) 2.3811 76180	(1) 2.3832 75058	(1) 2.3853 72088
1/3	8.2670 29409	8.2719 03838	8.2767 72529	8.2816 35499	8.2864 92764
1/4	4.8754 20869	4.8775 76704	4.8797 29685	4.8818 79820	4.8840 27117
1/5	3.5514 82586	3.5527 38859	3.5539 93358	3.5552 46087	3.5564 97054
1	570	571	572	573	574
2	3 24900	3 26041	3 27184	3 28329	3 29476
3	1851 93000	1861 69411	1871 49248	1881 32517	1891 19224
4	(11) 1.0556 00100	(11) 1.0630 27337	(11) 1.0704 93699	(11) 1.0779 99322	(11) 1.0855 44346
5	(13) 6.0169 20570	(13) 6.0698 86093	(13) 6.1232 23956	(13) 6.1769 36117	(13) 6.2310 24545
6	(16) 3.4296 44725	(16) 3.4659 04959	(16) 3.5024 84103	(16) 3.5393 84395	(16) 3.5766 08089
7	(19) 1.9548 97493	(19) 1.9790 31732	(19) 2.0034 20907	(19) 2.0280 67258	(19) 2.0529 73043
8	(22) 1.1142 91571	(22) 1.1300 27119	(22) 1.1459 56759	(22) 1.1620 82539	(22) 1.1784 06527
9	(24) 6.3514 61955	(24) 6.4524 54848	(24) 6.5548 72660	(24) 6.6587 32949	(24) 6.7640 53463
10	(27) 3.6203 33315	(27) 3.6843 51718	(27) 3.7493 87161	(27) 3.8154 53980	(27) 3.8825 66688
24	(66) 1.3835 55344	(66) 1.4430 00887	(66) 1.5048 89774	(66) 1.5693 17896	(66) 1.6363 84728
1/2	(1) 2.3874 67277	(1) 2.3895 60629	(1) 2.3916 52149	(1) 2.3937 41841	(1) 2.3958 29710
1/3	8.2913 44342	8.2961 90248	8.3010 30501	8.3058 65115	8.3106 94107
1/4	4.8861 71586	4.8883 13236	4.8904 52074	4.8925 88109	4.8947 21351
1/5	3.5577 46263	3.5589 93720	3.5602 39430	3.5614 83400	3.5627 25633

$$n^{\frac{1}{2}} \left[\begin{matrix} (-6) 2 \\ 3 \end{matrix} \right]$$

$$n^{\frac{1}{3}} \left[\begin{matrix} (-7) 8 \\ 4 \end{matrix} \right]$$

$$n^{\frac{1}{4}} \left[\begin{matrix} (-7) 4 \\ 3 \end{matrix} \right]$$

$$n^{\frac{1}{5}} \left[\begin{matrix} (-7) 2 \\ 3 \end{matrix} \right]$$

POWERS AND ROOTS n^k

Table 3.1

k					
1		575	576	577	578
2		3 30625	3 31776	3 32929	3 34084
3		1901 09375	1911 02976	1921 00033	1931 00552
4	(11)1.0931 28906	(11)1.1007 53142	(11)1.1084 17190	(11)1.1161 21191	(11)1.1238 65281
5	(13)6.2854 91211	(13)6.3403 38097	(13)6.3955 67189	(13)6.4511 80481	(13)6.5071 79976
6	(16)3.6141 57446	(16)3.6520 34744	(16)3.6902 42268	(16)3.7287 82318	(16)3.7676 57206
7	(19)2.0781 40532	(19)2.1035 72012	(19)2.1292 69789	(19)2.1552 36180	(19)2.1814 73522
8	(22)1.1949 30806	(22)1.2116 57479	(22)1.2285 88668	(22)1.2457 26512	(22)1.2630 73169
9	(24)6.8708 52133	(24)6.9791 47080	(24)7.0889 56614	(24)7.2002 99239	(24)7.3131 93651
10	(27)3.9507 39976	(27)4.0199 88718	(27)4.0903 27966	(27)4.1617 72960	(27)4.2343 39124
24	(66)1.7061 93459	(66)1.7788 51122	(66)1.8544 68735	(66)1.9331 61432	(66)2.0150 48620
1/2	(1)2.3979 15762	(1)2.4000 00000	(1)2.4020 82430	(1)2.4041 63056	(1)2.4062 41883
1/3	8.3155 17494	8.3203 35292	8.3251 47517	8.3299 54185	8.3347 55313
1/4	4.8968 51807	4.8989 79486	4.9011 04396	4.9032 26546	4.9053 45944
1/5	3.5639 66137	3.5652 04916	3.5664 41976	3.5676 77321	3.5689 10958
1		580	581	582	583
2		3 36400	3 37561	3 38724	3 39889
3		1951 12000	1961 22941	1971 37368	1981 55287
4	(11)1.1316 49600	(11)1.1394 74287	(11)1.1473 39482	(11)1.1552 45323	(11)1.1631 91951
5	(13)6.5635 67680	(13)6.6203 45609	(13)6.6775 15784	(13)6.7350 80234	(13)6.7930 40996
6	(16)3.8068 69254	(16)3.8464 20799	(16)3.8863 14186	(16)3.9265 51777	(16)3.9671 35942
7	(19)2.2079 84168	(19)2.2347 70484	(19)2.2618 34856	(19)2.2891 79686	(19)2.3168 07390
8	(22)1.2806 30817	(22)1.2984 01651	(22)1.3163 87886	(22)1.3345 91757	(22)1.3530 15516
9	(24)7.4276 58740	(24)7.5437 13594	(24)7.6613 77499	(24)7.7806 69942	(24)7.9016 10612
10	(27)4.3080 42069	(27)4.3828 97598	(27)4.4589 21704	(27)4.5361 30576	(27)4.6145 40597
24	(66)2.1002 54121	(66)2.1889 06331	(66)2.2811 38380	(66)2.3770 88299	(66)2.4768 99188
1/2	(1)2.4083 18916	(1)2.4103 94159	(1)2.4124 67616	(1)2.4145 39294	(1)2.4166 09195
1/3	8.3395 50915	8.3443 41009	8.3491 25609	8.3539 04732	8.3586 78393
1/4	4.9074 62599	4.9095 76518	4.9116 87710	4.9137 96184	4.9159 01946
1/5	3.5701 42892	3.5713 73127	3.5726 01670	3.5738 28526	3.5750 53698
1		585	586	587	588
2		3 42225	3 43396	3 44569	3 45744
3		2002 01625	2012 30056	2022 62003	2032 97472
4	(11)1.1711 79506	(11)1.1792 08128	(11)1.1872 77958	(11)1.1953 89135	(11)1.2035 41802
5	(13)6.8514 00112	(13)6.9101 59631	(13)6.9693 21611	(13)7.0288 88116	(13)7.0888 61216
6	(16)4.0080 69065	(16)4.0493 53544	(16)4.0909 91786	(16)4.1329 86212	(16)4.1753 39256
7	(19)2.3447 20403	(19)2.3729 21177	(19)2.4014 12178	(19)2.4301 95893	(19)2.4592 74822
8	(22)1.3716 61436	(22)1.3905 31810	(22)1.4096 28949	(22)1.4289 55185	(22)1.4485 12870
9	(24)8.0242 19400	(24)8.1485 16404	(24)8.2745 21928	(24)8.4022 56487	(24)8.5317 40805
10	(27)4.6941 68349	(27)4.7750 30613	(27)4.8571 44372	(27)4.9405 26815	(27)5.0251 95334
24	(66)2.5807 19397	(66)2.6887 02707	(66)2.8010 08521	(66)2.9178 02055	(66)3.0392 54545
1/2	(1)2.4186 77324	(1)2.4207 43687	(1)2.4228 08288	(1)2.4248 71131	(1)2.4269 32220
1/3	8.3634 46607	8.3682 09391	8.3729 66760	8.3777 18728	8.3824 65312
1/4	4.9180 05007	4.9201 05372	4.9222 03051	4.9242 98052	4.9263 90382
1/5	3.5762 77194	3.5774 99018	3.5787 19175	3.5799 37670	3.5811 54508
1		590	591	592	593
2		3 48100	3 49281	3 50464	3 51649
3		2053 79000	2064 25071	2074 74688	2085 27857
4	(11)1.2117 36100	(11)1.2199 72170	(11)1.2282 50153	(11)1.2365 70192	(11)1.2449 32429
5	(13)7.1492 42990	(13)7.2100 35522	(13)7.2712 40906	(13)7.3328 61239	(13)7.3948 98628
6	(16)4.2180 53364	(16)4.2611 30994	(16)4.3045 74616	(16)4.3483 86715	(16)4.3925 69785
7	(19)2.4886 51485	(19)2.5183 28417	(19)2.5483 08173	(19)2.5785 93322	(19)2.6091 86452
8	(22)1.4683 04376	(22)1.4883 32095	(22)1.5085 98438	(22)1.5291 05840	(22)1.5498 56753
9	(24)8.6629 95819	(24)8.7960 42679	(24)8.9309 02754	(24)9.0675 97630	(24)9.2061 49111
10	(27)5.1111 67533	(27)5.1984 61223	(27)5.2870 94431	(27)5.3770 85394	(27)5.4684 52572
24	(66)3.1655 43453	(66)3.2968 52680	(66)3.4333 72793	(66)3.5753 01250	(66)3.7228 42640
1/2	(1)2.4289 91560	(1)2.4310 49156	(1)2.4331 05012	(1)2.4351 59132	(1)2.4372 11521
1/3	8.3872 06527	8.3919 42387	8.3966 72908	8.4013 98104	8.4061 17992
1/4	4.9284 80050	4.9305 67063	4.9326 51429	4.9347 33156	4.9368 12252
1/5	3.5823 69695	3.5835 83235	3.5847 95134	3.5860 05396	3.5872 14026
1		595	596	597	598
2		3 54025	3 55216	3 56409	3 57604
3		2106 44875	2117 08736	2127 76173	2138 47192
4	(11)1.2533 37006	(11)1.2617 84067	(11)1.2702 73753	(11)1.2788 06208	(11)1.2873 81576
5	(13)7.4573 55187	(13)7.5202 33037	(13)7.5835 34304	(13)7.6472 61125	(13)7.7114 15640
6	(16)4.4371 26336	(16)4.4820 58990	(16)4.5273 69980	(16)4.5730 62153	(16)4.6191 37969
7	(19)2.6400 90170	(19)2.6713 07098	(19)2.7028 39878	(19)2.7346 91167	(19)2.7668 63643
8	(22)1.5708 53651	(22)1.5920 99031	(22)1.6135 95407	(22)1.6353 45318	(22)1.6573 51322
9	(24)9.3465 79225	(24)9.4889 10223	(24)9.6331 64580	(24)9.7793 65002	(24)9.9275 34420
10	(27)5.5612 14639	(27)5.6553 90493	(27)5.7509 99254	(27)5.8480 60271	(27)5.9465 93118
24	(66)3.8762 08928	(66)4.0356 19703	(66)4.2013 02448	(66)4.3734 92798	(66)4.5524 34829
1/2	(1)2.4392 62184	(1)2.4413 11123	(1)2.4433 58345	(1)2.4454 03852	(1)2.4474 47650
1/3	8.4108 32585	8.4155 41899	8.4202 45948	8.4249 44747	8.4296 38310
1/4	4.9388 88725	4.9409 62581	4.9430 33830	4.9451 02478	4.9471 68534
1/5	3.5884 21030	3.5896 26411	3.5908 30176	3.5920 32329	3.5932 32875

$$n^2 \sqrt[3]{(-6)2} \quad n^3 \sqrt[4]{(-7)7} \quad n^4 \sqrt[3]{(-7)4} \quad n^5 \sqrt[3]{(-7)2}$$

Table 3.1

POWERS AND ROOTS n^k

k							
1		600	601	602	603	604	
2		3 60000	3 61201	3 62404	3 63609	3 64816	
3		2160 00000	2170 81801	2181 67208	2192 56227	2203 48864	
4	(11)	1. 2960 00000	(11) 1. 3046 61624	(11) 1. 3133 66592	(11) 1. 3221 15049	(11) 1. 3309 07139	
5	(13)	7. 7760 00000	(13) 7. 8410 16360	(13) 7. 9064 66885	(13) 7. 9723 53744	(13) 8. 0386 79117	
6	(16)	4. 6656 00000	(16) 4. 7124 50833	(16) 4. 7596 93065	(16) 4. 8073 29308	(16) 4. 8553 62187	
7	(19)	2. 7993 60000	(19) 2. 8321 82950	(19) 2. 8653 35225	(19) 2. 8988 19573	(19) 2. 9326 38761	
8	(22)	1. 6796 16000	(22) 1. 7021 41953	(22) 1. 7249 31805	(22) 1. 7479 88202	(22) 1. 7713 13811	
9	(25)	1. 0077 69600	(25) 1. 0229 87314	(25) 1. 0384 08947	(25) 1. 0540 36886	(25) 1. 0698 73542	
10	(27)	6. 0466 17600	(27) 6. 1481 53756	(27) 6. 2512 21860	(27) 6. 3558 42422	(27) 6. 4620 36194	
24	(66)	4. 7383 81338	(66) 4. 9315 94142	(66) 5. 1323 44384	(66) 5. 3409 12849	(66) 5. 5575 90288	
1/2	(1)	2. 4494 89743	(1) 2. 4515 30134	(1) 2. 4535 68829	(1) 2. 4556 05832	(1) 2. 4576 41145	
1/3		8. 4343 26653	8. 4390 09789	8. 4436 87734	8. 4483 60500	8. 4530 28104	
1/4		4. 9492 32004	4. 9512 92896	4. 9533 51218	4. 9554 06978	4. 9574 60182	
1/5		3. 5944 31819	3. 5956 29165	3. 5968 24918	3. 5980 19083	3. 5992 11665	
1		605	606	607	608	609	
2		3 66025	3 67236	3 68449	3 69664	3 70881	
3		2214 45125	2225 45016	2236 48543	2247 55712	2258 66529	
4	(11)	1. 3397 43006	(11) 1. 3486 22797	(11) 1. 3575 46656	(11) 1. 3665 14729	(11) 1. 3755 27162	
5	(13)	8. 1054 45188	(13) 8. 1726 54150	(13) 8. 2403 08202	(13) 8. 3084 09552	(13) 8. 3769 60414	
6	(16)	4. 9037 94339	(16) 4. 9526 28415	(16) 5. 0018 67079	(16) 5. 0515 13008	(16) 5. 1015 68892	
7	(19)	2. 9667 95575	(19) 3. 0012 92819	(19) 3. 0361 33317	(19) 3. 0713 19909	(19) 3. 1068 55455	
8	(22)	1. 7949 11323	(22) 1. 8187 83448	(22) 1. 8429 32923	(22) 1. 8673 62504	(22) 1. 8920 74972	
9	(25)	1. 0859 21350	(25) 1. 1021 82770	(25) 1. 1186 60284	(25) 1. 1353 56403	(25) 1. 1522 73658	
10	(27)	6. 5698 24169	(27) 6. 6792 27585	(27) 6. 7902 67926	(27) 6. 9029 66929	(27) 7. 0173 46578	
24	(66)	5. 7826 77757	(66) 6. 0164 86963	(66) 6. 2593 40623	(66) 6. 5115 72833	(66) 6. 7735 29447	
1/2	(1)	2. 4596 74775	(1) 2. 4617 06725	(1) 2. 4637 36999	(1) 2. 4657 65601	(1) 2. 4677 92536	
1/3		8. 4576 90558	8. 4623 47878	8. 4670 00076	8. 4716 47168	8. 4762 89168	
1/4		4. 9595 10838	4. 9615 58954	4. 9636 04536	4. 9656 47592	4. 9676 88130	
1/5		3. 6004 02669	3. 6015 92098	3. 6027 79959	3. 6039 66255	3. 6051 50991	
1		610	611	612	613	614	
2		3 72100	3 73321	3 74544	3 75769	3 76996	
3		2269 81000	2280 99131	2292 20928	2303 46397	2314 75544	
4	(11)	1. 3845 84100	(11) 1. 3936 85690	(11) 1. 4028 32079	(11) 1. 4120 23414	(11) 1. 4212 59840	
5	(13)	8. 4459 63010	(13) 8. 5154 19568	(13) 8. 5853 32326	(13) 8. 6557 03525	(13) 8. 7265 35419	
6	(16)	5. 1520 37436	(16) 5. 2029 21356	(16) 5. 2542 23383	(16) 5. 3059 46261	(16) 5. 3580 92747	
7	(19)	3. 1427 42836	(19) 3. 1789 84949	(19) 3. 2155 84711	(19) 3. 2525 45058	(19) 3. 2898 68947	
8	(22)	1. 9170 73130	(22) 1. 9423 59804	(22) 1. 9679 37843	(22) 1. 9938 10121	(22) 2. 0199 79533	
9	(25)	1. 1694 14609	(25) 1. 1867 81840	(25) 1. 2043 77960	(25) 1. 2222 05604	(25) 1. 2402 67433	
10	(27)	7. 1334 29117	(27) 7. 2512 37043	(27) 7. 3707 93114	(27) 7. 4921 20352	(27) 7. 6152 42041	
24	(66)	7. 0455 68477	(66) 7. 3280 60494	(66) 7. 6213 89047	(66) 7. 9259 51097	(66) 8. 2421 57465	
1/2	(1)	2. 4698 17807	(1) 2. 4718 41419	(1) 2. 4738 63375	(1) 2. 4758 83681	(1) 2. 4779 02339	
1/3		8. 4809 26088	8. 4855 57944	8. 4901 84749	8. 4948 06516	8. 4994 23260	
1/4		4. 9697 26156	4. 9717 61679	4. 9737 94704	4. 9758 25239	4. 9779 53291	
1/5		3. 6063 34171	3. 6075 15802	3. 6086 95885	3. 6098 74428	3. 6110 51433	
1		615	616	617	618	619	
2		3 78225	3 79456	3 80689	3 81924	3 83161	
3		2326 08375	2337 44896	2348 85113	2360 29032	2371 76659	
4	(11)	1. 4305 41506	(11) 1. 4398 68559	(11) 1. 4492 41147	(11) 1. 4586 59418	(11) 1. 4681 23519	
5	(13)	8. 7978 30263	(13) 8. 8695 90326	(13) 8. 9418 17878	(13) 9. 0145 15202	(13) 9. 0876 84584	
6	(16)	5. 4106 65612	(16) 5. 4636 67641	(16) 5. 5171 01631	(16) 5. 5709 70395	(16) 5. 6252 76757	
7	(19)	3. 3275 95351	(19) 3. 3656 19267	(19) 3. 4040 51706	(19) 3. 4428 59704	(19) 3. 4820 46313	
8	(22)	2. 0464 49001	(22) 2. 0732 21468	(22) 2. 1002 99903	(22) 2. 1276 87297	(22) 2. 1553 86668	
9	(25)	1. 2585 66136	(25) 1. 2771 04424	(25) 1. 2958 85040	(25) 1. 3149 10750	(25) 1. 3341 84347	
10	(27)	7. 7401 81734	(27) 7. 8669 63254	(27) 7. 9956 10697	(27) 8. 1261 48432	(27) 8. 2586 01110	
24	(66)	8. 5704 33286	(66) 8. 9112 18488	(66) 9. 2649 68280	(66) 9. 6321 53659	(67) 1. 0013 26192	
1/2	(1)	2. 4799 19354	(1) 2. 4819 34729	(1) 2. 4839 48470	(1) 2. 4859 60579	(1) 2. 4879 71061	
1/3		8. 5040 34993	8. 5086 41730	8. 5132 43484	8. 5178 40269	8. 5224 32097	
1/4		4. 9798 78868	4. 9819 01975	4. 9839 22621	4. 9859 40813	4. 9879 56556	
1/5		3. 6122 26906	3. 6134 00850	3. 6145 73271	3. 6157 44173	3. 6169 13560	
1		620	621	622	623	624	
2		3 84400	3 85641	3 86884	3 88129	3 89376	
3		2383 28000	2394 83061	2406 41848	2418 04367	2429 70624	
4	(11)	1. 4776 33600	(11) 1. 4871 89809	(11) 1. 4967 92295	(11) 1. 5064 41206	(11) 1. 5161 36694	
5	(13)	9. 1613 28320	(13) 9. 2354 48713	(13) 9. 3100 48072	(13) 9. 3851 28716	(13) 9. 4606 92969	
6	(16)	5. 6800 23558	(16) 5. 7352 13651	(16) 5. 7908 49901	(16) 5. 8469 35190	(16) 5. 9034 72413	
7	(19)	3. 5216 14606	(19) 3. 5615 67677	(19) 3. 6019 08638	(19) 3. 6426 40623	(19) 3. 6837 66786	
8	(22)	2. 1834 01056	(22) 2. 2117 33527	(22) 2. 2403 87173	(22) 2. 2693 65108	(22) 2. 2986 70474	
9	(25)	1. 3537 08655	(25) 1. 3734 86521	(25) 1. 3935 20822	(25) 1. 4138 14463	(25) 1. 4343 70376	
10	(27)	8. 3929 93659	(27) 8. 5293 51293	(27) 8. 6676 99511	(27) 8. 8080 64101	(27) 8. 9504 71145	
24	(67)	1. 0408 79722	(67) 1. 0819 28109	(67) 1. 1245 25305	(67) 1. 1687 27115	(67) 1. 2145 91262	
1/2	(1)	2. 4899 79920	(1) 2. 4919 87159	(1) 2. 4939 92783	(1) 2. 4959 96795	(1) 2. 4979 99199	
1/3		8. 5270 18983	8. 5316 00940	8. 5361 77980	8. 5407 50116	8. 5453 17363	
1/4		4. 9899 69859	4. 9919 80728	4. 9939 89170	4. 9959 95191	4. 9979 98799	
1/5		3. 6180 84137	3. 6192 47808	3. 6204 12677	3. 6215 76049	3. 6227 37928	
		$n^2 \left[\begin{smallmatrix} (-6) \\ 3 \end{smallmatrix} \right]$	$n^3 \left[\begin{smallmatrix} (-7) \\ 4 \end{smallmatrix} \right]$	$n^4 \left[\begin{smallmatrix} (-7) \\ 3 \end{smallmatrix} \right]$	$n^5 \left[\begin{smallmatrix} (-7) \\ 3 \end{smallmatrix} \right]$		

POWERS AND ROOTS n^k

Table 3.1

1		625	626	627	628	629
2		3 90625	3 91876	3 93129	3 94384	3 95641
3		2441 40625	2453 14376	2464 91883	2476 73152	2488 58189
4	(11)	1.5258 78906	(11)1.5356 67994	(11)1.5455 04106	(11)1.5553 87395	(11)1.5653 18009
5	(13)	9.5367 43164	(13)9.6132 81641	(13)9.6903 10747	(13)9.7678 32838	(13)9.8458 50275
6	(16)	5.9604 64478	(16)6.0179 14307	(16)6.0758 24838	(16)6.1341 99022	(16)6.1930 39823
7	(19)	3.7252 90298	(19)3.7672 14356	(19)3.8095 42174	(19)3.8522 76986	(19)3.8954 22049
8	(22)	2.3283 06437	(22)2.3582 76187	(22)2.3885 82943	(22)2.4192 29947	(22)2.4502 20469
9	(25)	1.4551 91523	(25)1.4762 80893	(25)1.4976 41505	(25)1.5192 76407	(25)1.5411 88675
10	(27)	9.0949 47018	(27)9.2415 18391	(27)9.3902 12238	(27)9.5410 55835	(27)9.6940 76765
24	(67)	1.2621 77448	(67)1.3115 47419	(67)1.3627 65028	(67)1.4158 96309	(67)1.4710 09545
1/2	(1)	2.5000 00000	(1)2.5019 99201	(1)2.5039 96805	(1)2.5059 92817	(1)2.5079 87241
1/3		8.5498 79733	8.5544 37239	8.5589 89894	8.5635 37711	8.5680 80703
1/4		5.0000 00000	5.0019 98801	5.0039 95209	5.0059 89230	5.0079 80871
1/5		3.6238 98318	3.6250 57224	3.6262 14650	3.6273 70600	3.6285 25079
1		630	631	632	633	634
2		3 96900	3 98161	3 99424	4 00689	4 01956
3		2500 47000	2512 39591	2524 35968	2536 36137	2548 40104
4	(11)	1.5752 96100	(11)1.5853 21819	(11)1.5953 95318	(11)1.6055 16747	(11)1.6156 86259
5	(13)	9.5243 65430	(14)1.0003 38068	(14)1.0082 89841	(14)1.0162 92101	(14)1.0243 45088
6	(16)	6.2523 50221	(16)6.3121 33209	(16)6.3723 91794	(16)6.4331 28999	(16)6.4943 47861
7	(19)	3.9389 80639	(19)3.9829 56055	(19)4.0273 51614	(19)4.0721 70657	(19)4.1174 16544
8	(22)	2.4815 57803	(22)2.5132 45270	(22)2.5452 86220	(22)2.5776 84026	(22)2.6104 42089
9	(25)	1.5633 81416	(25)1.5858 57766	(25)1.6086 20891	(25)1.6316 73988	(25)1.6550 20284
10	(27)	9.8493 02919	(28)1.0006 76250	(28)1.0166 48403	(28)1.0328 49635	(28)1.0492 82860
24	(67)	1.5281 75339	(67)1.5874 66692	(67)1.6489 59081	(67)1.7127 30535	(67)1.7788 61719
1/2	(1)	2.5099 80080	(1)2.5119 71337	(1)2.5139 61018	(1)2.5159 49125	(1)2.5179 35662
1/3		8.5726 18882	8.5771 52262	8.5816 80854	8.5862 04672	8.5907 23728
1/4		5.0099 70139	5.0119 57040	5.0139 41581	5.0159 23768	5.0179 03608
1/5		3.6296 78090	3.6308 29638	3.6319 79727	3.6331 28361	3.6342 75544
1		635	636	637	638	639
2		4 03225	4 04496	4 05769	4 07044	4 08321
3		2560 47875	2572 59456	2584 74853	2596 94072	2609 17119
4	(11)	1.6259 04006	(11)1.6361 70140	(11)1.6464 84814	(11)1.6568 48179	(11)1.6672 60390
5	(14)	1.0324 49044	(14)1.0406 04209	(14)1.0488 10826	(14)1.0570 69138	(14)1.0653 79389
6	(16)	6.5560 51429	(16)6.6182 42770	(16)6.6809 24963	(16)6.7441 01103	(16)6.8077 74299
7	(19)	4.1630 92658	(19)4.2092 02402	(19)4.2557 49202	(19)4.3027 36504	(19)4.3501 67777
8	(22)	2.6435 63838	(22)2.6770 52728	(22)2.7109 12241	(22)2.7451 45889	(22)2.7797 57209
9	(25)	1.6786 63037	(25)1.7026 05535	(25)1.7268 51098	(25)1.7514 03077	(25)1.7762 64857
10	(28)	1.0659 51028	(28)1.0828 57120	(28)1.1000 04149	(28)1.1173 95163	(28)1.1350 33244
24	(67)	1.8474 36020	(67)1.9185 39634	(67)1.9922 61654	(67)2.0686 94164	(67)2.1479 32334
1/2	(1)	2.5199 20634	(1)2.5219 04043	(1)2.5238 85893	(1)2.5258 66188	(1)2.5278 44932
1/3		8.5952 38034	8.5997 47604	8.6042 52449	8.6087 52582	8.6132 48015
1/4		5.0198 81108	5.0218 56273	5.0238 29110	5.0257 99626	5.0277 67827
1/5		3.6354 21280	3.6365 65574	3.6377 08430	3.6388 49851	3.6399 89842
1		640	641	642	643	644
2		4 09600	4 10881	4 12164	4 13449	4 14736
3		2621 44000	2633 74721	2646 09288	2658 47707	2670 89984
4	(11)	1.6777 21600	(11)1.6882 31962	(11)1.6987 91629	(11)1.7094 00756	(11)1.7200 59497
5	(14)	1.0737 41824	(14)1.0821 56687	(14)1.0906 24226	(14)1.0991 44686	(14)1.1077 18316
6	(16)	6.8719 47674	(16)6.9366 24366	(16)7.0018 07530	(16)7.0675 00332	(16)7.1337 05955
7	(19)	4.3980 86511	(19)4.4463 76219	(19)4.4951 60434	(19)4.5444 02713	(19)4.5941 06635
8	(22)	2.8147 49767	(22)2.8501 27156	(22)2.8858 92999	(22)2.9220 50945	(22)2.9586 04673
9	(25)	1.8014 39851	(25)1.8269 31507	(25)1.8527 43305	(25)1.8788 78757	(25)1.9053 41409
10	(28)	1.1529 21505	(28)1.1710 63096	(28)1.1894 61202	(28)1.2081 19041	(28)1.2270 39868
24	(67)	2.2300 74520	(67)2.3152 22362	(67)2.4034 80891	(67)2.4949 58638	(67)2.5897 67740
1/2	(1)	2.5298 22128	(1)2.5317 97780	(1)2.5337 71892	(1)2.5357 44467	(1)2.5377 15508
1/3		8.6177 38760	8.6222 24830	8.6267 06237	8.6311 82992	8.6356 55108
1/4		5.0297 33719	5.0316 97308	5.0336 58602	5.0356 17605	5.0375 74325
1/5		3.6411 28406	3.6422 65548	3.6434 01272	3.6445 35581	3.6456 68481
1		645	646	647	648	649
2		4 16025	4 17316	4 18609	4 19904	4 21201
3		2683 36125	2695 86136	2708 40023	2720 97792	2733 59449
4	(11)	1.7307 68006	(11)1.7415 26439	(11)1.7523 34949	(11)1.7631 93692	(11)1.7741 02824
5	(14)	1.1163 45364	(14)1.1250 26079	(14)1.1337 60712	(14)1.1425 49513	(14)1.1513 92733
6	(16)	7.2004 27598	(16)7.2676 68472	(16)7.3354 31806	(16)7.4037 20841	(16)7.4725 38836
7	(19)	4.6442 75801	(19)4.6949 13833	(19)4.7460 24378	(19)4.7976 11105	(19)4.8496 77704
8	(22)	2.9955 57891	(22)3.0329 14336	(22)3.0706 77773	(22)3.1088 51996	(22)3.1474 40830
9	(25)	1.9321 34840	(25)1.9592 62661	(25)1.9867 28519	(25)2.0145 36093	(25)2.0426 89099
10	(28)	1.2462 26972	(28)1.2656 83679	(28)1.2854 13352	(28)1.3054 19389	(28)1.3257 05225
24	(67)	2.6880 24057	(67)2.7898 47292	(67)2.8953 61105	(67)3.0046 93247	(67)3.1179 75679
1/2	(1)	2.5396 85020	(1)2.5416 53005	(1)2.5436 19468	(1)2.5455 84412	(1)2.5475 47841
1/3		8.6401 22598	8.6445 85472	8.6490 43742	8.6534 97422	8.6579 46522
1/4		5.0395 28767	5.0414 80939	5.0434 30845	5.0453 78492	5.0473 23886
1/5		3.6467 99973	3.6479 30063	3.6490 58755	3.6501 86051	3.6513 11957

$$n^2 \left[\begin{matrix} (-6) \\ 3 \end{matrix} \right] \quad n^3 \left[\begin{matrix} (-7) \\ 4 \end{matrix} \right] \quad n^4 \left[\begin{matrix} (-7) \\ 3 \end{matrix} \right] \quad n^5 \left[\begin{matrix} (-7) \\ 3 \end{matrix} \right]$$

Table 3.1

POWERS AND ROOTS n^k

k	650	651	652	653	654
1	650	651	652	653	654
2	4 22500	4 23801	4 25104	4 26409	4 27716
3	2746 25000	2758 94451	2771 67808	2784 45077	2797 26264
4	(11) 1.7850 62500	(11) 1.7960 72876	(11) 1.8071 34108	(11) 1.8182 46353	(11) 1.8294 09767
5	(14) 1.1602 90625	(14) 1.1692 43442	(14) 1.1782 51439	(14) 1.1873 14868	(14) 1.1964 33987
6	(16) 7.5418 89063	(16) 7.6117 74809	(16) 7.6821 99379	(16) 7.7531 66091	(16) 7.8246 78277
7	(19) 4.9022 27891	(19) 4.9552 65401	(19) 5.0087 93995	(19) 5.0628 17457	(19) 5.1173 39593
8	(22) 3.1864 48129	(22) 3.2258 77776	(22) 3.2657 33685	(22) 3.3060 19800	(22) 3.3467 40094
9	(25) 2.0711 91284	(25) 2.1000 46432	(25) 2.1292 58363	(25) 2.1588 30929	(25) 2.1887 68021
10	(28) 1.3462 74334	(28) 1.3671 30227	(28) 1.3882 76452	(28) 1.4097 16597	(28) 1.4314 54286
24	(67) 3.2353 44710	(67) 3.3569 41134	(67) 3.4829 10364	(67) 3.6134 02582	(67) 3.7485 72888
1/2	(1) 2.5495 09757	(1) 2.5514 70164	(1) 2.5534 29067	(1) 2.5553 86468	(1) 2.5573 42371
1/3	8.6623 91053	8.6668 31029	8.6712 66460	8.6756 97359	8.6801 23736
1/4	5.0492 67033	5.0512 07939	5.0531 46611	5.0550 83054	5.0570 17274
1/5	3.6524 36476	3.6535 59612	3.6546 81368	3.6558 01749	3.6569 20758
1	655	656	657	658	659
2	4 29025	4 30336	4 31649	4 32964	4 34281
3	2810 11375	2823 00416	2835 93393	2848 90312	2861 91179
4	(11) 1.8406 24506	(11) 1.8518 90729	(11) 1.8632 08592	(11) 1.8745 78253	(11) 1.8859 99870
5	(14) 1.2056 09052	(14) 1.2148 40318	(14) 1.2241 28045	(14) 1.2334 72490	(14) 1.2428 73914
6	(16) 7.8967 39288	(16) 7.9693 52487	(16) 8.0425 21255	(16) 8.1162 48987	(16) 8.1905 39094
7	(19) 5.1723 64234	(19) 5.2278 95232	(19) 5.2839 36465	(19) 5.3404 91834	(19) 5.3975 65263
8	(22) 3.3878 98573	(22) 3.4294 99272	(22) 3.4715 46257	(22) 3.5140 43626	(22) 3.5569 95508
9	(25) 2.2190 73565	(25) 2.2497 51522	(25) 2.2808 05891	(25) 2.3122 40706	(25) 2.3440 60040
10	(28) 1.4534 93185	(28) 1.4758 36999	(28) 1.4984 89470	(28) 1.5214 54385	(28) 1.5447 35566
24	(67) 3.8885 81447	(67) 4.0335 93654	(67) 4.1837 80288	(67) 4.3393 17689	(67) 4.5003 87920
1/2	(1) 2.5592 96778	(1) 2.5612 49695	(1) 2.5632 01124	(1) 2.5651 51068	(1) 2.5670 99531
1/3	8.6845 45603	8.6889 62971	8.6933 75853	8.6977 84260	8.7021 88202
1/4	5.0589 49277	5.0608 79069	5.0628 06656	5.0647 32044	5.0666 55239
1/5	3.6580 38399	3.6591 54676	3.6602 69592	3.6613 83152	3.6624 95358
1	660	661	662	663	664
2	4 35600	4 36921	4 38244	4 39569	4 40896
3	2874 96000	2888 04781	2901 17528	2914 34247	2927 54944
4	(11) 1.8974 73600	(11) 1.9089 99602	(11) 1.9205 78035	(11) 1.9322 09058	(11) 1.9438 92828
5	(14) 1.2523 32576	(14) 1.2618 48737	(14) 1.2714 22659	(14) 1.2810 54605	(14) 1.2907 44838
6	(16) 8.2653 95002	(16) 8.3408 20153	(16) 8.4168 18005	(16) 8.4933 92032	(16) 8.5705 45724
7	(19) 5.4551 60701	(19) 5.5132 82121	(19) 5.5719 33519	(19) 5.6311 18918	(19) 5.6908 42360
8	(22) 3.6004 60663	(22) 3.6442 79482	(22) 3.6886 19990	(22) 3.7334 31842	(22) 3.7787 19327
9	(25) 2.3762 68001	(25) 2.4088 68738	(25) 2.4418 66433	(25) 2.4752 65311	(25) 2.5090 69633
10	(28) 1.5683 36881	(28) 1.5922 62236	(28) 1.6165 15579	(28) 1.6411 00901	(28) 1.6660 22237
24	(67) 4.6671 78950	(67) 4.8398 84834	(67) 5.0187 05901	(67) 5.2038 48947	(67) 5.3955 27431
1/2	(1) 2.5690 46516	(1) 2.5709 92026	(1) 2.5729 36066	(1) 2.5748 78638	(1) 2.5768 19745
1/3	8.7065 87691	8.7109 82739	8.7153 73356	8.7197 59553	8.7241 41343
1/4	5.0685 76246	5.0704 95071	5.0724 11720	5.0743 26200	5.0762 38514
1/5	3.6636 06215	3.6647 15727	3.6658 23896	3.6669 30727	3.6680 36224
1	665	666	667	668	669
2	4 42225	4 43556	4 44889	4 46224	4 47561
3	2940 79625	2954 08296	2967 40963	2980 77632	2994 18309
4	(11) 1.9556 29506	(11) 1.9674 19251	(11) 1.9792 62223	(11) 1.9911 58582	(11) 2.0031 08487
5	(14) 1.3004 93622	(14) 1.3103 01221	(14) 1.3201 67903	(14) 1.3300 93933	(14) 1.3400 79578
6	(16) 8.6482 82584	(16) 8.7266 06135	(16) 8.8055 19912	(16) 8.8850 27470	(16) 8.9651 32376
7	(19) 5.7511 07918	(19) 5.8119 19686	(19) 5.8732 81781	(19) 5.9351 98350	(19) 5.9976 73560
8	(22) 3.8244 86766	(22) 3.8707 38511	(22) 3.9174 78948	(22) 3.9647 12498	(22) 4.0124 43612
9	(25) 2.5432 83699	(25) 2.5779 11848	(25) 2.6129 58458	(25) 2.6484 27948	(25) 2.6843 24776
10	(28) 1.6912 83660	(28) 1.7168 89291	(28) 1.7428 43292	(28) 1.7691 49870	(28) 1.7958 13275
24	(67) 5.5939 61683	(67) 5.7993 79113	(67) 6.0120 14426	(67) 6.2321 09844	(67) 6.4599 15340
1/2	(1) 2.5787 59392	(1) 2.5806 97580	(1) 2.5826 34314	(1) 2.5845 69597	(1) 2.5865 03431
1/3	8.7285 18735	8.7328 91741	8.7372 60372	8.7416 24639	8.7459 84552
1/4	5.0781 48670	5.0800 56673	5.0819 62528	5.0838 66242	5.0857 67819
1/5	3.6691 40389	3.6702 43226	3.6713 44740	3.6724 44934	3.6735 43810
1	670	671	672	673	674
2	4 48900	4 50241	4 51584	4 52929	4 54276
3	3007 63000	3021 11711	3034 64448	3048 21217	3061 82024
4	(11) 2.0151 12100	(11) 2.0271 69581	(11) 2.0392 81091	(11) 2.0514 46790	(11) 2.0636 66842
5	(14) 1.3501 25107	(14) 1.3602 30789	(14) 1.3703 96893	(14) 1.3806 23690	(14) 1.3909 11451
6	(16) 9.0458 38217	(16) 9.1271 48592	(16) 9.2090 67120	(16) 9.2915 97433	(16) 9.3747 43182
7	(19) 6.0607 11605	(19) 6.1243 16705	(19) 6.1884 93105	(19) 6.2532 45073	(19) 6.3185 76905
8	(22) 4.0606 76776	(22) 4.1094 16509	(22) 4.1586 67366	(22) 4.2084 33934	(22) 4.2587 20834
9	(25) 2.7206 53440	(25) 2.7574 18478	(25) 2.7946 24470	(25) 2.8322 76038	(25) 2.8703 77842
10	(28) 1.8228 37805	(28) 1.8502 27799	(28) 1.8779 87644	(28) 1.9061 21773	(28) 1.9346 34665
24	(67) 6.6956 88867	(67) 6.9396 96605	(67) 7.1922 13208	(67) 7.4535 22063	(67) 7.7239 15552
1/2	(1) 2.5884 35821	(1) 2.5903 66769	(1) 2.5922 96279	(1) 2.5942 24354	(1) 2.5961 50997
1/3	8.7503 40123	8.7546 91362	8.7590 38280	8.7633 80887	8.7677 19196
1/4	5.0876 67266	5.0895 64588	5.0914 59790	5.0933 52878	5.0952 43858
1/5	3.6746 41374	3.6757 37627	3.6768 32575	3.6779 26219	3.6790 18565

$$n^2 \left[\begin{matrix} (-6) 2 \\ 3 \end{matrix} \right]$$

$$n^3 \left[\begin{matrix} (-7) 6 \\ 4 \end{matrix} \right]$$

$$n^4 \left[\begin{matrix} (-7) 3 \\ 3 \end{matrix} \right]$$

$$n^5 \left[\begin{matrix} (-7) 2 \\ 3 \end{matrix} \right]$$

POWERS AND ROOTS n^k

Table 3.1

k	675	676	677	678	679
1					
2	4 55625	4 56976	4 58329	4 59684	4 61041
3	3075 46875	3089 15776	3102 88733	3116 65752	3130 46839
4	(11)2.0759 41406	(11)2.0882 70646	(11)2.1006 54722	(11)2.1130 93799	(11)2.1255 88037
5	(14)1.4012 60449	(14)1.4116 70957	(14)1.4221 43247	(14)1.4326 77595	(14)1.4432 74277
6	(16)9.4585 08032	(16)9.5428 95666	(16)9.6279 09783	(16)9.7135 54097	(16)9.7998 32341
7	(19)6.3844 92922	(19)6.4509 97470	(19)6.5180 94923	(19)6.5857 89678	(19)6.6540 86159
8	(22)4.3095 32722	(22)4.3608 74290	(22)4.4127 50263	(22)4.4651 65402	(22)4.5181 24502
9	(25)2.9089 34587	(25)2.9479 51020	(25)2.9874 31928	(25)3.0273 82142	(25)3.0678 06537
10	(28)1.9635 30847	(28)1.9928 14890	(28)2.0224 91415	(28)2.0525 65092	(28)2.0830 40639
24	(67)8.0036 95322	(67)8.2931 72571	(67)8.5926 68325	(67)8.9025 13744	(67)9.2230 50418
1/2	(1)2.5980 76211	(1)2.6000 00000	(1)2.6019 22366	(1)2.6038 43313	(1)2.6057 62844
1/3	8.7720 53215	8.7763 82955	8.7807 08428	8.7850 29644	8.7893 46612
1/4	5.0971 32735	5.0990 19514	5.1009 04200	5.1027 86801	5.1046 67319
1/5	3.6801 09614	3.6811 99371	3.6822 87840	3.6833 75023	3.6844 60923
1	680	681	682	683	684
2	4 62400	4 63761	4 65124	4 66489	4 67856
3	3144 32000	3158 21241	3172 14568	3186 11987	3200 13504
4	(11)2.1381 37600	(11)2.1507 42651	(11)2.1634 03354	(11)2.1761 19871	(11)2.1888 92367
5	(14)1.4539 33568	(14)1.4646 55745	(14)1.4754 41087	(14)1.4862 89872	(14)1.4972 02379
6	(16)9.8867 48262	(16)9.9743 05627	(17)1.0062 50822	(17)1.0151 35983	(17)1.0240 86427
7	(19)6.7229 88818	(19)6.7925 02132	(19)6.8626 30603	(19)6.9333 78761	(19)7.0047 51164
8	(22)4.5716 32397	(22)4.6256 93952	(22)4.6803 14071	(22)4.7354 97694	(22)4.7912 49796
9	(25)3.1087 10030	(25)3.1500 97581	(25)3.1919 74196	(25)3.2343 44925	(25)3.2772 14860
10	(28)2.1139 22820	(28)2.1452 16453	(28)2.1769 26402	(28)2.2090 57584	(28)2.2416 14965
24	(67)9.5546 30685	(67)9.8976 17949	(68)1.0252 38701	(68)1.0619 32441	(68)1.0998 82878
1/2	(1)2.6076 80962	(1)2.6095 97670	(1)2.6115 12971	(1)2.6134 26869	(1)2.6153 39366
1/3	8.7936 59344	8.7979 67850	8.8022 72141	8.8065 72225	8.8108 68115
1/4	5.1065 45762	5.1084 22134	5.1102 96441	5.1121 68688	5.1140 38880
1/5	3.6855 45546	3.6866 28893	3.6877 10968	3.6887 91774	3.6898 71315
1	685	686	687	688	689
2	4 69225	4 70596	4 71969	4 73344	4 74721
3	3214 19125	3228 28856	3242 42703	3256 60672	3270 82769
4	(11)2.2017 21006	(11)2.2146 05952	(11)2.2275 47370	(11)2.2405 45423	(11)2.2536 00278
5	(14)1.5081 78889	(14)1.5192 19683	(14)1.5303 25043	(14)1.5414 95251	(14)1.5527 30592
6	(17)1.0331 02539	(17)1.0421 84703	(17)1.0513 33304	(17)1.0605 48733	(17)1.0698 31378
7	(19)7.0767 52393	(19)7.1493 87060	(19)7.2226 59802	(19)7.2965 75282	(19)7.3711 38199
8	(22)4.8475 75389	(22)4.9044 79523	(22)4.9619 67284	(22)5.0200 43794	(22)5.0787 14215
9	(25)3.3205 89142	(25)3.3644 72953	(25)3.4088 71524	(25)3.4537 90130	(25)3.4992 34094
10	(28)2.2746 03562	(28)2.3080 28446	(28)2.3418 94737	(28)2.3762 07610	(28)2.4109 72291
24	(68)1.1391 31118	(68)1.1797 19551	(68)1.2216 91886	(68)1.2650 93189	(68)1.3099 69927
1/2	(1)2.6172 50466	(1)2.6191 60171	(1)2.6210 68484	(1)2.6229 75410	(1)2.6248 80950
1/3	8.8151 59819	8.8194 47349	8.8237 30714	8.8280 09925	8.8322 84991
1/4	5.1159 07022	5.1177 73120	5.1196 37179	5.1214 99204	5.1233 59200
1/5	3.6909 49595	3.6920 26615	3.6931 02381	3.6941 76894	3.6952 50159
1	690	691	692	693	694
2	4 76100	4 77481	4 78864	4 80249	4 81636
3	3285 09000	3299 39371	3313 73888	3328 12557	3342 55384
4	(11)2.2667 12100	(11)2.2798 81054	(11)2.2931 07305	(11)2.3063 91020	(11)2.3197 32365
5	(14)1.5640 31349	(14)1.5753 97808	(14)1.5868 30255	(14)1.5983 28977	(14)1.6098 94261
6	(17)1.0791 81631	(17)1.0885 99885	(17)1.0980 86536	(17)1.1076 41981	(17)1.1172 66617
7	(19)7.4463 53253	(19)7.5222 25208	(19)7.5987 58832	(19)7.6759 58928	(19)7.7538 30324
8	(22)5.1379 83744	(22)5.1978 57619	(22)5.2583 41112	(22)5.3194 39537	(22)5.3811 58245
9	(25)3.5452 08784	(25)3.5917 19614	(25)3.6387 72050	(25)3.6863 71599	(25)3.7345 23822
10	(28)2.4461 94061	(28)2.4818 78254	(28)2.5180 30258	(28)2.5546 55518	(28)2.5917 59533
24	(68)1.3563 70007	(68)1.4043 42816	(68)1.4539 39271	(68)1.5052 11857	(68)1.5582 14678
1/2	(1)2.6267 85107	(1)2.6286 87886	(1)2.6305 89288	(1)2.6324 89316	(1)2.6343 89794
1/3	8.8365 55922	8.8408 22729	8.8450 85422	8.8493 44010	8.8535 98503
1/4	5.1252 17173	5.1270 73128	5.1289 27069	5.1307 79001	5.1326 28931
1/5	3.6963 22179	3.6973 92956	3.6984 62494	3.6995 30796	3.7005 97866
1	695	696	697	698	699
2	4 83025	4 84416	4 85809	4 87204	4 88601
3	3357 02375	3371 53536	3386 08873	3400 68392	3415 32099
4	(11)2.3331 31506	(11)2.3465 88611	(11)2.3601 03845	(11)2.3736 77376	(11)2.3873 09372
5	(14)1.6215 26397	(14)1.6332 25673	(14)1.6449 92380	(14)1.6568 26809	(14)1.6687 29251
6	(17)1.1269 60846	(17)1.1367 25068	(17)1.1465 59689	(17)1.1564 65112	(17)1.1664 41746
7	(19)7.8323 77878	(19)7.9116 06476	(19)7.9915 21031	(19)8.0721 26484	(19)8.1534 27808
8	(22)5.4435 02625	(22)5.5064 78107	(22)5.5700 90158	(22)5.6343 44286	(22)5.6992 46038
9	(25)3.7832 34325	(25)3.8325 08763	(25)3.8823 52840	(25)3.9327 72312	(25)3.9837 72980
10	(28)2.6293 47856	(28)2.6674 26099	(28)2.7059 99930	(28)2.7450 57074	(28)2.7846 57313
24	(68)1.6130 03502	(68)1.6696 35809	(68)1.7281 70846	(68)1.7886 69670	(68)1.8511 95210
1/2	(1)2.6362 85265	(1)2.6381 81192	(1)2.6400 75756	(1)2.6419 68963	(1)2.6438 60813
1/3	8.8578 48911	8.8620 95243	8.8663 37511	8.8705 75722	8.8748 09888
1/4	5.1344 76863	5.1363 22801	5.1381 66751	5.1400 08719	5.1418 48708
1/5	3.7016 63707	3.7027 28321	3.7037 91713	3.7048 53884	3.7059 14839

$$n^2 \left[\begin{matrix} (-6) \\ 3 \end{matrix} \right] \quad n^3 \left[\begin{matrix} (-7) \\ 4 \end{matrix} \right] \quad n^4 \left[\begin{matrix} (-7) \\ 3 \end{matrix} \right] \quad n^5 \left[\begin{matrix} (-7) \\ 3 \end{matrix} \right]$$

Table 3.1 POWERS AND ROOTS n^k

k	700	701	702	703	704
1	700	701	702	703	704
2	4 90000	4 91401	4 92804	4 94209	4 95616
3	3430 00000	3444 72101	3459 48408	3474 28927	3489 13664
4	(11) 2.4010 00000	(11) 2.4147 49428	(11) 2.4285 57824	(11) 2.4424 25357	(11) 2.4563 52195
5	(14) 1.6807 00000	(14) 1.6927 39349	(14) 1.7048 47593	(14) 1.7170 25026	(14) 1.7292 71945
6	(17) 1.1764 90000	(17) 1.1866 10284	(17) 1.1968 03010	(17) 1.2070 68593	(17) 1.2174 07449
7	(19) 8.2354 30000	(19) 8.3181 38089	(19) 8.4015 57130	(19) 8.4856 92210	(19) 8.5705 48443
8	(22) 5.7648 01000	(22) 5.8310 14800	(22) 5.8978 93105	(22) 5.9654 41624	(22) 6.0336 66104
9	(25) 4.0353 60700	(25) 4.0875 41375	(25) 4.1403 20960	(25) 4.1937 05461	(25) 4.2477 00937
10	(28) 2.8247 52490	(28) 2.8653 66504	(28) 2.9065 05314	(28) 2.9481 74939	(28) 2.9903 81460
24	(68) 1.9158 12314	(68) 1.9825 87808	(68) 2.0515 90555	(68) 2.1228 91511	(68) 2.1965 63787
1/2	(1) 2.6457 51311	(1) 2.6476 40459	(1) 2.6495 28260	(1) 2.6514 14717	(1) 2.6532 99832
1/3	8.8790 40017	8.8832 66120	8.8874 88205	8.8917 06283	8.8959 20362
1/4	5.1436 86724	5.1455 22771	5.1473 56856	5.1491 88981	5.1510 19154
1/5	3.7069 74581	3.7080 33112	3.7090 90435	3.7101 46554	3.7112 01473
1	705	706	707	708	709
2	4 97025	4 98436	4 99849	5 01264	5 02681
3	3504 02625	3518 95816	3533 93243	3548 94912	3564 00829
4	(11) 2.4703 38506	(11) 2.4843 84461	(11) 2.4984 90228	(11) 2.5126 55977	(11) 2.5268 81878
5	(14) 1.7415 88647	(14) 1.7539 75429	(14) 1.7664 32591	(14) 1.7789 60432	(14) 1.7915 59251
6	(17) 1.2278 19996	(17) 1.2383 06653	(17) 1.2488 67842	(17) 1.2595 03986	(17) 1.2702 15509
7	(19) 8.6561 30972	(19) 8.7424 44971	(19) 8.8294 95643	(19) 8.9172 88218	(19) 9.0058 27960
8	(22) 6.1025 72335	(22) 6.1721 66150	(22) 6.2424 53419	(22) 6.3134 40059	(22) 6.3851 32023
9	(25) 4.3023 13497	(25) 4.3575 49302	(25) 4.4134 14568	(25) 4.4699 15561	(25) 4.5270 58605
10	(28) 3.0331 31015	(28) 3.0764 29807	(28) 3.1202 84099	(28) 3.1647 00218	(28) 3.2096 84551
24	(68) 2.2726 82709	(68) 2.3513 25887	(68) 2.4325 73275	(68) 2.5165 07242	(68) 2.6032 12640
1/2	(1) 2.6551 83609	(1) 2.6570 66051	(1) 2.6589 47160	(1) 2.6608 26939	(1) 2.6627 05391
1/3	8.9001 30453	8.9043 36564	8.9085 38706	8.9127 36887	8.9169 31117
1/4	5.1528 47377	5.1546 73657	5.1564 97998	5.1583 20404	5.1601 40881
1/5	3.7122 55193	3.7133 07718	3.7143 59051	3.7154 09195	3.7164 58153
1	710	711	712	713	714
2	5 04100	5 05521	5 06944	5 08369	5 09796
3	3579 11000	3594 25431	3609 44128	3624 67097	3639 94344
4	(11) 2.5411 68100	(11) 2.5555 14814	(11) 2.5699 22191	(11) 2.5843 90402	(11) 2.5989 19616
5	(14) 1.8042 29351	(14) 1.8169 71033	(14) 1.8297 84600	(14) 1.8426 70356	(14) 1.8556 28606
6	(17) 1.2810 02839	(17) 1.2918 66404	(17) 1.3028 06635	(17) 1.3138 23964	(17) 1.3249 18825
7	(19) 9.0951 20158	(19) 9.1851 70136	(19) 9.2759 83244	(19) 9.3675 64864	(19) 9.4599 20408
8	(22) 6.4575 35312	(22) 6.5306 55967	(22) 6.6045 00070	(22) 6.6790 73748	(22) 6.7543 83171
9	(25) 4.5848 50072	(25) 4.6432 96392	(25) 4.7024 04050	(25) 4.7621 79582	(25) 4.8226 29584
10	(28) 3.2552 43551	(28) 3.3013 83735	(28) 3.3481 11683	(28) 3.3954 34042	(28) 3.4433 57523
24	(68) 2.6927 76876	(68) 2.7852 89985	(68) 2.8808 44702	(68) 2.9795 36544	(68) 3.0814 63889
1/2	(1) 2.6645 82519	(1) 2.6664 58325	(1) 2.6683 32813	(1) 2.6702 05985	(1) 2.6720 77843
1/3	8.9211 21404	8.9253 07760	8.9294 90191	8.9336 68708	8.9378 43321
1/4	5.1619 59433	5.1637 76065	5.1655 90782	5.1674 03588	5.1692 14489
1/5	3.7175 05928	3.7185 52523	3.7195 97942	3.7206 42186	3.7216 85260
1	715	716	717	718	719
2	5 11225	5 12656	5 14089	5 15524	5 16961
3	3655 25875	3670 61696	3686 01813	3701 46232	3716 94959
4	(11) 2.6135 10006	(11) 2.6281 61743	(11) 2.6428 74999	(11) 2.6576 49946	(11) 2.6724 86755
5	(14) 1.8686 59654	(14) 1.8817 63808	(14) 1.8949 41374	(14) 1.9081 92661	(14) 1.9215 17977
6	(17) 1.3360 91653	(17) 1.3473 42887	(17) 1.3586 72965	(17) 1.3700 82331	(17) 1.3815 71425
7	(19) 9.5530 55319	(19) 9.6469 75069	(19) 9.7416 85162	(19) 9.8371 91134	(19) 9.9334 98549
8	(22) 6.8304 34553	(22) 6.9072 34149	(22) 6.9847 88261	(22) 7.0631 03234	(22) 7.1421 85457
9	(25) 4.8837 60705	(25) 4.9455 79651	(25) 5.0080 93183	(25) 5.0713 08122	(25) 5.1352 31343
10	(28) 3.4918 88904	(28) 3.5410 35030	(28) 3.5908 02813	(28) 3.6411 99232	(28) 3.6922 31336
24	(68) 3.1867 28051	(68) 3.2954 33372	(68) 3.4076 87302	(68) 3.5236 00491	(68) 3.6432 86875
1/2	(1) 2.6739 48391	(1) 2.6758 17632	(1) 2.6776 85568	(1) 2.6795 52201	(1) 2.6814 17536
1/3	8.9420 14037	8.9461 80866	8.9503 43817	8.9545 02899	8.9586 58122
1/4	5.1710 23488	5.1728 30591	5.1746 35801	5.1764 39125	5.1782 40566
1/5	3.7227 27165	3.7237 67905	3.7248 07483	3.7258 45902	3.7268 83164
1	720	721	722	723	724
2	5 18400	5 19841	5 21284	5 22729	5 24176
3	3732 48000	3748 05361	3763 67048	3779 33067	3795 03424
4	(11) 2.6873 85600	(11) 2.7023 46653	(11) 2.7173 70087	(11) 2.7324 56074	(11) 2.7476 04790
5	(14) 1.9349 17632	(14) 1.9483 91937	(14) 1.9619 41202	(14) 1.9755 65742	(14) 1.9892 65868
6	(17) 1.3931 40695	(17) 1.4047 90586	(17) 1.4165 21548	(17) 1.4283 34031	(17) 1.4402 28488
7	(19) 9.5530 55319	(19) 9.6469 75069	(19) 9.7416 85162	(19) 9.8371 91134	(19) 9.9334 98549
8	(22) 7.2220 41363	(22) 7.3026 77432	(22) 7.3841 00187	(22) 7.4663 16199	(22) 7.5493 32081
9	(25) 5.1998 69781	(25) 5.2652 30428	(25) 5.3313 20335	(25) 5.3981 46612	(25) 5.4657 16426
10	(28) 3.7439 06243	(28) 3.7962 31139	(28) 3.8492 13282	(28) 3.9028 60000	(28) 3.9571 78693
24	(68) 3.7668 63772	(68) 3.8944 51981	(68) 4.0261 75870	(68) 4.1621 63488	(68) 4.3025 46659
1/2	(1) 2.6832 81573	(1) 2.6851 44316	(1) 2.6870 05769	(1) 2.6888 65932	(1) 2.6907 24809
1/3	8.9628 09493	8.9669 57022	8.9711 00718	8.9752 40590	8.9793 76646
1/4	5.1800 40128	5.1818 37817	5.1836 33637	5.1854 27593	5.1872 19688
1/5	3.7279 19273	3.7289 54232	3.7299 88042	3.7310 20708	3.7320 52232

$$n^{\frac{1}{2}} \left[\begin{matrix} (-6) 2 \\ 3 \end{matrix} \right] \quad n^{\frac{1}{3}} \left[\begin{matrix} (-7) 5 \\ 4 \end{matrix} \right] \quad n^{\frac{1}{4}} \left[\begin{matrix} (-7) 2 \\ 3 \end{matrix} \right] \quad n^{\frac{1}{5}} \left[\begin{matrix} (-7) 2 \\ 3 \end{matrix} \right]$$

POWERS AND ROOTS n^k

Table 3.1

k								
1		725		726		727		728
2		5 25625		5 27076		5 28529		5 29984
3		3810 78125		3826 57176		3842 40583		3858 28352
4	(11)	2.7628 16406	(11)	2.7780 91098	(11)	2.7934 29038	(11)	2.8088 30403
5	(14)	2.0030 41895	(14)	2.0168 94137	(14)	2.0308 22911	(14)	2.0448 28533
6	(17)	1.4522 05374	(17)	1.4642 65143	(17)	1.4764 08256	(17)	1.4886 35172
7	(20)	1.0528 48896	(20)	1.0630 56494	(20)	1.0733 48802	(20)	1.0837 26405
8	(22)	7.6331 54495	(22)	7.7177 90147	(22)	7.8032 45793	(22)	7.8895 28230
9	(25)	5.5340 37009	(25)	5.6031 15647	(25)	5.6729 59691	(25)	5.7435 76552
10	(28)	4.0121 76831	(28)	4.0678 61960	(28)	4.1242 41696	(28)	4.1813 23730
24	(68)	4.4474 61095	(68)	4.5970 46501	(68)	4.7514 46686	(68)	4.9108 09683
1/2	(1)	2.6925 82404	(1)	2.6944 38717	(1)	2.6962 93753	(1)	2.6981 47513
1/3		8.9835 08896		8.9876 37347		8.9917 62009		8.9958 82891
1/4		5.1890 09928		5.1907 98317		5.1925 84860		5.1943 69560
1/5		3.7330 82616		3.7341 11864		3.7351 39979		3.7361 66963
1		730		731		732		733
2		5 32900		5 34361		5 35824		5 37289
3		3890 17000		3906 17891		3922 23168		3938 32837
4	(11)	2.8398 24100	(11)	2.8554 16783	(11)	2.8710 73590	(11)	2.8867 94695
5	(14)	2.0730 71593	(14)	2.0873 09669	(14)	2.1016 25868	(14)	2.1160 20512
6	(17)	1.5133 42263	(17)	1.5258 23368	(17)	1.5383 90135	(17)	1.5510 43035
7	(20)	1.1047 39852	(20)	1.1153 76882	(20)	1.1261 01579	(20)	1.1369 14545
8	(22)	8.0646 00919	(22)	8.1534 05006	(22)	8.2430 63558	(22)	8.3335 62122
9	(25)	5.8871 58671	(25)	5.9601 39059	(25)	6.0339 22524	(25)	6.1085 16788
10	(28)	4.2976 25830	(28)	4.3568 61652	(28)	4.4168 31288	(28)	4.4775 42805
24	(68)	5.2450 38047	(68)	5.4202 21655	(68)	5.6010 04807	(68)	5.7875 58467
1/2	(1)	2.7018 51217	(1)	2.7037 01167	(1)	2.7055 49852	(1)	2.7073 97274
1/3		9.0041 13346		9.0082 22937		9.0123 28782		9.0164 30890
1/4		5.1979 33452		5.1997 12653		5.2014 90029		5.2032 65584
1/5		3.7382 17550		3.7392 41158		3.7402 63647		3.7412 85019
1		735		736		737		738
2		5 40225		5 41696		5 43169		5 44644
3		3970 65375		3986 88256		4003 15553		4019 47272
4	(11)	2.9184 30506	(11)	2.9343 45564	(11)	2.9503 25626	(11)	2.9663 70867
5	(14)	2.1450 46422	(14)	2.1596 78335	(14)	2.1743 89986	(14)	2.1891 81700
6	(17)	1.5766 09120	(17)	1.5895 23255	(17)	1.6025 25420	(17)	1.6156 16095
7	(20)	1.1588 07703	(20)	1.1698 89115	(20)	1.1810 61234	(20)	1.1923 24678
8	(22)	8.5172 36620	(22)	8.6103 83890	(22)	8.7044 21297	(22)	8.7993 56123
9	(25)	6.2601 68916	(25)	6.3372 42543	(25)	6.4151 58496	(25)	6.4939 24819
10	(28)	4.6012 24153	(28)	4.6642 10512	(28)	4.7279 71812	(28)	4.7925 16516
24	(68)	6.1786 86185	(68)	6.3836 27605	(68)	6.5950 74542	(68)	6.8132 24254
1/2	(1)	2.7110 88342	(1)	2.7129 31993	(1)	2.7147 74392	(1)	2.7166 15541
1/3		9.0246 23926		9.0287 14871		9.0328 02112		9.0368 85658
1/4		5.2068 11253		5.2085 81374		5.2103 49693		5.2121 16213
1/5		3.7433 24423		3.7443 42461		3.7453 59393		3.7463 75222
1		740		741		742		743
2		5 47600		5 49081		5 50564		5 52049
3		4052 24000		4068 69021		4085 18488		4101 72407
4	(11)	2.9986 57600	(11)	3.0148 99446	(11)	3.0312 07181	(11)	3.0475 80984
5	(14)	2.2190 06624	(14)	2.2340 40489	(14)	2.2491 55728	(14)	2.2643 52671
6	(17)	1.6420 64902	(17)	1.6554 24002	(17)	1.6688 73550	(17)	1.6824 14035
7	(20)	1.2151 28027	(20)	1.2266 69186	(20)	1.2383 04174	(20)	1.2500 33628
8	(22)	8.9919 47402	(22)	9.0896 18667	(22)	9.1882 16974	(22)	9.2877 49854
9	(25)	6.6540 41078	(25)	6.7354 07432	(25)	6.8176 56995	(25)	6.9007 98142
10	(28)	4.9239 90397	(28)	4.9909 36907	(28)	5.0587 01490	(28)	5.1272 93019
24	(68)	7.2704 49690	(68)	7.5099 49065	(68)	7.7569 98844	(68)	8.0118 26396
1/2	(1)	2.7202 94102	(1)	2.7221 31518	(1)	2.7239 67694	(1)	2.7258 02634
1/3		9.0450 41696		9.0491 14206		9.0531 83053		9.0572 48245
1/4		5.2156 43874		5.2174 05023		5.2191 64391		5.2209 21982
1/5		3.7484 03580		3.7494 16115		3.7504 27557		3.7514 37909
1		745		746		747		748
2		5 55025		5 56516		5 58009		5 59504
3		4134 93625		4151 60936		4168 32723		4185 08992
4	(11)	3.0805 27506	(11)	3.0971 00583	(11)	3.1137 40441	(11)	3.1304 47260
5	(14)	2.2949 92992	(14)	2.3104 37035	(14)	2.3259 64109	(14)	2.3415 74551
6	(17)	1.7097 69779	(17)	1.7235 86028	(17)	1.7374 95190	(17)	1.7514 97764
7	(20)	1.2737 78485	(20)	1.2857 95177	(20)	1.2979 08907	(20)	1.3101 20327
8	(22)	9.4896 49717	(22)	9.5920 32018	(22)	9.6953 79533	(22)	9.7997 00049
9	(25)	7.0697 89039	(25)	7.1556 55886	(25)	7.2424 48511	(25)	7.3301 75636
10	(28)	5.2669 92834	(28)	5.3381 19291	(28)	5.4101 09038	(28)	5.4829 71376
24	(68)	8.5457 57129	(68)	8.8253 48404	(68)	9.1136 94019	(68)	9.4110 55807
1/2	(1)	2.7294 68813	(1)	2.7313 00057	(1)	2.7331 30074	(1)	2.7349 58866
1/3		9.0653 67701		9.0694 21981		9.0734 72639		9.0775 19683
1/4		5.2244 31847		5.2261 84131		5.2279 34653		5.2296 83419
1/5		3.7534 55355		3.7544 62453		3.7554 68472		3.7564 73415

$$n^2 \sqrt[3]{(-6)2} \quad n^3 \sqrt[4]{(-7)5} \quad n^4 \sqrt[3]{(-7)2} \quad n^5 \sqrt[3]{(-7)1}$$

Table 3.1

POWERS AND ROOTS n^k

k					
1		750	751	752	753
2		5 62500	5 64001	5 65504	5 67009
3		4218 75000	4235 64751	4252 59008	4269 57777
4	(11) 3.1640 62500	(11) 3.1809 71280	(11) 3.1979 47740	(11) 3.2149 92061	(11) 3.2321 04423
5	(14) 2.3730 46875	(14) 2.3889 09431	(14) 2.4048 56701	(14) 2.4208 89022	(14) 2.4370 06735
6	(17) 1.7797 85156	(17) 1.7940 70983	(17) 1.8084 52239	(17) 1.8229 29433	(17) 1.8375 03078
7	(20) 1.3348 38867	(20) 1.3473 47308	(20) 1.3599 56084	(20) 1.3726 65863	(20) 1.3854 77321
8	(23) 1.0011 29150	(23) 1.0118 57828	(23) 1.0226 86975	(23) 1.0336 17395	(23) 1.0446 49900
9	(25) 7.5084 68628	(25) 7.5990 52291	(25) 7.6906 06051	(25) 7.7831 38985	(25) 7.8766 60245
10	(28) 5.6313 51471	(28) 5.7068 88271	(28) 5.7833 35750	(28) 5.8607 03656	(28) 5.9390 01825
24	(69) 1.0033 91278	(69) 1.0359 96977	(69) 1.0696 16698	(69) 1.1042 80565	(69) 1.1400 19555
1/2	(1) 2.7386 12788	(1) 2.7404 37921	(1) 2.7422 61840	(1) 2.7440 84547	(1) 2.7459 06044
1/3	9.0856 02964	9.0886 39217	9.0936 71888	9.0977 00985	9.1017 26517
1/4	5.2331 75697	5.2349 19217	5.2366 60997	5.2384 01041	5.2401 39353
1/5	3.7584 80079	3.7594 81806	3.7604 82467	3.7614 82064	3.7624 80599
1		755	756	757	758
2		5 70025	5 71536	5 73049	5 74564
3		4303 68875	4320 81216	4337 98093	4355 19512
4	(11) 3.2492 85006	(11) 3.2665 33993	(11) 3.2838 51564	(11) 3.3012 37901	(11) 3.3186 93186
5	(14) 2.4532 10180	(14) 2.4694 99699	(14) 2.4858 75634	(14) 2.5023 38329	(14) 2.5188 88128
6	(17) 1.8521 73686	(17) 1.8669 41772	(17) 1.8818 07855	(17) 1.8967 72453	(17) 1.9118 36089
7	(20) 1.3983 91133	(20) 1.4114 07980	(20) 1.4245 28546	(20) 1.4377 53520	(20) 1.4510 83592
8	(23) 1.0557 85305	(23) 1.0670 24433	(23) 1.0783 68109	(23) 1.0898 17168	(23) 1.1013 72446
9	(25) 7.9711 79054	(25) 8.0667 04711	(25) 8.1632 46588	(25) 8.2608 14132	(25) 8.3594 16865
10	(28) 6.0182 40186	(28) 6.0984 28762	(28) 6.1795 77667	(28) 6.2616 97112	(28) 6.3447 97401
24	(69) 1.1768 65520	(69) 1.2148 51214	(69) 1.2540 10313	(69) 1.2943 77441	(69) 1.3359 88198
1/2	(1) 2.7477 26333	(1) 2.7495 45417	(1) 2.7513 63298	(1) 2.7531 79980	(1) 2.7549 95463
1/3	9.1057 48491	9.1097 66916	9.1137 81798	9.1177 93146	9.1218 00968
1/4	5.2418 75936	5.2436 10795	5.2453 43934	5.2470 75356	5.2488 05067
1/5	3.7634 78075	3.7644 74495	3.7654 69862	3.7664 64176	3.7674 57442
1		760	761	762	763
2		5 77600	5 79121	5 80644	5 82169
3		4389 76000	4407 11081	4424 50728	4441 94947
4	(11) 3.3362 17600	(11) 3.3538 11326	(11) 3.3714 74547	(11) 3.3892 07446	(11) 3.4070 10204
5	(14) 2.5355 25376	(14) 2.5522 50419	(14) 2.5690 63605	(14) 2.5859 65281	(14) 2.6029 55796
6	(17) 1.9269 99286	(17) 1.9422 62569	(17) 1.9576 26467	(17) 1.9730 91509	(17) 1.9886 58228
7	(20) 1.4645 19457	(20) 1.4780 61815	(20) 1.4917 11368	(20) 1.5054 68822	(20) 1.5193 34886
8	(23) 1.1130 34787	(23) 1.1248 05041	(23) 1.1366 84062	(23) 1.1486 72711	(23) 1.1607 71853
9	(25) 8.4590 64385	(25) 8.5597 66364	(25) 8.6615 32555	(25) 8.7643 72784	(25) 8.8682 96958
10	(28) 6.4288 88932	(28) 6.5139 82203	(28) 6.6000 87807	(28) 6.6872 16435	(28) 6.7753 78876
24	(69) 1.3788 79182	(69) 1.4230 88020	(69) 1.4686 53390	(69) 1.5156 15056	(69) 1.5640 13890
1/2	(1) 2.7568 09750	(1) 2.7586 22845	(1) 2.7604 34748	(1) 2.7622 45463	(1) 2.7640 54992
1/3	9.1258 05271	9.1298 06063	9.1338 03351	9.1377 97144	9.1417 87449
1/4	5.2505 33069	5.2522 59366	5.2539 83963	5.2557 06863	5.2574 28071
1/5	3.7684 49662	3.7694 40838	3.7704 30972	3.7714 20068	3.7724 08126
1		765	766	767	768
2		5 85225	5 86756	5 88289	5 89824
3		4476 97125	4494 55096	4512 17663	4529 84832
4	(11) 3.4248 83006	(11) 3.4428 26035	(11) 3.4608 39475	(11) 3.4789 23510	(11) 3.4970 78323
5	(14) 2.6200 35500	(14) 2.6372 04743	(14) 2.6544 63877	(14) 2.6718 13255	(14) 2.6892 53231
6	(17) 2.0043 27157	(17) 2.0200 98833	(17) 2.0359 73794	(17) 2.0519 52580	(17) 2.0680 35734
7	(20) 1.5333 10275	(20) 1.5473 95706	(20) 1.5615 91900	(20) 1.5758 99582	(20) 1.5903 19480
8	(23) 1.1729 82361	(23) 1.1853 05111	(23) 1.1977 40987	(23) 1.2102 90879	(23) 1.2229 55680
9	(25) 8.9733 15059	(25) 9.0794 37150	(25) 9.1866 73373	(25) 9.2950 33948	(25) 9.4045 29178
10	(28) 6.8645 86020	(28) 6.9548 48857	(28) 7.0461 78477	(28) 7.1385 86072	(28) 7.2320 82938
24	(69) 1.6138 91907	(69) 1.6652 92289	(69) 1.7182 59425	(69) 1.7728 38934	(69) 1.8290 77701
1/2	(1) 2.7658 63337	(1) 2.7676 70501	(1) 2.7694 76485	(1) 2.7712 81292	(1) 2.7730 84925
1/3	9.1457 74274	9.1497 57625	9.1537 37512	9.1577 13940	9.1616 86919
1/4	5.2591 47590	5.2608 65424	5.2625 81576	5.2642 96052	5.2660 08854
1/5	3.7733 95151	3.7743 81144	3.7753 66108	3.7763 50045	3.7773 32958
1		770	771	772	773
2		5 92900	5 94441	5 95984	5 97529
3		4565 33000	4583 14011	4600 99648	4618 89917
4	(11) 3.5153 04100	(11) 3.5336 01025	(11) 3.5519 69283	(11) 3.5704 09058	(11) 3.5889 20538
5	(14) 2.7067 84157	(14) 2.7244 06390	(14) 2.7421 20286	(14) 2.7599 26202	(14) 2.7778 24496
6	(17) 2.0842 23801	(17) 2.1005 17327	(17) 2.1169 16861	(17) 2.1334 22954	(17) 2.1500 36160
7	(20) 1.6048 52327	(20) 1.6194 98859	(20) 1.6342 59817	(20) 1.6491 35944	(20) 1.6641 27988
8	(23) 1.2357 36292	(23) 1.2486 33620	(23) 1.2616 48578	(23) 1.2747 82084	(23) 1.2880 35063
9	(25) 9.5151 69445	(25) 9.6269 65212	(25) 9.7399 27025	(25) 9.8540 65513	(25) 9.9693 91385
10	(28) 7.3266 80473	(28) 7.4223 90179	(28) 7.5192 23664	(28) 7.6171 92641	(28) 7.7163 08932
24	(69) 1.8870 23915	(69) 1.9467 27094	(69) 2.0082 38127	(69) 2.0716 09310	(69) 2.1368 94378
1/2	(1) 2.7748 87385	(1) 2.7766 88675	(1) 2.7784 88798	(1) 2.7802 87755	(1) 2.7820 85549
1/3	9.1656 56454	9.1696 22555	9.1735 85227	9.1775 44479	9.1815 00317
1/4	5.2677 19986	5.2694 29452	5.2711 37257	5.2728 43403	5.2745 47894
1/5	3.7783 14849	3.7792 95720	3.7802 75573	3.7812 54412	3.7822 32239
		$n^2 \left[\begin{matrix} 1 \\ (-6) \\ 3 \end{matrix} \right]$	$n^3 \left[\begin{matrix} 1 \\ (-7) \\ 3 \end{matrix} \right]$	$n^4 \left[\begin{matrix} 1 \\ (-7) \\ 3 \end{matrix} \right]$	$n^5 \left[\begin{matrix} 1 \\ (-7) \\ 3 \end{matrix} \right]$

POWERS AND ROOTS n^k

Table 3.1

k					
1		775	776	777	778
2		6 00625	6 02176	6 03729	6 05284
3		4654 84375	4672 88576	4690 97433	4709 10952
4	(11) 3.6075 03906	(11) 3.6261 59350	(11) 3.6448 87054	(11) 3.6636 87207	(11) 3.6825 59993
5	(14) 2.7958 15527	(14) 2.8138 99655	(14) 2.8320 77241	(14) 2.8503 48647	(14) 2.8687 14234
6	(17) 2.1667 57034	(17) 2.1835 86133	(17) 2.2005 24016	(17) 2.2175 71247	(17) 2.2347 28389
7	(20) 1.6792 36701	(20) 1.6944 62839	(20) 1.7098 07161	(20) 1.7252 70430	(20) 1.7408 53415
8	(23) 1.3014 08443	(23) 1.3149 03163	(23) 1.3285 20164	(23) 1.3422 60395	(23) 1.3561 24810
9	(26) 1.0085 91544	(26) 1.0203 64854	(26) 1.0322 60167	(26) 1.0442 78587	(26) 1.0564 21227
10	(28) 7.8165 84463	(28) 7.9180 31271	(28) 8.0206 61501	(28) 8.1244 87408	(28) 8.2295 21359
24	(69) 2.2041 48547	(69) 2.2734 28553	(69) 2.3447 92689	(69) 2.4183 00846	(69) 2.4940 14558
1/2	(1) 2.7838 82181	(1) 2.7856 77655	(1) 2.7874 71973	(1) 2.7892 65136	(1) 2.7910 57147
1/3	9.1854 52750	9.1894 01784	9.1933 47428	9.1972 89687	9.2012 28569
1/4	5.2762 50735	5.2779 51928	5.2796 51478	5.2813 49388	5.2830 45663
1/5	3.7832 09055	3.7841 84864	3.7851 59667	3.7861 33467	3.7871 06266
1		780	781	782	783
2		6 08400	6 09961	6 11524	6 13089
3		4745 52000	4763 79541	4782 11768	4800 48687
4	(11) 3.7015 05600	(11) 3.7205 24215	(11) 3.7396 16026	(11) 3.7587 81219	(11) 3.7780 19983
5	(14) 2.8871 74368	(14) 2.9057 29412	(14) 2.9243 79732	(14) 2.9431 25695	(14) 2.9619 67667
6	(17) 2.2519 96007	(17) 2.2693 74671	(17) 2.2868 64951	(17) 2.3044 67419	(17) 2.3221 82651
7	(20) 1.7565 56885	(20) 1.7723 81618	(20) 1.7883 28391	(20) 1.8043 97989	(20) 1.8205 91198
8	(23) 1.3701 14371	(23) 1.3842 30044	(23) 1.3984 72802	(23) 1.4128 43625	(23) 1.4273 43499
9	(26) 1.0686 89209	(26) 1.0810 83664	(26) 1.0936 05731	(26) 1.1062 56559	(26) 1.1190 37304
10	(28) 8.3357 75831	(28) 8.4432 63416	(28) 8.5519 96818	(28) 8.6619 88854	(28) 8.7732 52460
24	(69) 2.5719 97041	(69) 2.6523 13239	(69) 2.7350 29868	(69) 2.8202 15463	(69) 2.9079 40422
1/2	(1) 2.7928 48009	(1) 2.7946 37722	(1) 2.7964 26291	(1) 2.7982 13716	(1) 2.8000 00000
1/3	9.2051 64083	9.2090 96233	9.2130 25029	9.2169 50477	9.2208 72584
1/4	5.2847 40305	5.2864 33318	5.2881 24706	5.2898 14473	5.2915 02622
1/5	3.7880 78066	3.7890 48871	3.7900 18681	3.7909 87500	3.7919 55329
1		785	786	787	788
2		6 16225	6 17796	6 19369	6 20944
3		4837 36625	4855 87656	4874 43403	4893 03872
4	(11) 3.7973 32506	(11) 3.8167 18976	(11) 3.8361 79582	(11) 3.8557 14511	(11) 3.8753 23954
5	(14) 2.9809 06017	(14) 2.9999 41115	(14) 3.0190 73331	(14) 3.0383 03035	(14) 3.0576 30600
6	(17) 2.3400 11224	(17) 2.3579 53717	(17) 2.3760 10711	(17) 2.3941 82792	(17) 2.4124 70543
7	(20) 1.8369 08811	(20) 1.8533 51621	(20) 1.8699 20430	(20) 1.8866 16040	(20) 1.9034 39259
8	(23) 1.4419 73416	(23) 1.4567 34374	(23) 1.4716 27378	(23) 1.4866 53439	(23) 1.5018 13575
9	(26) 1.1319 49132	(26) 1.1449 93218	(26) 1.1581 70747	(26) 1.1714 82910	(26) 1.1849 30911
10	(28) 8.8858 00685	(28) 8.9996 46695	(28) 9.1148 03776	(28) 9.2312 85332	(28) 9.3491 04886
24	(69) 2.9982 77060	(69) 3.0912 99652	(69) 3.1870 84488	(69) 3.2857 09926	(69) 3.3872 56439
1/2	(1) 2.8017 85145	(1) 2.8035 69154	(1) 2.8053 52028	(1) 2.8071 33770	(1) 2.8089 14381
1/3	9.2247 91357	9.2287 06804	9.2326 18931	9.2365 27746	9.2404 33255
1/4	5.2931 89157	5.2948 74081	5.2965 57399	5.2982 39113	5.2999 19227
1/5	3.7929 22172	3.7938 88029	3.7948 52904	3.7958 16799	3.7967 79716
1		790	791	792	793
2		6 24100	6 25681	6 27264	6 28849
3		4930 39000	4949 13671	4967 93088	4986 77257
4	(11) 3.8950 08100	(11) 3.9147 67138	(11) 3.9346 01257	(11) 3.9545 10648	(11) 3.9744 95501
5	(14) 3.0770 56399	(14) 3.0965 80806	(14) 3.1162 04196	(14) 3.1359 26944	(14) 3.1557 49428
6	(17) 2.4308 74555	(17) 2.4493 95417	(17) 2.4680 33723	(17) 2.4867 90066	(17) 2.5056 65046
7	(20) 1.9203 90899	(20) 1.9374 91775	(20) 1.9546 82708	(20) 1.9720 24523	(20) 1.9894 98046
8	(23) 1.5171 08810	(23) 1.5325 40174	(23) 1.5481 08705	(23) 1.5638 15447	(23) 1.5796 61449
9	(26) 1.1985 15960	(26) 1.2122 39278	(26) 1.2261 02094	(26) 1.2401 05649	(26) 1.2542 51190
10	(28) 9.4682 76083	(28) 9.5888 12687	(28) 9.7107 28588	(28) 9.8340 37797	(28) 9.9587 54451
24	(69) 3.4918 06676	(69) 3.5994 45514	(69) 3.7102 60118	(69) 3.8243 39997	(69) 3.9417 77065
1/2	(1) 2.8106 93865	(1) 2.8124 72222	(1) 2.8142 49456	(1) 2.8160 25568	(1) 2.8178 00561
1/3	9.2443 35465	9.2482 34384	9.2521 30018	9.2560 22375	9.2599 11460
1/4	5.3015 97745	5.3032 74670	5.3049 50005	5.3066 23755	5.3082 95923
1/5	3.7977 41656	3.7987 02623	3.7996 62619	3.8006 21646	3.8015 79705
1		795	796	797	798
2		6 32025	6 33616	6 35209	6 36804
3		5024 59875	5043 58336	5062 61573	5081 69592
4	(11) 3.9945 56006	(11) 4.0146 92355	(11) 4.0349 04737	(11) 4.0551 93344	(11) 4.0755 58368
5	(14) 3.1756 72025	(14) 3.1956 95114	(14) 3.2158 19075	(14) 3.2360 44289	(14) 3.2563 71136
6	(17) 2.5246 59260	(17) 2.5437 73311	(17) 2.5630 07803	(17) 2.5823 63342	(17) 2.6018 40538
7	(20) 2.0071 04112	(20) 2.0248 43555	(20) 2.0427 17219	(20) 2.0607 25947	(20) 2.0788 70590
8	(23) 1.5956 47769	(23) 1.6117 75470	(23) 1.6280 45624	(23) 1.6444 59306	(23) 1.6610 17601
9	(26) 1.2685 39976	(26) 1.2829 73274	(26) 1.2975 52362	(26) 1.3122 78526	(26) 1.3271 53063
10	(29) 1.0084 89281	(29) 1.0212 46726	(29) 1.0341 49232	(29) 1.0471 98264	(29) 1.0603 95298
24	(69) 4.0626 65702	(69) 4.1871 02820	(69) 4.3151 87922	(69) 4.4470 23172	(69) 4.5827 13463
1/2	(1) 2.8195 74436	(1) 2.8213 47196	(1) 2.8231 18843	(1) 2.8248 89378	(1) 2.8266 58805
1/3	9.2637 97282	9.2676 79846	9.2715 59160	9.2754 35230	9.2793 08064
1/4	5.3099 66512	5.3116 35526	5.3133 02968	5.3149 68841	5.3166 33150
1/5	3.8025 36800	3.8034 92932	3.8044 48104	3.8054 02317	3.8063 55574

$$n^2 \left[\begin{matrix} -6 \\ 3 \end{matrix} \right] 2$$

$$n^3 \left[\begin{matrix} -7 \\ 3 \end{matrix} \right] 4$$

$$n^4 \left[\begin{matrix} -7 \\ 3 \end{matrix} \right] 2$$

$$n^5 \left[\begin{matrix} -7 \\ 3 \end{matrix} \right] 1$$

Table 3.1 POWERS AND ROOTS n^k

k	800	801	802	803	804
1	800	801	802	803	804
2	6 40000	6 41601	6 43204	6 44809	6 46416
3	5120 00000	5139 22401	5158 49608	5177 81627	5197 18464
4	(11) 4. 0960 00000	(11) 4. 1165 18432	(11) 4. 1371 13856	(11) 4. 1577 86465	(11) 4. 1785 36451
5	(14) 3. 2768 00000	(14) 3. 2973 31264	(14) 3. 3179 65313	(14) 3. 3387 02531	(14) 3. 3595 43306
6	(17) 2. 6214 40000	(17) 2. 6411 62342	(17) 2. 6610 08181	(17) 2. 6809 78133	(17) 2. 7010 72818
7	(20) 2. 0971 52000	(20) 2. 1155 71036	(20) 2. 1341 28561	(20) 2. 1528 25440	(20) 2. 1716 62546
8	(23) 1. 6777 21600	(23) 1. 6945 72400	(23) 1. 7115 71106	(23) 1. 7287 18829	(23) 1. 7460 16687
9	(26) 1. 3421 77280	(26) 1. 3573 52492	(26) 1. 3726 80027	(26) 1. 3881 61219	(26) 1. 4037 97416
10	(29) 1. 0737 41824	(29) 1. 0872 39346	(29) 1. 1008 89382	(29) 1. 1146 93459	(29) 1. 1286 53123
24	(69) 4. 7223 66483	(69) 4. 8660 92789	(69) 5. 0140 05879	(69) 5. 1662 22264	(69) 5. 3228 61548
1/2	(1) 2. 8284 27125	(1) 2. 8301 94340	(1) 2. 8319 60452	(1) 2. 8337 25463	(1) 2. 8354 89376
1/3	9. 2831 77667	9. 2870 44047	9. 2909 07211	9. 2947 67164	9. 2986 23915
1/4	5. 3182 95897	5. 3199 57086	5. 3216 16720	5. 3232 74803	5. 3249 31338
1/5	3. 8073 87877	3. 8082 59229	3. 8092 09631	3. 8101 59085	3. 8111 07593

k	805	806	807	808	809
1	805	806	807	808	809
2	6 48025	6 49636	6 51249	6 52864	6 54481
3	5216 60125	5236 06616	5255 57943	5275 14112	5294 75129
4	(11) 4. 1993 64006	(11) 4. 2202 69325	(11) 4. 2412 52600	(11) 4. 2623 14025	(11) 4. 2834 53794
5	(14) 3. 3804 88025	(14) 3. 4015 37076	(14) 3. 4226 90848	(14) 3. 4439 49732	(14) 3. 4653 14119
6	(17) 2. 7212 92860	(17) 2. 7416 38883	(17) 2. 7621 11515	(17) 2. 7827 11384	(17) 2. 8034 39122
7	(20) 2. 1906 40752	(20) 2. 2097 60940	(20) 2. 2290 23992	(20) 2. 2484 30798	(20) 2. 2679 82250
8	(23) 1. 7634 65806	(23) 1. 7810 67318	(23) 1. 7988 22362	(23) 1. 8167 32085	(23) 1. 8347 97640
9	(26) 1. 4195 89974	(26) 1. 4355 40258	(26) 1. 4516 49646	(26) 1. 4679 19524	(26) 1. 4843 51291
10	(29) 1. 1427 69929	(29) 1. 1570 45448	(29) 1. 1714 81264	(29) 1. 1860 78976	(29) 1. 2008 40194
24	(69) 5. 4840 46503	(69) 5. 6499 03151	(69) 5. 8205 60843	(69) 5. 9961 52346	(69) 6. 1768 13927
1/2	(1) 2. 8372 52192	(1) 2. 8390 13913	(1) 2. 8407 74542	(1) 2. 8425 34081	(1) 2. 8442 92531
1/3	9. 3024 77468	9. 3063 27832	9. 3101 75012	9. 3140 19016	9. 3178 59849
1/4	5. 3265 86329	5. 3282 39778	5. 3298 91690	5. 3315 42067	5. 3331 90912
1/5	3. 8120 55159	3. 8130 01783	3. 8139 47468	3. 8148 92216	3. 8158 36029

k	810	811	812	813	814
1	810	811	812	813	814
2	6 56100	6 57721	6 59344	6 60969	6 62596
3	5314 41000	5334 11731	5353 87328	5373 67797	5393 53144
4	(11) 4. 3046 72100	(11) 4. 3259 69138	(11) 4. 3473 45103	(11) 4. 3688 00190	(11) 4. 3903 34592
5	(14) 3. 4867 84401	(14) 3. 5083 60971	(14) 3. 5300 44224	(14) 3. 5518 34554	(14) 3. 5737 32358
6	(17) 2. 8242 95365	(17) 2. 8452 80748	(17) 2. 8663 95910	(17) 2. 8876 41493	(17) 2. 9090 18139
7	(20) 2. 2876 79245	(20) 2. 3075 22686	(20) 2. 3275 13479	(20) 2. 3476 52533	(20) 2. 3679 40765
8	(23) 1. 8530 20189	(23) 1. 8714 00899	(23) 1. 8899 40945	(23) 1. 9086 41510	(23) 1. 9275 03783
9	(26) 1. 5009 46353	(26) 1. 5177 06129	(26) 1. 5346 32047	(26) 1. 5517 25547	(26) 1. 5689 88079
10	(29) 1. 2157 66546	(29) 1. 2308 59670	(29) 1. 2461 21222	(29) 1. 2615 52870	(29) 1. 2771 56297
24	(69) 6. 3626 85441	(69) 6. 5539 10420	(69) 6. 7506 36166	(69) 6. 9530 13847	(69) 7. 1611 98588
1/2	(1) 2. 8460 49894	(1) 2. 8478 06173	(1) 2. 8495 61370	(1) 2. 8513 15486	(1) 2. 8530 68524
1/3	9. 3216 97518	9. 3255 32030	9. 3293 63391	9. 3331 91608	9. 3370 16687
1/4	5. 3348 38230	5. 3364 84023	5. 3381 28295	5. 3397 71049	5. 3414 12288
1/5	3. 8167 78910	3. 8177 20859	3. 8186 61880	3. 8196 01974	3. 8205 41144

k	815	816	817	818	819
1	815	816	817	818	819
2	6 64225	6 65856	6 67489	6 69124	6 70761
3	5413 43375	5433 38496	5453 38513	5473 43432	5493 53259
4	(11) 4. 4119 48506	(11) 4. 4336 42127	(11) 4. 4554 15651	(11) 4. 4772 69274	(11) 4. 4992 03191
5	(14) 3. 5957 38033	(14) 3. 6178 51976	(14) 3. 6400 74587	(14) 3. 6624 06266	(14) 3. 6848 47414
6	(17) 2. 9305 26497	(17) 2. 9521 67212	(17) 2. 9739 40938	(17) 2. 9958 48326	(17) 3. 0178 90032
7	(20) 2. 3883 79095	(20) 2. 4089 68445	(20) 2. 4297 09746	(20) 2. 4506 03930	(20) 2. 4716 51936
8	(23) 1. 9465 28962	(23) 1. 9657 18251	(23) 1. 9850 72863	(23) 2. 0045 94015	(23) 2. 0242 82936
9	(26) 1. 5864 21104	(26) 1. 6040 26093	(26) 1. 6218 04529	(26) 1. 6397 57904	(26) 1. 6578 87724
10	(29) 1. 2929 33200	(29) 1. 3088 85292	(29) 1. 3250 14300	(29) 1. 3413 21966	(29) 1. 3578 10046
24	(69) 7. 3753 49576	(69) 7. 5956 30157	(69) 7. 8222 07941	(69) 8. 0552 54907	(69) 8. 2949 47511
1/2	(1) 2. 8548 20485	(1) 2. 8565 71371	(1) 2. 8583 21186	(1) 2. 8600 69929	(1) 2. 8618 17604
1/3	9. 3408 38634	9. 3446 57457	9. 3484 73160	9. 3522 85752	9. 3560 95237
1/4	5. 3430 52016	5. 3446 90236	5. 3463 26950	5. 3479 62163	5. 3495 95877
1/5	3. 8214 79391	3. 8224 16717	3. 8233 53125	3. 8242 88616	3. 8252 23193

k	820	821	822	823	824
1	820	821	822	823	824
2	6 72400	6 74041	6 75684	6 77329	6 78976
3	5513 68000	5533 87661	5554 12248	5574 41767	5594 76224
4	(11) 4. 5212 17600	(11) 4. 5433 12697	(11) 4. 5654 88679	(11) 4. 5877 45742	(11) 4. 6100 84086
5	(14) 3. 7073 98432	(14) 3. 7300 59724	(14) 3. 7528 31694	(14) 3. 7757 14746	(14) 3. 7987 09287
6	(17) 3. 0400 66714	(17) 3. 0623 79033	(17) 3. 0848 27652	(17) 3. 1074 13236	(17) 3. 1301 36452
7	(20) 2. 4928 54706	(20) 2. 5142 13186	(20) 2. 5357 28330	(20) 2. 5574 01093	(20) 2. 5792 32437
8	(23) 2. 0441 40859	(23) 2. 0641 69026	(23) 2. 0843 68687	(23) 2. 1047 41100	(23) 2. 1252 87528
9	(26) 1. 6761 95504	(26) 1. 6946 82770	(26) 1. 7133 51061	(26) 1. 7322 01925	(26) 1. 7512 36923
10	(29) 1. 3744 80313	(29) 1. 3913 34555	(29) 1. 4083 74572	(29) 1. 4256 02184	(29) 1. 4430 19224
24	(69) 8. 5414 66801	(69) 8. 7949 98523	(69) 9. 0557 33244	(69) 9. 3238 66467	(69) 9. 5995 98755
1/2	(1) 2. 8635 64213	(1) 2. 8653 09756	(1) 2. 8670 54237	(1) 2. 8687 97658	(1) 2. 8705 40019
1/3	9. 3599 01623	9. 3637 04916	9. 3675 05121	9. 3713 02245	9. 3750 96295
1/4	5. 3512 28095	5. 3528 58822	5. 3544 88059	5. 3561 15810	5. 3577 42079
1/5	3. 8261 56858	3. 8270 89612	3. 8280 21458	3. 8289 52397	3. 8298 82432

$$\frac{1}{n^2} \left[\begin{matrix} (-6) \\ 3 \end{matrix} \right] \quad \frac{1}{n^3} \left[\begin{matrix} (-7) \\ 3 \end{matrix} \right] \quad \frac{1}{n^4} \left[\begin{matrix} (-7) \\ 3 \end{matrix} \right] \quad \frac{1}{n^5} \left[\begin{matrix} (-7) \\ 3 \end{matrix} \right]$$

POWERS AND ROOTS n^k

Table 3.1

k					
1		825	826	827	828
2		6 80625	6 82276	6 83929	6 85584
3		5615 15625	5635 59976	5656 09283	5676 63552
4	(11)	4.6325 03906	(11) 4.6550 05402	(11) 4.6775 88770	(11) 4.7002 54211
5	(14)	3.8218 15723	(14) 3.8450 34462	(14) 3.8683 65913	(14) 3.8918 10486
6	(17)	3.1529 97971	(17) 3.1759 98465	(17) 3.1991 38610	(17) 3.2224 19083
7	(20)	2.6012 23326	(20) 2.6233 74732	(20) 2.6456 87631	(20) 2.6681 63000
8	(23)	2.1460 09244	(23) 2.1669 07529	(23) 2.1879 83671	(23) 2.2092 38964
9	(26)	1.7704 57626	(26) 1.7898 65619	(26) 1.8094 62496	(26) 1.8292 49863
10	(29)	1.4606 27542	(29) 1.4784 29001	(29) 1.4964 25484	(29) 1.5146 18886
24	(69)	9.8831 35853	(70) 1.0174 68882	(70) 1.0474 47415	(70) 1.0782 71392
1/2	(1)	2.8722 81323	(1) 2.8740 21573	(1) 2.8757 60769	(1) 2.8774 98914
1/3		9.3788 87277	9.3826 75196	9.3864 60060	9.3902 41873
1/4		5.3593 66869	5.3609 90182	5.3626 12021	5.3642 32391
1/5		3.8308 11564	3.8317 39795	3.8326 67128	3.8335 93565
1		830	831	832	833
2		6 88900	6 90561	6 92224	6 93889
3		5717 87000	5738 56191	5759 30368	5780 09537
4	(11)	4.7458 32100	(11) 4.7687 44947	(11) 4.7917 40642	(11) 4.8148 19443
5	(14)	3.9390 40643	(14) 3.9628 27051	(14) 3.9867 28231	(14) 4.0107 44596
6	(17)	3.2694 03734	(17) 3.2931 09279	(17) 3.3169 57888	(17) 3.3409 50249
7	(20)	2.7136 05099	(20) 2.7365 73811	(20) 2.7597 08963	(20) 2.7830 11557
8	(23)	2.2522 92253	(23) 2.2740 92837	(23) 2.2960 77857	(23) 2.3182 48627
9	(26)	1.8694 02532	(26) 1.8897 71148	(26) 1.9103 36777	(26) 1.9311 01106
10	(29)	1.5516 04119	(29) 1.5703 99824	(29) 1.5894 00198	(29) 1.6086 07222
24	(70)	1.1425 47375	(70) 1.1760 46709	(70) 1.2104 86167	(70) 1.2458 90957
1/2	(1)	2.8809 72058	(1) 2.8827 07061	(1) 2.8844 41020	(1) 2.8861 73938
1/3		9.3977 96375	9.4015 69076	9.4053 38751	9.4091 05407
1/4		5.3674 68731	5.3690 84709	5.3706 99229	5.3723 12294
1/5		3.8354 43756	3.8363 67514	3.8372 90383	3.8382 12366
1		835	836	837	838
2		6 97225	6 98896	7 00569	7 02244
3		5821 82875	5842 77056	5863 76253	5884 80472
4	(11)	4.8612 27006	(11) 4.8845 56188	(11) 4.9079 69238	(11) 4.9314 66355
5	(14)	4.0591 24550	(14) 4.0834 88973	(14) 4.1079 70252	(14) 4.1325 68806
6	(17)	3.3893 68999	(17) 3.4137 96782	(17) 3.4383 71101	(17) 3.4630 92659
7	(20)	2.8301 23115	(20) 2.8539 34109	(20) 2.8779 16611	(20) 2.9020 71648
8	(23)	2.3631 52801	(23) 2.3858 88916	(23) 2.4088 16204	(23) 2.4319 36041
9	(26)	1.9732 32589	(26) 1.9946 31333	(26) 2.0161 79163	(26) 2.0379 62403
10	(29)	1.6476 49211	(29) 1.6674 88220	(29) 1.6875 41959	(29) 1.7078 12493
24	(70)	1.3197 00592	(70) 1.3581 59133	(70) 1.3976 90431	(70) 1.4383 23072
1/2	(1)	2.8896 36655	(1) 2.8913 66459	(1) 2.8930 95228	(1) 2.8948 22965
1/3		9.4166 29685	9.4203 87319	9.4241 41957	9.4278 93606
1/4		5.3755 34071	5.3771 42790	5.3787 50067	5.3803 55904
1/5		3.8400 53677	3.8409 73010	3.8418 91464	3.8428 09040
1		840	841	842	843
2		7 05600	7 07281	7 08964	7 10649
3		5927 04000	5948 23321	5969 47688	5990 77107
4	(11)	4.9787 13600	(11) 5.0024 64130	(11) 5.0262 99533	(11) 5.0502 20012
5	(14)	4.1821 19424	(14) 4.2070 72333	(14) 4.2321 44207	(14) 4.2573 35470
6	(17)	3.5129 80316	(17) 3.5381 47832	(17) 3.5634 65422	(17) 3.5889 33801
7	(20)	2.9509 03466	(20) 2.9755 82327	(20) 3.0004 37885	(20) 3.0254 71195
8	(23)	2.4787 58911	(23) 2.5024 64737	(23) 2.5263 68700	(23) 2.5504 72217
9	(26)	2.0821 57485	(26) 2.1045 72844	(26) 2.1272 02445	(26) 2.1500 48079
10	(29)	1.7490 12288	(29) 1.7699 45762	(29) 1.7911 04459	(29) 1.8124 90531
24	(70)	1.5230 10388	(70) 1.5671 25939	(70) 1.6124 64626	(70) 1.6590 58848
1/2	(1)	2.8982 75349	(1) 2.9000 00000	(1) 2.9017 23626	(1) 2.9034 46228
1/3		9.4353 87961	9.4391 30677	9.4428 70428	9.4466 07220
1/4		5.3835 63271	5.3851 64807	5.3867 64916	5.3883 63600
1/5		3.8446 41568	3.8455 56523	3.8464 70609	3.8473 83826
1		845	846	847	848
2		7 14025	7 15716	7 17409	7 19104
3		6033 51125	6054 95736	6076 45423	6098 00192
4	(11)	5.0983 17006	(11) 5.1224 93927	(11) 5.1467 56733	(11) 5.1711 05628
5	(14)	4.3080 77870	(14) 4.3336 29862	(14) 4.3593 02953	(14) 4.3850 97573
6	(17)	3.6403 25800	(17) 3.6662 50863	(17) 3.6923 29601	(17) 3.7185 62742
7	(20)	3.0760 75301	(20) 3.1016 48230	(20) 3.1274 03172	(20) 3.1533 41205
8	(23)	2.5992 83630	(23) 2.6239 94403	(23) 2.6489 10487	(23) 2.6740 33342
9	(26)	2.1963 94667	(26) 2.2198 99265	(26) 2.2436 27182	(26) 2.2675 80274
10	(29)	1.8559 53494	(29) 1.8780 34778	(29) 1.9003 52223	(29) 1.9229 08072
24	(70)	1.7561 47601	(70) 1.8067 11101	(70) 1.8586 68111	(70) 1.9120 55324
1/2	(1)	2.9068 88371	(1) 2.9086 07914	(1) 2.9103 26442	(1) 2.9120 43956
1/3		9.4540 71946	9.4577 99893	9.4615 24903	9.4652 46982
1/4		5.3915 56705	5.3931 51133	5.3947 44148	5.3963 35753
1/5		3.8492 07664	3.8501 18288	3.8510 28051	3.8519 36956

$$n^2 \left[\begin{matrix} (-6)1 \\ 3 \end{matrix} \right] \quad n^3 \left[\begin{matrix} (-7)4 \\ 3 \end{matrix} \right] \quad n^4 \left[\begin{matrix} (-7)2 \\ 3 \end{matrix} \right] \quad n^5 \left[\begin{matrix} (-7)1 \\ 3 \end{matrix} \right]$$

Table 3.1 POWERS AND ROOTS n^k

k	850	851	852	853	854
1					
2	7 22500	7 24201	7 25904	7 27609	7 29316
3	6141 25000	6162 95051	6184 70208	6206 50477	6228 35864
4	(11) 5.2200 62500	(11) 5.2446 70884	(11) 5.2693 66172	(11) 5.2941 48569	(11) 5.3190 18279
5	(14) 4.4370 53125	(14) 4.4632 14922	(14) 4.4894 99979	(14) 4.5159 08729	(14) 4.5424 41610
6	(17) 3.7714 95156	(17) 3.7981 95899	(17) 3.8250 53982	(17) 3.8520 70146	(17) 3.8792 45135
7	(20) 3.2057 70883	(20) 3.2322 64710	(20) 3.2589 45993	(20) 3.2858 15835	(20) 3.3128 75345
8	(23) 2.7249 05250	(23) 2.7506 57268	(23) 2.7766 21986	(23) 2.8028 00907	(23) 2.8291 95545
9	(26) 2.3161 69463	(26) 2.3408 09335	(26) 2.3656 81932	(26) 2.3907 89174	(26) 2.4161 32995
10	(29) 1.9687 44043	(29) 1.9920 28744	(29) 2.0155 61006	(29) 2.0393 43165	(29) 2.0633 77578
24	(70) 2.0232 71747	(70) 2.0811 79034	(70) 2.1406 72719	(70) 2.2017 94325	(70) 2.2645 86409
1/2	(1) 2.9154 75947	(1) 2.9171 90429	(1) 2.9189 03904	(1) 2.9206 16373	(1) 2.9223 27839
1/3	9.4726 82372	9.4763 95693	9.4801 06107	9.4838 13619	9.4875 18234
1/4	5.3995 14744	5.4011 02137	5.4026 88131	5.4042 72729	5.4058 55935
1/5	3.8537 52195	3.8546 58534	3.8555 64021	3.8564 68659	3.8573 72448
1					
2	7 31025	7 32736	7 34449	7 36164	7 37881
3	6250 26375	6272 22016	6294 22793	6316 28712	6338 39779
4	(11) 5.3439 75506	(11) 5.3690 20457	(11) 5.3941 53336	(11) 5.4193 74349	(11) 5.4446 83702
5	(14) 4.5690 99058	(14) 4.5958 81511	(14) 4.6227 89409	(14) 4.6498 23191	(14) 4.6769 83300
6	(17) 3.9065 79694	(17) 3.9340 74574	(17) 3.9617 30523	(17) 3.9895 48298	(17) 4.0175 28654
7	(20) 3.3401 25639	(20) 3.3675 67835	(20) 3.3952 03059	(20) 3.4230 32440	(20) 3.4510 57114
8	(23) 2.8558 07421	(23) 2.8826 38067	(23) 2.9096 89021	(23) 2.9369 61833	(23) 2.9644 58061
9	(26) 2.4417 15345	(26) 2.4675 38185	(26) 2.4936 03491	(26) 2.5199 13253	(26) 2.5464 69474
10	(29) 2.0876 66620	(29) 2.1122 12686	(29) 2.1370 18192	(29) 2.1620 85571	(29) 2.1874 17279
24	(70) 2.3290 92589	(70) 2.3953 57569	(70) 2.4634 27165	(70) 2.5333 48329	(70) 2.6051 69182
1/2	(1) 2.9240 38303	(1) 2.9257 47768	(1) 2.9274 56234	(1) 2.9291 63703	(1) 2.9308 70178
1/3	9.4912 19958	9.4949 18797	9.4986 14756	9.5023 07842	9.5059 98059
1/4	5.4074 37751	5.4090 18180	5.4105 97225	5.4121 74889	5.4137 51174
1/5	3.8582 75391	3.8591 77490	3.8600 78746	3.8609 79161	3.8618 78737
1					
2	7 39600	7 41321	7 43044	7 44769	7 46496
3	6360 56000	6382 77381	6405 03928	6427 35647	6449 72544
4	(11) 5.4700 81600	(11) 5.4955 68250	(11) 5.5211 43859	(11) 5.5468 08634	(11) 5.5725 62780
5	(14) 4.7042 70176	(14) 4.7316 84264	(14) 4.7592 26007	(14) 4.7868 95851	(14) 4.8146 94242
6	(17) 4.0456 72351	(17) 4.0739 80151	(17) 4.1024 52818	(17) 4.1310 91119	(17) 4.1598 95825
7	(20) 3.4792 78222	(20) 3.5076 96910	(20) 3.5363 14329	(20) 3.5651 31636	(20) 3.5941 49993
8	(23) 2.9921 79271	(23) 3.0201 27039	(23) 3.0483 02952	(23) 3.0767 08602	(23) 3.1053 45594
9	(26) 2.5732 74173	(26) 2.6003 29381	(26) 2.6276 37144	(26) 2.6551 99523	(26) 2.6830 18593
10	(29) 2.2130 15789	(29) 2.2388 83597	(29) 2.2650 23218	(29) 2.2914 37189	(29) 2.3181 28064
24	(70) 2.6789 39031	(70) 2.7547 08410	(70) 2.8325 29097	(70) 2.9124 54150	(70) 2.9945 37938
1/2	(1) 2.9325 75660	(1) 2.9342 80150	(1) 2.9359 83651	(1) 2.9376 86164	(1) 2.9393 87691
1/3	9.5096 85413	9.5133 69910	9.5170 51555	9.5207 30354	9.5244 06312
1/4	5.4153 26084	5.4168 99621	5.4184 71787	5.4200 42587	5.4216 12022
1/5	3.8627 77475	3.8636 75378	3.8645 72447	3.8654 68684	3.8663 64090
1					
2	7 48225	7 49956	7 51689	7 53424	7 55161
3	6472 14625	6494 61896	6517 14363	6539 72032	6562 34909
4	(11) 5.5984 06506	(11) 5.6243 40019	(11) 5.6503 63527	(11) 5.6764 77238	(11) 5.7026 81359
5	(14) 4.8426 21628	(14) 4.8706 78457	(14) 4.8988 65178	(14) 4.9271 82242	(14) 4.9556 30101
6	(17) 4.1888 67708	(17) 4.2180 07544	(17) 4.2473 16109	(17) 4.2767 94186	(17) 4.3064 42558
7	(20) 3.6233 70568	(20) 3.6527 94533	(20) 3.6824 23067	(20) 3.7122 57354	(20) 3.7422 98583
8	(23) 3.1342 15541	(23) 3.1633 20065	(23) 3.1926 60799	(23) 3.2222 39383	(23) 3.2520 57468
9	(26) 2.7110 96443	(26) 2.7394 35177	(26) 2.7680 36913	(26) 2.7969 03785	(26) 2.8260 37940
10	(29) 2.3450 98423	(29) 2.3723 50863	(29) 2.3998 88003	(29) 2.4277 12485	(29) 2.4558 26970
24	(70) 3.0788 36164	(70) 3.1654 05907	(70) 3.2543 05644	(70) 3.3455 95291	(70) 3.4393 36231
1/2	(1) 2.9410 88234	(1) 2.9427 87794	(1) 2.9444 86373	(1) 2.9461 83973	(1) 2.9478 80595
1/3	9.5280 79435	9.5317 49727	9.5354 17196	9.5390 81845	9.5427 43681
1/4	5.4231 80095	5.4247 46809	5.4263 12167	5.4278 76171	5.4294 38824
1/5	3.8672 58668	3.8681 52418	3.8690 45344	3.8699 37445	3.8708 28725
1					
2	7 56900	7 58641	7 60384	7 62129	7 63876
3	6585 03000	6607 76311	6630 54848	6653 38617	6676 27624
4	(11) 5.7289 76100	(11) 5.7553 61669	(11) 5.7818 38275	(11) 5.8084 06126	(11) 5.8350 65434
5	(14) 4.9842 09207	(14) 5.0129 20014	(14) 5.0417 62975	(14) 5.0707 38548	(14) 5.0998 47189
6	(17) 4.3362 62010	(17) 4.3662 53332	(17) 4.3964 17315	(17) 4.4267 54753	(17) 4.4572 66443
7	(20) 3.7725 47949	(20) 3.8030 06652	(20) 3.8336 75898	(20) 3.8645 56899	(20) 3.8956 50871
8	(23) 3.2821 16715	(23) 3.3124 18794	(23) 3.3429 65383	(23) 3.3737 58173	(23) 3.4047 98862
9	(26) 2.8554 41542	(26) 2.8851 16769	(26) 2.9150 65814	(26) 2.9452 90885	(26) 2.9757 94205
10	(29) 2.4842 34142	(29) 2.5129 36706	(29) 2.5419 37390	(29) 2.5712 38943	(29) 2.6008 44135
24	(70) 3.5355 91351	(70) 3.6344 25075	(70) 3.7359 03403	(70) 3.8400 93943	(70) 3.9470 65953
1/2	(1) 2.9495 76241	(1) 2.9512 70913	(1) 2.9529 64612	(1) 2.9546 57341	(1) 2.9563 49100
1/3	9.5464 02709	9.5500 58934	9.5537 12362	9.5573 62998	9.5610 10846
1/4	5.4310 00130	5.4325 60090	5.4341 18707	5.4356 75984	5.4372 31924
1/5	3.8717 19185	3.8726 08827	3.8734 97651	3.8743 85661	3.8752 72857

$$n^{\frac{1}{2}} \left[\begin{matrix} (-6) \\ 3 \end{matrix} \right]$$

$$n^{\frac{1}{3}} \left[\begin{matrix} (-7) \\ 3 \end{matrix} \right]$$

$$n^{\frac{1}{4}} \left[\begin{matrix} (-7) \\ 3 \end{matrix} \right]$$

$$n^{\frac{1}{5}} \left[\begin{matrix} (-7) \\ 3 \end{matrix} \right]$$

POWERS AND ROOTS n^k

Table 3.1

k					
1		875	876	877	878
2		7 65625	7 67376	7 69129	7 70884
3		6699 21875	6722 21376	6745 26133	6768 36152
4	(11)	5.8618 16406	5.8886 59254	5.9155 94186	5.9426 21415
5	(14)	5.1290 89355	5.1584 65506	5.1879 76101	5.2176 21602
6	(17)	4.4879 53186	4.5188 15784	4.5498 55041	4.5810 71767
7	(20)	3.9269 59038	3.9584 82626	3.9902 22871	4.0221 81011
8	(23)	3.4360 89158	3.4676 30781	3.4994 25458	3.5314 74928
9	(26)	3.0065 78013	3.0376 44564	3.0689 96127	3.1006 34987
10	(29)	2.6307 55762	2.6609 76638	2.6915 09603	2.7223 57518
24	(70)	4.0568 90376	4.1696 39882	4.2853 88904	4.4042 13682
1/2	(1)	2.9580 39892	2.9597 29717	2.9614 18579	2.9631 06478
1/3		9.5646 55914	9.5682 98205	9.5719 37725	9.5755 74480
1/4		5.4387 86530	5.4403 39803	5.4418 91747	5.4434 42365
1/5		3.8761 59242	3.8770 44816	3.8779 29583	3.8788 13542
1		880	881	882	883
2		7 74400	7 76161	7 77924	7 79689
3		6814 72000	6837 97841	6861 28968	6884 65387
4	(11)	5.9969 53600	6.0242 58979	6.0516 57498	6.0791 49367
5	(14)	5.2773 19168	5.3073 72161	5.3375 61913	5.3678 88891
6	(17)	4.6440 40868	4.6757 94874	4.7077 29607	4.7398 45891
7	(20)	4.0867 55964	4.1193 75284	4.1522 17514	4.1852 83922
8	(23)	3.5963 45248	3.6291 69625	3.6622 55847	3.6956 05703
9	(26)	3.1647 83818	3.1972 98440	3.2301 09657	3.2632 19836
10	(29)	2.7850 09760	2.8168 19925	2.8489 56718	2.8814 23115
24	(70)	4.6514 04745	4.7799 32920	4.9118 60716	5.0472 74047
1/2	(1)	2.9664 79395	2.9681 64416	2.9698 48481	2.9715 31592
1/3		9.5828 39714	9.5864 68204	9.5900 93948	9.5937 16954
1/4		5.4465 39631	5.4480 86284	5.4496 31621	5.4511 75645
1/5		3.8805 79047	3.8814 60596	3.8823 41346	3.8832 21296
1		885	886	887	888
2		7 83225	7 84996	7 86769	7 88544
3		6931 54125	6955 06456	6978 64103	7002 27072
4	(11)	6.1344 14006	6.1621 87200	6.1900 54594	6.2180 16399
5	(14)	5.4289 56396	5.4596 97859	5.4905 78425	5.5215 98563
6	(17)	4.8046 26410	4.8372 92303	4.8701 43063	4.9031 79524
7	(20)	4.2520 94373	4.2858 40981	4.3198 16896	4.3540 23417
8	(23)	3.7631 03520	3.7972 55109	3.8316 77587	3.8663 72794
9	(26)	3.3303 46615	3.3643 68027	3.3986 98020	3.4333 39041
10	(29)	2.9473 56754	2.9808 30072	2.9146 45144	2.9308 05069
24	(70)	5.3289 11365	5.4753 17719	5.6255 74442	5.7797 78281
1/2	(1)	2.9748 94956	2.9765 75213	2.9782 54522	2.9799 32885
1/3		9.6009 54766	9.6045 69584	9.6081 81682	9.6117 91067
1/4		5.4542 59763	5.4557 99862	5.4573 38658	5.4588 76153
1/5		3.8849 78808	3.8858 56373	3.8867 33146	3.8876 09128
1		890	891	892	893
2		7 92100	7 93881	7 95664	7 97449
3		7049 69000	7073 47971	7097 32288	7121 21957
4	(11)	6.2742 24100	6.3024 70422	6.3308 12009	6.3592 49076
5	(14)	5.5840 59449	5.6155 01146	5.6470 84312	5.6788 09425
6	(17)	4.9698 12910	4.9993 11521	5.0371 99206	5.0711 76816
7	(20)	4.4231 33490	4.4580 39665	4.4931 81692	4.5285 60897
8	(23)	3.9365 88806	3.9721 13342	4.0079 18069	4.0440 04881
9	(26)	3.5035 64037	3.5391 52987	3.5750 62918	3.6112 96359
10	(29)	3.1181 71993	3.1533 85312	3.1889 56123	3.2248 87648
24	(70)	6.1004 25945	6.2670 75070	6.4380 82017	6.6135 55666
1/2	(1)	2.9832 86778	2.9849 62311	2.9866 36905	2.9883 10559
1/3		9.6190 01716	9.6226 02990	9.6262 01570	9.6297 97462
1/4		5.4619 47252	5.4634 80860	5.4650 13179	5.4665 44210
1/5		3.8893 58728	3.8902 32348	3.8911 05185	3.8919 77239
1		895	896	897	898
2		8 01025	8 02816	8 04609	8 06404
3		7169 17375	7193 23136	7217 34273	7241 50792
4	(11)	6.4164 10506	6.4451 35299	6.4739 56429	6.5028 74112
5	(14)	5.7426 87403	5.7748 41228	5.8071 38917	5.8395 80953
6	(17)	5.1397 05226	5.1742 57740	5.2090 03608	5.2439 43696
7	(20)	4.6000 36177	4.6361 34935	4.6724 76237	4.7090 61439
8	(23)	4.1170 32378	4.1539 76902	4.1912 11184	4.2287 37172
9	(26)	3.6847 43979	3.7219 63304	3.7595 16432	3.7974 05980
10	(29)	3.2978 45861	3.3348 79120	3.3722 86240	3.4100 70570
24	(70)	6.9783 51604	7.1679 04854	7.3623 86846	7.5619 20026
1/2	(1)	2.9916 55060	2.9933 25909	2.9949 95826	2.9966 64813
1/3		9.6369 81200	9.6405 69057	9.6441 54244	9.6477 36769
1/4		5.4696 02417	5.4711 29599	5.4726 55504	5.4741 80133
1/5		3.8937 19006	3.8945 88722	3.8954 57662	3.8963 25828
		$n^2 \left[\begin{smallmatrix} (-6) \\ 3 \end{smallmatrix} \right]$	$n^3 \left[\begin{smallmatrix} (-7) \\ 3 \end{smallmatrix} \right]$	$n^4 \left[\begin{smallmatrix} (-7) \\ 3 \end{smallmatrix} \right]$	$n^5 \left[\begin{smallmatrix} (-7) \\ 3 \end{smallmatrix} \right]$
1		899	899	899	899
2		7 99236	7 99236	7 99236	7 99236
3		7145 16984	7145 16984	7145 16984	7145 16984
4	(11)	6.3877 81837	6.3877 81837	6.3877 81837	6.3877 81837
5	(14)	5.7056 76962	5.7056 76962	5.7056 76962	5.7056 76962
6	(17)	5.1053 45204	5.1053 45204	5.1053 45204	5.1053 45204
7	(20)	4.5641 78613	4.5641 78613	4.5641 78613	4.5641 78613
8	(23)	4.0803 75680	4.0803 75680	4.0803 75680	4.0803 75680
9	(26)	3.6478 55858	3.6478 55858	3.6478 55858	3.6478 55858
10	(29)	3.2611 83137	3.2611 83137	3.2611 83137	3.2611 83137
24	(70)	6.7936 07487	6.7936 07487	6.7936 07487	6.7936 07487
1/2	(1)	2.9899 83278	2.9899 83278	2.9899 83278	2.9899 83278
1/3		9.6333 90671	9.6333 90671	9.6333 90671	9.6333 90671
1/4		5.4680 73955	5.4680 73955	5.4680 73955	5.4680 73955
1/5		3.8928 48512	3.8928 48512	3.8928 48512	3.8928 48512

Table 3.1 POWERS AND ROOTS n^k

k	900	901	902	903	904
1					
2	8 10000	8 11801	8 13604	8 15409	8 17216
3	7290 00000	7314 32701	7338 70808	7363 14327	7387 63264
4	(11) 6.5610 00000	(11) 6.5902 08636	(11) 6.6195 14688	(11) 6.6489 18373	(11) 6.6784 19907
5	(14) 5.9049 00000	(14) 5.9377 77981	(14) 5.9708 02249	(14) 6.0039 73291	(14) 6.0372 91596
6	(17) 5.3144 10000	(17) 5.3499 37961	(17) 5.3856 63628	(17) 5.4215 87881	(17) 5.4577 11602
7	(20) 4.7829 69000	(20) 4.8202 94103	(20) 4.8578 68593	(20) 4.8956 93857	(20) 4.9337 71289
8	(23) 4.3046 72100	(23) 4.3430 84987	(23) 4.3817 97471	(23) 4.4208 11553	(23) 4.4601 29245
9	(26) 3.8742 04890	(26) 3.9131 19573	(26) 3.9523 81319	(26) 3.9919 92832	(26) 4.0319 56837
10	(29) 3.4867 84401	(29) 3.5257 20735	(29) 3.5650 47949	(29) 3.6047 69527	(29) 3.6448 88981
24	(70) 7.9766 44308	(70) 8.1920 95066	(70) 8.4131 16465	(70) 8.6398 46120	(70) 8.8724 24888
1/2	(1) 3.0000 00000	(1) 3.0016 66204	(1) 3.0033 31484	(1) 3.0049 95840	(1) 3.0066 59276
1/3	9.6548 93846	9.6584 68409	9.6620 40328	9.6656 09608	9.6691 76254
1/4	5.4772 25575	5.4787 46393	5.4802 65946	5.4817 84235	5.4833 01264
1/5	3.8980 59841	3.8989 25692	3.8997 90774	3.9006 55089	3.9015 18640
1					
2	8 19025	8 20836	8 22649	8 24464	8 26281
3	7412 17625	7436 77416	7461 42643	7486 13312	7510 89429
4	(11) 6.7080 19506	(11) 6.7377 17389	(11) 6.7675 13772	(11) 6.7974 08873	(11) 6.8274 02910
5	(14) 6.0707 57653	(14) 6.1043 71954	(14) 6.1381 34991	(14) 6.1720 47257	(14) 6.2061 09245
6	(17) 5.4940 35676	(17) 5.5305 60991	(17) 5.5672 88437	(17) 5.6042 18909	(17) 5.6413 53304
7	(20) 4.9721 02287	(20) 5.0106 88258	(20) 5.0495 30612	(20) 5.0886 30769	(20) 5.1279 90153
8	(23) 4.4997 52570	(23) 4.5396 83561	(23) 4.5799 24265	(23) 4.6204 76739	(23) 4.6613 43049
9	(26) 4.0722 76076	(26) 4.1129 53307	(26) 4.1539 91309	(26) 4.1953 92879	(26) 4.2371 60832
10	(29) 3.6854 09848	(29) 3.7263 35696	(29) 3.7676 70117	(29) 3.8094 16734	(29) 3.8515 79196
24	(70) 9.1109 96943	(70) 9.3557 09844	(70) 9.6067 14616	(70) 9.8641 65825	(71) 1.0128 22166
1/2	(1) 3.0083 21791	(1) 3.0099 83389	(1) 3.0116 44069	(1) 3.0133 03835	(1) 3.0149 62686
1/3	9.6727 40271	9.6763 01663	9.6798 60436	9.6834 16593	9.6869 70141
1/4	5.4848 17035	5.4863 31551	5.4878 44813	5.4893 56824	5.4908 67587
1/5	3.9023 81426	3.9032 43449	3.9041 04712	3.9049 65216	3.9058 24962
1					
2	8 28100	8 29921	8 31744	8 33569	8 35396
3	7535 71000	7560 58031	7585 50528	7610 48497	7635 51944
4	(11) 6.8574 96100	(11) 6.8876 88662	(11) 6.9179 80815	(11) 6.9483 72778	(11) 6.9788 64768
5	(14) 6.2403 21451	(14) 6.2746 84371	(14) 6.3091 98504	(14) 6.3438 64346	(14) 6.3786 82398
6	(17) 5.6786 92576	(17) 5.7162 37462	(17) 5.7539 89035	(17) 5.7919 48148	(17) 5.8301 15712
7	(20) 5.1676 10194	(20) 5.2074 92328	(20) 5.2476 38000	(20) 5.2880 48659	(20) 5.3287 25761
8	(23) 4.7025 25276	(23) 4.7440 25511	(23) 4.7858 45856	(23) 4.8279 88426	(23) 4.8704 55345
9	(26) 4.2792 98001	(26) 4.3218 07241	(26) 4.3646 91421	(26) 4.4079 53433	(26) 4.4515 96186
10	(29) 3.8941 61181	(29) 3.9371 66396	(29) 3.9805 98576	(29) 4.0244 61484	(29) 4.0687 58914
24	(71) 1.0399 04400	(71) 1.0676 79852	(71) 1.0961 65476	(71) 1.1253 78622	(71) 1.1553 37042
1/2	(1) 3.0166 20626	(1) 3.0182 77655	(1) 3.0199 33774	(1) 3.0215 88986	(1) 3.0232 43292
1/3	9.6905 21083	9.6940 69425	9.6976 15172	9.7011 58327	9.7046 98896
1/4	5.4923 77104	5.4938 85378	5.4953 92410	5.4968 98203	5.4984 02760
1/5	3.9066 83951	3.9075 42186	3.9083 99668	3.9092 56397	3.9101 12376
1					
2	8 37225	8 39056	8 40889	8 42724	8 44561
3	7660 60875	7685 75296	7710 95213	7736 20632	7761 51559
4	(11) 7.0094 57006	(11) 7.0401 49711	(11) 7.0709 43103	(11) 7.1018 37402	(11) 7.1328 32827
5	(14) 6.4136 53161	(14) 6.4487 77136	(14) 6.4840 54826	(14) 6.5194 86735	(14) 6.5550 73368
6	(17) 5.8684 92642	(17) 5.9070 79856	(17) 5.9458 78275	(17) 5.9848 88823	(17) 6.0241 12425
7	(20) 5.3696 70767	(20) 5.4108 85148	(20) 5.4523 70378	(20) 5.4941 27939	(20) 5.5361 59319
8	(23) 4.9132 48752	(23) 4.9563 70796	(23) 4.9998 23637	(23) 5.0436 09448	(23) 5.0877 30414
9	(26) 4.4956 22608	(26) 4.5400 35649	(26) 4.5848 38275	(26) 4.6300 33473	(26) 4.6756 24251
10	(29) 4.1134 94687	(29) 4.1586 72654	(29) 4.2042 96698	(29) 4.2503 70729	(29) 4.2968 98686
24	(71) 1.1860 58902	(71) 1.2175 62793	(71) 1.2498 67732	(71) 1.2829 93183	(71) 1.3169 59057
1/2	(1) 3.0248 96692	(1) 3.0265 49190	(1) 3.0282 00786	(1) 3.0298 51482	(1) 3.0315 01278
1/3	9.7082 36884	9.7117 72294	9.7153 05133	9.7188 35404	9.7223 63112
1/4	5.4999 06083	5.5014 08174	5.5029 09036	5.5044 08671	5.5059 07081
1/5	3.9109 67606	3.9118 22089	3.9126 75826	3.9135 28819	3.9143 81068
1					
2	8 46400	8 48241	8 50084	8 51929	8 53776
3	7786 88000	7812 29961	7837 77448	7863 30467	7888 89024
4	(11) 7.1639 29600	(11) 7.1951 27941	(11) 7.2264 28071	(11) 7.2578 30210	(11) 7.2893 34582
5	(14) 6.5908 15232	(14) 6.6267 12833	(14) 6.6627 66681	(14) 6.6989 77284	(14) 6.7353 45154
6	(17) 6.0635 50013	(17) 6.1032 02520	(17) 6.1430 70880	(17) 6.1831 56033	(17) 6.2234 58922
7	(20) 5.5784 66012	(20) 5.6210 49521	(20) 5.6639 11351	(20) 5.7070 53019	(20) 5.7504 76044
8	(23) 5.1321 88731	(23) 5.1769 86608	(23) 5.2221 26266	(23) 5.2676 09936	(23) 5.3134 39864
9	(26) 4.7216 13633	(26) 4.7680 04666	(26) 4.8148 00417	(26) 4.8620 03971	(26) 4.9096 18435
10	(29) 4.3438 84542	(29) 4.3913 32298	(29) 4.4392 45985	(29) 4.4876 29665	(29) 4.5364 87434
24	(71) 1.3517 85726	(71) 1.3874 94035	(71) 1.4241 05308	(71) 1.4616 41363	(71) 1.5001 24518
1/2	(1) 3.0331 50178	(1) 3.0347 98181	(1) 3.0364 45290	(1) 3.0380 91506	(1) 3.0397 36831
1/3	9.7258 88262	9.7294 10859	9.7329 30906	9.7364 48410	9.7399 63373
1/4	5.5074 04268	5.5089 00236	5.5103 94986	5.5118 88520	5.5133 80842
1/5	3.9152 32576	3.9160 83344	3.9169 33373	3.9177 82664	3.9186 31220

$$n^2 \begin{bmatrix} (-6) 1 \\ 3 \end{bmatrix}$$

$$n^3 \begin{bmatrix} (-7) 3 \\ 3 \end{bmatrix}$$

$$n^4 \begin{bmatrix} (-7) 2 \\ 3 \end{bmatrix}$$

$$n^5 \begin{bmatrix} (-7) 1 \\ 3 \end{bmatrix}$$

Table 3.1 POWERS AND ROOTS n^k

k	950	951	952	953	954
1					
2	9 02500	9 04401	9 06304	9 08209	9 10116
3	8573 75000	8600 85351	8628 01408	8655 23177	8682 50664
4	(11) 8. 1450 62500	(11) 8. 1794 11688	(11) 8. 2138 69404	(11) 8. 2484 35877	(11) 8. 2831 11335
5	(14) 7. 7378 09375	(14) 7. 7786 20515	(14) 7. 8196 03673	(14) 7. 8607 59391	(14) 7. 9020 88213
6	(17) 7. 3509 18906	(17) 7. 3974 68110	(17) 7. 4442 62696	(17) 7. 4913 03699	(17) 7. 5385 92155
7	(20) 6. 9833 72961	(20) 7. 0349 92173	(20) 7. 0869 38087	(20) 7. 1392 12425	(20) 7. 1918 16916
8	(23) 6. 6342 04313	(23) 6. 6902 77556	(23) 6. 7467 65059	(23) 6. 8036 69441	(23) 6. 8609 93338
9	(26) 6. 3024 94097	(26) 6. 3624 53956	(26) 6. 4229 20336	(26) 6. 4838 96978	(26) 6. 5453 87645
10	(29) 5. 9873 69392	(29) 6. 0506 93712	(29) 6. 1146 20160	(29) 6. 1791 53820	(29) 6. 2442 99813
24	(71) 2. 9198 90243	(71) 2. 9945 55775	(71) 3. 0710 49109	(71) 3. 1494 12996	(71) 3. 2296 91146
1/2	(1) 3. 0822 07001	(1) 3. 0838 28789	(1) 3. 0854 49724	(1) 3. 0870 69808	(1) 3. 0886 89042
1/3	9. 8304 75725	9. 8339 23805	9. 8373 69469	9. 8408 12721	9. 8442 53565
1/4	5. 5517 62784	5. 5532 23198	5. 5546 82461	5. 5561 40574	5. 5575 97541
1/5	3. 9404 40019	3. 9412 69236	3. 9420 97756	3. 9429 25580	3. 9437 52709
1					
2	9 12025	9 13936	9 15849	9 17764	9 19681
3	8709 83875	8737 22816	8764 67493	8792 17912	8819 74079
4	(11) 8. 3178 96006	(11) 8. 3527 90121	(11) 8. 3877 93908	(11) 8. 4229 07597	(11) 8. 4581 31418
5	(14) 7. 9435 90686	(14) 7. 9852 67356	(14) 8. 0271 18770	(14) 8. 0691 45478	(14) 8. 1113 48029
6	(17) 7. 5861 29105	(17) 7. 6339 15592	(17) 7. 6819 52663	(17) 7. 7302 41368	(17) 7. 7787 82760
7	(20) 7. 2447 53295	(20) 7. 2980 23306	(20) 7. 3516 28698	(20) 7. 4055 71230	(20) 7. 4598 52667
8	(23) 6. 9187 39397	(23) 6. 9769 10280	(23) 7. 0355 08664	(23) 7. 0945 37239	(23) 7. 1539 98708
9	(26) 6. 6073 96124	(26) 6. 6699 26228	(26) 6. 7329 81792	(26) 6. 7965 66675	(26) 6. 8606 84761
10	(29) 6. 3100 63299	(29) 6. 3764 49474	(29) 6. 4434 63575	(29) 6. 5111 10874	(29) 6. 5793 96686
24	(71) 3. 3119 28238	(71) 3. 3961 69948	(71) 3. 4824 62966	(71) 3. 5708 55021	(71) 3. 6613 94899
1/2	(1) 3. 0903 07428	(1) 3. 0919 24967	(1) 3. 0935 41660	(1) 3. 0951 57508	(1) 3. 0967 72513
1/3	9. 8476 92005	9. 8511 28046	9. 8545 61691	9. 8579 92945	9. 8614 21813
1/4	5. 5590 53362	5. 5595 08040	5. 5619 61578	5. 5634 13977	5. 5648 65240
1/5	3. 9445 79145	3. 9454 04889	3. 9462 29943	3. 9470 54307	3. 9478 77983
1					
2	9 21600	9 23521	9 25444	9 27369	9 29296
3	8847 36000	8875 03681	8902 77128	8930 56347	8958 41344
4	(11) 8. 4934 65600	(11) 8. 5289 10374	(11) 8. 5644 65971	(11) 8. 6001 32622	(11) 8. 6359 10556
5	(14) 8. 1537 26976	(14) 8. 1962 82870	(14) 8. 2390 16264	(14) 8. 2819 27715	(14) 8. 3250 17776
6	(17) 7. 8275 77897	(17) 7. 8766 27838	(17) 7. 9259 33646	(17) 7. 9754 96389	(17) 8. 0253 17136
7	(20) 7. 5144 74781	(20) 7. 5694 39352	(20) 7. 6247 48168	(20) 7. 6804 03023	(20) 7. 7364 05719
8	(23) 7. 2138 95790	(23) 7. 2742 31217	(23) 7. 3350 07737	(23) 7. 3962 28111	(23) 7. 4578 95113
9	(26) 6. 9253 39958	(26) 6. 9905 36200	(26) 7. 0562 77443	(26) 7. 1225 67671	(26) 7. 1894 10889
10	(29) 6. 6483 26360	(29) 6. 7179 05288	(29) 6. 7881 38901	(29) 6. 8590 32667	(29) 6. 9305 92097
24	(71) 3. 7541 32467	(71) 3. 8491 18699	(71) 3. 9464 05693	(71) 4. 0460 46699	(71) 4. 1480 96142
1/2	(1) 3. 0983 86677	(1) 3. 1000 00000	(1) 3. 1016 12484	(1) 3. 1032 24130	(1) 3. 1048 34939
1/3	9. 8648 48297	9. 8682 72403	9. 8716 94135	9. 8751 13495	9. 8786 30490
1/4	5. 5663 15367	5. 5677 64363	5. 5692 12228	5. 5706 58964	5. 5721 04575
1/5	3. 9487 00972	3. 9495 23275	3. 9503 44894	3. 9511 65831	3. 9519 86085
1					
2	9 31225	9 33156	9 35089	9 37024	9 38961
3	8986 32125	9014 28696	9042 31063	9070 39232	9098 53209
4	(11) 8. 6718 00006	(11) 8. 7078 01203	(11) 8. 7439 14379	(11) 8. 7801 39766	(11) 8. 8164 77595
5	(14) 8. 3682 87006	(14) 8. 4117 35962	(14) 8. 4553 65205	(14) 8. 4991 75293	(14) 8. 5431 66790
6	(17) 8. 0753 96961	(17) 8. 1257 36940	(17) 8. 1763 38153	(17) 8. 2272 01684	(17) 8. 2783 28619
7	(20) 7. 7927 58067	(20) 7. 8494 61884	(20) 7. 9065 18994	(20) 7. 9639 31230	(20) 8. 0217 00432
8	(23) 7. 5200 11535	(23) 7. 5825 80180	(23) 7. 6456 03867	(23) 7. 7090 85431	(23) 7. 7730 27719
9	(26) 7. 2568 11131	(26) 7. 3247 72454	(26) 7. 3932 98939	(26) 7. 4623 94697	(26) 7. 5320 63859
10	(29) 7. 0028 22742	(29) 7. 0757 30190	(29) 7. 1493 20074	(29) 7. 2235 98067	(29) 7. 2985 69880
24	(71) 4. 2526 09649	(71) 4. 3596 44069	(71) 4. 4692 57504	(71) 4. 5815 09331	(71) 4. 6964 60232
1/2	(1) 3. 1064 44913	(1) 3. 1080 54054	(1) 3. 1096 62361	(1) 3. 1112 69837	(1) 3. 1128 76483
1/3	9. 8819 45122	9. 8853 57396	9. 8887 67316	9. 8921 74886	9. 8955 80110
1/4	5. 5735 49061	5. 5749 92425	5. 5764 34668	5. 5778 75794	5. 5793 15803
1/5	3. 9528 05659	3. 9536 24554	3. 9544 42771	3. 9552 60312	3. 9560 77177
1					
2	9 40900	9 42841	9 44784	9 46729	9 48676
3	9126 73000	9154 98611	9183 30048	9211 67317	9240 10424
4	(11) 8. 8529 28100	(11) 8. 8894 91513	(11) 8. 9261 68067	(11) 8. 9629 57994	(11) 8. 9998 61530
5	(14) 8. 5873 40257	(14) 8. 6316 96259	(14) 8. 6762 35361	(14) 8. 7209 58129	(14) 8. 7658 65130
6	(17) 8. 3297 20049	(17) 8. 3813 77067	(17) 8. 4333 00771	(17) 8. 4854 92259	(17) 8. 5379 52637
7	(20) 8. 0798 28448	(20) 8. 1383 17132	(20) 8. 1971 68349	(20) 8. 2563 83968	(20) 8. 3159 65868
8	(23) 7. 8374 33594	(23) 7. 9023 05936	(23) 7. 9676 47635	(23) 8. 0334 61601	(23) 8. 0997 50755
9	(26) 7. 6023 10587	(26) 7. 6731 39063	(26) 7. 7445 53501	(26) 7. 8165 58138	(26) 7. 8891 57236
10	(29) 7. 3742 41269	(29) 7. 4506 18031	(29) 7. 5277 06003	(29) 7. 6055 11068	(29) 7. 6840 39148
24	(71) 4. 8141 72219	(71) 4. 9347 08664	(71) 5. 0581 34323	(71) 5. 1845 15371	(71) 5. 3139 19427
1/2	(1) 3. 1144 82300	(1) 3. 1160 87290	(1) 3. 1176 91454	(1) 3. 1192 94792	(1) 3. 1208 97307
1/3	9. 8989 82992	9. 9023 83537	9. 9057 81747	9. 9091 77627	9. 9125 71181
1/4	5. 5807 54698	5. 5821 92482	5. 5836 29155	5. 5850 64719	5. 5864 99178
1/5	3. 9568 93368	3. 9577 08886	3. 9585 23732	3. 9593 37908	3. 9601 51415

$$n^2 \left[\begin{matrix} (-6) \\ 3 \end{matrix} \right] \quad n^3 \left[\begin{matrix} (-7) \\ 3 \end{matrix} \right] \quad n^4 \left[\begin{matrix} (-7) \\ 3 \end{matrix} \right] \quad n^5 \left[\begin{matrix} (-8) \\ 3 \end{matrix} \right]$$

ELEMENTARY ANALYTICAL METHODS

POWERS AND ROOTS n^k

Table 3.1

k					
1		975	976	977	978
2		9 50625	9 52576	9 54529	9 56484
3		9268 59375	9297 14176	9325 74833	9354 41352
4	(11) 9.0368 78906	(11) 9.0740 10358	(11) 9.1112 56118	(11) 9.1486 16423	(11) 9.1860 91505
5	(14) 8.8109 56934	(14) 8.8562 34109	(14) 8.9016 97228	(14) 8.9473 46861	(14) 8.9931 83583
6	(17) 8.5906 83010	(17) 8.6436 84491	(17) 8.6969 58191	(17) 8.7505 05230	(17) 8.8043 26728
7	(20) 8.3759 15935	(20) 8.4362 36063	(20) 8.4969 28153	(20) 8.5579 94115	(20) 8.6194 35867
8	(23) 8.1665 18037	(23) 8.2337 66397	(23) 8.3014 98806	(23) 8.3697 18245	(23) 8.4384 27713
9	(26) 7.9623 55086	(26) 8.0361 56004	(26) 8.1105 64333	(26) 8.1855 84443	(26) 8.2612 20731
10	(29) 7.7632 96209	(29) 7.8432 88260	(29) 7.9240 21353	(29) 8.0055 01586	(29) 8.0877 35096
24	(71) 5.4464 15584	(71) 5.5820 74443	(71) 5.7209 68141	(71) 5.8631 70383	(71) 6.0087 56477
1/2	(1) 3.1224 98999	(1) 3.1240 99870	(1) 3.1256 99922	(1) 3.1272 99154	(1) 3.1288 97569
1/3	9.9159 62413	9.9193 51328	9.9227 37928	9.9261 22218	9.9295 04202
1/4	5.5879 32533	5.5893 64785	5.5907 95938	5.5922 25992	5.5936 54950
1/5	3.9609 64254	3.9617 76427	3.9625 87934	3.9633 98776	3.9642 08956
1		980	981	982	983
2		9 60400	9 62361	9 64324	9 66289
3		9411 92000	9440 76141	9469 66168	9498 62087
4	(11) 9.2236 81600	(11) 9.2613 86943	(11) 9.2992 07770	(11) 9.3371. 44315	(11) 9.3751 96815
5	(14) 9.0392 07968	(14) 9.0854 20591	(14) 9.1318 22030	(14) 9.1784 12862	(14) 9.2251 93666
6	(17) 8.8584 23809	(17) 8.9127 97600	(17) 8.9674 49233	(17) 9.0223 79843	(17) 9.0775 90568
7	(20) 8.6812 55332	(20) 8.7434 54446	(20) 8.8060 35147	(20) 8.8689 99386	(20) 8.9323 49119
8	(23) 8.5076 30226	(23) 8.5773 28811	(23) 8.6475 26515	(23) 8.7182 26396	(23) 8.7894 31533
9	(26) 8.3374 77621	(26) 8.4143 59564	(26) 8.4918 71037	(26) 8.5700 16548	(26) 8.6488 00628
10	(29) 8.1707 28069	(29) 8.2544 86732	(29) 8.3390 17359	(29) 8.4243 26266	(29) 8.5104 19818
24	(71) 6.1578 03365	(71) 6.3103 89657	(71) 6.4665 95666	(71) 6.6265 03443	(71) 6.7901 96812
1/2	(1) 3.1304 95168	(1) 3.1320 91953	(1) 3.1336 87923	(1) 3.1352 83081	(1) 3.1368 77428
1/3	9.9328 83884	9.9362 61267	9.9396 36356	9.9430 09155	9.9463 79667
1/4	5.5950 82813	5.5965 09584	5.5979 35265	5.5993 59857	5.6007 83363
1/5	3.9650 18474	3.9658 27331	3.9666 35529	3.9674 43069	3.9682 49952
1		985	986	987	988
2		9 70225	9 72196	9 74169	9 76144
3		9556 71625	9585 85256	9615 04803	9644 30272
4	(11) 9.4133 65506	(11) 9.4516 50624	(11) 9.4900 52406	(11) 9.5285 71087	(11) 9.5672 06906
5	(14) 9.2721 65024	(14) 9.3193 27515	(14) 9.3666 81724	(14) 9.4142 28234	(14) 9.4619 67630
6	(17) 9.1330 82548	(17) 9.1888 56930	(17) 9.2449 14862	(17) 9.3012 57495	(17) 9.3578 85987
7	(20) 8.9960 86310	(20) 9.0602 12933	(20) 9.1247 30969	(20) 9.1896 42406	(20) 9.2549 49241
8	(23) 8.8611 45015	(23) 8.9333 69952	(23) 9.0061 09466	(23) 9.0793 66697	(23) 9.1531 44799
9	(26) 8.7282 27840	(26) 8.8083 02773	(26) 8.8890 30043	(26) 8.9704 14296	(26) 9.0524 60206
10	(29) 8.5973 04423	(29) 8.6849 86534	(29) 8.7734 72653	(29) 8.8627 69325	(29) 8.9528 83144
24	(71) 6.9577 61406	(71) 7.1292 84708	(71) 7.3048 56083	(71) 7.4845 66822	(71) 7.6685 10178
1/2	(1) 3.1384 70965	(1) 3.1400 63694	(1) 3.1416 55614	(1) 3.1432 46729	(1) 3.1448 37039
1/3	9.9497 47896	9.9531 13846	9.9564 77521	9.9598 38925	9.9631 98061
1/4	5.6022 05785	5.6036 27123	5.6050 47381	5.6064 66560	5.6078 84662
1/5	3.9690 56179	3.9698 61752	3.9706 66671	3.9714 70939	3.9722 74555
1		990	991	992	993
2		9 80100	9 82081	9 84064	9 86049
3		9702 99000	9732 42271	9761 91488	9791 46657
4	(11) 9.6059 60100	(11) 9.6448 30906	(11) 9.6838 19561	(11) 9.7229 26304	(11) 9.7621 51373
5	(14) 9.5099 00499	(14) 9.5580 27427	(14) 9.6063 49004	(14) 9.6548 65820	(14) 9.7035 78465
6	(17) 9.4148 01494	(17) 9.4720 05181	(17) 9.5294 98212	(17) 9.5872 81759	(17) 9.6453 56994
7	(20) 9.3206 53479	(20) 9.3867 57134	(20) 9.4532 62227	(20) 9.5201 70787	(20) 9.5874 84852
8	(23) 9.2274 46944	(23) 9.3022 76320	(23) 9.3776 36129	(23) 9.4535 29591	(23) 9.5299 59943
9	(26) 9.1351 72475	(26) 9.2185 55833	(26) 9.3026 15040	(26) 9.3873 54884	(26) 9.4727 80183
10	(29) 9.0438 20750	(29) 9.1355 88830	(29) 9.2281 94120	(29) 9.3216 43400	(29) 9.4159 43502
24	(71) 7.8567 81408	(71) 8.0494 77813	(71) 8.2466 98779	(71) 8.4485 45822	(71) 8.6551 22630
1/2	(1) 3.1464 26545	(1) 3.1480 15248	(1) 3.1496 03150	(1) 3.1511 90251	(1) 3.1527 76554
1/3	9.9665 54934	9.9699 09547	9.9732 61904	9.9766 12009	9.9799 59866
1/4	5.6093 01690	5.6107 17644	5.6121 32527	5.6135 46340	5.6149 59086
1/5	3.9730 77521	3.9738 79839	3.9746 81509	3.9754 82534	3.9762 82913
1		995	996	997	998
2		9 90025	9 92016	9 94009	9 96004
3		9850 74875	9880 47936	9910 26973	9940 11992
4	(11) 9.8014 95006	(11) 9.8409 57443	(11) 9.8805 38921	(11) 9.9203 39680	(11) 9.9600 59960
5	(14) 9.7524 87531	(14) 9.8015 93613	(14) 9.8508 97304	(14) 9.9002 99201	(14) 9.9500 99900
6	(17) 9.7037 25094	(17) 9.7623 87238	(17) 9.8213 44612	(17) 9.8805 98402	(17) 9.9401 49800
7	(20) 9.6552 06468	(20) 9.7233 37689	(20) 9.7918 80578	(20) 9.8608 37206	(20) 9.9302 09650
8	(23) 9.6069 30436	(23) 9.6844 44339	(23) 9.7625 04937	(23) 9.8411 15531	(23) 9.9202 79441
9	(26) 9.5588 95784	(26) 9.6457 06561	(26) 9.7332 17422	(26) 9.8214 33300	(26) 9.9103 59161
10	(29) 9.5111 01305	(29) 9.6071 23735	(29) 9.7040 17769	(29) 9.8017 90434	(29) 9.9004 48802
24	(71) 8.8665 35105	(71) 9.0828 91413	(71) 9.3043 02025	(71) 9.5308 79767	(71) 9.7627 39866
1/2	(1) 3.1543 62059	(1) 3.1559 46768	(1) 3.1575 30681	(1) 3.1591 13800	(1) 3.1606 96126
1/3	9.9833 05478	9.9866 48849	9.9899 89783	9.9933 28884	9.9966 65555
1/4	5.6163 70767	5.6177 81384	5.6191 90939	5.6205 99434	5.6220 06871
1/5	3.9770 82648	3.9778 81740	3.9786 80191	3.9794 78001	3.9802 75173

$$n^2 \left[\begin{matrix} (-6) \\ \xi \end{matrix} \right] \quad n^3 \left[\begin{matrix} (-7) \\ 3 \end{matrix} \right] \quad n^4 \left[\begin{matrix} (-7) \\ 3 \end{matrix} \right] \quad n^5 \left[\begin{matrix} (-8) \\ 3 \end{matrix} \right]$$

4. Elementary Transcendental Functions

Logarithmic, Exponential, Circular and Hyperbolic Functions

RUTH ZUCKER¹

Contents

	Page
Mathematical Properties	67
4.1. Logarithmic Function	67
4.2. Exponential Function	69
4.3. Circular Functions	71
4.4. Inverse Circular Functions	79
4.5. Hyperbolic Functions	83
4.6. Inverse Hyperbolic Functions	86
 Numerical Methods	 89
4.7. Use and Extension of the Tables	89
 References	 93
 Table 4.1. Common Logarithms ($100 \leq x \leq 1350$)	 95
$\log_{10} x$, $x=100(1)1350$, 10D	
 Table 4.2. Natural Logarithms ($0 \leq x \leq 2.1$)	 100
$\ln x$, $x=0(.001)2.1$, 16D	
 Table 4.3. Radix Table of Natural Logarithms	 114
$\ln(1+x)$, $-\ln(1-x)$, $x=10^{-n}(10^{-n})10^{-n+1}$, $n=10(-1)1$, 25D	
 Table 4.4. Exponential Function ($0 \leq x \leq 100$)	 116
e^x , $\pm x=0(.001)1$, 18D, $x=0(.1)5$, 15D	
$x=5(.1)10$, 12D, $-x=0(.1)10$, 20D	
$\pm x=0(1)100$, 19S	
 Table 4.5. Radix Table of the Exponential Function	 140
e^x, e^{-x} , $x=10^{-n}(10^{-n})10^{-n+1}$, $n=10(-1)1$, 25D	
 Table 4.6. Circular Sines and Cosines for Radian Arguments ($0 \leq x \leq 1.6$)	 142
$\sin x, \cos x$, $x=0(.001)1.6$, 23D	
 Table 4.7. Radix Table of Circular Sines and Cosines	 174
$\sin x, \cos x$, $x=10^{-n}(10^{-n})10^{-n+1}$, $n=10(-1)4$, 25D	
 Table 4.8. Circular Sines and Cosines for Large Radian Arguments ($0 \leq x \leq 1000$)	 175
$\sin x, \cos x$, $x=0(1)100$, 23D, $x=100(1)1000$, 8D	

¹ National Bureau of Standards.

- Table 4.9.** Circular Tangents, Cotangents, Secants and Cosecants for Page
Radian Arguments ($0 \leq x \leq 1.6$) 186
 $\tan x$, $\cot x$, $\sec x$, $\csc x$, $x=0(.01)1.6$, 7 to 9D
 $x^{-1}-\cot x$, $\csc x-x^{-1}$, $x=0(.01).5$, 8D
- Table 4.10.** Circular Sines and Cosines to Tenths of a Degree ($0^\circ \leq \theta \leq 90^\circ$) . 189
 $\sin \theta$, $\cos \theta$, $\theta=0^\circ(.1^\circ)90^\circ$, 15D
- Table 4.11.** Circular Tangents, Cotangents, Secants and Cosecants to
Five Tenths of a Degree ($0^\circ \leq \theta \leq 90^\circ$) 198
 $\tan \theta$, $\cot \theta$, $\theta=0^\circ(.5^\circ)90^\circ$, 15D
 $\sec \theta$, $\csc \theta$, $\theta=0^\circ(.5^\circ)90^\circ$, 8D
- Table 4.12.** Circular Functions for the Argument $\frac{\pi}{2}x$ ($0 \leq x \leq 1$) 200
 $\sin \frac{\pi}{2}x$, $\cos \frac{\pi}{2}x$, $\tan \frac{\pi}{2}x$, $\cot \frac{\pi}{2}x$, $\sec \frac{\pi}{2}x$, $\csc \frac{\pi}{2}x$, $x=0(.01)1$, 20D
- Table 4.13.** Harmonic Analysis 202
 $\sin \frac{2\pi r}{s}$, $\cos \frac{2\pi r}{s}$, $r=1(1)[s/2]$, s even
 $r=1(1)[(s-1)/2]$, s odd
 $s=3(1)25$, 10D
- Table 4.14.** Inverse Circular Sines and Tangents ($0 \leq x \leq 1$). 203
 $\arcsin x$, $\arctan x$, $x=0(.001)1$, 12D
 $f(x)=[2(1-x)]^{-\frac{1}{2}}[\frac{1}{2}\pi - \arcsin x]$, $x=.95(.001)1$, 12D
- Table 4.15.** Hyperbolic Functions ($0 \leq x \leq 10$) 213
 $\sinh x$, $\cosh x$, $x=0(.01)2$, 9D, $x=2(.1)10$, 9D
 $\tanh x$, $\coth x$, $x=0(.01)2$, 8D, 7D, $x=2(.1)10$, 10D
- Table 4.16.** Exponential and Hyperbolic Functions for the Argument πx
($0 \leq x \leq 1$) 219
 $e^{\pm \pi x}$, $\sinh \pi x$, $\cosh \pi x$, $\tanh \pi x$, $x=0(.01)1$, 10D
- Table 4.17.** Inverse Hyperbolic Functions ($0 \leq x \leq \infty$) 221
 $\operatorname{arsinh} x$, $\operatorname{artanh} x$, $x=0(.01)1$, 9D
 $\operatorname{arsinh} x$, $(\operatorname{arcosh} x)/(x^2-1)^{\frac{1}{2}}$, $x=1(.01)2$, 9D, 8D
 $\operatorname{arsinh} x - \ln x$, $\operatorname{arcosh} x - \ln x$, $x^{-1}=.5(-.01)0$, 10D
- Table 4.18.** Roots x_n of $\cos x_n \cosh x_n = \pm 1$, $n=1(1)5$, 7D 223
- Table 4.19.** Roots x_n of $\tan x_n = \lambda x_n$ ($-\infty \leq \lambda \leq 0$, $1 \leq \lambda \leq \infty$) 224
 $-\lambda=0(.05)1$, $n=1(1)9$, 5D
 $\lambda^{-1}=-1(.05)1$, $n=1(1)9$, 5D
- Table 4.20.** Roots x_n of $\cot x_n = \lambda x_n$ ($0 \leq \lambda \leq \infty$) 225
 $\lambda=0(.05)1$, $n=1(1)9$, 5D
 $\lambda^{-1}=1(-.05)0$, $n=1(1)9$, 5D

The author acknowledges the assistance of Lois K. Cherwinski and Elizabeth F. Godefroy in the preparation and checking of the tables.

4. Elementary Transcendental Functions

Logarithmic, Exponential, Circular and Hyperbolic Functions

Mathematical Properties

4.1. Logarithmic Function

Integral Representation

$$4.1.1 \quad \ln z = \int_1^z \frac{dt}{t}$$

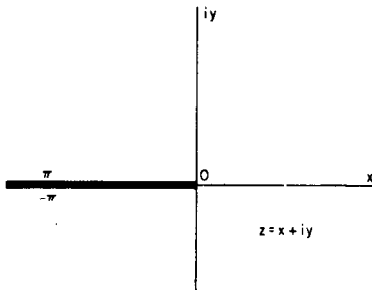

FIGURE 4.1. Branch cut for $\ln z$ and z^a .
(a not an integer or zero.)

where the path of integration does not pass through the origin or cross the negative real axis. $\ln z$ is a single-valued function, regular in the z -plane cut along the negative real axis, real when z is positive.

$$z = x + iy = re^{i\theta}$$

$$4.1.2 \quad \ln z = \ln r + i\theta \quad (-\pi < \theta \leq \pi)$$

$$4.1.3 \quad r = (x^2 + y^2)^{\frac{1}{2}}, \quad x = r \cos \theta, \quad y = r \sin \theta,$$

$$\theta = \arctan \frac{y}{x}$$

The general logarithmic function is the many-valued function $\text{Ln } z$ defined by

$$4.1.4 \quad \text{Ln } z = \int_1^z \frac{dt}{t}$$

where the path does not pass through the origin.

$$4.1.5 \quad \text{Ln}(re^{i\theta}) = \ln(re^{i\theta}) + 2k\pi i = \ln r + i(\theta + 2k\pi),$$

k being an arbitrary integer. $\ln z$ is said to be the *principal branch* of $\text{Ln } z$.

Logarithmic Identities

$$4.1.6 \quad \text{Ln}(z_1 z_2) = \text{Ln } z_1 + \text{Ln } z_2.$$

(i.e., every value of $\text{Ln}(z_1 z_2)$ is one of the values of $\text{Ln } z_1 + \text{Ln } z_2$.)

$$4.1.7 \quad \ln(z_1 z_2) = \ln z_1 + \ln z_2 \\ (-\pi < \arg z_1 + \arg z_2 \leq \pi)$$

$$4.1.8 \quad \text{Ln} \frac{z_1}{z_2} = \text{Ln } z_1 - \text{Ln } z_2$$

$$4.1.9 \quad \ln \frac{z_1}{z_2} = \ln z_1 - \ln z_2 \\ (-\pi < \arg z_1 - \arg z_2 \leq \pi)$$

$$4.1.10 \quad \text{Ln } z^n = n \text{Ln } z \quad (n \text{ integer})$$

$$4.1.11 \quad \ln z^n = n \ln z \\ (n \text{ integer}, \quad -\pi < n \arg z \leq \pi)$$

Special Values (see chapter 1)

$$4.1.12 \quad \ln 1 = 0$$

$$4.1.13 \quad \ln 0 = -\infty$$

$$4.1.14 \quad \ln(-1) = \pi i$$

$$4.1.15 \quad \ln(\pm i) = \pm \frac{1}{2}\pi i$$

$$4.1.16 \quad \ln e = 1, \quad e \text{ is the real number such that}$$

$$\int_1^e \frac{dt}{t} = 1$$

$$4.1.17 \quad e = \lim_{n \rightarrow \infty} \left(1 + \frac{1}{n}\right)^n = 2.71828 \ 18284 \dots$$

(see 4.2.21)

Logarithms to General Base

$$4.1.18 \quad \log_a z = \ln z / \ln a$$

$$4.1.19 \quad \log_a z = \frac{\log_b z}{\log_b a}$$

$$4.1.20 \quad \log_a b = \frac{1}{\log_b a}$$

$$4.1.21 \quad \log_e z = \ln z$$

$$4.1.22 \quad \log_{10} z = \ln z / \ln 10 = \log_{10} e \ln z \\ = (.43429 \ 44819 \dots) \ln z$$

$$4.1.23 \quad \ln z = \ln 10 \log_{10} z = (2.30258 \ 50929 \dots) \log_{10} z$$

($\log_e x = \ln x$, called natural, Napierian, or hyperbolic logarithms; $\log_{10} x$, called common or Briggs logarithms.)

Series Expansions

$$4.1.24 \quad \ln(1+z) = z - \frac{1}{2}z^2 + \frac{1}{3}z^3 - \dots$$

($|z| \leq 1$ and $z \neq -1$)

$$4.1.25 \quad \ln z = \left(\frac{z-1}{z}\right) + \frac{1}{2}\left(\frac{z-1}{z}\right)^2 + \frac{1}{3}\left(\frac{z-1}{z}\right)^3 + \dots$$

($\Re z \geq \frac{1}{2}$)

$$4.1.26 \quad \ln z = (z-1) - \frac{1}{2}(z-1)^2 + \frac{1}{3}(z-1)^3 - \dots$$

($|z-1| \leq 1$, $z \neq 0$)

$$4.1.27 \quad \ln z = 2 \left[\left(\frac{z-1}{z+1}\right) + \frac{1}{3}\left(\frac{z-1}{z+1}\right)^3 + \frac{1}{5}\left(\frac{z-1}{z+1}\right)^5 + \dots \right]$$

($\Re z \geq 0$, $z \neq 0$)

$$4.1.28 \quad \ln\left(\frac{z+1}{z-1}\right) = 2 \left(\frac{1}{z} + \frac{1}{3z^3} + \frac{1}{5z^5} + \dots \right)$$

($|z| \geq 1$, $z \neq \pm 1$)

$$4.1.29 \quad \ln(z+a) = \ln a + 2 \left[\left(\frac{z}{2a+z}\right) + \frac{1}{3}\left(\frac{z}{2a+z}\right)^3 + \frac{1}{5}\left(\frac{z}{2a+z}\right)^5 + \dots \right]$$

($a > 0$, $\Re z \geq -a \neq z$)

Limiting Values

$$4.1.30 \quad \lim_{x \rightarrow \infty} x^{-\alpha} \ln x = 0$$

(α constant, $\Re \alpha > 0$)

$$4.1.31 \quad \lim_{x \rightarrow 0} x^\alpha \ln x = 0$$

(α constant, $\Re \alpha > 0$)

$$4.1.32 \quad \lim_{m \rightarrow \infty} \left(\sum_{k=1}^m \frac{1}{k} - \ln m \right) = \gamma \text{ (Euler's constant)}$$

= .57721 56649 ...

(see chapters 1, 6 and 23)

Inequalities

$$4.1.33 \quad \frac{x}{1+x} < \ln(1+x) < x$$

($x > -1$, $x \neq 0$)

$$4.1.34 \quad x < -\ln(1-x) < \frac{x}{1-x}$$

($x < 1$, $x \neq 0$)

$$4.1.35 \quad |\ln(1-x)| < \frac{3x}{2} \quad (0 < x \leq .5828)$$

$$4.1.36 \quad \ln x \leq x-1 \quad (x > 0)$$

$$4.1.37 \quad \ln x \leq n(x^{1/n} - 1) \text{ for any positive } n$$

($x > 0$)

$$4.1.38 \quad |\ln(1+z)| \leq -\ln(1-|z|) \quad (|z| < 1)$$

Continued Fractions

$$4.1.39 \quad \ln(1+z) = \frac{z}{1 + \frac{z}{2 + \frac{z}{3 + \frac{4z}{4 + \frac{4z}{5 + \frac{9z}{6 + \dots}}}}}}$$

(z in the plane cut from -1 to $-\infty$)

$$4.1.40 \quad \ln\left(\frac{1+z}{1-z}\right) = \frac{2z}{1-3} - \frac{z^2}{5-7} + \frac{4z^2}{5-7} - \frac{9z^2}{7-9} + \dots$$

(z in the cut plane of Figure 4.7.)

Polynomial Approximations²

$$4.1.41 \quad \frac{1}{\sqrt{10}} \leq x \leq \sqrt{10}$$

$$\log_{10} x = a_1 t + a_3 t^3 + \epsilon(x), \quad t = (x-1)/(x+1)$$

($|\epsilon(x)| \leq 6 \times 10^{-4}$)

$a_1 = .86304 \quad a_3 = .36415$

$$4.1.42 \quad \frac{1}{\sqrt{10}} \leq x \leq \sqrt{10}$$

$$\log_{10} x = a_1 t + a_3 t^3 + a_5 t^5 + a_7 t^7 + a_9 t^9 + \epsilon(x)$$

$t = (x-1)/(x+1)$

($|\epsilon(x)| \leq 10^{-7}$)

$a_1 = .86859 \ 1718 \quad a_7 = .09437 \ 6476$

$a_3 = .28933 \ 5524 \quad a_9 = .19133 \ 7714$

$a_5 = .17752 \ 2071$

$$4.1.43 \quad 0 \leq x \leq 1$$

$$\ln(1+x) = a_1 x + a_2 x^2 + a_3 x^3 + a_4 x^4 + a_5 x^5 + \epsilon(x)$$

($|\epsilon(x)| \leq 1 \times 10^{-5}$)

$a_1 = .99949 \ 556 \quad a_4 = -.13606 \ 275$

$a_2 = -.49190 \ 896 \quad a_5 = .03215 \ 845$

$a_3 = .28947 \ 478$

² The approximations 4.1.41 to 4.1.44 are from C. Hastings, Jr., Approximations for digital computers. Princeton Univ. Press, Princeton, N.J., 1955 (with permission).

4.1.44 $0 \leq x \leq 1$
 $\ln(1+x) = a_1x + a_2x^2 + a_3x^3 + a_4x^4 + a_5x^5 + a_6x^6$
 $+ a_7x^7 + a_8x^8 + \epsilon(x)$
 $|\epsilon(x)| \leq 3 \times 10^{-8}$

$a_1 = .99999\ 64239$	$a_5 = .16765\ 40711$
$a_2 = -.49987\ 41238$	$a_6 = -.09532\ 93897$
$a_3 = .33179\ 90258$	$a_7 = .03608\ 84937$
$a_4 = -.24073\ 38084$	$a_8 = -.00645\ 35442$

Approximation in Terms of Chebyshev Polynomials³

4.1.45 $0 \leq x \leq 1$
 $T_n^*(x) = \cos n\theta, \cos \theta = 2x - 1$ (see chapter 22)

$\ln(1+x) = \sum_{n=0}^{\infty} A_n T_n^*(x)$

n	A_n	n	A_n
0	.37645 2813	6	-.00000 8503
1	.34314 5750	7	.00000 1250
2	-.02943 7252	8	-.00000 0188
3	.00336 7089	9	.00000 0029
4	-.00043 3276	10	-.00000 0004
5	.00005 9471	11	.00000 0001

Differentiation Formulas

4.1.46 $\frac{d}{dz} \ln z = \frac{1}{z}$

4.1.47 $\frac{d^n}{dz^n} \ln z = (-1)^{n-1} (n-1)! z^{-n}$

Integration Formulas

4.1.48 $\int \frac{dz}{z} = \ln z$

4.1.49 $\int \ln z \, dz = z \ln z - z$

4.1.50 $\int z^n \ln z \, dz = \frac{z^{n+1}}{n+1} \ln z - \frac{z^{n+1}}{(n+1)^2}$
 $(n \neq -1, n \text{ integer})$

4.1.51 $\int z^n (\ln z)^m \, dz = \frac{z^{n+1} (\ln z)^m}{n+1} - \frac{m}{n+1} \int z^n (\ln z)^{m-1} \, dz$
 $(n \neq -1)$

4.1.52 $\int \frac{dz}{z \ln z} = \ln \ln z$

4.1.53 $\int \ln [z + (z^2 \pm 1)^{\frac{1}{2}}] \, dz = z \ln [z + (z^2 \pm 1)^{\frac{1}{2}}] - (z^2 \pm 1)^{\frac{1}{2}}$

4.1.54 $\int z^n \ln [z + (z^2 \pm 1)^{\frac{1}{2}}] \, dz = \frac{z^{n+1}}{n+1} \ln [z + (z^2 \pm 1)^{\frac{1}{2}}]$
 $- \frac{1}{n+1} \int \frac{z^{n+1}}{(z^2 \pm 1)^{\frac{1}{2}}} \, dz \quad (n \neq -1)$

Definite Integrals

4.1.55 $\int_0^1 \frac{\ln t}{1-t} \, dt = -\pi^2/6$

4.1.56 $\int_0^1 \frac{\ln t}{1+t} \, dt = -\pi^2/12$

4.1.57 $\int_0^x \frac{dt}{\ln t} = \text{li}(x)$ (see 5.1.3)

4.2. Exponential Function

Series Expansion

4.2.1 $e^z = \exp z = 1 + \frac{z}{1!} + \frac{z^2}{2!} + \frac{z^3}{3!} + \dots \quad (z = x + iy)$

where e is the real number defined in 4.1.16

Fundamental Properties

4.2.2 $\text{Ln}(\exp z) = z + 2k\pi i \quad (k \text{ any integer})$

4.2.3 $\ln(\exp z) = z \quad (-\pi < \Im z \leq \pi)$

4.2.4 $\exp(\ln z) = \exp(\text{Ln } z) = z$

4.2.5 $\frac{d}{dz} \exp z = \exp z$

Definition of General Powers

4.2.6 If $N = a^z$, then $z = \text{Log}_a N$

4.2.7 $a^z = \exp(z \ln a)$

4.2.8 If $a = |a| \exp(i \arg a) \quad (-\pi < \arg a \leq \pi)$

4.2.9 $|a^z| = |a|^x e^{-y \arg a}$

4.2.10 $\arg(a^z) = y \ln |a| + x \arg a$

4.2.11 $\text{Ln } a^z = z \ln a$ for one of the values of $\text{Ln } a^z$

4.2.12 $\ln a^z = x \ln a \quad (a \text{ real and positive})$

4.2.13 $|e^z| = e^x$

³ The approximation 4.1.45 is from C. W. Clenshaw, Polynomial approximations to elementary functions, Math. Tables Aids Comp. 8, 143-147 (1954) (with permission).

- 4.2.14 $\arg(e^z) = y$
- 4.2.15 $a^{z_1} a^{z_2} = a^{z_1+z_2}$
- 4.2.16 $a^z b^z = (ab)^z \quad (-\pi < \arg a + \arg b \leq \pi)$

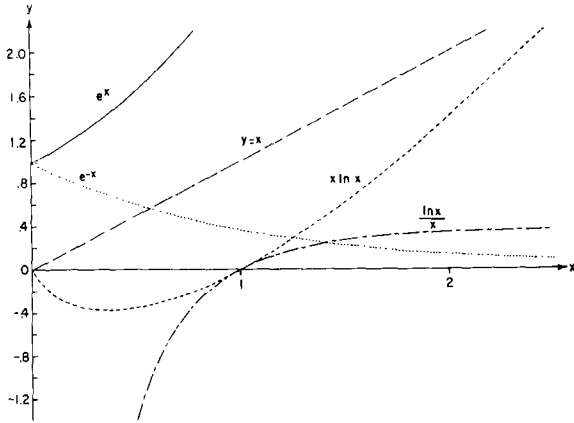

FIGURE 4.2. Logarithmic and exponential functions.

Periodic Property

4.2.17 $e^{z+2\pi ki} = e^z \quad (k \text{ any integer})$

Exponential Identities

- 4.2.18 $e^{z_1} e^{z_2} = e^{z_1+z_2}$
- 4.2.19 $(e^{z_1})^{z_2} = e^{z_1 z_2} \quad (-\pi < \mathcal{I} z_1 \leq \pi)$

The restriction $(-\pi < \mathcal{I} z_1 \leq \pi)$ can be removed if z_2 is an integer.

Limiting Values

- 4.2.20 $\lim_{|z| \rightarrow \infty} z^\alpha e^{-z} = 0 \quad (|\arg z| \leq \frac{1}{2}\pi - \epsilon < \frac{1}{2}\pi, \alpha \text{ constant})$
- 4.2.21 $\lim_{m \rightarrow \infty} \left(1 + \frac{z}{m}\right)^m = e^z$

Special Values (see chapter 1)

- 4.2.22 $e = 2.71828 \ 18284 \dots$
- 4.2.23 $e^0 = 1$
- 4.2.24 $e^\infty = \infty$
- 4.2.25 $e^{-\infty} = 0$
- 4.2.26 $e^{\pm \pi i} = -1$
- 4.2.27 $e^{\pm \frac{\pi i}{2}} = \pm i$
- 4.2.28 $e^{2\pi ki} = 1 \quad (k \text{ any integer})$

Exponential Inequalities

If x is real and different from zero

- 4.2.29 $e^{\frac{x}{1-x}} < 1-x < e^{-x} \quad (x < 1)$
- 4.2.30 $e^x > 1+x$
- 4.2.31 $e^x < \frac{1}{1-x} \quad (x < 1)$
- 4.2.32 $\frac{x}{1+x} < (1-e^{-x}) < x \quad (x > -1)$
- 4.2.33 $x < (e^x - 1) < \frac{x}{1-x} \quad (x < 1)$
- 4.2.34 $1+x > e^{\frac{x}{1+x}} \quad (x > -1)$
- 4.2.35 $e^x > 1 + \frac{x^n}{n!} \quad (n > 0, x > 0)$
- 4.2.36 $e^x > \left(1 + \frac{x}{y}\right)^y > e^{\frac{xy}{x+y}} \quad (x > 0, y > 0)$
- 4.2.37 $e^{-x} < 1 - \frac{x}{2} \quad (0 < x \leq 1.5936)$
- 4.2.38 $\frac{1}{4}|z| < |e^z - 1| < \frac{7}{4}|z| \quad (0 < |z| < 1)$
- 4.2.39 $|e^z - 1| \leq e^{|z|} - 1 \leq |z| e^{|z|} \quad (\text{all } z)$

Continued Fractions

- 4.2.40
$$e^z = \frac{1}{1 - \frac{z}{1 + \frac{z}{2 - \frac{z}{3 + \frac{z}{2 - \frac{z}{5 + \frac{z}{2 - \dots}}}}}}}} \quad (|z| < \infty)$$

$$= 1 + \frac{z}{1 - \frac{z}{2 + \frac{z}{3 - \frac{z}{2 + \frac{z}{5 - \frac{z}{2 + \frac{z}{7 - \dots}}}}}}}} \quad (|z| < \infty)$$

$$= 1 + \frac{z}{(1-z/2) + \frac{z^2/4 \cdot 3}{1 + \frac{z^2/4 \cdot 15}{1 + \frac{z^2/4 \cdot 35}{1 + \dots \frac{z^2/4(4n^2-1)}{1 + \dots}}}}}} \quad (|z| < \infty)$$
- 4.2.41
$$e^z - e_{n-1}(z) = \frac{z^n}{n! - (n+1)z} + \frac{z}{(n+2) - (n+3)z} + \frac{(n+1)z}{(n+4) - (n+5)z} + \frac{2z}{(n+5) + (n+6)z} - \dots \quad (|z| < \infty)$$

(For $e_n(z)$ see 6.5.11)

4.2.42

$$e^{2a \arctan \frac{1}{z}} = 1 + \frac{2a}{z-a} \frac{a^2+1}{3z} \frac{a^2+4}{5z} \frac{a^2+9}{7z} \dots$$

(z in the cut plane of Figure 4.4.)

Polynomial Approximations⁴

4.2.43 $0 \leq x \leq \ln 2 = .693 \dots$

$$e^{-x} = 1 + a_1x + a_2x^2 + \epsilon(x)$$

$$|\epsilon(x)| \leq 3 \times 10^{-3}$$

$$a_1 = -.9664 \quad a_2 = .3536$$

4.2.44 $0 \leq x \leq \ln 2$

$$e^{-x} = 1 + a_1x + a_2x^2 + a_3x^3 + a_4x^4 + \epsilon(x)$$

$$|\epsilon(x)| \leq 3 \times 10^{-4}$$

$$a_1 = -.9998684 \quad a_3 = -.1595332$$

$$a_2 = .4982926 \quad a_4 = .0293641$$

4.2.45 $0 \leq x \leq \ln 2$

$$e^{-x} = 1 + a_1x + a_2x^2 + a_3x^3 + a_4x^4 + a_5x^5 + a_6x^6 + a_7x^7 + \epsilon(x)$$

$$|\epsilon(x)| \leq 2 \times 10^{-10}$$

$$a_1 = -.9999999995 \quad a_5 = -.0083013598$$

$$a_2 = .4999999206 \quad a_6 = .0013298820$$

$$a_3 = -.1666653019 \quad a_7 = -.0001413161$$

$$a_4 = .0416573475$$

4.2.46⁵ $0 \leq x \leq 1$

$$10^x = (1 + a_1x + a_2x^2 + a_3x^3 + a_4x^4)^2 + \epsilon(x)$$

$$|\epsilon(x)| \leq 7 \times 10^{-4}$$

$$a_1 = 1.1499196 \quad a_3 = .2080030$$

$$a_2 = .6774323 \quad a_4 = .1268089$$

4.2.47 $0 \leq x \leq 1$

$$10^x = (1 + a_1x + a_2x^2 + a_3x^3 + a_4x^4 + a_5x^5 + a_6x^6 + a_7x^7)^2 + \epsilon(x)$$

$$|\epsilon(x)| < 5 \times 10^{-8}$$

$$a_1 = 1.15129277603 \quad a_5 = .01742111988$$

$$a_2 = .66273088429 \quad a_6 = .00255491796$$

$$a_3 = .25439357484 \quad a_7 = .00093264267$$

$$a_4 = .07295173666$$

⁴ The approximations 4.2.43 to 4.2.45 are from B. Carlson, M. Goldstein, Rational approximation of functions, Los Alamos Scientific Laboratory LA-1943, Los Alamos, N. Mex., 1955 (with permission).

⁵ The approximations 4.2.46 to 4.2.47 are from C. Hastings, Jr., Approximations for digital computers. Princeton Univ. Press, Princeton, N.J., 1955 (with permission).

Approximations in Terms of Chebyshev Polynomials⁶

4.2.48 $0 \leq x \leq 1$

$$T_n^*(x) = \cos n\theta, \quad \cos \theta = 2x - 1 \quad (\text{see chapter 22})$$

$$e^x = \sum_{n=0}^{\infty} A_n T_n^*(x) \quad e^{-x} = \sum_{n=0}^{\infty} A_n T_n^*(x)$$

n	A_n	n	A_n
0	1.753387654	0	.645035270
1	.850391654	1	-.312841606
2	.105208694	2	.038704116
3	.008722105	3	-.003208683
4	.000543437	4	.000199919
5	.000027115	5	-.000009975
6	.000001128	6	.000000415
7	.000000040	7	-.000000015
8	.000000001		

Differentiation Formulas

4.2.49 $\frac{d}{dz} e^z = e^z$

4.2.50 $\frac{d^n}{dz^n} e^{az} = a^n e^{az}$

4.2.51 $\frac{d}{dz} a^z = a^z \ln a$

4.2.52 $\frac{d}{dz} z^a = a z^{a-1}$

4.2.53 $\frac{d}{dz} z^z = (1 + \ln z) z^z$

Integration Formulas

4.2.54 $\int e^{az} dz = e^{az}/a$

4.2.55 $\int z^n e^{az} dz = \frac{e^{az}}{a^{n+1}} [(az)^n - n(az)^{n-1} + n(n-1)(az)^{n-2} + \dots + (-1)^{n-1} n!(az) + (-1)^n n!] \quad (n \geq 0)$

4.2.56 $\int \frac{e^{az}}{z^n} dz = -\frac{e^{az}}{(n-1)z^{n-1}} + \frac{a}{n-1} \int \frac{e^{az}}{z^{n-1}} dz \quad (n > 1)$

(See chapters 5, 7 and 29 for other integrals involving exponential functions.)

4.3. Circular Functions

Definitions

4.3.1 $\sin z = \frac{e^{iz} - e^{-iz}}{2i} \quad (z = x + iy)$

4.3.2 $\cos z = \frac{e^{iz} + e^{-iz}}{2}$

⁶ The approximations 4.2.48 are from C. W. Clenshaw, Polynomial approximations to elementary functions, Math. Tables Aids Comp. 8, 143-147 (1954) (with permission).

$$4.3.3 \quad \tan z = \frac{\sin z}{\cos z}$$

$$4.3.4 \quad \csc z = \frac{1}{\sin z}$$

$$4.3.5 \quad \sec z = \frac{1}{\cos z}$$

$$4.3.6 \quad \cot z = \frac{1}{\tan z}$$

Periodic Properties

$$4.3.7 \quad \sin(z + 2k\pi) = \sin z \quad (k \text{ any integer})$$

$$4.3.8 \quad \cos(z + 2k\pi) = \cos z$$

$$4.3.9 \quad \tan(z + k\pi) = \tan z$$

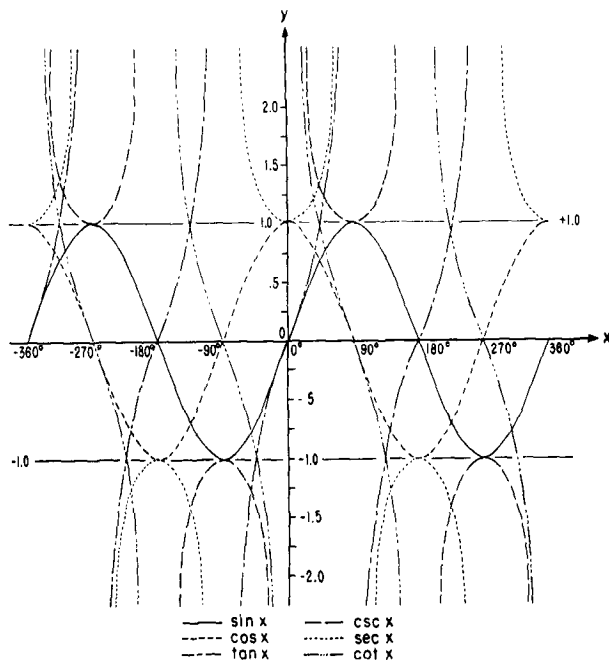

FIGURE 4.3. Circular functions.

Relations Between Circular Functions

$$4.3.10 \quad \sin^2 z + \cos^2 z = 1$$

$$4.3.11 \quad \sec^2 z - \tan^2 z = 1$$

$$4.3.12 \quad \csc^2 z - \cot^2 z = 1$$

Negative Angle Formulas

$$4.3.13 \quad \sin(-z) = -\sin z$$

$$4.3.14 \quad \cos(-z) = \cos z$$

$$4.3.15 \quad \tan(-z) = -\tan z$$

Addition Formulas

$$4.3.16 \quad \sin(z_1 + z_2) = \sin z_1 \cos z_2 + \cos z_1 \sin z_2$$

$$4.3.17 \quad \cos(z_1 + z_2) = \cos z_1 \cos z_2 - \sin z_1 \sin z_2$$

$$4.3.18 \quad \tan(z_1 + z_2) = \frac{\tan z_1 + \tan z_2}{1 - \tan z_1 \tan z_2}$$

$$4.3.19 \quad \cot(z_1 + z_2) = \frac{\cot z_1 \cot z_2 - 1}{\cot z_2 + \cot z_1}$$

Half-Angle Formulas

$$4.3.20 \quad \sin \frac{z}{2} = \pm \left(\frac{1 - \cos z}{2} \right)^{\frac{1}{2}}$$

$$4.3.21 \quad \cos \frac{z}{2} = \pm \left(\frac{1 + \cos z}{2} \right)^{\frac{1}{2}}$$

$$4.3.22 \quad \tan \frac{z}{2} = \pm \left(\frac{1 - \cos z}{1 + \cos z} \right)^{\frac{1}{2}} = \frac{1 - \cos z}{\sin z} = \frac{\sin z}{1 + \cos z}$$

The ambiguity in sign may be resolved with the aid of a diagram.

Transformation of Trigonometric Integrals

If $\tan \frac{u}{2} = z$ then

$$4.3.23 \quad \sin u = \frac{2z}{1+z^2}, \quad \cos u = \frac{1-z^2}{1+z^2}, \quad du = \frac{2}{1+z^2} dz$$

Multiple-Angle Formulas

$$4.3.24 \quad \sin 2z = 2 \sin z \cos z = \frac{2 \tan z}{1 + \tan^2 z}$$

$$4.3.25 \quad \begin{aligned} \cos 2z &= 2 \cos^2 z - 1 = 1 - 2 \sin^2 z \\ &= \cos^2 z - \sin^2 z = \frac{1 - \tan^2 z}{1 + \tan^2 z} \end{aligned}$$

$$4.3.26 \quad \tan 2z = \frac{2 \tan z}{1 - \tan^2 z} = \frac{2 \cot z}{\cot^2 z - 1} = \frac{2}{\cot z - \tan z}$$

$$4.3.27 \quad \sin 3z = 3 \sin z - 4 \sin^3 z$$

$$4.3.28 \quad \cos 3z = -3 \cos z + 4 \cos^3 z$$

$$4.3.29 \quad \sin 4z = 8 \cos^3 z \sin z - 4 \cos z \sin z$$

$$4.3.30 \quad \cos 4z = 8 \cos^4 z - 8 \cos^2 z + 1$$

Products of Sines and Cosines

$$4.3.31 \quad 2 \sin z_1 \sin z_2 = \cos(z_1 - z_2) - \cos(z_1 + z_2)$$

$$4.3.32 \quad 2 \cos z_1 \cos z_2 = \cos(z_1 - z_2) + \cos(z_1 + z_2)$$

$$4.3.33 \quad 2 \sin z_1 \cos z_2 = \sin(z_1 - z_2) + \sin(z_1 + z_2)$$

Addition and Subtraction of Two Circular Functions

4.3.34

$$\sin z_1 + \sin z_2 = 2 \sin \left(\frac{z_1 + z_2}{2} \right) \cos \left(\frac{z_1 - z_2}{2} \right)$$

4.3.35

$$\sin z_1 - \sin z_2 = 2 \cos \left(\frac{z_1 + z_2}{2} \right) \sin \left(\frac{z_1 - z_2}{2} \right)$$

4.3.36

$$\cos z_1 + \cos z_2 = 2 \cos \left(\frac{z_1 + z_2}{2} \right) \cos \left(\frac{z_1 - z_2}{2} \right)$$

4.3.37

$$\cos z_1 - \cos z_2 = -2 \sin \left(\frac{z_1 + z_2}{2} \right) \sin \left(\frac{z_1 - z_2}{2} \right)$$

4.3.38

$$\tan z_1 \pm \tan z_2 = \frac{\sin(z_1 \pm z_2)}{\cos z_1 \cos z_2}$$

4.3.39

$$\cot z_1 \pm \cot z_2 = \frac{\sin(z_2 \pm z_1)}{\sin z_1 \sin z_2}$$

Relations Between Squares of Sines and Cosines

4.3.40

$$\sin^2 z_1 - \sin^2 z_2 = \sin(z_1 + z_2) \sin(z_1 - z_2)$$

4.3.41

$$\cos^2 z_1 - \cos^2 z_2 = -\sin(z_1 + z_2) \sin(z_1 - z_2)$$

4.3.42

$$\cos^2 z_1 - \sin^2 z_2 = \cos(z_1 + z_2) \cos(z_1 - z_2)$$

4.3.43

Signs of the Circular Functions in the Four Quadrants

Quadrant	sin csc	cos sec	tan cot
I	+	+	+
II	+	-	-
III	-	-	+
IV	-	+	-

4.3.44

Functions of Angles in Any Quadrant in Terms of Angles in the First Quadrant. ($0 \leq \theta \leq \frac{\pi}{2}$, k any integer)

	$-\theta$	$\frac{\pi}{2} \pm \theta$	$\pi \pm \theta$	$\frac{3\pi}{2} \pm \theta$	$2k\pi \pm \theta$
sin.....	$-\sin \theta$	$\cos \theta$	$\mp \sin \theta$	$-\cos \theta$	$\pm \sin \theta$
cos.....	$\cos \theta$	$\mp \sin \theta$	$-\cos \theta$	$\pm \sin \theta$	$+\cos \theta$
tan.....	$-\tan \theta$	$\mp \cot \theta$	$\pm \tan \theta$	$\mp \cot \theta$	$\pm \tan \theta$
csc.....	$-\csc \theta$	$+\sec \theta$	$\mp \csc \theta$	$-\sec \theta$	$\pm \csc \theta$
sec.....	$\sec \theta$	$\mp \csc \theta$	$-\sec \theta$	$\pm \csc \theta$	$+\sec \theta$
cot.....	$-\cot \theta$	$\mp \tan \theta$	$\pm \cot \theta$	$\mp \tan \theta$	$\pm \cot \theta$

4.3.45

Relations Between Circular (or Inverse Circular) Functions

	$\sin x = a$	$\cos x = a$	$\tan x = a$	$\csc x = a$	$\sec x = a$	$\cot x = a$
sin x.....	a	$(1 - a^2)^{\frac{1}{2}}$	$a(1 + a^2)^{-\frac{1}{2}}$	a^{-1}	$a^{-1}(a^2 - 1)^{\frac{1}{2}}$	$(1 + a^2)^{-\frac{1}{2}}$
cos x.....	$(1 - a^2)^{\frac{1}{2}}$	a	$(1 + a^2)^{-\frac{1}{2}}$	$a^{-1}(a^2 - 1)^{\frac{1}{2}}$	a^{-1}	$a(1 + a^2)^{-\frac{1}{2}}$
tan x.....	$a(1 - a^2)^{-\frac{1}{2}}$	$a^{-1}(1 - a^2)^{\frac{1}{2}}$	a	$(a^2 - 1)^{-\frac{1}{2}}$	$(a^2 - 1)^{\frac{1}{2}}$	a^{-1}
csc x.....	a^{-1}	$(1 - a^2)^{-\frac{1}{2}}$	$a^{-1}(1 + a^2)^{\frac{1}{2}}$	a	$a(a^2 - 1)^{-\frac{1}{2}}$	$(1 + a^2)^{\frac{1}{2}}$
sec x.....	$(1 - a^2)^{-\frac{1}{2}}$	a^{-1}	$(1 + a^2)^{\frac{1}{2}}$	$a(a^2 - 1)^{-\frac{1}{2}}$	a	$a^{-1}(1 + a^2)^{\frac{1}{2}}$
cot x.....	$a^{-1}(1 - a^2)^{\frac{1}{2}}$	$a(1 - a^2)^{-\frac{1}{2}}$	a^{-1}	$(a^2 - 1)^{\frac{1}{2}}$	$(a^2 - 1)^{-\frac{1}{2}}$	a

$(0 \leq x \leq \frac{\pi}{2})$ Illustration: If $\sin x = a$, $\cot x = a^{-1}(1 - a^2)^{\frac{1}{2}}$
 $\operatorname{arcsec} a = \operatorname{arccot} (a^2 - 1)^{-\frac{1}{2}}$

4.3.46 Circular Functions for Certain Angles

	0 0°	$\pi/12$ 15°	$\pi/6$ 30°	$\pi/4$ 45°	$\pi/3$ 60°
sin	0	$\frac{\sqrt{2}}{4}(\sqrt{3}-1)$	1/2	$\sqrt{2}/2$	$\sqrt{3}/2$
cos	1	$\frac{\sqrt{2}}{4}(\sqrt{3}+1)$	$\sqrt{3}/2$	$\sqrt{2}/2$	1/2
tan	0	$2-\sqrt{3}$	$\sqrt{3}/3$	1	$\sqrt{3}$
csc	∞	$\sqrt{2}(\sqrt{3}+1)$	2	$\sqrt{2}$	$2\sqrt{3}/3$
sec	1	$\sqrt{2}(\sqrt{3}-1)$	$2\sqrt{3}/3$	$\sqrt{2}$	2
cot	∞	$2+\sqrt{3}$	$\sqrt{3}$	1	$\sqrt{3}/3$

	$5\pi/12$ 75°	$\pi/2$ 90°	$7\pi/12$ 105°	$2\pi/3$ 120°
sin	$\frac{\sqrt{2}}{4}(\sqrt{3}+1)$	1	$\frac{\sqrt{2}}{4}(\sqrt{3}+1)$	$\sqrt{3}/2$
cos	$\frac{\sqrt{2}}{4}(\sqrt{3}-1)$	0	$-\frac{\sqrt{2}}{4}(\sqrt{3}-1)$	-1/2
tan	$2+\sqrt{3}$	∞	$-(2+\sqrt{3})$	$-\sqrt{3}$
csc	$\sqrt{2}(\sqrt{3}-1)$	1	$\sqrt{2}(\sqrt{3}-1)$	$2\sqrt{3}/3$
sec	$\sqrt{2}(\sqrt{3}+1)$	∞	$-\sqrt{2}(\sqrt{3}+1)$	-2
cot	$2-\sqrt{3}$	0	$-(2-\sqrt{3})$	$-\sqrt{3}/3$

	$3\pi/4$ 135°	$5\pi/6$ 150°	$11\pi/12$ 165°	π 180°
sin	$\sqrt{2}/2$	1/2	$\frac{\sqrt{2}}{4}(\sqrt{3}-1)$	0
cos	$-\sqrt{2}/2$	$-\sqrt{3}/2$	$-\frac{\sqrt{2}}{4}(\sqrt{3}+1)$	-1
tan	-1	$-\sqrt{3}/3$	$-(2-\sqrt{3})$	0
csc	$\sqrt{2}$	2	$\sqrt{2}(\sqrt{3}+1)$	∞
sec	$-\sqrt{2}$	$-2\sqrt{3}/3$	$-\sqrt{2}(\sqrt{3}-1)$	-1
cot	-1	$-\sqrt{3}$	$-(2+\sqrt{3})$	∞

Euler's Formula

4.3.47 $e^z = e^{x+iy} = e^x (\cos y + i \sin y)$

De Moivre's Theorem

4.3.48 $(\cos z + i \sin z)^\nu = \cos \nu z + i \sin \nu z$
($-\pi < \Re z \leq \pi$ unless ν is an integer)

Relation to Hyperbolic Functions (see 4.5.7 to 4.5.12)

4.3.49 $\sin z = -i \sinh iz$

4.3.50 $\cos z = \cosh iz$

4.3.51 $\tan z = -i \tanh iz$

4.3.52 $\csc z = i \operatorname{csch} iz$

4.3.53 $\sec z = \operatorname{sech} iz$

4.3.54 $\cot z = i \operatorname{coth} iz$

Circular Functions in Terms of Real and Imaginary Parts

4.3.55 $\sin z = \sin x \cosh y + i \cos x \sinh y$

4.3.56 $\cos z = \cos x \cosh y - i \sin x \sinh y$

4.3.57 $\tan z = \frac{\sin 2x + i \sinh 2y}{\cos 2x + \cosh 2y}$

4.3.58 $\cot z = \frac{\sin 2x - i \sinh 2y}{\cosh 2y - \cos 2x}$

Modulus and Phase (Argument) of Circular Functions

4.3.59 $|\sin z| = (\sin^2 x + \sinh^2 y)^{\frac{1}{2}}$
 $= [\frac{1}{2} (\cosh 2y - \cos 2x)]^{\frac{1}{2}}$

4.3.60 $\arg \sin z = \arctan (\cot x \tanh y)$

4.3.61 $|\cos z| = (\cos^2 x + \sinh^2 y)^{\frac{1}{2}}$
 $= [\frac{1}{2} (\cosh 2y + \cos 2x)]^{\frac{1}{2}}$

4.3.62 $\arg \cos z = -\arctan (\tan x \tanh y)$

4.3.63 $|\tan z| = \left(\frac{\cosh 2y - \cos 2x}{\cosh 2y + \cos 2x} \right)^{\frac{1}{2}}$

4.3.64 $\arg \tan z = \arctan \left(\frac{\sinh 2y}{\sin 2x} \right)$

Series Expansions

4.3.65

$$\sin z = z - \frac{z^3}{3!} + \frac{z^5}{5!} - \frac{z^7}{7!} + \dots \quad (|z| < \infty)$$

4.3.66

$$\cos z = 1 - \frac{z^2}{2!} + \frac{z^4}{4!} - \frac{z^6}{6!} + \dots \quad (|z| < \infty)$$

4.3.67

$$\tan z = z + \frac{z^3}{3} + \frac{2z^5}{15} + \frac{17z^7}{315} + \dots + \frac{(-1)^{n-1} 2^{2n} (2^{2n}-1) B_{2n}}{(2n)!} z^{2n-1} + \dots \quad \left(|z| < \frac{\pi}{2}\right)$$

4.3.68

$$\csc z = \frac{1}{z} + \frac{z}{6} + \frac{7}{360} z^3 + \frac{31}{15120} z^5 + \dots + \frac{(-1)^{n-1} 2(2^{2n-1}-1) B_{2n}}{(2n)!} z^{2n-1} + \dots \quad (|z| < \pi)$$

4.3.69

$$\sec z = 1 + \frac{z^2}{2} + \frac{5z^4}{24} + \frac{61z^6}{720} + \dots + \frac{(-1)^n E_{2n}}{(2n)!} z^{2n} + \dots \quad \left(|z| < \frac{\pi}{2}\right)$$

4.3.70

$$\cot z = \frac{1}{z} - \frac{z}{3} + \frac{z^3}{45} - \frac{2z^5}{945} + \dots - \frac{(-1)^{n-1} 2^{2n} B_{2n}}{(2n)!} z^{2n-1} + \dots \quad (|z| < \pi)$$

4.3.71

$$\ln \frac{\sin z}{z} = \sum_{n=1}^{\infty} \frac{(-1)^n 2^{2n-1} B_{2n}}{n(2n)!} z^{2n} \quad (|z| < \pi)$$

4.3.72

$$\ln \cos z = \sum_{n=1}^{\infty} \frac{(-1)^n 2^{2n-1} (2^{2n}-1) B_{2n}}{n(2n)!} z^{2n} \quad (|z| < \frac{1}{2}\pi)$$

4.3.73

$$\ln \frac{\tan z}{z} = \sum_{n=1}^{\infty} \frac{(-1)^{n-1} 2^{2n} (2^{2n-1}-1) B_{2n}}{n(2n)!} z^{2n} \quad (|z| < \frac{1}{2}\pi)$$

where B_n and E_n are the Bernoulli and Euler numbers (see chapter 23).

Limiting Values

4.3.74 $\lim_{x \rightarrow 0} \frac{\sin x}{x} = 1$

4.3.75 $\lim_{x \rightarrow 0} \frac{\tan x}{x} = 1$

4.3.76 $\lim_{n \rightarrow \infty} n \sin \frac{x}{n} = x$

4.3.77 $\lim_{n \rightarrow \infty} n \tan \frac{x}{n} = x$

4.3.78 $\lim_{n \rightarrow \infty} \cos \frac{x}{n} = 1$

Inequalities

4.3.79 $\frac{\sin x}{x} > \frac{2}{\pi} \quad \left(-\frac{\pi}{2} < x < \frac{\pi}{2}\right)$

4.3.80 $\sin x \leq x \leq \tan x \quad \left(0 \leq x \leq \frac{\pi}{2}\right)$

4.3.81 $\cos x \leq \frac{\sin x}{x} \leq 1 \quad (0 \leq x \leq \pi)$

4.3.82 $\pi < \frac{\sin \pi x}{x(1-x)} \leq 4 \quad (0 < x < 1)$

4.3.83 $|\sinh y| \leq |\sin z| \leq \cosh y$

4.3.84 $|\sinh y| \leq |\cos z| \leq \cosh y$

4.3.85 $|\csc z| \leq \operatorname{csch} |y|$

4.3.86 $|\cos z| \leq \cosh |z|$

4.3.87 $|\sin z| \leq \sinh |z|$

4.3.88 $|\cos z| < 2, \quad |\sin z| \leq \frac{6}{5} |z| \quad (|z| < 1)$

Infinite Products

4.3.89 $\sin z = z \prod_{k=1}^{\infty} \left(1 - \frac{z^2}{k^2 \pi^2}\right)$

4.3.90 $\cos z = \prod_{k=1}^{\infty} \left(1 - \frac{4z^2}{(2k-1)^2 \pi^2}\right)$

Expansion in Partial Fractions

4.3.91 $\cot z = \frac{1}{z} + 2z \sum_{k=1}^{\infty} \frac{1}{z^2 - k^2 \pi^2} \quad (z \neq 0, \pm \pi, \pm 2\pi, \dots)$

4.3.92 $\csc^2 z = \sum_{k=-\infty}^{\infty} \frac{1}{(z - k\pi)^2} \quad (z \neq 0, \pm \pi, \pm 2\pi, \dots)$

4.3.93 $\csc z = \frac{1}{z} + 2z \sum_{k=1}^{\infty} \frac{(-1)^k}{z^2 - k^2 \pi^2} \quad (z \neq 0, \pm \pi, \pm 2\pi, \dots)$

Continued Fractions

4.3.94 $\tan z = \frac{z}{1 - \frac{z^2}{3 - \frac{z^2}{5 - \frac{z^2}{7 - \dots}}}} \quad \left(z \neq \frac{\pi}{2} \pm n\pi\right)$

4.3.95

$$\tan az = \frac{a \tan z}{1 + \frac{(1-a^2) \tan^2 z}{3 + \frac{(4-a^2) \tan^2 z}{5 + \frac{(9-a^2) \tan^2 z}{7 + \dots}}} \quad \left(-\frac{\pi}{2} < \mathcal{R} z < \frac{\pi}{2}, \quad az \neq \frac{\pi}{2} \pm n\pi\right)$$

Polynomial Approximations⁷

4.3.96

$$0 \leq x \leq \frac{\pi}{2}$$

$$\frac{\sin x}{x} = 1 + a_2 x^2 + a_4 x^4 + \epsilon(x)$$

$$|\epsilon(x)| \leq 2 \times 10^{-4}$$

$$a_2 = -.16605 \quad a_4 = .00761$$

4.3.97

$$0 \leq x \leq \frac{\pi}{2}$$

$$\frac{\sin x}{x} = 1 + a_2 x^2 + a_4 x^4 + a_6 x^6 + a_8 x^8 + a_{10} x^{10} + \epsilon(x)$$

$$|\epsilon(x)| \leq 2 \times 10^{-9}$$

$$a_2 = -.16666 \ 66664 \quad a_8 = .00000 \ 27526$$

$$a_4 = .00833 \ 33315 \quad a_{10} = -.00000 \ 00239$$

$$a_6 = -.00019 \ 84090$$

4.3.98

$$0 \leq x \leq \frac{\pi}{2}$$

$$\cos x = 1 + a_2 x^2 + a_4 x^4 + \epsilon(x)$$

$$|\epsilon(x)| \leq 9 \times 10^{-4}$$

$$a_2 = -.49670 \quad a_4 = .03705$$

4.3.99

$$0 \leq x \leq \frac{\pi}{2}$$

$$\cos x = 1 + a_2 x^2 + a_4 x^4 + a_6 x^6 + a_8 x^8 + a_{10} x^{10} + \epsilon(x)$$

$$|\epsilon(x)| \leq 2 \times 10^{-9}$$

$$a_2 = -.49999 \ 99963 \quad a_8 = .00002 \ 47609$$

$$a_4 = .04166 \ 66418 \quad a_{10} = -.00000 \ 02605$$

$$a_6 = -.00138 \ 88397$$

4.3.100

$$0 \leq x \leq \frac{\pi}{4}$$

$$\frac{\tan x}{x} = 1 + a_2 x^2 + a_4 x^4 + \epsilon(x)$$

$$|\epsilon(x)| \leq 1 \times 10^{-3}$$

$$a_2 = .31755 \quad a_4 = .20330$$

4.3.101

$$0 \leq x \leq \frac{\pi}{4}$$

$$\frac{\tan x}{x} = 1 + a_2 x^2 + a_4 x^4 + a_6 x^6 + a_8 x^8 + a_{10} x^{10} + a_{12} x^{12} + \epsilon(x)$$

$$|\epsilon(x)| \leq 2 \times 10^{-8}$$

$$a_2 = .33333 \ 14036$$

$$a_8 = .02456 \ 50893$$

$$a_4 = .13339 \ 23995$$

$$a_{10} = .00290 \ 05250$$

$$a_6 = .05337 \ 40603$$

$$a_{12} = .00951 \ 68091$$

4.3.102

$$0 \leq x \leq \frac{\pi}{4}$$

$$* \quad x \cot x = 1 + a_2 x^2 + a_4 x^4 + \epsilon(x)$$

$$|\epsilon(x)| \leq 3 \times 10^{-5}$$

$$a_2 = -.332867$$

$$a_4 = -.024369$$

4.3.103

$$0 \leq x \leq \frac{\pi}{4}$$

$$x \cot x = 1 + a_2 x^2 + a_4 x^4 + a_6 x^6 + a_8 x^8 + a_{10} x^{10} + \epsilon(x)$$

$$|\epsilon(x)| \leq 4 \times 10^{-10}$$

$$a_2 = -.33333 \ 33410$$

$$a_8 = -.00020 \ 78504$$

$$a_4 = -.02222 \ 20287$$

$$a_{10} = -.00002 \ 62619$$

$$a_6 = -.00211 \ 77168$$

Approximations in Terms of Chebyshev Polynomials⁸

4.3.104

$$-1 \leq x \leq 1$$

$$T_n^*(x) = \cos n\theta, \quad \cos \theta = 2x - 1 \quad (\text{see chapter 22})$$

$$\sin \frac{1}{2}\pi x = x \sum_{n=0}^{\infty} A_n T_n^*(x^2) \quad \cos \frac{1}{2}\pi x = \sum_{n=0}^{\infty} A_n T_n^*(x^2)$$

n	A_n	n	A_n
0	1.27627 8962	0	.47200 1216
1	-.28526 1569	1	-.49940 3258
2	.00911 8016	2	.02799 2080
3	-.00013 6587	3	-.00059 6695
4	.00000 1185	4	.00000 6704
5	-.00000 0007	5	-.00000 0047

⁷ The approximations 4.3.96 to 4.3.103 are from B. Carlson, M. Goldstein, Rational approximation of functions, Los Alamos Scientific Laboratory LA-1943, Los Alamos, N. Mex., 1955 (with permission).

⁸ The approximations 4.3.104 are from C. W. Clenshaw, Polynomial approximations to elementary functions, Math. Tables Aids Comp. 8, 143-147 (1954) (with permission).

*See page 11.

Differentiation Formulas

4.3.105 $\frac{d}{dz} \sin z = \cos z$

4.3.106 $\frac{d}{dz} \cos z = -\sin z$

4.3.107 $\frac{d}{dz} \tan z = \sec^2 z$

4.3.108 $\frac{d}{dz} \csc z = -\csc z \cot z$

4.3.109 $\frac{d}{dz} \sec z = \sec z \tan z$

4.3.110 $\frac{d}{dz} \cot z = -\csc^2 z$

4.3.111 $\frac{d^n}{dz^n} \sin z = \sin\left(z + \frac{1}{2}n\pi\right)$

4.3.112 $\frac{d^n}{dz^n} \cos z = \cos\left(z + \frac{1}{2}n\pi\right)$

Integration Formulas

4.3.113 $\int \sin z \, dz = -\cos z$

4.3.114 $\int \cos z \, dz = \sin z$

4.3.115 $\int \tan z \, dz = -\ln \cos z = \ln \sec z$

4.3.116 $\int \csc z \, dz = \ln \tan \frac{z}{2} = \ln (\csc z - \cot z) = \frac{1}{2} \ln \frac{1 - \cos z}{1 + \cos z}$

4.3.117 $\int \sec z \, dz = \ln (\sec z + \tan z) = \ln \tan \left(\frac{\pi}{4} + \frac{z}{2}\right) = \text{gd}^{-1}(z)$

= Inverse Gudermannian Function

$\text{gd } z = 2 \arctan e^z - \frac{\pi}{2}$

4.3.118 $\int \cot z \, dz = \ln \sin z = -\ln \csc z$

4.3.119 $\int z^n \sin z \, dz = -z^n \cos z + n \int z^{n-1} \cos z \, dz$

4.3.120 $\int \frac{\sin z}{z^n} \, dz = \frac{-\sin z}{(n-1)z^{n-1}} + \frac{1}{n-1} \int \frac{\cos z}{z^{n-1}} \, dz \quad (n > 1)$

4.3.121 $\int \frac{z}{\sin^2 z} \, dz = -z \cot z - \ln \sin z$

4.3.122

$$\int \frac{z \, dz}{\sin^n z} = \frac{-z \cos z}{(n-1) \sin^{n-1} z} - \frac{1}{(n-1)(n-2) \sin^{n-2} z} + \frac{(n-2)}{(n-1)} \int \frac{z \, dz}{\sin^{n-2} z} \quad (n > 2)$$

4.3.123

$$\int z^n \cos z \, dz = z^n \sin z - n \int z^{n-1} \sin z \, dz$$

4.3.124

$$\int \frac{\cos z}{z^n} \, dz = -\frac{\cos z}{(n-1)z^{n-1}} - \frac{1}{n-1} \int \frac{\sin z}{z^{n-1}} \, dz \quad (n > 1)$$

4.3.125 $\int \frac{z}{\cos^2 z} \, dz = z \tan z + \ln \cos z$

4.3.126

$$\int \frac{z \, dz}{\cos^n z} = \frac{z \sin z}{(n-1) \cos^{n-1} z} - \frac{1}{(n-1)(n-2) \cos^{n-2} z} + \frac{(n-2)}{(n-1)} \int \frac{z \, dz}{\cos^{n-2} z} \quad (n > 2)$$

4.3.127

$$\begin{aligned} \int \sin^m z \cos^n z \, dz &= \frac{\sin^{m+1} z \cos^{n-1} z}{m+n} \\ &+ \frac{(n-1)}{(m+n)} \int \sin^m z \cos^{n-2} z \, dz \\ &= -\frac{\sin^{m-1} z \cos^{n+1} z}{m+n} \\ &+ \frac{(m-1)}{(m+n)} \int \sin^{m-2} z \cos^n z \, dz \quad (m \neq -n) \end{aligned}$$

4.3.128

$$\begin{aligned} \int \frac{dz}{\sin^m z \cos^n z} &= \frac{1}{(n-1) \sin^{m-1} z \cos^{n-1} z} \\ &+ \frac{m+n-2}{n-1} \int \frac{dz}{\sin^m z \cos^{n-2} z} \quad (n > 1) \\ &= \frac{-1}{(m-1) \sin^{m-1} z \cos^{n-1} z} \\ &+ \frac{m+n-2}{m-1} \int \frac{dz}{\sin^{m-2} z \cos^n z} \quad (m > 1) \end{aligned}$$

4.3.129 $\int \tan^n z \, dz = \frac{\tan^{n-1} z}{n-1} - \int \tan^{n-2} z \, dz \quad (n \neq 1)$

4.3.130 $\int \cot^n z \, dz = -\frac{\cot^{n-1} z}{n-1} - \int \cot^{n-2} z \, dz \quad (n \neq 1)$

$$4.3.131 \quad \int \frac{dz}{a+b \sin z} = \frac{2}{(a^2-b^2)^{\frac{1}{2}}} \arctan \frac{a \tan \left(\frac{z}{2}\right) + b}{(a^2-b^2)^{\frac{1}{2}}} \quad (a^2 > b^2)$$

$$= \frac{1}{(b^2-a^2)^{\frac{1}{2}}} \ln \left[\frac{a \tan \left(\frac{z}{2}\right) + b - (b^2-a^2)^{\frac{1}{2}}}{a \tan \left(\frac{z}{2}\right) + b + (b^2-a^2)^{\frac{1}{2}}} \right] \quad (b^2 > a^2)$$

$$4.3.132 \quad \int \frac{dz}{1 \pm \sin z} = \mp \tan \left(\frac{\pi}{4} \mp \frac{z}{2}\right)$$

$$4.3.133 \quad \int \frac{dz}{a+b \cos z} = \frac{2}{(a^2-b^2)^{\frac{1}{2}}} \arctan \frac{(a-b) \tan \frac{z}{2}}{(a^2-b^2)^{\frac{1}{2}}} \quad (a^2 > b^2)$$

$$= \frac{1}{(b^2-a^2)^{\frac{1}{2}}} \ln \left[\frac{(b-a) \tan \frac{z}{2} + (b^2-a^2)^{\frac{1}{2}}}{(b-a) \tan \frac{z}{2} - (b^2-a^2)^{\frac{1}{2}}} \right] \quad (b^2 > a^2)$$

$$4.3.134 \quad \int \frac{dz}{1+\cos z} = \tan \frac{z}{2}$$

$$4.3.135 \quad \int \frac{dz}{1-\cos z} = -\cot \frac{z}{2}$$

$$4.3.136 \quad \int e^{az} \sin bz \, dz = \frac{e^{az}}{a^2+b^2} (a \sin bz - b \cos bz)$$

$$4.3.137 \quad \int e^{az} \cos bz \, dz = \frac{e^{az}}{a^2+b^2} (a \cos bz + b \sin bz)$$

$$4.3.138 \quad \int e^{az} \sin^n bz \, dz = \frac{e^{az} \sin^{n-1} bz}{a^2+n^2b^2} (a \sin bz - nb \cos bz) \\ + \frac{n(n-1)b^2}{a^2+n^2b^2} \int e^{az} \sin^{n-2} bz \, dz$$

$$4.3.139 \quad \int e^{az} \cos^n bz \, dz = \frac{e^{az} \cos^{n-1} bz}{a^2+n^2b^2} (a \cos bz + nb \sin bz) \\ + \frac{n(n-1)b^2}{a^2+n^2b^2} \int e^{az} \cos^{n-2} bz \, dz$$

Definite Integrals

$$4.3.140 \quad \int_0^\pi \sin mt \sin nt \, dt = 0 \\ (m \neq n, \quad m \text{ and } n \text{ integers})$$

$$\int_0^\pi \cos mt \cos nt \, dt = 0$$

$$4.3.141 \quad \int_0^\pi \sin^2 nt \, dt = \int_0^\pi \cos^2 nt \, dt = \frac{\pi}{2} \\ (n \text{ an integer, } n \neq 0)$$

$$4.3.142 \quad \int_0^\infty \frac{\sin mt}{t} \, dt = \frac{\pi}{2} \quad (m > 0) \\ = 0 \quad (m = 0) \\ = -\frac{\pi}{2} \quad (m < 0)$$

$$4.3.143 \quad \int_0^\infty \frac{\cos at - \cos bt}{t} \, dt = \ln(b/a)$$

$$4.3.144 \quad \int_0^\infty \sin t^2 \, dt = \int_0^\infty \cos t^2 \, dt = \frac{1}{2} \sqrt{\frac{\pi}{2}}$$

$$4.3.145 \quad \int_0^{\pi/2} \ln \sin t \, dt = \int_0^{\pi/2} \ln \cos t \, dt = -\frac{\pi}{2} \ln 2$$

$$4.3.146 \quad \int_0^\infty \frac{\cos mt}{1+t^2} \, dt = \frac{\pi}{2} e^{-m}$$

(See chapters 5 and 7 for other integrals involving circular functions.)

(See [5.3] for Fourier transforms.)

4.3.147

Formulas for Solution of Plane Right Triangles

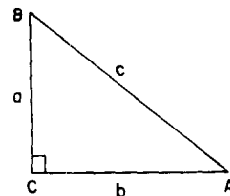

If A, B and C are the vertices (C the right angle), and a, b and c the sides opposite respectively,

$$\sin A = \frac{a}{c} = \frac{1}{\csc A}$$

$$\cos A = \frac{b}{c} = \frac{1}{\sec A}$$

$$\tan A = \frac{a}{b} = \frac{1}{\cot A}$$

$$\text{versine } A = \text{vers } A = 1 - \cos A$$

$$\text{coversine } A = \text{covers } A = 1 - \sin A$$

$$\text{haversine } A = \text{hav } A = \frac{1}{2} \text{vers } A$$

$$\text{exsecant } A = \text{exsec } A = \sec A - 1$$

4.3.148

Formulas for Solution of Plane Triangles

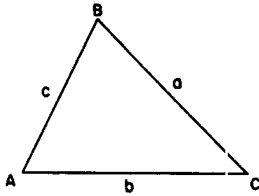

In a triangle with angles A, B and C and sides opposite a, b and c respectively,

$$\frac{a}{\sin A} = \frac{b}{\sin B} = \frac{c}{\sin C}$$

$$\cos A = \frac{c^2 + b^2 - a^2}{2bc}$$

$$a = b \cos C + c \cos B$$

$$\frac{a+b}{a-b} = \frac{\tan \frac{1}{2}(A+B)}{\tan \frac{1}{2}(A-B)}$$

$$\text{area} = \frac{bc \sin A}{2} = [s(s-a)(s-b)(s-c)]^{\frac{1}{2}}$$

$$s = \frac{1}{2}(a+b+c)$$

4.3.149

Formulas for Solution of Spherical Triangles

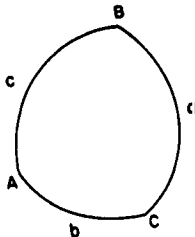

If A, B and C are the three angles and a, b and c the opposite sides,

$$\frac{\sin A}{\sin a} = \frac{\sin B}{\sin b} = \frac{\sin C}{\sin c}$$

$$\cos a = \cos b \cos c + \sin b \sin c \cos A$$

$$= \frac{\cos b \cos (c \pm \theta)}{\cos \theta}$$

where $\tan \theta = \tan b \cos A$

$$\cos A = -\cos B \cos C + \sin B \sin C \cos a$$

4.4. Inverse Circular Functions

Definitions

4.4.1

$$\arcsin z = \int_0^z \frac{dt}{(1-t^2)^{\frac{1}{2}}} \quad (z = x + iy)$$

4.4.2

$$\arccos z = \int_z^1 \frac{dt}{(1-t^2)^{\frac{1}{2}}} = \frac{\pi}{2} - \arcsin z$$

4.4.3

$$\arctan z = \int_0^z \frac{dt}{1+t^2}$$

The path of integration must not cross the real axis in the case of 4.4.1 and 4.4.2 and the imaginary axis in the case of 4.4.3 except possibly inside the unit circle. Each function is single-valued and regular in the z -plane cut along the real axis from $-\infty$ to -1 and $+1$ to $+\infty$ in the case of 4.4.1 and 4.4.2 and along the imaginary axis from i to $i\infty$ and $-i$ to $-i\infty$ in the case of 4.4.3.

Inverse circular functions are also written $\arcsin z = \sin^{-1} z$, $\arccos z = \cos^{-1} z$, $\arctan z = \tan^{-1} z$,

When $-1 \leq x \leq 1$, $\arcsin x$ and $\arccos x$ are real and

4.4.4 $-\frac{1}{2}\pi \leq \arcsin x \leq \frac{1}{2}\pi, \quad 0 < \arccos x \leq \pi$

4.4.5 $\arctan z + \operatorname{arccot} z = \pm \frac{1}{2}\pi \begin{matrix} Rz \geq 0 \\ Rz < 0 \end{matrix}$

4.4.6 $\operatorname{arccsc} z = \arcsin 1/z$

4.4.7 $\operatorname{arcsec} z = \arccos 1/z$

4.4.8 $\operatorname{arccot} z = \arctan 1/z$

4.4.9 $\operatorname{arcsec} z + \operatorname{arccsc} z = \frac{1}{2}\pi$

(see 4.3.45)

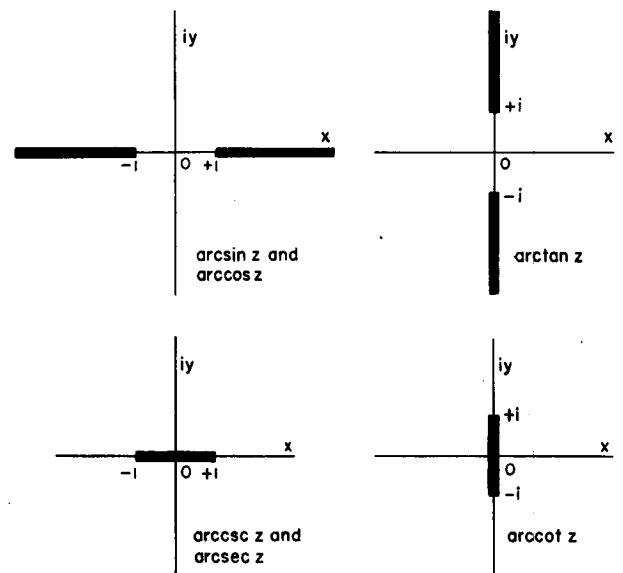

FIGURE 4.4. Branch cuts for inverse circular functions.

Fundamental Property

The general solutions of the equations

$$\sin t = z$$

$$\cos t = z$$

$$\tan t = z$$

are respectively

$$4.4.10 \quad t = \text{Arcsin } z = (-1)^k \arcsin z + k\pi$$

$$4.4.11 \quad t = \text{Arccos } z = \pm \arccos z + 2k\pi$$

$$4.4.12 \quad t = \text{Arctan } z = \arctan z + k\pi \quad (z^2 \neq -1)$$

where k is an arbitrary integer.

4.4.13 Interval containing principal value

y	x positive	x negative
	or zero	

$$\arcsin x \text{ and } \arctan x \quad 0 \leq y \leq \pi/2 \quad -\pi/2 \leq y < 0$$

$$\arccos x \text{ and } \text{arcsec } x \quad 0 \leq y \leq \pi/2 \quad \pi/2 < y \leq \pi$$

$$\text{arccot } x \text{ and } \text{arccsc } x \quad 0 \leq y \leq \pi/2 \quad -\pi/2 \leq y < 0$$

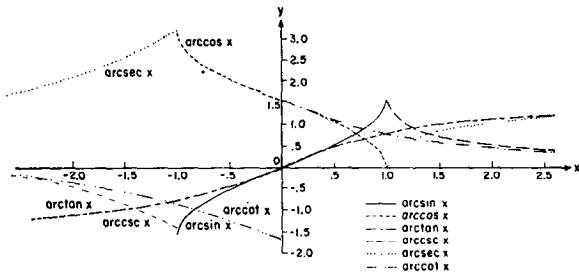

FIGURE 4.5. Inverse circular functions.

Functions of Negative Arguments

$$4.4.14 \quad \arcsin(-z) = -\arcsin z$$

$$4.4.15 \quad \arccos(-z) = \pi - \arccos z$$

$$4.4.16 \quad \arctan(-z) = -\arctan z$$

$$4.4.17 \quad \text{arccsc}(-z) = -\text{arccsc } z$$

$$4.4.18 \quad \text{arcsec}(-z) = \pi - \text{arcsec } z$$

$$4.4.19 \quad \text{arccot}(-z) = -\text{arccot } z$$

Relation to Inverse Hyperbolic Functions (see 4.6.14 to 4.6.19)

$$4.4.20 \quad \text{Arcsin } z = -i \text{Arcsinh } iz$$

$$4.4.21 \quad \text{Arccos } z = \pm i \text{Arccosh } z$$

$$4.4.22 \quad \text{Arctan } z = -i \text{Arctanh } iz \quad (z^2 \neq -1)$$

$$4.4.23 \quad \text{Arccsc } z = i \text{Arccsch } iz$$

$$4.4.24 \quad \text{Arcsec } z = \pm i \text{Arcsech } z$$

$$4.4.25 \quad \text{Arccot } z = i \text{Arcoth } iz$$

Logarithmic Representations

$$4.4.26 \quad \text{Arcsin } x = -i \text{Ln} [(1-x^2)^{1/2} + ix] \quad (x^2 \leq 1)$$

$$4.4.27 \quad \text{Arccos } x = -i \text{Ln} [x + i(1-x^2)^{1/2}] \quad (x^2 \leq 1)$$

$$4.4.28 \quad \text{Arctan } x = \frac{i}{2} \text{Ln} \frac{1-ix}{1+ix} = \frac{i}{2} \text{Ln} \frac{i+x}{i-x} \quad (x \text{ real})$$

$$4.4.29 \quad \text{Arccsc } x = -i \text{Ln} \left[\frac{(x^2-1)^{1/2} + i}{x} \right] \quad (x^2 \geq 1)$$

$$4.4.30 \quad \text{Arcsec } x = -i \text{Ln} \left[\frac{1+i(x^2-1)^{1/2}}{x} \right] \quad (x^2 \geq 1)$$

$$4.4.31 \quad \text{Arccot } x = \frac{i}{2} \text{Ln} \left(\frac{ix+1}{ix-1} \right) = \frac{i}{2} \text{Ln} \left(\frac{x-i}{x+i} \right) \quad (x \text{ real})$$

Addition and Subtraction of Two Inverse Circular Functions

$$4.4.32 \quad \text{Arcsin } z_1 \pm \text{Arcsin } z_2 = \text{Arcsin} [z_1(1-z_2^2)^{1/2} \pm z_2(1-z_1^2)^{1/2}]$$

$$4.4.33 \quad \text{Arccos } z_1 \pm \text{Arccos } z_2 = \text{Arccos} \{ z_1 z_2 \mp [(1-z_1^2)(1-z_2^2)]^{1/2} \}$$

$$4.4.34 \quad \text{Arctan } z_1 \pm \text{Arctan } z_2 = \text{Arctan} \left(\frac{z_1 \pm z_2}{1 \mp z_1 z_2} \right)$$

$$4.4.35 \quad \text{Arcsin } z_1 \pm \text{Arccos } z_2 = \text{Arcsin} \{ z_1 z_2 \pm [(1-z_1^2)(1-z_2^2)]^{1/2} \} = \text{Arccos} [z_2(1-z_1^2)^{1/2} \mp z_1(1-z_2^2)^{1/2}]$$

$$4.4.36 \quad \text{Arctan } z_1 \pm \text{Arccot } z_2 = \text{Arctan} \left(\frac{z_1 z_2 \pm 1}{z_2 \mp z_1} \right) = \text{Arccot} \left(\frac{z_2 \mp z_1}{z_1 z_2 \pm 1} \right)$$

Inverse Circular Functions in Terms of Real and Imaginary Parts

$$4.4.37 \quad \text{Arcsin } z = k\pi + (-1)^k \arcsin \beta + (-1)^k i \ln [\alpha + (\alpha^2 - 1)^{1/2}]$$

$$4.4.38 \quad \text{Arccos } z = 2k\pi \pm \{ \arccos \beta - i \ln [\alpha + (\alpha^2 - 1)^{1/2}] \}$$

4.4.39

$$\operatorname{Arctan} z = k\pi + \frac{1}{2} \arctan \left(\frac{2x}{1-x^2-y^2} \right) + \frac{i}{4} \ln \left[\frac{x^2+(y+1)^2}{x^2+(y-1)^2} \right] \quad (z^2 \neq -1)$$

where k is an integer or zero and

$$\alpha = \frac{1}{2} [(x+1)^2 + y^2]^{\frac{1}{2}} + \frac{1}{2} [(x-1)^2 + y^2]^{\frac{1}{2}}$$

$$\beta = \frac{1}{2} [(x+1)^2 + y^2]^{\frac{1}{2}} - \frac{1}{2} [(x-1)^2 + y^2]^{\frac{1}{2}}$$

Series Expansions

4.4.40

$$\arcsin z = z + \frac{z^3}{2 \cdot 3} + \frac{1 \cdot 3 z^5}{2 \cdot 4 \cdot 5} + \frac{1 \cdot 3 \cdot 5 z^7}{2 \cdot 4 \cdot 6 \cdot 7} + \dots \quad (|z| < 1)$$

4.4.41

$$\arcsin(1-z) = \frac{\pi}{2} - (2z)^{\frac{1}{2}} \left[1 + \sum_{k=1}^{\infty} \frac{1 \cdot 3 \cdot 5 \dots (2k-1)}{2^{2k} (2k+1) k!} z^k \right] \quad (|z| < 2)$$

4.4.42

$$\begin{aligned} \arctan z &= z - \frac{z^3}{3} + \frac{z^5}{5} - \frac{z^7}{7} + \dots \quad (|z| \leq 1 \text{ and } z^2 \neq -1) \\ &= \frac{\pi}{2} - \frac{1}{z} + \frac{1}{3z^3} - \frac{1}{5z^5} + \dots \quad (|z| > 1 \text{ and } z^2 \neq -1) \\ &= \frac{z}{1+z^2} \left[1 + \frac{2}{3} \frac{z^2}{1+z^2} + \frac{2 \cdot 4}{3 \cdot 5} \left(\frac{z^2}{1+z^2} \right)^2 + \dots \right] \quad (z^2 \neq -1) \end{aligned}$$

Continued Fractions

4.4.43 $\arctan z = \frac{z}{1 + \frac{z^2}{3 + \frac{4z^2}{5 + \frac{9z^2}{7 + \frac{16z^2}{9 + \dots}}}}}$
(z in the cut plane of Figure 4.4.)

4.4.44 $\frac{\arcsin z}{\sqrt{1-z^2}} = \frac{z}{1 - \frac{1 \cdot 2z^2}{3 - \frac{1 \cdot 2z^2}{5 - \frac{3 \cdot 4z^2}{7 - \frac{3 \cdot 4z^2}{9 - \dots}}}}}$
(z in the cut plane of Figure 4.4.)

Polynomial Approximations ⁹

4.4.45

$$0 \leq x \leq 1$$

$$\arcsin x = \frac{\pi}{2} - (1-x)^{\frac{1}{2}} (a_0 + a_1x + a_2x^2 + a_3x^3) + \epsilon(x)$$

$$|\epsilon(x)| \leq 5 \times 10^{-5}$$

$$a_0 = 1.57072 \ 88 \qquad a_2 = .07426 \ 10$$

$$a_1 = -.21211 \ 44 \qquad a_3 = -.01872 \ 93$$

4.4.46

$$0 \leq x \leq 1$$

$$\arcsin x = \frac{\pi}{2} - (1-x)^{\frac{1}{2}} (a_0 + a_1x + a_2x^2 + a_3x^3 + a_4x^4 + a_5x^5 + a_6x^6 + a_7x^7) + \epsilon(x)$$

$$|\epsilon(x)| \leq 2 \times 10^{-8}$$

$$a_0 = 1.57079 \ 63050 \qquad a_4 = .03089 \ 18810$$

$$a_1 = -.21459 \ 88016 \qquad a_5 = -.01708 \ 81256$$

$$a_2 = .08897 \ 89874 \qquad a_6 = .00667 \ 00901$$

$$a_3 = -.05017 \ 43046 \qquad a_7 = -.00126 \ 24911$$

4.4.47

$$-1 \leq x \leq 1$$

$$\arctan x = a_1x + a_3x^3 + a_5x^5 + a_7x^7 + a_9x^9 + \epsilon(x)$$

$$|\epsilon(x)| \leq 10^{-5}$$

$$a_1 = .99986 \ 60 \qquad a_7 = -.08513 \ 30$$

$$a_3 = -.33029 \ 95 \qquad a_9 = .02083 \ 51$$

$$a_5 = .18014 \ 10$$

4.4.48¹⁰

$$-1 \leq x \leq 1$$

$$\arctan x = \frac{x}{1 + .28x^2} + \epsilon(x)$$

$$|\epsilon(x)| \leq 5 \times 10^{-3}$$

4.4.49¹¹

$$0 \leq x \leq 1$$

$$\frac{\arctan x}{x} = 1 + \sum_{k=1}^8 a_{2k} x^{2k} + \epsilon(x)$$

$$|\epsilon(x)| \leq 2 \times 10^{-8}$$

$$a_2 = -.33333 \ 14528 \qquad a_{10} = -.07528 \ 96400$$

$$a_4 = .19993 \ 55085 \qquad a_{12} = .04290 \ 96138$$

$$a_6 = -.14208 \ 89944 \qquad a_{14} = -.01616 \ 57367$$

$$a_8 = .10656 \ 26393 \qquad a_{16} = .00286 \ 62257$$

¹⁰ The approximation 4.4.48 is from C. Hastings, Jr., Note 143, Math. Tables Aids Comp. 6, 68 (1953) (with permission).

¹¹ The approximation 4.4.49 is from B. Carlson, M. Goldstein, Rational approximation of functions, Los Alamos Scientific Laboratory LA-1943, Los Alamos, N. Mex., 1955 (with permission).

⁹ The approximations 4.4.45 to 4.4.47 are from C. Hastings, Jr., Approximations for digital computers. Princeton Univ. Press, Princeton, N.J., 1955 (with permission).

Approximations in Terms of Chebyshev Polynomials¹²

4.4.50
$$-1 \leq x \leq 1$$

$$T_n^*(x) = \cos n\theta, \quad \cos \theta = 2x - 1 \quad (\text{see chapter 22})$$

$$\arctan x = x \sum_{n=0}^{\infty} A_n T_n^*(x^2)$$

n	A_n	n	A_n
0	.88137 3587	6	.00000 3821
1	-.10589 2925	7	-.00000 0570
2	.01113 5843	8	.00000 0086
3	-.00138 1195	9	-.00000 0013
4	.00018 5743	10	.00000 0002
5	-.00002 6215		

For $x > 1$, use $\arctan x = \frac{1}{2}\pi - \arctan(1/x)$

4.4.51
$$-\frac{1}{2}\sqrt{2} \leq x \leq \frac{1}{2}\sqrt{2}$$

$$\arcsin x = x \sum_{n=0}^{\infty} A_n T_n^*(2x^2)$$

$$0 \leq x \leq \frac{1}{2}\sqrt{2}$$

$$\arccos x = \frac{1}{2}\pi - x \sum_{n=0}^{\infty} A_n T_n^*(2x^2)$$

n	A_n	n	A_n
0	1.05123 1959	5	.00000 5881
1	.05494 6487	6	.00000 0777
2	.00408 0631	7	.00000 0107
3	.00040 7890	8	.00000 0015
4	.00004 6985	9	.00000 0002

For $\frac{1}{2}\sqrt{2} \leq x \leq 1$, use $\arcsin x = \arccos(1-x^2)^{\frac{1}{2}}$, $\arccos x = \arcsin(1-x^2)^{\frac{1}{2}}$.

Differentiation Formulas

4.4.52
$$\frac{d}{dz} \arcsin z = (1-z^2)^{-\frac{1}{2}}$$

4.4.53
$$\frac{d}{dz} \arccos z = -(1-z^2)^{-\frac{1}{2}}$$

4.4.54
$$\frac{d}{dz} \arctan z = \frac{1}{1+z^2}$$

4.4.55
$$\frac{d}{dz} \operatorname{arccot} z = \frac{-1}{1+z^2}$$

4.4.56
$$\frac{d}{dz} \operatorname{arcsec} z = \frac{1}{z(z^2-1)^{\frac{1}{2}}}$$

4.4.57
$$\frac{d}{dz} \operatorname{arccsc} z = -\frac{1}{z(z^2-1)^{\frac{1}{2}}}$$

Integration Formulas

4.4.58
$$\int \arcsin z \, dz = z \arcsin z + (1-z^2)^{\frac{1}{2}}$$

4.4.59
$$\int \arccos z \, dz = z \arccos z - (1-z^2)^{\frac{1}{2}}$$

4.4.60
$$\int \arctan z \, dz = z \arctan z - \frac{1}{2} \ln(1+z^2)$$

4.4.61
$$\int \operatorname{arccsc} z \, dz = z \operatorname{arccsc} z \pm \ln[z + (z^2-1)^{\frac{1}{2}}]$$

$$\begin{cases} 0 < \operatorname{arccsc} z < \frac{\pi}{2} \\ -\frac{\pi}{2} < \operatorname{arccsc} z < 0 \end{cases}$$

4.4.62
$$\int \operatorname{arcsec} z \, dz = z \operatorname{arcsec} z \mp \ln[z + (z^2-1)^{\frac{1}{2}}]$$

$$\begin{cases} 0 < \operatorname{arcsec} z < \frac{\pi}{2} \\ \frac{\pi}{2} < \operatorname{arcsec} z < \pi \end{cases}$$

4.4.63
$$\int \operatorname{arccot} z \, dz = z \operatorname{arccot} z + \frac{1}{2} \ln(1+z^2)$$

4.4.64
$$\int z \arcsin z \, dz = \left(\frac{z^2-1}{2}\right) \arcsin z + \frac{z}{4} (1-z^2)^{\frac{1}{2}}$$

4.4.65
$$\int z^n \arcsin z \, dz = \frac{z^{n+1}}{n+1} \arcsin z - \frac{1}{n+1} \int \frac{z^{n+1}}{(1-z^2)^{\frac{1}{2}}} dz \quad (n \neq -1)$$

4.4.66
$$\int z \arccos z \, dz = \left(\frac{z^2-1}{2}\right) \arccos z - \frac{z}{4} (1-z^2)^{\frac{1}{2}}$$

4.4.67
$$\int z^n \arccos z \, dz = \frac{z^{n+1}}{n+1} \arccos z + \frac{1}{n+1} \int \frac{z^{n+1}}{(1-z^2)^{\frac{1}{2}}} dz \quad (n \neq -1)$$

4.4.68
$$\int z \arctan z \, dz = \frac{1}{2} (1+z^2) \arctan z - \frac{z}{2}$$

¹² The approximations 4.4.50 to 4.4.51 are from C. W. Clenshaw, Polynomial approximations to elementary functions, Math. Tables Aids Comp. 8, 143-147 (1954) (with permission).

4.4.69

$$\int z^n \arctan z \, dz = \frac{z^{n+1}}{n+1} \arctan z - \frac{1}{n+1} \int \frac{z^{n+1}}{1+z^2} \, dz$$

($n \neq -1$)

4.4.70

$$\int z \operatorname{arccot} z \, dz = \frac{1}{2} (1+z^2) \operatorname{arccot} z + \frac{z}{2}$$

4.4.71

$$\int z^n \operatorname{arccot} z \, dz = \frac{z^{n+1}}{n+1} \operatorname{arccot} z + \frac{1}{n+1} \int \frac{z^{n+1}}{1+z^2} \, dz$$

($n \neq -1$)

4.5. Hyperbolic Functions

Definitions

4.5.1 $\sinh z = \frac{e^z - e^{-z}}{2}$ ($z = x + iy$)

4.5.2 $\cosh z = \frac{e^z + e^{-z}}{2}$

4.5.3 $\tanh z = \sinh z / \cosh z$

4.5.4 $\operatorname{csch} z = 1 / \sinh z$

4.5.5 $\operatorname{sech} z = 1 / \cosh z$

4.5.6 $\operatorname{coth} z = 1 / \tanh z$

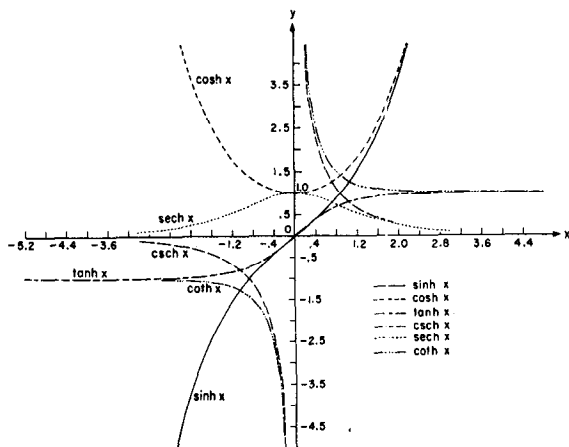

FIGURE 4.6. Hyperbolic functions.

Relation to Circular Functions (see 4.3.49 to 4.3.54)

Hyperbolic formulas can be derived from trigonometric identities by replacing z by iz

4.5.7 $\sinh z = -i \sin iz$

4.5.8 $\cosh z = \cos iz$

4.5.9 $\tanh z = -i \tan iz$

4.5.10 $\operatorname{csch} z = i \csc iz$

4.5.11 $\operatorname{sech} z = \sec iz$

4.5.12 $\operatorname{coth} z = i \cot iz$

Periodic Properties

4.5.13 $\sinh(z + 2k\pi i) = \sinh z$
(k any integer)

4.5.14 $\cosh(z + 2k\pi i) = \cosh z$

4.5.15 $\tanh(z + k\pi i) = \tanh z$

Relations Between Hyperbolic Functions

4.5.16 $\cosh^2 z - \sinh^2 z = 1$

4.5.17 $\tanh^2 z + \operatorname{sech}^2 z = 1$

4.5.18 $\operatorname{coth}^2 z - \operatorname{csch}^2 z = 1$

4.5.19 $\cosh z + \sinh z = e^z$

4.5.20 $\cosh z - \sinh z = e^{-z}$

Negative Angle Formulas

4.5.21 $\sinh(-z) = -\sinh z$

4.5.22 $\cosh(-z) = \cosh z$

4.5.23 $\tanh(-z) = -\tanh z$

Addition Formulas

4.5.24 $\sinh(z_1 + z_2) = \sinh z_1 \cosh z_2 + \cosh z_1 \sinh z_2$

4.5.25 $\cosh(z_1 + z_2) = \cosh z_1 \cosh z_2 + \sinh z_1 \sinh z_2$

4.5.26 $\tanh(z_1 + z_2) = (\tanh z_1 + \tanh z_2) / (1 + \tanh z_1 \tanh z_2)$

4.5.27 $\operatorname{coth}(z_1 + z_2) = (\operatorname{coth} z_1 \operatorname{coth} z_2 + 1) / (\operatorname{coth} z_2 + \operatorname{coth} z_1)$

Half-Angle Formulas

4.5.28 $\sinh \frac{z}{2} = \left(\frac{\cosh z - 1}{2} \right)^{\frac{1}{2}}$

4.5.29

$$\cosh \frac{z}{2} = \left(\frac{\cosh z + 1}{2} \right)^{\frac{1}{2}}$$

4.5.30

$$\tanh \frac{z}{2} = \left(\frac{\cosh z - 1}{\cosh z + 1} \right)^{\frac{1}{2}} = \frac{\cosh z - 1}{\sinh z} = \frac{\sinh z}{\cosh z + 1}$$

Multiple-Angle Formulas

$$4.5.31 \quad \sinh 2z = 2 \sinh z \cosh z = \frac{2 \tanh z}{1 - \tanh^2 z}$$

$$4.5.32 \quad \cosh 2z = 2 \cosh^2 z - 1 = 2 \sinh^2 z + 1 \\ = \cosh^2 z + \sinh^2 z$$

$$4.5.33 \quad \tanh 2z = \frac{2 \tanh z}{1 + \tanh^2 z}$$

$$4.5.34 \quad \sinh 3z = 3 \sinh z + 4 \sinh^3 z$$

$$4.5.35 \quad \cosh 3z = -3 \cosh z + 4 \cosh^3 z$$

$$4.5.36 \quad \sinh 4z = 4 \sinh^3 z \cosh z + 4 \cosh^3 z \sinh z$$

$$4.5.37 \quad \cosh 4z = \cosh^4 z + 6 \sinh^2 z \cosh^2 z + \sinh^4 z$$

Products of Hyperbolic Sines and Cosines

$$4.5.38 \quad 2 \sinh z_1 \sinh z_2 = \cosh (z_1 + z_2) \\ - \cosh (z_1 - z_2)$$

$$4.5.39 \quad 2 \cosh z_1 \cosh z_2 = \cosh (z_1 + z_2) \\ + \cosh (z_1 - z_2)$$

$$4.5.40 \quad 2 \sinh z_1 \cosh z_2 = \sinh (z_1 + z_2) \\ + \sinh (z_1 - z_2)$$

Addition and Subtraction of Two Hyperbolic Functions

4.5.41

$$\sinh z_1 + \sinh z_2 = 2 \sinh \left(\frac{z_1 + z_2}{2} \right) \cosh \left(\frac{z_1 - z_2}{2} \right)$$

4.5.42

$$\sinh z_1 - \sinh z_2 = 2 \cosh \left(\frac{z_1 + z_2}{2} \right) \sinh \left(\frac{z_1 - z_2}{2} \right)$$

4.5.43

$$\cosh z_1 + \cosh z_2 = 2 \cosh \left(\frac{z_1 + z_2}{2} \right) \cosh \left(\frac{z_1 - z_2}{2} \right)$$

4.5.44

$$\cosh z_1 - \cosh z_2 = 2 \sinh \left(\frac{z_1 + z_2}{2} \right) \sinh \left(\frac{z_1 - z_2}{2} \right)$$

4.5.45

$$\tanh z_1 + \tanh z_2 = \frac{\sinh (z_1 + z_2)}{\cosh z_1 \cosh z_2}$$

4.5.46

$$\coth z_1 + \coth z_2 = \frac{\sinh (z_1 + z_2)}{\sinh z_1 \sinh z_2}$$

Relations Between Squares of Hyperbolic Sines and Cosines

4.5.47

$$\sinh^2 z_1 - \sinh^2 z_2 = \sinh (z_1 + z_2) \sinh (z_1 - z_2) \\ = \cosh^2 z_1 - \cosh^2 z_2$$

4.5.48

$$\sinh^2 z_1 + \cosh^2 z_2 = \cosh (z_1 + z_2) \cosh (z_1 - z_2) \\ = \cosh^2 z_1 + \sinh^2 z_2$$

Hyperbolic Functions in Terms of Real and Imaginary Parts

$$(z = x + iy)$$

$$4.5.49 \quad \sinh z = \sinh x \cos y + i \cosh x \sin y$$

$$4.5.50 \quad \cosh z = \cosh x \cos y + i \sinh x \sin y$$

$$4.5.51 \quad \tanh z = \frac{\sinh 2x + i \sin 2y}{\cosh 2x + \cos 2y}$$

$$4.5.52 \quad \coth z = \frac{\sinh 2x - i \sin 2y}{\cosh 2x - \cos 2y}$$

De Moivre's Theorem

$$4.5.53 \quad (\cosh z + \sinh z)^n = \cosh nz + \sinh nz$$

Modulus and Phase (Argument) of Hyperbolic Functions

$$4.5.54 \quad |\sinh z| = (\sinh^2 x + \sin^2 y)^{\frac{1}{2}} \\ = \left[\frac{1}{2} (\cosh 2x - \cos 2y) \right]^{\frac{1}{2}}$$

$$4.5.55 \quad \arg \sinh z = \arctan (\coth x \tan y)$$

$$4.5.56 \quad |\cosh z| = (\sinh^2 x + \cos^2 y)^{\frac{1}{2}} \\ = \left[\frac{1}{2} (\cosh 2x + \cos 2y) \right]^{\frac{1}{2}}$$

$$4.5.57 \quad \arg \cosh z = \arctan (\tanh x \tan y)$$

$$4.5.58 \quad |\tanh z| = \left(\frac{\cosh 2x - \cos 2y}{\cosh 2x + \cos 2y} \right)^{\frac{1}{2}}$$

$$4.5.59 \quad \arg \tanh z = \arctan \left(\frac{\sin 2y}{\sinh 2x} \right)$$

4.5.60 Relations Between Hyperbolic (or Inverse Hyperbolic) Functions

	$\sinh x=a$	$\cosh x=a$	$\tanh x=a$	$\operatorname{csch} x=a$	$\operatorname{sech} x=a$	$\operatorname{coth} x=a$
$\sinh x$ -----	a	$(a^2-1)^{\frac{1}{2}}$	$a(1-a^2)^{-\frac{1}{2}}$	a^{-1}	$a^{-1}(1-a^2)^{\frac{1}{2}}$	$(a^2-1)^{-\frac{1}{2}}$
$\cosh x$ -----	$(1+a^2)^{\frac{1}{2}}$	a	$(1-a^2)^{-\frac{1}{2}}$	$a^{-1}(1+a^2)^{\frac{1}{2}}$	a^{-1}	$a(a^2-1)^{-\frac{1}{2}}$
$\tanh x$ -----	$a(1+a^2)^{-\frac{1}{2}}$	$a^{-1}(a^2-1)^{\frac{1}{2}}$	a	$(1+a^2)^{-\frac{1}{2}}$	$(1-a^2)^{\frac{1}{2}}$	a^{-1}
$\operatorname{csch} x$ -----	a^{-1}	$(a^2-1)^{-\frac{1}{2}}$	$a^{-1}(1-a^2)^{\frac{1}{2}}$	a	$a(1-a^2)^{-\frac{1}{2}}$	$(a^2-1)^{\frac{1}{2}}$
$\operatorname{sech} x$ -----	$(1+a^2)^{-\frac{1}{2}}$	a^{-1}	$(1-a^2)^{\frac{1}{2}}$	$a(1+a^2)^{-\frac{1}{2}}$	a	$a^{-1}(a^2-1)^{\frac{1}{2}}$
$\operatorname{coth} x$ -----	$a^{-1}(a^2+1)^{\frac{1}{2}}$	$a(a^2-1)^{-\frac{1}{2}}$	a^{-1}	$(1+a^2)^{\frac{1}{2}}$	$(1-a^2)^{-\frac{1}{2}}$	a

Illustration: If $\sinh x=a$, $\operatorname{coth} x=a^{-1}(a^2+1)^{\frac{1}{2}}$

$\operatorname{arcsech} a=\operatorname{arccoth} (1-a^2)^{-\frac{1}{2}}$

4.5.61 Special Values of the Hyperbolic Functions

z	0	$\frac{\pi}{2}i$	πi	$\frac{3\pi}{2}i$	∞
$\sinh z$ -----	0	i	0	$-i$	∞
$\cosh z$ -----	1	0	-1	0	∞
$\tanh z$ -----	0	∞i	0	$-\infty i$	1
$\operatorname{csch} z$ -----	∞	$-i$	∞	i	0
$\operatorname{sech} z$ -----	1	∞	-1	∞	0
$\operatorname{coth} z$ -----	∞	0	∞	0	1

Series Expansions

4.5.62 $\sinh z = z + \frac{z^3}{3!} + \frac{z^5}{5!} + \frac{z^7}{7!} + \dots \quad (|z| < \infty)$

4.5.63 $\cosh z = 1 + \frac{z^2}{2!} + \frac{z^4}{4!} + \frac{z^6}{6!} + \dots \quad (|z| < \infty)$

4.5.64 $\tanh z = z - \frac{z^3}{3} + \frac{2}{15}z^5 - \frac{17}{315}z^7 + \dots + \frac{2^{2n}(2^{2n}-1)B_{2n}}{(2n)!}z^{2n-1} + \dots$
 $(|z| < \frac{\pi}{2})$

4.5.65 $\operatorname{csch} z = \frac{1}{z} - \frac{z}{6} + \frac{7}{360}z^3 - \frac{31}{15120}z^5 + \dots - \frac{2(2^{2n-1}-1)B_{2n}}{(2n)!}z^{2n-1} + \dots$
 $(|z| < \pi)$

4.5.66

$\operatorname{sech} z = 1 - \frac{z^2}{2} + \frac{5}{24}z^4 - \frac{61}{720}z^6 + \dots + \frac{E_{2n}}{(2n)!}z^{2n} + \dots$
 $(|z| < \frac{\pi}{2})$

4.5.67

$\operatorname{coth} z = \frac{1}{z} + \frac{z}{3} - \frac{z^3}{45} + \frac{2}{945}z^5 - \dots + \frac{2^{2n}B_{2n}}{(2n)!}z^{2n-1} + \dots$
 $(|z| < \pi)$

where B_n and E_n are the n th Bernoulli and Euler numbers, see chapter 23.

Infinite Products

4.5.68 $\sinh z = z \prod_{k=1}^{\infty} \left(1 + \frac{z^2}{k^2\pi^2}\right)$

4.5.69 $\cosh z = \prod_{k=1}^{\infty} \left[1 + \frac{4z^2}{(2k-1)^2\pi^2}\right]$

Continued Fraction

4.5.70 $\tanh z = \frac{z}{1 + \frac{z^2}{3 + \frac{z^2}{5 + \frac{z^2}{7 + \dots}}}}$
 $(z \neq \frac{\pi}{2}i \pm n\pi i)$

Differentiation Formulas

4.5.71 $\frac{d}{dz} \sinh z = \cosh z$

4.5.72 $\frac{d}{dz} \cosh z = \sinh z$

4.5.73 $\frac{d}{dz} \tanh z = \operatorname{sech}^2 z$

4.5.74 $\frac{d}{dz} \operatorname{csch} z = -\operatorname{csch} z \operatorname{coth} z$

*See page 11.

$$4.5.75 \quad \frac{d}{dz} \operatorname{sech} z = -\operatorname{sech} z \tanh z$$

$$4.5.76 \quad \frac{d}{dz} \operatorname{coth} z = -\operatorname{csch}^2 z$$

Integration Formulas

$$4.5.77 \quad \int \sinh z \, dz = \cosh z$$

$$4.5.78 \quad \int \cosh z \, dz = \sinh z$$

$$4.5.79 \quad \int \tanh z \, dz = \ln \cosh z$$

$$4.5.80 \quad \int \operatorname{csch} z \, dz = \ln \tanh \frac{z}{2}$$

$$4.5.81 \quad \int \operatorname{sech} z \, dz = \arctan (\sinh z)$$

$$4.5.82 \quad \int \operatorname{coth} z \, dz = \ln \sinh z$$

$$4.5.83 \quad \int z^n \sinh z \, dz = z^n \cosh z - n \int z^{n-1} \cosh z \, dz$$

$$4.5.84 \quad \int z^n \cosh z \, dz = z^n \sinh z - n \int z^{n-1} \sinh z \, dz$$

$$4.5.85 \quad \int \sinh^m z \cosh^n z \, dz = \frac{1}{m+n} \sinh^{m+1} z \cosh^{n-1} z \\ + \frac{n-1}{m+n} \int \sinh^m z \cosh^{n-2} z \, dz \\ = \frac{1}{m+n} \sinh^{m-1} z \cosh^{n+1} z \\ - \frac{m-1}{m+n} \int \sinh^{m-2} z \cosh^n z \, dz \quad (m+n \neq 0)$$

$$4.5.86 \quad \int \frac{dz}{\sinh^m z \cosh^n z} = \frac{-1}{m-1} \frac{1}{\sinh^{m-1} z \cosh^{n-1} z} \\ - \frac{m+n-2}{m-1} \int \frac{dz}{\sinh^{m-2} z \cosh^n z} \quad (m \neq 1) \\ = \frac{1}{n-1} \frac{1}{\sinh^{m-1} z \cosh^{n-1} z} \\ + \frac{m+n-2}{n-1} \int \frac{dz}{\sinh^m z \cosh^{n-2} z} \quad (n \neq 1)$$

4.5.87

$$\int \tanh^n z \, dz = -\frac{\tanh^{n-1} z}{n-1} + \int \tanh^{n-2} z \, dz \quad (n \neq 1)$$

4.5.88

$$\int \operatorname{coth}^n z \, dz = -\frac{\operatorname{coth}^{n-1} z}{n-1} + \int \operatorname{coth}^{n-2} z \, dz \quad (n \neq 1)$$

(See chapters 5 and 7 for other integrals involving hyperbolic functions.)

4.6. Inverse Hyperbolic Functions

Definitions

$$4.6.1 \quad \operatorname{arsinh} z = \int_0^z \frac{dt}{(1+t^2)^{\frac{1}{2}}} \quad (z = x + iy)$$

$$4.6.2 \quad \operatorname{arcosh} z = \int_1^z \frac{dt}{(t^2-1)^{\frac{1}{2}}}$$

$$4.6.3 \quad \operatorname{artanh} z = \int_0^z \frac{dt}{1-t^2}$$

The paths of integration must not cross the following cuts.

4.6.1 imaginary axis from $-i\infty$ to $-i$ and i to $i\infty$

4.6.2 real axis from $-\infty$ to $+1$

4.6.3 real axis from $-\infty$ to -1 and $+1$ to $+\infty$

Inverse hyperbolic functions are also written $\sinh^{-1} z$, $\operatorname{arsinh} z$, $\mathcal{A}r \sinh z$, etc.

$$4.6.4 \quad \operatorname{arcsch} z = \operatorname{arsinh} 1/z$$

$$4.6.5 \quad \operatorname{arcsech} z = \operatorname{arcosh} 1/z$$

$$4.6.6 \quad \operatorname{arcoth} z = \operatorname{artanh} 1/z$$

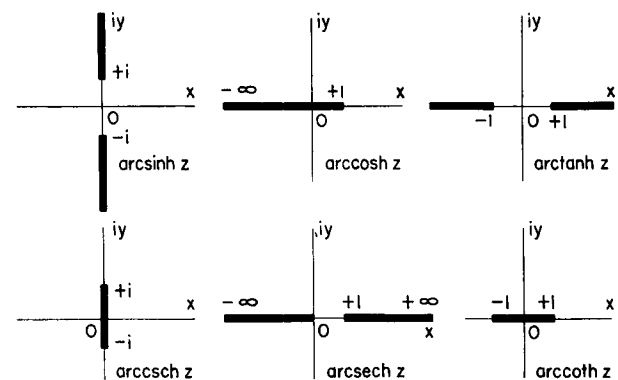

FIGURE 4.7. Branch cuts for inverse hyperbolic functions.

4.6.7 $\operatorname{arctanh} z = \operatorname{arccoth} z \pm \frac{1}{2}\pi i$
 (see 4.5.60) (according as $\Im z \geq 0$)

Fundamental Property

The general solutions of the equations

$$z = \sinh t$$

$$z = \cosh t$$

$$z = \tanh t$$

are respectively

4.6.8 $t = \operatorname{Arcsinh} z = (-1)^k \operatorname{arsinh} z + k\pi i$

4.6.9 $t = \operatorname{Arccosh} z = \pm \operatorname{arccosh} z + 2k\pi i$

4.6.10 $t = \operatorname{Arctanh} z = \operatorname{arctanh} z + k\pi i$
 (k , integer)

Functions of Negative Arguments

4.6.11 $\operatorname{arsinh} (-z) = -\operatorname{arsinh} z$

*4.6.12 $\operatorname{arccosh} (-z) = \pi i - \operatorname{arccosh} z$

4.6.13 $\operatorname{arctanh} (-z) = -\operatorname{arctanh} z$

Relation to Inverse Circular Functions (see 4.4.20 to 4.4.25)

Hyperbolic identities can be derived from trigonometric identities by replacing z by iz .

4.6.14 $\operatorname{Arcsinh} z = -i \operatorname{Arcsin} iz$

4.6.15 $\operatorname{Arccosh} z = \pm i \operatorname{Arccos} z$

4.6.16 $\operatorname{Arctanh} z = -i \operatorname{Arctan} iz$

4.6.17 $\operatorname{Arcsch} z = i \operatorname{Arccsc} iz$

4.6.18 $\operatorname{Arcsech} z = \pm i \operatorname{Arcsec} z$

4.6.19 $\operatorname{Arcoth} z = i \operatorname{Arccot} iz$

Logarithmic Representations

4.6.20 $\operatorname{arsinh} x = \ln [x + (x^2 + 1)^{\frac{1}{2}}]$

4.6.21 $\operatorname{arccosh} x = \ln [x + (x^2 - 1)^{\frac{1}{2}}] \quad (x \geq 1)$

4.6.22 $\operatorname{arctanh} x = \frac{1}{2} \ln \frac{1+x}{1-x} \quad (0 \leq x^2 < 1)$

4.6.23 $\operatorname{arcsch} x = \ln \left[\frac{1}{x} + \left(\frac{1}{x^2} + 1 \right)^{\frac{1}{2}} \right] \quad (x \neq 0)$

4.6.24 $\operatorname{arcsech} x = \ln \left[\frac{1}{x} + \left(\frac{1}{x^2} - 1 \right)^{\frac{1}{2}} \right] \quad (0 < x \leq 1)$

4.6.25 $\operatorname{arccoth} x = \frac{1}{2} \ln \frac{x+1}{x-1} \quad (x^2 > 1)$

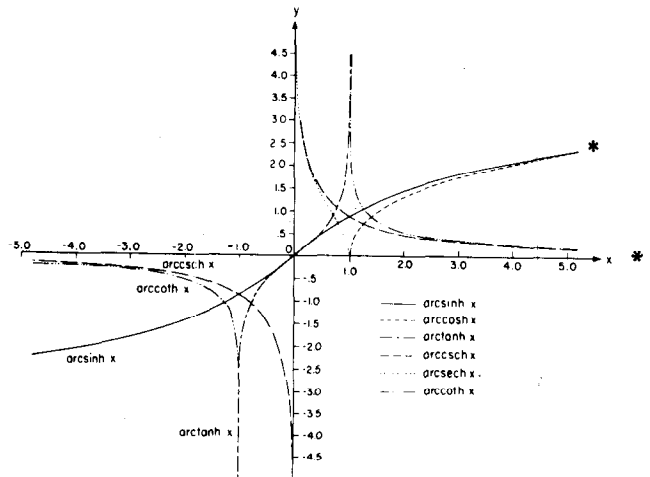

FIGURE 4.8. Inverse hyperbolic functions.

Addition and Subtraction of Two Inverse Hyperbolic Functions

4.6.26

$\operatorname{Arcsinh} z_1 \pm \operatorname{Arcsinh} z_2$
 $= \operatorname{Arcsinh} [z_1(1+z_2^2)^{\frac{1}{2}} \pm z_2(1+z_1^2)^{\frac{1}{2}}]$

4.6.27

$\operatorname{Arccosh} z_1 \pm \operatorname{Arccosh} z_2$
 $= \operatorname{Arccosh} \{z_1 z_2 \pm [(z_1^2 - 1)(z_2^2 - 1)]^{\frac{1}{2}}\}$

4.6.28

$\operatorname{Arctanh} z_1 \pm \operatorname{Arctanh} z_2 = \operatorname{Arctanh} \left(\frac{z_1 \pm z_2}{1 \pm z_1 z_2} \right)$

4.6.29

$\operatorname{Arcsinh} z_1 \pm \operatorname{Arccosh} z_2$
 $= \operatorname{Arcsinh} \{z_1 z_2 \pm [(1+z_1^2)(z_2^2-1)]^{\frac{1}{2}}\}$
 $= \operatorname{Arccosh} [z_2(1+z_1^2)^{\frac{1}{2}} \pm z_1(z_2^2-1)^{\frac{1}{2}}]$

4.6.30

$\operatorname{Arctanh} z_1 \pm \operatorname{Arcoth} z_2 = \operatorname{Arctanh} \left(\frac{z_1 z_2 \pm 1}{z_2 \pm z_1} \right)$
 $= \operatorname{Arcoth} \left(\frac{z_2 \pm z_1}{z_1 z_2 \pm 1} \right)$

*See page 11.

Series Expansions

4.6.31

$$\operatorname{arcsinh} z = z - \frac{1}{2 \cdot 3} z^3 + \frac{1 \cdot 3}{2 \cdot 4 \cdot 5} z^5 - \frac{1 \cdot 3 \cdot 5}{2 \cdot 4 \cdot 6 \cdot 7} z^7 + \dots$$

 $(|z| < 1)$

$$= \ln 2z + \frac{1}{2 \cdot 2z^2} - \frac{1 \cdot 3}{2 \cdot 4 \cdot 4z^4} + \frac{1 \cdot 3 \cdot 5}{2 \cdot 4 \cdot 6 \cdot 6z^6} - \dots$$

 $(|z| > 1)$

4.6.32

$$\operatorname{arccosh} z = \ln 2z - \frac{1}{2 \cdot 2z^2} - \frac{1 \cdot 3}{2 \cdot 4 \cdot 4z^4} - \frac{1 \cdot 3 \cdot 5}{2 \cdot 4 \cdot 6 \cdot 6z^6} - \dots$$

 $(|z| > 1)$

$$4.6.33 \quad \operatorname{arctanh} z = z + \frac{z^3}{3} + \frac{z^5}{5} + \frac{z^7}{7} + \dots \quad (|z| < 1)$$

$$4.6.34 \quad \operatorname{arcoth} z = \frac{1}{z} + \frac{1}{3z^3} + \frac{1}{5z^5} + \frac{1}{7z^7} + \dots \quad (|z| > 1)$$

Continued Fractions

$$4.6.35 \quad \operatorname{arctanh} z = \frac{z}{1 - \frac{z^2}{3 - \frac{4z^2}{5 - \frac{9z^2}{7 - \dots}}}}$$

 $(z \text{ in the cut plane of Figure 4.7.})$

4.6.36

$$\frac{\operatorname{arcsinh} z}{\sqrt{1+z^2}} = \frac{z}{1+} \frac{1 \cdot 2z^2}{3+} \frac{1 \cdot 2z^2}{5+} \frac{3 \cdot 4z^2}{7+} \frac{3 \cdot 4z^2}{9+} \dots$$

Differentiation Formulas

$$4.6.37 \quad \frac{d}{dz} \operatorname{arcsinh} z = (1+z^2)^{-1/2}$$

$$4.6.38 \quad \frac{d}{dz} \operatorname{arccosh} z = (z^2-1)^{-1/2}$$

$$4.6.39 \quad \frac{d}{dz} \operatorname{arctanh} z = (1-z^2)^{-1}$$

$$4.6.40 \quad \frac{d}{dz} \operatorname{arcsch} z = \mp \frac{1}{z(1+z^2)^{1/2}}$$

 $(\text{according as } \Re z \geq 0)$

$$4.6.41 \quad \frac{d}{dz} \operatorname{arcsech} z = \mp \frac{1}{z(1-z^2)^{1/2}}$$

$$4.6.42 \quad \frac{d}{dz} \operatorname{arcoth} z = (1-z^2)^{-1}$$

Integration Formulas

$$4.6.43 \quad \int \operatorname{arcsinh} z \, dz = z \operatorname{arcsinh} z - (1+z^2)^{1/2}$$

$$4.6.44 \quad \int \operatorname{arccosh} z \, dz = z \operatorname{arccosh} z - (z^2-1)^{1/2}$$

$$4.6.45 \quad \int \operatorname{arctanh} z \, dz = z \operatorname{arctanh} z + \frac{1}{2} \ln(1-z^2)$$

$$4.6.46 \quad \int \operatorname{arcsch} z \, dz = z \operatorname{arcsch} z \pm \operatorname{arcsinh} z \quad *$$

 $(\text{according as } \Re z \geq 0)$

$$4.6.47 \quad \int \operatorname{arcsech} z \, dz = z \operatorname{arcsech} z \pm \operatorname{arcsin} z \quad *$$

$$4.6.48 \quad \int \operatorname{arcoth} z \, dz = z \operatorname{arcoth} z + \frac{1}{2} \ln(z^2-1)$$

$$4.6.49 \quad \int z \operatorname{arcsinh} z \, dz = \frac{2z^2+1}{4} \operatorname{arcsinh} z - \frac{z}{4} (z^2+1)^{1/2}$$

4.6.50

$$\int z^n \operatorname{arcsinh} z \, dz = \frac{z^{n+1}}{n+1} \operatorname{arcsinh} z - \frac{1}{n+1} \int \frac{z^{n+1}}{(1+z^2)^{1/2}} dz \quad (n \neq -1)$$

4.6.51

$$\int z \operatorname{arccosh} z \, dz = \frac{2z^2-1}{4} \operatorname{arccosh} z - \frac{z}{4} (z^2-1)^{1/2}$$

4.6.52

$$\int z^n \operatorname{arccosh} z \, dz = \frac{z^{n+1}}{n+1} \operatorname{arccosh} z - \frac{1}{n+1} \int \frac{z^{n+1}}{(z^2-1)^{1/2}} dz \quad (n \neq -1)$$

4.6.53

$$\int z \operatorname{arctanh} z \, dz = \frac{z^2-1}{2} \operatorname{arctanh} z + \frac{z}{2}$$

4.6.54

$$\int z^n \operatorname{arctanh} z \, dz = \frac{z^{n+1}}{n+1} \operatorname{arctanh} z - \frac{1}{n+1} \int \frac{z^{n+1}}{1-z^2} dz \quad (n \neq -1)$$

4.6.55

$$\int z \operatorname{arcsch} z \, dz = \frac{z^2}{2} \operatorname{arcsch} z \pm \frac{1}{2} (1+z^2)^{1/2} \quad *$$

 $(\text{according as } \Re z \geq 0)$

4.6.56

$$\int z^n \operatorname{arcsch} z \, dz = \frac{z^{n+1}}{n+1} \operatorname{arcsch} z \pm \frac{1}{n+1} \int \frac{z^n}{(z^2+1)^{1/2}} dz \quad *$$

 $(n \neq -1)$

*See page II.

4.6.57 $\int z \operatorname{arcsech} z \, dz = \frac{z^2}{2} \operatorname{arcsech} z \mp \frac{1}{2} (1-z^2)^{\frac{1}{2}}$
 (according as $\Re z \geq 0$)

4.6.59 $\int z \operatorname{arccoth} z \, dz = \frac{z^2-1}{2} \operatorname{arccoth} z + \frac{z}{2}$

4.6.58 $\int z^n \operatorname{arcsech} z \, dz = \frac{z^{n+1}}{n+1} \operatorname{arcsech} z \pm \frac{1}{n+1} \int \frac{z^n}{(1-z^2)^{\frac{1}{2}}} dz$
 ($n \neq -1$)

4.6.60 $\int z^n \operatorname{arccoth} z \, dz = \frac{z^{n+1}}{n+1} \operatorname{arccoth} z + \frac{1}{n+1} \int \frac{z^{n+1}}{z^2-1} dz$
 ($n \neq -1$)

Numerical Methods

4.7. Use and Extension of the Tables

NOTE: In the examples given it is assumed that the arguments are exact.

Example 1. Computation of Common Logarithms.

To compute common logarithms, the number must be expressed in the form $x \cdot 10^q$, ($1 \leq x < 10$, $-\infty \leq q \leq \infty$). The common logarithm of $x \cdot 10^q$ consists of an integral part which is called the characteristic and a decimal part which is called the mantissa. Table 4.1 gives the common logarithm of x .

x	$x \cdot 10^q$	$\log_{10} x \cdot 10^q$
.009836	$9.836 \cdot 10^{-3}$	$\bar{3}.99281 \, 85 = (-2.00718 \, 15)$
.09836	$9.836 \cdot 10^{-2}$	$\bar{2}.99281 \, 85 = (-1.00718 \, 15)$
.9836	$9.836 \cdot 10^{-1}$	$\bar{1}.99281 \, 85 = (-0.00718 \, 15)$
9.836	$9.836 \cdot 10^0$	0.99281 85
98.36	$9.836 \cdot 10^1$	1.99281 85
983.6	$9.836 \cdot 10^2$	2.99281 85

Interpolation in Table 4.1 between 983 and 984 gives .99281 85 as the mantissa of 9836.

Note that $\bar{3}.99281 \, 85 = -3 + .99281 \, 85$. When q is negative the common logarithm can be expressed in the alternative forms

$\log_{10} (.009836) = \bar{3}.99281 \, 85 = 7.99281 \, 85 - 10$
 $= -2.00718 \, 15.$

The last form is convenient for conversion from common logarithms to natural logarithms.

The inverse of $\log_{10} x$ is called the antilogarithm of x , and is written $\operatorname{antilog} x$ or $\log^{-1} x$. The logarithm of the reciprocal of a number is called the cologarithm, written colog .

*See page 11.

Example 2.

Compute $x^{-3/4}$ for $x=9.19826$ to 10D using the Table of Common Logarithms.

From Table 4.1, four-point Lagrangian interpolation gives $\log_{10} (9.19826) = .96370 \, 56812$. Then, $-\frac{3}{4} \log_{10} (x) = -.72277 \, 92609 = 9.27722 \, 07391 - 10$.

Linear inverse interpolation in Table 4.1 yields $\operatorname{antilog} (\bar{1}.27722) = .18933$. For 10 place accuracy subtabulation with 4-point Lagrangian interpolants produces the table

N	$\log_{10} N$	Δ	Δ^2
.18933	.27721 94350	2 29379	
.18934	.27724 23729	2 29366	-13
.18935	.27726 53095		

By linear inverse interpolation

$x^{-3/4} = .18933 \, 05685.$

Example 3.

Convert $\log_{10} x$ to $\ln x$ for $x = .009836$.

Using 4.1.23 and Table 4.1, $\ln (.009836) = \ln 10 \log_{10} (.009836) = 2.30258 \, 5093 (-2.00718 \, 15) = -4.62170 \, 62$.

Example 4.

Compute $\ln x$ for $x = .00278$ to 6D.

Using 4.1.7, 4.1.11 and Table 4.2, $\ln (.00278) = \ln (.278 \cdot 10^{-2}) = \ln (.278) - 2 \ln 10 = -5.885304$.

Linear interpolation between $x = .002$ and $x = .003$ would give $\ln (.00278) = -5.898$. To obtain 5 decimal place accuracy with linear interpolation it is necessary that $x > .175$.

Example 5.

Compute $\ln x$ for $x = 1131.718$ to 8D.

Using 4.1.7, 4.1.11 and Table 4.2

$\ln 1131.718 = \ln \left(\frac{1131.718}{1131} \cdot 1131 \right)$
 $= \ln \frac{1131.718}{1131} + \ln 1.131 + \ln 10^3$
 $= \ln (1.00063 \, 4836) + \ln 1.131 + 3 \ln 10.$

Then from 4.1.24

$$\begin{aligned} \ln 1131.718 &= (.00063 \ 4836) - \frac{1}{2}(.00063 \ 4836)^2 \\ &+ \ln 1.131 + 3 \ln 10 = .00063 \ 4836 - .00000 \ 0202 \\ &+ .12310 \ 2197 + 6.90775 \ 5279 = 7.03149 \ 211. \end{aligned}$$

Example 6.

Compute $\ln x$ working with 16D for
 $x = 1.38967 \ 12458 \ 179231$.

Since $\frac{x}{1.389} = 1.00048 \ 32583 \ 282384 = 1 + a$, using
 4.1.24 and Table 4.2 we compute successively

$$\begin{aligned} a &= .00048 \ 32583 \ 282384 \\ -\frac{a^2}{2} &= \underline{\hspace{1.5cm}} \quad 1167 \ 693059 \\ \frac{a^3}{3} &= \hspace{1.5cm} \quad 376199 \\ -\frac{a^4}{4} &= \underline{\hspace{1.5cm}} \quad 136 \\ \ln(1+a) &= .00048 \ 31415 \ 965388 \\ \ln 1.389 &= \underline{\hspace{1.5cm}} \quad .32858 \ 40637 \ 722067 \\ \ln x &= \underline{\hspace{1.5cm}} \quad .32906 \ 72053 \ 687455. \end{aligned}$$

Example 7.

Compute the principal value of $\ln(\pm 2 \pm 3i)$.
 From 4.1.2, 4.1.3 and Tables 4.2 and 4.14.

$$\begin{aligned} \ln(2+3i) &= \frac{1}{2} \ln(2^2+3^2) + i \arctan \frac{3}{2} \\ &= 1.282475 + i(.982794) \\ \ln(-2+3i) &= \frac{1}{2} \ln 13 + i \left(\pi - \arctan \frac{3}{2} \right) \\ &= 1.282475 + i(2.158799) \\ \ln(-2-3i) &= \frac{1}{2} \ln 13 + i \left(-\pi + \arctan \frac{3}{2} \right) \\ &= 1.282475 - i(2.158799) \\ \ln(2-3i) &= \frac{1}{2} \ln 13 + i \left(-\arctan \frac{3}{2} \right) \\ &= 1.282475 - i(.982794). \end{aligned}$$

Example 8.

Compute $(.227)^{.69}$ to 7D.
 Using 4.2.7 and Tables 4.2 and 4.4,

$$\begin{aligned} (.227)^{.69} &= e^{.69 \ln (.227)} = e^{.69(-1.48280 \ 5282)} \\ &= e^{-1.02313 \ 5631} = .35946 \ 60. \end{aligned}$$

Example 9.

Compute $e^{4.99728 \ 69}$ to 7S.
 Using 4.2.18 and Table 4.4,

$$e^{4.99728 \ 69} = e^{4.9} e^{.09728 \ 69}$$

Linear interpolation gives $e^{.09728 \ 69} = 1.10217 \ 67$
 with an error of 1×10^{-7} ,

$$e^{4.99728 \ 69} = (134.28978)(1.10217 \ 67) = 148.0111.$$

Example 10.

Compute e^x to 18D for

$$x = .86725 \ 13489 \ 24685 \ 12693.$$

Let $a = x - .867$. Using 4.2.1, compute succes-
 sively

$$\begin{aligned} &1.00000 \ 00000 \ 00000 \ 00000 \\ a &= .00025 \ 13489 \ 24685 \ 12693 \\ \frac{a^2}{2!} &= \hspace{1.5cm} \quad 315 \ 88140 \ 97019 \\ \frac{a^3}{3!} &= \hspace{1.5cm} \quad 2646 \ 54842 \\ \frac{a^4}{4!} &= \underline{\hspace{1.5cm}} \quad 16630 \end{aligned}$$

$$e^x = 1.00025 \ 13805 \ 15472 \ 81184$$

$$e^{.867} = 2.37976 \ 08513 \ 29496 \ 863 \text{ from Table 4.4}$$

$$e^x e^{.867} = e^x = 2.38035 \ 90768 \ 39006 \ 089.$$

Example 11.

Compute e^{648} to 7S.

Let $n = \frac{x}{\ln 10}$ and $d =$ the decimal part of $\frac{x}{\ln 10}$.

Then

$$\begin{aligned} \exp x &= \exp \left(\frac{x}{\ln 10} \ln 10 \right) = \exp [(n+d) \ln 10] \\ &= \exp (\ln 10^n) \exp (d \ln 10) \\ &= 10^n \exp (d \ln 10) \end{aligned}$$

From Table 4.4

$$e^{648} = \exp \left(\frac{648}{\ln 10} \ln 10 \right) = \exp (281.42282 \ 42 \ln 10)$$

$$= 10^{281} \exp (.42282 \ 42 \ln 10) = 10^{281} \exp .97358 \ 87$$

$$= 10^{281} (2.647428) = (281) 2.647428.$$

Example 12.

Compute e^{-x} for $x = .75$ using the expansion in
 Chebyshev polynomials.

Following the procedure in [4.3] we have from 4.2.48

$$e^{-x} = \sum_{k=0}^7 A_k T_k^*(x)$$

* where $T_k^*(x)$ are the Chebyshev polynomials defined in chapter 22. Assuming $b_8 = b_0 = 0$ we generate $b_k, k=7, 6, 5, \dots, 0$ from the recurrence relation

$$b_k = (4x-2)b_{k+1} - b_{k+2} + A_k$$

k	b _k
7	-.00000 0015
6	.00000 0400
5	-.00000 9560
4	.00018 9959
3	-.00300 9164
2	.03550 4993
1	-.27432 7449
0	.33520 2828

since $f(x) = b_0 - (2x-1)b_1,$

$$e^{-.76} = .33520 2828 - (.5)(-.27432 7449) = .47236 6553.$$

Example 13.

Express $38^\circ 42' 32''$ in radians to 6D.

$$\begin{aligned} 1^\circ &= .01745 32925 19943 29577 \text{ r} \\ 1' &= .00029 08882 08665 72159 62 \text{ r} \\ 1'' &= .00000 48481 36811 09535 9936 \text{ r} \end{aligned}$$

Therefore

$$\begin{aligned} 38^\circ &= .66322 51 \text{ r} \\ 42' &= .01221 73 \text{ r} \\ 32'' &= .00015 51 \text{ r} \\ 38^\circ 42' 32'' &= .675598 \text{ r.} \end{aligned}$$

Example 14.

Express $x = 1.6789$ radians in degrees, minutes and seconds to the nearest tenth of a second.

From Table 1.1 giving the mathematical constants we have

$$\begin{aligned} 1 \text{ r} &= \frac{180^\circ}{\pi} = 57.29577 95130^\circ \dots \\ 1.6789 \text{ r} &= 96.19388^\circ \\ .19388^\circ \times 60 &= 11.633' \\ .633' \times 60 &= 38.0'' \\ 1.6789 \text{ r} &= 96^\circ 11' 38.0'' \end{aligned}$$

Example 15.

Compute $\sin x$ and $\cos x$ for $x = 2.317$ to 7D. From 4.3.44 and Table 4.6

$$\begin{aligned} \sin(2.317) &= \sin(\pi - 2.317) = \sin(.82459 2654) \\ &= .73427 12 \end{aligned}$$

$$\begin{aligned} \cos(2.317) &= \cos(\pi - 2.317) = -\cos(.82459 2654) \\ &= -.67885 60. \end{aligned}$$

Linear interpolation for $x = .82459 2654$ gives an error of 9×10^{-8} .

Example 16.

Compute $\sin x$ for $x = 12.867$ to 8D. From 4.3.16 and Tables 4.6 and 4.8

$$\begin{aligned} \sin(12.867) &= \sin 12 \cos .867 + \cos 12 \sin .867 \\ &= .29612 142. \end{aligned}$$

The method of reduction to an angle in the first quadrant which was given in Example 15 may also be used.

Example 17.

Compute $\sin x$ to 19D for

$$x = .86725 13489 24685 12693.$$

Let $\alpha = .867, \beta = x - \alpha$. From 4.3.16 and Table 4.6

$$\begin{aligned} \sin(\alpha + \beta) &= \sin \alpha \cos \beta + \cos \alpha \sin \beta \\ \sin \alpha &= .76239 10208 07866 22598 \\ \cos \alpha &= .64711 66288 94312 75010 \end{aligned}$$

With the series expansions for $\sin \beta$ and $\cos \beta$ we compute successively

	1.00000	00000	00000	00000
$-\frac{\beta^2}{2!} = -$		315	88140	97019
$\frac{\beta^4}{4!} =$				16630
<hr/>				
$\cos \beta =$.99999	99684	11859	19611
$\beta =$.00025	13489	24685	12693
$-\frac{\beta^3}{3!} = -$			2646	54842
$\frac{\beta^5}{5!} =$				1
<hr/>				

$$\begin{aligned} \sin \beta &= .00025 13489 22038 57852 \\ \sin \alpha \cos \beta &= .76239 09967 25351 31308 \\ \cos \alpha \sin \beta &= .00016 26520 67105 82436 \\ \sin x &= .76255 36487 92457 1374 \end{aligned}$$

*See page 11.

This procedure is equivalent to interpolation with Taylor's formula 3.6.4.

Example 18.

In the plane triangle ABC , $a=123$, $B=29^\circ 16'$, $c=321$; find A , b .

$$b^2 = a^2 + c^2 - 2ac \cos B = (123)^2 + (321)^2 - 2(123)(321) \cos 29^\circ 16'$$

$$b = 221.99934 \ 00$$

$$\sin A = \frac{a \sin B}{b} = \frac{(123)(.48887 \ 50196)}{221.99934 \ 00} = .27086 \ 39918$$

$$A = 15^\circ 42' 56.469''.$$

Example 19.

In the plane triangle ABC , $a=4$, $b=7$, $c=9$, find A , B , and C .

$$\cos A = \frac{c^2 + b^2 - a^2}{2bc} = \frac{81 + 49 - 16}{2 \cdot 7 \cdot 9} = \frac{114}{126} = .90476 \ 1905$$

$$A = .43997 \ 5954 = 25^\circ 12' 31.6''$$

$$\sin A = .42591 \ 7709$$

$$\sin B = \frac{7(.42591 \ 7709)}{4}, \quad B = .84106 \ 8670 \\ = 48^\circ 11' 22.9''$$

$$\sin C = \frac{9(.42591 \ 7709)}{4}, \quad C = 1.86054 \ 803 \\ = 106^\circ 36' 5.6''$$

where the supplementary angle must be chosen for C . As a check we get $A+B+C=180^\circ 00'.1''$.

Example 20.

Compute $\cot x$ for $x=.4589$ to 6D.

Since $x < .5$, using Table 4.9 with interpolation in $(x^{-1} - \cot x)$, we find $\frac{1}{.4589} - \cot(.4589) = .155159$. Therefore $\cot(.4589) = 2.179124 - .155159 = 2.023965$.

Example 21.

Compute $\arcsin x$ for $x=.99511$.

For $x > .95$, using Table 4.14 with interpolation in the auxiliary function $f(x)$ we find

$$\arcsin x = \frac{\pi}{2} - [2(1-x)]^{\frac{1}{2}} f(x)$$

$$\arcsin(.99511) = \frac{\pi}{2} - [2(.00489)]^{\frac{1}{2}} f(.99511) \\ = 1.57079 \ 6327 - (.09889 \ 388252) \\ = 1.47186 \ 2100. \quad (1.00040 \ 7951)$$

Example 22.

Compute $\arctan 20$ and $\operatorname{arccot} 20$ to 9D. Using 4.4.5, 4.4.8, and Table 4.14 *

$$\arctan 20 = \frac{\pi}{2} - \arctan 1/20 = 1.52083 \ 7931$$

$$\operatorname{arccot} 20 = \frac{\pi}{2} - \arctan 20 = \arctan .05 = .04995 \ 8396.$$

Example 23.

Express $z=3+9i$ in polar form.

$$z = x + iy = re^{i\theta}, \text{ where } r = (x^2 + y^2)^{\frac{1}{2}},$$

$$\theta = \arctan \frac{y}{x} + 2\pi k, \quad k \text{ is an integer. For } k=0,$$

$$r = (3^2 + 9^2)^{\frac{1}{2}} = \sqrt{90} = 9.486833$$

$$\theta = \arctan 9/3 = \arctan 3 = 1.24904 \ 58.$$

Thus $3+9i = 9.486833 \exp(1.24904 \ 58i)$.

Example 24.

Compute $\arctan x$ for $x=1/3$ to 12D. From 4.4.34 and 4.4.42 we have

$$\arctan x = \arctan(x_0 + h) \\ = \arctan x_0 + \arctan \frac{h}{1 + x_0 h + x_0^2} \\ = \arctan x_0 + \left(\frac{h}{1 + x_0 h + x_0^2} \right) - \frac{1}{3} \left(\frac{h}{1 + x_0 h + x_0^2} \right)^3 + \dots$$

We have

$x = \frac{1}{3} = .33333 \ 33333 \ 33$ so that $h = .00033 \ 33333 \ 33$ and, from Table 4.14, $\arctan x_0 = \arctan .333 = .32145 \ 05244 \ 03$. Since $\frac{h}{1 + x_0 h + x_0^2} = .00030 \ 00300 \ 03$ we get

$$\arctan x = .32145 \ 05244 \ 03 + .00030 \ 00300 \ 03 \\ - .00000 \ 00000 \ 09 \\ = .32175 \ 05543 \ 97.$$

If x is given in the form b/a it is convenient to use 4.4.34 in the form

$$\arctan \frac{b}{a} = \arctan x_0 + \arctan \frac{b - ax_0}{a + bx_0}$$

In the present example we get

$$\arctan \frac{1}{3} = \arctan .333 + \arctan \frac{1}{3333}$$

*See page 11.

Example 25.

Compute $\operatorname{arcsec} 2.8$ to 5D.
Using 4.3.45 and Table 4.14

$$\begin{aligned}\operatorname{arcsec} z &= \arcsin \frac{(z^2-1)^{\frac{1}{2}}}{z} \\ \operatorname{arcsec} 2.8 &= \arcsin \frac{[(2.8)^2-1]^{\frac{1}{2}}}{2.8} \\ &= \arcsin .93404\ 97735 \\ &= 1.20559\end{aligned}$$

or using 4.3.45 and Table 4.14

$$\begin{aligned}\operatorname{arcsec} z &= \arctan (z^2-1)^{\frac{1}{2}} \\ \operatorname{arcsec} 2.8 &= \arctan 2.61533\ 9366 \\ &= \frac{\pi}{2} - \arctan .38235\ 95564, \\ &\qquad\qquad\qquad \text{from 4.4.3 and 4.4.8} \\ &= 1.570796 - .365207 \\ &= 1.20559.\end{aligned}$$

Example 26.

Compute $\operatorname{arctanh} x$ for $x=.96035$ to 6D.
From 4.6.22 and Table 4.2

$$\begin{aligned}\operatorname{arctanh} .96035 &= \frac{1}{2} \ln \frac{1+.96035}{1-.96035} = \frac{1}{2} \ln \frac{1.96035}{.03965} \\ &= \frac{1}{2} \ln 49.44136\ 191 \\ &= \frac{1}{2}(3.90078\ 7359) = 1.950394.\end{aligned}$$

Example 27.

Compute $\operatorname{arccosh} x$ for $x=1.5368$ to 6D.
Using Table 4.17

$$\begin{aligned}\frac{\operatorname{arccosh} x}{(x^2-1)^{\frac{1}{2}}} &= \frac{\operatorname{arccosh} 1.5368}{[(1.5368)^2-1]^{\frac{1}{2}}} = .852346 \\ \operatorname{arccosh} 1.5368 &= (.852346)(1.361754)^{\frac{1}{2}} \\ &= (.852346)(1.166942) \\ &= .994638.\end{aligned}$$

Example 28.

Compute $\operatorname{arccosh} x$ for $x=31.2$ to 5D.
Using Tables 4.2 and 4.17 with $1/x=1/31.2$
 $=.03205\ 128205$

$$\begin{aligned}\operatorname{arccosh} 31.2 - \ln 31.2 &= .692886 \\ \operatorname{arccosh} 31.2 &= .692886 + 3.440418 = 4.13330.\end{aligned}$$

References**Texts**

- [4.1] B. Carlson, M. Goldstein, Rational approximation of functions, Los Alamos Scientific Laboratory LA-1943 (Los Alamos, N. Mex., 1955).
- [4.2] C. W. Clenshaw, Polynomial approximations to elementary functions, *Math. Tables Aids Comp.* 8, 143-147 (1954).
- [4.3] C. W. Clenshaw, A note on the summation of Chebyshev series, *Math. Tables Aids Comp.* 9, 118-120 (1955).
- [4.4] G. H. Hardy, A course of pure mathematics, 9th ed. (Cambridge Univ. Press, Cambridge, England, and The Macmillan Co., New York, N.Y., 1947).
- [4.5] C. Hastings, Jr., Approximations for digital computers (Princeton Univ. Press, Princeton, N.J., 1955).
- [4.6] C. Hastings, Jr., Note 143, *Math. Tables Aids Comp.* 6, 68 (1953).
- [4.7] E. W. Hobson, A treatise on plane trigonometry, 4th ed. (Cambridge Univ. Press, Cambridge, England, 1918).
- [4.8] H. S. Wall, Analytic theory of continued fractions (D. Van Nostrand Co., Inc., New York, N.Y., 1948).
- [4.9] E. P. Adams, Smithsonian mathematical formulae and tables of elliptic functions, 3d reprint (The Smithsonian Institution, Washington, D.C., 1957).
- [4.10] H. Andoyer, Nouvelles tables trigonométriques fondamentales (Hermann et fils, Paris, France, 1916).
- [4.11] British Association for the Advancement of Science, *Mathematical Tables*, vol. I. Circular and hyperbolic functions, exponential, sine and cosine integrals, factorial function and allied functions, Hermitian probability functions, 3d ed. (Cambridge Univ. Press, Cambridge, England, 1951).
- [4.12] Chemical Rubber Company, *Standard mathematical tables*, 12th ed. (Chemical Rubber Publ. Co., Cleveland, Ohio, 1959).
- [4.13] L. J. Comrie, *Chambers' six-figure mathematical tables*, vol. 2 (W. R. Chambers, Ltd., London, England, 1949).
- [4.14] H. B. Dwight, *Tables of integrals and other mathematical data*, 3d rev. ed. (The Macmillan Co., New York, N.Y., 1957).
- [4.15] W. Gröbner and N. Hofreiter, *Integraltafel, unbestimmte und bestimmte Integrale* (Springer-Verlag, Wien and Innsbruck, Austria, 1949-1950).
- [4.16] Harvard Computation Laboratory, *Tables of the function arcsin z* (Harvard Univ. Press, Cambridge, Mass., 1956). $z=x+iy$, $0 \leq x \leq 475$, $0 \leq y \leq 475$, 6D, varying intervals.
- [4.17] Harvard Computation Laboratory, *Tables of inverse hyperbolic functions* (Harvard Univ. Press, Cambridge, Mass., 1949). $\operatorname{arctanh} x$, $0 \leq x < 1$; $\operatorname{arsinh} x$, $0 \leq x < 3.5$; $\operatorname{arccosh} x$, $1 \leq x < 3.5$; $\operatorname{arsinh} x$, $\operatorname{arccosh} x$, $3.5 \leq x \leq 22980$, 9D, varying intervals.
- [4.18] National Bureau of Standards, *Tables of 10^x* , Applied Math. Series 27 (U.S. Government Printing Office, Washington, D.C., 1953). $x=0(.00001)1$, 10 D. Radix table of $10^{n \cdot 10^{-p}}$, $n=1(1)999$, $p=3(3)15$, 15D.

- [4.19] National Bureau of Standards, Table of natural logarithms for arguments between zero and five to sixteen decimal places, 2d ed., Applied Math. Series 31 (U.S. Government Printing Office, Washington, D.C., 1953). $x=0(.0001)5$, 16 D.
- [4.20] National Bureau of Standards, Tables of the exponential function e^x , 3d ed., Applied Math. Series 14 (U.S. Government Printing Office, Washington, D.C., 1951). $x=-2.4999(.0001) .9999$, 18D, $x=1(.0001) 2.4999$, 15D, $x=2.5(.001) 4.999$, 15D, $x=5(.01) 9.99$, 12D, $x=-.000099(.000001) .000099$, 18D, $x=-100(1)100$, 19S, $x=-9 \times 10^{-n}(10^{-n})9 \times 10^{-n}$, $n=10, 9, 8, 7$, 18D; values of e and $1/e$, 2556D.
- [4.21] National Bureau of Standards, Table of the descending exponential, $x=2.5$ to $x=10$, Applied Math. Series 46 (U.S. Government Printing Office, Washington, D.C., 1955). $x=2.5(.001)10$, 20D.
- [4.22] National Bureau of Standards, Tables of sines and cosines for radian arguments, 2d ed., Applied Math. Series 43 (U.S. Government Printing Office, Washington, D.C., 1955). $\sin x$, $\cos x$, $x=0(.001)25.2$, $0(1)100$, 8D, $x=10^{-n}(10^{-n})9 \times 10^{-n}$, $n=5, 4, 3, 2, 1$, 15D, $x=0(.00001) .01$, 12D.
- [4.23] National Bureau of Standards, Tables of circular and hyperbolic sines and cosines for radian arguments, 2d ed., Applied Math. Series 36 (U.S. Government Printing Office, Washington, D.C., 1953). $\sin x$, $\cos x$, $\sinh x$, $\cosh x$, $x=0(.0001) 1.9999$, $0(.1)10$, 9D.
- [4.24] National Bureau of Standards, Table of circular and hyperbolic tangents and cotangents for radian arguments, 2d printing (Columbia Univ. Press, New York, N.Y., 1947). $\tan x$, $\cot x$, $\tanh x$, $\coth x$, $x=0(.0001)2$, 8D or 8S, $x=0(.1)10$, 10D.
- [4.25] National Bureau of Standards, Table of sines and cosines to fifteen decimal places at hundredths of a degree, Applied Math. Series 5 (U.S. Government Printing Office, Washington, D.C., 1949). $\sin x$, $\cos x$, $x=0^\circ(.01^\circ)90^\circ$, 15D; supplementary table of $\sin x$, $\cos x$, $x=1^\circ(1^\circ)89^\circ$, 30 D.
- [4.26] National Bureau of Standards, Table of secants and cosecants to nine significant figures at hundredths of a degree, Applied Math. Series 40 (U.S. Government Printing Office, Washington, D.C., 1954).
- [4.27] National Bureau of Standards, Tables of functions and of zeros of functions, Collected short tables of the Computation Laboratory, Applied Math. Series 37 (U.S. Government Printing Office, Washington, D.C., 1954).
- [4.28] National Bureau of Standards, Table of arcsin x (Columbia Univ. Press, New York, N.Y., 1945). arcsin x , $x=0(.0001) .989(.00001)1$, 12D; auxiliary table of $f(v)=\frac{1}{2}\pi - \arcsin(1-v)/(2v)^n$, $v=0(.00001) .0005$, 13D.
- [4.29] National Bureau of Standards, Tables of arctan x , 2d ed., Applied Math. Series 26 (U.S. Government Printing Office, Washington D.C., 1953). $x=0(.001)7(.01)50(.1)300(1)2000(10)10000$, 12D.
- [4.30] National Bureau of Standards, Table of hyperbolic sines and cosines, $x=2$ to $x=10$, Applied Math. Series 45 (U.S. Government Printing Office, Washington, D.C., 1955). $x=2(.001)10$, 9S.
- [4.31] B. O. Peirce, A short table of integrals, 4th ed. (Ginn and Co., Boston, Mass., 1956).
- [4.32] J. Peters, Ten-place logarithm table, vols. 1, 2 (together with an appendix of mathematical tables), (Berlin, 1922; rev. ed., Frederick Ungar Publ. Co., New York, N.Y., 1957).
- [4.33] J. Peters, Seven-place values of trigonometric functions for every thousandth of a degree (Berlin-Friedenau, 1918; D. Van Nostrand Co., Inc., New York, N.Y., 1942).
- [4.34] L. W. Pollak, Rechentafeln zur harmonischen Analyse (Johann Ambrosius Barth, Leipzig, Germany, 1926).
- [4.35] A. J. Thompson, Standard table of logarithms to twenty decimal places, Tracts for Computers, No. 22 (Cambridge Univ. Press, Cambridge, England, and New York, N.Y., 1952).
- [4.36] J. Todd, Table of arctangents of rational numbers, NBS Applied Math. Series 11 (U.S. Government Printing Office, Washington, D.C., 1951). arctan m/n and arccot m/n , $0 < m < n \leq 100$, 12D; reductions of arctan m/n , $0 < m < n \leq 100$; reductions of arctan n for reducible $n \leq 2089$.
- [4.37] U.S. Department of Commerce, Coast and Geodetic Survey, Natural sines and cosines to eight decimal places, Special Publication No. 231 (U.S. Government Printing Office, Washington, D.C., 1942).
- [4.38] C. E. Van Ostrand, Tables of the exponential function and of the circular sine and cosine to radian arguments, Memoirs of the National Academy of Sciences 14, 5th Memoir (U.S. Government Printing Office, Washington, D.C., 1921).
- [4.39] B. V. Vega, Logarithmic tables of numbers and trigonometrical functions (G. E. Stechert & Co., New York, N.Y., 1905); $\log_{10} x$, $x=1(1)100000$; logarithms of the trigonometrical functions for every ten seconds.

COMMON LOGARITHMS

Table 4.1

x	$\log_{10} x$	x	$\log_{10} x$	x	$\log_{10} x$	x	$\log_{10} x$	x	$\log_{10} x$
100	00000 00000	150	17609 12591	200	30102 99957	250	39794 00087	300	47712 12547
101	00432 13738	151	17897 69473	201	30319 60574	251	39967 37215	301	47856 64956
102	00860 01718	152	18184 35879	202	30535 13694	252	40140 05408	302	48000 69430
103	01283 72247	153	18469 14308	203	30749 60379	253	40312 05212	303	48144 26285
104	01703 33393	154	18752 07208	204	30963 01674	254	40483 37166	304	48287 35836
105	02118 92991	155	19033 16982	205	31175 38611	255	40654 01804	305	48429 98393
106	02530 58653	156	19312 45984	206	31386 72204	256	40823 99653	306	48572 14265
107	02938 37777	157	19589 96524	207	31597 03455	257	40993 31233	307	48713 83755
108	03342 37555	158	19865 70870	208	31806 33350	258	41161 97060	308	48855 07165
109	03742 64979	159	20139 71243	209	32014 62861	259	41329 97641	309	48995 84794
110	04139 26852	160	20411 99827	210	32221 92947	260	41497 33480	310	49136 16938
111	04532 29788	161	20682 58760	211	32428 24553	261	41664 05073	311	49276 03890
112	04921 80227	162	20951 50145	212	32633 58609	262	41830 12913	312	49415 45940
113	05307 84435	163	21218 76044	213	32837 96034	263	41995 57485	313	49554 43375
114	05690 48513	164	21484 38480	214	33041 37733	264	42160 39269	314	49692 96481
115	06069 78404	165	21748 39442	215	33243 84599	265	42324 58739	315	49831 05538
116	06445 79892	166	22010 80880	216	33445 37512	266	42488 16366	316	49968 70826
117	06818 58617	167	22271 64711	217	33645 97338	267	42651 12614	317	50105 92622
118	07188 20073	168	22530 92817	218	33845 64936	268	42813 47940	318	50242 71200
119	07554 69614	169	22788 67046	219	34044 41148	269	42975 22800	319	50379 06831
120	07918 12460	170	23044 89214	220	34242 26808	270	43136 37642	320	50514 99783
121	08278 53703	171	23299 61104	221	34439 22737	271	43296 92909	321	50650 50324
122	08635 98307	172	23552 84469	222	34635 29745	272	43456 89040	322	50785 58717
123	08990 51114	173	23804 61031	223	34830 48630	273	43616 26470	323	50920 25223
124	09342 16852	174	24054 92483	224	35024 80183	274	43775 05628	324	51054 50102
125	09691 00130	175	24303 80487	225	35218 25181	275	43933 26938	325	51188 33610
126	10037 05451	176	24551 26678	226	35410 84391	276	44090 90821	326	51321 76001
127	10380 37210	177	24797 32664	227	35602 58572	277	44247 97691	327	51454 77527
128	10720 99696	178	25042 00023	228	35793 48470	278	44404 47959	328	51587 38437
129	11058 97103	179	25285 30310	229	35983 54823	279	44560 42033	329	51719 58979
130	11394 33523	180	25527 25051	230	36172 78360	280	44715 80313	330	51851 39399
131	11727 12957	181	25767 85749	231	36361 19799	281	44870 63199	331	51982 79938
132	12057 39312	182	26007 13880	232	36548 79849	282	45024 91083	332	52113 80837
133	12385 16410	183	26245 10897	233	36735 59210	283	45178 64355	333	52244 42335
134	12710 47984	184	26481 78230	234	36921 58574	284	45331 83400	334	52374 64668
135	13033 37685	185	26717 17284	235	37106 78623	285	45484 48600	335	52504 48070
136	13353 89084	186	26951 29442	236	37291 20030	286	45636 60331	336	52633 92774
137	13672 05672	187	27184 16065	237	37474 83460	287	45788 18967	337	52762 99009
138	13987 90864	188	27415 78493	238	37657 69571	288	45939 24878	338	52891 67003
139	14301 48003	189	27646 18042	239	37839 79009	289	46089 78428	339	53019 96982
140	14612 80357	190	27875 36010	240	38021 12417	290	46239 79979	340	53147 89170
141	14921 91127	191	28103 33672	241	38201 70426	291	46389 29890	341	53275 43790
142	15228 83444	192	28330 12287	242	38381 53660	292	46538 28514	342	53402 61061
143	15533 60375	193	28555 73090	243	38560 62736	293	46686 76204	343	53529 41200
144	15836 24921	194	28780 17299	244	38738 98263	294	46834 73304	344	53655 84426
145	16136 80022	195	29003 46114	245	38916 60844	295	46982 20160	345	53781 90951
146	16435 28558	196	29225 60714	246	39093 51071	296	47129 17111	346	53907 60988
147	16731 73347	197	29446 62262	247	39269 69533	297	47275 64493	347	54032 94748
148	17026 17154	198	29666 51903	248	39445 16808	298	47421 62641	348	54157 92439
149	17318 62684	199	29885 30764	249	39619 93471	299	47567 11883	349	54282 54270
150	17609 12591	200	30102 99957	250	39794 00087	300	47712 12547	350	54406 80444
	$\left[\begin{smallmatrix} (-6)6 \\ 5 \end{smallmatrix} \right]$		$\left[\begin{smallmatrix} (-6)2 \\ 5 \end{smallmatrix} \right]$		$\left[\begin{smallmatrix} (-6)1 \\ 4 \end{smallmatrix} \right]$		$\left[\begin{smallmatrix} (-7)9 \\ 4 \end{smallmatrix} \right]$		$\left[\begin{smallmatrix} (-7)6 \\ 4 \end{smallmatrix} \right]$

For use of common logarithms see Examples 1-3. For $100 < x < 135$ interpolate in the range $1000 < x < 1350$. Compiled from A. J. Thompson, Standard table of logarithms to twenty decimal places, Tracts for Computers. No. 22. Cambridge Univ. Press, Cambridge, England, 1952 (with permission).

Table 4.1

COMMON LOGARITHMS

x	$\log_{10} x$	x	$\log_{10} x$	x	$\log_{10} x$	x	$\log_{10} x$	x	$\log_{10} x$					
350	54406	80444	400	60205	99913	450	65321	25138	500	69897	00043	550	74036	26895
351	54530	71165	401	60314	43726	451	65417	65419	501	69983	77259	551	74115	15989
352	54654	26635	402	60422	60531	452	65513	84348	502	70070	37171	552	74193	90777
353	54777	47054	403	60530	50461	453	65609	82020	503	70156	79851	553	74272	51313
354	54900	32620	404	60638	13651	454	65705	58529	504	70243	05364	554	74350	97647
355	55022	83531	405	60745	50232	455	65801	13967	505	70329	13781	555	74429	29831
356	55144	99980	406	60852	60336	456	65896	48427	506	70415	05168	556	74507	47916
357	55266	82161	407	60959	44092	457	65991	62001	507	70500	79593	557	74585	51952
358	55388	30266	408	61066	01631	458	66086	54780	508	70586	37123	558	74663	41989
359	55509	44486	409	61172	33080	459	66181	26855	509	70671	77823	559	74741	18079
360	55630	25008	410	61278	38567	460	66275	78317	510	70757	01761	560	74818	80270
361	55750	72019	411	61384	18219	461	66370	09254	511	70842	09001	561	74896	28613
362	55870	85705	412	61489	72160	462	66464	19756	512	70926	99610	562	74973	63156
363	55990	66250	413	61595	00517	463	66558	09910	513	71011	73651	563	75050	83949
364	56110	13836	414	61700	03411	464	66651	79806	514	71096	31190	564	75127	91040
365	56229	28645	415	61804	80967	465	66745	29529	515	71180	72290	565	75204	84478
366	56348	10854	416	61909	33306	466	66838	59167	516	71264	97016	566	75281	64312
367	56466	60643	417	62013	60550	467	66931	68806	517	71349	05431	567	75358	30589
368	56584	78187	418	62117	62818	468	67024	58531	518	71432	97597	568	75434	83357
369	56702	63662	419	62221	40230	469	67117	28427	519	71516	73578	569	75511	22664
370	56820	17241	420	62324	92904	470	67209	78579	520	71600	33436	570	75587	48557
371	56937	39096	421	62428	20958	471	67302	09071	521	71683	77233	571	75663	61082
372	57054	29399	422	62531	24510	472	67394	19986	522	71767	05030	572	75739	60288
373	57170	88318	423	62634	03674	473	67486	11407	523	71850	16889	573	75815	46220
374	57287	16022	424	62736	58566	474	67577	83417	524	71933	12870	574	75891	18924
375	57403	12677	425	62838	89301	475	67669	36096	525	72015	93034	575	75966	78447
376	57518	78449	426	62940	95991	476	67760	69527	526	72098	57442	576	76042	24834
377	57634	13502	427	63042	78750	477	67851	83790	527	72181	06152	577	76117	58132
378	57749	17998	428	63144	37690	478	67942	78966	528	72263	39225	578	76192	78384
379	57863	92100	429	63245	72922	479	68033	55134	529	72345	56720	579	76267	85637
380	57978	35966	430	63346	84556	480	68124	12374	530	72427	58696	580	76342	79936
381	58092	49757	431	63447	72702	481	68214	50764	531	72509	45211	581	76417	61324
382	58206	33629	432	63548	37468	482	68304	70382	532	72591	16323	582	76492	29846
383	58319	87740	433	63648	78964	483	68394	71308	533	72672	72090	583	76566	85548
384	58433	12244	434	63748	97295	484	68484	53616	534	72754	12570	584	76641	28471
385	58546	07295	435	63848	92570	485	68574	17386	535	72835	37820	585	76715	58661
386	58658	73047	436	63948	64893	486	68663	62693	536	72916	47897	586	76789	76160
387	58771	09650	437	64048	14370	487	68752	89612	537	72997	42857	587	76863	81012
388	58883	17256	438	64147	41105	488	68841	98220	538	73078	22757	588	76937	73261
389	58994	96013	439	64246	45202	489	68930	88591	539	73158	87652	589	77011	52948
390	59106	46070	440	64345	26765	490	69019	60800	540	73239	37598	590	77085	20116
391	59217	67574	441	64443	85895	491	69108	14921	541	73319	72651	591	77158	74809
392	59328	60670	442	64542	22693	492	69196	51028	542	73399	92865	592	77232	17067
393	59439	25504	443	64640	37262	493	69284	69193	543	73479	98296	593	77305	46934
394	59549	62218	444	64738	29701	494	69372	69489	544	73559	88997	594	77378	64450
395	59659	70956	445	64836	00110	495	69460	51989	545	73639	65023	595	77451	69657
396	59769	51859	446	64933	48587	496	69548	16765	546	73719	26427	596	77524	62597
397	59879	05068	447	65030	75231	497	69635	63887	547	73798	73263	597	77597	43311
398	59988	30721	448	65127	80140	498	69722	93428	548	73878	05585	598	77670	11840
399	60097	28957	449	65224	63410	499	69810	05456	549	73957	23445	599	77742	68224
400	60205	99913	450	65321	25138	500	69897	00043	550	74036	26895	600	77815	12504
	$\left[\begin{matrix} (-7)4 \\ 4 \end{matrix} \right]$			$\left[\begin{matrix} (-7)3 \\ 4 \end{matrix} \right]$			$\left[\begin{matrix} (-7)3 \\ 4 \end{matrix} \right]$			$\left[\begin{matrix} (-7)2 \\ 4 \end{matrix} \right]$			$\left[\begin{matrix} (-7)2 \\ 4 \end{matrix} \right]$	

COMMON LOGARITHMS

Table 4.1

x	$\log_{10} x$	x	$\log_{10} x$	x	$\log_{10} x$	x	$\log_{10} x$	x	$\log_{10} x$
600	77815 12504	650	81291 33566	700	84509 80400	750	87506 12634	800	90308 99870
601	77887 44720	651	81358 09886	701	84571 80180	751	87563 99370	801	90363 25161
602	77959 64913	652	81424 75957	702	84633 71121	752	87621 78406	802	90417 43683
603	78031 73121	653	81491 31813	703	84695 53250	753	87679 49762	803	90471 55453
604	78103 69386	654	81557 77483	704	84757 26591	754	87737 13459	804	90525 60487
605	78175 53747	655	81624 13000	705	84818 91170	755	87794 69516	805	90579 58804
606	78247 26242	656	81690 38394	706	84880 47011	756	87852 17955	806	90633 50418
607	78318 86911	657	81756 53696	707	84941 94138	757	87909 58795	807	90687 35347
608	78390 35793	658	81822 58936	708	85003 32577	758	87966 92056	808	90741 13608
609	78461 72926	659	81888 54146	709	85064 62352	759	88024 17759	809	90794 85216
610	78532 98350	660	81954 39355	710	85125 83487	760	88081 35923	810	90848 50189
611	78604 12102	661	82020 14595	711	85186 96007	761	88138 46568	811	90902 08542
612	78675 14221	662	82085 79894	712	85247 99936	762	88195 49713	812	90955 60292
613	78746 04745	663	82151 35284	713	85308 95299	763	88252 45380	813	91009 05456
614	78816 83711	664	82216 80794	714	85369 82118	764	88309 33586	814	91062 44049
615	78887 51158	665	82282 16453	715	85430 60418	765	88366 14352	815	91115 76087
616	78958 07122	666	82347 42292	716	85491 30223	766	88422 87696	816	91169 01588
617	79028 51640	667	82412 58339	717	85551 91557	767	88479 53639	817	91222 20565
618	79098 84751	668	82477 64625	718	85612 44442	768	88536 12200	818	91275 33037
619	79169 06490	669	82542 61178	719	85672 88904	769	88592 63398	819	91328 39018
620	79239 16895	670	82607 48027	720	85733 24964	770	88649 07252	820	91381 38524
621	79309 16002	671	82672 25202	721	85793 52647	771	88705 43781	821	91434 31571
622	79379 03847	672	82736 92731	722	85853 71976	772	88761 73003	822	91487 18175
623	79448 80467	673	82801 50642	723	85913 82973	773	88817 94939	823	91539 98352
624	79518 45897	674	82865 98965	724	85973 85662	774	88874 09607	824	91592 72117
625	79588 00173	675	82930 37728	725	86033 80066	775	88930 17025	825	91645 39485
626	79657 43332	676	82994 66959	726	86093 66207	776	88986 17213	826	91698 00473
627	79726 75408	677	83058 86687	727	86153 44109	777	89042 10188	827	91750 55096
628	79795 96437	678	83122 96939	728	86213 13793	778	89097 95970	828	91803 03368
629	79865 06454	679	83186 97743	729	86272 75283	779	89153 74577	829	91855 45306
630	79934 05495	680	83250 89127	730	86332 28601	780	89209 46027	830	91907 80924
631	80002 93592	681	83314 71119	731	86391 73770	781	89265 10339	831	91960 10238
632	80071 70783	682	83378 43747	732	86451 10811	782	89320 67531	832	92012 33263
633	80140 37100	683	83442 07037	733	86510 39746	783	89376 17621	833	92064 50014
634	80208 92579	684	83505 61017	734	86569 60599	784	89431 60627	834	92116 60506
635	80277 37253	685	83569 05715	735	86628 73391	785	89486 96567	835	92168 64755
636	80345 71156	686	83632 41157	736	86687 78143	786	89542 25460	836	92220 62774
637	80413 94323	687	83695 67371	737	86746 74879	787	89597 47324	837	92272 54580
638	80482 06787	688	83758 84382	738	86805 63618	788	89652 62175	838	92324 40186
639	80550 08582	689	83821 92219	739	86864 44384	789	89707 70032	839	92376 19608
640	80617 99740	690	83884 90907	740	86923 17197	790	89762 70913	840	92427 92861
641	80685 80295	691	83947 80474	741	86981 82080	791	89817 64835	841	92479 59958
642	80753 50281	692	84010 60945	742	87040 39053	792	89872 51816	842	92531 20915
643	80821 09729	693	84073 32346	743	87098 88138	793	89927 31873	843	92582 75746
644	80888 58674	694	84135 94705	744	87157 29355	794	89982 05024	844	92634 24466
645	80955 97146	695	84198 48046	745	87215 62727	795	90036 71287	845	92685 67089
646	81023 25180	696	84260 92396	746	87273 88275	796	90091 30677	846	92737 03630
647	81090 42807	697	84323 27781	747	87332 06018	797	90145 83214	847	92788 34103
648	81157 50059	698	84385 54226	748	87390 15979	798	90200 28914	848	92839 58523
649	81224 46968	699	84447 71757	749	87448 18177	799	90254 67793	849	92890 76902
650	81291 33566	700	84509 80400	750	87506 12634	800	90308 99870	850	92941 89257
	$\left[\begin{matrix} (-7)2 \\ 4 \end{matrix} \right]$		$\left[\begin{matrix} (-7)1 \\ 4 \end{matrix} \right]$		$\left[\begin{matrix} (-7)1 \\ 4 \end{matrix} \right]$		$\left[\begin{matrix} (-7)1 \\ 4 \end{matrix} \right]$		$\left[\begin{matrix} (-8)8 \\ 4 \end{matrix} \right]$

Table 4.1

COMMON LOGARITHMS

x	$\log_{10} x$	x	$\log_{10} x$	x	$\log_{10} x$	x	$\log_{10} x$	x	$\log_{10} x$
850	92941 89257	900	95424 25094	950	97772 36053	1000	00000 00000	1050	02118 92991
851	92992 95601	901	95472 47910	951	97818 05169	1001	00043 40775	1051	02160 27160
852	93043 95948	902	95520 65375	952	97863 69484	1002	00086 77215	1052	02201 57398
853	93094 90312	903	95568 77503	953	97909 29006	1003	00130 09330	1053	02242 83712
854	93145 78707	904	95616 84305	954	97954 83747	1004	00173 37128	1054	02284 06109
855	93196 61147	905	95664 85792	955	98000 33716	1005	00216 60618	1055	02325 24596
856	93247 37647	906	95712 81977	956	98045 78923	1006	00259 79807	1056	02366 39182
857	93298 08219	907	95760 72871	957	98091 19378	1007	00302 94706	1057	02407 49873
858	93348 72878	908	95808 58485	958	98136 55091	1008	00346 05321	1058	02448 56677
859	93399 31638	909	95856 38832	959	98181 86072	1009	00389 11662	1059	02489 59601
860	93449 84512	910	95904 13923	960	98227 12330	1010	00432 13738	1060	02530 58653
861	93500 31515	911	95951 83770	961	98272 33877	1011	00475 11556	1061	02571 53839
862	93550 72658	912	95999 48383	962	98317 50720	1012	00518 05125	1062	02612 45167
863	93601 07957	913	96047 07775	963	98362 62871	1013	00560 94454	1063	02653 32645
864	93651 37425	914	96094 61957	964	98407 70339	1014	00603 79550	1064	02694 16280
865	93701 61075	915	96142 10941	965	98452 73133	1015	00646 60422	1065	02734 96078
866	93751 78920	916	96189 54737	966	98497 71264	1016	00689 37079	1066	02775 72047
867	93801 90975	917	96236 93357	967	98542 64741	1017	00732 09529	1067	02816 44194
868	93851 97252	918	96284 26812	968	98587 53573	1018	00774 77780	1068	02857 12527
869	93901 97764	919	96331 55114	969	98632 37771	1019	00817 41840	1069	02897 77052
870	93951 92526	920	96378 78273	970	98677 17343	1020	00860 01718	1070	02938 37777
871	94001 81550	921	96425 96302	971	98721 92299	1021	00902 57421	1071	02978 94708
872	94051 64849	922	96473 09211	972	98766 62649	1022	00945 08958	1072	03019 47854
873	94101 42437	923	96520 17010	973	98811 28403	1023	00987 56337	1073	03059 97220
874	94151 14326	924	96567 19712	974	98855 89569	1024	01029 99566	1074	03100 42814
875	94200 80530	925	96614 17327	975	98900 46157	1025	01072 38654	1075	03140 84643
876	94250 41062	926	96661 09867	976	98944 98177	1026	01114 73608	1076	03181 22713
877	94299 95934	927	96707 97341	977	98989 45637	1027	01157 04436	1077	03221 57033
878	94349 45159	928	96754 79762	978	99033 88548	1028	01199 31147	1078	03261 87609
879	94398 88751	929	96801 57140	979	99078 26918	1029	01241 53748	1079	03302 14447
880	94448 26722	930	96848 29486	980	99122 60757	1030	01283 72247	1080	03342 37555
881	94497 59084	931	96894 96810	981	99166 90074	1031	01325 86653	1081	03382 56940
882	94546 85851	932	96941 59124	982	99211 14878	1032	01367 96973	1082	03422 72608
883	94596 07036	933	96988 16437	983	99255 35178	1033	01410 03215	1083	03462 84566
884	94645 22650	934	97034 68762	984	99299 50984	1034	01452 05388	1084	03502 92822
885	94694 32707	935	97081 16109	985	99343 62305	1035	01494 03498	1085	03542 97382
886	94743 37219	936	97127 58487	986	99387 69149	1036	01535 97554	1086	03582 98253
887	94792 36198	937	97173 95909	987	99431 71527	1037	01577 87564	1087	03622 95441
888	94841 29658	938	97220 28384	988	99475 69446	1038	01619 73535	1088	03662 88954
889	94890 17610	939	97266 55923	989	99519 62916	1039	01661 55476	1089	03702 78798
890	94939 00066	940	97312 78536	990	99563 51946	1040	01703 33393	1090	03742 64979
891	94987 77040	941	97358 96234	991	99607 36545	1041	01745 07295	1091	03782 47506
892	95036 48544	942	97405 09028	992	99651 16722	1042	01786 77190	1092	03822 26384
893	95085 14589	943	97451 16927	993	99694 92485	1043	01828 43084	1093	03862 01619
894	95133 75188	944	97497 19943	994	99738 63844	1044	01870 04987	1094	03901 73220
895	95182 30353	945	97543 18085	995	99782 30807	1045	01911 62904	1095	03941 41192
896	95230 80097	946	97589 11364	996	99825 93384	1046	01953 16845	1096	03981 05541
897	95279 24430	947	97634 99790	997	99869 51583	1047	01994 66817	1097	04020 66276
898	95327 63367	948	97680 83373	998	99913 05413	1048	02036 12826	1098	04060 23401
899	95375 96917	949	97726 62124	999	99956 54882	1049	02077 54882	1099	04099 76924
900	95424 25094	950	97772 36053	1000	00000 00000	1050	02118 92991	1100	04139 26852
	$\left[\begin{smallmatrix} (-8)8 \\ 4 \end{smallmatrix} \right]$		$\left[\begin{smallmatrix} (-8)7 \\ 4 \end{smallmatrix} \right]$		$\left[\begin{smallmatrix} (-8)6 \\ 3 \end{smallmatrix} \right]$		$\left[\begin{smallmatrix} (-8)5 \\ 3 \end{smallmatrix} \right]$		$\left[\begin{smallmatrix} (-8)5 \\ 3 \end{smallmatrix} \right]$

COMMON LOGARITHMS

Table 4.1

x	$\log_{10} x$	x	$\log_{10} x$	x	$\log_{10} x$	x	$\log_{10} x$	x	$\log_{10} x$
1100	04139 26852	1150	06069 78404	1200	07918 12460	1250	09691 00130	1300	11394 33523
1101	04178 73190	1151	06107 53236	1201	07954 30074	1251	09725 73097	1301	11427 72966
1102	04218 15945	1152	06145 24791	1202	07990 44677	1252	09760 43289	1302	11461 09842
1103	04257 55124	1153	06182 93073	1203	08026 56273	1253	09795 10710	1303	11494 44157
1104	04296 90734	1154	06220 58088	1204	08062 64869	1254	09829 75365	1304	11527 75914
1105	04336 22780	1155	06258 19842	1205	08098 70469	1255	09864 37258	1305	11561 05117
1106	04375 51270	1156	06295 78341	1206	08134 73078	1256	09898 96394	1306	11594 31769
1107	04414 76209	1157	06333 33590	1207	08170 72701	1257	09933 52777	1307	11627 55876
1108	04453 97604	1158	06370 85594	1208	08206 69343	1258	09968 06411	1308	11660 77440
1109	04493 15461	1159	06408 34360	1209	08242 63009	1259	10002 57301	1309	11693 96466
1110	04532 29788	1160	06445 79892	1210	08278 53703	1260	10037 05451	1310	11727 12957
1111	04571 40589	1161	06483 22197	1211	08314 41431	1261	10071 50866	1311	11760 26917
1112	04610 47872	1162	06520 61281	1212	08350 26198	1262	10105 93549	1312	11793 38350
1113	04649 51643	1163	06557 97147	1213	08386 08009	1263	10140 33506	1313	11826 47261
1114	04688 51908	1164	06595 29803	1214	08421 86867	1264	10174 70739	1314	11859 53652
1115	04727 48674	1165	06632 59254	1215	08457 62779	1265	10209 05255	1315	11892 57528
1116	04766 41946	1166	06669 85504	1216	08493 35749	1266	10243 37057	1316	11925 58893
1117	04805 31731	1167	06707 08560	1217	08529 05782	1267	10277 66149	1317	11958 57750
1118	04844 18036	1168	06744 28428	1218	08564 72883	1268	10311 92535	1318	11991 54103
1119	04883 00865	1169	06781 45112	1219	08600 37056	1269	10346 16221	1319	12024 47955
1120	04921 80227	1170	06818 58617	1220	08635 98307	1270	10380 37210	1320	12057 39312
1121	04960 56126	1171	06855 68951	1221	08671 56639	1271	10414 55506	1321	12090 28176
1122	04999 28569	1172	06892 76117	1222	08707 12059	1272	10448 71113	1322	12123 14551
1123	05037 97563	1173	06929 80121	1223	08742 64570	1273	10482 84037	1323	12155 98442
1124	05076 63112	1174	06966 80969	1224	08778 14178	1274	10516 94280	1324	12188 79851
1125	05115 25224	1175	07003 78666	1225	08813 60887	1275	10551 01848	1325	12221 58783
1126	05153 83905	1176	07040 73217	1226	08849 04702	1276	10585 06744	1326	12254 35241
1127	05192 39160	1177	07077 64628	1227	08884 45627	1277	10619 08973	1327	12287 09229
1128	05230 90996	1178	07114 52905	1228	08919 83668	1278	10653 08538	1328	12319 80750
1129	05269 39419	1179	07151 38051	1229	08955 18829	1279	10687 05445	1329	12352 49809
1130	05307 84435	1180	07188 20073	1230	08990 51114	1280	10720 99696	1330	12385 16410
1131	05346 26049	1181	07224 98976	1231	09025 80529	1281	10754 91297	1331	12417 80555
1132	05384 64269	1182	07261 74765	1232	09061 07078	1282	10788 80252	1332	12450 42248
1133	05422 99099	1183	07298 47446	1233	09096 30766	1283	10822 66564	1333	12483 01494
1134	05461 30546	1184	07335 17024	1234	09131 51597	1284	10856 50237	1334	12515 58296
1135	05499 58615	1185	07371 83503	1235	09166 69576	1285	10890 31277	1335	12548 12657
1136	05537 83314	1186	07408 46390	1236	09201 84708	1286	10924 09686	1336	12580 64581
1137	05576 04647	1187	07445 07190	1237	09236 96996	1287	10957 85469	1337	12613 14073
1138	05614 22621	1188	07481 64406	1238	09272 06447	1288	10991 58630	1338	12645 61134
1139	05652 37241	1189	07518 18546	1239	09307 13064	1289	11025 29174	1339	12678 05770
1140	05690 48513	1190	07554 69514	1240	09342 16852	1290	11058 97103	1340	12710 47984
1141	05728 56444	1191	07591 17515	1241	09377 17815	1291	11092 62423	1341	12742 87779
1142	05766 61039	1192	07627 62554	1242	09412 15958	1292	11126 25137	1342	12775 25158
1143	05804 62304	1193	07664 04437	1243	09447 11286	1293	11159 85249	1343	12807 60127
1144	05842 60245	1194	07700 43268	1244	09482 03804	1294	11193 42763	1344	12839 92687
1145	05880 54867	1195	07736 79053	1245	09516 93514	1295	11226 97684	1345	12872 22843
1146	05918 46176	1196	07773 11797	1246	09551 80423	1296	11260 50015	1346	12904 50599
1147	05956 34179	1197	07809 41504	1247	09586 64535	1297	11293 99761	1347	12936 75957
1148	05994 18881	1198	07845 68181	1248	09621 45853	1298	11327 46925	1348	12968 98922
1149	06032 00287	1199	07881 91331	1249	09656 24384	1299	11360 91511	1349	13001 19497
1150	06069 78404	1200	07918 12460	1250	09691 00130	1300	11394 33523	1350	13033 37685
	$\left[\begin{smallmatrix} (-8)5 \\ 3 \end{smallmatrix} \right]$		$\left[\begin{smallmatrix} (-8)4 \\ 3 \end{smallmatrix} \right]$		$\left[\begin{smallmatrix} (-8)4 \\ 3 \end{smallmatrix} \right]$		$\left[\begin{smallmatrix} (-8)3 \\ 3 \end{smallmatrix} \right]$		$\left[\begin{smallmatrix} (-8)3 \\ 3 \end{smallmatrix} \right]$

Table 4.2

NATURAL LOGARITHMS

x	$\ln x$			x	$\ln x$			x	$\ln x$		
0.000	-∞			0.050	-2.99573	22735	539910	0.100	-2.30258	50929	940457
0.001	-6.90775	52789	821371	0.051	-2.97592	96462	578113	0.101	-2.29263	47621	408776
0.002	-6.21460	80984	221917	0.052	-2.95651	15604	007097	0.102	-2.28278	24656	978660
0.003	-5.80914	29903	140274	0.053	-2.93746	33654	300152	0.103	-2.27302	62907	525013
0.004	-5.52146	09178	622464	0.054	-2.91877	12324	178627	0.104	-2.26336	43798	407644
0.005	-5.29831	73665	480367	0.055	-2.90042	20937	496661	0.105	-2.25379	49288	246137
0.006	-5.11599	58097	540821	0.056	-2.88240	35882	469878	0.106	-2.24431	61848	700699
0.007	-4.96184	51299	268237	0.057	-2.86470	40111	475869	0.107	-2.23492	64445	202309
0.008	-4.82831	37373	023011	0.058	-2.84731	22684	357177	0.108	-2.22562	40518	579174
0.009	-4.71053	07016	459177	0.059	-2.83021	78350	764176	0.109	-2.21640	73967	529934
0.010	-4.60517	01859	880914	0.060	-2.81341	07167	600364	0.110	-2.20727	49131	897208
0.011	-4.50986	00061	837665	0.061	-2.79688	14148	088258	0.111	-2.19822	50776	698029
0.012	-4.42284	86291	941367	0.062	-2.78062	08939	370455	0.112	-2.18925	64076	870425
0.013	-4.34280	59215	206003	0.063	-2.76462	05525	906044	0.113	-2.18036	74602	697965
0.014	-4.26869	79493	668784	0.064	-2.74887	21956	224652	0.114	-2.17155	68305	876416
0.015	-4.19970	50778	799270	0.065	-2.73336	80090	864999	0.115	-2.16282	31506	188870
0.016	-4.13516	65567	423558	0.066	-2.71810	05369	557115	0.116	-2.15416	50878	757724
0.017	-4.07454	19349	259210	0.067	-2.70306	26595	911710	0.117	-2.14558	13441	843809
0.018	-4.01738	35210	859724	0.068	-2.68824	75738	060304	0.118	-2.13707	06545	164723
0.019	-3.96331	62998	156966	0.069	-2.67364	87743	848777	0.119	-2.12863	17858	706077
0.020	-3.91202	30054	281461	0.070	-2.65926	00369	327781	0.120	-2.12026	35362	000911
0.021	-3.86323	28412	587141	0.071	-2.64507	54019	408216	0.121	-2.11196	47333	853960
0.022	-3.81671	28256	238212	0.072	-2.63108	91599	660817	0.122	-2.10373	42342	488805
0.023	-3.77226	10630	529874	0.073	-2.61729	58378	337459	0.123	-2.09557	09236	097196
0.024	-3.72970	14486	341914	0.074	-2.60369	01857	779673	0.124	-2.08747	37133	771002
0.025	-3.68887	94541	139363	0.075	-2.59026	71654	458266	0.125	-2.07944	15416	798359
0.026	-3.64965	87409	606550	0.076	-2.57702	19386	958060	0.126	-2.07147	33720	306591
0.027	-3.61191	84129	778080	0.077	-2.56394	98571	284532	0.127	-2.06356	81925	235458
0.028	-3.57555	07688	069331	0.078	-2.55104	64522	925453	0.128	-2.05572	50150	625199
0.029	-3.54045	94489	956630	0.079	-2.53830	74265	151156	0.129	-2.04794	28746	204649
0.030	-3.50655	78973	199817	0.080	-2.52572	86443	082554	0.130	-2.04022	08285	265546
0.031	-3.47376	80744	969908	0.081	-2.51330	61243	096983	0.131	-2.03255	79557	809855
0.032	-3.44201	93761	824105	0.082	-2.50103	60317	178839	0.132	-2.02495	33563	957662
0.033	-3.41124	77175	156568	0.083	-2.48891	46711	855391	0.133	-2.01740	61507	603833
0.034	-3.38139	47543	659757	0.084	-2.47693	84801	388234	0.134	-2.00991	54790	312257
0.035	-3.35240	72174	927234	0.085	-2.46510	40224	918206	0.135	-2.00248	05005	437076
0.036	-3.32423	63405	260271	0.086	-2.45340	79827	286293	0.136	-1.99510	03932	460850
0.037	-3.29683	73663	379126	0.087	-2.44184	71603	275533	0.137	-1.98777	43531	540121
0.038	-3.27016	91192	557513	0.088	-2.43041	84645	039306	0.138	-1.98050	15938	249324
0.039	-3.24419	36328	524906	0.089	-2.41911	89092	499972	0.139	-1.97328	13458	514453
0.040	-3.21887	58248	682007	0.090	-2.40794	56086	518720	0.140	-1.96611	28563	728328
0.041	-3.19418	32122	778292	0.091	-2.39689	57724	652870	0.141	-1.95899	53886	039688
0.042	-3.17008	56606	987687	0.092	-2.38596	67019	330967	0.142	-1.95192	82213	808763
0.043	-3.14655	51632	885746	0.093	-2.37515	57858	288811	0.143	-1.94491	06487	222298
0.044	-3.12356	56450	638759	0.094	-2.36446	04967	121332	0.144	-1.93794	19794	061364
0.045	-3.10109	27892	118173	0.095	-2.35387	83873	815962	0.145	-1.93102	15365	615627
0.046	-3.07911	38824	930421	0.096	-2.34340	70875	143008	0.146	-1.92414	86572	738006
0.047	-3.05760	76772	720785	0.097	-2.33304	43004	787542	0.147	-1.91732	26922	034008
0.048	-3.03655	42680	742461	0.098	-2.32278	78003	115651	0.148	-1.91054	30052	180220
0.049	-3.01593	49808	715104	0.099	-2.31263	54288	475471	0.149	-1.90380	89730	366779
0.050	-2.99573	22735	539910	0.100	-2.30258	50929	940457	0.150	-1.89711	99848	858813

$$\left[\begin{matrix} (-5)5 \\ 12 \end{matrix} \right]$$

$$\left[\begin{matrix} (-5)1 \\ 9 \end{matrix} \right]$$

For use of natural logarithms see Examples 4-7.

$$\ln 10 = 2.30258 50929 940457$$

NATURAL LOGARITHMS

Table 4.2

x	$\ln x$	x	$\ln x$	x	$\ln x$
0.150	-1.89711 99848 858813	0.200	-1.60943 79124 341004	0.250	-1.38629 43611 198906
0.151	-1.89047 54421 672127	0.201	-1.60445 03709 230613	0.251	-1.38230 23398 503532
0.152	-1.88387 47581 358607	0.202	-1.59948 75815 809323	0.252	-1.37832 61914 707137
0.153	-1.87731 73575 897016	0.203	-1.59454 92999 403497	0.253	-1.37436 57902 546168
0.154	-1.87080 26765 685079	0.204	-1.58963 52851 379207	0.254	-1.37042 10119 636005
0.155	-1.86433 01620 628904	0.205	-1.58474 52998 437289	0.255	-1.36649 17338 237109
0.156	-1.85789 92717 326000	0.206	-1.57987 91101 925560	0.256	-1.36257 78345 025746
0.157	-1.85150 94736 338290	0.207	-1.57503 64857 167680	0.257	-1.35867 91940 869173
0.158	-1.84516 02459 551702	0.208	-1.57021 71992 808191	0.258	-1.35479 56940 605196
0.159	-1.83885 10767 619055	0.209	-1.56542 10270 173260	0.259	-1.35092 72172 825993
0.160	-1.83258 14637 483101	0.210	-1.56064 77482 646684	0.260	-1.34707 36479 666093
0.161	-1.82635 09139 976741	0.211	-1.55589 71455 060706	0.261	-1.34323 48716 594436
0.162	-1.82015 89437 497530	0.212	-1.55116 90043 101246	0.262	-1.33941 07752 214002
0.163	-1.81400 50781 753747	0.213	-1.54646 31132 727119	0.263	-1.33560 12468 043725
0.164	-1.80788 88511 579386	0.214	-1.54177 92639 602856	0.264	-1.33180 61758 358209
0.165	-1.80180 98050 815564	0.215	-1.53711 72508 544743	0.265	-1.32802 54529 959148
0.166	-1.79576 74906 255938	0.216	-1.53247 68712 979720	0.266	-1.32425 89702 004380
0.167	-1.78976 14665 653819	0.217	-1.52785 79254 416775	0.267	-1.32050 66205 818875
0.168	-1.78379 12995 788781	0.218	-1.52326 02161 930480	0.268	-1.31676 82984 712804
0.169	-1.77785 65640 590636	0.219	-1.51868 35491 656362	0.269	-1.31304 38993 802979
0.170	-1.77195 68419 318753	0.220	-1.51412 77326 297755	0.270	-1.30933 33199 837623
0.171	-1.76609 17224 794772	0.221	-1.50959 25774 643842	0.271	-1.30563 64581 024362
0.172	-1.76026 08021 686840	0.222	-1.50507 78971 098576	0.272	-1.30195 32126 861397
0.173	-1.75446 36844 843581	0.223	-1.50058 35075 220183	0.273	-1.29828 34837 971773
0.174	-1.74869 99797 676080	0.224	-1.49610 92271 270972	0.274	-1.29462 71725 940668
0.175	-1.74296 93050 586230	0.225	-1.49165 48767 777169	0.275	-1.29098 41813 155658
0.176	-1.73727 12839 439853	0.226	-1.48722 02797 098512	0.276	-1.28735 44132 649871
0.177	-1.73160 55464 083079	0.227	-1.48280 52615 007344	0.277	-1.28373 77727 947986
0.178	-1.72597 17286 900519	0.228	-1.47840 96500 276963	0.278	-1.28013 41652 915000
0.179	-1.72036 94731 413821	0.229	-1.47403 32754 278974	0.279	-1.27654 34971 607714
0.180	-1.71479 84280 919267	0.230	-1.46967 59700 589417	0.280	-1.27296 56758 128874
0.181	-1.70925 82477 163113	0.231	-1.46533 75684 603435	0.281	-1.26940 06096 483913
0.182	-1.70374 85919 053417	0.232	-1.46101 79073 158271	0.282	-1.26584 82080 440235
0.183	-1.69826 91261 407161	0.233	-1.45671 68254 164365	0.283	-1.26230 83813 388994
0.184	-1.69281 95213 731514	0.234	-1.45243 41636 244356	0.284	-1.25878 10408 209310
0.185	-1.68739 94539 038122	0.235	-1.44816 97648 379781	0.285	-1.25526 60987 134865
0.186	-1.68200 86052 689358	0.236	-1.44392 34739 565270	0.286	-1.25176 34681 622845
0.187	-1.67664 66621 275504	0.237	-1.43969 51378 470059	0.287	-1.24827 30632 225159
0.188	-1.67131 33161 521878	0.238	-1.43548 46053 106624	0.288	-1.24479 47988 461911
0.189	-1.66600 82639 224947	0.239	-1.43129 17270 506264	0.289	-1.24132 85908 697049
0.190	-1.66073 12068 216509	0.240	-1.42711 63556 401457	0.290	-1.23787 43560 016173
0.191	-1.65548 18509 355072	0.241	-1.42295 83454 914821	0.291	-1.23443 20118 106445
0.192	-1.65025 99069 543555	0.242	-1.41881 75528 254507	0.292	-1.23100 14767 138553
0.193	-1.64506 50900 772515	0.243	-1.41469 38356 415886	0.293	-1.22758 26699 650697
0.194	-1.63989 71199 188089	0.244	-1.41058 70536 889352	0.294	-1.22417 55116 434554
0.195	-1.63475 57204 183903	0.245	-1.40649 70684 374101	0.295	-1.22077 99226 423172
0.196	-1.62964 06197 516198	0.246	-1.40242 37430 497742	0.296	-1.21739 58246 580767
0.197	-1.62455 15502 441485	0.247	-1.39836 69423 541599	0.297	-1.21402 31401 794374
0.198	-1.61948 82482 876018	0.248	-1.39432 65328 171549	0.298	-1.21066 17924 767326
0.199	-1.61445 04542 576447	0.249	-1.39030 23825 174294	0.299	-1.20731 17055 914506
0.200	-1.60943 79124 341004	0.250	-1.38629 43611 198906	0.300	-1.20397 28043 259360

$$\left[\begin{matrix} (-6)5 \\ 8 \end{matrix} \right]$$

$$\left[\begin{matrix} (-6)3 \\ 8 \end{matrix} \right]$$

$$\left[\begin{matrix} (-6)2 \\ 7 \end{matrix} \right]$$

$$\ln 10 = 2.30258 50929 940457$$

Table 4.2

NATURAL LOGARITHMS

x	$\ln x$			x	$\ln x$			x	$\ln x$		
0.300	-1.20397	28043	259360	0.350	-1.04982	21244	986777	0.400	-0.91629	07318	741551
0.301	-1.20064	50142	332613	0.351	-1.04696	90555	162712	0.401	-0.91379	38516	755679
0.302	-1.19732	82616	072674	0.352	-1.04412	41033	840400	0.402	-0.91130	31903	631160
0.303	-1.19402	24734	727679	0.353	-1.04128	72220	488403	0.403	-0.90881	87170	354541
0.304	-1.19072	75775	759154	0.354	-1.03845	83658	483626	0.404	-0.90634	04010	209870
0.305	-1.18744	35023	747254	0.355	-1.03563	74895	067213	0.405	-0.90386	82118	755979
0.306	-1.18417	01770	297563	0.356	-1.03282	45481	301066	0.406	-0.90140	21193	804044
0.307	-1.18090	75313	949399	0.357	-1.03001	94972	024980	0.407	-0.89894	20935	395421
0.308	-1.17765	54960	085626	0.358	-1.02722	22925	814367	0.408	-0.89648	81045	779754
0.309	-1.17441	40020	843916	0.359	-1.02443	28904	938582	0.409	-0.89404	01229	393353
0.310	-1.17118	29815	029451	0.360	-1.02165	12475	319814	0.410	-0.89159	81192	837836
0.311	-1.16796	23668	029029	0.361	-1.01887	73206	492561	0.411	-0.88916	20644	859024
0.312	-1.16475	20911	726547	0.362	-1.01611	10671	563660	0.412	-0.88673	19296	326107
0.313	-1.16155	20884	419838	0.363	-1.01335	24447	172863	0.413	-0.88430	76860	211043
0.314	-1.15836	22930	738837	0.364	-1.01060	14113	453964	0.414	-0.88188	93051	568227
0.315	-1.15518	26401	565040	0.365	-1.00785	79253	996455	0.415	-0.87947	67587	514388
0.316	-1.15201	30653	952249	0.366	-1.00512	19455	807708	0.416	-0.87707	00187	208738
0.317	-1.14885	35051	048564	0.367	-1.00239	34309	275668	0.417	-0.87466	90571	833356
0.318	-1.14570	38962	019602	0.368	-0.99967	23408	132061	0.418	-0.87227	38464	573807
0.319	-1.14256	41761	972925	0.369	-0.99695	86349	416099	0.419	-0.86988	43590	599993
0.320	-1.13943	42831	883648	0.370	-0.99425	22733	438669	0.420	-0.86750	05677	047231
0.321	-1.13631	41558	521212	0.371	-0.99155	32163	747019	0.421	-0.86512	24452	997556
0.322	-1.13320	37334	377287	0.372	-0.98886	14247	089905	0.422	-0.86274	99649	461252
0.323	-1.13010	29557	594805	0.373	-0.98617	68593	383215	0.423	-0.86038	30999	358591
0.324	-1.12701	17631	898077	0.374	-0.98349	94815	676051	0.424	-0.85802	18237	501793
0.325	-1.12393	00966	523996	0.375	-0.98082	92530	117262	0.425	-0.85566	61100	577202
0.326	-1.12085	78976	154294	0.376	-0.97816	61355	922425	0.426	-0.85331	59327	127666
0.327	-1.11779	51080	848837	0.377	-0.97551	00915	341263	0.427	-0.85097	12657	535125
0.328	-1.11474	16705	979933	0.378	-0.97286	10833	625494	0.428	-0.84863	20834	003403
0.329	-1.11169	75282	167652	0.379	-0.97021	90738	997107	0.429	-0.84629	83600	541201
0.330	-1.10866	26245	216111	0.380	-0.96758	40262	617056	0.430	-0.84397	00702	945289
0.331	-1.10563	69036	050742	0.381	-0.96495	59038	554361	0.431	-0.84164	71888	783893
0.332	-1.10262	03100	656485	0.382	-0.96233	46703	755619	0.432	-0.83932	96907	380267
0.333	-1.09961	27890	016932	0.383	-0.95972	02898	014911	0.433	-0.83701	75509	796472
0.334	-1.09661	42860	054366	0.384	-0.95711	27263	944102	0.434	-0.83471	07448	817322
0.335	-1.09362	47471	570706	0.385	-0.95451	19446	943528	0.435	-0.83240	92478	934530
0.336	-1.09064	41190	189328	0.386	-0.95191	79095	173062	0.436	-0.83011	30356	331027
0.337	-1.08767	23486	297753	0.387	-0.94933	05859	523552	0.437	-0.82782	20838	865469
0.338	-1.08470	93834	991183	0.388	-0.94674	99393	588636	0.438	-0.82553	63686	056909
0.339	-1.08175	51716	016868	0.389	-0.94417	59353	636908	0.439	-0.82325	58659	069657
0.340	-1.07880	96613	719300	0.390	-0.94160	85398	584449	0.440	-0.82098	05520	698302
0.341	-1.07587	28016	986203	0.391	-0.93904	77189	967713	0.441	-0.81871	04035	352911
0.342	-1.07294	45419	195319	0.392	-0.93649	34391	916745	0.442	-0.81644	53969	044389
0.343	-1.07002	48318	161971	0.393	-0.93394	56671	128758	0.443	-0.81418	55089	370014
0.344	-1.06711	36216	087387	0.394	-0.93140	43696	842032	0.444	-0.81193	07165	499123
0.345	-1.06421	08619	507773	0.395	-0.92886	95140	810152	0.445	-0.80968	09968	158968
0.346	-1.06131	65039	244128	0.396	-0.92634	10677	276565	0.446	-0.80743	63269	620730
0.347	-1.05843	04990	352779	0.397	-0.92381	89982	949466	0.447	-0.80519	66843	685682
0.348	-1.05555	27992	076627	0.398	-0.92130	32736	976993	0.448	-0.80296	20465	671519
0.349	-1.05268	33567	797099	0.399	-0.91879	38620	922736	0.449	-0.80073	23912	398828
0.350	-1.04982	21244	986777	0.400	-0.91629	07318	741551	0.450	-0.79850	76962	177716
		$\left[\begin{smallmatrix} (-6)1 \\ 7 \end{smallmatrix} \right]$				$\left[\begin{smallmatrix} (-6)1 \\ 7 \end{smallmatrix} \right]$				$\left[\begin{smallmatrix} (-7)8 \\ 7 \end{smallmatrix} \right]$	

$\ln 10 = 2.30258 50929 940457$

*See page II.

NATURAL LOGARITHMS

Table 4.2

x	$\ln x$	x	$\ln x$	x	$\ln x$
0.450	-0.79850 76962 177716	0.500	-0.69314 71805 599453	0.550	-0.59783 70007 556204
0.451	-0.79628 79394 794587	0.501	-0.69114 91778 972723	0.551	-0.59602 04698 292226
0.452	-0.79407 30991 499059	0.502	-0.68915 51592 904079	0.552	-0.59420 72327 050417
0.453	-0.79186 31534 991030	0.503	-0.68716 51088 823978	0.553	-0.59239 72774 598023
0.454	-0.78965 80809 407891	0.504	-0.68517 90109 107684	0.554	-0.59059 05922 348532
0.455	-0.78745 78600 311866	0.505	-0.68319 68497 067772	0.555	-0.58878 71652 357025
0.456	-0.78526 24694 677510	0.506	-0.68121 86096 946715	0.556	-0.58698 69847 315547
0.457	-0.78307 18880 879324	0.507	-0.67924 42753 909539	0.557	-0.58519 00390 548530
0.458	-0.78088 60948 679521	0.508	-0.67727 38314 036552	0.558	-0.58339 63166 008261
0.459	-0.77870 50689 215919	0.509	-0.67530 72624 316143	0.559	-0.58160 58058 270379
0.460	-0.77652 87894 989964	0.510	-0.67334 45532 637656	0.560	-0.57981 84952 529421
0.461	-0.77435 72359 854885	0.511	-0.67138 56887 784326	0.561	-0.57803 43734 594407
0.462	-0.77219 03879 003982	0.512	-0.66943 06539 426293	0.562	-0.57625 34290 884460
0.463	-0.77002 82248 959030	0.513	-0.66747 94338 113675	0.563	-0.57447 56508 424467
0.464	-0.76787 07267 558818	0.514	-0.66553 20135 269719	0.564	-0.57270 10274 840782
0.465	-0.76571 78733 947807	0.515	-0.66358 83783 184009	0.565	-0.57092 95478 356961
0.466	-0.76356 96448 564912	0.516	-0.66164 85135 005743	0.566	-0.56916 12007 789541
0.467	-0.76142 60213 132397	0.517	-0.65971 24044 737079	0.567	-0.56739 59752 543850
0.468	-0.75928 69830 644903	0.518	-0.65778 00367 226540	0.568	-0.56563 38602 609857
0.469	-0.75715 25105 358577	0.519	-0.65585 13958 162484	0.569	-0.56387 84848 558061
0.470	-0.75502 25842 780328	0.520	-0.65392 64674 066640	0.570	-0.56211 89181 535412
0.471	-0.75289 71849 657193	0.521	-0.65200 52372 287701	0.571	-0.56036 60693 261268
0.472	-0.75077 62933 965817	0.522	-0.65008 76910 994983	0.572	-0.55861 62876 023392
0.473	-0.74865 98904 902041	0.523	-0.64817 38149 172142	0.573	-0.55686 95622 673975
0.474	-0.74654 79572 870606	0.524	-0.64626 35946 610949	0.574	-0.55512 58826 625706
0.475	-0.74444 04749 474958	0.525	-0.64435 70163 905133	0.575	-0.55338 52381 847866
0.476	-0.74233 74247 507170	0.526	-0.64245 40662 444272	0.576	-0.55164 76182 862458
0.477	-0.74023 87880 937958	0.527	-0.64055 47304 407747	0.577	-0.54991 30124 740375
0.478	-0.73814 45464 906811	0.528	-0.63865 89952 758756	0.578	-0.54818 14103 097596
0.479	-0.73605 46815 712218	0.529	-0.63676 68471 238377	0.579	-0.54645 28014 091418
0.480	-0.73396 91750 802004	0.530	-0.63487 82724 359695	0.580	-0.54472 71754 416720
0.481	-0.73188 80088 763759	0.531	-0.63299 32577 401982	0.581	-0.54300 45221 302258
0.482	-0.72981 11649 315367	0.532	-0.63111 17896 404927	0.582	-0.54128 48312 506992
0.483	-0.72773 86253 295644	0.533	-0.62923 38548 162925	0.583	-0.53956 80926 316447
0.484	-0.72567 03722 655053	0.534	-0.62735 94400 219422	0.584	-0.53785 42961 539100
0.485	-0.72360 63880 446539	0.535	-0.62548 85320 861305	0.585	-0.53614 34317 502806
0.486	-0.72154 66550 816433	0.536	-0.62362 11179 113351	0.586	-0.53443 54894 051244
0.487	-0.71949 11558 995473	0.537	-0.62175 71844 732724	0.587	-0.53273 04591 540406
0.488	-0.71743 98731 289899	0.538	-0.61989 67188 203526	0.588	-0.53102 83310 835101
0.489	-0.71539 27895 072650	0.539	-0.61803 97080 731399	0.589	-0.52932 90953 305503
0.490	-0.71334 98878 774648	0.540	-0.61618 61394 238170	0.590	-0.52763 27420 823719
0.491	-0.71131 11511 876165	0.541	-0.61433 60001 356555	0.591	-0.52593 92615 760389
0.492	-0.70927 65624 898289	0.542	-0.61248 92775 424908	0.592	-0.52424 86440 981314
0.493	-0.70724 61049 394469	0.543	-0.61064 59590 482016	0.593	-0.52256 08799 844116
0.494	-0.70521 97617 942145	0.544	-0.60880 60321 261944	0.594	-0.52087 59596 194921
0.495	-0.70319 75164 134468	0.545	-0.60696 94843 188930	0.595	-0.51919 38734 365073
0.496	-0.70117 93522 572096	0.546	-0.60513 63032 372320	0.596	-0.51751 46119 167873
0.497	-0.69916 52528 855083	0.547	-0.60330 64765 601558	0.597	-0.51583 81655 895350
0.498	-0.69715 52019 574841	0.548	-0.60147 99920 341215	0.598	-0.51416 45250 315053
0.499	-0.69514 91832 306184	0.549	-0.59965 68374 726064	0.599	-0.51249 36808 666877
0.500	-0.69314 71805 599453	0.550	-0.59783 70007 556204	0.600	-0.51082 56237 659907

$$\left[\begin{matrix} (-7)6 \\ 7 \end{matrix} \right]$$

$$\left[\begin{matrix} (-7)5 \\ 6 \end{matrix} \right]$$

$$\left[\begin{matrix} (-7)4 \\ 6 \end{matrix} \right]$$

$$\ln 10 = 2.30258 50929 940457$$

Table 4.2

NATURAL LOGARITHMS

x	$\ln x$			x	$\ln x$			x	$\ln x$		
0.600	-0.51082	56237	659907	0.650	-0.43078	29160	924543	0.700	-0.35667	49439	387324
0.601	-0.50916	03444	469295	0.651	-0.42924	56367	735678	0.701	-0.35524	73919	475470
0.602	-0.50749	78336	733160	0.652	-0.42771	07170	554841	0.702	-0.35382	18749	563259
0.603	-0.50583	80822	549516	0.653	-0.42617	81497	057060	0.703	-0.35239	83871	714721
0.604	-0.50418	10810	473221	0.654	-0.42464	79275	249384	0.704	-0.35097	69228	240947
0.605	-0.50252	68209	512956	0.655	-0.42312	00433	468851	0.705	-0.34955	74761	698684
0.606	-0.50087	52929	128226	0.656	-0.42159	44900	380480	0.706	-0.34814	00414	888950
0.607	-0.49922	64879	226388	0.657	-0.42007	12604	975265	0.707	-0.34672	46130	855643
0.608	-0.49758	03970	159700	0.658	-0.41855	03476	568199	0.708	-0.34531	11852	884173
0.609	-0.49593	70112	722400	0.659	-0.41703	17444	796298	0.709	-0.34389	97524	500096
0.610	-0.49429	63218	147801	0.660	-0.41551	54439	616658	0.710	-0.34249	03089	467759
0.611	-0.49265	83198	105417	0.661	-0.41400	14391	304508	0.711	-0.34108	28491	788962
0.612	-0.49102	29964	698110	0.662	-0.41248	97230	451288	0.712	-0.33967	73675	701613
0.613	-0.48939	03430	459257	0.663	-0.41098	02887	962745	0.713	-0.33827	38585	678411
0.614	-0.48776	03508	349946	0.664	-0.40947	31295	057032	0.714	-0.33687	23166	425527
0.615	-0.48613	30111	756192	0.665	-0.40796	82383	262829	0.715	-0.33547	27362	881294
0.616	-0.48450	83154	486173	0.666	-0.40646	56084	417479	0.716	-0.33407	51120	214914
0.617	-0.48288	62550	767492	0.667	-0.40496	52330	665133	0.717	-0.33267	94383	825167
0.618	-0.48126	68215	244463	0.668	-0.40346	71054	454913	0.718	-0.33128	57099	339129
0.619	-0.47965	00062	975409	0.669	-0.40197	12188	539086	0.719	-0.32989	39212	610904
0.620	-0.47803	58009	429998	0.670	-0.40047	75665	971253	0.720	-0.32850	40669	720361
0.621	-0.47642	41970	486583	0.671	-0.39898	61420	104553	0.721	-0.32711	61416	971880
0.622	-0.47481	51862	429576	0.672	-0.39749	69384	589875	0.722	-0.32573	01400	893108
0.623	-0.47320	87601	946839	0.673	-0.39600	99493	374092	0.723	-0.32434	60568	233724
0.624	-0.47160	49106	127094	0.674	-0.39452	51680	698300	0.724	-0.32296	38865	964207
0.625	-0.47000	36292	457356	0.675	-0.39304	25881	096072	0.725	-0.32158	36241	274623
0.626	-0.46840	49078	820385	0.676	-0.39156	22029	391730	0.726	-0.32020	52641	573410
0.627	-0.46680	87383	492164	0.677	-0.39008	40060	698621	0.727	-0.31882	88014	486177
0.628	-0.46521	51125	139384	0.678	-0.38860	79910	417415	0.728	-0.31745	42307	854511
0.629	-0.46362	40222	816965	0.679	-0.38713	41514	234409	0.729	-0.31608	15469	734789
0.630	-0.46203	54595	965587	0.680	-0.38566	24808	119847	0.730	-0.31471	07448	397002
0.631	-0.46044	94164	409239	0.681	-0.38419	29728	326247	0.731	-0.31334	18192	323585
0.632	-0.45886	58848	352796	0.682	-0.38272	56211	386750	0.732	-0.31197	47650	208255
0.633	-0.45728	48568	379609	0.683	-0.38126	04194	113470	0.733	-0.31060	95770	954856
0.634	-0.45570	63245	449111	0.684	-0.37979	73613	595866	0.734	-0.30924	62503	676215
0.635	-0.45413	02800	894454	0.685	-0.37833	64407	199118	0.735	-0.30788	47797	693004
0.636	-0.45255	67156	420149	0.686	-0.37687	76512	562518	0.736	-0.30652	51602	532608
0.637	-0.45098	56234	099737	0.687	-0.37542	09867	597877	0.737	-0.30516	73867	928004
0.638	-0.44941	69956	373472	0.688	-0.37396	64410	487934	0.738	-0.30381	14543	816646
0.639	-0.44785	08246	046022	0.689	-0.37251	40079	684785	0.739	-0.30245	73580	339353
0.640	-0.44628	71026	284195	0.690	-0.37106	36813	908320	0.740	-0.30110	50927	839216
0.641	-0.44472	58220	614670	0.691	-0.36961	54552	144672	0.741	-0.29975	46536	860502
0.642	-0.44316	69752	921759	0.692	-0.36816	93233	644675	0.742	-0.29840	60358	147566
0.643	-0.44161	05547	445177	0.693	-0.36672	52797	922338	0.743	-0.29705	92342	643779
0.644	-0.44005	65528	777834	0.694	-0.36528	33184	753326	0.744	-0.29571	42441	490452
0.645	-0.43850	49621	863646	0.695	-0.36384	34334	173449	0.745	-0.29437	10606	025775
0.646	-0.43695	57751	995352	0.696	-0.36240	56186	477174	0.746	-0.29302	96787	783762
0.647	-0.43540	89844	812365	0.697	-0.36096	98682	216132	0.747	-0.29169	00938	493197
0.648	-0.43386	45826	298624	0.698	-0.35953	61762	197646	0.748	-0.29035	23010	076598
0.649	-0.43232	25622	780471	0.699	-0.35810	45367	483268	0.749	-0.28901	62954	649176
0.650	-0.43078	29160	924543	0.700	-0.35667	49439	387324	0.750	-0.28768	20724	517809

$$\left[\begin{matrix} (-7)3 \\ 6 \end{matrix} \right]$$

$$\left[\begin{matrix} (-7)3 \\ 6 \end{matrix} \right]$$

$$\left[\begin{matrix} (-7)3 \\ 6 \end{matrix} \right]$$

$$\ln 10 = 2.30258 \ 50929 \ 940457$$

NATURAL LOGARITHMS

Table 4.2

x	$\ln x$			x	$\ln x$			x	$\ln x$		
0.750	-0.28768	20724	517809	0.800	-0.22314	35513	142098	0.850	-0.16251	89294	977749
0.751	-0.28634	96272	180023	0.801	-0.22189	43319	137778	0.851	-0.16134	31504	087629
0.752	-0.28501	89550	322973	0.802	-0.22064	66711	156226	0.852	-0.16016	87521	528213
0.753	-0.28369	00511	822435	0.803	-0.21940	05650	353754	0.853	-0.15899	57314	904579
0.754	-0.28236	29109	741810	0.804	-0.21815	60098	031707	0.854	-0.15782	40851	935672
0.755	-0.28103	75297	331123	0.805	-0.21691	30015	635737	0.855	-0.15665	38100	453768
0.756	-0.27971	39028	026041	0.806	-0.21567	15364	755088	0.856	-0.15548	49028	403950
0.757	-0.27839	20255	446883	0.807	-0.21443	16107	121883	0.857	-0.15431	73603	843573
0.758	-0.27707	18933	397654	0.808	-0.21319	32204	610417	0.858	-0.15315	11794	941748
0.759	-0.27575	35015	865071	0.809	-0.21195	63619	236454	0.859	-0.15198	63569	978817
0.760	-0.27443	68457	017603	0.810	-0.21072	10313	156526	0.860	-0.15082	28897	345836
0.761	-0.27312	19211	204512	0.811	-0.20948	72248	667241	0.861	-0.14966	07745	544063
0.762	-0.27180	87232	954908	0.812	-0.20825	49388	204591	0.862	-0.14850	00083	184440
0.763	-0.27049	72476	976800	0.813	-0.20702	41694	343265	0.863	-0.14734	05878	987091
0.764	-0.26918	74898	156166	0.814	-0.20579	49129	795968	0.864	-0.14618	25101	780814
0.765	-0.26787	94451	556012	0.815	-0.20456	71657	412743	0.865	-0.14502	57720	502577
0.766	-0.26657	31092	415458	0.816	-0.20334	09240	180300	0.866	-0.14387	03704	197019
0.767	-0.26526	84776	148809	0.817	-0.20211	61841	221342	0.867	-0.14271	63022	015952
0.768	-0.26396	55458	344649	0.818	-0.20089	29423	793900	0.868	-0.14156	35643	217869
0.769	-0.26266	43094	764931	0.819	-0.19967	11951	290676	0.869	-0.14041	21537	167450
0.770	-0.26136	47641	344075	0.820	-0.19845	09387	238383	0.870	-0.13926	20673	335076
0.771	-0.26006	69054	188076	0.821	-0.19723	21695	297088	0.871	-0.13811	33021	296343
0.772	-0.25877	07289	573609	0.822	-0.19601	48839	259571	0.872	-0.13696	58550	731574
0.773	-0.25747	62303	947151	0.823	-0.19479	90783	050672	0.873	-0.13581	97231	425348
0.774	-0.25618	34053	924099	0.824	-0.19358	47490	726654	0.874	-0.13467	49033	266016
0.775	-0.25489	22496	287901	0.825	-0.19237	18926	474561	0.875	-0.13353	13926	245226
0.776	-0.25360	27587	989183	0.826	-0.19116	05054	611590	0.876	-0.13238	91880	457456
0.777	-0.25231	49286	144896	0.827	-0.18995	05839	584457	0.877	-0.13124	82866	099540
0.778	-0.25102	87548	037454	0.828	-0.18874	21245	968774	0.878	-0.13010	86853	470204
0.779	-0.24974	42331	113888	0.829	-0.18753	51238	468421	0.879	-0.12897	03812	969601
0.780	-0.24846	13592	984996	0.830	-0.18632	95781	914934	0.880	-0.12783	33715	098849
0.781	-0.24718	01291	424511	0.831	-0.18512	54841	266889	0.881	-0.12669	76530	459575
0.782	-0.24590	05384	368260	0.832	-0.18392	28381	609285	0.882	-0.12556	32229	753457
0.783	-0.24462	25829	913340	0.833	-0.18272	16368	152944	0.883	-0.12443	00783	781770
0.784	-0.24334	62586	317292	0.834	-0.18152	18766	233903	0.884	-0.12329	82163	444936
0.785	-0.24207	15611	997286	0.835	-0.18032	35541	312816	0.885	-0.12216	76339	742075
0.786	-0.24079	84865	529305	0.836	-0.17912	66658	974354	0.886	-0.12103	83283	770561
0.787	-0.23952	70305	647338	0.837	-0.17793	12084	926617	0.887	-0.11991	02966	725576
0.788	-0.23825	71891	242579	0.838	-0.17673	71785	000540	0.888	-0.11878	35359	899670
0.789	-0.23698	89581	362628	0.839	-0.17554	45725	149309	0.889	-0.11765	80434	682325
0.790	-0.23572	23335	210699	0.840	-0.17435	33871	447778	0.890	-0.11653	38162	559515
0.791	-0.23445	73112	144832	0.841	-0.17316	36190	091890	0.891	-0.11541	08515	113277
0.792	-0.23319	38871	677112	0.842	-0.17197	52647	398103	0.892	-0.11428	91464	021277
0.793	-0.23193	20573	472891	0.843	-0.17078	83209	802816	0.893	-0.11316	86981	056380
0.794	-0.23067	18177	350013	0.844	-0.16960	27843	861799	0.894	-0.11204	95038	086229
0.795	-0.22941	31643	278052	0.845	-0.16841	86516	249632	0.895	-0.11093	15607	072817
0.796	-0.22815	60931	377540	0.846	-0.16723	59193	759138	0.896	-0.10981	48660	072066
0.797	-0.22690	06001	919220	0.847	-0.16605	45843	300827	0.897	-0.10869	94169	233409
0.798	-0.22564	66815	323283	0.848	-0.16487	46431	902340	0.898	-0.10758	52106	799374
0.799	-0.22439	43332	158624	0.849	-0.16369	60926	707897	0.899	-0.10647	22445	105168
0.800	-0.22314	35513	142098	0.850	-0.16251	89294	977749	0.900	-0.10536	05156	578263
		$\left[\begin{smallmatrix} (-7)2 \\ 6 \end{smallmatrix} \right]$				$\left[\begin{smallmatrix} (-7)2 \\ 6 \end{smallmatrix} \right]$				$\left[\begin{smallmatrix} (-7)2 \\ 6 \end{smallmatrix} \right]$	

$\ln 10 = 2.30258\ 50929\ 940457$

Table 4.2

NATURAL LOGARITHMS

x	$\ln x$			x	$\ln x$			x	$\ln x$		
0.900	-0.10536	05156	578263	0.950	-0.05129	32943	875505	1.000	0.00000	00000	000000
0.901	-0.10425	00213	737991	0.951	-0.05024	12164	367467	1.001	0.00099	95003	330835
0.902	-0.10314	07589	195134	0.952	-0.04919	02441	907717	1.002	0.00199	80026	626731
0.903	-0.10203	27255	651516	0.953	-0.04814	03753	279349	1.003	0.00299	55089	797985
0.904	-0.10092	59185	899606	0.954	-0.04709	16075	338505	1.004	0.00399	20212	695375
0.905	-0.09982	03352	822109	0.955	-0.04604	39385	014068	1.005	0.00498	75415	110391
0.906	-0.09871	59729	391577	0.956	-0.04499	73659	307358	1.006	0.00598	20716	775475
0.907	-0.09761	28288	670004	0.957	-0.04395	18875	291828	1.007	0.00697	56137	364252
0.908	-0.09651	09003	808438	0.958	-0.04290	75010	112765	1.008	0.00796	81696	491769
0.909	-0.09541	01848	046582	0.959	-0.04186	42040	986988	1.009	0.00895	97413	714719
0.910	-0.09431	06794	712413	0.960	-0.04082	19945	202551	1.010	0.00995	03308	531681
0.911	-0.09321	23817	221787	0.961	-0.03978	08700	118446	1.011	0.01093	99400	383344
0.912	-0.09211	52889	078057	0.962	-0.03874	08283	164306	1.012	0.01192	85708	652738
0.913	-0.09101	93983	871686	0.963	-0.03770	18671	840115	1.013	0.01291	62252	665463
0.914	-0.08992	47075	279870	0.964	-0.03666	39843	715914	1.014	0.01390	29051	689914
0.915	-0.08883	12137	066157	0.965	-0.03562	71776	431511	1.015	0.01488	86124	937507
0.916	-0.08773	89143	080068	0.966	-0.03459	14447	696191	1.016	0.01587	33491	562901
0.917	-0.08664	78067	256722	0.967	-0.03355	67835	288427	1.017	0.01685	71170	664229
0.918	-0.08555	78883	616466	0.968	-0.03252	31917	055600	1.018	0.01783	99181	283310
0.919	-0.08446	91566	264500	0.969	-0.03149	06670	913708	1.019	0.01882	17542	405878
0.920	-0.08338	16089	390511	0.970	-0.03045	92074	847085	1.020	0.01980	26272	961797
0.921	-0.08229	52427	268302	0.971	-0.02942	88106	908121	1.021	0.02078	25391	825285
0.922	-0.08121	00554	255432	0.972	-0.02839	94745	216980	1.022	0.02176	14917	815127
0.923	-0.08012	60444	792849	0.973	-0.02737	11967	961320	1.023	0.02273	94869	694894
0.924	-0.07904	32073	404529	0.974	-0.02634	39753	396020	1.024	0.02371	65266	173160
0.925	-0.07796	15414	697119	0.975	-0.02531	78079	842899	1.025	0.02469	26125	903715
0.926	-0.07688	10443	359577	0.976	-0.02429	26925	690446	1.026	0.02566	77467	485778
0.927	-0.07580	17134	162819	0.977	-0.02326	86269	393543	1.027	0.02664	19309	464212
0.928	-0.07472	35461	959365	0.978	-0.02224	56089	473197	1.028	0.02761	51670	329734
0.929	-0.07364	65401	682985	0.979	-0.02122	36364	516267	1.029	0.02858	74568	519126
0.930	-0.07257	06928	348354	0.980	-0.02020	27073	175194	1.030	0.02955	88022	415444
0.931	-0.07149	60017	050700	0.981	-0.01918	28194	167740	1.031	0.03052	92050	348229
0.932	-0.07042	24642	965459	0.982	-0.01816	39706	276712	1.032	0.03149	86670	593710
0.933	-0.06935	00781	347932	0.983	-0.01714	61588	349705	1.033	0.03246	71901	375015
0.934	-0.06827	88407	532944	0.984	-0.01612	93819	298836	1.034	0.03343	47760	862374
0.935	-0.06720	87496	934501	0.985	-0.01511	36378	100482	1.035	0.03440	14267	173324
0.936	-0.06613	98025	045450	0.986	-0.01409	89243	795016	1.036	0.03536	71438	372913
0.937	-0.06507	19967	437149	0.987	-0.01308	52395	486555	1.037	0.03633	19292	473903
0.938	-0.06400	53299	759124	0.988	-0.01207	25812	342692	1.038	0.03729	57847	436969
0.939	-0.06293	97997	738741	0.989	-0.01106	09473	594249	1.039	0.03825	87121	170903
0.940	-0.06187	54037	180875	0.990	-0.01005	03358	535014	1.040	0.03922	07131	532813
0.941	-0.06081	21393	967574	0.991	-0.00904	07446	521491	1.041	0.04018	17896	328318
0.942	-0.05975	00044	057740	0.992	-0.00803	21716	972643	1.042	0.04114	19433	311752
0.943	-0.05868	89963	486796	0.993	-0.00702	46149	369645	1.043	0.04210	11760	186354
0.944	-0.05762	91128	366364	0.994	-0.00601	80723	255630	1.044	0.04305	94894	604470
0.945	-0.05657	03514	883943	0.995	-0.00501	25418	235443	1.045	0.04401	68854	167743
0.946	-0.05551	27099	302588	0.996	-0.00400	80213	975388	1.046	0.04497	33656	427312
0.947	-0.05445	61857	960588	0.997	-0.00300	45090	202987	1.047	0.04592	89318	883998
0.948	-0.05340	07767	271152	0.998	-0.00200	20026	706731	1.048	0.04688	35858	988504
0.949	-0.05234	64803	722092	0.999	-0.00100	05003	335835	1.049	0.04783	73294	141601
0.950	-0.05129	32943	875505	1.000	0.00000	00000	000000	1.050	0.04879	01641	694320

$$\left[\begin{matrix} (-7)2 \\ 6 \end{matrix} \right]$$

$$\left[\begin{matrix} (-7)1 \\ 6 \end{matrix} \right]$$

$$\left[\begin{matrix} (-7)1 \\ 6 \end{matrix} \right]$$

$$\ln 10 = 2.30258 50929 940457$$

NATURAL LOGARITHMS

Table 4.2

x	$\ln x$			x	$\ln x$			x	$\ln x$		
1.050	0.04879	01641	694320	1.100	0.09531	01798	043249	1.150	0.13976	19423	751587
1.051	0.04974	20918	948141	1.101	0.09621	88577	405429	1.151	0.14063	11297	397456
1.052	0.05069	31143	155181	1.102	0.09712	67107	307227	1.152	0.14149	95622	736995
1.053	0.05164	32331	518384	1.103	0.09803	37402	713654	1.153	0.14236	72412	869220
1.054	0.05259	24501	191706	1.104	0.09893	99478	549036	1.154	0.14323	41680	859078
1.055	0.05354	07669	280298	1.105	0.09984	53349	697161	1.155	0.14410	03439	737569
1.056	0.05448	81852	840697	1.106	0.10074	99031	001431	1.156	0.14496	57702	501857
1.057	0.05543	47068	881006	1.107	0.10165	36537	264998	1.157	0.14583	04482	115395
1.058	0.05638	03334	361076	1.108	0.10255	65883	250921	1.158	0.14669	43791	508035
1.059	0.05732	50666	192694	1.109	0.10345	87083	682300	1.159	0.14755	75643	576147
1.060	0.05826	89081	239758	1.110	0.10436	00153	242428	1.160	0.14842	00051	182733
1.061	0.05921	18596	318461	1.111	0.10526	05106	574929	1.161	0.14928	17027	157544
1.062	0.06015	39228	197471	1.112	0.10616	01958	283906	1.162	0.15014	26584	297195
1.063	0.06109	50993	598109	1.113	0.10705	90722	934078	1.163	0.15100	28735	365274
1.064	0.06203	53909	194526	1.114	0.10795	71415	050923	1.164	0.15186	23493	092461
1.065	0.06297	47991	613884	1.115	0.10885	44049	120821	1.165	0.15272	10870	176639
1.066	0.06391	33257	436528	1.116	0.10975	08639	591192	1.166	0.15357	90879	283006
1.067	0.06485	09723	196163	1.117	0.11064	65200	870637	1.167	0.15443	63533	044189
1.068	0.06578	77405	380031	1.118	0.11154	13747	329074	1.168	0.15529	28844	060353
1.069	0.06672	36320	429082	1.119	0.11243	54293	297882	1.169	0.15614	86824	899314
1.070	0.06765	86484	738148	1.120	0.11332	86853	070032	1.170	0.15700	37488	096648
1.071	0.06859	27914	656117	1.121	0.11422	11440	900229	1.171	0.15785	80846	155803
1.072	0.06952	60626	486102	1.122	0.11511	28071	005046	1.172	0.15871	16911	548209
1.073	0.07045	84636	485614	1.123	0.11600	36757	563061	1.173	0.15956	45696	713384
1.074	0.07138	99960	866729	1.124	0.11689	37514	714993	1.174	0.16041	67214	059047
1.075	0.07232	06615	796261	1.125	0.11778	30356	563835	1.175	0.16126	81475	961223
1.076	0.07325	04617	395927	1.126	0.11867	15297	174986	1.176	0.16211	88494	764352
1.077	0.07417	93981	742515	1.127	0.11955	92350	576392	1.177	0.16296	88282	781397
1.078	0.07510	74724	868054	1.128	0.12044	61530	758672	1.178	0.16381	80852	293950
1.079	0.07603	46862	759976	1.129	0.12133	22851	675250	1.179	0.16466	66215	552339
1.080	0.07696	10411	361283	1.130	0.12221	76327	242492	1.180	0.16551	44384	775734
1.081	0.07788	65386	570712	1.131	0.12310	21971	339834	1.181	0.16636	15372	152253
1.082	0.07881	11804	242898	1.132	0.12398	59797	809912	1.182	0.16720	79189	839065
1.083	0.07973	49680	188536	1.133	0.12486	89820	458693	1.183	0.16805	35849	962497
1.084	0.08065	79030	174545	1.134	0.12575	12053	055603	1.184	0.16889	85364	618139
1.085	0.08157	99869	924229	1.135	0.12663	26509	333660	1.185	0.16974	27745	870945
1.086	0.08250	12215	117437	1.136	0.12751	33202	989596	1.186	0.17058	63005	755337
1.087	0.08342	16081	390724	1.137	0.12839	32147	683990	1.187	0.17142	91156	275310
1.088	0.08434	11484	337509	1.138	0.12927	23357	041392	1.188	0.17227	12209	404532
1.089	0.08525	98439	508234	1.139	0.13015	06844	650451	1.189	0.17311	26177	086448
1.090	0.08617	76962	410523	1.140	0.13102	82624	064041	1.190	0.17395	33071	234380
1.091	0.08709	47068	509338	1.141	0.13190	50708	799386	1.191	0.17479	32903	731631
1.092	0.08801	08773	227133	1.142	0.13278	11112	338185	1.192	0.17563	25686	431580
1.093	0.08892	62091	944015	1.143	0.13365	63848	126736	1.193	0.17647	11431	157791
1.094	0.08984	07039	997895	1.144	0.13453	08929	576062	1.194	0.17730	90149	704103
1.095	0.09075	43632	684641	1.145	0.13540	46370	062030	1.195	0.17814	61853	834740
1.096	0.09166	71885	258238	1.146	0.13627	76182	925478	1.196	0.17898	26555	284400
1.097	0.09257	91812	930932	1.147	0.13714	98381	472336	1.197	0.17981	84265	758361
1.098	0.09349	03430	873389	1.148	0.13802	12978	973747	1.198	0.18065	34996	932576
1.099	0.09440	06754	214843	1.149	0.13889	19988	666186	1.199	0.18148	78760	453772
1.100	0.09531	01798	043249	1.150	0.13976	19423	751587	1.200	0.18232	15567	939546

$$\left[\begin{matrix} (-7)1 \\ 6 \end{matrix} \right]$$

$$\left[\begin{matrix} (-7)1 \\ 6 \end{matrix} \right]$$

$$\left[\begin{matrix} (-8)9 \\ 6 \end{matrix} \right]$$

$$\ln 10 = 2.30258 50929 940457$$

Table 4.2

NATURAL LOGARITHMS

x	$\ln x$			x	$\ln x$			x	$\ln x$		
1.200	0.18232	15567	939546	1.250	0.22314	35513	142098	1.300	0.26236	42644	674911
1.201	0.18315	45430	978465	1.251	0.22394	32314	847741	1.301	0.26313	31995	303682
1.202	0.18398	68361	130158	1.252	0.22474	22726	779068	1.302	0.26390	15437	863775
1.203	0.18481	84369	925418	1.253	0.22554	06759	139312	1.303	0.26466	92981	427081
1.204	0.18564	93468	866293	1.254	0.22633	84422	107290	1.304	0.26543	64635	044612
1.205	0.18647	95669	426183	1.255	0.22713	55725	837472	1.305	0.26620	30407	746567
1.206	0.18730	90983	049937	1.256	0.22793	20680	460069	1.306	0.26696	90308	542393
1.207	0.18813	79421	153944	1.257	0.22872	79296	081104	1.307	0.26773	44346	420849
1.208	0.18896	60995	126232	1.258	0.22952	31582	782488	1.308	0.26849	92530	350070
1.209	0.18979	35716	326556	1.259	0.23031	77550	622101	1.309	0.26926	34869	277629
1.210	0.19062	03596	086497	1.260	0.23111	17209	633866	1.310	0.27002	71372	130602
1.211	0.19144	64645	709552	1.261	0.23190	50569	827825	1.311	0.27079	02047	815628
1.212	0.19227	18876	471227	1.262	0.23269	77641	190214	1.312	0.27155	26905	218973
1.213	0.19309	66299	619131	1.263	0.23348	98433	683541	1.313	0.27231	45953	206591
1.214	0.19392	06926	373065	1.264	0.23428	12957	246657	1.314	0.27307	59200	624188
1.215	0.19474	40767	925118	1.265	0.23507	21221	794836	1.315	0.27383	66656	297279
1.216	0.19556	67835	439753	1.266	0.23586	23237	219844	1.316	0.27459	68329	031255
1.217	0.19638	88140	053901	1.267	0.23665	19013	390020	1.317	0.27535	64227	611440
1.218	0.19721	01692	877053	1.268	0.23744	08560	150342	1.318	0.27611	54360	803155
1.219	0.19803	08504	991345	1.269	0.23822	91887	322506	1.319	0.27687	38737	351775
1.220	0.19885	08587	451652	1.270	0.23901	69004	704999	1.320	0.27763	17365	982795
1.221	0.19967	01951	285676	1.271	0.23980	39922	073170	1.321	0.27838	90255	401883
1.222	0.20048	88607	494036	1.272	0.24059	04649	179304	1.322	0.27914	57414	294945
1.223	0.20130	68567	050353	1.273	0.24137	63195	752695	1.323	0.27990	18851	328186
1.224	0.20212	41840	901343	1.274	0.24216	15571	499716	1.324	0.28065	74575	148165
1.225	0.20294	08439	966903	1.275	0.24294	61786	103895	1.325	0.28141	24594	381855
1.226	0.20375	68375	140197	1.276	0.24373	01849	225981	1.326	0.28216	68917	636708
1.227	0.20457	21657	287744	1.277	0.24451	35770	504022	1.327	0.28292	07553	500705
1.228	0.20538	68297	249507	1.278	0.24529	63559	553431	1.328	0.28367	40510	542421
1.229	0.20620	08305	838978	1.279	0.24607	85225	967056	1.329	0.28442	67797	311083
1.230	0.20701	41693	843261	1.280	0.24686	00779	315258	1.330	0.28517	89422	336624
1.231	0.20782	68472	023165	1.281	0.24764	10229	145972	1.331	0.28593	05394	129746
1.232	0.20863	88651	113280	1.282	0.24842	13584	984783	1.332	0.28668	15721	181974
1.233	0.20945	02241	822072	1.283	0.24920	10856	334994	1.333	0.28743	20411	965716
1.234	0.21026	09254	831961	1.284	0.24998	02052	677694	1.334	0.28818	19474	934320
1.235	0.21107	09700	799405	1.285	0.25075	87183	471831	1.335	0.28893	12918	522129
1.236	0.21188	03590	354990	1.286	0.25153	66258	154276	1.336	0.28968	00751	144540
1.237	0.21268	90934	103508	1.287	0.25231	39286	139896	1.337	0.29042	82981	198061
1.238	0.21349	71742	624044	1.288	0.25309	06276	821619	1.338	0.29117	59617	060367
1.239	0.21430	46026	470054	1.289	0.25386	67239	570503	1.339	0.29192	30667	090355
1.240	0.21511	13796	169455	1.290	0.25464	22183	735807	1.340	0.29266	96139	628200
1.241	0.21591	75062	224702	1.291	0.25541	71118	645054	1.341	0.29341	56042	995415
1.242	0.21672	29835	112870	1.292	0.25619	14053	604101	1.342	0.29416	10385	494901
1.243	0.21752	78125	285741	1.293	0.25696	50997	897204	1.343	0.29490	59175	411005
1.244	0.21833	19943	169877	1.294	0.25773	81960	787088	1.344	0.29565	02421	009578
1.245	0.21913	55299	166709	1.295	0.25851	06951	515011	1.345	0.29639	40130	538024
1.246	0.21993	84203	652614	1.296	0.25928	25979	300830	1.346	0.29713	72312	225361
1.247	0.22074	06666	978994	1.297	0.26005	39053	343068	1.347	0.29787	98974	282269
1.248	0.22154	22699	472359	1.298	0.26082	46182	818983	1.348	0.29862	20124	901153
1.249	0.22234	32311	434406	1.299	0.26159	47376	884625	1.349	0.29936	35772	256188
1.250	0.22314	35513	142098	1.300	0.26236	42644	674911	1.350	0.30010	45924	503381
		$\left[\begin{smallmatrix} (-8)9 \\ 6 \end{smallmatrix} \right]$				$\left[\begin{smallmatrix} (-8)8 \\ 6 \end{smallmatrix} \right]$				$\left[\begin{smallmatrix} (-8)7 \\ 6 \end{smallmatrix} \right]$	

$$\ln 10 = 2.30258\ 50929\ 940457$$

NATURAL LOGARITHMS

Table 4.2

x	$\ln x$			x	$\ln x$			x	$\ln x$		
1.350	0.30010	45924	503381	1.400	0.33647	22366	212129	1.450	0.37156	35564	324830
1.351	0.30084	50589	780618	1.401	0.33718	62673	548700	1.451	0.37225	29739	020508
1.352	0.30158	49776	207723	1.402	0.33789	97886	123983	1.452	0.37294	19164	026043
1.353	0.30232	43491	886510	1.403	0.33861	28011	203239	1.453	0.37363	03845	881459
1.354	0.30306	31744	900833	1.404	0.33932	53056	036194	1.454	0.37431	83791	113276
1.355	0.30380	14543	316642	1.405	0.34003	73027	857091	1.455	0.37500	59006	234558
1.356	0.30453	91895	182038	1.406	0.34074	87933	884732	1.456	0.37569	29497	744942
1.357	0.30527	63808	527321	1.407	0.34145	97781	322520	1.457	0.37637	95272	130678
1.358	0.30601	30291	365044	1.408	0.34217	02577	358507	1.458	0.37706	56335	864664
1.359	0.30674	91351	690067	1.409	0.34288	02329	165432	1.459	0.37775	12695	406486
1.360	0.30748	46997	479606	1.410	0.34358	97043	900769	1.460	0.37843	64357	202451
1.361	0.30821	97236	693290	1.411	0.34429	86728	706770	1.461	0.37912	11327	685624
1.362	0.30895	42077	273206	1.412	0.34500	71390	710503	1.462	0.37980	53613	275868
1.363	0.30968	81527	143956	1.413	0.34571	51037	023904	1.463	0.38048	91220	379873
1.364	0.31042	15594	212704	1.414	0.34642	25674	743810	1.464	0.38117	24155	391198
1.365	0.31115	44286	369231	1.415	0.34712	95310	952009	1.465	0.38185	52424	690306
1.366	0.31188	67611	485983	1.416	0.34783	59952	715280	1.466	0.38253	76034	644597
1.367	0.31261	85577	418125	1.417	0.34854	19607	085434	1.467	0.38321	94991	608447
1.368	0.31334	98192	003587	1.418	0.34924	74281	099358	1.468	0.38390	09301	923238
1.369	0.31408	05463	063118	1.419	0.34995	23981	779056	1.469	0.38458	18971	917403
1.370	0.31481	07398	400335	1.420	0.35065	68716	131694	1.470	0.38526	24007	906449
1.371	0.31554	04005	801773	1.421	0.35136	08491	149636	1.471	0.38594	24416	193005
1.372	0.31626	95293	036935	1.422	0.35206	43313	810491	1.472	0.38662	20203	066845
1.373	0.31699	81267	858340	1.423	0.35276	73191	077153	1.473	0.38730	11374	804932
1.374	0.31772	61938	001576	1.424	0.35346	98129	897840	1.474	0.38797	97937	671449
1.375	0.31845	37311	185346	1.425	0.35417	18137	206138	1.475	0.38865	79897	917831
1.376	0.31918	07395	111519	1.426	0.35487	33219	921042	1.476	0.38933	57261	782808
1.377	0.31990	72197	465178	1.427	0.35557	43384	946994	1.477	0.39001	30035	492427
1.378	0.32063	31725	914668	1.428	0.35627	48639	173926	1.478	0.39068	98225	260100
1.379	0.32135	85988	111648	1.429	0.35697	48989	477304	1.479	0.39136	61837	286627
1.380	0.32208	34991	691133	1.430	0.35767	44442	718159	1.480	0.39204	20877	760237
1.381	0.32280	78744	271551	1.431	0.35837	35005	743139	1.481	0.39271	75352	856617
1.382	0.32353	17253	454782	1.432	0.35907	20685	384539	1.482	0.39339	25268	738951
1.383	0.32425	50526	826212	1.433	0.35977	01488	460348	1.483	0.39406	70631	557950
1.384	0.32497	78571	954778	1.434	0.36046	77421	774286	1.484	0.39474	11447	451887
1.385	0.32570	01396	393018	1.435	0.36116	48492	115844	1.485	0.39541	47722	546629
1.386	0.32642	19007	677115	1.436	0.36186	14706	260324	1.486	0.39608	79462	955674
1.387	0.32714	31413	326945	1.437	0.36255	76070	968879	1.487	0.39676	06674	780180
1.388	0.32786	38620	846128	1.438	0.36325	32592	988549	1.488	0.39743	29364	109001
1.389	0.32858	40637	722067	1.439	0.36394	84279	052308	1.489	0.39810	47537	018719
1.390	0.32930	37471	426004	1.440	0.36464	31135	879093	1.490	0.39877	61199	573678
1.391	0.33002	29129	413059	1.441	0.36533	73170	173850	1.491	0.39944	70357	826014
1.392	0.33074	15619	122279	1.442	0.36603	10388	627573	1.492	0.40011	75017	815691
1.393	0.33145	96947	976686	1.443	0.36672	42797	917338	1.493	0.40078	75185	570533
1.394	0.33217	73123	383321	1.444	0.36741	70404	706345	1.494	0.40145	70867	106256
1.395	0.33289	44152	733290	1.445	0.36810	93215	643955	1.495	0.40212	62068	426497
1.396	0.33361	10043	401807	1.446	0.36880	11237	365729	1.496	0.40279	48795	522855
1.397	0.33432	70802	748248	1.447	0.36949	24476	493468	1.497	0.40346	31054	374913
1.398	0.33504	26438	116185	1.448	0.37018	32939	635246	1.498	0.40413	08850	950277
1.399	0.33575	76956	833441	1.449	0.37087	36633	385453	1.499	0.40479	82191	204607
1.400	0.33647	22366	212129	1.450	0.37156	35564	324830	1.500	0.40546	51081	081644

$$\left[\begin{matrix} (-8)7 \\ 6 \end{matrix} \right]$$

$$\left[\begin{matrix} (-8)6 \\ 6 \end{matrix} \right]$$

$$\left[\begin{matrix} (-8)6 \\ 5 \end{matrix} \right]$$

$\ln 10 = 2.30258 50929 940457$

Table 4.2

NATURAL LOGARITHMS

x	$\ln x$			x	$\ln x$			x	$\ln x$		
1.500	0.40546	51081	081644	1.550	0.43825	49309	311553	1.600	0.47000	36292	457356
1.501	0.40613	15526	513249	1.551	0.43889	98841	944018	1.601	0.47062	84340	145776
1.502	0.40679	75533	419430	1.552	0.43954	44217	610270	1.602	0.47125	28486	461675
1.503	0.40746	31107	708374	1.553	0.44018	85441	665500	1.603	0.47187	68736	274159
1.504	0.40812	82255	276481	1.554	0.44083	22519	454557	1.604	0.47250	05094	443228
1.505	0.40879	28982	008391	1.555	0.44147	55456	311975	1.605	0.47312	37565	819792
1.506	0.40945	71293	777018	1.556	0.44211	84257	561999	1.606	0.47374	66155	245699
1.507	0.41012	09196	443584	1.557	0.44276	08928	518613	1.607	0.47436	90867	553755
1.508	0.41078	42695	857643	1.558	0.44340	29474	485565	1.608	0.47499	11707	567746
1.509	0.41144	71797	857118	1.559	0.44404	45900	756395	1.609	0.47561	28680	102462
1.510	0.41210	96508	268330	1.560	0.44468	58212	614457	1.610	0.47623	41789	963716
1.511	0.41277	16832	906025	1.561	0.44532	66415	332950	1.611	0.47685	51041	948373
1.512	0.41343	32777	573413	1.562	0.44596	70514	174942	1.612	0.47747	56440	844365
1.513	0.41409	44348	062189	1.563	0.44660	70514	393396	1.613	0.47809	57991	430718
1.514	0.41475	51550	152570	1.564	0.44724	66421	231193	1.614	0.47871	55698	477571
1.515	0.41541	54389	613325	1.565	0.44788	58239	921165	1.615	0.47933	49566	746199
1.516	0.41607	52872	201799	1.566	0.44852	45975	686114	1.616	0.47995	39600	989036
1.517	0.41673	47003	663952	1.567	0.44916	29633	738838	1.617	0.48057	25805	949698
1.518	0.41739	36789	734382	1.568	0.44980	09219	282161	1.618	0.48119	08186	362999
1.519	0.41805	22236	136358	1.569	0.45043	84737	508955	1.619	0.48180	86746	954981
1.520	0.41871	03348	581850	1.570	0.45107	56193	602167	1.620	0.48242	61492	442927
1.521	0.41936	80132	771558	1.571	0.45171	23592	734841	1.621	0.48304	32427	535391
1.522	0.42002	52594	394941	1.572	0.45234	86940	070148	1.622	0.48365	99556	932212
1.523	0.42068	20739	130248	1.573	0.45298	46240	761408	1.623	0.48427	62885	324542
1.524	0.42133	84572	644545	1.574	0.45362	01499	952115	1.624	0.48489	22417	394862
1.525	0.42199	44100	593749	1.575	0.45425	52722	775964	1.625	0.48550	78157	817008
1.526	0.42264	99328	622653	1.576	0.45488	99914	356874	1.626	0.48612	30111	256188
1.527	0.42330	50262	364954	1.577	0.45552	43079	809013	1.627	0.48673	78282	369007
1.528	0.42395	96907	443287	1.578	0.45615	82224	236825	1.628	0.48735	22675	803486
1.529	0.42461	39269	469252	1.579	0.45679	17352	735050	1.629	0.48796	63296	199081
1.530	0.42526	77354	043441	1.580	0.45742	48470	388754	1.630	0.48858	00148	186710
1.531	0.42592	11166	755467	1.581	0.45805	75582	273350	1.631	0.48919	33236	388768
1.532	0.42657	40713	183996	1.582	0.45868	98693	454621	1.632	0.48980	62565	419153
1.533	0.42722	65998	896771	1.583	0.45932	17808	988751	1.633	0.49041	88139	883281
1.534	0.42787	87029	450644	1.584	0.45995	32933	922341	1.634	0.49103	09964	378111
1.535	0.42853	03810	391605	1.585	0.46058	44073	292439	1.635	0.49164	28043	492167
1.536	0.42918	16347	254804	1.586	0.46121	51232	126562	1.636	0.49225	42381	805553
1.537	0.42983	24645	564588	1.587	0.46184	54415	442720	1.637	0.49286	52983	889979
1.538	0.43048	28710	834522	1.588	0.46247	53628	249440	1.638	0.49347	59854	308777
1.539	0.43113	28548	567422	1.589	0.46310	48875	545789	1.639	0.49408	62997	616926
1.540	0.43178	24164	255378	1.590	0.46373	40162	321402	1.640	0.49469	62418	361071
1.541	0.43243	15563	379787	1.591	0.46436	27493	556498	1.641	0.49530	58121	079538
1.542	0.43308	02751	411377	1.592	0.46499	10874	221913	1.642	0.49591	50110	302365
1.543	0.43372	85733	810238	1.593	0.46561	90309	279115	1.643	0.49652	38390	551310
1.544	0.43437	64516	025844	1.594	0.46624	65803	680233	1.644	0.49713	22966	339882
1.545	0.43502	39103	497088	1.595	0.46687	37362	368079	1.645	0.49774	03842	173352
1.546	0.43567	09501	652302	1.596	0.46750	04990	276170	1.646	0.49834	81022	548781
1.547	0.43631	75715	909291	1.597	0.46812	68692	328754	1.647	0.49895	54511	955033
1.548	0.43696	37751	675354	1.598	0.46875	28473	440829	1.648	0.49956	24314	872800
1.549	0.43760	95614	347316	1.599	0.46937	84338	518172	1.649	0.50016	90435	774619
1.550	0.43825	49309	311553	1.600	0.47000	36292	457356	1.650	0.50077	52879	124892

$$\left[\begin{matrix} (-8)6 \\ 5 \end{matrix} \right]$$

$$\left[\begin{matrix} (-8)5 \\ 5 \end{matrix} \right]$$

$$\left[\begin{matrix} (-8)5 \\ 5 \end{matrix} \right]$$

$$\ln 10 = 2.30258 \ 50929 \ 940457$$

NATURAL LOGARITHMS

Table 4.2

x	$\ln x$		x	$\ln x$		x	$\ln x$	
1.650	0.50077	52879 124892	1.700	0.53062	82510 621704	1.750	0.55961	57879 354227
1.651	0.50138	11649 379910	1.701	0.53121	63134 137247	1.751	0.56018	70533 037148
1.652	0.50198	66750 987863	1.702	0.53180	40301 511824	1.752	0.56075	79925 141997
1.653	0.50259	18188 388871	1.703	0.53239	14016 805512	1.753	0.56132	86059 390974
1.654	0.50319	65966 014996	1.704	0.53297	84284 071240	1.754	0.56189	88939 499913
1.655	0.50380	10088 290262	1.705	0.53356	51107 354801	1.755	0.56246	88569 178291
1.656	0.50440	50559 630679	1.706	0.53415	14490 694874	1.756	0.56303	84952 129249
1.657	0.50500	87384 444259	1.707	0.53473	74438 123036	1.757	0.56360	78092 049601
1.658	0.50561	20567 131032	1.708	0.53532	30953 663781	1.758	0.56417	67992 629853
1.659	0.50621	50112 083074	1.709	0.53590	84041 334538	1.759	0.56474	54657 554211
1.660	0.50681	76023 684519	1.710	0.53649	33705 145685	1.760	0.56531	38090 500604
1.661	0.50741	98306 311578	1.711	0.53707	79949 100564	1.761	0.56588	18295 140691
1.662	0.50802	16964 332564	1.712	0.53766	22777 195504	1.762	0.56644	95275 139878
1.663	0.50862	32002 107906	1.713	0.53824	62193 419829	1.763	0.56701	69034 157332
1.664	0.50922	43423 990168	1.714	0.53882	98201 755880	1.764	0.56758	39575 845396
1.665	0.50982	51234 324071	1.715	0.53941	30806 179032	1.765	0.56815	06903 852601
1.666	0.51042	55437 446509	1.716	0.53999	60010 657705	1.766	0.56871	71021 817683
1.667	0.51102	56037 686569	1.717	0.54057	85819 153385	1.767	0.56928	31933 375593
1.668	0.51162	53039 365550	1.718	0.54116	08235 620636	1.768	0.56984	89642 154517
1.669	0.51222	46446 796980	1.719	0.54174	27264 007122	1.769	0.57041	44151 776482
1.670	0.51282	36264 286637	1.720	0.54232	42908 253617	1.770	0.57097	95465 857378
1.671	0.51342	22496 132567	1.721	0.54290	55172 294024	1.771	0.57154	43588 006965
1.672	0.51402	05146 625099	1.722	0.54348	64060 055391	1.772	0.57210	88521 828892
1.673	0.51461	84220 046869	1.723	0.54406	69575 457926	1.773	0.57267	30270 920708
1.674	0.51521	59720 672836	1.724	0.54464	71722 415014	1.774	0.57323	68838 873877
1.675	0.51581	31652 770298	1.725	0.54522	70504 833231	1.775	0.57380	04229 273791
1.676	0.51641	00020 598913	1.726	0.54580	65926 612362	1.776	0.57436	36445 699783
1.677	0.51700	64828 410718	1.727	0.54638	57991 645415	1.777	0.57492	65491 725143
1.678	0.51760	26080 450144	1.728	0.54696	46703 818639	1.778	0.57548	91370 917128
1.679	0.51819	83780 954038	1.729	0.54754	32067 011534	1.779	0.57605	14086 836981
1.680	0.51879	37934 151676	1.730	0.54812	14085 096876	1.780	0.57661	33643 039938
1.681	0.51938	88544 264786	1.731	0.54869	92761 940722	1.781	0.57717	50043 075246
1.682	0.51998	35615 507563	1.732	0.54927	68101 402434	1.782	0.57773	63290 486176
1.683	0.52057	79152 086690	1.733	0.54985	40107 334690	1.783	0.57829	73388 810034
1.684	0.52117	19158 201350	1.734	0.55043	08783 583501	1.784	0.57885	80341 578176
1.685	0.52176	55638 043250	1.735	0.55100	74133 988225	1.785	0.57941	84152 316024
1.686	0.52235	88595 796637	1.736	0.55158	36162 381584	1.786	0.57997	84824 543073
1.687	0.52295	18035 638312	1.737	0.55215	94872 589679	1.787	0.58053	82361 772910
1.688	0.52354	43961 737654	1.738	0.55273	50268 432003	1.788	0.58109	76767 513224
1.689	0.52413	66378 256630	1.739	0.55331	02353 721460	1.789	0.58165	68045 265821
1.690	0.52472	85289 349821	1.740	0.55388	51132 264377	1.790	0.58221	56198 526636
1.691	0.52532	00699 164432	1.741	0.55445	96607 860520	1.791	0.58277	41230 785747
1.692	0.52591	12611 840315	1.742	0.55503	38784 303111	1.792	0.58333	23145 527387
1.693	0.52650	21031 509983	1.743	0.55560	77665 378839	1.793	0.58389	01946 229958
1.694	0.52709	25962 298627	1.744	0.55618	13254 867879	1.794	0.58444	77636 366044
1.695	0.52768	27408 324136	1.745	0.55675	45556 543905	1.795	0.58500	50219 402422
1.696	0.52827	25373 697113	1.746	0.55732	74574 174105	1.796	0.58556	19698 800079
1.697	0.52886	19862 520893	1.747	0.55790	00311 519195	1.797	0.58611	86078 014220
1.698	0.52945	10878 891556	1.748	0.55847	22772 333437	1.798	0.58667	49360 494285
1.699	0.53003	98426 897950	1.749	0.55904	41960 364650	1.799	0.58723	09549 683961
1.700	0.53062	82510 621704	1.750	0.55961	57879 354227	1.800	0.58778	66649 021190

$$\left[\begin{matrix} (-8)5 \\ 5 \end{matrix} \right]$$

$$\left[\begin{matrix} (-8)4 \\ 5 \end{matrix} \right]$$

$$\left[\begin{matrix} (-8)4 \\ 5 \end{matrix} \right]$$

$\ln 10 = 2.30258 50929 940457$

Table 4.2

NATURAL LOGARITHMS

x	$\ln x$			x	$\ln x$			x	$\ln x$		
1.800	0.58778	66649	021190	1.850	0.61518	56390	902335	1.900	0.64185	38861	723948
1.801	0.58834	20661	938190	1.851	0.61572	60335	913605	1.901	0.64238	00635	062921
1.802	0.58889	71591	861462	1.852	0.61626	61362	239876	1.902	0.64290	59641	231986
1.803	0.58945	19442	211802	1.853	0.61680	59473	032227	1.903	0.64343	15883	140124
1.804	0.59000	64216	404319	1.854	0.61734	54671	436634	1.904	0.64395	69363	691736
1.805	0.59056	05917	848442	1.855	0.61788	46960	593985	1.905	0.64448	20085	786643
1.806	0.59111	44549	947937	1.856	0.61842	36343	640088	1.906	0.64500	68052	320104
1.807	0.59166	80116	100914	1.857	0.61896	22823	705687	1.907	0.64553	13266	182820
1.808	0.59222	12619	699848	1.858	0.61950	06403	916468	1.908	0.64605	55730	260948
1.809	0.59277	42064	131581	1.859	0.62003	87087	393070	1.909	0.64657	95447	436106
1.810	0.59332	68452	777344	1.860	0.62057	64877	251099	1.910	0.64710	32420	585385
1.811	0.59387	91789	012763	1.861	0.62111	39776	601137	1.911	0.64762	66652	581360
1.812	0.59443	12076	207876	1.862	0.62165	11788	548753	1.912	0.64814	98146	292095
1.813	0.59498	29317	727140	1.863	0.62218	80916	194514	1.913	0.64867	26904	581158
1.814	0.59553	43516	929449	1.864	0.62272	47162	633994	1.914	0.64919	52930	307625
1.815	0.59608	54677	168141	1.865	0.62326	10530	957789	1.915	0.64971	76226	326093
1.816	0.59663	62801	791016	1.866	0.62379	71024	251521	1.916	0.65023	96795	486688
1.817	0.59718	67894	140341	1.867	0.62433	28645	595856	1.917	0.65076	14640	635074
1.818	0.59773	69957	552871	1.868	0.62486	83398	066509	1.918	0.65128	29764	612465
1.819	0.59828	68995	359852	1.869	0.62540	35284	734258	1.919	0.65180	42170	255629
1.820	0.59883	65010	887040	1.870	0.62593	84308	664953	1.920	0.65232	51860	396902
1.821	0.59938	58007	454709	1.871	0.62647	30472	919526	1.921	0.65284	58837	864196
1.822	0.59993	47988	377666	1.872	0.62700	73780	554003	1.922	0.65336	63105	481007
1.823	0.60048	34956	965260	1.873	0.62754	14234	619515	1.923	0.65388	64666	066427
1.824	0.60103	18916	521396	1.874	0.62807	51838	162304	1.924	0.65440	63522	435147
1.825	0.60157	99870	344548	1.875	0.62860	86594	223741	1.925	0.65492	59677	397475
1.826	0.60212	77821	727767	1.876	0.62914	18505	840329	1.926	0.65544	53133	759338
1.827	0.60267	52773	958697	1.877	0.62967	47576	043718	1.927	0.65596	43894	322293
1.828	0.60322	24730	319583	1.878	0.63020	73807	860712	1.928	0.65648	31961	883539
1.829	0.60376	93694	087286	1.879	0.63073	97204	313283	1.929	0.65700	17339	235920
1.830	0.60431	59668	533296	1.880	0.63127	17768	418578	1.930	0.65752	00029	167942
1.831	0.60486	22656	923737	1.881	0.63180	35503	188933	1.931	0.65803	80034	463774
1.832	0.60540	82662	519385	1.882	0.63233	50411	631879	1.932	0.65855	57357	903263
1.833	0.60595	39688	575680	1.883	0.63286	62496	750154	1.933	0.65907	32002	261938
1.834	0.60649	93738	342731	1.884	0.63339	71761	541713	1.934	0.65959	03970	311026
1.835	0.60704	44815	065336	1.885	0.63392	78208	999741	1.935	0.66010	73264	817451
1.836	0.60758	92921	982987	1.886	0.63445	81842	112658	1.936	0.66062	39888	543853
1.837	0.60813	38062	329886	1.887	0.63498	82663	864132	1.937	0.66114	03844	248588
1.838	0.60867	80239	334953	1.888	0.63551	80677	233089	1.938	0.66165	65134	685745
1.839	0.60922	19456	221840	1.889	0.63604	75885	193725	1.939	0.66217	23762	605148
1.840	0.60976	55716	208943	1.890	0.63657	68290	715510	1.940	0.66268	79730	752368
1.841	0.61030	89022	509408	1.891	0.63710	57896	763204	1.941	0.66320	33041	868732
1.842	0.61085	19378	331151	1.892	0.63763	44706	296865	1.942	0.66371	83698	691332
1.843	0.61139	46786	876862	1.893	0.63816	28722	271858	1.943	0.66423	31703	953030
1.844	0.61193	71251	344021	1.894	0.63869	09947	638865	1.944	0.66474	77060	382473
1.845	0.61247	92774	924905	1.895	0.63921	88385	343897	1.945	0.66526	19770	704096
1.846	0.61302	11360	806604	1.896	0.63974	64038	328301	1.946	0.66577	59837	638133
1.847	0.61356	27012	171029	1.897	0.64027	36909	528772	1.947	0.66628	97263	900626
1.848	0.61410	39732	194924	1.898	0.64080	07001	877361	1.948	0.66680	32052	203434
1.849	0.61464	49524	049878	1.899	0.64132	74318	301488	1.949	0.66731	64205	254238
1.850	0.61518	56390	902335	1.900	0.64185	38861	723948	1.950	0.66782	93725	756554

$$\left[\begin{matrix} (-8)4 \\ 5 \end{matrix} \right]$$

$$\left[\begin{matrix} (-8)4 \\ 5 \end{matrix} \right]$$

$$\left[\begin{matrix} (-8)3 \\ 5 \end{matrix} \right]$$

$$\ln 10 = 2.30258 50929 940457$$

NATURAL LOGARITHMS

Table 4.2

x	$\ln x$		x	$\ln x$		x	$\ln x$	
1.950	0.66782	93725 756554	2.000	0.69314	71805 599453	2.050	0.71783	97931 503168
1.951	0.66834	20616 409742	2.001	0.69364	70556 015964	2.051	0.71832	74790 902436
1.952	0.66885	44879 909007	2.002	0.69414	66808 930288	2.052	0.71881	49273 085231
1.953	0.66936	66518 945419	2.003	0.69464	60566 836812	2.053	0.71930	21380 367965
1.954	0.66987	85536 205910	2.004	0.69514	51832 226184	2.054	0.71978	91115 063665
1.955	0.67039	01934 373291	2.005	0.69564	40607 585325	2.055	0.72027	58479 481979
1.956	0.67090	15716 126256	2.006	0.69614	26895 397438	2.056	0.72076	23475 929187
1.957	0.67141	26884 139392	2.007	0.69664	10698 142011	2.057	0.72124	86106 708201
1.958	0.67192	35441 083186	2.008	0.69713	92018 294828	2.058	0.72173	46374 118579
1.959	0.67243	41389 624037	2.009	0.69763	70858 327974	2.059	0.72222	04280 456524
1.960	0.67294	44732 424259	2.010	0.69813	47220 709844	2.060	0.72270	59828 014897
1.961	0.67345	45472 142092	2.011	0.69863	21107 905150	2.061	0.72319	13019 083220
1.962	0.67396	43611 431713	2.012	0.69912	92522 374928	2.062	0.72367	63855 947682
1.963	0.67447	39152 943240	2.013	0.69962	61466 576544	2.063	0.72416	12340 891148
1.964	0.67498	32099 322741	2.014	0.70012	27942 963706	2.064	0.72464	58476 193163
1.965	0.67549	22453 212246	2.015	0.70061	91953 986463	2.065	0.72513	02264 129961
1.966	0.67600	10217 249748	2.016	0.70111	53502 091222	2.066	0.72561	43706 974468
1.967	0.67650	95394 069220	2.017	0.70161	12589 720747	2.067	0.72609	82806 996312
1.968	0.67701	77986 300617	2.018	0.70210	69219 314172	2.068	0.72658	19566 461827
1.969	0.67752	57996 569885	2.019	0.70260	23393 307004	2.069	0.72706	53987 634060
1.970	0.67803	35427 498971	2.020	0.70309	75114 131134	2.070	0.72754	86072 772777
1.971	0.67854	10281 705832	2.021	0.70359	24384 214840	2.071	0.72803	15824 134471
1.972	0.67904	82561 804437	2.022	0.70408	71205 982797	2.072	0.72851	43243 972366
1.973	0.67955	52270 404783	2.023	0.70458	15581 856084	2.073	0.72899	68334 536425
1.974	0.68006	19410 112898	2.024	0.70507	57514 252191	2.074	0.72947	91098 073356
1.975	0.68056	83983 530852	2.025	0.70556	97005 585025	2.075	0.72996	11536 826616
1.976	0.68107	45993 256761	2.026	0.70606	34058 264916	2.076	0.73044	29653 036422
1.977	0.68158	05441 884799	2.027	0.70655	68674 698630	2.077	0.73092	45448 939753
1.978	0.68208	62332 005204	2.028	0.70705	00857 289367	2.078	0.73140	58926 770357
1.979	0.68259	16666 204287	2.029	0.70754	30608 436777	2.079	0.73188	70088 758759
1.980	0.68309	68447 064439	2.030	0.70803	57930 536960	2.080	0.73236	78937 132266
1.981	0.68360	17677 164139	2.031	0.70852	82825 982476	2.081	0.73284	85474 114974
1.982	0.68410	64359 077962	2.032	0.70902	05297 162355	2.082	0.73332	89701 927771
1.983	0.68461	08495 376589	2.033	0.70951	25346 462096	2.083	0.73380	91622 788349
1.984	0.68511	50088 626811	2.034	0.71000	42976 263682	2.084	0.73428	91238 911205
1.985	0.68561	89141 391537	2.035	0.71049	58188 945583	2.085	0.73476	88552 507648
1.986	0.68612	25656 229808	2.036	0.71098	70986 882763	2.086	0.73524	83565 785807
1.987	0.68662	59635 696798	2.037	0.71147	81372 446688	2.087	0.73572	76280 950637
1.988	0.68712	91082 343823	2.038	0.71196	89348 005331	2.088	0.73620	66700 203923
1.989	0.68763	19998 718351	2.039	0.71245	94915 923181	2.089	0.73668	54825 744287
1.990	0.68813	46387 364010	2.040	0.71294	98078 561250	2.090	0.73716	40659 767196
1.991	0.68863	70250 820592	2.041	0.71343	98838 277077	2.091	0.73764	24204 464965
1.992	0.68913	91591 624065	2.042	0.71392	97197 424738	2.092	0.73812	05462 026765
1.993	0.68964	10412 306577	2.043	0.71441	93158 354850	2.093	0.73859	84434 638627
1.994	0.69014	26715 396466	2.044	0.71490	86723 414580	2.094	0.73907	61124 483451
1.995	0.69064	40503 418268	2.045	0.71539	77894 947651	2.095	0.73955	35533 741011
1.996	0.69114	51778 892722	2.046	0.71588	66675 294347	2.096	0.74003	07664 587957
1.997	0.69164	60544 336782	2.047	0.71637	53066 791525	2.097	0.74050	77519 197829
1.998	0.69214	66802 263618	2.048	0.71686	37071 772614	2.098	0.74098	45099 741054
1.999	0.69264	70555 182630	2.049	0.71735	18692 567627	2.099	0.74146	10408 384959
2.000	0.69314	71805 599453	2.050	0.71783	97931 503168	2.100	0.74193	73447 293773
	$\left[\begin{smallmatrix} (-8)3 \\ 5 \end{smallmatrix} \right]$			$\left[\begin{smallmatrix} (-8)3 \\ 5 \end{smallmatrix} \right]$			$\left[\begin{smallmatrix} (-8)3 \\ 5 \end{smallmatrix} \right]$	

For $x > 2.1$ see Example 5.

$\ln 10 = 2.30258 50929 940457$

Table 4.3

RADIX TABLE OF NATURAL LOGARITHMS

x	n	$\ln(1+x10^{-n})$					$-\ln(1-x10^{-n})$				
1	10	0.00000	00000	99999	99999	50000	0.00000	00001	00000	00000	50000
2	10	0.00000	00001	99999	99998	00000	0.00000	00002	00000	00002	00000
3	10	0.00000	00002	99999	99995	50000	0.00000	00003	00000	00004	50000
4	10	0.00000	00003	99999	99992	00000	0.00000	00004	00000	00008	00000
5	10	0.00000	00004	99999	99987	50000	0.00000	00005	00000	00012	50000
6	10	0.00000	00005	99999	99982	00000	0.00000	00006	00000	00018	00000
7	10	0.00000	00006	99999	99975	50000	0.00000	00007	00000	00024	50000
8	10	0.00000	00007	99999	99968	00000	0.00000	00008	00000	00032	00000
9	10	0.00000	00008	99999	99959	50000	0.00000	00009	00000	00040	50000
1	9	0.00000	00009	99999	99950	00000	0.00000	00010	00000	00050	00000
2	9	0.00000	00019	99999	99800	00000	0.00000	00020	00000	00200	00000
3	9	0.00000	00029	99999	99550	00000	0.00000	00030	00000	00450	00000
4	9	0.00000	00039	99999	99200	00000	0.00000	00040	00000	00800	00000
5	9	0.00000	00049	99999	98750	00000	0.00000	00050	00000	01250	00000
6	9	0.00000	00059	99999	98200	00001	0.00000	00060	00000	01800	00001
7	9	0.00000	00069	99999	97550	00001	0.00000	00070	00000	02450	00001
8	9	0.00000	00079	99999	96800	00002	0.00000	00080	00000	03200	00002
9	9	0.00000	00089	99999	95950	00002	0.00000	00090	00000	04050	00002
1	8	0.00000	00099	99999	95000	00003	0.00000	00100	00000	05000	00003
2	8	0.00000	00199	99999	80000	00027	0.00000	00200	00000	20000	00027
3	8	0.00000	00299	99999	55000	00090	0.00000	00300	00000	45000	00090
4	8	0.00000	00399	99999	20000	00213	0.00000	00400	00000	80000	00213
5	8	0.00000	00499	99998	75000	00417	0.00000	00500	00001	25000	00417
6	8	0.00000	00599	99998	20000	00720	0.00000	00600	00001	80000	00720
7	8	0.00000	00699	99997	55000	01143	0.00000	00700	00002	45000	01143
8	8	0.00000	00799	99996	80000	01707	0.00000	00800	00003	20000	01707
9	8	0.00000	00899	99995	95000	02430	0.00000	00900	00004	05000	02430
1	7	0.00000	00999	99995	00000	03333	0.00000	01000	00005	00000	03333
2	7	0.00000	01999	99980	00000	26667	0.00000	02000	00020	00000	26667
3	7	0.00000	02999	99955	00000	90000	0.00000	03000	00045	00000	90000
4	7	0.00000	03999	99920	00002	13333	0.00000	04000	00080	00002	13333
5	7	0.00000	04999	99875	00004	16667	0.00000	05000	00125	00004	16667
6	7	0.00000	05999	99820	00007	20000	0.00000	06000	00180	00007	20000
7	7	0.00000	06999	99755	00011	43333	0.00000	07000	00245	00011	43334
8	7	0.00000	07999	99680	00017	06666	0.00000	08000	00320	00017	06668
9	7	0.00000	08999	99595	00024	29998	0.00000	09000	00405	00024	30002
1	6	0.00000	09999	99500	00033	33331	0.00000	10000	00500	00033	33336
2	6	0.00000	19999	98000	00266	66627	0.00000	20000	02000	00266	66707
3	6	0.00000	29999	95500	00899	99798	0.00000	30000	04500	00900	00203
4	6	0.00000	39999	92000	02133	32693	0.00000	40000	08000	02133	33973
5	6	0.00000	49999	87500	04166	65104	0.00000	50000	12500	04166	68229
6	6	0.00000	59999	82000	07199	96760	0.00000	60000	18000	07200	03240
7	6	0.00000	69999	75500	11433	27331	0.00000	70000	24500	11433	39336
8	6	0.00000	79999	68000	17066	56427	0.00000	80000	32000	17066	76907
9	6	0.00000	89999	59500	24299	83598	0.00000	90000	40500	24300	16403

For $n > 10$, $\ln(1 \pm x10^{-n}) = \pm x10^{-n} - \frac{1}{2}x^2 10^{-2n}$ to 25D.

RADIX TABLE OF NATURAL LOGARITHMS

Table 4.3

x	n	$\ln(1+x10^{-n})$						$-\ln(1-x10^{-n})$					
1	5	0.00000	99999	50000	33333	08334	0.00001	00000	50000	33333	58334		
2	5	0.00001	99998	00002	66662	66673	0.00002	00002	00002	66670	66673		
3	5	0.00002	99995	50008	99979	75049	0.00003	00004	50009	00020	25049		
4	5	0.00003	99992	00021	33269	33538	0.00004	00008	00021	33397	33538		
5	5	0.00004	99987	50041	66510	42292	0.00005	00012	50041	66822	92292		
6	5	0.00005	99982	00071	99676	01555	0.00006	00018	00072	00324	01555		
7	5	0.00006	99975	50114	32733	11695	0.00007	00024	50114	33933	61695		
8	5	0.00007	99968	00170	65642	73220	0.00008	00032	00170	67690	73221		
9	5	0.00008	99959	50242	98359	86809	0.00009	00040	50243	01640	36811		
1	4	0.00009	99950	00333	30833	53332	0.00010	00050	00333	35833	53335		
2	4	0.00019	99800	02666	26673	06560	0.00020	00200	02667	06673	06773		
3	4	0.00029	99550	08997	97548	58785	0.00030	00450	09002	02548	61215		
4	4	0.00039	99200	21326	93538	06509	0.00040	00800	21339	73538	20162		
5	4	0.00049	98750	41651	04791	40636	0.00050	01250	41682	29791	92719		
6	4	0.00059	98200	71967	61554	42280	0.00060	01800	72032	41555	97800		
7	4	0.00069	97551	14273	34192	77369	0.00070	02451	14393	39196	69533		
8	4	0.00079	96801	70564	33215	90059	0.00080	03201	70769	13224	63873		
9	4	0.00089	95952	42836	09300	94948	0.00090	04052	43164	14318	66419		
1	3	0.00099	95003	33083	53316	68094	0.00100	05003	33583	53350	01430		
2	3	0.00199	80026	62673	05601	82538	0.00200	20026	70673	07735	16511		
3	3	0.00299	55089	79798	47881	16106	0.00300	45090	20298	72181	32509		
4	3	0.00399	20212	69537	45299	90751	0.00400	80213	97538	81834	87927		
5	3	0.00498	75415	11039	07361	21022	0.00501	25418	23544	28204	30937		
6	3	0.00598	20716	77547	46378	20189	0.00601	80723	25563	01620	19350		
7	3	0.00697	56137	36425	24209	95222	0.00702	46149	36964	45987	41123		
8	3	0.00796	81696	49176	87351	07973	0.00803	21716	97264	25903	86494		
9	3	0.00895	97413	71471	90444	31465	0.00904	07446	52149	06220	55241		
1	2	0.00995	03308	53168	08284	82154	0.01005	03358	53501	44118	35489		
2	2	0.01980	26272	96179	71302	60291	0.02020	27073	17519	44840	80453		
3	2	0.02955	88022	41544	40273	26194	0.03045	92074	84708	54591	92613		
4	2	0.03922	07131	53281	29626	92009	0.04082	19945	20255	12955	45771		
5	2	0.04879	01641	69432	00306	53744	0.05129	32943	87550	53342	61961		
6	2	0.05826	89081	23975	77552	57184	0.06187	54037	18087	47179	78001		
7	2	0.06765	86484	73814	80526	84159	0.07257	06928	34835	43071	15733		
8	2	0.07696	10411	36128	32498	42170	0.08338	16089	39051	05839	47658		
9	2	0.08617	76962	41052	33234	13335	0.09431	06794	71241	32687	71427		
1	1	0.09531	01798	04324	86004	39521	0.10536	05156	57826	30122	75010		
2	1	0.18232	15567	93954	62621	17180	0.22314	35513	14209	75576	62951		
3	1	0.26236	42644	67491	05203	54960	0.35667	49439	38732	37891	26387		
4	1	0.33647	22366	21212	93050	45934	0.51082	56237	65990	68320	55141		
5	1	0.40546	51081	08164	38197	80131	0.69314	71805	59945	30941	72321		
6	1	0.47000	36292	45735	55365	09370	0.91629	07318	74155	06518	35272		
7	1	0.53062	82510	62170	39623	15432	1.20397	28043	25935	99262	27462		
8	1	0.58778	66649	02119	00818	97311	1.60943	79124	34100	37460	07593		
9	1	0.64185	38861	72394	77599	10360	2.30258	50929	94045	68401	79915		
1	0	0.69314	71805	59945	30941	72321					∞		

Table 4.4

EXPONENTIAL FUNCTION

x	e^x				e^{-x}			
0.000	1.00000	00000	00000	000	1.00000	00000	00000	000
0.001	1.00100	05001	66708	342	0.99900	04998	33374	992
0.002	1.00200	20013	34000	267	0.99800	19986	67333	067
0.003	1.00300	45045	03377	026	0.99700	44955	03372	976
0.004	1.00400	80106	77341	872	0.99600	79893	43991	472
0.005	1.00501	25208	59401	063	0.99501	24791	92682	313
0.006	1.00601	80360	54064	865	0.99401	79640	53935	265
0.007	1.00702	45572	66848	555	0.99302	44429	33235	105
0.008	1.00803	20855	04273	431	0.99203	19148	37060	630
0.009	1.00904	06217	73867	814	0.99104	03787	72883	662
0.010	1.01005	01670	84168	058	0.99004	8337	49168	054
0.011	1.01106	07224	44719	556	0.98906	02787	75368	698
0.012	1.01207	22888	66077	754	0.98807	17128	61930	540
0.013	1.01308	48673	59809	158	0.98708	41350	20287	583
0.014	1.01409	84589	38492	345	0.98609	75442	62861	903
0.015	1.01511	30646	15718	979	0.98511	19396	03062	661
0.016	1.01612	86854	06094	822	0.98412	73200	55285	115
0.017	1.01714	53223	25240	748	0.98314	36846	34909	635
0.018	1.01816	29763	89793	761	0.98216	10323	58300	718
0.019	1.01918	16486	17408	011	0.98117	93622	42806	006
0.020	1.02020	13400	26755	810	0.98019	86733	06755	302
0.021	1.02122	20516	37528	653	0.97921	89645	69459	588
0.022	1.02224	37844	70438	235	0.97824	02350	51210	045
0.023	1.02326	65395	47217	475	0.97726	24837	73277	073
0.024	1.02429	03178	90621	534	0.97628	57097	57909	314
0.025	1.02531	51205	24428	841	0.97530	99120	28332	669
0.026	1.02634	09484	73442	115	0.97433	50896	08749	328
0.027	1.02736	78027	63489	392	0.97336	12415	24336	791
0.028	1.02839	56844	21425	045	0.97238	83668	01246	891
0.029	1.02942	45944	75130	820	0.97141	64644	66604	825
0.030	1.03045	45339	53516	856	0.97044	55335	48508	177
0.031	1.03148	55038	86522	716	0.96947	55730	76025	948
0.032	1.03251	75053	05118	420	0.96850	65820	79197	585
0.033	1.03355	05392	41305	472	0.96753	85595	89032	009
0.034	1.03458	46067	28117	894	0.96657	15046	37506	651
0.035	1.03561	97087	99623	260	0.96560	54162	57566	478
0.036	1.03665	58464	90923	727	0.96464	02934	83123	030
0.037	1.03769	30208	38157	074	0.96367	61353	49053	452
0.038	1.03873	12328	78497	733	0.96271	29408	91199	529
0.039	1.03977	04836	50157	831	0.96175	07091	46366	723
0.040	1.04081	07741	92388	227	0.96078	94391	52323	209
0.041	1.04185	21055	45479	549	0.95982	91299	47798	914
0.042	1.04289	44787	50763	238	0.95886	97805	72484	552
0.043	1.04393	78948	50612	586	0.95791	13900	67030	669
0.044	1.04498	23548	88443	779	0.95695	39574	73046	678
0.045	1.04602	78599	08716	943	0.95599	74818	33099	907
0.046	1.04707	44109	56937	184	0.95504	19621	90714	635
0.047	1.04812	20090	79655	638	0.95408	73975	90371	141
0.048	1.04917	06553	24470	516	0.95313	37870	77504	745
0.049	1.05022	03507	40028	148	0.95218	11296	98504	853
0.050	1.05127	10963	76024	040	0.95122	94245	00714	009
		$\left[\begin{smallmatrix} (-7) \\ 6 \end{smallmatrix} \right]$				$\left[\begin{smallmatrix} (-7) \\ 6 \end{smallmatrix} \right]$		

For use and extension of the table see Examples 8-11.

See Table 7.1 for values of $\frac{2}{\sqrt{\pi}} e^{-x^2}$ and Table 26.1 for $\frac{1}{\sqrt{2\pi}} e^{-\frac{x^2}{2}}$.

EXPONENTIAL FUNCTION

Table 4.4

x	e^x				e^{-x}			
0.050	1.05127	10963	76024	040	0.95122	94245	00714	009
0.051	1.05232	28932	83203	913	0.95027	86705	32426	935
0.052	1.05337	57425	13364	763	0.94932	88668	42889	583
0.053	1.05442	96451	19355	907	0.94838	00124	82298	184
0.054	1.05548	46021	55080	041	0.94743	21065	01798	300
0.055	1.05654	06146	75494	286	0.94648	51479	53483	869
0.056	1.05759	76837	36611	252	0.94553	91358	90396	267
0.057	1.05865	58103	95500	087	0.94459	40693	66523	349
0.058	1.05971	49957	10287	540	0.94364	99474	36798	514
0.059	1.06077	52407	40159	012	0.94270	67691	57099	754
0.060	1.06183	65465	45359	622	0.94176	45335	84248	710
0.061	1.06289	89141	87195	264	0.94082	32397	76009	730
0.062	1.06396	23447	28033	669	0.93988	28867	91088	928
0.063	1.06502	68392	31305	464	0.93894	34736	89133	241
0.064	1.06609	23987	61505	244	0.93800	49995	30729	488
0.065	1.06715	90243	84192	625	0.93706	74633	77403	433
0.066	1.06822	67171	65993	321	0.93613	08642	91618	844
0.067	1.06929	54781	74600	202	0.93519	52013	36776	558
0.068	1.07036	53084	78774	366	0.93426	04735	77213	542
0.069	1.07143	62091	48346	205	0.93332	66800	78201	958
0.070	1.07250	81812	54216	479	0.93239	38199	05948	229
0.071	1.07358	12258	68357	383	0.93146	18921	27592	106
0.072	1.07465	53440	63813	620	0.93053	08958	11205	732
0.073	1.07573	05369	14703	476	0.92960	08300	25792	713
0.074	1.07680	68054	96219	891	0.92867	16938	41287	187
0.075	1.07788	41508	84631	536	0.92774	34863	28552	892
0.076	1.07896	25741	57285	889	0.92681	62065	59382	237
0.077	1.08004	20763	92600	313	0.92588	98536	06495	377
0.078	1.08112	26586	70083	133	0.92496	44265	43539	280
0.079	1.08220	43220	70314	717	0.92403	99244	45086	807
0.080	1.08328	70676	74958	554	0.92311	63463	86635	783
0.081	1.08437	08965	66760	341	0.92219	36914	44608	072
0.082	1.08545	58098	29549	059	0.92127	19586	96348	654
0.083	1.08654	18085	48238	061	0.92035	11472	20124	706
0.084	1.08762	88938	08826	156	0.91943	12560	95124	674
0.085	1.08871	70666	98398	696	0.91851	22844	01457	356
0.086	1.08980	63283	05128	660	0.91759	42312	20150	982
0.087	1.09089	66797	18277	747	0.91667	70956	33152	295
0.088	1.09198	81220	28197	460	0.91576	08767	23325	631
0.089	1.09308	06563	26330	201	0.91484	55735	74452	003
0.090	1.09417	42837	05210	358	0.91393	11852	71228	187
0.091	1.09526	90052	58465	401	0.91301	77108	99265	803
0.092	1.09636	48220	80816	975	0.91210	51495	45090	403
0.093	1.09746	17352	68081	994	0.91119	35002	96140	557
0.094	1.09855	97459	17173	736	0.91028	27622	40766	940
0.095	1.09965	88551	26102	942	0.90937	29344	68231	420
0.096	1.10075	90639	93978	912	0.90846	40160	68706	150
0.097	1.10186	03736	21010	606	0.90755	60061	33272	654
0.098	1.10296	27851	08507	743	0.90664	89037	53920	921
0.099	1.10406	62995	58881	902	0.90574	27080	23548	496
0.100	1.10517	09180	75647	625	0.90483	74180	35959	573
		$\left[\begin{smallmatrix} (-7)1 \\ 6 \end{smallmatrix} \right]$					$\left[\begin{smallmatrix} (-7)1 \\ 6 \end{smallmatrix} \right]$	

Table 4.4

EXPONENTIAL FUNCTION

x	e^x				e^{-x}			
0.100	1.10517	09180	75647	625	0.90483	74180	35959	573
0.101	1.10627	66417	63423	521	0.90393	30328	85864	089
0.102	1.10738	34717	27933	371	0.90302	95516	68876	819
0.103	1.10849	14090	76007	230	0.90212	69734	81516	470
0.104	1.10960	04549	15582	540	0.90122	52974	21204	780
0.105	1.11071	06103	55705	232	0.90032	45225	86265	613
0.106	1.11182	18765	06530	839	0.89942	46480	75924	059
0.107	1.11293	42544	79325	605	0.89852	56729	90305	534
0.108	1.11404	77453	86467	594	0.89762	75964	30434	876
0.109	1.11516	23503	41447	807	0.89673	04174	98235	450
0.110	1.11627	80704	58871	292	0.89583	41352	96528	251
0.111	1.11739	49068	54458	258	0.89493	87489	29031	000
0.112	1.11851	28606	45045	196	0.89404	42575	00357	257
0.113	1.11963	19329	48585	987	0.89315	06601	16015	519
0.114	1.12075	21248	84153	031	0.89225	79558	82408	325
0.115	1.12187	34375	71938	354	0.89136	61439	06831	368
0.116	1.12299	58721	33254	738	0.89047	52232	97472	599
0.117	1.12411	94296	90536	839	0.88958	51931	63411	334
0.118	1.12524	41113	67342	307	0.88869	60526	14617	364
0.119	1.12636	99182	88352	913	0.88780	78007	61950	067
0.120	1.12749	68515	79375	671	0.88692	04367	17157	516
0.121	1.12862	49123	67343	967	0.88603	39595	92875	591
0.122	1.12975	41017	80318	682	0.88514	83685	02627	096
0.123	1.13088	44209	47489	324	0.88426	36625	60820	866
0.124	1.13201	58709	99175	153	0.88337	98408	82750	886
0.125	1.13314	84530	66826	317	0.88249	69025	84595	403
0.126	1.13428	21682	83024	976	0.88161	48467	83416	046
0.127	1.13541	70177	81486	442	0.88073	36725	97156	940
0.128	1.13655	30026	97060	307	0.87985	33791	44643	827
0.129	1.13769	01241	65731	582	0.87897	39655	45583	178
0.130	1.13882	83833	24621	831	0.87809	54309	20561	324
0.131	1.13996	77813	11990	306	0.87721	77743	91043	564
0.132	1.14110	83192	67235	091	0.87634	09950	79373	297
0.133	1.14224	99983	30894	235	0.87546	50921	08771	138
0.134	1.14339	28196	44646	898	0.87459	00646	03334	043
0.135	1.14453	67843	51314	488	0.87371	59116	88034	434
0.136	1.14568	18935	94861	807	0.87284	26324	88719	322
0.137	1.14682	81485	20398	195	0.87197	02261	32109	436
0.138	1.14797	55502	74178	672	0.87109	86917	45798	347
0.139	1.14912	41000	03605	088	0.87022	80284	58251	595
0.140	1.15027	37988	57227	268	0.86935	82353	98805	820
0.141	1.15142	46479	84744	161	0.86848	93116	97667	890
0.142	1.15257	66485	37004	992	0.86762	12564	85914	032
0.143	1.15372	98016	66010	407	0.86675	40688	95488	962
0.144	1.15488	41085	24913	632	0.86588	77480	59205	017
0.145	1.15603	95702	68021	623	0.86502	22931	10741	288
0.146	1.15719	61880	50796	218	0.86415	77031	84642	755
0.147	1.15835	39630	29855	297	0.86329	39774	16319	421
0.148	1.15951	28963	62973	936	0.86243	11149	42045	443
0.149	1.16067	29892	09085	563	0.86156	91148	98958	277
0.150	1.16183	42427	28283	123	0.86070	79764	25057	807
		$\left[\begin{smallmatrix} (-7)1 \\ 6 \end{smallmatrix} \right]$					$\left[\begin{smallmatrix} (-7)1 \\ 6 \end{smallmatrix} \right]$	

EXPONENTIAL FUNCTION

Table 4.4

x	e^x				e^{-x}			
0.150	1.16183	42427	28283	123	0.86070	79764	25057	807
0.151	1.16299	66580	81820	230	0.85984	76986	59205	488
0.152	1.16416	02364	32112	335	0.85898	82807	41123	482
0.153	1.16532	49789	42737	886	0.85812	97218	11393	800
0.154	1.16649	08867	78439	490	0.85727	20210	11457	440
0.155	1.16765	79611	05125	080	0.85641	51774	83613	531
0.156	1.16882	62030	89869	080	0.85555	91903	71018	473
0.157	1.16999	56139	00913	572	0.85470	40588	17685	083
0.158	1.17116	61947	07669	465	0.85384	97819	68481	735
0.159	1.17233	79466	80717	662	0.85299	63589	69131	511
0.160	1.17351	08709	91810	235	0.85214	37889	66211	338
0.161	1.17468	49688	13871	592	0.85129	20711	07151	144
0.162	1.17586	02413	20999	654	0.85044	12045	40232	998
0.163	1.17703	66896	88467	025	0.84959	11884	14590	263
0.164	1.17821	43150	92722	171	0.84874	20218	80206	741
0.165	1.17939	31187	11390	594	0.84789	37040	87915	828
0.166	1.18057	31017	23276	011	0.84704	62341	89399	660
0.167	1.18175	42653	08361	533	0.84619	96113	37188	270
0.168	1.18293	66106	47810	843	0.84535	38346	84658	733
0.169	1.18412	01389	23969	378	0.84450	89033	86034	326
0.170	1.18530	48513	20365	514	0.84366	48165	96383	682
0.171	1.18649	07490	21711	746	0.84282	15734	71619	939
0.172	1.18767	78332	13905	874	0.84197	91731	68499	904
0.173	1.18886	61050	84032	188	0.84113	76148	44623	201
0.174	1.19005	55658	20362	660	0.84029	68976	58431	438
0.175	1.19124	62166	12358	122	0.83945	70207	69207	358
0.176	1.19243	80586	50669	468	0.83861	79833	37074	003
0.177	1.19363	10931	27138	834	0.83777	97845	22993	869
0.178	1.19482	53212	34800	796	0.83694	24234	88768	073
0.179	1.19602	07441	67883	563	0.83610	58993	97035	511
0.180	1.19721	73631	21810	165	0.83527	02114	11272	021
0.181	1.19841	51792	93199	657	0.83443	53586	95789	549
0.182	1.19961	41938	79868	311	0.83360	13404	15735	309
0.183	1.20081	44080	80830	812	0.83276	81557	37090	951
0.184	1.20201	58230	96301	462	0.83193	58038	26671	728
0.185	1.20321	84401	27695	376	0.83110	42838	52125	659
0.186	1.20442	22603	77629	686	0.83027	35949	81932	701
0.187	1.20562	72850	49924	742	0.82944	37363	85403	915
0.188	1.20683	35153	49605	317	0.82861	47072	32680	634
0.189	1.20804	09524	82901	811	0.82778	65066	94733	637
0.190	1.20924	95976	57251	458	0.82695	91339	43362	318
0.191	1.21045	94520	81299	533	0.82613	25881	51193	854
0.192	1.21167	05169	64900	562	0.82530	68684	91682	387
0.193	1.21288	27935	19119	527	0.82448	19741	39108	186
0.194	1.21409	62829	56233	085	0.82365	79042	68576	832
0.195	1.21531	09864	89730	774	0.82283	46580	56018	384
0.196	1.21652	69053	34316	229	0.82201	22346	78186	562
0.197	1.21774	40407	05908	396	0.82119	06333	12657	919
0.198	1.21896	23938	21642	747	0.82036	98531	37831	021
0.199	1.22018	19658	99872	499	0.81954	98933	32925	626
0.200	1.22140	27581	60169	834	0.81873	07530	77981	859
		$\left[\begin{smallmatrix} (-7)1 \\ 6 \end{smallmatrix} \right]$					$\left[\begin{smallmatrix} (-7)1 \\ 6 \end{smallmatrix} \right]$	

Table 4.4

EXPONENTIAL FUNCTION

x	e^x				e^{-x}			
0.200	1.22140	27581	60169	834	0.81873	07530	77981	859
0.201	1.22262	47718	23327	112	0.81791	24315	53859	397
0.202	1.22384	80081	11358	099	0.81709	49279	42236	649
0.203	1.22507	24682	47499	185	0.81627	82414	25609	934
0.204	1.22629	81534	56210	607	0.81546	23711	87292	668
0.205	1.22752	50649	63177	678	0.81464	73164	11414	545
0.206	1.22875	32039	95312	005	0.81383	30762	82920	720
0.207	1.22998	25717	80752	723	0.81301	96499	87570	998
0.208	1.23121	31695	48867	721	0.81220	70367	11939	015
0.209	1.23244	49985	30254	869	0.81139	52356	43411	427
0.210	1.23367	80599	56743	251	0.81058	42459	70187	100
0.211	1.23491	23550	61394	396	0.80977	40668	81276	291
0.212	1.23614	78850	78503	512	0.80896	46975	66499	845
0.213	1.23738	46512	43600	719	0.80815	61372	16488	379
0.214	1.23862	26547	93452	285	0.80734	83850	22681	475
0.215	1.23986	18969	66061	862	0.80654	14401	77326	874
0.216	1.24110	23790	00671	728	0.80573	53018	73479	662
0.217	1.24234	41021	37764	020	0.80492	99693	05001	467
0.218	1.24358	70676	19061	978	0.80412	54416	66559	655
0.219	1.24483	12766	87531	187	0.80332	17181	53626	521
0.220	1.24607	67305	87380	820	0.80251	87979	62478	483
0.221	1.24732	34305	64064	879	0.80171	66802	90195	284
0.222	1.24857	13778	64283	447	0.80091	53643	34659	186
0.223	1.24982	05737	35983	926	0.80011	48492	94554	165
0.224	1.25107	10194	28362	294	0.79931	51343	69365	114
0.225	1.25232	27161	91864	345	0.79851	62187	59377	043
0.226	1.25357	56652	78186	948	0.79771	81016	65674	274
0.227	1.25482	98679	40279	295	0.79692	07822	90139	647
0.228	1.25608	53254	32344	151	0.79612	42598	35453	721
0.229	1.25734	20390	09839	113	0.79532	85335	05093	973
0.230	1.25860	00099	29477	863	0.79453	36025	03334	008
0.231	1.25985	92394	49231	426	0.79373	94660	35242	758
0.232	1.26111	97288	28329	426	0.79294	61233	06683	687
0.233	1.26238	14793	27261	349	0.79215	35735	24314	003
0.234	1.26364	44922	07777	797	0.79136	18158	95583	855
0.235	1.26490	87687	32891	756	0.79057	08496	28735	550
0.236	1.26617	43101	66879	857	0.78978	06739	32802	754
0.237	1.26744	11177	75283	640	0.78899	12880	17609	706
0.238	1.26870	91928	24910	818	0.78820	26910	93770	426
0.239	1.26997	85365	83836	547	0.78741	48823	72687	922
0.240	1.27124	91503	21404	692	0.78662	78610	66553	409
0.241	1.27252	10353	08229	095	0.78584	16263	88345	515
0.242	1.27379	41928	16194	849	0.78505	61775	51829	496
0.243	1.27506	86241	18459	570	0.78427	15137	71556	451
0.244	1.27634	43304	89454	665	0.78348	76342	62862	532
0.245	1.27762	13132	04886	611	0.78270	45382	41868	168
0.246	1.27889	95735	41738	230	0.78192	22249	25477	270
0.247	1.28017	91127	78269	966	0.78114	06935	31376	458
0.248	1.28145	99321	94021	162	0.78035	99432	78034	273
0.249	1.28274	20330	69811	341	0.77957	99733	84700	396
0.250	1.28402	54166	87741	484	0.77880	07830	71404	868
		$\left[\begin{matrix} (-7)2 \\ 6 \end{matrix} \right]$				$\left[\begin{matrix} (-7)1 \\ 6 \end{matrix} \right]$		

EXPONENTIAL FUNCTION

Table 4.4

x	e^x				e^{-x}			
0.250	1.28402	54166	87741	484	0.77880	07830	71404	868
0.251	1.28531	00843	31195	317	0.77802	23715	58957	312
0.252	1.28659	60372	84840	591	0.77724	47380	68946	150
0.253	1.28788	32768	34630	366	0.77646	78818	23737	828
0.254	1.28917	18042	67804	299	0.77569	18020	46476	034
0.255	1.29046	16208	72889	931	0.77491	64979	61080	928
0.256	1.29175	27279	39703	974	0.77414	19687	92248	360
0.257	1.29304	51267	59353	603	0.77336	82137	65449	096
0.258	1.29433	88186	24237	745	0.77259	52321	06928	045
0.259	1.29563	38048	28048	373	0.77182	30230	43703	483
0.260	1.29693	00866	65771	798	0.77105	15858	03566	284
0.261	1.29822	76654	33689	967	0.77028	09196	15079	142
0.262	1.29952	65424	29381	755	0.76951	10237	07575	806
0.263	1.30082	67189	51724	266	0.76874	18973	11160	303
0.264	1.30212	81963	00894	131	0.76797	35396	56706	173
0.265	1.30343	09757	78368	808	0.76720	59499	75855	698
0.266	1.30473	50586	86927	883	0.76643	91275	01019	133
0.267	1.30604	04463	30654	372	0.76567	30714	65373	938
0.268	1.30734	71400	14936	028	0.76490	77811	02864	015
0.269	1.30865	51410	46466	646	0.76414	32556	48198	937
0.270	1.30996	44507	33247	364	0.76337	94943	36853	186
0.271	1.31127	50703	84587	979	0.76261	64964	05065	386
0.272	1.31258	70013	11108	252	0.76185	42610	89837	543
0.273	1.31390	02448	24739	218	0.76109	27876	28934	278
0.274	1.31521	48022	38724	500	0.76033	20752	60882	066
0.275	1.31653	06748	67621	623	0.75957	21232	24968	476
0.276	1.31784	78640	27303	324	0.75881	29307	61241	409
0.277	1.31916	63710	34958	873	0.75805	44971	10508	337
0.278	1.32048	61972	09095	387	0.75729	68215	14335	547
0.279	1.32180	73438	69539	151	0.75653	99032	15047	380
0.280	1.32312	98123	37436	936	0.75578	37414	55725	472
0.281	1.32445	36039	35257	318	0.75502	83354	80208	002
0.282	1.32577	87199	86792	007	0.75427	36845	33088	932
0.283	1.32710	51618	17157	164	0.75351	97878	59717	250
0.284	1.32843	29307	52794	731	0.75276	66447	06196	222
0.285	1.32976	20281	21473	753	0.75201	42543	19382	630
0.286	1.33109	24552	52291	710	0.75126	26159	46886	026
0.287	1.33242	42134	75675	843	0.75051	17288	37067	974
0.288	1.33375	73041	23384	488	0.74976	15922	39041	301
0.289	1.33509	17285	28508	403	0.74901	22054	02669	348
0.290	1.33642	74880	25472	103	0.74826	35675	78565	215
0.291	1.33776	45839	50035	199	0.74751	56780	18091	016
0.292	1.33910	30176	39293	724	0.74676	85359	73357	128
0.293	1.34044	27904	31681	481	0.74602	21406	97221	444
0.294	1.34178	39036	66971	373	0.74527	64914	43288	626
0.295	1.34312	63586	86276	747	0.74453	15874	65909	357
0.296	1.34447	01568	32052	735	0.74378	74280	20179	599
0.297	1.34581	52994	48097	594	0.74304	40123	61939	843
0.298	1.34716	17878	79554	052	0.74230	13397	47774	369
0.299	1.34850	96234	72910	654	0.74155	94094	35010	502
0.300	1.34985	88075	76003	104	0.74081	82206	81717	866
		$\left[\begin{smallmatrix} (-7)2 \\ 6 \end{smallmatrix} \right]$				$\left[\begin{smallmatrix} (-7)1 \\ 6 \end{smallmatrix} \right]$		

Table 4.4

EXPONENTIAL FUNCTION

x	e^x				e^{-x}			
0.300	1.34985	88075	76003	104	0.74081	82206	81717	866
0.301	1.35120	93415	38015	618	0.74007	77727	46707	647
0.302	1.35256	12267	09482	272	0.73933	80648	89531	848
0.303	1.35391	44644	42288	348	0.73859	90963	70482	549
0.304	1.35526	90560	89671	692	0.73786	08664	50591	171
0.305	1.35662	50030	06224	066	0.73712	33743	91627	732
0.306	1.35798	23065	47892	497	0.73638	66194	56100	112
0.307	1.35934	09680	71980	642	0.73565	06009	07253	313
0.308	1.36070	09889	37150	137	0.73491	53180	09068	726
0.309	1.36206	23705	03421	961	0.73418	07700	26263	391
0.310	1.36342	51141	32177	794	0.73344	69562	24289	264
0.311	1.36478	92211	86161	378	0.73271	38758	69332	482
0.312	1.36615	46930	29479	880	0.73198	15282	28312	628
0.313	1.36752	15310	27605	258	0.73124	99125	68882	001
0.314	1.36888	97365	47375	624	0.73051	90281	59424	881
0.315	1.37025	93109	56996	611	0.72978	88742	69056	797
0.316	1.37163	02556	26042	743	0.72905	94501	67623	797
0.317	1.37300	25719	25458	804	0.72833	07551	25701	720
0.318	1.37437	62612	27561	208	0.72760	27884	14595	463
0.319	1.37575	13249	06039	370	0.72687	55493	06338	254
0.320	1.37712	77643	35957	085	0.72614	90370	73690	925
0.321	1.37850	55808	93753	895	0.72542	32509	90141	181
0.322	1.37988	47759	57246	476	0.72469	81903	29902	880
0.323	1.38126	53509	05630	003	0.72397	38543	67915	300
0.324	1.38264	73071	19479	542	0.72325	02423	79842	419
0.325	1.38403	06459	80751	421	0.72252	73536	42072	189
0.326	1.38541	53688	72784	617	0.72180	51874	31715	812
0.327	1.38680	14771	80302	136	0.72108	37430	26607	016
0.328	1.38818	89722	89412	403	0.72036	30197	05301	338
0.329	1.38957	78555	87610	642	0.71964	30167	47075	395
0.330	1.39096	81284	63780	266	0.71892	37334	31926	170
0.331	1.39235	97923	08194	268	0.71820	51690	40570	286
0.332	1.39375	28485	12516	609	0.71748	73228	54443	294
0.333	1.39514	72984	69803	608	0.71677	01941	55698	947
0.334	1.39654	31435	74505	339	0.71605	37822	27208	486
0.335	1.39794	03852	22467	023	0.71533	80863	52559	924
0.336	1.39933	90248	10930	424	0.71462	31058	16057	326
0.337	1.40073	90637	38535	249	0.71390	88399	02720	095
0.338	1.40214	05034	05320	540	0.71319	52878	98282	260
0.339	1.40354	33452	12726	081	0.71248	24490	89191	756
0.340	1.40494	75905	63593	797	0.71177	03227	62609	715
0.341	1.40635	32408	62169	155	0.71105	89082	06409	751
0.342	1.40776	02975	14102	572	0.71034	82047	09177	248
0.343	1.40916	87619	26450	817	0.70963	82115	60208	649
0.344	1.41057	86355	07678	418	0.70892	89280	49510	748
0.345	1.41198	99196	67659	075	0.70822	03534	67799	973
0.346	1.41340	26158	17677	066	0.70751	24871	06501	685
0.347	1.41481	67253	70428	658	0.70680	53282	57749	463
0.348	1.41623	22497	40023	522	0.70609	88762	14384	398
0.349	1.41764	91903	41986	146	0.70539	31302	69954	390
0.350	1.41906	75485	93257	248	0.70468	80897	18713	434
		$\left[\begin{smallmatrix} (-7)2 \\ 6 \end{smallmatrix} \right]$				$\left[\begin{smallmatrix} (-8)9 \\ 6 \end{smallmatrix} \right]$		

EXPONENTIAL FUNCTION

Table 4.4

x	e^x				e^{-x}			
0.350	1.41906	75485	93257	248	0.70468	80897	18713	434
0.351	1.42048	73259	12195	200	0.70398	37538	55620	921
0.352	1.42190	85237	18577	438	0.70328	01219	76340	929
0.353	1.42333	11434	33601	886	0.70257	71933	77241	521
0.354	1.42475	51864	79888	380	0.70187	49673	55394	037
0.355	1.42618	06542	81480	082	0.70117	34432	08572	398
0.356	1.42760	75482	63844	915	0.70047	26202	35252	399
0.357	1.42903	58698	53876	979	0.69977	24977	34611	008
0.358	1.43046	56204	79897	983	0.69907	30750	06525	666
0.359	1.43189	68015	71658	672	0.69837	43513	51573	587
0.360	1.43332	94145	60340	258	0.69767	63260	71031	057
0.361	1.43476	34608	78555	848	0.69697	89984	66872	738
0.362	1.43619	89419	60351	880	0.69628	23678	41770	967
0.363	1.43763	58592	41209	556	0.69558	64334	99095	062
0.364	1.43907	42141	58046	276	0.69489	11947	42910	621
0.365	1.44051	40081	49217	078	0.69419	66508	77978	831
0.366	1.44195	52426	54516	071	0.69350	28012	09755	768
0.367	1.44339	79191	15177	881	0.69280	96450	44391	707
0.368	1.44484	20389	73879	090	0.69211	71816	88730	425
0.369	1.44628	76036	74739	677	0.69142	54104	50308	508
0.370	1.44773	46146	63324	462	0.69073	43306	37354	660
0.371	1.44918	30733	86644	554	0.69004	39415	58789	010
0.372	1.45063	29812	93158	799	0.68935	42425	24222	423
0.373	1.45208	43398	32775	223	0.68866	52328	43955	806
0.374	1.45353	71504	56852	487	0.68797	69118	28979	422
0.375	1.45499	14146	18201	336	0.68728	92787	90972	199
0.376	1.45644	71337	71086	052	0.68660	23330	42301	040
0.377	1.45790	43093	71225	910	0.68591	60738	96020	141
0.378	1.45936	29428	75796	632	0.68523	05006	65870	297
0.379	1.46082	30357	43431	842	0.68454	56126	66278	222
0.380	1.46228	45894	34224	532	0.68386	14092	12355	858
0.381	1.46374	76054	09728	512	0.68317	78896	19899	696
0.382	1.46521	20851	32959	881	0.68249	50532	05390	084
0.383	1.46667	80300	68398	485	0.68181	28992	85990	553
0.384	1.46814	54416	81989	380	0.68113	14271	79547	125
0.385	1.46961	43214	41144	302	0.68045	06362	04587	638
0.386	1.47108	46708	14743	133	0.67977	05256	80321	060
0.387	1.47255	64912	73135	370	0.67909	10949	26636	810
0.388	1.47402	97842	88141	592	0.67841	23432	64104	077
0.389	1.47550	45513	33054	939	0.67773	42700	13971	142
0.390	1.47698	07938	82642	577	0.67705	68744	98164	700
0.391	1.47845	85134	13147	180	0.67638	01560	39289	177
0.392	1.47993	77114	02288	401	0.67570	41139	60626	058
0.393	1.48141	83893	29264	352	0.67502	87475	86133	209
0.394	1.48290	05486	74753	084	0.67435	40562	40444	198
0.395	1.48438	41909	20914	066	0.67368	00392	48867	624
0.396	1.48586	93175	51389	667	0.67300	66959	37386	438
0.397	1.48735	59300	51306	642	0.67233	40256	32657	274
0.398	1.48884	40299	07277	615	0.67166	20276	62009	771
0.399	1.49033	36186	07402	565	0.67099	07013	53445	901
0.400	1.49182	46976	41270	318	0.67032	00460	35639	301
		$\left[\begin{smallmatrix} (-7)2 \\ 6 \end{smallmatrix} \right]$					$\left[\begin{smallmatrix} (-8)9 \\ 6 \end{smallmatrix} \right]$	

Table 4.4

EXPONENTIAL FUNCTION

x	e^x				e^{-x}			
0.400	1.49182	46976	41270	318	0.67032	00460	35639	301
0.401	1.49331	72684	99960	030	0.66965	00610	37934	596
0.402	1.49481	13326	76042	686	0.66898	07456	90346	733
0.403	1.49630	68916	63582	585	0.66831	20993	23560	309
0.404	1.49780	39469	58138	840	0.66764	41212	68928	902
0.405	1.49930	25000	56766	870	0.66697	68108	58474	400
0.406	1.50080	25524	58019	898	0.66631	01674	24886	338
0.407	1.50230	41056	61950	452	0.66564	41903	01521	227
0.408	1.50380	71611	70111	860	0.66497	88788	22401	888
0.409	1.50531	17204	85559	754	0.66431	42323	22216	786
0.410	1.50681	77851	12853	578	0.66365	02501	36319	366
0.411	1.50832	53565	58058	082	0.66298	69316	00727	386
0.412	1.50983	44363	28744	838	0.66232	42760	52122	256
0.413	1.51134	50259	33993	742	0.66166	22828	27848	372
0.414	1.51285	71268	84394	526	0.66100	09512	65912	454
0.415	1.51437	07406	92048	265	0.66034	02807	04982	886
0.416	1.51588	58688	70568	894	0.65968	02704	84389	050
0.417	1.51740	25129	35084	718	0.65902	09199	44120	673
0.418	1.51892	06744	02239	927	0.65836	22284	24827	158
0.419	1.52044	03547	90196	115	0.65770	41952	67816	932
0.420	1.52196	15556	18633	796	0.65704	68198	15056	782
0.421	1.52348	42784	08753	926	0.65639	01014	09171	201
0.422	1.52500	85246	83279	422	0.65573	40393	93441	728
0.423	1.52653	42959	66456	685	0.65507	86331	11806	293
0.424	1.52806	15937	84057	126	0.65442	38819	08858	560
0.425	1.52959	04196	63378	690	0.65376	97851	29847	271
0.426	1.53112	07751	33247	382	0.65311	63421	20675	593
0.427	1.53265	26617	24018	802	0.65246	35522	27900	462
0.428	1.53418	60809	67579	666	0.65181	14147	98731	930
0.429	1.53572	10343	97349	347	0.65115	99291	81032	515
0.430	1.53725	75235	48281	402	0.65050	90947	23316	545
0.431	1.53879	55499	56865	110	0.64985	89107	74749	506
0.432	1.54033	51151	61127	008	0.64920	93766	85147	398
0.433	1.54187	62207	00632	428	0.64856	04918	04976	075
0.434	1.54341	88681	16487	038	0.64791	22554	85350	604
0.435	1.54496	30589	51338	384	0.64726	46670	78034	611
0.436	1.54650	87947	49377	427	0.64661	77259	35439	635
0.437	1.54805	60770	56340	096	0.64597	14314	10624	479
0.438	1.54960	49074	19508	826	0.64532	57828	57294	565
0.439	1.55115	52873	87714	108	0.64468	07796	29801	285
0.440	1.55270	72185	11336	042	0.64403	64210	83141	359
0.441	1.55426	07023	42305	879	0.64339	27065	72956	185
0.442	1.55581	57404	34107	580	0.64274	96354	55531	200
0.443	1.55737	23343	41779	367	0.64210	72070	87795	233
0.444	1.55893	04856	21915	277	0.64146	54208	27319	863
0.445	1.56049	01958	32666	719	0.64082	42760	32318	776
0.446	1.56205	14665	33744	035	0.64018	37720	61647	123
0.447	1.56361	42992	86418	055	0.63954	39082	74800	880
0.448	1.56517	86956	53521	663	0.63890	46840	31916	208
0.449	1.56674	46571	99451	356	0.63826	60986	93768	809
0.450	1.56831	21854	90168	811	0.63762	81516	21773	293
		$\left[\begin{smallmatrix} (-7) \\ 6 \end{smallmatrix} \right]$				$\left[\begin{smallmatrix} (-8) \\ 6 \end{smallmatrix} \right]$		

EXPONENTIAL FUNCTION

Table 4.4

x	e^x				e^{-x}			
0.450	1.56831	21854	90168	811	0.63762	81516	21773	293
0.451	1.56988	12820	93202	449	0.63699	08421	77982	535
0.452	1.57145	19485	77649	003	0.63635	41697	25087	037
0.453	1.57302	41865	14175	089	0.63571	81336	26414	293
0.454	1.57459	79974	75018	775	0.63508	27332	45928	153
0.455	1.57617	33830	33991	152	0.63444	79679	48228	182
0.456	1.57775	03447	66477	911	0.63381	38370	98549	030
0.457	1.57932	88842	49440	916	0.63318	03400	62759	794
0.458	1.58090	90030	61419	781	0.63254	74762	07363	387
0.459	1.58249	07027	82533	449	0.63191	52448	99495	898
0.460	1.58407	39849	94481	775	0.63128	36455	06925	969
0.461	1.58565	88512	80547	101	0.63065	26773	98054	154
0.462	1.58724	53032	25595	846	0.63002	23399	41912	291
0.463	1.58883	33424	16080	087	0.62939	26325	08162	872
0.464	1.59042	29704	40039	147	0.62876	35544	67098	411
0.465	1.59201	41888	87101	182	0.62813	51051	89640	814
0.466	1.59360	69993	48484	772	0.62750	72840	47340	750
0.467	1.59520	14034	17000	511	0.62688	00904	12377	027
0.468	1.59679	74026	87052	601	0.62625	35236	57555	956
0.469	1.59839	49987	54640	444	0.62562	75831	56310	730
0.470	1.59999	41932	17360	241	0.62500	22682	82700	796
0.471	1.60159	49876	74406	589	0.62437	75784	11411	229
0.472	1.60319	73837	26574	077	0.62375	35129	17752	104
0.473	1.60480	13829	76258	891	0.62313	00711	77657	876
0.474	1.60640	69870	27460	416	0.62250	72525	67686	754
0.475	1.60801	41974	85782	835	0.62188	50564	65020	075
0.476	1.60962	30159	58436	741	0.62126	34822	47461	685
0.477	1.61123	34440	54240	740	0.62064	25292	93437	314
0.478	1.61284	54833	83623	064	0.62002	21969	81993	957
0.479	1.61445	91355	58623	174	0.61940	24846	92799	250
0.480	1.61607	44021	92893	382	0.61878	33918	06140	853
0.481	1.61769	12849	01700	456	0.61816	49177	02925	827
0.482	1.61930	97853	01927	238	0.61754	70617	64680	018
0.483	1.62092	99050	12074	265	0.61692	98233	73547	436
0.484	1.62255	16456	52261	382	0.61631	32019	12289	639
0.485	1.62417	50088	44229	364	0.61569	71967	64285	113
0.486	1.62579	99962	11341	538	0.61508	18073	13528	659
0.487	1.62742	66093	78585	406	0.61446	70329	44630	776
0.488	1.62905	48499	72574	272	0.61385	28730	42817	043
0.489	1.63068	47196	21548	865	0.61323	93269	93927	508
0.490	1.63231	62199	55378	970	0.61262	63941	84416	069
0.491	1.63394	93526	05565	057	0.61201	40740	01349	867
0.492	1.63558	41192	05239	912	0.61140	23658	32408	668
0.493	1.63722	05213	89170	270	0.61079	12690	65884	251
0.494	1.63885	85607	93758	453	0.61018	07830	90679	799
0.495	1.64049	82390	57044	002	0.60957	09072	96309	287
0.496	1.64213	95578	18705	315	0.60896	16410	72896	868
0.497	1.64378	25187	20061	292	0.60835	29838	11176	269
0.498	1.64542	71234	04072	971	0.60774	49349	02490	178
0.499	1.64707	33735	15345	173	0.60713	74937	38789	634
0.500	1.64872	12707	00128	147	0.60653	06597	12633	424
		$\left[\begin{smallmatrix} (-7)2 \\ 6 \end{smallmatrix} \right]$				$\left[\begin{smallmatrix} (-8)8 \\ 6 \end{smallmatrix} \right]$		

Table 4.4

EXPONENTIAL FUNCTION

x	e^x				e^{-x}			
0.500	1.64872	12707	00128	147	0.60653	06597	12633	424
0.501	1.65037	08166	06319	214	0.60592	44322	17187	470
0.502	1.65202	20128	83464	418	0.60531	88106	46224	228
0.503	1.65367	48611	82760	175	0.60471	37943	94122	075
0.504	1.65532	93631	57054	920	0.60410	93828	55864	709
0.505	1.65698	55204	60850	766	0.60350	55754	27040	541
0.506	1.65864	33347	50305	156	0.60290	23715	03842	093
0.507	1.66030	28076	83232	516	0.60229	97704	83065	390
0.508	1.66196	39409	19105	918	0.60169	77717	62109	362
0.509	1.66362	67361	19058	736	0.60109	63747	38975	237
0.510	1.66529	11949	45886	308	0.60049	55788	12265	943
0.511	1.66695	73190	64047	601	0.59989	53833	81185	502
0.512	1.66862	51101	39666	871	0.59929	57878	45538	434
0.513	1.67029	45698	40535	333	0.59869	67916	05729	153
0.514	1.67196	56998	36112	826	0.59809	83940	62761	369
0.515	1.67363	85017	97529	486	0.59750	05946	18237	489
0.516	1.67531	29773	97587	414	0.59690	33926	74358	019
0.517	1.67698	91283	10762	348	0.59630	67876	33920	965
0.518	1.67866	69562	13205	342	0.59571	07789	00321	238
0.519	1.68034	64627	82744	439	0.59511	53658	77550	053
0.520	1.68202	76496	98886	347	0.59452	05479	70194	339
0.521	1.68371	05186	42818	123	0.59392	63245	83436	138
0.522	1.68539	50712	97408	851	0.59333	26951	23052	015
0.523	1.68708	13093	47211	326	0.59273	96589	95412	460
0.524	1.68876	92344	78463	738	0.59214	72156	07481	294
0.525	1.69045	88483	79091	359	0.59155	53643	66815	082
0.526	1.69215	01527	38708	232	0.59096	41046	81562	533
0.527	1.69384	31492	48618	855	0.59037	34359	60463	912
0.528	1.69553	78396	01819	881	0.58978	33576	12850	450
0.529	1.69723	42254	93001	803	0.58919	38690	48643	749
0.530	1.69893	23086	18550	654	0.58860	49696	78355	196
0.531	1.70063	20906	76549	702	0.58801	66589	13085	372
0.532	1.70233	35733	66781	146	0.58742	89361	64523	463
0.533	1.70403	67583	90727	817	0.58684	18008	44946	670
0.534	1.70574	16474	51574	883	0.58625	52523	67219	626
0.535	1.70744	82422	54211	545	0.58566	92901	44793	803
0.536	1.70915	65445	05232	748	0.58508	39135	91706	932
0.537	1.71086	65559	12940	887	0.58449	91221	22582	409
0.538	1.71257	82781	87347	510	0.58391	49151	52628	716
0.539	1.71429	17130	40175	036	0.58333	12920	97638	836
0.540	1.71600	68621	84858	460	0.58274	82523	73989	665
0.541	1.71772	37273	36547	069	0.58216	57953	98641	430
0.542	1.71944	23102	12106	159	0.58158	39205	89137	107
0.543	1.72116	26125	30118	747	0.58100	26273	63601	839
0.544	1.72288	46360	10887	296	0.58042	19151	40742	351
0.545	1.72460	83823	76435	429	0.57984	17833	39846	373
0.546	1.72633	38533	50509	656	0.57926	22313	80782	055
0.547	1.72806	10506	58581	095	0.57868	32586	83997	389
0.548	1.72978	99760	27847	197	0.57810	48646	70519	631
0.549	1.73152	06311	87233	477	0.57752	70487	61954	718
0.550	1.73325	30178	67395	237	0.57694	98103	80486	695
		$\left[\begin{smallmatrix} (-7)2 \\ 6 \end{smallmatrix} \right]$					$\left[\begin{smallmatrix} (-8)8 \\ 6 \end{smallmatrix} \right]$	

EXPONENTIAL FUNCTION

Table 4.4

x	e^x	e^{-x}
0.550	1.73325 30178 67395 237	0.57694 98103 80486 695
0.551	1.73498 71378 00719 302	0.57637 31489 48877 132
0.552	1.73672 29927 21325 750	0.57579 70638 90464 548
0.553	1.73846 05843 65069 647	0.57522 15546 29163 839
0.554	1.74019 99144 69542 780	0.57464 66205 89465 693
0.555	1.74194 09847 74075 399	0.57407 22611 96436 024
0.556	1.74368 37970 19737 955	0.57349 84758 75715 391
0.557	1.74542 83529 49342 837	0.57292 52640 53518 425
0.558	1.74717 46543 07446 121	0.57235 26251 56633 257
0.559	1.74892 27028 40349 310	0.57178 05586 12420 941
0.560	1.75067 25002 96101 083	0.57120 90638 48814 886
0.561	1.75242 40484 24499 041	0.57063 81402 94320 280
0.562	1.75417 73489 77091 459	0.57006 77873 78013 522
0.563	1.75593 24037 07179 036	0.56949 80045 29541 648
0.564	1.75768 92143 69816 648	0.56892 87911 79121 761
0.565	1.75944 77827 21815 104	0.56836 01467 57540 464
0.566	1.76120 81105 21742 902	0.56779 20706 96153 288
0.567	1.76297 01995 29927 989	0.56722 45624 26884 125
0.568	1.76473 40515 08459 520	0.56665 76213 82224 657
0.569	1.76649 96682 21189 621	0.56609 12469 95233 792
0.570	1.76826 70514 33735 152	0.56552 54386 99537 097
0.571	1.77003 62029 13479 471	0.56496 01959 29326 229
0.572	1.77180 71244 29574 208	0.56439 55181 19358 370
0.573	1.77357 98177 52941 024	0.56383 14047 04955 664
0.574	1.77535 42846 56273 392	0.56326 78551 22004 648
0.575	1.77713 05269 14038 362	0.56270 48688 06955 693
0.576	1.77890 85463 02478 341	0.56214 24451 96822 437
0.577	1.78068 83445 99612 864	0.56158 05837 29181 224
0.578	1.78246 99235 85240 377	0.56101 92838 42170 538
0.579	1.78425 32850 40940 016	0.56045 85449 74490 445
0.580	1.78603 84307 50073 382	0.55989 83665 65402 033
0.581	1.78782 53624 97786 336	0.55933 87480 54726 843
0.582	1.78961 40820 71010 772	0.55877 96888 82846 320
0.583	1.79140 45912 58466 414	0.55822 11884 90701 245
0.584	1.79319 68918 50662 599	0.55766 32463 19791 179
0.585	1.79499 09856 39900 067	0.55710 58618 12173 905
0.586	1.79678 68744 20272 757	0.55654 90344 10464 868
0.587	1.79858 45599 87669 600	0.55599 27635 57836 621
0.588	1.80038 40441 39776 313	0.55543 70486 98018 264
0.589	1.80218 53286 76077 198	0.55488 18892 75294 892
0.590	1.80398 84153 97856 940	0.55432 72847 34507 035
0.591	1.80579 33061 08202 413	0.55377 32345 21050 107
0.592	1.80760 00026 12004 477	0.55321 97380 80873 848
0.593	1.80940 85067 15959 787	0.55266 67948 60481 771
0.594	1.81121 88202 28572 596	0.55211 44043 06930 610
0.595	1.81303 09449 60156 569	0.55156 25658 67829 766
0.596	1.81484 48827 22836 588	0.55101 12789 91340 753
0.597	1.81666 06353 30550 566	0.55046 05431 26176 649
0.598	1.81847 82045 99051 264	0.54991 03577 21601 542
0.599	1.82029 75923 45908 101	0.54936 07222 27429 984
0.600	1.82211 88003 90508 975	0.54881 16360 94026 433
	$\left[\begin{smallmatrix} (-7)2 \\ 6 \end{smallmatrix} \right]$	$\left[\begin{smallmatrix} (-8)7 \\ 6 \end{smallmatrix} \right]$

Table 4.4

EXPONENTIAL FUNCTION

x	e^x				e^{-x}			
0.600	1.82211	88003	90508	975	0.54881	16360	94026	433
0.601	1.82394	18305	54062	083	0.54826	30987	72304	710
0.602	1.82576	66846	59597	740	0.54771	51097	13727	448
0.603	1.82759	33645	31970	203	0.54716	76683	70305	543
0.604	1.82942	18719	97859	499	0.54662	07741	94597	605
0.605	1.83125	22088	85773	244	0.54607	44266	39709	413
0.606	1.83308	43770	26048	479	0.54552	86251	59293	368
0.607	1.83491	83782	50853	497	0.54498	33692	07547	943
0.608	1.83675	42143	94189	676	0.54443	86582	39217	140
0.609	1.83859	18872	91893	312	0.54389	44917	09589	946
0.610	1.84043	13987	81637	455	0.54335	08690	74499	787
0.611	1.84227	27507	02933	750	0.54280	77897	90323	981
0.612	1.84411	59448	97134	270	0.54226	52533	13983	200
0.613	1.84596	09832	07433	364	0.54172	32591	02940	922
0.614	1.84780	78674	78869	496	0.54118	18066	15202	890
0.615	1.84965	65995	58327	090	0.54064	08953	09316	571
0.616	1.85150	71812	94538	381	0.54010	05246	44370	616
0.617	1.85335	96145	38085	258	0.53956	06940	79994	313
0.618	1.85521	39011	41401	120	0.53902	14030	76357	053
0.619	1.85707	00429	58772	725	0.53848	26510	94167	789
0.620	1.85892	80418	46342	044	0.53794	44375	94674	492
0.621	1.86078	78996	62108	121	0.53740	67620	39663	618
0.622	1.86264	96182	65928	925	0.53686	96238	91459	568
0.623	1.86451	31995	19523	215	0.53633	30226	12924	149
0.624	1.86637	86452	86472	402	0.53579	69576	67456	037
0.625	1.86824	59574	32222	407	0.53526	14285	18990	242
0.626	1.87011	51378	24085	530	0.53472	64346	31997	571
0.627	1.87198	61883	31242	321	0.53419	19754	71484	093
0.628	1.87385	91108	24743	442	0.53365	80505	02990	602
0.629	1.87573	39071	77511	543	0.53312	46591	92592	086
0.630	1.87761	05792	64343	132	0.53259	18010	06897	190
0.631	1.87948	91289	61910	454	0.53205	94754	13047	683
0.632	1.88136	95581	48763	361	0.53152	76818	78717	927
0.633	1.88325	18687	05331	198	0.53099	64198	72114	344
0.634	1.88513	60625	13924	678	0.53046	56888	61974	883
0.635	1.88702	21414	58737	766	0.52993	54883	17568	489
0.636	1.88891	01074	25849	565	0.52940	58177	08694	574
0.637	1.89079	99623	03226	199	0.52887	66765	05682	485
0.638	1.89269	17079	80722	703	0.52834	80641	79390	975
0.639	1.89458	53463	50084	912	0.52781	99802	01207	673
0.640	1.89648	08793	04951	353	0.52729	24240	43048	557
0.641	1.89837	83087	40855	140	0.52676	53951	77357	426
0.642	1.90027	76365	55225	865	0.52623	88930	77105	369
0.643	1.90217	88646	47391	502	0.52571	29172	15790	242
0.644	1.90408	19949	18580	301	0.52518	74670	67436	140
0.645	1.90598	70292	71922	692	0.52466	25421	06592	872
0.646	1.90789	39696	12453	188	0.52413	81418	08335	432
0.647	1.90980	28178	47112	287	0.52361	42656	48263	478
0.648	1.91171	35758	84748	384	0.52309	09131	02500	807
0.649	1.91362	62456	36119	674	0.52256	80836	47694	830
0.650	1.91554	08290	13896	070	0.52204	57767	61016	048
		$\left[\begin{matrix} (-7)2 \\ 6 \end{matrix} \right]$				$\left[\begin{matrix} (-8)7 \\ 6 \end{matrix} \right]$		

EXPONENTIAL FUNCTION

Table 4.4

x	e^x				e^{-x}			
0.650	1.91554	08290	13896	070	0.52204	57767	61016	048
0.651	1.91745	73279	32661	108	0.52152	39919	20157	530
0.652	1.91937	57443	08913	867	0.52100	27286	03334	394
0.653	1.92129	60800	61070	883	0.52048	19862	89283	277
0.654	1.92321	83371	09468	067	0.51996	17644	57261	823
0.655	1.92514	25173	76362	630	0.51944	20625	87048	156
0.656	1.92706	86227	85934	997	0.51892	28801	58940	364
0.657	1.92899	66552	64290	740	0.51840	42166	53755	974
0.658	1.93092	66167	39462	496	0.51788	60715	52831	438
0.659	1.93285	85091	41411	902	0.51736	84443	38021	612
0.660	1.93479	23344	02031	522	0.51685	13344	91699	238
0.661	1.93672	80944	55146	776	0.51633	47414	96754	426
0.662	1.93866	57912	36517	879	0.51581	86648	36594	140
0.663	1.94060	54266	83841	774	0.51530	31039	95141	674
0.664	1.94254	70027	36754	070	0.51478	80584	56836	146
0.665	1.94449	05213	36830	982	0.51427	35277	06631	974
0.666	1.94643	59844	27591	272	0.51375	95112	29998	365
0.667	1.94838	33939	54498	192	0.51324	60085	12918	798
0.668	1.95033	27518	64961	432	0.51273	30190	41890	516
0.669	1.95228	40601	08339	065	0.51222	05423	03924	002
0.670	1.95423	73206	35939	496	0.51170	85777	86542	478
0.671	1.95619	25354	01023	417	0.51119	71249	77781	383
0.672	1.95814	97063	58805	754	0.51068	61833	66187	865
0.673	1.96010	88354	66457	630	0.51017	57524	40820	271
0.674	1.96206	99246	83108	314	0.50966	58316	91247	632
0.675	1.96403	29759	69847	187	0.50915	64206	07549	157
0.676	1.96599	79912	89725	700	0.50864	75186	80313	718
0.677	1.96796	49726	07759	335	0.50813	91254	00639	348
0.678	1.96993	39218	90929	575	0.50763	12402	60132	723
0.679	1.97190	48411	08185	868	0.50712	38627	50908	661
0.680	1.97387	77322	30447	594	0.50661	69923	65589	610
0.681	1.97585	25972	30606	040	0.50611	06285	97305	142
0.682	1.97782	94380	83526	371	0.50560	47709	39691	448
0.683	1.97980	82567	66049	605	0.50509	94188	86890	827
0.684	1.98178	90552	56994	589	0.50459	45719	33551	185
0.685	1.98377	18355	37159	979	0.50409	02295	74825	526
0.686	1.98575	65995	89326	220	0.50358	63913	06371	449
0.687	1.98774	33493	98257	531	0.50308	30566	24350	644
0.688	1.98973	20869	50703	885	0.50258	22250	25428	387
0.689	1.99172	28142	35403	001	0.50207	3960	06773	037
0.690	1.99371	55332	43082	329	0.50157	60690	66055	534
0.691	1.99571	02459	66461	043	0.50107	47437	01448	895
0.692	1.99770	69544	00252	033	0.50057	39194	11627	713
0.693	1.99970	56605	41163	899	0.50007	35956	95767	658
0.694	2.00170	63663	87902	948	0.49957	37720	53544	971
0.695	2.00370	90739	41175	193	0.49907	44479	85135	969
0.696	2.00571	37852	03688	356	0.49857	56229	91216	541
0.697	2.00772	05021	80153	865	0.49807	72965	72961	653
0.698	2.00972	92268	77288	865	0.49757	94682	32044	844
0.699	2.01173	99613	03818	219	0.49708	21374	70637	732
0.700	2.01375	27074	70476	522	0.49658	53037	91409	515
		$\left[\begin{smallmatrix} (-7)2 \\ 6 \end{smallmatrix} \right]$					$\left[\begin{smallmatrix} (-8)6 \\ 6 \end{smallmatrix} \right]$	

Table 4.4

EXPONENTIAL FUNCTION

x	e^x				e^{-x}			
0.700	2.01375	27074	70476	522	0.49658	53037	91409	515
0.701	2.01576	74673	90010	108	0.49608	89666	97526	471
0.702	2.01778	42430	77179	065	0.49559	31256	92651	465
0.703	2.01980	30365	48759	247	0.49509	77802	80943	451
0.704	2.02182	38498	23544	296	0.49460	29299	67056	976
0.705	2.02384	66849	22347	653	0.49410	85742	56141	685
0.706	2.02587	15438	68004	586	0.49361	47126	53841	826
0.707	2.02789	84286	85374	210	0.49312	13446	66295	756
0.708	2.02992	73414	01341	511	0.49262	84698	00135	445
0.709	2.03195	82840	44819	374	0.49213	60875	62485	987
0.710	2.03399	12586	46750	612	0.49164	41974	60965	102
0.711	2.03602	62672	40109	996	0.49115	27990	03682	649
0.712	2.03806	33118	59906	288	0.49066	18916	99240	129
0.713	2.04010	23945	43184	280	0.49017	14750	56730	197
0.714	2.04214	35173	29026	822	0.48968	15485	85736	169
0.715	2.04418	66822	58556	873	0.48919	21117	96331	534
0.716	2.04623	18913	74939	531	0.48870	31641	99079	460
0.717	2.04827	91467	23384	083	0.48821	47053	05032	312
0.718	2.05032	84503	51146	049	0.48772	67346	25731	153
0.719	2.05237	98043	07529	226	0.48723	92516	73205	263
0.720	2.05443	32106	43887	743	0.48675	22559	59971	650
0.721	2.05648	86714	13628	106	0.48626	57469	99034	560
0.722	2.05854	61886	72211	257	0.48577	97243	03884	990
0.723	2.06060	57644	77154	626	0.48529	41873	88500	207
0.724	2.06266	74008	88034	189	0.48480	91357	67343	253
0.725	2.06473	10999	66486	529	0.48432	45689	55362	467
0.726	2.06679	68637	76210	896	0.48384	04864	67990	997
0.727	2.06886	46943	82971	273	0.48335	68878	21146	315
0.728	2.07093	45938	54598	438	0.48287	37725	31229	734
0.729	2.07300	65642	60992	036	0.48239	11401	15125	923
0.730	2.07508	06076	74122	645	0.48190	89900	90202	427
0.731	2.07715	67261	68033	852	0.48142	73219	74309	180
0.732	2.07923	49218	18844	323	0.48094	61352	85778	027
0.733	2.08131	51967	04749	882	0.48046	54295	43422	238
0.734	2.08339	75529	06025	589	0.47998	52042	66536	031
0.735	2.08548	19925	05027	819	0.47950	54589	74894	090
0.736	2.08756	85175	86196	344	0.47902	61931	88751	082
0.737	2.08965	71302	36056	419	0.47854	74064	28841	182
0.738	2.09174	78325	43220	868	0.47806	90982	16377	589
0.739	2.09384	06265	98392	173	0.47759	12680	73052	052
0.740	2.09593	55144	94364	563	0.47711	39155	21034	388
0.741	2.09803	24983	26026	109	0.47663	70400	82972	004
0.742	2.10013	15801	90360	816	0.47616	06412	81989	423
0.743	2.10223	27621	86450	725	0.47568	47186	41687	803
0.744	2.10433	60464	15478	007	0.47520	92716	86144	466
0.745	2.10644	14349	80727	065	0.47473	42999	39912	416
0.746	2.10854	89299	87586	641	0.47425	98029	28019	867
0.747	2.11065	85335	43551	917	0.47378	57801	75969	767
0.748	2.11277	02477	58226	625	0.47331	22312	09739	326
0.749	2.11488	40747	43325	155	0.47283	91555	55779	537
0.750	2.11700	00166	12674	669	0.47236	65527	41014	707
		$\left[\begin{smallmatrix} (-7)3 \\ 6 \end{smallmatrix} \right]$				$\left[\begin{smallmatrix} (-8)6 \\ 6 \end{smallmatrix} \right]$		

EXPONENTIAL FUNCTION

Table 4.4

x	e^x				e^{-x}			
0.750	2.11700	00166	12674	669	0.47236	65527	41014	707
0.751	2.11911	80754	82217	212	0.47189	44222	92841	982
0.752	2.12123	82534	70011	830	0.47142	27637	39130	875
0.753	2.12336	05526	96236	688	0.47095	15766	08222	791
0.754	2.12548	49752	83191	190	0.47048	08604	28930	562
0.755	2.12761	15233	55298	098	0.47001	06147	30537	969
0.756	2.12974	01990	39105	663	0.46954	08390	42799	274
0.757	2.13187	10044	63289	745	0.46907	15328	95938	749
0.758	2.13400	39417	58655	946	0.46860	26958	20650	211
0.759	2.13613	90130	58141	739	0.46813	43273	48096	543
0.760	2.13827	62204	96818	602	0.46766	64270	09909	234
0.761	2.14041	55662	11894	152	0.46719	89943	38187	907
0.762	2.14255	70523	42714	282	0.46673	20288	65499	852
0.763	2.14470	06810	30765	301	0.46626	55301	24879	557
0.764	2.14684	64544	19676	075	0.46579	94976	49828	242
0.765	2.14899	43746	55220	173	0.46533	39309	74313	393
0.766	2.15114	44438	85318	010	0.46486	88296	32768	297
0.767	2.15329	66642	60038	993	0.46440	41931	60091	573
0.768	2.15545	10379	31603	678	0.46394	00210	91646	708
0.769	2.15760	75670	54385	916	0.46347	63129	63261	598
0.770	2.15976	62537	84915	008	0.46301	30683	11228	073
0.771	2.16192	71002	81877	866	0.46255	02866	72301	444
0.772	2.16409	01087	06121	167	0.46208	79675	83700	034
0.773	2.16625	52812	20653	514	0.46162	61105	83104	714
0.774	2.16842	26199	90647	604	0.46116	47152	08658	446
0.775	2.17059	21271	83442	386	0.46070	37809	98965	818
0.776	2.17276	38049	68545	234	0.46024	33074	93092	580
0.777	2.17493	76555	17634	114	0.45978	32942	30565	189
0.778	2.17711	36810	04559	757	0.45932	37407	51370	344
0.779	2.17929	18836	05347	830	0.45886	46465	95954	527
0.780	2.18147	22654	98201	117	0.45840	60113	05223	545
0.781	2.18365	48288	63501	691	0.45794	78344	20542	069
0.782	2.18583	95758	83813	099	0.45749	01154	83733	175
0.783	2.18802	65087	43882	545	0.45703	28540	37077	890
0.784	2.19021	56296	30643	070	0.45657	60496	23314	727
0.785	2.19240	69407	33215	744	0.45611	97017	85639	236
0.786	2.19460	04442	42911	852	0.45566	38100	67703	540
0.787	2.19679	61423	53235	086	0.45520	83740	13615	885
0.788	2.19899	40372	59883	740	0.45475	33931	67940	176
0.789	2.20119	41311	60752	903	0.45429	88670	75695	532
0.790	2.20339	64262	55936	659	0.45384	47952	82355	822
0.791	2.20560	09247	47730	288	0.45339	11773	33849	215
0.792	2.20780	76288	40632	465	0.45293	80127	76557	724
0.793	2.21001	65407	41347	466	0.45248	53011	57316	754
0.794	2.21222	76626	58787	377	0.45203	30420	23414	649
0.795	2.21444	09968	04074	299	0.45158	12349	22592	237
0.796	2.21665	65453	90542	561	0.45112	98794	03042	379
0.797	2.21887	43106	33740	936	0.45067	89750	13409	518
0.798	2.22109	42947	51434	850	0.45022	85213	02789	227
0.799	2.22331	64999	63608	607	0.44977	85178	20727	758
0.800	2.22554	09284	92467	605	0.44932	89641	17221	591
			$\left[\begin{smallmatrix} (-7)3 \\ 6 \end{smallmatrix} \right]$				$\left[\begin{smallmatrix} (-8)6 \\ 6 \end{smallmatrix} \right]$	

Table 4.4

EXPONENTIAL FUNCTION

x	e^x	e^{-x}
0.800	2.22554 09284 92467 605	0.44932 89641 17221 591
0.801	2.22776 75825 62440 556	0.44887 98597 42716 986
0.802	2.22999 64644 00181 717	0.44843 12042 48109 530
0.803	2.23222 75762 34573 111	0.44798 29971 84743 691
0.804	2.23446 09202 96726 759	0.44753 52381 04412 369
0.805	2.23669 64988 19986 909	0.44708 79265 59356 447
0.806	2.23893 43140 39932 270	0.44664 10621 02264 340
0.807	2.24117 43681 94378 249	0.44619 46442 86271 556
0.808	2.24341 66635 23379 186	0.44574 86726 64960 242
0.809	2.24566 12022 69230 599	0.44530 31467 92358 738
0.810	2.24790 79866 76471 419	0.44485 80662 22941 134
0.811	2.25015 70189 91886 242	0.44441 34305 11626 826
0.812	2.25240 83014 64507 569	0.44396 92392 13780 063
0.813	2.25466 18363 45618 061	0.44352 54918 85209 512
0.814	2.25691 76258 88752 788	0.44308 21880 82167 806
0.815	2.25917 56723 49701 480	0.44263 93273 61351 106
0.816	2.26143 59779 86510 786	0.44219 69092 79898 654
0.817	2.26369 85450 59486 532	0.44175 49333 95392 332
0.818	2.26596 33758 31195 979	0.44131 33992 65856 218
0.819	2.26823 04725 66470 087	0.44087 23064 49756 146
0.820	2.27049 98375 32405 781	0.44043 16545 05999 263
0.821	2.27277 14729 98368 215	0.43999 14429 93933 588
0.822	2.27504 53812 35993 046	0.43955 16714 73347 574
0.823	2.27732 15645 19188 700	0.43911 23395 04469 662
0.824	2.27960 00251 24138 650	0.43867 34466 47967 847
0.825	2.28188 07653 29303 690	0.43823 49924 64949 237
0.826	2.28416 37874 15424 217	0.43779 69765 16959 611
0.827	2.28644 90936 65522 506	0.43735 93983 65982 985
0.828	2.28873 66863 64904 998	0.43692 22575 74441 171
0.829	2.29102 65678 01164 583	0.43648 55537 05193 342
0.830	2.29331 87402 64182 888	0.43604 92863 21535 593
0.831	2.29561 32060 46132 567	0.43561 34549 87200 502
0.832	2.29790 99674 41479 593	0.43517 80592 66356 699
0.833	2.30020 90267 46985 553	0.43474 30987 23608 428
0.834	2.30251 03862 61709 945	0.43430 85729 23995 109
0.835	2.30481 40482 87012 474	0.43387 44814 32990 906
0.836	2.30712 00151 26555 358	0.43344 08238 16504 293
0.837	2.30942 82890 86305 628	0.43300 75996 40877 616
0.838	2.31173 88724 74537 437	0.43257 48084 72886 664
0.839	2.31405 17676 01834 366	0.43214 24498 79740 233
0.840	2.31636 69767 81091 734	0.43171 05234 29079 693
0.841	2.31868 45023 27518 913	0.43127 90286 88978 558
0.842	2.32100 43465 58641 644	0.43084 79652 27942 052
0.843	2.32332 65117 94304 351	0.43041 73326 14906 679
0.844	2.32565 10003 56672 462	0.42998 71304 19239 788
0.845	2.32797 78145 70234 734	0.42955 73582 10739 148
0.846	2.33030 69567 61805 575	0.42912 80155 59632 516
0.847	2.33263 84292 60527 370	0.42869 91020 36577 204
0.848	2.33497 22343 97872 812	0.42827 06172 12659 654
0.849	2.33730 83745 07647 233	0.42784 25606 59395 005
0.850	2.33964 68519 25990 937	0.42741 49319 48726 670
	$\left[\begin{smallmatrix} (-7)3 \\ 6 \end{smallmatrix} \right]$	$\left[\begin{smallmatrix} (-8)6 \\ 6 \end{smallmatrix} \right]$

EXPONENTIAL FUNCTION

Table 4.4

x	e^x	e^{-x}
0.850	2.33964 68519 25990 937	0.42741 49319 48726 670
0.851	2.34198 76689 91381 538	0.42698 77306 53025 901
0.852	2.34433 08280 44636 295	0.42656 09563 45091 367
0.853	2.34667 63314 28914 459	0.42613 46085 98148 726
0.854	2.34902 41814 89719 607	0.42570 86869 85850 193
0.855	2.35137 43805 74901 997	0.42528 31910 82274 123
0.856	2.35372 69310 34660 911	0.42485 81204 61924 574
0.857	2.35608 18352 21547 002	0.42443 34746 99730 893
0.858	2.35843 90954 90464 656	0.42400 92533 71047 281
0.859	2.36079 87141 98674 336	0.42358 54560 51652 373
0.860	2.36316 06937 05794 948	0.42316 20823 17748 817
0.861	2.36552 50363 73806 196	0.42273 91317 45962 841
0.862	2.36789 17445 67050 946	0.42231 66039 13343 840
0.863	2.37026 08206 52237 586	0.42189 44983 97363 945
0.864	2.37263 22669 98442 400	0.42147 28147 75917 606
0.865	2.37500 60859 77111 933	0.42105 15526 27321 165
0.866	2.37738 22799 62065 359	0.42063 07115 30312 439
0.867	2.37976 08513 29496 863	0.42021 02910 64050 296
0.868	2.38214 18024 57978 010	0.41979 02908 08114 234
0.869	2.38452 51357 28460 126	0.41937 07103 42503 963
0.870	2.38691 08535 24276 682	0.41895 15492 47638 983
0.871	2.38929 89582 31145 671	0.41853 28071 04358 162
0.872	2.39168 94522 37171 999	0.41811 44834 93919 324
0.873	2.39408 23379 32849 872	0.41769 65779 97998 822
0.874	2.39647 76177 11065 184	0.41727 90901 98691 126
0.875	2.39887 52939 67097 915	0.41686 20196 78508 403
0.876	2.40127 53690 98624 518	0.41644 53660 20380 096
0.877	2.40367 78455 05720 327	0.41602 91288 07652 513
0.878	2.40608 27255 90861 947	0.41561 33076 24088 408
0.879	2.40849 00117 58929 666	0.41519 79020 53866 560
0.880	2.41089 97064 17209 851	0.41478 29116 81581 367
0.881	2.41331 18119 75397 361	0.41436 83360 92242 420
0.882	2.41572 63308 45597 956	0.41395 41748 71274 097
0.883	2.41814 32654 42330 708	0.41354 04276 04515 140
0.884	2.42056 26181 82530 413	0.41312 70938 78218 250
0.885	2.42298 43914 85550 015	0.41271 41732 79049 666
0.886	2.42540 85877 73163 018	0.41230 16653 94088 753
0.887	2.42783 52094 69565 911	0.41188 95698 10827 593
0.888	2.43026 42590 01380 593	0.41147 78861 17170 568
0.889	2.43269 57387 97656 799	0.41106 66139 01433 949
0.890	2.43512 96512 89874 527	0.41065 57527 52345 488
0.891	2.43756 59989 11946 472	0.41024 53022 59044 001
0.892	2.44000 47841 00220 460	0.40983 52620 11078 959
0.893	2.44244 60092 93481 882	0.40942 56315 98410 082
0.894	2.44488 96769 32956 134	0.40901 64106 11406 922
0.895	2.44733 57894 62311 060	0.40860 75986 40848 458
0.896	2.44978 43493 27659 394	0.40819 91952 77922 685
0.897	2.45223 53589 77561 203	0.40779 12001 14226 207
0.898	2.45468 88208 63026 343	0.40738 36127 41763 826
0.899	2.45714 47374 37516 904	0.40697 64327 52948 135
0.900	2.45960 31111 56949 664	0.40656 96597 40599 112
	$\left[\begin{matrix} (-7)^3 \\ 6 \end{matrix} \right]$	$\left[\begin{matrix} (-8)^5 \\ 6 \end{matrix} \right]$

Table 4.4

EXPONENTIAL FUNCTION

x	e^x				e^{-x}			
0.900	2.45960	31111	56949	664	0.40656	96597	40599	112
0.901	2.46206	39444	79698	548	0.40616	32932	97943	710
0.902	2.46452	72398	66597	083	0.40575	73330	18615	453
0.903	2.46699	29997	80940	863	0.40535	17784	96654	028
0.904	2.46946	12266	88490	006	0.40494	66293	26504	879
0.905	2.47193	19230	57471	626	0.40454	18851	03018	802
0.906	2.47440	50913	58582	298	0.40413	75454	21451	540
0.907	2.47688	07340	64990	529	0.40373	36098	77463	377
0.908	2.47935	88536	52339	232	0.40333	00780	67118	736
0.909	2.48183	94525	98748	200	0.40292	69495	86885	773
0.910	2.48432	25333	84816	587	0.40252	42240	33635	975
0.911	2.48680	80984	93625	386	0.40212	19010	04643	753
0.912	2.48929	61504	10739	912	0.40171	99800	97586	047
0.913	2.49178	66916	24212	291	0.40131	84609	10541	915
0.914	2.49427	97246	24583	942	0.40091	73430	41992	136
0.915	2.49677	52519	04888	075	0.40051	66260	90818	809
0.916	2.49927	32759	60652	177	0.40011	63096	56304	950
0.917	2.50177	37992	89900	513	0.39971	63933	38134	089
0.918	2.50427	68243	93156	620	0.39931	68767	36389	877
0.919	2.50678	23537	73445	810	0.39891	77594	51555	677
0.920	2.50929	03899	36297	671	0.39851	90410	84514	173
0.921	2.51180	09353	89748	577	0.39812	07212	36546	962
0.922	2.51431	39926	44344	189	0.39772	27995	09334	165
0.923	2.51682	95642	13141	971	0.39732	52755	04954	021
0.924	2.51934	76526	11713	703	0.39692	81488	25882	492
0.925	2.52186	82603	58147	991	0.39653	14190	74992	866
0.926	2.52439	13899	73052	794	0.39613	50858	55555	360
0.927	2.52691	70439	79557	936	0.39573	91487	71236	720
0.928	2.52944	52249	03317	633	0.39534	36074	26099	830
0.929	2.53197	59352	72513	022	0.39494	84614	24603	311
0.930	2.53450	91776	17854	680	0.39455	37103	71601	130
0.931	2.53704	49544	72585	166	0.39415	93538	72342	199
0.932	2.53958	32683	72481	544	0.39376	53915	32469	987
0.933	2.54212	41218	55857	927	0.39337	18229	58022	122
0.934	2.54466	75174	63568	010	0.39297	86477	55429	996
0.935	2.54721	34577	39007	611	0.39258	58655	31518	373
0.936	2.54976	19452	28117	220	0.39219	34758	93504	997
0.937	2.55231	29824	79384	537	0.39180	14784	49000	198
0.938	2.55486	65720	43847	026	0.39140	98728	06006	497
0.939	2.55742	27164	75094	464	0.39101	86585	72918	221
0.940	2.55998	14183	29271	496	0.39062	78353	58521	102
0.941	2.56254	26801	65080	189	0.39023	74027	71991	894
0.942	2.56510	65045	43782	593	0.38984	73604	22897	977
0.943	2.56767	28940	29203	299	0.38945	77079	21196	971
0.944	2.57024	18511	87732	007	0.38906	84448	77236	341
0.945	2.57281	33785	88326	089	0.38867	95709	01753	010
0.946	2.57538	74788	02513	161	0.38829	10856	05872	971
0.947	2.57796	41544	04393	651	0.38790	29886	01110	896
0.948	2.58054	34079	70643	376	0.38751	52794	99369	747
0.949	2.58312	52420	80516	117	0.38712	79579	12940	390
0.950	2.58570	96593	15846	199	0.38674	10234	54501	207
		$\left[\begin{smallmatrix} (-7)3 \\ 6 \end{smallmatrix} \right]$					$\left[\begin{smallmatrix} (-8)5 \\ 6 \end{smallmatrix} \right]$	

EXPONENTIAL FUNCTION

Table 4.4

x	e^x				e^{-x}			
0.950	2.58570	96593	15846	199	0.38674	10234	54501	207
0.951	2.58829	66622	61051	072	0.38635	44757	37117	707
0.952	2.59088	62535	03133	898	0.38596	83143	74242	140
0.953	2.59347	84356	31686	135	0.38558	25389	79713	111
0.954	2.59607	32112	38890	126	0.38519	71491	67755	194
0.955	2.59867	05829	19521	695	0.38481	21445	52978	545
0.956	2.60127	05532	70952	740	0.38442	75247	50378	516
0.957	2.60387	31248	93153	828	0.38404	32893	75335	273
0.958	2.60647	83003	88696	799	0.38365	94380	43613	409
0.959	2.60908	60823	62757	366	0.38327	59703	71361	560
0.960	2.61169	64734	23117	718	0.38289	28859	75112	023
0.961	2.61430	94761	80169	136	0.38251	01844	71780	368
0.962	2.61692	50932	46914	592	0.38212	78654	78665	061
0.963	2.61954	33272	38971	373	0.38174	59286	13447	076
0.964	2.62216	41807	74573	688	0.38136	43734	94189	517
0.965	2.62478	76564	74575	291	0.38098	31997	39337	233
0.966	2.62741	37569	62452	101	0.38060	24069	67716	437
0.967	2.63004	24848	64304	825	0.38022	19947	98534	325
0.968	2.63267	38428	08861	583	0.37984	19628	51378	697
0.969	2.63530	78334	27480	539	0.37946	23107	46217	574
0.970	2.63794	44593	54152	532	0.37908	30381	03398	818
0.971	2.64058	37232	25503	708	0.37870	41445	43649	757
0.972	2.64322	56276	80798	158	0.37832	56296	88076	798
0.973	2.64587	01753	61940	558	0.37794	74931	58165	054
0.974	2.64851	73689	13478	808	0.37756	97345	75777	964
0.975	2.65116	72109	82606	682	0.37719	23535	63156	913
0.976	2.65381	97042	19166	470	0.37681	53497	42920	859
0.977	2.65647	48512	75651	628	0.37643	87227	38065	949
0.978	2.65913	26548	07209	434	0.37606	24721	71965	147
0.979	2.66179	31174	71643	642	0.37568	65976	68367	855
0.980	2.66445	62419	29417	138	0.37531	10988	51399	539
0.981	2.66712	20308	43654	602	0.37493	59753	45561	350
0.982	2.66979	04868	80145	169	0.37456	12267	75729	751
0.983	2.67246	16127	07345	099	0.37418	68527	67156	142
0.984	2.67513	54109	96380	441	0.37381	28529	45466	482
0.985	2.67781	18844	21049	708	0.37343	92269	36660	918
0.986	2.68049	10356	57826	547	0.37306	59743	67113	412
0.987	2.68317	28673	85862	418	0.37269	30948	63571	361
0.988	2.68585	73822	86989	272	0.37232	05880	53155	231
0.989	2.68854	45830	45722	235	0.37194	84535	63358	181
0.990	2.69123	44723	49262	289	0.37157	66910	22045	691
0.991	2.69392	70528	87498	962	0.37120	53000	57455	187
0.992	2.69662	23273	53013	016	0.37083	42802	98195	674
0.993	2.69932	02984	41079	142	0.37046	36313	73247	362
0.994	2.70202	09688	49668	652	0.37009	33529	11961	296
0.995	2.70472	43412	79452	181	0.36972	34445	44058	983
0.996	2.70743	04184	33802	382	0.36935	39058	99632	024
0.997	2.71013	92030	18796	637	0.36898	47366	09141	744
0.998	2.71285	06977	43219	755	0.36861	59363	03418	822
0.999	2.71556	49053	18566	687	0.36824	75046	13662	921
1.000	2.71828	18284	59045	235	0.36787	94411	71442	322
		$\left[\begin{smallmatrix} (-7)3 \\ 6 \end{smallmatrix} \right]$				$\left[\begin{smallmatrix} (-8)5 \\ 6 \end{smallmatrix} \right]$		

Table 4.4

EXPONENTIAL FUNCTION

x	e^x			e^{-x}			
0.0	1.00000	00000	00000	1.00000	00000	00000	00000
0.1	1.10517	09180	75648	0.90483	74180	35959	57316
0.2	1.22140	27581	60170	0.81873	07530	77981	85867
0.3	1.34985	88075	76003	0.74081	82206	81717	86607
0.4	1.49182	46976	41270	0.67032	00460	35639	30074
0.5	1.64872	12707	00128	0.60653	06597	12633	42360
0.6	1.82211	88003	90509	0.54881	16360	94026	43263
0.7	2.01375	27074	70477	0.49658	53037	91409	51470
0.8	2.22554	09284	92468	0.44932	89641	17221	59143
0.9	2.45960	31111	56950	0.40656	96597	40599	11188
1.0	2.71828	18284	59045	0.36787	94411	71442	32160
1.1	3.00416	60239	46433	0.33287	10836	98079	55329
1.2	3.32011	69227	36547	0.30119	42119	12202	09664
1.3	3.66929	66676	19244	0.27253	17930	34012	60312
1.4	4.05519	99668	44675	0.24659	69639	41606	47694
1.5	4.48168	90703	38065	0.22313	01601	48429	82893
1.6	4.95303	24243	95115	0.20189	65179	94655	40849
1.7	5.47394	73917	27200	0.18268	35240	52734	65022
1.8	6.04964	74644	12946	0.16529	88882	21586	53830
1.9	6.68589	44422	79269	0.14956	86192	22635	05264
2.0	7.38905	60989	30650	0.13533	52832	36612	69189
2.1	8.16616	99125	67650	0.12245	64282	52981	91022
2.2	9.02501	34994	34121	0.11080	31583	62333	88333
2.3	9.97418	24548	14721	0.10025	88437	22803	73373
2.4	11.02317	63806	41602	0.09071	79532	89412	50338
2.5	12.18249	39607	03473	0.08208	49986	23898	79517
2.6	13.46373	80350	01690	0.07427	35782	14333	88043
2.7	14.87973	17248	72834	0.06720	55127	39749	76513
2.8	16.44464	67710	97050	0.06081	00626	25217	96500
2.9	18.17414	53694	43061	0.05502	32200	56407	22903
3.0	20.08553	69231	87668	0.04978	70683	67863	94298
3.1	22.19795	12814	41633	0.04504	92023	93557	80607
3.2	24.53253	01971	09349	0.04076	22039	78366	21517
3.3	27.11263	89206	57887	0.03688	31674	01240	00545
3.4	29.96410	00473	97013	0.03337	32699	60326	07948
3.5	33.11545	19586	92314	0.03019	73834	22318	50074
3.6	36.59823	44436	77988	0.02732	37224	47292	56080
3.7	40.44730	43600	67391	0.02472	35264	70339	39120
3.8	44.70118	44933	00823	0.02237	07718	56165	59578
3.9	49.40244	91055	30174	0.02024	19114	45804	38847
4.0	54.59815	00331	44239	0.01831	56388	88734	18029
4.1	60.34028	75973	61969	0.01657	26754	01761	24754
4.2	66.68633	10409	25142	0.01499	55768	20477	70621
4.3	73.69979	36995	95797	0.01356	85590	12200	93176
4.4	81.45086	86649	68117	0.01227	73399	03068	44118
4.5	90.01713	13005	21814	0.01110	89965	38242	30650
4.6	99.48431	56419	33809	0.01005	18357	44633	58164
4.7	109.94717	24521	23499	0.00909	52771	01695	81709
4.8	121.51041	75187	34881	0.00822	97470	49020	02884
4.9	134.28977	96849	35485	0.00744	65830	70924	34052
5.0	148.41315	91025	76603	0.00673	79469	99085	46710

From C. E. Van Orstrand, Tables of the exponential function and of the circular sine and cosine to radian arguments, Memoirs of the National Academy of Sciences, vol. 14, Fifth Memoir. U.S. Government Printing Office, Washington, D.C., 1921 (with permission) for e^{-x} , $x \leq 2.4$.

EXPONENTIAL FUNCTION

Table 4.4

x	e^x				e^{-x}			
5.0	148.41315	91025	77	0.00673	79469	99085	46710	
5.1	164.02190	72999	02	0.00609	67465	65515	63611	
5.2	181.27224	18751	51	0.00551	65644	20760	77242	
5.3	200.33680	99747	92	0.00499	15939	06910	21621	
5.4	221.40641	62041	87	0.00451	65809	42612	66798	
5.5	244.69193	22642	20	0.00408	67714	38464	06699	
5.6	270.42640	74261	53	0.00369	78637	16482	93082	
5.7	298.86740	09670	60	0.00334	59654	57471	27277	
5.8	330.29955	99096	49	0.00302	75547	45375	81475	
5.9	365.03746	78653	29	0.00273	94448	18768	36923	
6.0	403.42879	34927	35	0.00247	87521	76666	35842	
6.1	445.85777	00825	17	0.00224	28677	19485	80247	
6.2	492.74904	10932	56	0.00202	94306	36295	73436	
6.3	544.57191	01259	29	0.00183	63047	77028	90683	
6.4	601.84503	78720	82	0.00166	15572	73173	93450	
6.5	665.14163	30443	62	0.00150	34391	92977	57245	
6.6	735.09518	92419	73	0.00136	03680	37547	89342	
6.7	812.40582	51675	43	0.00123	09119	02673	48118	
6.8	897.84729	16504	18	0.00111	37751	47844	80308	
6.9	992.27471	56050	26	0.00100	77854	29048	51076	
7.0	1096.63315	84284	59	0.00091	18819	65554	51621	
7.1	1211.96707	44925	77	0.00082	51049	23265	90427	
7.2	1339.43076	43944	18	0.00074	65858	08376	67937	
7.3	1480.29992	75845	45	0.00067	55387	75193	84424	
7.4	1635.98442	99959	27	0.00061	12527	61129	57256	
7.5	1808.04241	44560	63	0.00055	30843	70147	83358	
7.6	1998.19589	51041	18	0.00050	04514	33440	61070	
7.7	2208.34799	18872	09	0.00045	28271	82886	79706	
7.8	2440.60197	76244	99	0.00040	97349	78979	78671	
7.9	2697.28232	82685	09	0.00037	07435	40459	08837	
8.0	2980.95798	70417	28	0.00033	54626	27902	51184	
8.1	3294.46807	52838	41	0.00030	35391	38078	86666	
8.2	3640.95030	73323	55	0.00027	46535	69972	14233	
8.3	4023.87239	38223	10	0.00024	85168	27107	95202	
8.4	4447.06674	76998	56	0.00022	48673	24178	84827	
8.5	4914.76884	02991	34	0.00020	34683	69010	64417	
8.6	5431.65959	13629	80	0.00018	41057	93667	57912	
8.7	6002.91221	72610	22	0.00016	65858	10987	63341	
8.8	6634.24400	62778	85	0.00015	07330	75095	47660	
8.9	7331.97353	91559	93	0.00013	63889	26482	01145	
9.0	8103.08392	75753	84	0.00012	34098	04086	67955	
9.1	8955.29270	34825	12	0.00011	16658	08490	11474	
9.2	9897.12905	87439	16	0.00010	10394	01837	09335	
9.3	10938.01920	81651	84	0.00009	14242	31478	17334	
9.4	12088.38073	02169	84	0.00008	27240	65556	63226	
9.5	13359.72682	96618	72	0.00007	48518	29887	70059	
9.6	14764.78156	55772	73	0.00006	77287	36490	85387	
9.7	16317.60719	80154	32	0.00006	12834	95053	22210	
9.8	18033.74492	78285	11	0.00005	54515	99432	17698	
9.9	19930.37043	82302	89	0.00005	01746	82056	17530	
10.0	22026.46579	48067	17	0.00004	53999	29762	48485	

26185

Table 4.4

EXPONENTIAL FUNCTION

x	e^x	e^{-x}
0	(0) 1.00000 00000 00000 000	(0) 1.00000 00000 00000 000
1	(0) 2.71828 18284 59045 235	(- 1) 3.67879 44117 14423 216
2	(0) 7.38905 60989 30650 227	(- 1) 1.35335 28323 66126 919
3	(1) 2.00855 36923 18766 774	(- 2) 4.97870 68367 86394 298
4	(1) 5.45981 50033 14423 908	(- 2) 1.83156 38888 73418 029
5	(2) 1.48413 15910 25766 034	(- 3) 6.73794 69990 85467 097
6	(2) 4.03428 79349 27351 226	(- 3) 2.47875 21766 66358 423
7	(3) 1.09663 31584 28458 599	(- 4) 9.11881 96555 45162 080
8	(3) 2.98095 79870 41728 275	(- 4) 3.35462 62790 25118 388
9	(3) 8.10308 39275 75384 008	(- 4) 1.23409 80408 66795 495
10	(4) 2.20264 65794 80671 652	(- 5) 4.53999 29762 48485 154
11	(4) 5.98741 41715 19781 846	(- 5) 1.67017 00790 24565 931
12	(5) 1.62754 79141 90039 208	(- 6) 6.14421 23533 28209 759
13	(5) 4.42413 39200 89205 033	(- 6) 2.26032 94069 81054 326
14	(6) 1.20260 42841 64776 778	(- 7) 8.31528 71910 35678 841
15	(6) 3.26901 73724 72110 639	(- 7) 3.05902 32050 18257 884
16	(6) 8.88611 05205 07872 637	(- 7) 1.12535 17471 92591 145
17	(7) 2.41549 52753 57529 821	(- 8) 4.13993 77187 85166 660
18	(7) 6.56599 69137 33051 114	(- 8) 1.52299 79744 71262 844
19	(8) 1.78482 30096 31872 608	(- 9) 5.60279 64375 37267 540
20	(8) 4.85165 19540 97902 780	(- 9) 2.06115 36224 38557 828
21	(9) 1.31881 57344 83214 697	(-10) 7.58256 04279 11906 728
22	(9) 3.58491 28461 31591 562	(-10) 2.78946 80928 68924 808
23	(9) 9.74480 34462 48902 600	(-10) 1.02618 79631 70189 030
24	(10) 2.64891 22129 84347 229	(-11) 3.77513 45442 79097 752
25	(10) 7.20048 99337 38587 252	(-11) 1.38879 43864 96402 059
26	(11) 1.95729 60942 88387 643	(-12) 5.10908 90280 63324 720
27	(11) 5.32048 24060 17986 167	(-12) 1.87952 88165 39083 295
28	(12) 1.44625 70642 91475 174	(-13) 6.91440 01069 40203 009
29	(12) 3.93133 42971 44042 074	(-13) 2.54366 56473 76922 910
30	(13) 1.06864 74581 52446 215	(-14) 9.35762 29688 40174 605
31	(13) 2.90488 49665 24742 523	(-14) 3.44247 71084 69976 458
32	(13) 7.89629 60182 68069 516	(-14) 1.26641 65549 09417 572
33	(14) 2.14643 57978 59160 646	(-15) 4.65888 61451 03397 364
34	(14) 5.83461 74252 74548 814	(-15) 1.71390 84315 42012 966
35	(15) 1.58601 34523 13430 728	(-16) 6.30511 67601 46989 386
36	(15) 4.31123 15471 15195 227	(-16) 2.31952 28302 43569 388
37	(16) 1.17191 42372 80261 131	(-17) 8.53304 76257 44065 794
38	(16) 3.18559 31757 11375 622	(-17) 3.13913 27920 48029 629
39	(16) 8.65934 00423 99374 695	(-17) 1.15482 24173 01578 599
40	(17) 2.35385 26683 70199 854	(-18) 4.24835 42552 91588 995
41	(17) 6.39843 49353 00549 492	(-18) 1.56288 21893 34988 768
42	(18) 1.73927 49415 20501 047	(-19) 5.74952 22642 93559 807
43	(18) 4.72783 94682 29346 561	(-19) 2.11513 10375 91080 487
44	(19) 1.28516 00114 35930 828	(-20) 7.78113 22411 33796 516
45	(19) 3.49342 71057 48509 535	(-20) 2.86251 85805 49393 644
46	(19) 9.49611 94206 02448 875	(-20) 1.05306 17357 55381 238
47	(20) 2.58131 28861 90067 396	(-21) 3.87399 76286 87187 113
48	(20) 7.01673 59120 97631 739	(-21) 1.42516 40827 40935 106
49	(21) 1.90734 65724 95099 691	(-22) 5.24288 56633 63463 937
50	(21) 5.18470 55285 87072 464	(-22) 1.92874 98479 63917 783

EXPONENTIAL FUNCTION

Table 4.4

x	e^x	e^{-x}
50	(21) 5.18470 55285 87072 464	(-22) 1.92874 98479 63917 783
51	(22) 1.40934 90824 26938 796	(-23) 7.09547 41622 84704 139
52	(22) 3.83100 80007 16576 849	(-23) 2.61027 90696 67704 805
53	(23) 1.04137 59433 02908 780	(-24) 9.60268 00545 08676 030
54	(23) 2.83075 33032 74693 900	(-24) 3.53262 85722 00807 030
55	(23) 7.69478 52651 42017 138	(-24) 1.29958 14250 07503 074
56	(24) 2.09165 94960 12996 154	(-25) 4.78089 28838 85469 081
57	(24) 5.68571 99993 35932 223	(-25) 1.75879 22024 24311 649
58	(25) 1.54553 89355 90103 930	(-26) 6.47023 49256 45460 326
59	(25) 4.20121 04037 90514 255	(-26) 2.38026 64086 94400 606
60	(26) 1.14200 73898 15684 284	(-27) 8.75651 07626 96520 338
61	(26) 3.10429 79357 01919 909	(-27) 3.22134 02859 92516 089
62	(26) 8.43835 66687 41454 489	(-27) 1.18506 48642 33981 006
63	(27) 2.29378 31594 69609 879	(-28) 4.35961 00000 63080 974
64	(27) 6.23514 90808 11616 883	(-28) 1.60381 08905 48637 853
65	(28) 1.69488 92444 10333 714	(-29) 5.90009 05415 97061 391
66	(28) 4.60718 66343 31291 543	(-29) 2.17052 20113 03639 412
67	(29) 1.25236 31708 42213 781	(-30) 7.98490 42456 86978 808
68	(29) 3.40427 60499 31740 521	(-30) 2.93748 21117 10802 947
69	(29) 9.25378 17255 87787 600	(-30) 1.08063 92777 07278 495
70	(30) 2.51543 86709 19167 006	(-31) 3.97544 97359 08646 808
71	(30) 6.83767 12297 62743 867	(-31) 1.46248 62272 51230 947
72	(31) 1.85867 17452 84127 980	(-32) 5.38018 61600 21138 414
73	(31) 5.05239 36302 76104 195	(-32) 1.97925 98779 46904 554
74	(32) 1.37338 29795 40176 188	(-33) 7.28129 01783 21643 834
75	(32) 3.73324 19967 99001 640	(-33) 2.67863 69618 08077 944
76	(33) 1.01480 03881 13888 728	(-34) 9.85415 46861 11258 029
77	(33) 2.75851 34545 23170 206	(-34) 3.62514 09191 43559 224
78	(33) 7.49841 69969 90120 435	(-34) 1.33361 48155 02261 341
79	(34) 2.03828 10665 12668 767	(-35) 4.90609 47306 49280 566
80	(34) 5.54062 23843 93510 053	(-35) 1.80485 13878 45415 172
81	(35) 1.50609 73145 85030 548	(-36) 6.63967 71995 80734 401
82	(35) 4.09399 69621 27454 697	(-36) 2.44260 07377 40527 679
83	(36) 1.11286 37547 91759 412	(-37) 8.98582 59440 49380 670
84	(36) 3.02507 73222 01142 338	(-37) 3.30570 06267 60734 298
85	(36) 8.22301 27146 22913 510	(-37) 1.21609 92992 52825 564
86	(37) 2.23524 66037 34715 047	(-38) 4.47377 93061 81120 735
87	(37) 6.07603 02250 56872 150	(-38) 1.64581 14310 82273 651
88	(38) 1.65163 62549 94001 856	(-39) 6.05460 18954 01185 885
89	(38) 4.48961 28191 74345 246	(-39) 2.22736 35617 95743 739
90	(39) 1.22040 32943 17840 802	(-40) 8.19401 26239 90515 430
91	(39) 3.31740 00983 35742 626	(-40) 3.01440 87850 65374 553
92	(39) 9.01762 84050 34298 931	(-40) 1.10893 90193 12136 379
93	(40) 2.45124 55429 20085 786	(-41) 4.07955 86671 77560 158
94	(40) 6.66317 62164 10895 834	(-41) 1.50078 57627 07394 888
95	(41) 1.81123 90828 89023 282	(-42) 5.52108 22770 28532 732
96	(41) 4.92345 82860 12058 400	(-42) 2.03109 26627 34810 926
97	(42) 1.33833 47192 04269 500	(-43) 7.47197 23373 42990 161
98	(42) 3.63797 09476 08804 579	(-43) 2.74878 50079 10214 930
99	(42) 9.88903 03193 46946 771	(-43) 1.01122 14926 10448 530
100	(43) 2.68811 71418 16135 448	(-44) 3.72007 59760 20835 963

For $|x| > 100$ see Example 11.

Table 4.5

RADIX TABLE OF THE EXPONENTIAL FUNCTION

x	n	$e^{x10^{-n}}$					$e^{-x10^{-n}}$				
1	10	1.00000	00001	00000	00000	50000	0.99999	99999	00000	00000	50000
2	10	1.00000	00002	00000	00002	00000	0.99999	99998	00000	00002	00000
3	10	1.00000	00003	00000	00004	50000	0.99999	99997	00000	00004	50000
4	10	1.00000	00004	00000	00008	00000	0.99999	99996	00000	00008	00000
5	10	1.00000	00005	00000	00012	50000	0.99999	99995	00000	00012	50000
6	10	1.00000	00006	00000	00018	00000	0.99999	99994	00000	00018	00000
7	10	1.00000	00007	00000	00024	50000	0.99999	99993	00000	00024	50000
8	10	1.00000	00008	00000	00032	00000	0.99999	99992	00000	00032	00000
9	10	1.00000	00009	00000	00040	50000	0.99999	99991	00000	00040	50000
1	9	1.00000	00010	00000	00050	00000	0.99999	99990	00000	00050	00000
2	9	1.00000	00020	00000	00200	00000	0.99999	99980	00000	00200	00000
3	9	1.00000	00030	00000	00450	00000	0.99999	99970	00000	00450	00000
4	9	1.00000	00040	00000	00800	00000	0.99999	99960	00000	00800	00000
5	9	1.00000	00050	00000	01250	00000	0.99999	99950	00000	01250	00000
6	9	1.00000	00060	00000	01800	00000	0.99999	99940	00000	01800	00000
7	9	1.00000	00070	00000	02450	00001	0.99999	99930	00000	02449	99999
8	9	1.00000	00080	00000	03200	00001	0.99999	99920	00000	03199	99999
9	9	1.00000	00090	00000	04050	00001	0.99999	99910	00000	04049	99999
1	8	1.00000	00100	00000	05000	00002	0.99999	99900	00000	04999	99998
2	8	1.00000	00200	00000	20000	00013	0.99999	99800	00000	19999	99987
3	8	1.00000	00300	00000	45000	00045	0.99999	99700	00000	44999	99955
4	8	1.00000	00400	00000	80000	00107	0.99999	99600	00000	79999	99893
5	8	1.00000	00500	00001	25000	00208	0.99999	99500	00001	24999	99792
6	8	1.00000	00600	00001	80000	00360	0.99999	99400	00001	79999	99640
7	8	1.00000	00700	00002	45000	00572	0.99999	99300	00002	44999	99428
8	8	1.00000	00800	00003	20000	00853	0.99999	99200	00003	19999	99147
9	8	1.00000	00900	00004	05000	01215	0.99999	99100	00004	04999	98785
1	7	1.00000	01000	00005	00000	01667	0.99999	99000	00004	99999	98333
2	7	1.00000	02000	00020	00000	13333	0.99999	98000	00019	99999	86667
3	7	1.00000	03000	00045	00000	45000	0.99999	97000	00044	99999	55000
4	7	1.00000	04000	00080	00001	06667	0.99999	96000	00079	99998	93333
5	7	1.00000	05000	00125	00002	08333	0.99999	95000	00124	99997	91667
6	7	1.00000	06000	00180	00003	60000	0.99999	94000	00179	99996	40000
7	7	1.00000	07000	00245	00005	71667	0.99999	93000	00244	99994	28333
8	7	1.00000	08000	00320	00008	53334	0.99999	92000	00319	99991	46667
9	7	1.00000	09000	00405	00012	15000	0.99999	91000	00404	99987	85000
1	6	1.00000	10000	00500	00016	66667	0.99999	90000	00499	99983	33334
2	6	1.00000	20000	02000	00133	33340	0.99999	80000	01999	99866	66673
3	6	1.00000	30000	04500	00450	00034	0.99999	70000	04499	99550	00034
4	6	1.00000	40000	08000	01066	66773	0.99999	60000	07999	98933	33440
5	6	1.00000	50000	12500	02083	33594	0.99999	50000	12499	97916	66927
6	6	1.00000	60000	18000	03600	00540	0.99999	40000	17999	96400	00540
7	6	1.00000	70000	24500	05716	67667	0.99999	30000	24499	94283	34334
8	6	1.00000	80000	32000	08533	35040	0.99999	20000	31999	91466	68373
9	6	1.00000	90000	40500	12150	02734	0.99999	10000	40499	87850	02734

For $n > 10$, $e^{\pm x10^{-n}} = 1 \pm x10^{-n} + \frac{1}{2} x^2 10^{-2n}$ to 25D.

Compiled from C. E. Van Orstrand, Tables of the exponential function and of the circular sine and cosine to radian arguments, Memoirs of the National Academy of Sciences, vol. 14, Fifth Memoir. U.S. Government Printing Office, Washington, D.C., 1921 (with permission).

RADIX TABLE OF THE EXPONENTIAL FUNCTION Table 4.5

x	n	$e^{x10^{-n}}$						$e^{-x10^{-n}}$					
1	5	1.00001	00000	50000	16666	70833	0.99999	00000	49999	83333	37500		
2	5	1.00002	00002	00001	33334	00000	0.99998	00001	99998	66667	33333		
3	5	1.00003	00004	50004	50003	37502	0.99997	00004	49995	50003	37498		
4	5	1.00004	00008	00010	66677	33342	0.99996	00007	99989	33343	99991		
5	5	1.00005	00012	50020	83359	37526	0.99995	00012	49979	16692	70807		
6	5	1.00006	00018	00036	00054	00065	0.99994	00017	99964	00053	99935		
7	5	1.00007	00024	50057	16766	70973	0.99993	00024	49942	83433	37360		
8	5	1.00008	00032	00085	33504	00273	0.99992	00031	99914	66837	33060		
9	5	1.00009	00040	50121	50273	37992	0.99991	00040	49878	50273	37008		
1	4	1.00010	00050	00156	67083	34167	0.99990	00049	99833	33749	99167		
2	4	1.00020	00200	01333	40000	26668	0.99980	00199	98666	73333	06668		
3	4	1.00030	00450	04500	33752	02510	0.99970	00449	95500	33747	97510		
4	4	1.00040	00800	10667	73341	86724	0.99960	00799	89334	39991	46724		
5	4	1.00050	01250	20835	93776	04384	0.99950	01249	79169	27057	29384		
6	4	1.00060	01800	36005	40064	80648	0.99940	01799	64005	39935	20648		
7	4	1.00070	02450	57176	67223	40801	0.99930	02449	42843	33609	95801		
8	4	1.00080	03200	85350	40273	10308	0.99920	03199	14683	73060	30307		
9	4	1.00090	04051	21527	34242	14882	0.99910	04048	78527	33257	99880		
1	3	1.00100	05001	66708	34166	80558	0.99900	04998	33374	99166	80554		
2	3	1.00200	20013	34000	26675	55810	0.99800	19986	67333	06675	55302		
3	3	1.00300	45045	03377	02601	29341	0.99700	44955	03372	97601	20662		
4	3	1.00400	80106	77341	87235	88080	0.99600	79893	43991	47235	23064		
5	3	1.00501	25208	59401	06338	35662	0.99501	24791	92682	31335	25642		
6	3	1.00601	80360	54064	86485	55845	0.99401	79640	53935	26474	44988		
7	3	1.00702	45572	66848	55523	16000	0.99302	44429	33235	10490	47970		
8	3	1.00803	20855	04273	43117	20736	0.99203	19148	37060	63033	98697		
9	3	1.00904	06217	73867	81406	25705	0.99104	03787	72883	66216	45648		
1	2	1.01005	01670	84168	05754	21655	0.99004	98337	49168	05357	39060		
2	2	1.02020	13400	26755	81016	01439	0.98019	86733	06755	30222	08141		
3	2	1.03045	45339	53516	85561	24400	0.97044	55335	48508	17693	25284		
4	2	1.04081	07741	92388	22675	70448	0.96078	94391	52323	20943	92107		
5	2	1.05127	10963	76024	03969	75176	0.95122	94245	00714	00909	14253		
6	2	1.06183	65465	45359	62222	46849	0.94176	45335	84248	70953	71528		
7	2	1.07250	81812	54216	47905	31039	0.93239	38199	05948	22885	79726		
8	2	1.08328	70676	74958	55443	59878	0.92311	63463	86635	78291	07598		
9	2	1.09417	42837	05210	35787	28976	0.91393	11852	71228	18674	73535		
1	1	1.10517	09180	75647	62481	17078	0.90483	74180	35959	57316	42491		
2	1	1.22140	27581	60169	83392	10720	0.81873	07530	77981	85866	99355		
3	1	1.34985	88075	76003	10398	37443	0.74081	82206	81717	86606	68738		
4	1	1.49182	46976	41270	31782	48530	0.67032	00460	35639	30074	44329		
5	1	1.64872	12707	00128	14684	86508	0.60653	06597	12633	42360	37995		
6	1	1.82211	88003	90508	97487	53677	0.54881	16360	94026	43262	84589		
7	1	2.01375	27074	70476	52162	45494	0.49658	53037	91409	51470	48001		
8	1	2.22554	09284	92467	60457	95375	0.44932	89641	17221	59143	01024		
9	1	2.45960	31111	56949	66380	01266	0.40656	96597	40599	11188	34542		
1	0	2.71828	18284	59045	23536	02875	0.36787	94411	71442	32159	55238		

Table 4.6 CIRCULAR SINES AND COSINES FOR RADIAN ARGUMENTS

x	sin x					cos x				
0.000	0.00000	00000	00000	00000	000	1.00000	00000	00000	00000	000
0.001	0.00099	99998	33333	34166	667	0.99999	95000	00041	66666	528
0.002	0.00199	99986	66666	93333	331	0.99999	80000	00666	66657	778
0.003	0.00299	99955	00002	02499	957	0.99999	55000	03374	99898	750
0.004	0.00399	99893	33341	86666	342	0.99999	20000	10666	66097	778
0.005	0.00499	99791	66692	70831	783	0.99998	75000	26041	64496	529
0.006	0.00599	99640	00064	79994	446	0.99998	20000	53999	93520	004
0.007	0.00699	99428	33473	39150	327	0.99997	55001	00041	50326	542
0.008	0.00799	99146	66939	73291	723	0.99996	80001	70666	30257	819
0.009	0.00899	98785	00492	07405	100	0.99995	95002	73374	26188	857
0.010	0.00999	98333	34166	66468	254	0.99995	00004	16665	27778	026
0.011	0.01099	97781	68008	75446	684	0.99993	95006	10039	20617	059
0.012	0.01199	97120	02073	59289	053	0.99992	80008	63995	85281	066
0.013	0.01299	96338	36427	42921	659	0.99991	55011	90034	96278	551
0.014	0.01399	95426	71148	51241	801	0.99990	20016	00656	20901	438
0.015	0.01499	94375	06328	09109	944	0.99988	75021	09359	17975	106
0.016	0.01599	93173	42071	41340	585	0.99987	20027	30643	36508	430
0.017	0.01699	91811	78498	72691	726	0.99985	55034	80008	14243	829
0.018	0.01799	90280	15746	27852	832	0.99983	80043	73952	76107	331
0.019	0.01899	88568	53967	31431	205	0.99981	95054	29976	32558	650
0.020	0.01999	86666	93333	07936	649	0.99980	00066	66577	77841	270
0.021	0.02099	84565	34033	81764	335	0.99977	95081	03255	88132	556
0.022	0.02199	82253	76279	77175	771	0.99975	80097	60509	19593	878
0.023	0.02299	79722	20302	18277	769	0.99973	55116	59836	06320	750
0.024	0.02399	76960	66354	28999	311	0.99971	20138	23734	58193	002
0.025	0.02499	73959	14712	33066	217	0.99968	75162	75702	58624	967
0.026	0.02599	70707	65676	53973	517	0.99966	20190	40237	62215	698
0.027	0.02699	67196	19572	14955	411	0.99963	55221	42836	92299	214
0.028	0.02799	63414	76750	38952	746	0.99960	80256	09997	38394	779
0.029	0.02899	59353	37589	48577	881	0.99957	95294	69215	53557	207
0.030	0.02999	55002	02495	66076	853	0.99955	00337	48987	51627	216
0.031	0.03099	50350	71904	13288	752	0.99951	95384	78809	04381	810
0.032	0.03199	45389	46280	11602	188	0.99948	80436	89175	38584	710
0.033	0.03299	40108	26119	81908	762	0.99945	55494	11581	32936	824
0.034	0.03399	34497	11951	44553	435	0.99942	20556	78521	14926	773
0.035	0.03499	28546	04336	19281	702	0.99938	75625	23488	57581	460
0.036	0.03599	22245	03869	25183	461	0.99935	20699	80976	76116	700
0.037	0.03699	15584	11180	80633	489	0.99931	55780	86478	24487	902
0.038	0.03799	08553	26937	03228	414	0.99927	80868	76484	91840	819
0.039	0.03899	01142	51841	09720	085	0.99923	95963	88487	98862	358
0.040	0.03998	93341	86634	15945	255	0.99920	01066	60977	94031	457
0.041	0.04098	85141	32096	36751	449	0.99915	96177	33444	49770	040
0.042	0.04198	76530	89047	85918	946	0.99911	81296	46376	58494	043
0.043	0.04298	67500	58349	76078	755	0.99907	56424	41262	28564	524
0.044	0.04398	58040	40905	18626	492	0.99903	21561	60588	80138	853
0.045	0.04498	48140	37660	23632	066	0.99898	76708	47842	40921	992
0.046	0.04598	37790	49604	99745	054	0.99894	21865	47508	41817	869
0.047	0.04698	26980	77774	54095	689	0.99889	57033	05071	12480	849
0.048	0.04798	15701	23249	92191	340	0.99884	82211	67013	76767	299
0.049	0.04898	03941	87159	17808	403	0.99879	97401	80818	48087	272
0.050	0.04997	91692	70678	32879	487	0.99875	02603	94966	24656	287
			$\left[\begin{smallmatrix} (-9)6 \\ 7 \end{smallmatrix} \right]$						$\left[\begin{smallmatrix} (-7)1 \\ 7 \end{smallmatrix} \right]$	

For conversion from degrees to radians see Example 13.

For use and extension of the table see Examples 15–17.

From C. E. Van Orstrand, Tables of the exponential function and of the circular sine and cosine to radian arguments, *Memoirs of the National Academy of Sciences*, vol. 14, Fifth Memoir. U.S. Government Printing Office, Washington, D.C., 1921 (with permission). Known errors have been corrected.

CIRCULAR SINES AND COSINES FOR RADIAN ARGUMENTS

Table 4.6

x	sin x					cos x					
0.050	0.04997	91692	70678	32879	487	0.99875	02603	94966	24656	287	
0.051	0.05097	78943	75032	37375	800	0.99869	97818	58936	84647	237	
0.052	0.05197	65685	01496	29184	649	0.99864	83046	23208	81242	407	
0.053	0.05297	51906	51396	03981	925	0.99859	58287	39259	37585	623	
0.054	0.05397	37598	26109	55099	505	0.99854	23542	59564	41634	531	
0.055	0.05497	22750	27067	73387	446	0.99848	78812	37598	40913	005	
0.056	0.05597	07352	55755	47070	891	0.99843	24097	27834	37163	704	
0.057	0.05696	91395	13712	61601	567	0.99837	59397	85743	80900	770	
0.058	0.05796	74868	02534	99503	794	0.99831	84714	67796	65862	676	
0.059	0.05896	57761	23875	40214	896	0.99826	00048	31461	23365	235	
0.060	0.05996	40064	79444	59919	909	0.99820	05399	35204	16554	766	
0.061	0.06096	21768	71012	31380	500	0.99814	00768	38490	34561	437	
0.062	0.06196	02863	00408	23757	982	0.99807	86156	01782	86552	769	
0.063	0.06295	83337	69523	02430	343	0.99801	61562	86542	95687	334	
0.064	0.06395	63182	80309	28803	166	0.99795	26989	55229	92968	628	
0.065	0.06495	42388	34782	60114	361	0.99788	82436	71301	10999	144	
0.066	0.06595	20944	35022	49232	601	0.99782	27904	99211	77634	635	
0.067	0.06694	98840	83173	44449	361	0.99775	63395	04415	09538	592	
0.068	0.06794	76067	81445	89264	458	0.99768	88907	53362	05636	926	
0.069	0.06894	52615	32117	22165	004	0.99762	04443	13501	40472	866	
0.070	0.06994	28473	37532	76397	655	0.99755	10002	53279	57462	091	
0.071	0.07094	03632	00106	79734	071	0.99748	05586	42140	62048	084	
0.072	0.07193	78081	22323	54229	480	0.99740	91195	50526	14757	726	
0.073	0.07293	51811	06738	15974	250	0.99733	66830	49875	24157	139	
0.074	0.07393	24811	55977	74838	360	0.99726	32492	12624	39707	777	
0.075	0.07492	97072	72742	34208	684	0.99718	88181	12207	44522	774	
0.076	0.07592	68584	59805	90718	980	0.99711	33898	23055	48023	568	
0.077	0.07692	39337	20017	33972	485	0.99703	69644	20596	78496	785	
0.078	0.07792	09320	56301	46257	015	0.99695	95419	81256	75551	417	
0.079	0.07891	78524	71660	02252	478	0.99688	11225	82457	82476	279	
0.080	0.07991	46939	69172	68730	688	0.99680	17063	02619	38497	771	
0.081	0.08091	14555	51998	04247	389	0.99672	12932	21157	70937	933	
0.082	0.08190	81362	23374	58826	394	0.99663	98834	18485	87272	823	
0.083	0.08290	47349	86621	73635	718	0.99655	74769	76013	67091	212	
0.084	0.08390	12508	45140	80655	638	0.99647	40739	76147	53953	598	
0.085	0.08489	76828	02416	02338	544	0.99638	96745	02290	47151	570	
0.086	0.08589	40298	62015	51260	514	0.99630	42786	38841	93367	506	
0.087	0.08689	02910	27592	29764	492	0.99621	78864	71197	78234	626	
0.088	0.08788	64653	02885	29594	973	0.99613	04980	85750	17797	412	
0.089	0.08888	25516	91720	31524	112	0.99604	21135	69887	49872	388	
0.090	0.08987	85491	98011	04969	125	0.99595	27330	11994	25309	284	
0.091	0.09087	44568	25760	07600	919	0.99586	23565	01450	99152	586	
0.092	0.09187	02735	79059	84943	819	0.99577	09841	28634	21703	483	
0.093	0.09286	59984	62093	69966	323	0.99567	86159	84916	29482	217	
0.094	0.09386	16304	79136	82662	751	0.99558	52521	62665	36090	844	
0.095	0.09485	71686	34557	29625	724	0.99549	08927	55245	22976	426	
0.096	0.09585	26119	32817	03609	347	0.99539	55378	57015	30094	649	
0.097	0.09684	79593	78472	83083	006	0.99529	91875	63330	46473	881	
0.098	0.09784	32099	76177	31775	683	0.99520	18419	70541	00679	686	
0.099	0.09883	83627	30679	98210	683	0.99510	35011	75992	51179	796	
0.100	0.09983	34166	46828	15230	681	0.99500	41652	78025	76609	556	
		$\left[\begin{smallmatrix} (-8)1 \\ 7 \end{smallmatrix} \right]$						$\left[\begin{smallmatrix} (-7)1 \\ 7 \end{smallmatrix} \right]$			

Table 4.6 CIRCULAR SINES AND COSINES FOR RADIAN ARGUMENTS

x	sin x					cos x				
0.100	0.09983	34166	46828	15230	681	0.99500	41652	78025	76609	556
0.101	0.10082	83707	29567	99512	975	0.99490	38343	75976	65937	840
0.102	0.10182	32239	83945	51074	864	0.99480	25085	70176	08533	469
0.103	0.10281	79754	15107	52769	040	0.99470	01879	61949	84132	117
0.104	0.10381	26240	28302	69768	897	0.99459	68726	53618	52703	737
0.105	0.10480	71688	28882	49043	655	0.99449	25627	48497	44220	501
0.106	0.10580	16088	22302	18823	209	0.99438	72583	50896	48325	268
0.107	0.10679	59430	14121	88052	588	0.99428	09595	66120	03900	596
0.108	0.10779	01704	10007	45835	941	0.99417	36665	00466	88538	307
0.109	0.10878	42900	15731	60869	939	0.99406	53792	61230	07909	607
0.110	0.10977	83008	37174	80866	495	0.99395	60979	56696	85035	784
0.111	0.11077	22018	80326	31964	714	0.99384	58226	96148	49459	483
0.112	0.11176	59921	51285	18131	952	0.99373	45535	89860	26316	578
0.113	0.11275	96706	56261	20553	909	0.99362	22907	49101	25308	652
0.114	0.11375	32364	01575	97013	636	0.99350	90342	86134	29576	080
0.115	0.11474	66883	93663	81259	372	0.99339	47843	14215	84471	755
0.116	0.11574	00256	39072	82361	097	0.99327	95409	47595	86235	439
0.117	0.11673	32471	44465	84055	722	0.99316	33043	01517	70568	768
0.118	0.11772	63519	16621	44080	790	0.99304	60744	92218	01110	921
0.119	0.11871	93389	62434	93496	613	0.99292	78516	36926	57814	950
0.120	0.11971	22072	88919	35996	735	0.99280	86358	53866	25224	810
0.121	0.12070	49559	03206	47206	615	0.99268	84272	62252	80653	067
0.122	0.12169	75838	12547	73970	447	0.99256	72259	82294	82259	329
0.123	0.12269	00900	24315	33626	003	0.99244	50321	35193	57029	382
0.124	0.12368	24735	46003	13267	407	0.99232	18458	43142	88655	070
0.125	0.12467	47333	85227	68995	744	0.99219	76672	29329	05314	910
0.126	0.12566	68685	49729	25157	389	0.99207	24964	17930	67355	462
0.127	0.12665	88780	47372	73569	978	0.99194	63335	34118	54873	474
0.128	0.12765	07608	86148	72735	909	0.99181	91787	04055	55198	803
0.129	0.12864	25160	74174	47043	273	0.99169	10320	54896	50278	123
0.130	0.12963	41426	19694	85954	121	0.99156	18937	14788	03959	451
0.131	0.13062	56395	31083	43179	968	0.99143	17638	12868	49177	481
0.132	0.13161	70058	16843	35844	433	0.99130	06424	79267	75039	751
0.133	0.13260	82404	85608	43632	907	0.99116	85298	45107	13813	659
0.134	0.13359	93425	46144	07929	171	0.99103	54260	42499	27814	325
0.135	0.13459	03110	07348	30938	844	0.99090	13312	04547	96193	339
0.136	0.13558	11448	78252	74799	575	0.99076	62454	65348	01628	375
0.137	0.13657	18431	68023	60677	867	0.99063	01689	59985	16913	714
0.138	0.13756	24048	85962	67852	453	0.99049	31018	24535	91451	667
0.139	0.13855	28290	41508	32784	107	0.99035	50441	96067	37644	937
0.140	0.13954	31146	44236	48171	799	0.99021	59962	12637	17189	895
0.141	0.14053	32607	03861	61995	092	0.99007	59580	13293	27270	829
0.142	0.14152	32662	30237	76542	691	0.98993	49297	38073	86655	145
0.143	0.14251	31302	33359	47427	025	0.98979	29115	28007	21689	546
0.144	0.14350	28517	23362	82584	791	0.98964	99035	25111	52197	214
0.145	0.14449	24297	10526	41263	332	0.98950	59058	72394	77275	984
0.146	0.14548	18632	05272	32992	773	0.98936	09187	13854	60997	551
0.147	0.14647	11512	18167	16543	800	0.98921	49421	94478	18007	704
0.148	0.14746	02927	59922	98870	997	0.98906	79764	60241	99027	617
0.149	0.14844	92868	41398	34041	627	0.98892	00216	58111	76256	193
0.150	0.14943	81324	73599	22149	773	0.98877	10779	36042	28673	498
			$\left[\begin{smallmatrix} (-8)2 \\ 7 \end{smallmatrix} \right]$						$\left[\begin{smallmatrix} (-7)1 \\ 7 \end{smallmatrix} \right]$	

CIRCULAR SINES AND COSINES FOR RADIAN ARGUMENTS

Table 4.6

x	$\sin x$					$\cos x$				
0.150	0.14943	81324	73599	22149	773	0.98877	10779	36042	28673	498
0.151	0.15042	68286	67680	08215	725	0.98862	11454	42977	27245	283
0.152	0.15141	53744	34944	81070	532	0.98847	02243	28849	20028	611
0.153	0.15240	37687	86847	72225	604	0.98831	83147	44579	17178	614
0.154	0.15339	20107	34994	54727	267	0.98816	54168	42076	75856	382
0.155	0.15438	00992	91143	41996	190	0.98801	15307	74239	85038	006
0.156	0.15536	80334	67205	86651	555	0.98785	66566	94954	50224	794
0.157	0.15635	58122	75247	79319	902	0.98770	07947	59094	78054	663
0.158	0.15734	34347	27490	47428	529	0.98754	39451	22522	60814	736
0.159	0.15833	08998	36311	53983	354	0.98738	61079	42087	60855	150
0.160	0.15931	82066	14245	96331	146	0.98722	72833	75626	94904	095
0.161	0.16030	53540	73987	04906	020	0.98706	74715	81965	18284	099
0.162	0.16129	23412	28387	41960	095	0.98690	66727	20914	09029	574
0.163	0.16227	91670	90460	00278	226	0.98674	48869	53272	51905	638
0.164	0.16326	58306	73379	01876	705	0.98658	21144	40826	22328	234
0.165	0.16425	23309	90480	96685	825	0.98641	83553	46347	70185	554
0.166	0.16523	86670	55265	61216	228	0.98625	36098	33596	03560	791
0.167	0.16622	48378	81396	97208	916	0.98608	78780	67316	72356	233
0.168	0.16721	08424	82704	30268	843	0.98592	11602	13241	51818	712
0.169	0.16819	66798	73183	08481	981	0.98575	34564	38088	25966	434
0.170	0.16918	23490	66996	01015	762	0.98558	47669	09560	70917	193
0.171	0.17016	78490	78473	96702	805	0.98541	50917	96348	38117	998
0.172	0.17115	31789	22117	02607	812	0.98524	44312	68126	37476	124
0.173	0.17213	83376	12595	42577	560	0.98507	27854	95555	20391	598
0.174	0.17312	33241	64750	55773	865	0.98490	01546	50280	62691	158
0.175	0.17410	81375	93595	95189	433	0.98472	65389	04933	47463	670
0.176	0.17509	27769	14318	26146	505	0.98455	19384	33129	47797	052
0.177	0.17607	72411	42278	24778	176	0.98437	63534	09469	09416	699
0.178	0.17706	15292	93011	76492	317	0.98419	97840	09537	33225	443
0.179	0.17804	56403	82230	74417	975	0.98402	22304	09903	57745	046
0.180	0.17902	95734	25824	17834	180	0.98384	36927	88121	41459	272
0.181	0.18001	33274	39859	10581	029	0.98366	41713	22728	45058	522
0.182	0.18099	69014	40581	59452	980	0.98348	36661	93246	13586	083
0.183	0.18198	02944	44417	72574	233	0.98330	21775	80179	58485	974
0.184	0.18296	35054	67974	57756	116	0.98311	97056	65017	39552	448
0.185	0.18394	65335	28041	20836	370	0.98293	62506	30231	46781	122
0.186	0.18492	93776	41589	64000	231	0.98275	18126	59276	82121	799
0.187	0.18591	20368	25775	84083	224	0.98256	63919	36591	41132	959
0.188	0.18689	45100	97940	70855	554	0.98237	99886	47595	94537	971
0.189	0.18787	67964	75611	05288	013	0.98219	26029	78693	69683	022
0.190	0.18885	88949	76500	57799	285	0.98200	42351	17270	31896	788
0.191	0.18984	08046	18510	86484	571	0.98181	48852	51693	65751	875
0.192	0.19082	25244	19732	35325	424	0.98162	45535	71313	56228	034
0.193	0.19180	40533	98445	32380	691	0.98143	32402	66461	69777	178
0.194	0.19278	53905	73120	87958	485	0.98124	09455	28451	35290	214
0.195	0.19376	65349	62421	92769	058	0.98104	76695	49577	24965	723
0.196	0.19474	74855	85204	16058	510	0.98085	34125	23115	35080	479
0.197	0.19572	82414	60517	03723	204	0.98065	81746	43322	66661	867
0.198	0.19670	88016	07604	76404	820	0.98046	19561	05437	06062	170
0.199	0.19768	91650	45907	27565	917	0.98026	47571	05677	05434	796
0.200	0.19866	93307	95061	21545	941	0.98006	65778	41241	63112	420
			$\left[\begin{smallmatrix} (-8)2 \\ 7 \end{smallmatrix} \right]$						$\left[\begin{smallmatrix} (-7)1 \\ 7 \end{smallmatrix} \right]$	

Table 4.6 CIRCULAR SINES AND COSINES FOR RADIAN ARGUMENTS

x	sin x					cos x				
0.200	0.19866	93307	95061	21545	941	0.98006	65778	41241	63112	420
0.201	0.19964	92978	74900	91597	545	0.97986	74185	10310	03887	090
0.202	0.20062	90653	05459	37903	151	0.97966	72793	12041	59192	306
0.203	0.20160	86321	06969	25571	640	0.97946	61604	46575	47187	084
0.204	0.20258	79972	99863	82615	083	0.97926	40621	15030	52742	047
0.205	0.20356	71599	04777	97905	397	0.97906	09845	19505	07327	536
0.206	0.20454	61189	42549	19110	856	0.97885	69278	63076	68803	784
0.207	0.20552	48734	34218	50612	330	0.97865	18923	49802	01113	156
0.208	0.20650	34224	01031	51399	175	0.97844	58781	84716	53874	491
0.209	0.20748	17648	64439	32944	665	0.97823	88855	73834	41879	553
0.210	0.20845	98998	46099	57060	871	0.97803	09147	24148	24491	614
0.211	0.20943	78263	67877	33732	895	0.97782	19658	43628	84946	201
0.212	0.21041	55434	51846	18932	346	0.97761	20391	41225	09554	014
0.213	0.21139	30501	20289	12409	982	0.97740	11348	26863	66806	039
0.214	0.21237	03453	95699	55467	398	0.97718	92531	11448	86380	882
0.215	0.21334	74283	00782	28707	677	0.97697	63942	06862	38054	344
0.216	0.21432	42978	58454	49764	905	0.97676	25583	25963	10511	247
0.217	0.21530	09530	91846	71012	439	0.97654	77456	82586	90059	555
0.218	0.21627	73930	24303	77249	851	0.97633	19564	91546	39246	782
0.219	0.21725	36166	79385	83368	434	0.97611	51909	68630	75378	736
0.220	0.21822	96230	80869	31995	179	0.97589	74493	30605	48940	602
0.221	0.21920	54112	52747	91115	124	0.97567	87317	95212	21920	392
0.222	0.22018	09802	19233	51671	977	0.97545	90385	81168	46034	788
0.223	0.22115	63290	04757	25146	920	0.97523	83699	08167	40857	388
0.224	0.22213	14566	33970	41115	484	0.97501	67259	96877	71849	392
0.225	0.22310	63621	31745	44782	417	0.97479	41070	68943	28292	737
0.226	0.22408	10445	23176	94494	428	0.97457	05133	46983	01125	708
0.227	0.22505	55028	33582	59230	720	0.97434	59450	54590	60681	052
0.228	0.22602	97360	88504	16071	214	0.97412	04024	16334	34326	607
0.229	0.22700	37433	13708	47642	363	0.97389	38856	57756	84008	477
0.230	0.22797	75235	35188	39540	462	0.97366	63950	05374	83696	773
0.231	0.22895	10757	79163	77732	354	0.97343	79306	86678	96733	940
0.232	0.22992	43990	72082	45933	437	0.97320	84929	30133	53085	695
0.233	0.23089	74924	40621	22962	869	0.97297	80819	65176	26494	602
0.234	0.23187	03549	11686	80075	884	0.97274	66980	22218	11536	294
0.235	0.23284	29855	12416	78273	112	0.97251	43413	32643	00578	389
0.236	0.23381	53832	70180	65586	809	0.97228	10121	28807	60642	091
0.237	0.23478	75472	12580	74343	904	0.97204	67106	44041	10166	529
0.238	0.23575	94763	67453	18405	752	0.97181	14371	12644	95675	843
0.239	0.23673	11697	62868	90384	520	0.97157	51917	69892	68349	034
0.240	0.23770	26264	27134	58836	079	0.97133	79748	52029	60492	618
0.241	0.23867	38453	88793	65429	334	0.97109	97865	96272	61916	095
0.242	0.23964	48256	76627	22091	869	0.97086	06272	40809	96210	262
0.243	0.24061	55663	19655	08131	828	0.97062	04970	24800	96928	391
0.244	0.24158	60663	47136	67335	933	0.97037	93961	88375	83670	294
0.245	0.24255	63247	88572	05043	522	0.97013	73249	72635	38069	313
0.246	0.24352	63406	73702	85196	546	0.96989	42836	19650	79682	233
0.247	0.24449	61130	32513	27365	389	0.96965	02723	72463	41782	166
0.248	0.24546	56408	95231	03750	445	0.96940	52914	75084	47054	425
0.249	0.24643	49232	92328	36159	337	0.96915	93411	72494	83195	397
0.250	0.24740	39592	54522	92959	685	0.96891	24217	10644	78414	459
			$\left[\begin{smallmatrix} (-8)8 \\ 7 \end{smallmatrix} \right]$						$\left[\begin{smallmatrix} (-7)1 \\ 7 \end{smallmatrix} \right]$	

CIRCULAR SINES AND COSINES FOR RADIAN ARGUMENTS Table 4.6

x	sin x					cos x				
0.250	0.24740	39592	54522	92959	685	0.96891	24217	10644	78414	459
0.251	0.24837	27478	12778	86007	332	0.96866	45333	36453	76838	955
0.252	0.24934	12879	98307	67549	922	0.96841	56762	97810	13822	250
0.253	0.25030	95788	42569	27105	742	0.96816	58508	43570	91154	897
0.254	0.25127	76193	77272	88317	722	0.96791	50572	23561	52178	941
0.255	0.25224	54086	34378	05782	506	0.96766	32956	88575	56805	375
0.256	0.25321	29456	46095	61854	486	0.96741	05664	90374	56434	780
0.257	0.25418	02294	44888	63424	714	0.96715	68698	81687	68781	180
0.258	0.25514	72590	63473	38674	587	0.96690	22061	16211	52599	126
0.259	0.25611	40335	34820	33804	209	0.96664	65754	48609	82314	035
0.260	0.25708	05518	92155	09735	339	0.96638	99781	34513	22555	822
0.261	0.25804	68131	68959	38788	820	0.96613	24144	30519	02595	835
0.262	0.25901	28163	98972	01336	401	0.96587	38845	94190	90687	131
0.263	0.25997	85606	16189	82426	844	0.96561	43888	84058	68308	107
0.264	0.26094	40448	54868	68386	239	0.96535	39275	59618	04309	520
0.265	0.26190	92681	49524	43392	399	0.96509	25008	81330	28964	923
0.266	0.26287	42295	34933	86023	278	0.96483	01091	10622	07924	537
0.267	0.26383	89280	46135	65779	278	0.96456	67525	09885	16072	584
0.268	0.26480	33627	18431	39579	372	0.96430	24313	42476	11288	118
0.269	0.26576	75325	87386	48230	942	0.96403	71458	72716	08109	368
0.270	0.26673	14366	88831	12873	229	0.96377	08963	65890	51301	623
0.271	0.26769	50740	58861	31394	301	0.96350	36830	88248	89328	696
0.272	0.26865	84437	33839	74821	451	0.96323	55063	07004	47727	972
0.273	0.26962	15447	50396	83684	915	0.96296	63662	90334	02389	084
0.274	0.27058	43761	45431	64354	828	0.96269	62633	07377	52736	246
0.275	0.27154	69369	56112	85351	302	0.96242	51976	28237	94814	248
0.276	0.27250	92262	19879	73627	557	0.96215	31695	23980	94278	169
0.277	0.27347	12429	74443	10825	981	0.96188	01792	66634	59286	807
0.278	0.27443	29862	57786	29507	043	0.96160	62271	29189	13299	879
0.279	0.27539	44551	08166	09350	952	0.96133	13133	85596	67778	997
0.280	0.27635	56485	64113	73331	967	0.96105	54383	10770	94792	459
0.281	0.27731	65656	64435	83865	270	0.96077	86021	80586	99523	878
0.282	0.27827	72054	48215	38926	293	0.96050	08052	71880	92684	682
0.283	0.27923	75669	54812	68142	411	0.96022	20478	62449	62830	504
0.284	0.28019	76492	23866	28856	909	0.95994	23302	31050	48581	495
0.285	0.28115	74512	95294	02165	110	0.95966	16526	57401	10746	590
0.286	0.28211	69722	09293	88922	591	0.95938	00154	22179	04351	746
0.287	0.28307	62110	06345	05725	374	0.95909	74188	07021	50572	193
0.288	0.28403	51667	27208	80861	997	0.95881	38630	94525	08568	713
0.289	0.28499	38384	12929	50237	384	0.95852	93485	68245	47227	984
0.290	0.28595	22251	04835	53268	394	0.95824	38755	12697	16807	013
0.291	0.28691	03258	44540	28750	981	0.95795	74442	13353	20481	688
0.292	0.28786	81396	73943	10698	841	0.95767	00549	56644	85799	478
0.293	0.28882	56656	35230	24153	475	0.95738	17080	29961	36036	308
0.294	0.28978	29027	70875	80965	551	0.95709	24037	21649	61457	636
0.295	0.29073	98501	23642	75547	489	0.95680	21423	21013	90483	768
0.296	0.29169	65067	36583	80597	155	0.95651	09241	18315	60759	429
0.297	0.29265	28716	53042	42792	582	0.95621	87494	04772	90127	632
0.298	0.29360	89439	16653	78457	616	0.95592	56184	72560	47507	858
0.299	0.29456	47225	71345	69198	389	0.95563	15316	14809	23678	590
0.300	0.29552	02066	61339	57510	532	0.95533	64891	25606	01964	231
			$\left[\begin{smallmatrix} (-8)4 \\ 7 \end{smallmatrix} \right]$						$\left[\begin{smallmatrix} (-7)1 \\ 7 \end{smallmatrix} \right]$	

Table 4.6 CIRCULAR SINES AND COSINES FOR RADIAN ARGUMENTS

x	sin x					cos x				
0.300	0.29552	02066	61339	57510	532	0.95533	64891	25606	01964	231
0.301	0.29647	53952	31151	42357	025	0.95504	04912	99993	28826	414
0.302	0.29743	02873	25592	74716	586	0.95474	35384	33968	84359	763
0.303	0.29838	48819	89771	53102	518	0.95444	56308	24485	52692	116
0.304	0.29933	91782	69093	19051	897	0.95414	67687	69450	92289	242
0.305	0.30029	31752	09261	52585	026	0.95384	69525	67727	06164	084
0.306	0.30124	68718	56279	67635	045	0.95354	61825	19130	11990	559
0.307	0.30220	02672	56451	07447	613	0.95324	44589	24430	12121	945
0.308	0.30315	33604	56380	39950	549	0.95294	17820	85350	63513	878
0.309	0.30410	61505	02974	53093	365	0.95263	81523	04568	47552	001
0.310	0.30505	86364	43443	50156	564	0.95233	35698	85713	39784	281
0.311	0.30601	08173	25301	45030	632	0.95202	80351	33367	79558	038
0.312	0.30696	26921	96367	57464	615	0.95172	15483	53066	39561	711
0.313	0.30791	42601	04767	08284	189	0.95141	41098	51295	95271	383
0.314	0.30886	55200	98932	14579	138	0.95110	57199	35494	94302	111
0.315	0.30981	64712	27602	84860	120	0.95079	63789	14053	25664	080
0.316	0.31076	71125	39828	14184	658	0.95048	60870	96311	88923	617
0.317	0.31171	74430	84966	79252	234	0.95017	48447	92562	63269	094
0.318	0.31266	74619	12688	33468	402	0.94986	26523	14047	76481	749
0.319	0.31361	71680	72974	01977	833	0.94954	95099	72959	73811	467
0.320	0.31456	65606	16117	76666	176	0.94923	54180	82440	86757	531
0.321	0.31551	56385	92727	11130	659	0.94892	03769	56583	01754	395
0.322	0.31646	44010	53724	15619	332	0.94860	43869	10427	28762	501
0.323	0.31741	28470	50346	51938	844	0.94828	74482	59963	69764	173
0.324	0.31836	09756	34148	28330	674	0.94796	95613	22130	87164	613
0.325	0.31930	87858	57000	94315	718	0.94765	07264	14815	72098	048
0.326	0.32025	62767	71094	35507	128	0.94733	09438	56853	12639	034
0.327	0.32120	34474	28937	68391	319	0.94701	02139	68025	61918	976
0.328	0.32215	02968	83360	35077	048	0.94668	85370	69063	06147	877
0.329	0.32309	68241	87512	98012	460	0.94636	59134	81642	32541	351
0.330	0.32404	30283	94868	34670	020	0.94604	23435	28386	97152	941
0.331	0.32498	89085	59222	32199	224	0.94571	78275	32866	92611	768
0.332	0.32593	44637	34694	82047	011	0.94539	23658	19598	15765	535
0.333	0.32687	96929	75730	74545	756	0.94506	59587	14042	35228	939
0.334	0.32782	45953	37100	93468	777	0.94473	86065	42606	58837	502
0.335	0.32876	91698	73903	10553	241	0.94441	03096	32643	01006	864
0.336	0.32971	34156	41562	79990	386	0.94408	10683	12448	49997	577
0.337	0.33065	73316	95834	32882	957	0.94375	08829	11264	35085	413
0.338	0.33160	09170	92801	71669	766	0.94341	97537	59275	93637	243
0.339	0.33254	41708	88879	64517	288	0.94308	76811	87612	38092	499
0.340	0.33348	70921	40814	39678	177	0.94275	46655	28346	22850	264
0.341	0.33442	96799	05684	79816	635	0.94242	07071	14493	11062	025
0.342	0.33537	19332	40903	16300	519	0.94208	58062	80011	41330	105
0.343	0.33631	38512	04216	23460	104	0.94174	99633	59801	94311	834
0.344	0.33725	54328	53706	12813	399	0.94141	31786	89707	59229	468
0.345	0.33819	66772	47791	27257	928	0.94107	54526	06513	00285	905
0.346	0.33913	75834	45227	35228	880	0.94073	67854	47944	22986	218
0.347	0.34007	81505	05108	24823	531	0.94039	71775	52668	40365	059
0.348	0.34101	83774	86866	97891	850	0.94005	66292	60293	39119	944
0.349	0.34195	82634	50276	64093	188	0.93971	51409	11367	45650	473
0.350	0.34289	78074	55451	34918	963	0.93937	27128	47378	92003	503
			$\left[\begin{smallmatrix} (-8)4 \\ 7 \end{smallmatrix} \right]$						$\left[\begin{smallmatrix} (-7)1 \\ 7 \end{smallmatrix} \right]$	

CIRCULAR SINES AND COSINES FOR RADIAN ARGUMENTS Table 4.6

x	sin x					cos x				
0.350	0.34289	78074	55451	34918	963	0.93937	27128	47378	92003	503
0.351	0.34383	70085	62847	17681	237	0.93902	93454	10755	81724	321
0.352	0.34477	58658	33263	09467	102	0.93868	50389	44865	55613	841
0.353	0.34571	43783	27841	91058	778	0.93833	97937	94014	57391	869
0.354	0.34665	25451	08071	20819	319	0.93799	36103	03447	99266	461
0.355	0.34759	03652	35784	28543	852	0.93764	64888	19349	27409	412
0.356	0.34852	78377	73161	09276	237	0.93729	84296	88839	87337	915
0.357	0.34946	49617	82729	17091	064	0.93694	94332	59978	89202	418
0.358	0.35040	17363	27364	58840	891	0.93659	94998	81762	72980	716
0.359	0.35133	81604	70292	87868	632	0.93624	86299	04124	73578	312
0.360	0.35227	42332	75089	97684	991	0.93589	68236	77934	85835	091
0.361	0.35320	99538	05683	15610	866	0.93554	40815	54999	29438	322
0.362	0.35414	53211	26351	96384	608	0.93519	04038	88060	13742	042
0.363	0.35508	03343	01729	15734	065	0.93483	57910	30795	02492	855
0.364	0.35601	49923	96801	63913	294	0.93448	02433	37816	78462	165
0.365	0.35694	92944	76911	39203	863	0.93412	37611	64673	07984	897
0.366	0.35788	32396	07756	41380	647	0.93376	63448	67846	05404	739
0.367	0.35881	68268	55391	65142	021	0.93340	79948	04751	97425	922
0.368	0.35975	00552	86229	93504	354	0.93304	87113	33740	87371	606
0.369	0.36068	29239	67042	91160	721	0.93268	84948	14096	19348	871
0.370	0.36161	54319	64961	97803	729	0.93232	73456	06034	42320	381
0.371	0.36254	75783	47479	21412	373	0.93196	52640	70704	74082	737
0.372	0.36347	93621	82448	31502	813	0.93160	22505	70188	65151	560
0.373	0.36441	07825	38085	52343	006	0.93123	83054	67499	62553	347
0.374	0.36534	18384	82970	56131	067	0.93087	34291	26582	73524	125
0.375	0.36627	25290	86047	56137	291	0.93050	76219	12314	29114	948
0.376	0.36720	28534	16625	99809	733	0.93014	08841	90501	47704	265
0.377	0.36813	28105	44381	61843	251	0.92977	32163	27881	98417	211
0.378	0.36906	23995	39357	37211	926	0.92940	46186	92123	64451	836
0.379	0.36999	16194	71964	34164	758	0.92903	50916	51824	06312	328
0.380	0.37092	04694	12982	67184	549	0.92866	46355	76510	24949	253
0.381	0.37184	89484	33562	49909	881	0.92829	32508	36638	24806	858
0.382	0.37277	70556	05224	88020	096	0.92792	09378	03592	76777	471
0.383	0.37370	47899	99862	72083	184	0.92754	76968	49686	81063	030
0.384	0.37463	21506	89741	70366	479	0.92717	35283	48161	29943	792
0.385	0.37555	91367	47501	21610	089	0.92679	84326	73184	70454	235
0.386	0.37648	57472	46155	27762	945	0.92642	24101	99852	66966	223
0.387	0.37741	19812	59093	46681	397	0.92604	54613	04187	63679	438
0.388	0.37833	78378	60081	84790	240	0.92566	75863	63138	47019	143
0.389	0.37926	33161	23263	89706	110	0.92528	87857	54580	07941	297
0.390	0.38018	84151	23161	42823	118	0.92490	90598	57313	04145	068
0.391	0.38111	31339	34675	51860	671	0.92452	84090	51063	22192	776
0.392	0.38203	74716	33087	43373	349	0.92414	68337	16481	39537	314
0.393	0.38296	14272	94059	55222	774	0.92376	43342	35142	86457	070
0.394	0.38388	49999	93636	29011	366	0.92338	09109	89547	07898	401
0.395	0.38480	81888	08245	02477	888	0.92299	65643	63117	25225	693
0.396	0.38573	09928	14697	01854	707	0.92261	12947	40199	97879	040
0.397	0.38665	34110	90188	34186	658	0.92222	51025	06064	84939	589
0.398	0.38757	54427	12300	79611	426	0.92183	79880	46904	06602	584
0.399	0.38849	70867	59002	83601	363	0.92144	99517	49832	05558	150
0.400	0.38941	83423	08650	49166	631	0.92106	09940	02885	08279	853
			$\left[\begin{smallmatrix} (-8)5 \\ 7 \end{smallmatrix} \right]$						$\left[\begin{smallmatrix} (-7)1 \\ 7 \end{smallmatrix} \right]$	

Table 4.6 CIRCULAR SINES AND COSINES FOR RADIAN ARGUMENTS

x	sin x					cos x				
0.400	0.38941	83423	08650	49166	631	0.92106	09940	02885	08279	853
0.401	0.39033	92084	39988	29019	595	0.92067	11151	95020	86221	075
0.402	0.39125	96842	32150	17700	358	0.92028	03157	16118	16919	248
0.403	0.39217	97687	64660	43663	363	0.91988	85959	56976	45007	979
0.404	0.39309	94611	17434	61324	955	0.91949	59563	09315	43137	110
0.405	0.39401	87603	70780	43071	820	0.91910	23971	65774	72800	745
0.406	0.39493	76656	05398	71230	202	0.91870	79189	19913	45073	295
0.407	0.39585	61759	02384	29995	816	0.91831	25219	66209	81253	568
0.408	0.39677	42903	43226	97324	356	0.91791	62067	00060	73416	956
0.409	0.39769	20080	09812	36782	508	0.91751	89735	17781	44875	737
0.410	0.39860	93279	84422	89359	380	0.91712	08228	16605	10547	564
0.411	0.39952	62493	49738	65238	251	0.91672	17549	94682	37232	150
0.412	0.40044	27711	88838	35528	558	0.91632	17704	51081	03796	202
0.413	0.40135	88925	85200	23958	010	0.91592	08695	85785	61266	649
0.414	0.40227	46126	22702	98524	766	0.91551	90527	99696	92832	194
0.415	0.40318	99303	85626	63109	550	0.91511	63204	94631	73753	232
0.416	0.40410	48449	58653	49047	645	0.91471	26730	73322	31180	180
0.417	0.40501	93554	26869	06660	654	0.91430	81109	39416	03880	251
0.418	0.40593	34608	75762	96747	939	0.91390	26344	97475	01872	722
0.419	0.40684	71603	91229	82037	655	0.91349	62441	52975	65972	725
0.420	0.40776	04530	59570	18597	279	0.91308	89403	12308	27243	609
0.421	0.40867	33379	67491	47203	546	0.91268	07233	82776	66357	915
0.422	0.40958	58142	02108	84671	703	0.91227	15937	72597	72866	996
0.423	0.41049	78808	50946	15143	980	0.91186	15518	90901	04379	332
0.424	0.41140	95370	01936	81337	201	0.91145	05981	47728	45647	576
0.425	0.41232	07817	43424	75749	435	0.91103	87329	54033	67564	373
0.426	0.41323	16141	64165	31825	593	0.91062	59567	21681	86066	990
0.427	0.41414	20333	53326	15081	889	0.91021	22698	63449	20950	808
0.428	0.41505	20384	00488	14189	067	0.90979	76727	93022	54591	701
0.429	0.41596	16283	95646	32014	301	0.90938	21659	24998	90577	360
0.430	0.41687	08024	29210	76621	692	0.90896	57496	74885	12247	591
0.431	0.41777	95595	92007	52231	243	0.90854	84244	59097	41143	638
0.432	0.41868	78989	75279	50136	257	0.90813	01906	94960	95366	563
0.433	0.41959	58196	70687	39579	028	0.90771	10488	00709	47844	729
0.434	0.42050	33207	70310	58584	774	0.90729	09991	95484	84510	435
0.435	0.42141	04013	66648	04753	684	0.90687	00422	99336	62385	731
0.436	0.42231	70605	52619	26011	018	0.90644	81785	33221	67577	465
0.437	0.42322	32974	21565	11315	146	0.90602	54083	19003	73181	601
0.438	0.42412	91110	67248	81323	456	0.90560	17320	79452	97096	848
0.439	0.42503	45005	83856	79016	027	0.90517	71502	38245	59747	647
0.440	0.42593	94650	65999	60276	972	0.90475	16632	19963	41716	554
0.441	0.42684	40036	08712	84433	381	0.90432	52714	50093	41286	061
0.442	0.42774	81153	07458	04751	750	0.90389	79753	55027	31889	904
0.443	0.42865	17992	58123	58891	823	0.90346	97753	62061	19473	892
0.444	0.42955	50545	57025	59317	745	0.90304	06718	99394	99766	305
0.445	0.43045	78803	00908	83666	443	0.90261	06653	96132	15457	899
0.446	0.43136	02755	86947	65073	141	0.90217	97562	82279	13291	573
0.447	0.43226	22395	12746	82453	917	0.90174	79449	88745	01061	718
0.448	0.43316	37711	76342	50745	219	0.90131	52319	47341	04523	319
0.449	0.43406	48696	76203	11100	244	0.90088	16175	90780	24210	832
0.450	0.43496	55341	11230	21042	084	0.90044	71023	52676	92166	884
			$\left[\begin{smallmatrix} (-8)5 \\ 7 \end{smallmatrix} \right]$						$\left[\begin{smallmatrix} (-7)1 \\ 7 \end{smallmatrix} \right]$	

CIRCULAR SINES AND COSINES FOR RADIAN ARGUMENTS Table 4.6

x	sin x					cos x				
0.450	0.43496	55341	11230	21042	084	0.90044	71023	52676	92166	884
0.451	0.43586	57635	80759	44573	567	0.90001	16866	67546	28580	847
0.452	0.43676	55571	84561	42243	681	0.89957	53709	70803	98337	319
0.453	0.43766	49140	22842	61170	507	0.89913	81556	98765	67474	569
0.454	0.43856	38331	96246	25020	568	0.89870	00412	88646	59552	965
0.455	0.43946	23138	05853	23944	492	0.89826	10281	78561	11933	463
0.456	0.44036	03549	53183	04468	918	0.89782	11168	07522	31966	167
0.457	0.44125	79557	40194	59344	542	0.89738	03076	15441	53089	030
0.458	0.44215	51152	69287	17350	215	0.89693	86010	43127	90836	721
0.459	0.44305	18326	43301	33053	008	0.89649	59975	32287	98759	714
0.460	0.44394	81069	65519	76524	151	0.89605	24975	25525	24253	639
0.461	0.44484	39373	39668	23010	752	0.89560	81014	66339	64298	937
0.462	0.44573	93228	69916	42563	218	0.89516	28097	99127	21110	867
0.463	0.44663	42626	60878	89618	275	0.89471	66229	69179	57699	908
0.464	0.44752	87558	17615	92537	506	0.89426	95414	22683	53342	602
0.465	0.44842	28014	45634	43101	319	0.89382	15656	06720	58962	873
0.466	0.44931	63986	50888	85958	244	0.89337	26959	69266	52423	883
0.467	0.45020	95465	39782	08029	479	0.89292	29329	59190	93730	459
0.468	0.45110	22442	19166	27868	603	0.89247	22770	26256	80142	134
0.469	0.45199	44907	96343	84976	342	0.89202	07286	21120	01196	857
0.470	0.45288	62853	79068	29070	327	0.89156	82881	95328	93645	402
0.471	0.45377	76270	75545	09309	736	0.89111	49562	01323	96296	541
0.472	0.45466	85149	94432	63474	735	0.89066	07330	92437	04773	005
0.473	0.45555	89482	44843	07100	635	0.89020	56193	22891	26178	292
0.474	0.45644	89259	36343	22566	671	0.88974	96153	47800	33674	367
0.475	0.45733	84471	78955	48139	307	0.88929	27216	23168	20970	288
0.476	0.45822	75110	83158	66969	994	0.88883	49386	05888	56721	822
0.477	0.45911	61167	59888	96047	279	0.88837	62667	53744	38842	074
0.478	0.46000	42633	20540	75103	180	0.88791	67065	25407	48723	197
0.479	0.46089	19498	76967	55473	739	0.88745	62583	80438	05369	212
0.480	0.46177	91755	41482	88913	664	0.88699	49227	79284	19439	995
0.481	0.46266	59394	26861	16364	968	0.88653	27001	83281	47206	469
0.482	0.46355	22406	46338	56679	522	0.88606	95910	54652	44417	051
0.483	0.46443	80783	13613	95295	430	0.88560	55958	56506	20075	401
0.484	0.46532	34515	42849	72867	132	0.88514	07150	52837	90129	517
0.485	0.46620	83594	48672	73849	162	0.88467	49491	08528	31072	223
0.486	0.46709	28011	46175	15033	451	0.88420	82984	89343	33453	094
0.487	0.46797	67757	50915	34040	104	0.88374	07636	61933	55301	874
0.488	0.46886	02823	78918	77761	558	0.88327	23450	93833	75463	416
0.489	0.46974	33201	46678	90760	024	0.88280	30432	53462	46844	214
0.490	0.47062	58881	71158	03618	136	0.88233	28586	10121	49570	547
0.491	0.47150	79855	69788	21242	715	0.88186	17916	33995	44058	307
0.492	0.47238	96114	60472	11121	556	0.88138	98427	96151	23994	541
0.493	0.47327	07649	61583	91533	149	0.88091	70125	68537	69230	763
0.494	0.47415	14451	91970	19709	261	0.88044	33014	23984	98588	075
0.495	0.47503	16512	70950	79950	264	0.87996	87098	36204	22574	157
0.496	0.47591	13823	18319	71693	150	0.87949	32382	79786	96012	154
0.497	0.47679	06374	54345	97532	118	0.87901	68872	30204	70581	529
0.498	0.47766	94157	99774	51191	668	0.87853	96571	63808	47270	917
0.499	0.47854	77164	75827	05452	099	0.87806	15485	57828	28743	023
0.500	0.47942	55386	04203	00027	329	0.87758	25618	90372	71611	628
			$\left[\begin{matrix} (-8)6 \\ 7 \end{matrix} \right]$					$\left[\begin{matrix} (-7)1 \\ 7 \end{matrix} \right]$		

Table 4.6 CIRCULAR SINES AND COSINES FOR RADIAN ARGUMENTS

x	sin x					cos x				
0.500	0.47942	55386	04203	00027	329	0.87758	25618	90372	71611	628
0.501	0.48030	28813	07080	29394	947	0.87710	26976	40428	38630	733
0.502	0.48117	97437	07116	30578	414	0.87662	19562	87859	50795	903
0.503	0.48205	61249	27448	70881	314	0.87614	03383	13407	39357	847
0.504	0.48293	20240	91696	35573	583	0.87565	78441	98689	97748	295
0.505	0.48380	74403	23960	15529	617	0.87517	44744	26201	33418	203
0.506	0.48468	23727	48823	94818	170	0.87469	02294	79311	19588	355
0.507	0.48555	68204	91355	38243	967	0.87420	51098	42264	46912	391
0.508	0.48643	07826	77106	78840	928	0.87371	91160	00180	75052	318
0.509	0.48730	42584	32116	05316	931	0.87323	22484	39053	84166	561
0.510	0.48817	72468	82907	49450	013	0.87274	45076	45751	26310	581
0.511	0.48904	97471	56492	73435	934	0.87225	58941	08013	76750	129
0.512	0.48992	17583	80371	57187	006	0.87176	64083	14454	85187	176
0.513	0.49079	32796	82532	85582	104	0.87127	60507	54560	26898	565
0.514	0.49166	43101	91455	35667	778	0.87078	48219	18687	53787	441
0.515	0.49253	48490	36108	63810	364	0.87029	27222	98065	45347	504
0.516	0.49340	48953	45953	92799	025	0.86979	97523	84793	59540	132
0.517	0.49427	44482	50944	98899	617	0.86930	59126	71841	83584	429
0.518	0.49514	35068	81528	98859	309	0.86881	12036	53049	84660	240
0.519	0.49601	20703	68647	36861	855	0.86831	56258	23126	60524	189
0.520	0.49688	01378	43736	71433	446	0.86781	91796	77649	90038	785
0.521	0.49774	77084	38729	62299	043	0.86732	18657	13065	83614	647
0.522	0.49861	47812	86055	57189	109	0.86682	36844	26688	33565	898
0.523	0.49948	13555	18641	78596	658	0.86632	46363	16698	64378	779
0.524	0.50034	74302	69914	10484	518	0.86582	47218	82144	82893	524
0.525	0.50121	30046	73797	84942	748	0.86532	39416	22941	28399	561
0.526	0.50207	80778	64718	68796	092	0.86482	22960	39868	22644	077
0.527	0.50294	26489	77603	50161	411	0.86431	97856	34571	19753	996
0.528	0.50380	67171	47881	24954	981	0.86381	64109	09560	56071	436
0.529	0.50467	02815	11483	83349	596	0.86331	21723	68210	99902	671
0.530	0.50553	33412	04846	96181	366	0.86280	70705	14761	01180	670
0.531	0.50639	58953	64911	01306	143	0.86230	11058	54312	41041	248
0.532	0.50725	79431	29121	89905	473	0.86179	42788	92829	81312	894
0.533	0.50811	94836	35431	92741	999	0.86128	65901	37140	13920	311
0.534	0.50898	05160	22300	66364	220	0.86077	80400	94932	10201	726
0.535	0.50984	10394	28695	79260	534	0.86026	86292	74755	70140	025
0.536	0.51070	10529	94093	97962	456	0.85975	83581	86021	71507	760
0.537	0.51156	05558	58481	73096	946	0.85924	72273	39001	18926	068
0.538	0.51241	95471	62356	25387	754	0.85873	52372	44824	92837	581
0.539	0.51327	80260	46726	31605	686	0.85822	23884	15482	98393	339
0.540	0.51413	59916	53113	10467	728	0.85770	86813	63824	14253	797
0.541	0.51499	34431	23551	08484	914	0.85719	41166	03555	41303	947
0.542	0.51585	03796	00588	85758	874	0.85667	86946	49241	51282	623
0.543	0.51670	68002	27290	01726	969	0.85616	24160	16304	35326	032
0.544	0.51756	27041	47234	00855	920	0.85564	52812	21022	52425	567
0.545	0.51841	80905	04516	98283	861	0.85512	72907	80530	77799	957
0.546	0.51927	29584	43752	65410	714	0.85460	84452	12819	51181	787
0.547	0.52012	73071	10073	15436	812	0.85408	87450	36734	25018	472
0.548	0.52098	11356	49129	88849	675	0.85356	81907	71975	12587	703
0.549	0.52183	44432	07094	38858	868	0.85304	67829	39096	36027	442
0.550	0.52268	72289	30659	16778	838	0.85252	45220	59505	74280	498
			$\left[\begin{smallmatrix} (-8)7 \\ 7 \end{smallmatrix} \right]$						$\left[\begin{smallmatrix} (-7)1 \\ 7 \end{smallmatrix} \right]$	

CIRCULAR SINES AND COSINES FOR RADIAN ARGUMENTS Table 4.6

x	sin x					cos x				
0.550	0.52268	72289	30659	16778	838	0.85252	45220	59505	74280	498
0.551	0.52353	94919	67038	57359	653	0.85200	14086	55464	10953	761
0.552	0.52439	12314	63969	64065	565	0.85147	74432	50084	82092	114
0.553	0.52524	24465	69712	94301	297	0.85095	26263	67333	23867	110
0.554	0.52609	31364	33053	44585	976	0.85042	69585	32026	20180	431
0.555	0.52694	33002	03301	35674	635	0.84990	04402	69831	50182	218
0.556	0.52779	29370	30292	97627	180	0.84937	30721	07267	35704	287
0.557	0.52864	20460	64391	54824	757	0.84884	48545	71701	88608	318
0.558	0.52949	06264	56488	10933	415	0.84831	57881	91352	58049	047
0.559	0.53033	86773	58002	33815	002	0.84778	58734	95285	77652	517
0.560	0.53118	61979	20883	40385	187	0.84725	51110	13416	12609	452
0.561	0.53203	31872	97610	81418	533	0.84672	35012	76506	06683	799
0.562	0.53287	96446	41195	26300	543	0.84619	10448	16165	29136	481
0.563	0.53372	55691	05179	47726	585	0.84565	77421	64850	21564	438
0.564	0.53457	09598	43639	06347	607	0.84512	35938	55863	44654	991
0.565	0.53541	58160	11183	35362	572	0.84458	86004	23353	24855	579
0.566	0.53626	01367	62956	25057	521	0.84405	27624	02313	00958	945
0.567	0.53710	39212	54637	07291	168	0.84351	60803	28580	70603	796
0.568	0.53794	71686	42441	39926	969	0.84297	85547	38838	36691	011
0.569	0.53878	98780	83121	91211	553	0.84244	01861	70611	53715	445
0.570	0.53963	20487	33969	24099	446	0.84190	09751	62268	74013	376
0.571	0.54047	36797	52812	80524	005	0.84136	09222	53020	93925	658
0.572	0.54131	47702	98021	65614	465	0.84082	00279	82920	99876	632
0.573	0.54215	53195	28505	31859	028	0.84027	82928	92863	14368	839
0.574	0.54299	53266	03714	63213	905	0.83973	57175	24582	41893	605
0.575	0.54383	47906	83642	59158	222	0.83919	23024	20654	14757	543
0.576	0.54467	37109	28825	18694	718	0.83864	80481	24493	38825	019
0.577	0.54551	20865	00342	24296	136	0.83810	29551	80354	39176	658
0.578	0.54634	99165	59818	25797	231	0.83755	70241	33330	05683	918
0.579	0.54718	72002	69423	24232	321	0.83701	02555	29351	38499	807
0.580	0.54802	39367	91873	55618	270	0.83646	26499	15186	93465	789
0.581	0.54886	01252	90432	74682	851	0.83591	42078	38442	27434	927
0.582	0.54969	57649	28912	38538	382	0.83536	49298	47559	43511	337
0.583	0.55053	08548	71672	90300	563	0.83481	48164	91816	36205	988
0.584	0.55136	53942	83624	42652	424	0.83426	38683	21326	36508	907
0.585	0.55219	93823	30227	61353	309	0.83371	20858	87037	56877	861
0.586	0.55303	28181	77494	48692	799	0.83315	94697	40732	36143	543
0.587	0.55386	57009	91989	26889	504	0.83260	60204	35026	84331	337
0.588	0.55469	80299	40829	21434	637	0.83205	17385	23370	27399	720
0.589	0.55552	98041	91685	44380	278	0.83149	66245	60044	51895	332
0.590	0.55636	10229	12783	77572	254	0.83094	06791	00163	49524	800
0.591	0.55719	16852	72905	55827	556	0.83038	39026	99672	61643	346
0.592	0.55802	17904	41388	50056	192	0.82982	62959	15348	23660	255
0.593	0.55885	13375	88127	50327	409	0.82926	78593	04797	09361	243
0.594	0.55968	03258	83575	48880	201	0.82870	85934	26455	75147	786
0.595	0.56050	87544	98744	23078	004	0.82814	84988	39590	04193	468
0.596	0.56133	66226	05205	18307	516	0.82758	75761	04294	50517	407
0.597	0.56216	39293	75090	30821	541	0.82702	58257	81491	82974	799
0.598	0.56299	06739	81092	90525	792	0.82646	32484	32932	29164	660
0.599	0.56381	68555	96468	43709	545	0.82589	98446	21193	19254	799
0.600	0.56464	24733	95035	35720	095	0.82533	56149	09678	29724	095
			$\left[\begin{smallmatrix} (-8)7 \\ 7 \end{smallmatrix} \right]$						$\left[\begin{smallmatrix} (-7)1 \\ 7 \end{smallmatrix} \right]$	

Table 4.6 CIRCULAR SINES AND COSINES FOR RADIAN ARGUMENTS

x	sin x					cos x				
0.600	0.56464	24733	95035	35720	095	0.82533	56149	09678	29724	095
0.601	0.56546	75265	51175	93580	897	0.82477	05598	62617	27022	123
0.602	0.56629	20142	39837	08553	336	0.82420	46800	45065	11146	193
0.603	0.56711	59356	36531	18642	028	0.82363	79760	22901	59135	858
0.604	0.56793	92899	17336	91043	574	0.82307	04483	62830	68484	934
0.605	0.56876	20762	58900	04538	687	0.82250	20976	32380	00471	116
0.606	0.56958	42938	38434	31827	607	0.82193	29243	99900	23403	216
0.607	0.57040	59418	33722	21808	719	0.82136	29292	34564	55786	102
0.608	0.57122	70194	23115	81800	299	0.82079	21127	06368	09403	380
0.609	0.57204	75257	85537	59705	300	0.82022	04753	86127	32317	893
0.610	0.57286	74601	00481	26119	098	0.81964	80178	45479	51790	075
0.611	0.57368	68215	48012	56380	111	0.81907	47406	56882	17114	225
0.612	0.57450	56093	08770	12563	221	0.81850	06443	93612	42372	770
0.613	0.57532	38225	63966	25415	904	0.81792	57296	29766	49108	549
0.614	0.57614	14604	95387	76236	989	0.81734	99969	40259	08915	198
0.615	0.57695	85222	85396	78697	975	0.81677	34469	00822	85945	685
0.616	0.57777	50071	16931	60606	809	0.81619	60800	88007	79339	051
0.617	0.57859	09141	73507	45614	047	0.81561	78970	79180	65565	411
0.618	0.57940	62426	39217	34861	330	0.81503	88984	52524	40689	288
0.619	0.58022	09916	98732	88572	073	0.81445	90847	87037	62551	318
0.620	0.58103	51605	37305	07584	296	0.81387	84566	62533	92868	400
0.621	0.58184	87483	40765	14825	522	0.81329	70146	59641	39252	335
0.622	0.58266	17542	95525	36729	641	0.81271	47593	59801	97147	027
0.623	0.58347	41775	88579	84595	681	0.81213	16913	45270	91684	290
0.624	0.58428	60174	07505	35888	387	0.81154	78111	99116	19458	331
0.625	0.58509	72729	40462	15480	540	0.81096	31195	05217	90218	953
0.626	0.58590	79433	76194	76836	923	0.81037	76168	48267	68483	556
0.627	0.58671	80279	04032	83139	861	0.80979	13038	13768	15067	973
0.628	0.58752	75257	13891	88356	252	0.80920	41809	88032	28536	214
0.629	0.58833	64359	96274	18246	006	0.80861	62489	58182	86569	178
0.630	0.58914	47579	42269	51311	811	0.80802	75083	12151	87252	371
0.631	0.58995	24907	43555	99690	151	0.80743	79596	38679	90282	722
0.632	0.59075	96335	92400	89983	484	0.80684	76035	27315	58094	522
0.633	0.59156	61856	81661	44033	509	0.80625	64405	68414	96904	569
0.634	0.59237	21462	04785	59635	440	0.80566	44713	53140	97676	566
0.635	0.59317	75143	55812	91193	198	0.80507	16964	73462	77004	837
0.636	0.59398	22893	29375	30315	454	0.80447	81165	22155	17917	411
0.637	0.59478	64703	20697	86352	425	0.80388	37320	92798	10598	548
0.638	0.59559	00565	25599	66873	364	0.80328	85437	79775	93030	752
0.639	0.59639	30471	40494	58084	641	0.80269	25521	78276	91556	338
0.640	0.59719	54413	62392	05188	355	0.80209	57578	84292	61358	611
0.641	0.59799	72383	88897	92681	375	0.80149	81614	94617	26862	715
0.642	0.59879	84374	18215	24594	757	0.80089	97636	06847	22056	216
0.643	0.59959	90376	49145	04673	426	0.80030	05648	19380	30729	469
0.644	0.60039	90382	81087	16496	070	0.79970	05657	31415	26635	842
0.645	0.60119	84385	14041	03535	151	0.79909	97669	42951	13571	848
0.646	0.60199	72375	48606	49156	949	0.79849	81690	54786	65377	243
0.647	0.60279	54345	85984	56561	576	0.79789	57726	68519	65855	159
0.648	0.60359	30288	27978	28662	868	0.79729	25783	86546	48612	327
0.649	0.60439	00194	76993	47908	070	0.79668	85868	12061	36819	444
0.650	0.60518	64057	36039	56037	252	0.79608	37985	49055	82891	760
			$\left[\begin{smallmatrix} (-8)8 \\ 7 \end{smallmatrix} \right]$						$\left[\begin{smallmatrix} (-7)1 \\ 7 \end{smallmatrix} \right]$	

CIRCULAR SINES AND COSINES FOR RADIAN ARGUMENTS Table 4.6

x	sin x					cos x				
0.650	0.60518	64057	36039	56037	252	0.79608	37985	49055	82891	760
0.651	0.60598	21868	08730	33782	358	0.79547	82142	02318	08089	927
0.652	0.60677	73618	99284	80505	818	0.79487	18343	77432	42041	183
0.653	0.60757	19302	12527	93778	646	0.79426	46596	80778	62180	929
0.654	0.60836	58909	53891	48897	929	0.79365	66907	19531	33114	757
0.655	0.60915	92433	29414	78343	652	0.79304	79281	01659	45900	987
0.656	0.60995	19865	45745	51174	755	0.79243	83724	35925	57253	785
0.657	0.61074	41198	10140	52364	359	0.79182	80243	31885	28666	909
0.658	0.61153	56423	30466	62074	073	0.79121	68843	99886	65458	154
0.659	0.61232	65533	15201	34867	307	0.79060	49532	51069	55734	550
0.660	0.61311	68519	73433	78861	515	0.78999	22314	97365	09278	382
0.661	0.61390	65375	14865	34819	272	0.78937	87197	51494	96354	080
0.662	0.61469	56091	49810	55178	137	0.78876	44186	26970	86436	061
0.663	0.61548	40660	89197	83019	186	0.78814	93287	38093	86857	558
0.664	0.61627	19075	44570	30974	165	0.78753	34506	99953	81380	523
0.665	0.61705	91327	28086	60071	171	0.78691	67851	28428	68686	643
0.666	0.61784	57408	52521	58518	785	0.78629	93326	40184	00789	551
0.667	0.61863	17311	31267	20428	576	0.78568	10938	52672	21368	279
0.668	0.61941	71027	78333	24475	901	0.78506	20693	84132	04022	017
0.669	0.62020	18550	08348	12498	919	0.78444	22598	53587	90446	244
0.670	0.62098	59870	36559	68035	744	0.78382	16658	80849	28530	294
0.671	0.62176	94980	78835	94799	654	0.78320	02880	86510	10376	414
0.672	0.62255	23873	51665	95092	281	0.78257	81270	91948	10240	374
0.673	0.62333	46540	72160	48154	700	0.78195	51835	19324	22393	698
0.674	0.62411	62974	58052	88456	349	0.78133	14579	91581	98907	578
0.675	0.62489	73167	27699	83921	682	0.78070	69511	32446	87358	526
0.676	0.62567	77111	00082	14094	496	0.78008	16635	66425	68455	830
0.677	0.62645	74797	94805	48239	849	0.77945	55959	18805	93590	877
0.678	0.62723	66220	32101	23383	477	0.77882	87488	15655	22308	414
0.679	0.62801	51370	32827	22288	658	0.77820	11228	83820	59699	786
0.680	0.62879	30240	18468	51370	418	0.77757	27187	50927	93718	239
0.681	0.62957	02822	11138	18547	018	0.77694	35370	45381	32416	339
0.682	0.63034	69108	33578	11028	644	0.77631	35783	96362	41105	566
0.683	0.63112	29091	09159	73043	207	0.77568	28434	33829	79438	156
0.684	0.63189	82762	61884	83499	197	0.77505	13327	88518	38411	247
0.685	0.63267	30115	16386	33585	498	0.77441	90470	91938	77293	390
0.686	0.63344	71140	97929	04308	084	0.77378	59869	76376	60473	500
0.687	0.63422	05832	32410	43963	542	0.77315	21530	74891	94232	293
0.688	0.63499	34181	46361	45549	306	0.77251	75460	21318	63436	286
0.689	0.63576	56180	66947	24110	566	0.77188	21664	50263	68154	418
0.690	0.63653	71822	21967	94023	743	0.77124	60149	97106	60197	354
0.691	0.63730	81098	39859	46216	467	0.77060	90922	97998	79579	541
0.692	0.63807	84001	49694	25323	984	0.76997	13989	89862	90904	069
0.693	0.63884	80523	81182	06781	899	0.76933	29357	10392	19670	418
0.694	0.63961	70657	64670	73855	200	0.76869	37030	98049	88505	132
0.695	0.64038	54395	31146	94603	464	0.76805	37017	92068	53315	502
0.696	0.64115	31729	12236	98782	185	0.76741	29324	32449	39366	321
0.697	0.64192	02651	40207	54680	136	0.76677	13956	59961	77279	757
0.698	0.64268	67154	47966	45892	698	0.76612	90921	16142	38958	434
0.699	0.64345	25230	69063	48031	063	0.76548	60224	43294	73431	759
0.700	0.64421	76872	37691	05367	261	0.76484	21872	84488	42625	586
			$\left[\begin{smallmatrix} (-8)8 \\ 7 \end{smallmatrix} \right]$						$\left[\begin{smallmatrix} (-7)1 \\ 7 \end{smallmatrix} \right]$	

Table 4.6 CIRCULAR SINES AND COSINES FOR RADIAN ARGUMENTS

x	$\sin x$					$\cos x$				
0.700	0.64421	76872	37691	05367	261	0.76484	21872	84488	42625	586
0.701	0.64498	22071	88685	07414	902	0.76419	75872	83558	57055	252
0.702	0.64574	60821	57525	65445	583	0.76355	22230	85105	11442	075
0.703	0.64650	93113	80337	88940	870	0.76290	60953	34492	20253	368
0.704	0.64727	18940	93892	61979	783	0.76225	92046	77847	53166	023
0.705	0.64803	38295	35607	19561	705	0.76161	15517	62061	70453	752
0.706	0.64879	51169	43546	23864	641	0.76096	31372	34787	58298	030
0.707	0.64955	57555	56422	40438	747	0.76031	39617	44439	64022	815
0.708	0.65031	57446	13597	14335	062	0.75966	40259	40193	31253	107
0.709	0.65107	50833	55081	46169	354	0.75901	33304	71984	34997	406
0.710	0.65183	37710	21536	68121	013	0.75836	18759	90508	16654	146
0.711	0.65259	18068	54275	19866	915	0.75770	96631	47219	18942	159
0.712	0.65334	91900	95261	24450	173	0.75705	66925	94330	20755	235
0.713	0.65410	59199	87111	64083	709	0.75640	29649	84811	71940	852
0.714	0.65486	19957	73096	55888	565	0.75574	84809	72391	28003	128
0.715	0.65561	74166	97140	27566	883	0.75509	32412	11552	84730	074
0.716	0.65637	21820	03821	93009	463	0.75443	72463	57536	12745	203
0.717	0.65712	62909	38376	27837	851	0.75378	04970	66335	91983	563
0.718	0.65787	97427	46694	44880	853	0.75312	29939	94701	46092	263
0.719	0.65863	25366	75324	69585	417	0.75246	47378	00135	76755	558
0.720	0.65938	46719	71473	15361	800	0.75180	57291	40894	97944	549
0.721	0.66013	61478	83004	58862	952	0.75114	59686	75987	70091	576
0.722	0.66088	69636	58443	15198	027	0.75048	54570	65174	34189	363
0.723	0.66163	71185	46973	13079	967	0.74982	41949	68966	45814	983
0.724	0.66238	66117	98439	69907	065	0.74916	21830	48626	09078	707
0.725	0.66313	54426	63349	66778	441	0.74849	94219	66165	10497	806
0.726	0.66388	36103	92872	23443	354	0.74783	59123	84344	52795	369
0.727	0.66463	11142	38839	73184	280	0.74717	16549	66673	88624	209
0.728	0.66537	79534	53748	37633	666	0.74650	66503	77410	54215	910
0.729	0.66612	41272	90759	01524	309	0.74584	08992	81559	02955	103
0.730	0.66686	96350	03697	87373	259	0.74517	44023	44870	38879	013
0.731	0.66761	44758	47057	30099	195	0.74450	71602	33841	50102	364
0.732	0.66835	86490	75996	51573	181	0.74383	91736	15714	42167	693
0.733	0.66910	21539	46342	35102	739	0.74317	04431	58475	71321	153
0.734	0.66984	49897	14589	99849	159	0.74250	09695	30855	77713	862
0.735	0.67058	71556	37903	75177	973	0.74183	07534	02328	18528	866
0.736	0.67132	86509	74117	74942	523	0.74115	97954	43109	01033	791
0.737	0.67206	94749	81736	71700	537	0.74048	80963	24156	15559	237
0.738	0.67280	96269	19936	70863	650	0.73981	56567	17168	68402	998
0.739	0.67354	91060	48565	84779	796	0.73914	24772	94586	14660	158
0.740	0.67428	79116	28145	06748	388	0.73846	85587	29587	90979	142
0.741	0.67502	60429	19868	84968	216	0.73779	39016	96092	48243	787
0.742	0.67576	34991	85605	96417	996	0.73711	85068	68756	84181	492
0.743	0.67650	02796	87900	20669	485	0.73644	23749	22975	75897	532
0.744	0.67723	63836	89971	13633	096	0.73576	55065	34881	12335	582
0.745	0.67797	18104	55714	81235	936	0.73508	79023	81341	26664	537
0.746	0.67870	65592	49704	53032	193	0.73440	95631	39960	28591	681
0.747	0.67944	06293	37191	55745	803	0.73373	04894	89077	36602	285
0.748	0.68017	40199	84105	86745	313	0.73305	06821	07766	10125	695
0.749	0.68090	67304	57056	87450	880	0.73237	01416	75833	81627	975
0.750	0.68163	87600	23334	16673	324	0.73168	88688	73820	88631	184

$$\left[\begin{matrix} (-8)9 \\ 7 \end{matrix} \right]$$

$$\left[\begin{matrix} (-7)1 \\ 7 \end{matrix} \right]$$

CIRCULAR SINES AND COSINES FOR RADIAN ARGUMENTS Table 4.6

x	sin x						cos x					
0.750	0.68163	87600	23334	16673	324	0.73168	88688	73820	88631	184		
0.751	0.68237	01079	50908	23885	163	0.73100	68643	83000	05659	342		
0.752	0.68310	07735	08431	22423	554	0.73032	41288	85375	76111	160		
0.753	0.68383	07559	65237	62625	080	0.72964	06630	63683	44059	608		
0.754	0.68456	00545	91345	04892	285	0.72895	64676	01388	85978	367		
0.755	0.68528	86686	57454	92691	917	0.72827	15431	82687	42395	268		
0.756	0.68601	65974	34953	25484	772	0.72758	58904	92503	49472	750		
0.757	0.68674	38401	95911	31587	089	0.72689	95102	16489	70515	436		
0.758	0.68747	03962	13086	40963	419	0.72621	24030	41026	27404	867		
0.759	0.68819	62647	59922	57950	885	0.72552	45696	53220	31961	494		
0.760	0.68892	14451	10551	33914	776	0.72483	60107	40905	17233	969		
0.761	0.68964	59365	39792	39835	383	0.72414	67269	92639	68715	814		
0.762	0.69036	97383	23154	38826	030	0.72345	67190	97707	55489	548		
0.763	0.69109	28497	36835	58582	200	0.72276	59877	46116	61298	318		
0.764	0.69181	52700	57724	63761	700	0.72207	45336	28598	15545	123		
0.765	0.69253	69985	63401	28295	794	0.72138	23574	36606	24219	693		
0.766	0.69325	80345	32137	07631	223	0.72068	94598	62317	00753	084		
0.767	0.69397	83772	42896	10903	039	0.71999	58415	98627	96800	072		
0.768	0.69469	80259	75335	73038	195	0.71930	15033	39157	32949	410		
0.769	0.69541	69800	09807	26789	802	0.71860	64457	78243	29362	010		
0.770	0.69613	52386	27356	74701	988	0.71791	06696	10943	36337	129		
0.771	0.69685	28011	09725	61005	296	0.71721	41755	33033	64806	626		
0.772	0.69756	96667	39351	43442	524	0.71651	69642	41008	16757	355		
0.773	0.69828	58347	99368	65024	972	0.71581	90364	32078	15581	770		
0.774	0.69900	13045	73609	25718	983	0.71512	03928	04171	36356	807		
0.775	0.69971	60753	46603	54062	747	0.71442	10340	55931	36051	117		
0.776	0.70043	01464	03580	78713	256	0.71372	09608	86716	83660	709		
0.777	0.70114	35170	30469	99923	379	0.71302	01739	96600	90273	093		
0.778	0.70185	61865	13900	60948	949	0.71231	86740	86370	39059	972		
0.779	0.70256	81541	41203	19385	818	0.71161	64618	57525	15198	564		
0.780	0.70327	94192	00410	18436	790	0.71091	35380	12277	35721	626		
0.781	0.70398	99809	80256	58108	374	0.71020	99032	53550	79296	239		
0.782	0.70469	98387	70180	66337	280	0.70950	55582	84980	15931	435		
0.783	0.70540	89918	60324	70046	581	0.70880	05038	10910	36614	737		
0.784	0.70611	74395	41535	66131	480	0.70809	47405	36395	82877	671		
0.785	0.70682	51811	05365	92374	614	0.70738	82691	67199	76290	330		
0.786	0.70753	22158	44073	98290	801	0.70668	10904	09793	47885	059		
0.787	0.70823	85430	50625	15901	193	0.70597	32049	71355	67509	330		
0.788	0.70894	41620	18692	30436	730	0.70526	46135	59771	73107	880		
0.789	0.70964	90720	42656	50970	857	0.70455	53168	83632	99934	173		
0.790	0.71035	32724	17607	80981	403	0.70384	53156	52236	09691	278		
0.791	0.71105	67624	39345	88841	574	0.70313	46105	75582	19602	208		
0.792	0.71175	95414	04380	78239	979	0.70242	32023	64376	31409	812		
0.793	0.71246	16086	09933	58529	620	0.70171	10917	30026	60306	275		
0.794	0.71316	29633	53937	15005	776	0.70099	82793	84643	63792	314		
0.795	0.71386	36049	35036	79112	713	0.70028	47660	41039	70466	123		
0.796	0.71456	35326	52590	98579	148	0.69957	05524	12728	08742	151		
0.797	0.71526	27458	06672	07482	391	0.69885	56392	13922	35499	779		
0.798	0.71596	12436	98066	96241	109	0.69814	00271	59535	64661	971		
0.799	0.71665	90256	28277	81536	630	0.69742	37169	65179	95703	964		
0.800	0.71735	60908	99522	76162	718	0.69670	67093	47165	42092	075		
			$\left[\begin{smallmatrix} (-8)9 \\ 7 \end{smallmatrix} \right]$						$\left[\begin{smallmatrix} (-8)9 \\ 7 \end{smallmatrix} \right]$			

Table 4.6 CIRCULAR SINES AND COSINES FOR RADIAN ARGUMENTS

x	sin x					cos x				
0.800	0.71735	60908	99522	76162	718	0.69670	67093	47165	42092	075
0.801	0.71805	24388	14736	58803	753	0.69598	90050	22499	59652	695
0.802	0.71874	80686	77571	43741	255	0.69527	06047	08886	74871	538
0.803	0.71944	29797	92397	50488	651	0.69455	15091	24727	13123	218
0.804	0.72013	71714	64303	73354	263	0.69383	17189	89116	26831	236
0.805	0.72083	06429	99098	50932	396	0.69311	12350	21844	23558	425
0.806	0.72152	33937	03310	35522	503	0.69239	00579	43394	94027	956
0.807	0.72221	54228	84188	62476	322	0.69166	81884	74945	40074	951
0.808	0.72290	67298	49704	19472	935	0.69094	56273	38365	02528	784
0.809	0.72359	73139	08550	15721	677	0.69022	23752	56214	89026	151
0.810	0.72428	71743	70142	51092	818	0.68949	84329	51747	01754	964
0.811	0.72497	63105	44620	85175	959	0.68877	38011	48903	65129	158
0.812	0.72566	47217	42849	06266	069	0.68804	84805	72316	53394	472
0.813	0.72635	24072	76416	00277	085	0.68732	24719	47306	18165	280
0.814	0.72703	93664	57636	19583	027	0.68659	57759	99881	15892	545
0.815	0.72772	55985	99550	51786	534	0.68586	83934	56737	35262	969
0.816	0.72841	11030	15926	88414	775	0.68514	03250	45257	24529	414
0.817	0.72909	58790	21260	93542	651	0.68441	15714	93509	18772	652
0.818	0.72977	99259	30776	72343	223	0.68368	21335	30246	67094	544
0.819	0.73046	32430	60427	39565	302	0.68295	20118	84907	59742	692
0.820	0.73114	58297	26895	87938	131	0.68222	12072	87613	55166	656
0.821	0.73182	76852	47595	56503	084	0.68148	97204	69169	07005	802
0.822	0.73250	88089	40670	98872	320	0.68075	75521	61060	91008	857
0.823	0.73318	92001	24998	51414	329	0.68002	47030	95457	31885	232
0.824	0.73386	88581	20187	01366	283	0.67929	11740	05207	30088	213
0.825	0.73454	77822	46578	54873	150	0.67855	69656	23839	88530	058
0.826	0.73522	59718	25249	04953	477	0.67782	20786	85563	39229	106
0.827	0.73590	34261	78008	99391	793	0.67708	65139	25264	69888	949
0.828	0.73658	01446	27404	08557	557	0.67635	02720	78508	50409	750
0.829	0.73725	61264	96715	93150	579	0.67561	33538	81536	59331	781
0.830	0.73793	13711	09962	71872	858	0.67487	57600	71267	10211	246
0.831	0.73860	58777	91899	89026	752	0.67413	74913	85293	77928	481
0.832	0.73927	96458	68020	82039	434	0.67339	85485	61885	24928	580
0.833	0.73995	26746	64557	48913	544	0.67265	89323	39984	27394	537
0.834	0.74062	49635	08481	15603	989	0.67191	86434	59207	10352	983
0.835	0.74129	65117	27503	03320	808	0.67117	76826	59842	28712	570
0.836	0.74196	73186	50074	95758	049	0.67043	60506	82850	83235	098
0.837	0.74263	73836	05390	06248	576	0.66969	37482	69864	56439	445
0.838	0.74330	67059	23383	44844	755	0.66895	07761	63185	83438	385
0.839	0.74397	52849	34732	85324	932	0.66820	71351	05786	68708	357
0.840	0.74464	31199	70859	32125	657	0.66746	28258	41308	11792	267
0.841	0.74531	02103	63927	87199	577	0.66671	78491	14059	32935	396
0.842	0.74597	65554	46848	16798	923	0.66597	22056	69016	98654	482
0.843	0.74664	21545	53275	18184	539	0.66522	58962	51824	47240	065
0.844	0.74730	70070	17609	86260	385	0.66447	89216	08791	14192	152
0.845	0.74797	11121	74999	80133	429	0.66373	12824	86891	57589	286
0.846	0.74863	44693	61339	89598	886	0.66298	29796	33764	83391	100
0.847	0.74929	70779	13273	01550	724	0.66223	40137	97713	70674	409
0.848	0.74995	89371	68190	66317	368	0.66148	43857	27703	96802	946
0.849	0.75062	00464	64233	63922	547	0.66073	40961	73363	62530	783
0.850	0.75128	04051	40292	70271	207	0.65998	31458	84982	17039	542

$$\left[\begin{matrix} (-8)9 \\ 7 \end{matrix} \right]$$

$$\left[\begin{matrix} (-8)9 \\ 7 \end{matrix} \right]$$

CIRCULAR SINES AND COSINES FOR RADIAN ARGUMENTS Table 4.6

x	sin x					cos x				
0.850	0.75128	04051	40292	70271	207	0.65998	31458	84982	17039	542
0.851	0.75194	00125	36009	23260	432	0.65923	15356	13509	82909	449
0.852	0.75259	88679	91775	88815	295	0.65847	92661	10556	81024	321
0.853	0.75325	69708	48737	26849	594	0.65772	63381	28392	55410	547
0.854	0.75391	43204	48790	57151	380	0.65697	27524	19944	98010	152
0.855	0.75457	09161	34586	25193	237	0.65621	85097	38799	73388	013
0.856	0.75522	67572	49528	67867	227	0.65546	36108	39199	43373	300
0.857	0.75588	18431	37776	79144	450	0.65470	80564	76042	91635	218
0.858	0.75653	61731	44244	75659	143	0.65395	18474	04884	48193	134
0.859	0.75718	97466	14602	62217	260	0.65319	49843	81933	13861	148
0.860	0.75784	25628	95276	97229	459	0.65243	74681	64051	84627	203
0.861	0.75849	46213	33451	58068	441	0.65167	92995	08756	75966	794
0.862	0.75914	59212	77068	06350	566	0.65092	04791	74216	47091	357
0.863	0.75979	64620	74826	53141	684	0.65016	10079	19251	25131	418
0.864	0.76044	62430	76186	24087	122	0.64940	08865	03332	29254	574
0.865	0.76109	52636	31366	24465	750	0.64864	01156	86580	94718	373
0.866	0.76174	35230	91346	04168	073	0.64787	86962	29767	96858	196
0.867	0.76239	10208	07866	22598	272	0.64711	66288	94312	75010	176
0.868	0.76303	77561	33429	13500	144	0.64635	39144	42282	56369	276
0.869	0.76368	37284	21299	49706	858	0.64559	05536	36391	79782	561
0.870	0.76432	89370	25505	07814	480	0.64482	65472	40001	19477	766
0.871	0.76497	33813	00837	32779	191	0.64406	18960	17117	08727	234
0.872	0.76561	70606	02852	02438	134	0.64329	66007	32390	63447	280
0.873	0.76625	99742	87869	91953	834	0.64253	06621	51117	05733	091
0.874	0.76690	21217	12977	38182	114	0.64176	40810	39234	87329	202
0.875	0.76754	35022	36027	03963	458	0.64099	68581	63325	13035	656
0.876	0.76818	41152	15638	42337	736	0.64022	89942	90610	64049	903
0.877	0.76882	39600	11198	60682	252	0.63946	04901	88955	21244	528
0.878	0.76946	30359	82862	84773	027	0.63869	13466	26862	88380	872
0.879	0.77010	13424	91555	22769	271	0.63792	15643	73477	15258	639
0.880	0.77073	88788	98969	29120	965	0.63715	11441	98580	20801	550
0.881	0.77137	56445	67568	68399	506	0.63638	00868	72592	16079	131
0.882	0.77201	16388	60587	79051	337	0.63560	83931	66570	27264	710
0.883	0.77264	68611	42032	37074	497	0.63483	60638	52208	18529	695
0.884	0.77328	13107	76680	19618	049	0.63406	30997	01835	14874	218
0.885	0.77391	49871	30081	68504	290	0.63328	95014	88415	24894	213
0.886	0.77454	78895	68560	53673	706	0.63251	52699	85546	63485	020
0.887	0.77518	00174	59214	36552	600	0.63174	04059	67460	74481	571
0.888	0.77581	13701	69915	33343	321	0.63096	49102	09021	53235	256
0.889	0.77644	19470	69310	78237	045	0.63018	87834	85724	69127	530
0.890	0.77707	17475	26823	86549	033	0.62941	20265	73696	88020	355
0.891	0.77770	07709	12654	17776	316	0.62863	46402	49694	94643	540
0.892	0.77832	90165	97778	38577	722	0.62785	66252	91105	14919	057
0.893	0.77895	64839	53950	85676	211	0.62707	79824	75942	38222	428
0.894	0.77958	31723	53704	28683	432	0.62629	87125	82849	39581	242
0.895	0.78020	90811	70350	32846	443	0.62551	88163	91096	01810	880
0.896	0.78083	42097	77980	21716	548	0.62473	82946	80578	37587	545
0.897	0.78145	85575	51465	39740	163	0.62395	71482	31818	11458	656
0.898	0.78208	21238	66458	14771	667	0.62317	53778	25961	61790	683
0.899	0.78270	49080	99392	20508	171	0.62239	29842	44779	22654	524
0.900	0.78332	69096	27483	38846	138	0.62160	99682	70664	45648	472

$$\left[\begin{matrix} (-7)1 \\ 7 \end{matrix} \right]$$

$$\left[\begin{matrix} (-8)8 \\ 7 \end{matrix} \right]$$

Table 4.6 CIRCULAR SINES AND COSINES FOR RADIAN ARGUMENTS

x	sin x					cos x				
0.900	0.78332	69096	27483	38846	138	0.62160	99682	70664	45648	472
0.901	0.78394	81278	28730	22159	796	0.62082	63306	86633	21658	870
0.902	0.78456	85620	81914	55501	279	0.62004	20722	76323	02558	530
0.903	0.78518	82117	66602	18722	439	0.61925	71938	23992	22842	983
0.904	0.78580	70762	63143	48518	260	0.61847	16961	14519	21204	658
0.905	0.78642	51549	52674	00391	817	0.61768	55799	33401	62045	040
0.906	0.78704	24472	17115	10540	713	0.61689	88460	66755	56924	921
0.907	0.78765	89524	39174	57664	940	0.61611	14953	01314	85952	792
0.908	0.78827	46700	02347	24696	094	0.61532	35284	24430	19111	466
0.909	0.78888	95992	90915	60447	888	0.61453	49462	24068	37523	020
0.910	0.78950	37396	89950	41187	896	0.61374	57494	88811	54652	118
0.911	0.79011	70905	85311	32130	474	0.61295	59390	07856	37447	803
0.912	0.79072	96513	63647	48850	789	0.61216	55155	71013	27423	839
0.913	0.79134	14214	12398	18619	897	0.61137	44799	68705	61677	674
0.914	0.79195	24001	19793	41660	812	0.61058	28329	91968	93848	110
0.915	0.79256	25868	74854	52325	499	0.60979	05754	32450	15011	758
0.916	0.79317	19810	67394	80192	738	0.60899	77080	82406	74518	350
0.917	0.79378	05820	88020	11086	785	0.60820	42317	34706	00764	999
0.918	0.79438	83893	28129	48016	785	0.60741	01471	82824	21909	476
0.919	0.79499	54021	79915	72036	860	0.60661	54552	20845	86522	589
0.920	0.79560	16200	36366	03026	828	0.60582	01566	43462	84179	741
0.921	0.79620	70422	91262	60393	471	0.60502	42522	45973	65991	745
0.922	0.79681	16683	39183	23692	319	0.60422	77428	24282	65074	984
0.923	0.79741	54975	75501	93169	858	0.60343	06291	74899	16960	980
0.924	0.79801	85293	96389	50226	129	0.60263	29120	94936	79945	468
0.925	0.79862	07631	98814	17797	639	0.60183	45923	82112	55377	043
0.926	0.79922	21983	80542	20660	537	0.60103	56708	34746	07885	466
0.927	0.79982	28343	40138	45653	978	0.60023	61482	51758	85549	703
0.928	0.80042	26704	76967	01823	638	0.59943	60254	32673	40005	791
0.929	0.80102	17061	91191	80485	294	0.59863	53031	77612	46494	584
0.930	0.80161	99408	83777	15208	432	0.59783	39822	87298	23849	491
0.931	0.80221	73739	56488	41719	806	0.59703	20635	63051	54424	260
0.932	0.80281	40048	11892	57726	899	0.59622	95478	06791	03960	905
0.933	0.80340	98328	53358	82661	218	0.59542	64358	21032	41397	846
0.934	0.80400	48574	85059	17341	371	0.59462	27284	08887	58618	345
0.935	0.80459	90781	11969	03555	863	0.59381	84263	74063	90139	324
0.936	0.80519	24941	39867	83565	545	0.59301	35305	20863	32740	634
0.937	0.80578	51049	75339	59525	671	0.59220	80416	54181	65034	867
0.938	0.80637	69100	25773	52827	488	0.59140	19605	79507	66977	785
0.939	0.80696	79086	99364	63359	313	0.59059	52881	02922	39319	443
0.940	0.80755	81004	05114	28687	022	0.58978	80250	31098	22996	099
0.941	0.80814	74845	52830	83153	915	0.58898	01721	71298	18462	976
0.942	0.80873	60605	53130	16899	872	0.58817	17303	31375	04967	973
0.943	0.80932	38278	17436	34799	758	0.58736	27003	19770	59766	388
0.944	0.80991	07857	57982	15321	017	0.58655	30829	45514	77276	748
0.945	0.81049	69337	87809	69300	383	0.58574	28790	18224	88177	827
0.946	0.81108	22713	20770	98639	669	0.58493	20893	48104	78446	913
0.947	0.81166	67977	71528	54920	560	0.58412	07147	45944	08339	436
0.948	0.81225	05125	55555	97938	351	0.58330	87560	23117	31310	012
0.949	0.81283	34150	89138	54154	591	0.58249	62139	91583	12874	994
0.950	0.81341	55047	89373	75068	542	0.58168	30894	63883	49416	618
			$\left[\begin{smallmatrix} (-7)1 \\ 7 \end{smallmatrix} \right]$						$\left[\begin{smallmatrix} (-8)8 \\ 7 \end{smallmatrix} \right]$	

CIRCULAR SINES AND COSINES FOR RADIAN ARGUMENTS Table 4.6

x	sin x					cos x				
0.950	0.81341	55047	89373	75068	542	0.58168	30894	63883	49416	618
0.951	0.81399	67810	74171	95507	433	0.58086	93832	53142	86928	810
0.952	0.81457	72433	62256	91835	411	0.58005	50961	73067	39704	748
0.953	0.81515	68910	73166	40081	165	0.57924	02290	37944	08966	253
0.954	0.81573	57236	27252	73984	145	0.57842	47826	62640	01435	096
0.955	0.81631	37404	45683	42959	322	0.57760	87578	62601	47846	300
0.956	0.81689	09409	50441	69980	433	0.57679	21554	53853	21403	511
0.957	0.81746	73245	64327	09381	654	0.57597	49762	52997	56176	536
0.958	0.81804	28907	10956	04577	644	0.57515	72210	77213	65441	113
0.959	0.81861	76388	14762	45701	891	0.57433	88907	44256	59961	007
0.960	0.81919	15683	00998	27163	322	0.57351	99860	72456	66212	505
0.961	0.81976	46785	95734	05121	101	0.57270	05078	80718	44551	395
0.962	0.82033	69691	25859	54877	569	0.57188	04569	88520	07322	513
0.963	0.82090	84393	19084	28189	263	0.57105	98342	15912	36911	940
0.964	0.82147	90886	03938	10495	962	0.57023	86403	83518	03741	923
0.965	0.82204	89164	09771	78067	694	0.56941	68763	12530	84208	614
0.966	0.82261	79221	66757	55069	656	0.56859	45428	24714	78562	699
0.967	0.82318	61053	05889	70544	986	0.56777	16407	42403	28733	004
0.968	0.82375	34652	58985	15315	328	0.56694	81708	88498	36093	162
0.969	0.82432	00014	58683	98799	136	0.56612	41340	86469	79171	417
0.970	0.82488	57133	38450	05747	662	0.56529	95311	60354	31303	653
0.971	0.82545	06003	32571	52898	564	0.56447	43629	34754	78229	727
0.972	0.82601	46618	76161	45547	087	0.56364	86302	34839	35633	190
0.973	0.82657	78974	05158	34034	750	0.56282	23338	86340	66624	480
0.974	0.82714	03063	56326	70155	495	0.56199	54747	15554	99167	663
0.975	0.82770	18881	67257	63479	226	0.56116	80535	49341	43450	813
0.976	0.82826	26422	76369	37592	699	0.56034	00712	15121	09200	110
0.977	0.82882	25681	22907	86257	689	0.55951	15285	40876	22937	736
0.978	0.82938	16651	46947	29486	397	0.55868	24263	55149	45183	654
0.979	0.82993	99327	89390	69534	022	0.55785	27654	87042	87601	358
0.980	0.83049	73704	91970	46808	453	0.55702	25467	66217	30087	666
0.981	0.83105	39776	97248	95697	028	0.55619	17710	22891	37806	645
0.982	0.83160	97538	48619	00310	290	0.55536	04390	87840	78167	757
0.983	0.83216	46983	90304	50142	703	0.55452	85517	92397	37748	295
0.984	0.83271	88107	67360	95650	254	0.55369	61099	68448	39160	207
0.985	0.83327	20904	25676	03744	902	0.55286	31144	48435	57861	376
0.986	0.83382	45368	11970	13205	801	0.55202	95660	65354	38911	453
0.987	0.83437	61493	73796	90007	262	0.55119	54656	52753	13672	322
0.988	0.83492	69275	59543	82563	379	0.55036	08140	44732	16453	272
0.989	0.83547	68708	18432	76889	279	0.54952	56120	75943	01100	969
0.990	0.83602	59786	00520	51678	926	0.54868	98605	81587	57534	313
0.991	0.83657	42503	56699	33299	444	0.54785	35603	97417	28224	252
0.992	0.83712	16855	38697	50701	883	0.54701	67123	59732	24618	647
0.993	0.83766	82835	99079	90248	385	0.54617	93173	05380	43512	268
0.994	0.83821	40439	91248	50455	694	0.54534	13760	71756	83362	006
0.995	0.83875	89661	69442	96654	953	0.54450	28894	96802	60547	375
0.996	0.83930	30495	88741	15567	733	0.54366	38584	19004	25576	412
0.997	0.83984	62937	05059	69798	245	0.54282	42836	77392	79237	026
0.998	0.84038	86979	75154	52241	668	0.54198	41661	11542	88693	907
0.999	0.84093	02618	56621	40408	555	0.54114	35065	61572	03531	067
1.000	0.84147	09848	07896	50665	250	0.54030	23058	68139	71740	094
			$\left[\begin{smallmatrix} (-7)1 \\ 7 \end{smallmatrix} \right]$					$\left[\begin{smallmatrix} (-8)7 \\ 7 \end{smallmatrix} \right]$		

Table 4.6 CIRCULAR SINES AND COSINES FOR RADIAN ARGUMENTS

x	$\sin x$						$\cos x$					
1.000	0.84147	09848	07896	50665	250	0.54030	23058	68139	71740	094		
1.001	0.84201	08662	88256	92390	268	0.53946	05648	72446	55654	214		
1.002	0.84254	99057	57821	22046	578	0.53861	82844	16233	47828	237		
1.003	0.84308	81026	77549	97169	747	0.53777	54653	41780	86864	465		
1.004	0.84362	54565	09246	30271	873	0.53693	21084	91907	73184	669		
1.005	0.84416	19667	15556	42661	273	0.53608	82147	09970	84748	188		
1.006	0.84469	76327	59970	18177	851	0.53524	37848	39863	92716	262		
1.007	0.84523	24541	06821	56844	116	0.53439	88197	26016	77062	668		
1.008	0.84576	64302	21289	28431	774	0.53355	33202	13394	42130	747		
1.009	0.84629	95605	69397	25943	853	0.53270	72871	47496	32136	904		
1.010	0.84683	18446	18015	19012	310	0.53186	07213	74355	46620	673		
1.011	0.84736	32818	34859	07211	051	0.53101	36237	40537	55841	426		
1.012	0.84789	38716	88491	73284	331	0.53016	59950	93140	16121	808		
1.013	0.84842	36136	48323	36290	466	0.52931	78362	79791	85137	984		
1.014	0.84895	25071	84612	04660	810	0.52846	91481	48651	37156	798		
1.015	0.84948	05517	68464	29173	940	0.52761	99315	48406	78219	896		
1.016	0.85000	77468	71835	55845	003	0.52677	01873	28274	61274	932		
1.017	0.85053	40919	67530	78730	164	0.52591	99163	37999	01253	921		
1.018	0.85105	95865	29204	92646	111	0.52506	91194	27850	90098	832		
1.019	0.85158	42300	31363	45804	549	0.52421	77974	48627	11734	503		
1.020	0.85210	80219	49362	92361	655	0.52336	59512	51649	56988	961		
1.021	0.85263	09617	59411	44882	415	0.52251	35816	88764	38461	245		
1.022	0.85315	30489	38569	26719	808	0.52166	06896	12341	05336	792		
1.023	0.85367	42829	64749	24308	778	0.52080	72758	75271	58150	502		
1.024	0.85419	46633	16717	39374	945	0.51995	33413	30969	63497	542		
1.025	0.85471	41894	74093	41057	997	0.51909	88868	33369	68691	985		
1.026	0.85523	28609	17351	17949	715	0.51824	39132	36926	16373	373		
1.027	0.85575	06771	27819	30046	586	0.51738	84213	96612	59061	276		
1.028	0.85626	76375	87681	60616	931	0.51653	24121	67920	73657	956		
1.029	0.85678	37417	79977	67982	525	0.51567	58864	06859	75899	186		
1.030	0.85729	89891	88603	37214	627	0.51481	88449	69955	34753	350		
1.031	0.85781	33792	98311	31744	398	0.51396	12887	14248	86768	878		
1.032	0.85832	69115	94711	44887	626	0.51310	32184	97296	50370	116		
1.033	0.85883	95855	64271	51283	734	0.51224	46351	77168	40101	715		
1.034	0.85935	14006	94317	58248	998	0.51138	55396	12447	80821	625		
1.035	0.85986	23564	73034	57043	938	0.51052	59326	62230	21842	776		
1.036	0.86037	24523	89466	74054	819	0.50966	58151	86122	51023	535		
1.037	0.86088	16879	33518	21889	224	0.50880	51880	44242	08807	028		
1.038	0.86139	00625	95953	50385	634	0.50794	40520	97216	02209	404		
1.039	0.86189	75758	68397	97536	975	0.50708	24082	06180	18757	138		
1.040	0.86240	42272	43338	40328	079	0.50622	02572	32778	40373	447		
1.041	0.86291	00162	14123	45486	997	0.50535	76000	39161	57213	919		
1.042	0.86341	49422	74964	20150	131	0.50449	44374	87986	81451	427		
1.043	0.86391	90049	20934	62441	124	0.50363	07704	42416	61010	426		
1.044	0.86442	22036	47972	11963	456	0.50276	65997	66117	93250	711		
1.045	0.86492	45379	52878	00206	699	0.50190	19263	23261	38600	728		
1.046	0.86542	60073	33318	00866	385	0.50103	67509	78520	34140	520		
1.047	0.86592	66112	87822	80077	424	0.50017	10745	97070	07134	396		
1.048	0.86642	63493	15788	46561	037	0.49930	48980	44586	88513	415		
1.049	0.86692	52209	17477	01685	140	0.49843	82221	87247	26307	756		
1.050	0.86742	32255	94016	89438	141	0.49757	10478	91726	99029	085		

$$\left[\begin{matrix} (-7)1 \\ 7 \end{matrix} \right]$$

$$\left[\begin{matrix} (-8)7 \\ 7 \end{matrix} \right]$$

CIRCULAR SINES AND COSINES FOR RADIAN ARGUMENTS Table 4.6

x	sin x					cos x				
1.050	0.86742	32255	94016	89438	141	0.49757	10478	91726	99029	085
1.051	0.86792	03628	47403	46316	092	0.49670	33760	25200	29002	975
1.052	0.86841	66321	80499	51123	146	0.49583	52074	55338	95651	499
1.053	0.86891	20330	97035	74685	276	0.49496	65430	50311	48726	051
1.054	0.86940	65651	01611	29477	198	0.49409	73836	78782	21490	510
1.055	0.86990	02276	99694	19162	460	0.49322	77302	09910	43854	806
1.056	0.87039	30203	97621	88046	624	0.49235	75835	13349	55459	008
1.057	0.87088	49427	02601	70443	529	0.49148	69444	59246	18707	979
1.058	0.87137	59941	22711	39954	543	0.49061	58139	18239	31756	732
1.059	0.87186	61741	66899	58660	794	0.48974	41927	61459	41446	534
1.060	0.87235	54823	44986	26228	295	0.48887	20818	60527	56191	864
1.061	0.87284	39181	67663	28925	947	0.48799	94820	87554	58818	317
1.062	0.87333	14811	46494	88556	345	0.48712	63943	15140	19351	528
1.063	0.87381	81707	93918	11299	356	0.48625	28194	16372	07757	202
1.064	0.87430	39866	23243	36468	402	0.48537	87582	64825	06632	362
1.065	0.87478	89281	48654	85179	424	0.48450	42117	34560	23847	867
1.066	0.87527	29948	85211	08932	453	0.48362	91807	00124	05142	311
1.067	0.87575	61863	48845	38105	753	0.48275	36660	36547	46667	387
1.068	0.87623	85020	56366	30362	492	0.48187	76686	19345	07484	800
1.069	0.87671	99415	25458	18969	874	0.48100	11893	24514	22014	811
1.070	0.87720	05042	74681	61030	706	0.48012	42290	28534	12436	509
1.071	0.87768	01898	23473	85627	336	0.47924	67886	08365	01039	904
1.072	0.87815	89976	92149	41877	919	0.47836	88689	41447	22529	904
1.073	0.87863	69274	01900	46904	963	0.47749	04709	05700	36282	289
1.074	0.87911	39784	74797	33716	111	0.47661	15953	79522	38551	762
1.075	0.87959	01504	33788	98997	101	0.47573	22432	41788	74632	160
1.076	0.88006	54428	02703	50816	869	0.47485	24153	71851	50968	911
1.077	0.88053	98551	06248	56244	731	0.47397	21126	49538	47223	840
1.078	0.88101	33868	70011	88879	619	0.47309	13359	55152	28292	396
1.079	0.88148	60376	20461	76291	297	0.47221	00861	69469	56273	392
1.080	0.88195	78068	84947	47373	533	0.47132	83641	73740	02391	353
1.081	0.88242	86941	91699	79609	169	0.47044	61708	49685	58871	547
1.082	0.88289	86990	69831	46247	031	0.46956	35070	79499	50767	810
1.083	0.88336	78210	49337	63390	660	0.46868	03737	45845	47743	217
1.084	0.88383	60596	61096	36998	790	0.46779	67717	31856	75803	727
1.085	0.88430	34144	36869	09797	534	0.46691	27019	21135	28984	862
1.086	0.88476	98849	09301	08104	243	0.46602	81651	97750	80991	522
1.087	0.88523	54706	11921	88562	972	0.46514	31624	46239	96791	014
1.088	0.88570	01710	79145	84791	522	0.46425	76945	51605	44159	401
1.089	0.88616	39858	46272	53940	000	0.46337	17623	99315	05181	235
1.090	0.88662	69144	49487	23160	860	0.46248	53668	75300	87702	790
1.091	0.88708	89564	25861	35990	371	0.46159	85088	65958	36738	852
1.092	0.88755	01113	13352	98641	470	0.46071	11892	58145	45833	190
1.093	0.88801	03786	50807	26207	951	0.45982	34089	39181	68372	764
1.094	0.88846	97579	77956	88779	948	0.45893	51687	96847	28855	783
1.095	0.88892	82488	35422	57470	660	0.45804	64697	19382	34113	686
1.096	0.88938	58507	64713	50354	274	0.45715	73125	95485	84487	142
1.097	0.88984	25633	08227	78315	047	0.45626	76983	14314	84956	158
1.098	0.89029	83860	09252	90807	488	0.45537	76277	65483	56224	382
1.099	0.89075	33184	11966	21527	609	0.45448	71018	39062	45757	688
1.100	0.89120	73600	61435	33995	180	0.45359	61214	25577	38777	137
			$\binom{-7}{7}1$					$\binom{-8}{7}6$		

Table 4.6 CIRCULAR SINES AND COSINES FOR RADIAN ARGUMENTS

x	sin x					cos x				
1.100	0.89120	73600	61435	33995	180	0.45359	61214	25577	38777	137
1.101	0.89166	05105	03618	67046	971	0.45270	46874	16008	69206	400
1.102	0.89211	27692	85365	80240	901	0.45181	28007	01790	30573	730
1.103	0.89256	41359	54417	99171	080	0.45092	04621	74808	86868	576
1.104	0.89301	46100	59408	60693	678	0.45002	76727	27402	83352	928
1.105	0.89346	41911	49863	58063	585	0.44913	44332	52361	57327	478
1.106	0.89391	28787	76201	85981	812	0.44824	07446	42924	48852	689
1.107	0.89436	06724	89735	85553	594	0.44734	66077	92780	11424	866
1.108	0.89480	75718	42671	89157	146	0.44645	20235	96065	22607	305
1.109	0.89525	35763	88110	65223	027	0.44555	69929	47363	94616	628
1.110	0.89569	86856	80047	62924	063	0.44466	15167	41706	84864	374
1.111	0.89614	28992	73373	56775	801	0.44376	55958	74570	06453	951
1.112	0.89658	62167	23874	91147	427	0.44286	92312	41874	38633	030
1.113	0.89702	86375	88234	24683	120	0.44197	24237	39984	37201	474
1.114	0.89747	01614	24030	74633	785	0.44107	51742	65707	44874	890
1.115	0.89791	07877	89740	61099	138	0.44017	74837	16293	01603	891
1.116	0.89835	05162	44737	51180	079	0.43927	93529	89431	54849	166
1.117	0.89878	93463	49293	03041	321	0.43838	07829	83253	69812	438
1.118	0.89922	72776	64577	09884	230	0.43748	17745	96329	39623	410
1.119	0.89966	43097	52658	43829	826	0.43658	23287	27666	95482	777
1.120	0.90010	04421	76504	99711	910	0.43568	24462	76712	16761	399
1.121	0.90053	56744	99984	38780	263	0.43478	21281	43347	41055	736
1.122	0.90097	00062	87864	32313	880	0.43388	13752	27890	74199	612
1.123	0.90140	34371	05813	05144	201	0.43298	01884	31095	00232	420
1.124	0.90183	59665	20399	79088	276	0.43207	85686	54146	91323	845
1.125	0.90226	75940	99095	16291	842	0.43117	65167	98666	17655	197
1.126	0.90269	83194	10271	62482	258	0.43027	40337	66704	57257	452
1.127	0.90312	81420	23203	90131	256	0.42937	11204	60745	05806	078
1.128	0.90355	70615	08069	41527	464	0.42846	77777	83700	86372	749
1.129	0.90398	50774	35948	71758	658	0.42756	40066	38914	59134	030
1.130	0.90441	21893	78825	91603	708	0.42665	98079	30157	31037	122
1.131	0.90483	83969	09589	10334	160	0.42575	51825	61627	65422	763
1.132	0.90526	36996	02030	78425	425	0.42485	01314	37950	91605	376
1.133	0.90568	80970	30848	30177	523	0.42394	46554	64178	14410	540
1.134	0.90611	15887	71644	26245	348	0.42303	87555	45785	23669	902
1.135	0.90653	41744	00926	96078	401	0.42213	24325	88672	03673	585
1.136	0.90695	58534	96110	80269	960	0.42122	56874	99161	42580	219
1.137	0.90737	66256	35516	72815	632	0.42031	85211	83998	41784	656
1.138	0.90779	64903	98372	63281	260	0.41941	09345	50349	25243	478
1.139	0.90821	54473	64813	78880	126	0.41850	29285	05800	48758	379
1.140	0.90863	34961	15883	26459	422	0.41759	45039	58358	09217	519
1.141	0.90905	06362	33532	34395	940	0.41668	56618	16446	53794	933
1.142	0.90946	68673	00620	94400	939	0.41577	64029	88907	89108	094
1.143	0.90988	21889	00918	03234	153	0.41486	67283	85000	90333	707
1.144	0.91029	66006	19102	04326	885	0.41395	66389	14400	10281	852
1.145	0.91071	01020	40761	29314	164	0.41304	61354	87194	88428	529
1.146	0.91112	26927	52394	39475	912	0.41213	52190	13888	59906	732
1.147	0.91153	43723	41410	67087	073	0.41122	38904	05397	64456	120
1.148	0.91194	51403	96130	56676	684	0.41031	21505	73050	55331	381
1.149	0.91235	49965	05786	06195	821	0.40940	00004	28587	08169	395
1.150	0.91276	39402	60521	08094	403	0.40848	74408	84157	29815	258

$$\begin{bmatrix} (-7)1 \\ 7 \end{bmatrix}$$

$$\begin{bmatrix} (-8)6 \\ 7 \end{bmatrix}$$

CIRCULAR SINES AND COSINES FOR RADIAN ARGUMENTS Table 4.6

x	sin x					cos x				
1.150	0.91276	39402	60521	08094	403	0.40848	74408	84157	29815	258
1.151	0.91317	19712	51391	90306	792	0.40757	44728	52320	67107	284
1.152	0.91357	90890	70367	57146	165	0.40666	10972	46045	15621	071
1.153	0.91398	52933	10330	30107	602	0.40574	73149	78706	28372	706
1.154	0.91439	05835	65075	88579	865	0.40483	31269	64086	24481	224
1.155	0.91479	49594	29314	10465	816	0.40391	85341	16372	97790	397
1.156	0.91519	84204	98669	12711	431	0.40300	35373	50159	25449	945
1.157	0.91560	09663	69679	91743	383	0.40208	81375	80441	76456	266
1.158	0.91600	25966	39800	63815	143	0.40117	23357	22620	20152	779
1.159	0.91640	33109	07401	05261	556	0.40025	61326	92496	34689	958
1.160	0.91680	31087	71766	92661	866	0.39933	95294	06273	15445	164
1.161	0.91720	19898	33100	42911	136	0.39842	25267	80553	83402	355
1.162	0.91759	99536	92520	53200	023	0.39750	51257	32340	93491	775
1.163	0.91799	69999	52063	40902	883	0.39658	73271	79035	42889	706
1.164	0.91839	31282	14682	83374	147	0.39566	91320	38435	79278	377
1.165	0.91878	83380	84250	57652	941	0.39475	05412	28737	09066	125
1.166	0.91918	26291	65556	80075	906	0.39383	15556	68530	05567	898
1.167	0.91957	60010	64310	45798	178	0.39291	21762	76800	17146	187
1.168	0.91996	84533	87139	68222	492	0.39199	24039	72926	75312	486
1.169	0.92035	99857	41592	18336	360	0.39107	22396	76682	02789	366
1.170	0.92075	05977	36135	63957	301	0.39015	16843	08230	21533	266
1.171	0.92114	02889	80158	08886	071	0.38923	07387	88126	60718	072
1.172	0.92152	90590	83968	31967	851	0.38830	94040	37316	64679	599
1.173	0.92191	69076	58796	26061	369	0.38738	76809	77135	00821	054
1.174	0.92230	38343	16793	36915	902	0.38646	55705	29304	67479	575
1.175	0.92268	98386	71033	01956	127	0.38554	30736	15936	01753	942
1.176	0.92307	49203	35510	88974	783	0.38462	01911	59525	87293	547
1.177	0.92345	90789	25145	34733	097	0.38369	69240	82956	62048	718
1.178	0.92384	23140	55777	83468	944	0.38277	32733	09495	25982	487
1.179	0.92422	46253	44173	25312	701	0.38184	92397	62792	48743	902
1.180	0.92460	60124	08020	34610	754	0.38092	48243	66881	77302	960
1.181	0.92498	64748	65932	08156	619	0.38000	00280	46178	43547	271
1.182	0.92536	60123	37446	03329	642	0.37907	48517	25478	71840	534
1.183	0.92574	46244	43024	76141	242	0.37814	92963	29958	86542	917
1.184	0.92612	23108	04056	19188	645	0.37722	33627	85174	19493	444
1.185	0.92649	90710	42853	99516	095	0.37629	70520	17058	17454	471
1.186	0.92687	49047	82657	96383	480	0.37537	03649	51921	49518	342
1.187	0.92724	98116	47634	38942	352	0.37444	33025	16451	14476	334
1.188	0.92762	37912	62876	43819	290	0.37351	58656	37709	48149	962
1.189	0.92799	68432	54404	52606	588	0.37258	80552	43133	30684	752
1.190	0.92836	89672	49166	69260	202	0.37165	98722	60532	93806	568
1.191	0.92874	01628	75038	97404	950	0.37073	13176	18091	28040	589
1.192	0.92911	04297	60825	77546	899	0.36980	23922	44362	89893	026
1.193	0.92947	97675	36260	24192	928	0.36887	30970	68273	08995	672
1.194	0.92984	81758	32004	62877	403	0.36794	34330	19116	95213	382
1.195	0.93021	56542	79650	67095	956	0.36701	34010	26558	45714	570
1.196	0.93058	22025	11719	95146	303	0.36608	30020	20629	52004	819
1.197	0.93094	78201	61664	26876	083	0.36515	22369	31729	06923	698
1.198	0.93131	25068	63866	00337	679	0.36422	11066	90622	11604	876
1.199	0.93167	62622	53638	48349	974	0.36328	96122	28438	82399	631
1.200	0.93203	90859	67226	34967	013	0.36235	77544	76673	57763	837
			$\left[\begin{smallmatrix} (-7)1 \\ 7 \end{smallmatrix} \right]$					$\left[\begin{smallmatrix} (-8)5 \\ 7 \end{smallmatrix} \right]$		

Table 4.6 CIRCULAR SINES AND COSINES FOR RADIAN ARGUMENTS

x	$\sin x$					$\cos x$				
1.200	0.93203	90859	67226	34967	013	0.36235	77544	76673	57763	837
1.201	0.93240	09776	41805	91853	542	0.36142	55343	67184	05108	539
1.202	0.93276	19369	15485	54567	367	0.36049	29528	32190	27614	189
1.203	0.93312	19634	27305	98748	519	0.35956	00108	04273	71008	651
1.204	0.93348	10568	17240	76215	175	0.35862	67092	16376	30309	065
1.205	0.93383	92167	26196	50966	302	0.35769	30490	01799	56527	660
1.206	0.93419	64427	96013	35090	992	0.35675	90310	94203	63341	607
1.207	0.93455	27346	69465	24584	444	0.35582	46564	27606	33727	018
1.208	0.93490	80919	90260	35070	567	0.35488	99259	36382	26557	166
1.209	0.93526	25144	03041	37431	162	0.35395	48405	55261	83165	039
1.210	0.93561	60015	53385	93341	646	0.35301	94012	19330	33870	301
1.211	0.93596	85530	87806	90713	291	0.35208	36088	64027	04470	775
1.212	0.93632	01686	53752	79041	926	0.35114	74644	25144	22698	521
1.213	0.93667	08478	99608	04663	095	0.35021	09688	38826	24640	616
1.214	0.93702	05904	74693	45913	598	0.34927	41230	41568	61124	730
1.215	0.93736	93960	29266	48199	416	0.34833	69279	70217	04069	578
1.216	0.93771	72642	14521	58969	959	0.34739	93845	61966	52800	358
1.217	0.93806	41946	82590	62598	617	0.34646	14937	54360	40329	260
1.218	0.93841	01870	86543	15169	574	0.34552	32564	85289	39601	140
1.219	0.93875	52410	80386	79170	848	0.34458	46736	92990	69704	455
1.220	0.93909	93563	19067	58093	524	0.34364	57463	16047	02047	552
1.221	0.93944	25324	58470	30937	151	0.34270	64752	93385	66500	405
1.222	0.93978	47691	55418	86621	257	0.34176	68615	64277	57501	890
1.223	0.94012	60660	67676	58302	957	0.34082	69060	68336	40132	702
1.224	0.94046	64228	53946	57600	622	0.33988	66097	45517	56153	996
1.225	0.94080	58391	73872	08723	559	0.33894	59735	36117	30011	855
1.226	0.94114	43146	88036	82507	685	0.33800	49983	80771	74807	668
1.227	0.94148	18490	57965	30357	157	0.33706	36852	20455	98234	533
1.228	0.94181	84419	46123	18091	912	0.33612	20349	96483	08479	750
1.229	0.94215	40930	15917	59701	104	0.33518	00486	50503	20093	523
1.230	0.94248	88019	31697	51002	382	0.33423	77271	24502	59823	955
1.231	0.94282	25683	58754	03206	998	0.33329	50713	60802	72418	427
1.232	0.94315	53919	63320	76390	684	0.33235	20823	02059	26391	462
1.233	0.94348	72724	12574	12870	299	0.33140	87608	91261	19759	164
1.234	0.94381	82093	74633	70486	175	0.33046	51080	71729	85740	328
1.235	0.94414	82025	18562	55790	164	0.32952	11247	87117	98424	316
1.236	0.94447	72515	14367	57139	322	0.32857	68119	81408	78405	786
1.237	0.94480	53560	32999	77695	223	0.32763	21705	98914	98386	387
1.238	0.94513	25157	46354	68328	851	0.32668	72015	84277	88743	487
1.239	0.94545	87303	27272	60431	046	0.32574	19058	82466	43066	054
1.240	0.94578	39994	49538	98628	471	0.32479	62844	38776	23657	769
1.241	0.94610	83227	87884	73405	063	0.32385	03381	98828	67007	475
1.242	0.94643	17000	17986	53628	942	0.32290	40681	08569	89227	042
1.243	0.94675	41308	16467	18984	738	0.32195	74751	14269	91456	764
1.244	0.94707	56148	60895	92311	309	0.32101	05601	62521	65238	364
1.245	0.94739	61518	29788	71844	815	0.32006	33242	00239	97855	712
1.246	0.94771	57414	02608	63367	118	0.31911	57681	74660	77643	341
1.247	0.94803	43832	59766	12259	472	0.31816	78930	33339	99262	871
1.248	0.94835	20770	82619	35461	479	0.31721	96997	24152	68947	423
1.249	0.94866	88225	53474	53335	262	0.31627	11891	95292	09714	116
1.250	0.94898	46193	55586	21434	849	0.31532	23623	95268	66544	754
			$\left[\begin{smallmatrix} (-7)1 \\ 7 \end{smallmatrix} \right]$					$\left[\begin{smallmatrix} (-8)5 \\ 7 \end{smallmatrix} \right]$		

CIRCULAR SINES AND COSINES FOR RADIAN ARGUMENTS Table 4.6

x	sin x					cos x				
1.250	0.94898	46193	55586	21434	849	0.31532	23623	95268	66544	754
1.251	0.94929	94671	73157	62180	713	0.31437	32202	72909	11534	791
1.252	0.94961	33656	91340	96439	444	0.31342	37637	77355	49010	665
1.253	0.94992	63145	96237	75008	528	0.31247	39938	58064	20615	601
1.254	0.95023	83135	74899	10006	196	0.31152	39114	64805	10363	979
1.255	0.95054	93623	15326	06166	303	0.31057	35175	47660	49664	355
1.256	0.95085	94605	06469	92038	225	0.30962	28130	57024	22311	242
1.257	0.95116	86078	38232	51091	729	0.30867	17989	43600	69445	729
1.258	0.95147	68040	01466	52726	783	0.30772	04761	58403	94485	052
1.259	0.95178	40486	87975	83188	287	0.30676	88456	52756	68021	196
1.260	0.95209	03415	90515	76385	682	0.30581	69083	78289	32688	634
1.261	0.95239	56824	02793	44617	416	0.30486	46652	86939	08001	291
1.262	0.95270	00708	19468	09200	227	0.30391	21173	30948	95158	833
1.263	0.95300	35065	36151	31003	222	0.30295	92654	62866	81822	373
1.264	0.95330	59892	49407	40886	709	0.30200	61106	35544	46859	693
1.265	0.95360	75186	56753	70045	767	0.30105	26538	02136	65060	070
1.266	0.95390	80944	56660	80258	512	0.30009	88959	16100	11818	814
1.267	0.95420	77163	48552	94039	032	0.29914	48379	31192	67791	595
1.268	0.95450	63840	32808	24694	963	0.29819	04808	01472	23518	675
1.269	0.95480	40972	10759	06289	671	0.29723	58254	81295	84019	121
1.270	0.95510	08555	84692	23509	018	0.29628	08729	25318	73355	114
1.271	0.95539	66588	57849	41432	673	0.29532	56240	88493	39166	425
1.272	0.95569	15067	34427	35209	944	0.29437	00799	26068	57175	182
1.273	0.95598	53989	19578	19640	104	0.29341	42413	93588	35661	000
1.274	0.95627	83351	19409	78657	170	0.29245	81094	46891	19906	579
1.275	0.95657	03150	40985	94719	118	0.29150	16850	42108	96613	869
1.276	0.95686	13383	92326	78101	497	0.29054	49691	35665	98290	890
1.277	0.95715	14048	82408	96095	419	0.28958	79626	84278	07609	308
1.278	0.95744	05142	21166	02109	886	0.28863	06666	44951	61732	860
1.279	0.95772	86661	19488	64678	437	0.28767	30819	74982	56616	726
1.280	0.95801	58602	89224	96370	075	0.28671	52096	31955	51277	939
1.281	0.95830	20964	43180	82604	453	0.28575	70505	73742	72036	934
1.282	0.95858	73742	95120	10371	286	0.28479	86057	58503	16730	332
1.283	0.95887	16935	59764	96853	962	0.28383	98761	44681	58895	050
1.284	0.95915	50539	52796	17957	320	0.28288	08626	91007	51923	831
1.285	0.95943	74551	90853	36739	577	0.28192	15663	56494	33192	303
1.286	0.95971	88969	91535	31748	357	0.28096	19881	00438	28157	651
1.287	0.95999	93790	73400	25260	814	0.28000	21288	82417	54428	993
1.288	0.96027	89011	55966	11427	805	0.27904	19896	62291	25809	577
1.289	0.96055	74629	59710	84322	094	0.27808	15714	00198	56310	871
1.290	0.96083	50642	06072	65890	556	0.27712	08750	56557	64138	661
1.291	0.96111	17046	17450	33810	354	0.27615	99015	92064	75651	234
1.292	0.96138	73839	17203	49249	056	0.27519	86519	67693	29289	769
1.293	0.96166	21018	29652	84528	675	0.27423	71271	44692	79480	997
1.294	0.96193	58580	80080	50693	590	0.27327	53280	84588	00512	263
1.295	0.96220	86523	94730	24982	339	0.27231	32557	49177	90379	053
1.296	0.96248	04845	00807	78203	231	0.27135	09111	00534	74605	108
1.297	0.96275	13541	26481	02013	782	0.27038	82951	01003	10035	206
1.298	0.96302	12610	00880	36103	915	0.26942	54087	13198	88600	711
1.299	0.96329	02048	54098	95282	920	0.26846	22529	00008	41057	992
1.300	0.96355	81854	17192	96470	135	0.26749	88286	24587	40699	798
			$\left[\begin{smallmatrix} (-7)1 \\ 7 \end{smallmatrix} \right]$						$\left[\begin{smallmatrix} (-8)4 \\ 7 \end{smallmatrix} \right]$	

Table 4.6 CIRCULAR SINES AND COSINES FOR RADIAN ARGUMENTS

x	sin x					cos x				
1.300	0.96355	81854	17192	96470	135	0.26749	88286	24587	40699	798
1.301	0.96382	52024	22181	85589	331	0.26653	51368	50360	07039	695
1.302	0.96409	12556	02048	64366	761	0.26557	11785	41018	09469	650
1.303	0.96435	63446	90740	17032	855	0.26460	69546	60519	70890	877
1.304	0.96462	04694	23167	36927	537	0.26364	24661	73088	71318	016
1.305	0.96488	36295	35205	53009	126	0.26267	77140	43213	51456	761
1.306	0.96514	58247	63694	56266	806	0.26171	26992	35646	16255	031
1.307	0.96540	70548	46439	26036	635	0.26074	74227	15401	38427	774
1.308	0.96566	73195	22209	56221	061	0.25978	18854	47755	61955	494
1.309	0.96592	66185	30740	81411	924	0.25881	60883	98246	05556	626
1.310	0.96618	49516	12734	02916	926	0.25785	00325	32669	66133	818
1.311	0.96644	23185	09856	14689	520	0.25688	37188	17082	22194	242
1.312	0.96669	87189	64740	29162	218	0.25591	71482	17797	37244	030
1.313	0.96695	41527	20986	02983	276	0.25495	03217	01385	63156	911
1.314	0.96720	86195	23159	62656	736	0.25398	32402	34673	43517	173
1.315	0.96746	21191	16794	30085	794	0.25301	59047	84742	16937	022
1.316	0.96771	46512	48390	48019	478	0.25204	83163	18927	20348	457
1.317	0.96796	62156	65416	05402	607	0.25108	04758	04816	92269	738
1.318	0.96821	68121	16306	62628	991	0.25011	23842	10251	76046	556
1.319	0.96846	64403	50465	76697	879	0.24914	40425	03323	23067	996
1.320	0.96871	51001	18265	26273	590	0.24817	54516	52372	95957	398
1.321	0.96896	27911	71045	36648	340	0.24720	66126	25991	71738	199
1.322	0.96920	95132	61115	04608	211	0.24623	75263	93018	44974	865
1.323	0.96945	52661	41752	23202	252	0.24526	81939	22539	30889	004
1.324	0.96970	00495	67204	06414	685	0.24429	86161	83886	68450	760
1.325	0.96994	38632	92687	13740	188	0.24332	87941	46638	23445	582
1.326	0.97018	67070	74387	74662	236	0.24235	87287	80615	91516	463
1.327	0.97042	85806	69462	13034	465	0.24138	84210	55885	01181	759
1.328	0.97066	94838	36036	71365	051	0.24041	78719	42753	16828	662
1.329	0.97090	94163	33208	35004	060	0.23944	70824	11769	41682	448
1.330	0.97114	83779	21044	56233	768	0.23847	60534	33723	20751	578
1.331	0.97138	63683	60583	78261	900	0.23750	47859	79643	43748	768
1.332	0.97162	33874	13835	59117	786	0.23653	32810	20797	47988	097
1.333	0.97185	94348	43780	95451	405	0.23556	15395	28690	21258	288
1.334	0.97209	45104	14372	46235	282	0.23458	95624	75063	04672	221
1.335	0.97232	86138	90534	56369	230	0.23361	73508	31892	95492	805
1.336	0.97256	17450	38163	80187	900	0.23264	49055	71391	49935	286
1.337	0.97279	39036	24129	04871	129	0.23167	22276	66003	85946	099
1.338	0.97302	50894	16271	73757	046	0.23069	93180	88407	85958	358
1.339	0.97325	53021	83406	09557	931	0.22972	61778	11512	99624	085
1.340	0.97348	45416	95319	37478	787	0.22875	28078	08459	46523	264
1.341	0.97371	28077	22772	08238	616	0.22777	92090	52617	18849	831
1.342	0.97394	01000	37498	20994	365	0.22680	53825	17584	84074	691
1.343	0.97416	64184	12205	46167	522	0.22583	13291	77188	87585	859
1.344	0.97439	17626	20575	48173	349	0.22485	70500	05482	55305	819
1.345	0.97461	61324	37264	08052	713	0.22388	25459	76744	96286	212
1.346	0.97483	95276	37901	46006	501	0.22290	78180	65480	05279	929
1.347	0.97506	19479	99092	43832	603	0.22193	28672	46415	65290	729
1.348	0.97528	33932	98416	67265	423	0.22095	76944	94502	50100	463
1.349	0.97550	38633	14428	88217	916	0.21998	23007	84913	26774	007
1.350	0.97572	33578	26659	06926	111	0.21900	66870	93041	58142	002

$$\left[\begin{array}{c} (-7)1 \\ 7 \end{array} \right]$$

$$\left[\begin{array}{c} (-8)3 \\ 7 \end{array} \right]$$

CIRCULAR SINES AND COSINES FOR RADIAN ARGUMENTS Table 4.6

x	sin x					cos x				
1.350	0.97572	33578	26659	06926	111	0.21900	66870	93041	58142	002
1.351	0.97594	18766	15612	73996	110	0.21803	08543	94501	05261	504
1.352	0.97615	94194	62771	12353	536	0.21705	48036	65124	29854	627
1.353	0.97637	59861	50591	39095	407	0.21607	85358	80961	96725	291
1.354	0.97659	15764	62506	87244	418	0.21510	20520	18281	76154	163
1.355	0.97680	61901	82927	27405	609	0.21412	53530	53567	46271	899
1.356	0.97701	98270	97238	89325	386	0.21314	84399	63517	95410	772
1.357	0.97723	24869	91804	83352	894	0.21217	13137	25046	24434	790
1.358	0.97744	41696	53965	21803	706	0.21119	39753	15278	49048	406
1.359	0.97765	48748	72037	40225	805	0.21021	64257	11553	02083	908
1.360	0.97786	46024	35316	18567	849	0.20923	86658	91419	35767	598
1.361	0.97807	33521	34074	02249	690	0.20826	06968	32637	23964	842
1.362	0.97828	11237	59561	23135	125	0.20728	25195	13175	64404	112
1.363	0.97848	79171	04006	20406	864	0.20630	41349	11211	80880	089
1.364	0.97869	37319	60615	61343	685	0.20532	55440	05130	25435	952
1.365	0.97889	85681	23574	61999	774	0.20434	67477	73521	80524	932
1.366	0.97910	24253	88047	07786	196	0.20336	77471	95182	61151	240
1.367	0.97930	53035	50175	73954	516	0.20238	85432	49113	16990	457
1.368	0.97950	72024	07082	45982	521	0.20140	91369	14517	34489	495
1.369	0.97970	81217	56868	39862	027	0.20042	95291	70801	38946	217
1.370	0.97990	80613	98614	22288	769	0.19944	97209	97572	96568	820
1.371	0.98010	70211	32380	30754	328	0.19846	97133	74640	16515	079
1.372	0.98030	50007	59206	93540	094	0.19748	95072	82010	52911	545
1.373	0.98050	20000	81114	49613	233	0.19650	91036	99890	06852	798
1.374	0.98069	80189	01103	68424	652	0.19552	85036	08682	28380	853
1.375	0.98089	30570	23155	69608	920	0.19454	77079	88987	18444	822
1.376	0.98108	71142	52232	42586	155	0.19356	67178	21600	30840	918
1.377	0.98128	01903	94276	66065	826	0.19258	55340	87511	74132	912
1.378	0.98147	22852	56212	27452	479	0.19160	41577	67905	13553	129
1.379	0.98166	33986	45944	42153	343	0.19062	25898	44156	72884	094
1.380	0.98185	35303	72359	72787	813	0.18964	08312	97834	36320	915
1.381	0.98204	26802	45326	48298	791	0.18865	88831	10696	50314	508
1.382	0.98223	08480	75694	82965	850	0.18767	67462	64691	25395	757
1.383	0.98241	80336	75296	95320	221	0.18669	44217	41955	37980	715
1.384	0.98260	42368	56947	26961	571	0.18571	19105	24813	32156	930
1.385	0.98278	94574	34442	61276	561	0.18472	92135	95776	21451	016
1.386	0.98297	36952	22562	42059	162	0.18374	63319	37540	90577	542
1.387	0.98315	69500	37068	92032	708	0.18276	32665	32988	97169	360
1.388	0.98333	92216	94707	31273	673	0.18178	00183	65185	73489	451
1.389	0.98352	05100	13205	95537	148	0.18079	65884	17379	28124	404
1.390	0.98370	08148	11276	54484	004	0.17981	29776	72999	47659	616
1.391	0.98388	01359	08614	29809	722	0.17882	91871	15656	98336	311
1.392	0.98405	84731	25898	13274	870	0.17784	52177	29142	27690	484
1.393	0.98423	58262	84790	84637	207	0.17686	10704	97424	66173	860
1.394	0.98441	21952	07939	29485	405	0.17587	67464	04651	28756	976
1.395	0.98458	75797	18974	56974	360	0.17489	22464	35146	16514	467
1.396	0.98476	19796	42512	17462	083	0.17390	75715	73409	18192	681
1.397	0.98493	53948	04152	20048	145	0.17292	27228	04115	11759	690
1.398	0.98510	78250	30479	50013	670	0.17193	77011	12112	65937	830
1.399	0.98527	92701	49063	86162	846	0.17095	25074	82423	41718	833
1.400	0.98544	97299	88460	18065	947	0.16996	71429	00240	93861	675

$$\begin{bmatrix} (-7)1 \\ 7 \end{bmatrix}$$

$$\begin{bmatrix} (-8)3 \\ 7 \end{bmatrix}$$

Table 4.6 CIRCULAR SINES AND COSINES FOR RADIAN ARGUMENTS

x	$\sin x$					$\cos x$				
1.400	0.98544	97299	88460	18065	947	0.16996	71429	00240	93861	675
1.401	0.98561	92043	78208	63203	840	0.16898	16083	50929	72373	233
1.402	0.98578	76931	48834	84013	966	0.16799	59048	20024	23971	842
1.403	0.98595	51961	31850	04837	776	0.16701	00332	93227	93533	854
1.404	0.98612	17131	59751	28769	609	0.16602	39947	56412	25523	303
1.405	0.98628	72440	66021	54406	982	0.16503	77901	95615	65404	770
1.406	0.98645	17886	85129	92502	294	0.16405	14205	97042	61039	544
1.407	0.98661	53468	52531	82515	912	0.16306	48869	47062	64065	184
1.408	0.98677	79184	04669	09070	631	0.16207	81902	32209	31258	571
1.409	0.98693	95031	78970	18307	486	0.16109	13314	39179	25882	568
1.410	0.98710	01010	13850	34142	909	0.16010	43115	54831	19016	356
1.411	0.98725	97117	48711	74427	198	0.15911	71315	66184	90869	577
1.412	0.98741	83352	23943	67004	304	0.15812	97924	60420	32080	359
1.413	0.98757	59712	80922	65672	895	0.15714	22952	24876	44997	336
1.414	0.98773	26197	62012	66048	706	0.15615	46408	47050	44945	751
1.415	0.98788	82805	10565	21328	142	0.15516	68303	14596	61477	752
1.416	0.98804	29533	70919	57953	120	0.15417	88646	15325	39606	967
1.417	0.98819	66381	88402	91177	144	0.15319	07447	37202	41027	471
1.418	0.98834	93348	09330	40532	586	0.15220	24716	68347	45317	231
1.419	0.98850	10430	81005	45199	170	0.15121	40463	97033	51126	135
1.420	0.98865	17628	51719	79273	627	0.15022	54699	11685	77348	698
1.421	0.98880	14939	70753	66940	521	0.14923	67432	00880	64281	559
1.422	0.98895	02362	88375	97544	222	0.14824	78672	53344	74765	840
1.423	0.98909	79896	55844	40562	021	0.14725	88430	57953	95314	499
1.424	0.98924	47539	25405	60478	351	0.14626	96716	03732	37224	747
1.425	0.98939	05289	50295	31560	129	0.14528	03538	79851	37675	648
1.426	0.98953	53145	84738	52533	174	0.14429	08908	75628	60810	986
1.427	0.98967	91106	83949	61159	714	0.14330	12835	80526	98807	514
1.428	0.98982	19171	04132	48716	941	0.14231	15329	84153	72928	666
1.429	0.98996	37337	02480	74376	619	0.14132	16400	76259	34563	848
1.430	0.99010	45603	37177	79485	729	0.14033	16058	46736	66253	390
1.431	0.99024	43968	67397	01748	121	0.13934	14312	85619	82699	275
1.432	0.99038	32431	53301	89307	176	0.13835	11173	83083	31761	733
1.433	0.99052	10990	56046	14729	460	0.13736	06651	29440	95441	799
1.434	0.99065	79644	37773	88889	346	0.13637	00755	15144	90849	940
1.435	0.99079	38391	61619	74754	605	0.13537	93495	30784	71160	849
1.436	0.99092	87230	91709	01072	941	0.13438	84881	67086	26554	495
1.437	0.99106	26160	93157	75959	459	0.13339	74924	14910	85143	546
1.438	0.99119	55180	32073	00385	060	0.13240	63632	65254	13887	244
1.439	0.99132	74287	75552	81565	735	0.13141	51017	09245	19491	852
1.440	0.99145	83481	91686	46252	760	0.13042	37087	38145	49297	752
1.441	0.99158	82761	49554	53923	766	0.12943	21853	43347	92153	306
1.442	0.99171	72125	19229	09874	676	0.12844	05325	16375	79275	576
1.443	0.99184	51571	71773	78212	505	0.12744	87512	48881	85098	002
1.444	0.99197	21099	79243	94748	990	0.12645	68425	32647	28105	135
1.445	0.99209	80708	14686	79795	055	0.12546	48073	59580	71654	525
1.446	0.99222	30395	52141	50856	088	0.12447	26467	21717	24785	871
1.447	0.99234	70160	66639	35228	024	0.12348	03616	11217	43017	513
1.448	0.99247	00002	34203	82494	216	0.12248	79530	20366	29130	391
1.449	0.99259	19919	31850	76923	086	0.12149	54219	41572	33939	548
1.450	0.99271	29910	37588	49766	535	0.12050	27693	67366	57053	287
			$\left[\begin{smallmatrix} (-7)1 \\ 7 \end{smallmatrix} \right]$						$\left[\begin{smallmatrix} (-8)2 \\ 7 \end{smallmatrix} \right]$	

CIRCULAR SINES AND COSINES FOR RADIAN ARGUMENTS Table 4.6

x	sin x					cos x				
1.450	0.99271	29910	37588	49766	535	0.12050	27693	67366	57053	287
1.451	0.99283	29974	30417	91459	118	0.11950	99962	90401	47620	080
1.452	0.99295	20109	90332	63717	946	0.11851	71037	03450	05063	327
1.453	0.99307	00315	98319	11543	325	0.11752	40925	99404	79804	068
1.454	0.99318	70591	36356	75120	114	0.11653	09639	71276	73971	735
1.455	0.99330	30934	87418	01619	777	0.11553	77188	12194	42103	061
1.456	0.99341	81345	35468	56903	143	0.11454	43581	15402	91829	237
1.457	0.99353	21821	65467	37123	830	0.11355	08828	74262	84551	407
1.458	0.99364	52362	63366	80232	355	0.11255	72940	82249	36104	618
1.459	0.99375	72967	16112	77380	893	0.11156	35927	32951	17410	313
1.460	0.99386	83634	11644	84228	683	0.11056	97798	20069	55117	465
1.461	0.99397	84362	38896	32148	075	0.10957	58563	37417	32232	463
1.462	0.99408	75150	87794	39331	194	0.10858	18232	78917	88737	835
1.463	0.99419	55998	49260	21797	223	0.10758	76816	38604	22199	915
1.464	0.99430	26904	15209	04300	286	0.10659	34324	10617	88365	556
1.465	0.99440	87866	78550	31137	923	0.10559	90765	89208	01747	983
1.466	0.99451	38885	33187	76860	141	0.10460	46151	68730	36201	884
1.467	0.99461	79958	74019	56879	043	0.10361	00491	43646	25487	846
1.468	0.99472	11085	96938	37979	012	0.10261	53795	08521	63826	230
1.469	0.99482	32265	98831	48727	437	0.10162	06072	58026	06440	584
1.470	0.99492	43497	77580	89785	993	0.10062	57333	86931	70090	698
1.471	0.99502	44780	32063	44122	430	0.09963	07588	90112	33595	391
1.472	0.99512	36112	62150	87122	898	0.09863	56847	62542	38345	147
1.473	0.99522	17493	68709	96604	762	0.09764	05119	99295	88804	678
1.474	0.99531	88922	53602	62729	932	0.09664	52415	95545	53005	525
1.475	0.99541	50398	19685	97818	664	0.09564	98745	46561	63028	806
1.476	0.99551	01919	70812	46063	854	0.09465	44118	47711	15478	186
1.477	0.99560	43486	11829	93145	787	0.09365	88544	94456	71943	189
1.478	0.99569	75096	48581	75747	356	0.09266	32034	82355	59452	948
1.479	0.99578	96749	87906	90969	720	0.09166	74598	07058	70920	484
1.480	0.99588	08445	37640	05648	408	0.09067	16244	64309	65577	623
1.481	0.99597	10182	06611	65569	851	0.08967	56984	49943	69400	641
1.482	0.99606	01959	04648	04588	337	0.08867	96827	59886	75526	752
1.483	0.99614	83775	42571	53643	374	0.08768	35783	90154	44661	519
1.484	0.99623	55630	32200	49677	461	0.08668	73863	36851	05477	303
1.485	0.99632	17522	86349	44454	246	0.08569	11075	96168	55002	845
1.486	0.99640	69452	18829	13277	079	0.08469	47431	64385	59004	070
1.487	0.99649	11417	44446	63607	933	0.08369	82940	37866	52356	240
1.488	0.99657	43417	79005	43586	693	0.08270	17612	13060	39407	518
1.489	0.99665	65452	39305	50450	815	0.08170	51456	86499	94334	076
1.490	0.99673	77520	43143	38855	320	0.08070	84484	54800	61486	832
1.491	0.99681	79621	09312	29093	143	0.07971	16705	14659	55729	907
1.492	0.99689	71753	57602	15215	811	0.07871	48128	62854	62770	926
1.493	0.99697	53917	08799	73054	448	0.07771	78764	96243	39483	234
1.494	0.99705	26110	84688	68141	099	0.07672	08624	11762	14220	152
1.495	0.99712	88334	08049	63530	364	0.07572	37716	06424	87121	354
1.496	0.99720	40586	02660	27521	334	0.07472	66050	77322	30411	478
1.497	0.99727	82865	93295	41279	821	0.07372	93638	21620	88691	060
1.498	0.99735	15173	05727	06360	877	0.07273	20488	36561	79219	898
1.499	0.99742	37506	66724	52131	595	0.07173	46611	19459	92192	943
1.500	0.99749	49866	04054	43094	172	0.07073	72016	67702	91008	819
			$\left[\begin{smallmatrix} (-7)1 \\ 7 \end{smallmatrix} \right]$					$\left[\begin{smallmatrix} (-8)2 \\ 7 \end{smallmatrix} \right]$		

Table 4.6 CIRCULAR SINES AND COSINES FOR RADIAN ARGUMENTS

x	sin x					cos x				
1.500	0.99749	49866	04054	43094	172	0.07073	72016	67702	91008	819
1.501	0.99756	52250	46480	86109	251	0.06973	96714	78750	12531	065
1.502	0.99763	44659	23765	37519	509	0.06874	20715	50131	67342	208
1.503	0.99770	27091	66667	10173	501	0.06774	44028	79447	39990	761
1.504	0.99776	99547	06942	80349	750	0.06674	66664	64365	89231	245
1.505	0.99783	62024	77346	94581	063	0.06574	88633	02623	48257	343
1.506	0.99790	14524	11631	76379	092	0.06475	09943	92023	24928	268
1.507	0.99796	57044	44547	32859	104	0.06375	30607	30434	01988	470
1.508	0.99802	89585	11841	61264	976	0.06275	50633	15789	37280	758
1.509	0.99809	12145	50260	55394	397	0.06175	70031	46086	63952	953
1.510	0.99815	24724	97548	11924	274	0.06075	88812	19385	90658	160
1.511	0.99821	27322	92446	36636	332	0.05976	06985	33809	01748	769
1.512	0.99827	19938	74695	50542	912	0.05876	24560	87538	57464	281
1.513	0.99833	02571	85033	95912	947	0.05776	41548	78816	94113	053
1.514	0.99838	75221	65198	42198	118	0.05676	57959	05945	24248	072
1.515	0.99844	37887	57923	91859	188	0.05576	73801	67282	36836	851
1.516	0.99849	90569	06943	86092	495	0.05476	89086	61243	97425	545
1.517	0.99855	33265	56990	10456	612	0.05377	03823	86301	48297	399
1.518	0.99860	65976	53793	00399	163	0.05277	18023	40981	08625	609
1.519	0.99865	88701	44081	46683	784	0.05177	31695	23862	74620	716
1.520	0.99871	01439	75583	00717	231	0.05077	44849	33579	19672	613
1.521	0.99876	04190	97023	79776	634	0.04977	57495	68814	94487	284
1.522	0.99880	96954	58128	72136	872	0.04877	69644	28305	27218	360
1.523	0.99885	79730	09621	42098	089	0.04777	81305	10835	23593	598
1.524	0.99890	52517	03224	34913	328	0.04677	92488	15238	67036	388
1.525	0.99895	15314	91658	81616	285	0.04578	03203	40397	18782	371
1.526	0.99899	68123	28645	03749	180	0.04478	13460	85239	17991	291
1.527	0.99904	10941	68902	17990	729	0.04378	23270	48738	81854	166
1.528	0.99908	43769	68148	40684	234	0.04278	32642	29915	05695	871
1.529	0.99912	66606	83100	92265	762	0.04178	41586	27830	63073	262
1.530	0.99916	79452	71476	01592	427	0.04078	50112	41591	05868	899
1.531	0.99920	82306	91989	10170	755	0.03978	58230	70343	64380	513
1.532	0.99924	75169	04354	76285	152	0.03878	65951	13276	47406	277
1.533	0.99928	58038	69286	79026	436	0.03778	73283	69617	42326	008
1.534	0.99932	30915	48498	22220	463	0.03678	80238	38633	15178	390
1.535	0.99935	93799	04701	38256	819	0.03578	86825	19628	10734	312
1.536	0.99939	46689	01607	91817	592	0.03478	93054	11943	52566	435
1.537	0.99942	89585	03928	83506	202	0.03378	98935	14956	43115	073
1.538	0.99946	22486	77374	53376	306	0.03279	04478	28078	63750	505
1.539	0.99949	45393	88654	84360	752	0.03179	09693	50755	74831	796
1.540	0.99952	58306	05479	05600	596	0.03079	14590	82466	15762	248
1.541	0.99955	61222	96555	95674	180	0.02979	19180	22720	05041	568
1.542	0.99958	54144	31593	85726	242	0.02879	23471	71058	40314	858
1.543	0.99961	37069	81300	62497	095	0.02779	27475	27051	98418	526
1.544	0.99964	09999	17383	71251	832	0.02679	31200	90300	35423	217
1.545	0.99966	72932	12550	18609	586	0.02579	34658	60430	86673	867
1.546	0.99969	25868	40506	75272	821	0.02479	37858	37097	66826	971
1.547	0.99971	68807	75959	78656	660	0.02379	40810	19980	69885	184
1.548	0.99974	01749	94615	35418	249	0.02279	43524	08784	69229	328
1.549	0.99976	24694	73179	23886	150	0.02179	46010	03238	17647	934
1.550	0.99978	37641	89356	96389	761	0.02079	48278	03092	47364	391
			$\begin{bmatrix} (-7)1 \\ 7 \end{bmatrix}$						$\begin{bmatrix} (-9)9 \\ 7 \end{bmatrix}$	

CIRCULAR SINES AND COSINES FOR RADIAN ARGUMENTS Table 4.6

x	sin x					cos x					
1.550	0.99978	37641	89356	96389	761	0.02079	48278	03092	47364	391	
1.551	0.99980	40591	21853	81488	767	0.01979	50338	08120	70061	827	
1.552	0.99982	33542	50374	86102	606	0.01879	52200	18116	76905	802	
1.553	0.99984	16495	55624	97539	966	0.01779	53874	32894	38564	929	
1.554	0.99985	89450	19308	85428	298	0.01679	55370	52286	05229	507	
1.555	0.99987	52406	24131	03543	342	0.01579	56698	76142	06628	284	
1.556	0.99989	05363	53795	91538	676	0.01479	57869	04329	52043	433	
1.557	0.99990	48321	93007	76575	277	0.01379	58891	36731	30323	849	
1.558	0.99991	81281	27470	74851	093	0.01279	59775	73245	09896	874	
1.559	0.99993	04241	43888	93030	623	0.01179	60532	13782	38778	533	
1.560	0.99994	17202	29966	29574	517	0.01079	61170	58267	44582	392	
1.561	0.99995	20163	74406	75969	172	0.00979	61701	06636	34527	146	
1.562	0.99996	13125	66914	17856	344	0.00879	62133	58835	95443	014	
1.563	0.99996	96087	98192	36062	758	0.00779	62478	14822	93777	062	
1.564	0.99997	69050	59945	07529	731	0.00679	62744	74562	75597	546	
1.565	0.99998	32013	44876	06142	794	0.00579	62943	38028	66597	372	
1.566	0.99998	84976	46689	03461	318	0.00479	63084	05200	72096	784	
1.567	0.99999	27939	60087	69348	142	0.00379	63176	76064	77045	359	
1.568	0.99999	60902	80775	72499	201	0.00279	63231	50611	46023	436	
1.569	0.99999	83866	05456	80873	162	0.00179	63258	28835	23243	059	
1.570	0.99999	96829	31834	62021	053	+0.00079	63267	10733	32548	541	
1.571	0.99999	99792	58612	83315	895	-0.00020	36732	03695	22583	254	
1.572	0.99999	92755	85495	12082	337	-0.00120	36729	14450	59042	804	
1.573	0.99999	75719	13185	15626	285	-0.00220	36714	21533	14087	901	
1.574	0.99999	48682	43386	61164	539	-0.00320	36677	24944	45343	613	
1.575	0.99999	11645	78803	15654	423	-0.00420	36608	24688	30802	109	
1.576	0.99998	64609	23138	45523	419	-0.00520	36497	20771	68822	280	
1.577	0.99998	07572	81096	16298	798	-0.00620	36334	13205	78129	029	
1.578	0.99997	40536	58379	92137	261	-0.00720	36109	02006	97812	142	
1.579	0.99996	63500	61693	35254	568	-0.00820	35811	87197	87324	647	
1.580	0.99995	76464	98740	05255	179	-0.00920	35432	68808	26480	539	
1.581	0.99994	79429	78223	58361	895	-0.01020	34961	46876	15451	796	
1.582	0.99993	72395	09847	46545	499	-0.01120	34388	21448	74764	568	
1.583	0.99992	55361	04315	16554	408	-0.01220	33702	92583	45294	454	
1.584	0.99991	28327	73330	08844	324	-0.01320	32895	60348	88260	743	
1.585	0.99989	91295	29595	56407	893	-0.01420	31956	24825	85219	553	
1.586	0.99988	44263	86814	83504	374	-0.01520	30874	86108	38055	737	
1.587	0.99986	87233	59691	04289	313	-0.01620	29641	44304	68973	475	
1.588	0.99985	20204	63927	21344	232	-0.01720	28245	99538	20485	440	
1.589	0.99983	43177	16226	24106	322	-0.01820	26678	51948	55400	452	
1.590	0.99981	56151	34290	87198	158	-0.01920	24929	01692	56809	503	
1.591	0.99979	59127	36823	68657	422	-0.02020	22987	48945	28070	065	
1.592	0.99977	52105	43527	08066	646	-0.02120	20843	93900	92788	583	
1.593	0.99975	35085	75103	24582	972	-0.02220	18488	36773	94801	039	
1.594	0.99973	08068	53254	14867	933	-0.02320	15910	77799	98151	502	
1.595	0.99970	71054	00681	50917	259	-0.02420	13101	17236	87068	552	
1.596	0.99968	24042	41086	77790	702	-0.02520	10049	55365	65939	492	
1.597	0.99965	67033	99171	11241	891	-0.02620	06745	92491	59282	234	
1.598	0.99963	00029	00635	35248	219	-0.02720	03180	28945	11714	764	
1.599	0.99960	23027	72179	99440	759	-0.02819	99342	65082	87922	093	
1.600	0.99957	36030	41505	16434	211	-0.02919	95223	01288	72620	577	
		$\left[\begin{smallmatrix} (-7)1 \\ 7 \end{smallmatrix} \right]$						$\left[\begin{smallmatrix} (-9)3 \\ 7 \end{smallmatrix} \right]$			

For $x > 1.6$ see Example 16.

$$\frac{\pi}{2} = 1.57079 \ 63267 \ 94896 \ 61923 \ 132 \quad \pi = 3.14159 \ 26535 \ 89793 \ 23846 \ 264$$

Table 4.7

RADIX TABLE OF CIRCULAR SINES AND COSINES

x	n	$\sin x10^{-n}$					$\cos x10^{-n}$				
1	10	0.00000	00001	00000	00000	00000	0.99999	99999	99999	99999	50000
2	10	0.00000	00002	00000	00000	00000	0.99999	99999	99999	99998	00000
3	10	0.00000	00003	00000	00000	00000	0.99999	99999	99999	99995	50000
4	10	0.00000	00004	00000	00000	00000	0.99999	99999	99999	99992	00000
5	10	0.00000	00005	00000	00000	00000	0.99999	99999	99999	99987	50000
6	10	0.00000	00006	00000	00000	00000	0.99999	99999	99999	99982	00000
7	10	0.00000	00007	00000	00000	00000	0.99999	99999	99999	99975	50000
8	10	0.00000	00008	00000	00000	00000	0.99999	99999	99999	99968	00000
9	10	0.00000	00009	00000	00000	00000	0.99999	99999	99999	99959	50000
1	9	0.00000	00010	00000	00000	00000	0.99999	99999	99999	99950	00000
2	9	0.00000	00020	00000	00000	00000	0.99999	99999	99999	99800	00000
3	9	0.00000	00030	00000	00000	00000	0.99999	99999	99999	99550	00000
4	9	0.00000	00040	00000	00000	00000	0.99999	99999	99999	99200	00000
5	9	0.00000	00050	00000	00000	00000	0.99999	99999	99999	98750	00000
6	9	0.00000	00060	00000	00000	00000	0.99999	99999	99999	98200	00000
7	9	0.00000	00069	99999	99999	99999	0.99999	99999	99999	97750	50000
8	9	0.00000	00079	99999	99999	99999	0.99999	99999	99999	96800	00000
9	9	0.00000	00089	99999	99999	99999	0.99999	99999	99999	95950	00000
1	8	0.00000	00099	99999	99999	99998	0.99999	99999	99999	95000	00000
2	8	0.00000	00199	99999	99999	99987	0.99999	99999	99999	80000	00000
3	8	0.00000	00299	99999	99999	99955	0.99999	99999	99999	55000	00000
4	8	0.00000	00399	99999	99999	99893	0.99999	99999	99999	20000	00000
5	8	0.00000	00499	99999	99999	99792	0.99999	99999	99998	75000	00000
6	8	0.00000	00599	99999	99999	99640	0.99999	99999	99998	20000	00000
7	8	0.00000	00699	99999	99999	99428	0.99999	99999	99997	55000	00000
8	8	0.00000	00799	99999	99999	99147	0.99999	99999	99996	80000	00000
9	8	0.00000	00899	99999	99999	98785	0.99999	99999	99995	95000	00000
1	7	0.00000	00999	99999	99999	98333	0.99999	99999	99995	00000	00000
2	7	0.00000	01999	99999	99999	86667	0.99999	99999	99980	00000	00000
3	7	0.00000	02999	99999	99999	55000	0.99999	99999	99955	00000	00000
4	7	0.00000	03999	99999	99998	93333	0.99999	99999	99920	00000	00000
5	7	0.00000	04999	99999	99997	91667	0.99999	99999	99875	00000	00000
6	7	0.00000	05999	99999	99996	40000	0.99999	99999	99820	00000	00000
7	7	0.00000	06999	99999	99994	28333	0.99999	99999	99755	00000	00000
8	7	0.00000	07999	99999	99991	46667	0.99999	99999	99680	00000	00000
9	7	0.00000	08999	99999	99987	85000	0.99999	99999	99595	00000	00000
1	6	0.00000	09999	99999	99983	33333	0.99999	99999	99500	00000	00000
2	6	0.00000	19999	99999	99866	66667	0.99999	99999	98000	00000	00007
3	6	0.00000	29999	99999	99550	00000	0.99999	99999	95500	00000	00034
4	6	0.00000	39999	99999	98933	33333	0.99999	99999	92000	00000	00107
5	6	0.00000	49999	99999	97916	66667	0.99999	99999	87500	00000	00260
6	6	0.00000	59999	99999	96400	00000	0.99999	99999	82000	00000	00540
7	6	0.00000	69999	99999	94283	33333	0.99999	99999	75500	00000	01000
8	6	0.00000	79999	99999	91466	66667	0.99999	99999	68000	00000	01707
9	6	0.00000	89999	99999	87850	00000	0.99999	99999	59500	00000	02734
1	5	0.00000	99999	99999	83333	33333	0.99999	99999	50000	00000	04167
2	5	0.00001	99999	99998	66666	66667	0.99999	99998	00000	00000	66667
3	5	0.00002	99999	99995	50000	00002	0.99999	99995	50000	00003	37500
4	5	0.00003	99999	99989	33333	33342	0.99999	99992	00000	00010	66667
5	5	0.00004	99999	99979	16666	66693	0.99999	99987	50000	00026	04167
6	5	0.00005	99999	99964	00000	00065	0.99999	99982	00000	00054	00000
7	5	0.00006	99999	99942	83333	33473	0.99999	99975	50000	00100	04167
8	5	0.00007	99999	99914	66666	66940	0.99999	99968	00000	00170	66667
9	5	0.00008	99999	99878	50000	00492	0.99999	99959	50000	00273	37500
1	4	0.00009	99999	99833	33333	34167	0.99999	99950	00000	00416	66667
2	4	0.00019	99999	98666	66666	93333	0.99999	99800	00000	06666	66666
3	4	0.00029	99999	95500	00002	02500	0.99999	99550	00000	33749	99990
4	4	0.00039	99999	89333	33341	86667	0.99999	99200	00001	06666	66610
5	4	0.00049	99999	79166	66692	70833	0.99999	98750	00002	60416	66450
6	4	0.00059	99999	64000	00064	80000	0.99999	98200	00005	39999	99352
7	4	0.00069	99999	42833	33473	39167	0.99999	97550	00010	00416	65033
8	4	0.00079	99999	14666	66939	73333	0.99999	96800	00017	06666	63026
9	4	0.00089	99998	78500	00492	07499	0.99999	95950	00027	33749	92619
1	3	0.00099	99998	33333	34166	66665	0.99999	95000	00041	66666	52778

For $n > 10$, $\sin x10^{-n} = x10^{-n}$; $\cos x10^{-n} = 1 - \frac{1}{2}x^210^{-2n}$, to 25D.

From C. E. Van Orstrand, Tables of the exponential function and of the circular sine and cosine to radian arguments, Memoirs of the National Academy of Sciences, vol. 14, Fifth Memoir. U.S. Government Printing Office, Washington, D.C., 1921 (with permission).

CIRCULAR SINES AND COSINES FOR LARGE RADIAN ARGUMENTS Table 4.8

x	sin x					cos x				
0	0.00000	00000	00000	00000	000	1.00000	00000	00000	00000	000
1	+0.84147	09848	07896	50665	250	+0.54030	23058	68139	71740	094
2	+0.90929	74268	25681	69539	602	-0.41614	68365	47142	38699	757
3	+0.14112	00080	59867	22210	074	-0.98999	24966	00445	45727	157
4	-0.75680	24953	07928	25137	264	-0.65364	36208	63611	91463	917
5	-0.95892	42746	63138	46889	315	+0.28366	21854	63226	26446	664
6	-0.27941	54981	98925	87281	156	+0.96017	02866	50366	02054	565
7	+0.65698	65987	18789	09039	700	+0.75390	22543	43304	63814	120
8	+0.98935	82466	23381	77780	812	-0.14550	00338	08613	52586	884
9	+0.41211	84852	41756	56975	627	-0.91113	02618	84676	98836	829
10	-0.54402	11108	89369	81340	475	-0.83907	15290	76452	45225	886
11	-0.99999	02065	50703	45705	156	+0.00442	56979	88050	78574	836
12	-0.53657	29180	00434	97166	537	+0.84385	39587	32492	10465	396
13	+0.42016	70368	26640	92186	896	+0.90744	67814	50196	21385	269
14	+0.99060	73556	94870	30787	535	+0.13673	72182	07833	59424	893
15	+0.65028	78401	57116	86582	974	-0.75968	79128	58821	27384	815
16	-0.28790	33166	65065	29478	446	-0.95765	94803	23384	64189	964
17	-0.96139	74918	79556	85726	164	-0.27516	33380	51596	92222	034
18	-0.75098	72467	71676	10375	016	+0.66031	67082	44080	14481	610
19	+0.14987	72096	62952	32975	424	+0.98870	46181	86669	25289	835
20	+0.91294	52507	27627	65437	610	+0.40808	20618	13391	98606	227
21	+0.83665	56385	36056	03186	648	-0.54772	92602	24268	42138	427
22	-0.00885	13092	90403	87592	169	-0.99996	08263	94637	12645	417
23	-0.84622	04041	75170	63524	133	-0.53283	30203	33397	55521	576
24	-0.90557	83620	06623	84513	579	+0.42417	90073	36996	97593	705
25	-0.13235	17500	97773	02890	201	+0.99120	28118	63473	59808	329
26	+0.76255	84504	79602	73751	582	+0.64691	93223	28640	34272	138
27	+0.95637	59284	04503	01343	234	-0.29213	88087	33836	19337	140
28	+0.27090	57883	07869	01998	634	-0.96260	58663	13566	60197	545
29	-0.66363	38842	12967	50215	117	-0.74805	75296	89000	35176	519
30	-0.98803	16240	92861	78998	775	+0.15425	14498	87584	05071	866
31	-0.40403	76453	23065	00604	877	+0.91474	23578	04531	27896	244
32	+0.55142	66812	41690	55066	156	+0.83422	33605	06510	27221	553
33	+0.99991	18601	07267	14572	808	-0.01327	67472	23059	47891	522
34	+0.52908	26861	20023	82083	249	-0.84857	02747	84605	18659	997
35	-0.42818	26694	96151	00440	675	-0.90369	22050	91506	75984	730
36	-0.99177	88534	43115	73683	529	-0.12796	36896	27404	68102	833
37	-0.64353	81333	56999	46068	567	+0.76541	40519	45343	35649	108
38	+0.29636	85787	09385	31739	230	+0.95507	36440	47294	85758	654
39	+0.96379	53862	84087	75326	066	+0.26664	29323	59937	25152	683
40	+0.74511	31604	79348	78698	771	-0.66693	80616	52261	84438	409
41	-0.15862	26688	04708	98710	332	-0.98733	92775	23826	45822	883
42	-0.91652	15479	15633	78589	899	-0.39998	53149	88351	29395	471
43	-0.83177	47426	28598	28820	958	+0.55511	33015	20625	67704	483
44	+0.01770	19251	05413	57780	795	+0.99984	33086	47691	22006	901
45	+0.85090	35245	34118	42486	238	+0.52532	19888	17729	69604	746
46	+0.90178	83476	48809	18503	329	-0.43217	79448	84778	29495	278
47	+0.12357	31227	45224	00406	153	-0.99233	54691	50928	71827	975
48	-0.76825	46613	23666	79904	497	-0.64014	43394	69199	73131	294
49	-0.95375	26527	59471	81836	042	+0.30059	25437	43637	08368	703
50	-0.26237	48537	03928	78591	439	+0.96496	60284	92113	27406	896

From C. E. Van Orstrand, Tables of the exponential function and of the circular sine and cosine to radian arguments, Memoirs of the National Academy of Sciences, vol. 14, Fifth Memoir. U.S. Government Printing Office, Washington, D.C., 1921 (with permission) for $x \leq 100$.

Table 4.8 CIRCULAR SINES AND COSINES FOR LARGE RADIAN ARGUMENTS

x	sin x					cos x				
50	-0.26237	48537	03928	78591	439	+0.96496	60284	92113	27406	896
51	+0.67022	91758	43374	73449	435	+0.74215	41968	13782	53946	738
52	+0.98662	75920	40485	29658	757	-0.16299	07807	95705	48100	333
53	+0.39592	51501	81834	18150	339	-0.91828	27862	12118	89119	973
54	-0.55878	90488	51616	24581	787	-0.82930	98328	63150	14772	785
55	-0.99975	51733	58619	83659	863	+0.02212	67562	61955	73456	356
56	-0.52155	10020	86911	88018	741	+0.85322	01077	22584	11396	968
57	+0.43616	47552	47824	95908	053	+0.89986	68269	69193	78650	300
58	+0.99287	26480	84537	11816	509	+0.11918	01354	48819	28543	584
59	+0.63673	80071	39137	88077	123	-0.77108	02229	75845	22938	744
60	-0.30481	06211	02216	70562	565	-0.95241	29804	15156	29269	382
61	-0.96611	77700	08392	94701	829	-0.25810	16359	38267	44570	121
62	-0.73918	06966	49222	86727	602	+0.67350	71623	23586	25288	783
63	+0.16735	57003	02806	92152	784	+0.98589	65815	82549	69743	864
64	+0.92002	60381	96790	68335	154	+0.39185	72304	29550	00516	171
65	+0.82682	86794	90103	46771	021	-0.56245	38512	38172	03106	212
66	-0.02655	11540	23966	79446	384	-0.99964	74559	66349	96483	045
67	-0.85551	99789	75322	25899	683	-0.51776	97997	89505	06565	339
68	-0.89792	76806	89291	26040	073	+0.44014	30224	96040	70593	105
69	-0.11478	48137	83187	22054	507	+0.99339	03797	22271	63756	155
70	+0.77389	06815	57889	09778	733	+0.63331	92030	86299	83233	201
71	+0.95105	46532	54374	63665	657	-0.30902	27281	66070	70291	749
72	+0.25382	33627	62036	27306	903	-0.96725	05882	73882	48729	171
73	-0.67677	19568	87307	62215	498	-0.73619	27182	27315	96016	815
74	-0.98514	62604	68247	37085	189	+0.17171	73418	30777	55609	845
75	-0.38778	16354	09430	43773	094	+0.92175	12697	24749	31639	230
76	+0.56610	76368	98180	32361	028	+0.82433	13311	07557	75991	501
77	+0.99952	01585	80731	24386	610	-0.03097	50317	31216	45752	196
78	+0.51397	84559	87535	21169	609	-0.85780	30932	44987	85540	835
79	-0.44411	26687	07508	36850	760	-0.89597	09467	90963	14833	703
80	-0.99388	86539	23375	18973	081	-0.11038	72438	39047	55811	787
81	-0.62988	79942	74453	87856	521	+0.77668	59820	21631	15768	342
82	+0.31322	87824	33085	15263	353	+0.94967	76978	82543	20471	326
83	+0.96836	44611	00185	40435	015	+0.24954	01179	73338	12437	735
84	+0.73319	03200	73292	16636	321	-0.68002	34955	87338	79542	720
85	-0.17607	56199	48587	07696	212	-0.98437	66433	94041	89491	821
86	-0.92345	84470	04059	80260	163	-0.38369	84449	49741	84477	893
87	-0.82181	78366	30822	54487	211	+0.56975	03342	65311	92000	851
88	+0.03539	83027	33660	68362	543	+0.99937	32836	95124	65698	442
89	+0.86006	94058	12453	22683	685	+0.51017	70449	41668	89902	379
90	+0.89399	66636	00557	89051	827	-0.44807	36161	29170	15236	548
91	+0.10598	75117	51156	85002	021	-0.99436	74609	28201	52610	672
92	-0.77946	60696	15804	68855	400	-0.62644	44479	10339	06880	027
93	-0.94828	21412	69947	23213	104	+0.31742	87015	19701	64974	551
94	-0.24525	19854	67654	32522	044	+0.96945	93666	69987	60380	439
95	+0.68326	17147	36120	98369	958	+0.73017	35609	94819	66479	352
96	+0.98358	77454	34344	85760	773	-0.18043	04492	91083	95011	850
97	+0.37960	77390	27521	69648	192	-0.92514	75365	96413	89170	475
98	-0.57338	18719	90422	88494	922	-0.81928	82452	91459	25267	566
99	-0.99920	68341	86353	69443	272	+0.03982	08803	93138	89816	180
100	-0.50636	56411	09758	79365	656	+0.86231	88722	87683	93410	194

CIRCULAR SINES AND COSINES FOR LARGE RADIAN ARGUMENTS Table 4.8

x	$\sin x$	$\cos x$	x	$\sin x$	$\cos x$
100	-0.50636 564	+0.86231 887	150	-0.71487 643	+0.69925 081
101	+0.45202 579	+0.89200 487	151	+0.20214 988	+0.97935 460
102	+0.99482 679	+0.10158 570	152	+0.93332 052	+0.35904 429
103	+0.62298 863	-0.78223 089	153	+0.80640 058	-0.59136 968
104	-0.32162 240	-0.94686 801	154	-0.06192 034	-0.99808 109
105	-0.97053 528	-0.24095 905	155	-0.87331 198	-0.48716 135
106	-0.72714 250	+0.68648 655	156	-0.88178 462	+0.47165 229
107	+0.18478 174	+0.98277 958	157	-0.07954 854	+0.99683 099
108	+0.92681 851	+0.37550 960	158	+0.79582 410	+0.60552 787
109	+0.81674 261	-0.57700 218	159	+0.93951 973	-0.34249 478
110	-0.04424 268	-0.99902 081	160	+0.21942 526	-0.97562 931
111	-0.86455 145	-0.50254 432	161	-0.70240 779	-0.71177 476
112	-0.88999 560	+0.45596 910	162	-0.97845 035	+0.20648 223
113	-0.09718 191	+0.99526 664	163	-0.35491 018	+0.93490 040
114	+0.78498 039	+0.61952 061	164	+0.59493 278	+0.80377 546
115	+0.94543 533	-0.32580 981	165	+0.99779 728	-0.06633 694
116	+0.23666 139	-0.97159 219	166	+0.48329 156	-0.87545 946
117	-0.68969 794	-0.72409 720	167	-0.47555 019	-0.87968 859
118	-0.98195 217	+0.18912 942	168	-0.99717 329	-0.07513 609
119	-0.37140 410	+0.92847 132	169	-0.60199 987	+0.79849 619
120	+0.58061 118	+0.81418 097	170	+0.34664 946	+0.93799 475
121	+0.99881 522	-0.04866 361	171	+0.97659 087	+0.21510 527
122	+0.49871 315	-0.86676 709	172	+0.70865 914	-0.70555 101
123	-0.45990 349	-0.88796 891	173	-0.21081 053	-0.97752 694
124	-0.99568 699	-0.09277 620	174	-0.93646 197	-0.35076 911
125	-0.61604 046	+0.78771 451	175	-0.80113 460	+0.59848 422
126	+0.32999 083	+0.94398 414	176	+0.07075 224	+0.99749 392
127	+0.97263 007	+0.23235 910	177	+0.87758 979	+0.47941 231
128	+0.72103 771	-0.69289 582	178	+0.87757 534	-0.47943 877
129	-0.19347 339	-0.98110 552	179	+0.07072 217	-0.99749 605
130	-0.93010 595	-0.36729 133	180	-0.80115 264	-0.59846 007
131	-0.81160 339	+0.58420 882	181	-0.93645 140	+0.35079 734
132	+0.05308 359	+0.99859 007	182	-0.21078 107	+0.97753 329
133	+0.86896 576	+0.49487 222	183	+0.70868 041	+0.70552 964
134	+0.88592 482	-0.46382 887	184	+0.97658 438	-0.21513 471
135	+0.08836 869	-0.99608 784	185	+0.34662 118	-0.93800 520
136	-0.79043 321	-0.61254 824	186	-0.60202 394	-0.79847 804
137	-0.94251 445	+0.33416 538	187	-0.99717 102	+0.07516 615
138	-0.22805 226	+0.97364 889	188	-0.47552 367	+0.87970 293
139	+0.69608 013	+0.71796 410	189	+0.48331 795	+0.87544 489
140	+0.98023 966	-0.19781 357	190	+0.99779 928	+0.06630 686
141	+0.36317 137	-0.93172 236	191	+0.59490 855	-0.80379 339
142	-0.58779 501	-0.80900 991	192	-0.35493 836	-0.93488 971
143	-0.99834 536	+0.05750 253	193	-0.97845 657	-0.20645 273
144	-0.49102 159	+0.87114 740	194	-0.70238 633	+0.71179 593
145	+0.46774 516	+0.88386 337	195	+0.21945 467	+0.97562 270
146	+0.99646 917	+0.08395 944	196	+0.93953 006	+0.34246 646
147	+0.60904 402	-0.79313 642	197	+0.79580 584	-0.60555 186
148	-0.33833 339	-0.94102 631	198	-0.07957 859	-0.99682 859
149	-0.97464 865	-0.22374 095	199	-0.88179 884	-0.47162 571
150	-0.71487 643	+0.69925 081	200	-0.87329 730	+0.48718 768

Table 4.8 CIRCULAR SINES AND COSINES FOR LARGE RADIAN ARGUMENTS

x	$\sin x$	$\cos x$	x	$\sin x$	$\cos x$
200	-0.87329 730	+0.48718 768	250	-0.97052 802	+0.24098 831
201	-0.06189 025	+0.99808 296	251	-0.32159 386	+0.94687 771
202	+0.80641 841	+0.59134 538	252	+0.62301 221	+0.78221 211
203	+0.93330 970	-0.35907 242	253	+0.99482 373	-0.10161 569
204	+0.20212 036	-0.97936 069	254	+0.45199 890	-0.89201 850
205	-0.71489 751	-0.69922 926	255	-0.50639 163	-0.86230 361
206	-0.97464 190	+0.22377 033	256	-0.99920 803	-0.03979 076
207	-0.33830 503	+0.94103 651	257	-0.57335 717	+0.81930 553
208	+0.60906 793	+0.79311 806	258	+0.37963 563	+0.92513 609
209	+0.99646 664	-0.08398 947	259	+0.98359 318	+0.18040 080
210	+0.46771 852	-0.88387 747	260	+0.68323 970	-0.73019 416
211	-0.49104 785	-0.87113 260	261	-0.24528 121	-0.96945 197
212	-0.99834 709	-0.05747 243	262	-0.94829 171	-0.31740 012
213	-0.58777 062	+0.80902 763	263	-0.77944 719	+0.62646 794
214	+0.36319 945	+0.93171 141	264	+0.10601 749	+0.99436 427
215	+0.98024 562	+0.19778 403	265	+0.89401 017	+0.44804 667
216	+0.69605 849	-0.71798 508	266	+0.86005 403	-0.51020 297
217	-0.22808 161	-0.97364 202	267	+0.03536 818	-0.99937 435
218	-0.94252 453	-0.33413 697	268	-0.82183 501	-0.56972 556
219	-0.79041 474	+0.61257 207	269	-0.92344 688	+0.38372 628
220	+0.08839 871	+0.99608 517	270	-0.17604 595	+0.98438 195
221	+0.88593 880	+0.46380 216	271	+0.73321 082	+0.68000 139
222	+0.86895 084	-0.49489 841	272	+0.96835 694	-0.24956 931
223	+0.05305 349	-0.99859 167	273	+0.31320 015	-0.94968 714
224	-0.81162 100	-0.58418 435	274	-0.62991 141	-0.77666 699
225	-0.93009 488	+0.36731 937	275	-0.99388 533	+0.11041 720
226	-0.19344 382	+0.98111 135	276	-0.44408 566	+0.89598 433
227	+0.72105 860	+0.69287 409	277	+0.51400 431	+0.85778 760
228	+0.97262 306	-0.23238 842	278	+0.99952 109	+0.03094 490
229	+0.32996 237	-0.94399 409	279	+0.56608 279	-0.82434 840
230	-0.61606 420	-0.78769 594	280	-0.38780 942	-0.92173 958
231	-0.99568 419	+0.09280 622	281	-0.98515 144	-0.17168 765
232	-0.45987 672	+0.88798 277	282	-0.67674 976	+0.73621 312
233	+0.49873 928	+0.86675 206	283	+0.25385 252	+0.96724 294
234	+0.99881 669	+0.04863 350	284	+0.95106 397	+0.30899 406
235	+0.58058 664	-0.81419 847	285	+0.77387 159	-0.63334 253
236	-0.37143 209	-0.92846 012	286	-0.11481 476	-0.99338 692
237	-0.98195 787	-0.18909 982	287	-0.89794 095	-0.44011 595
238	-0.68967 611	+0.72411 799	288	-0.85550 437	+0.51779 559
239	+0.23669 068	+0.97158 506	289	-0.02652 102	+0.99964 826
240	+0.94544 515	+0.32578 131	290	+0.82684 563	+0.56242 893
241	+0.78496 171	-0.61954 428	291	+0.92001 423	-0.39188 496
242	-0.09721 191	-0.99526 371	292	+0.16732 598	-0.98590 163
243	-0.89000 935	-0.45594 228	293	-0.73920 100	-0.67348 488
244	-0.86453 630	+0.50257 038	294	-0.96610 999	+0.25813 076
245	-0.04421 256	+0.99902 215	295	-0.30478 191	+0.95242 217
246	+0.81676 000	+0.57697 756	296	+0.63676 125	+0.77106 103
247	+0.92680 719	-0.37553 754	297	+0.99286 906	-0.11921 006
248	+0.18475 212	-0.98278 515	298	+0.43613 763	-0.89987 997
249	-0.72716 319	-0.68646 463	299	-0.52157 672	-0.85320 439
250	-0.97052 802	+0.24098 831	300	-0.99975 584	-0.02209 662

CIRCULAR SINES AND COSINES FOR LARGE RADIAN ARGUMENTS Table 4.8

x	$\sin x$	$\cos x$	x	$\sin x$	$\cos x$
300	-0.99975 584	-0.02209 662	350	-0.95893 283	-0.28363 328
301	-0.55876 405	+0.82932 668	351	-0.75678 279	+0.65366 643
302	+0.39595 283	+0.91827 085	352	+0.14114 985	+0.98998 824
303	+0.98663 250	+0.16296 104	353	+0.90930 997	+0.41611 943
304	+0.67020 680	-0.74217 440	354	+0.84145 470	-0.54032 767
305	-0.26240 394	-0.96495 812	355	-0.00003 014	-1.00000 000
306	-0.95376 171	-0.30056 379	356	-0.84148 727	-0.54027 694
307	-0.76823 536	+0.64016 750	357	-0.90928 488	+0.41617 425
308	+0.12360 304	+0.99233 174	358	-0.14109 017	+0.98999 675
309	+0.90180 137	+0.43215 076	359	+0.75682 220	+0.65362 081
310	+0.85088 769	-0.52534 764	360	+0.95891 572	-0.28369 109
311	+0.01767 179	-0.99984 384	361	+0.27938 655	-0.96017 871
312	-0.83179 148	-0.55508 823	362	-0.65700 932	-0.75388 245
313	-0.91650 949	+0.40001 294	363	-0.98935 386	+0.14552 986
314	-0.15859 291	+0.98734 406	364	-0.41209 102	+0.91114 268
315	+0.74513 326	+0.66691 560	365	+0.54404 640	+0.83905 513
316	+0.96378 735	-0.26667 199	366	+0.99999 007	-0.00445 584
317	+0.29633 979	-0.95508 258	367	+0.53654 748	-0.84387 013
318	-0.64356 121	-0.76539 465	368	-0.42019 439	-0.90743 412
319	-0.99177 500	+0.12799 359	369	-0.99061 148	-0.13670 736
320	-0.42815 543	+0.90370 511	370	-0.65026 494	+0.75970 752
321	+0.52910 827	+0.84855 433	371	+0.28793 218	+0.95765 080
322	+0.99991 226	+0.01324 661	372	+0.96140 579	+0.27513 436
323	+0.55140 153	-0.83423 998	373	+0.75096 734	-0.66033 935
324	-0.40406 522	-0.91473 018	374	-0.14990 701	-0.98870 010
325	-0.98803 627	-0.15422 167	375	-0.91295 755	-0.40805 454
326	-0.66361 133	+0.74807 753	376	-0.83663 913	+0.54775 448
327	+0.27093 481	+0.96259 770	377	+0.00888 145	+0.99996 056
328	+0.95638 473	+0.29210 998	378	+0.84623 647	+0.53280 751
329	+0.76253 895	-0.64694 231	379	+0.90556 557	-0.42420 631
330	-0.13238 163	-0.99119 882	380	+0.13232 187	-0.99120 680
331	-0.90559 115	-0.42415 171	381	-0.76257 795	-0.64689 634
332	-0.84620 434	+0.53285 853	382	-0.95636 712	+0.29216 764
333	-0.00882 117	+0.99996 109	383	-0.27087 677	+0.96261 403
334	+0.83667 215	+0.54770 404	384	+0.66365 643	+0.74803 752
335	+0.91293 295	-0.40810 958	385	+0.98802 697	-0.15428 123
336	+0.14984 741	-0.98870 914	386	+0.40401 007	-0.91475 454
337	-0.75100 715	-0.66029 407	387	-0.55145 183	-0.83420 674
338	-0.96138 920	+0.27519 232	388	-0.99991 146	+0.01330 689
339	-0.28787 445	+0.95766 816	389	-0.52905 711	+0.84858 622
340	+0.65031 074	+0.75966 831	390	+0.42820 991	+0.90367 930
341	+0.99060 323	-0.13676 708	391	+0.99178 271	+0.12793 379
342	+0.42013 968	-0.90745 945	392	+0.64351 506	-0.76543 345
343	-0.53659 836	-0.84383 778	393	-0.29639 737	-0.95506 471
344	-0.99999 034	-0.00439 555	394	-0.96380 342	-0.26661 388
345	-0.54399 582	+0.83908 793	395	-0.74509 306	+0.66696 052
346	+0.41214 595	+0.91111 784	396	+0.15865 243	+0.98733 450
347	+0.98936 263	+0.14547 021	397	+0.91653 361	+0.39995 769
348	+0.65696 387	-0.75392 206	398	+0.83175 801	-0.55513 837
349	-0.27944 444	-0.96016 186	399	-0.01773 206	-0.99984 277
350	-0.95893 283	-0.28363 328	400	-0.85091 936	-0.52529 634

Table 4.8 CIRCULAR SINES AND COSINES FOR LARGE RADIAN ARGUMENTS

x	$\sin x$	$\cos x$	x	$\sin x$	$\cos x$
400	-0.85091 936	-0.52529 634	450	-0.68328 373	-0.73015 296
401	-0.90177 532	+0.43220 513	451	-0.98358 231	+0.18046 010
402	-0.12354 321	+0.99233 919	452	-0.37957 985	+0.92515 898
403	+0.76827 396	+0.64012 118	453	+0.57340 657	+0.81927 096
404	+0.95374 359	-0.30062 129	454	+0.99920 563	-0.03985 100
405	+0.26234 577	-0.96497 394	455	+0.50633 965	-0.86233 414
406	-0.67025 155	-0.74213 399	456	-0.45205 268	-0.89199 124
407	-0.98662 268	+0.16302 052	457	-0.99482 985	-0.10155 572
408	-0.39589 747	+0.91829 472	458	-0.62296 505	+0.78224 967
409	+0.55881 405	+0.82929 299	459	+0.32165 095	+0.94685 832
410	+0.99975 451	-0.02215 689	460	+0.97054 255	+0.24092 979
411	+0.52152 528	-0.85323 583	461	+0.72712 181	-0.68650 847
412	-0.43619 188	-0.89985 368	462	-0.18481 137	-0.98277 401
413	-0.99287 624	-0.11915 021	463	-0.92682 982	-0.37548 166
414	-0.63671 476	+0.77109 942	464	-0.81672 521	+0.57702 680
415	+0.30483 933	+0.95240 379	465	+0.04427 279	+0.99901 948
416	+0.96612 555	+0.25807 251	466	+0.86456 660	+0.50251 826
417	+0.73916 039	-0.67352 944	467	+0.88998 186	-0.45599 593
418	-0.16738 542	-0.98589 154	468	+0.09715 190	-0.99526 957
419	-0.92003 785	-0.39182 950	469	-0.78499 906	-0.61949 695
420	-0.82681 172	+0.56247 878	470	-0.94542 551	+0.32583 830
421	+0.02658 129	+0.99964 666	471	-0.23663 211	+0.97159 932
422	+0.85553 559	+0.51774 401	472	+0.68971 977	+0.72407 641
423	+0.89791 441	-0.44017 009	473	+0.98194 647	-0.18915 902
424	+0.11475 487	-0.99339 384	474	+0.37137 611	-0.92848 252
425	-0.77390 977	-0.63329 587	475	-0.58063 573	-0.81416 347
426	-0.95104 534	+0.30905 140	476	-0.99881 376	+0.04869 372
427	-0.25379 421	+0.96725 824	477	-0.49868 703	+0.86678 212
428	+0.67679 415	+0.73617 232	478	+0.45993 026	+0.88795 504
429	+0.98514 108	-0.17174 704	479	+0.99568 978	+0.09274 619
430	+0.38775 385	-0.92176 296	480	+0.61601 671	-0.78773 308
431	-0.56613 249	-0.82431 427	481	-0.33001 928	-0.94397 419
432	-0.99951 922	+0.03100 516	482	-0.97263 707	-0.23232 978
433	-0.51395 260	+0.85781 859	483	-0.72101 682	+0.69291 756
434	+0.44413 968	+0.89595 756	484	+0.19350 297	+0.98109 969
435	+0.99389 198	+0.11035 728	485	+0.93011 702	+0.36726 329
436	+0.62986 458	-0.77670 497	486	+0.81158 578	-0.58423 328
437	-0.31325 741	-0.94966 826	487	-0.05311 369	-0.99858 847
438	-0.96837 198	-0.24951 093	488	-0.86898 067	-0.49484 603
439	-0.73316 982	+0.68004 560	489	-0.88591 083	+0.46385 557
440	+0.17610 529	+0.98437 134	490	-0.08833 866	+0.99609 050
441	+0.92347 001	+0.38367 061	491	+0.79045 167	+0.61252 441
442	+0.82180 066	-0.56977 511	492	+0.94250 438	-0.33419 379
443	-0.03542 843	-0.99937 222	493	+0.22802 291	-0.97365 577
444	-0.86008 478	-0.51015 112	494	-0.69610 177	-0.71794 312
445	-0.89398 316	+0.44810 056	495	-0.98023 370	+0.19784 312
446	-0.10595 754	+0.99437 066	496	-0.36314 328	+0.93173 331
447	+0.77948 495	+0.62642 095	497	+0.58781 939	+0.80899 219
448	+0.94827 257	-0.31745 729	498	+0.99834 363	-0.05753 262
449	+0.24522 276	-0.96946 676	499	+0.49099 533	-0.87116 220
450	-0.68328 373	-0.73015 296	500	-0.46777 181	-0.88384 927

CIRCULAR SINES AND COSINES FOR LARGE RADIAN ARGUMENTS Table 4.8

x	$\sin x$	$\cos x$	x	$\sin x$	$\cos x$
500	-0.46777 181	-0.88384 927	550	-0.21948 408	-0.97561 608
501	-0.99647 170	-0.08392 940	551	-0.93954 038	-0.34243 814
502	-0.60902 011	+0.79315 478	552	-0.79578 759	+0.60557 585
503	+0.33836 176	+0.94101 611	553	+0.07960 864	+0.99682 620
504	+0.97465 539	+0.22371 157	554	+0.88181 305	+0.47159 913
505	+0.71485 535	-0.69927 236	555	+0.87328 261	-0.48721 400
506	-0.20217 940	-0.97934 850	556	+0.06186 016	-0.99808 483
507	-0.93333 135	-0.35901 615	557	-0.80643 623	-0.59132 107
508	-0.80638 275	+0.59139 399	558	-0.93329 888	+0.35910 055
509	+0.06195 042	+0.99807 923	559	-0.20209 084	+0.97936 678
510	+0.87332 667	+0.48713 502	560	+0.71491 859	+0.69920 771
511	+0.88177 040	-0.47167 887	561	+0.97463 516	-0.22379 971
512	+0.07951 849	-0.99683 339	562	+0.33827 666	-0.94104 671
513	-0.79584 235	-0.60550 389	563	-0.60909 184	-0.79309 970
514	-0.93950 941	+0.34252 310	564	-0.99646 411	+0.08401 951
515	-0.21939 585	+0.97563 593	565	-0.46769 187	+0.88389 157
516	+0.70242 924	+0.71175 358	566	+0.49107 411	+0.87111 780
517	+0.97844 413	-0.20651 172	567	+0.99834 883	+0.05744 234
518	+0.35488 199	-0.93491 110	568	+0.58774 623	-0.80904 534
519	-0.59495 701	-0.80375 753	569	-0.36322 754	-0.93170 046
520	-0.99779 528	+0.06636 701	570	-0.98025 158	-0.19775 448
521	-0.48326 517	+0.87547 403	571	-0.69603 684	+0.71800 607
522	+0.47557 670	+0.87967 426	572	+0.22811 096	+0.97363 514
523	+0.99717 555	+0.07510 603	573	+0.94253 460	+0.33410 856
524	+0.60197 580	-0.79851 433	574	+0.79039 628	-0.61259 589
525	-0.34667 773	-0.93798 430	575	-0.08842 874	-0.99608 251
526	-0.97659 735	-0.21507 583	576	-0.88595 278	-0.46377 546
527	-0.70863 787	+0.70557 237	577	-0.86893 592	+0.49492 461
528	+0.21084 000	+0.97752 059	578	-0.05302 338	+0.99859 327
529	+0.93647 255	+0.35074 088	579	+0.81163 861	+0.58415 989
530	+0.80111 655	-0.59850 837	580	+0.93008 380	-0.36734 740
531	-0.07078 230	-0.99749 179	581	+0.19341 424	-0.98111 719
532	-0.87760 424	-0.47938 586	582	-0.72107 948	-0.69285 235
533	-0.87756 088	+0.47946 522	583	-0.97261 606	+0.23241 774
534	-0.07069 210	+0.99749 818	584	-0.32993 391	+0.94400 403
535	+0.80117 068	+0.59843 592	585	+0.61608 795	+0.78767 737
536	+0.93644 083	-0.35082 557	586	+0.99568 139	-0.09283 623
537	+0.21075 160	-0.97753 965	587	+0.45984 996	-0.88799 663
538	-0.70870 168	-0.70550 828	588	-0.49876 541	-0.86673 702
539	-0.97657 790	+0.21516 415	589	-0.99881 816	-0.04860 339
540	-0.34659 290	+0.93801 565	590	-0.58056 210	+0.81421 597
541	+0.60204 801	+0.79845 989	591	+0.37146 008	+0.92844 893
542	+0.99716 876	-0.07519 621	592	+0.98196 357	+0.18907 022
543	+0.47549 715	-0.87971 726	593	+0.68965 428	-0.72413 878
544	-0.48334 434	-0.87543 032	594	-0.23671 997	-0.97157 792
545	-0.99780 128	-0.06627 678	595	-0.94545 497	-0.32575 281
546	-0.59488 432	+0.80381 133	596	-0.78494 304	+0.61956 794
547	+0.35496 654	+0.93487 901	597	+0.09724 191	+0.99526 078
548	+0.97846 280	+0.20642 324	598	+0.89002 309	+0.45591 545
549	+0.70236 487	-0.71181 710	599	+0.86452 115	-0.50259 644
550	-0.21948 408	-0.97561 608	600	+0.04418 245	-0.99902 348

Table 4.8 CIRCULAR SINES AND COSINES FOR LARGE RADIAN ARGUMENTS

x	$\sin x$	$\cos x$	x	$\sin x$	$\cos x$
600	+0.04418 245	-0.99902 348	650	+0.30475 320	-0.95243 136
601	-0.81677 739	-0.57695 294	651	-0.63678 449	-0.77104 183
602	-0.92679 586	+0.37556 547	652	-0.99286 546	+0.11923 999
603	-0.18472 249	+0.98279 072	653	-0.43611 050	+0.89989 312
604	+0.72718 389	+0.68644 271	654	+0.52160 244	+0.85318 866
605	+0.97052 075	-0.24101 756	655	+0.99975 651	+0.02206 648
606	+0.32156 532	-0.94688 740	656	+0.55873 905	-0.82934 352
607	-0.62303 579	-0.78219 333	657	-0.39598 051	-0.91825 891
608	-0.99482 067	+0.10164 568	658	-0.98663 742	-0.16293 130
609	-0.45197 201	+0.89203 212	659	-0.67018 443	+0.74219 460
610	+0.50641 763	+0.86228 834	660	+0.26243 303	+0.96495 021
611	+0.99920 923	+0.03976 064	661	+0.95377 077	+0.30053 504
612	+0.57333 248	-0.81932 281	662	+0.76821 607	-0.64019 066
613	-0.37966 351	-0.92512 465	663	-0.12363 295	-0.99232 802
614	-0.98359 862	-0.18037 115	664	-0.90181 440	-0.43212 358
615	-0.68321 769	+0.73021 475	665	-0.85087 185	+0.52537 329
616	+0.24531 043	+0.96944 458	666	-0.01764 165	+0.99984 437
617	+0.94830 128	+0.31737 153	667	+0.83180 821	+0.55506 315
618	+0.77942 830	-0.62649 144	668	+0.91649 743	-0.40004 057
619	-0.10604 746	-0.99436 107	669	+0.15856 314	-0.98734 884
620	-0.89402 368	-0.44801 972	670	-0.74515 337	-0.66689 314
621	-0.86003 865	+0.51022 890	671	-0.96377 931	+0.26670 104
622	-0.03533 805	+0.99937 542	672	-0.29631 100	+0.95509 151
623	+0.82185 218	+0.56970 079	673	+0.64358 428	+0.76537 525
624	+0.92343 531	-0.38375 412	674	+0.99177 114	-0.12802 348
625	+0.17601 627	-0.98438 726	675	+0.42812 819	-0.90371 802
626	-0.73323 132	-0.67997 929	676	-0.52913 384	-0.84853 838
627	-0.96834 941	+0.24959 850	677	-0.99991 266	-0.01321 646
628	-0.31317 153	+0.94969 658	678	-0.55137 639	+0.83425 660
629	+0.62993 482	+0.77664 801	679	+0.40409 279	+0.91471 800
630	+0.99388 200	-0.11044 716	680	+0.98804 092	+0.15419 188
631	+0.44405 865	-0.89599 772	681	+0.66358 878	-0.74809 754
632	-0.51403 017	-0.85777 210	682	-0.27096 382	-0.96258 953
633	-0.99952 202	-0.03091 477	683	-0.95639 354	-0.29208 115
634	-0.56605 794	+0.82436 546	684	-0.76251 945	+0.64696 529
635	+0.38783 721	+0.92172 789	685	+0.13241 151	+0.99119 483
636	+0.98515 661	+0.17165 795	686	+0.90560 393	+0.42412 441
637	+0.67672 757	-0.73623 352	687	+0.84618 828	-0.53288 404
638	-0.25388 168	-0.96723 528	688	-0.00879 102	-0.99996 136
639	-0.95107 328	-0.30896 539	689	-0.83668 866	-0.54767 882
640	-0.77385 250	+0.63336 586	690	-0.91292 065	+0.40813 710
641	+0.11484 470	+0.99338 346	691	-0.14981 760	+0.98871 365
642	+0.89795 421	+0.44008 889	692	+0.75102 706	+0.66027 143
643	+0.85548 876	-0.51782 138	693	+0.96138 090	-0.27522 130
644	+0.02649 089	-0.99964 905	694	+0.28784 558	-0.95767 684
645	-0.82686 259	-0.56240 400	695	-0.65033 364	-0.75964 871
646	-0.92000 241	+0.39191 270	696	-0.99059 911	+0.13679 694
647	-0.16729 626	+0.98590 667	697	-0.42011 233	+0.90747 211
648	+0.73922 130	+0.67346 260	698	+0.53662 379	+0.84382 161
649	+0.96610 221	-0.25815 988	699	+0.99999 047	+0.00436 541
650	+0.30475 320	-0.95243 136	700	+0.54397 052	-0.83910 433

CIRCULAR SINES AND COSINES FOR LARGE RADIAN ARGUMENTS Table 4.8

x	$\sin x$	$\cos x$	x	$\sin x$	$\cos x$
700	+0.54397 052	-0.83910 433	750	+0.74507 295	-0.66698 298
701	-0.41217 342	-0.91110 541	751	-0.15868 219	-0.98732 971
702	-0.98936 702	-0.14544 039	752	-0.91654 566	-0.39993 006
703	-0.65694 115	+0.75394 186	753	-0.83174 127	+0.55516 345
704	+0.27947 339	+0.96015 344	754	+0.01776 220	+0.99984 224
705	+0.95894 137	+0.28360 437	755	+0.85093 519	+0.52527 069
706	+0.75676 309	-0.65368 925	756	+0.90176 229	-0.43223 231
707	-0.14117 969	-0.98998 399	757	+0.12351 330	-0.99234 292
708	-0.90932 251	-0.41609 202	758	-0.76829 325	-0.64009 802
709	-0.84143 841	+0.54035 304	759	-0.95373 453	+0.30065 004
710	+0.00006 029	+1.00000 000	760	-0.26231 668	+0.96498 184
711	+0.84150 356	+0.54025 157	761	+0.67027 392	+0.74211 379
712	+0.90927 234	-0.41620 166	762	+0.98661 776	+0.16305 026
713	+0.14106 032	-0.99000 100	763	+0.39586 979	-0.91830 665
714	-0.75684 190	-0.65359 799	764	-0.55883 905	-0.82927 614
715	-0.95890 717	+0.28372 000	765	-0.99975 384	+0.02218 703
716	-0.27935 761	+0.96018 713	766	-0.52149 956	+0.85325 155
717	+0.65703 205	+0.75386 264	767	+0.43621 901	+0.89984 053
718	+0.98934 947	-0.14555 968	768	+0.99287 983	+0.11912 028
719	+0.41206 355	-0.91115 511	769	+0.63669 152	-0.77111 861
720	-0.54407 170	-0.83903 873	770	-0.30486 804	-0.95239 460
721	-0.99998 994	+0.00448 599	771	-0.96613 333	-0.25804 339
722	-0.53652 204	+0.84388 631	772	-0.73914 009	+0.67355 173
723	+0.42022 174	+0.90742 145	773	+0.16741 514	+0.98588 649
724	+0.99061 560	+0.13667 750	774	+0.92004 966	+0.39180 176
725	+0.65024 204	-0.75972 712	775	+0.82679 477	-0.56250 370
726	-0.28796 105	-0.95764 212	776	-0.02661 142	-0.99964 585
727	-0.96141 408	-0.27510 538	777	-0.85555 119	-0.51771 822
728	-0.75094 744	+0.66036 198	778	-0.89790 114	+0.44019 716
729	+0.14993 682	+0.98869 558	779	-0.11472 492	+0.99339 730
730	+0.91296 985	+0.40802 702	780	+0.77392 886	+0.63327 255
731	+0.83662 262	-0.54777 970	781	+0.95103 602	-0.30908 007
732	-0.00891 160	-0.99996 029	782	+0.25376 505	-0.96726 589
733	-0.84625 253	-0.53278 200	783	-0.67681 634	-0.73615 192
734	-0.90555 279	+0.42423 360	784	-0.98513 591	+0.17177 673
735	-0.13229 199	+0.99121 079	785	-0.38772 606	+0.92177 465
736	+0.76259 745	+0.64687 335	786	+0.56615 733	+0.82429 720
737	+0.95635 831	-0.29219 647	787	+0.99951 829	-0.03103 529
738	+0.27084 775	-0.96262 220	788	+0.51392 674	-0.85783 408
739	-0.66367 898	-0.74801 752	789	-0.44416 668	-0.89594 417
740	-0.98802 232	+0.15431 102	790	-0.99389 531	-0.11032 732
741	-0.40398 250	+0.91476 672	791	-0.62984 117	+0.77672 396
742	+0.55147 697	+0.83419 011	792	+0.31328 604	+0.94965 881
743	+0.99991 106	-0.01333 703	793	+0.96837 950	+0.24948 174
744	+0.52903 153	-0.84860 217	794	+0.73314 932	-0.68006 770
745	-0.42823 715	-0.90366 639	795	-0.17613 497	-0.98436 603
746	-0.99178 657	-0.12790 390	796	-0.92348 158	-0.38364 277
747	-0.64349 199	+0.76545 285	797	-0.82178 349	+0.56979 988
748	+0.29642 616	+0.95505 577	798	+0.03545 855	+0.99937 115
749	+0.96381 146	+0.26658 483	799	+0.86010 016	+0.51012 519
750	+0.74507 295	-0.66698 298	800	+0.89396 965	-0.44812 751

Table 4.8 CIRCULAR SINES AND COSINES FOR LARGE RADIAN ARGUMENTS

x	$\sin x$	$\cos x$	x	$\sin x$	$\cos x$
800	+0.89396 965	-0.44812 751	850	+0.98022 773	-0.19787 267
801	+0.10592 756	-0.99437 385	851	+0.36311 519	-0.93174 426
802	-0.77950 384	-0.62639 745	852	-0.58784 378	-0.80897 447
803	-0.94826 300	+0.31748 587	853	-0.99834 189	+0.05756 271
804	-0.24519 354	+0.96947 415	854	-0.49096 907	+0.87117 700
805	+0.68330 573	+0.73013 237	855	+0.46779 845	+0.88383 517
806	+0.98357 687	-0.18048 975	856	+0.99647 423	+0.08389 936
807	+0.37955 196	-0.92517 042	857	+0.60899 620	-0.79317 314
808	-0.57343 126	-0.81925 368	858	-0.33839 013	-0.94100 591
809	-0.99920 443	+0.03988 112	859	-0.97466 214	-0.22368 219
810	-0.50631 365	+0.86234 940	860	-0.71483 427	+0.69929 390
811	+0.45207 956	+0.89197 762	861	+0.20220 893	+0.97934 241
812	+0.99483 291	+0.10152 573	862	+0.93334 217	+0.35898 802
813	+0.62294 147	-0.78226 845	863	+0.80636 493	-0.59141 830
814	-0.32167 949	-0.94684 862	864	-0.06198 051	-0.99807 736
815	-0.97054 981	-0.24090 054	865	-0.87334 135	-0.48710 870
816	-0.72710 111	+0.68653 039	866	-0.88175 618	+0.47170 545
817	+0.18484 099	+0.98276 844	867	-0.07948 845	+0.99683 579
818	+0.92684 114	+0.37545 372	868	+0.79586 060	+0.60547 989
819	+0.81670 782	-0.57705 142	869	+0.93949 908	-0.34255 142
820	-0.04430 291	-0.99901 814	870	+0.21936 644	-0.97564 254
821	-0.86458 174	-0.50249 220	871	-0.70245 070	-0.71173 241
822	-0.88996 811	+0.45602 276	872	-0.97843 790	+0.20654 122
823	-0.09712 190	+0.99527 249	873	-0.35485 381	+0.93492 180
824	+0.78501 774	+0.61947 329	874	+0.59498 124	+0.80373 959
825	+0.94541 569	-0.32586 680	875	+0.99779 328	-0.06639 709
826	+0.23660 282	-0.97160 646	876	+0.48323 878	-0.87548 859
827	-0.68974 159	-0.72405 561	877	-0.47560 322	-0.87965 992
828	-0.98194 076	+0.18918 862	878	-0.99717 782	-0.07507 597
829	-0.37134 812	+0.92849 371	879	-0.60195 173	+0.79853 248
830	+0.58066 027	+0.81414 596	880	+0.34670 601	+0.93797 385
831	+0.99881 229	-0.04872 383	881	+0.97660 383	+0.21504 639
832	+0.49866 090	-0.86679 716	882	+0.70861 660	-0.70559 373
833	-0.45995 702	-0.88794 118	883	-0.21086 947	-0.97751 423
834	-0.99569 258	-0.09271 618	884	-0.93648 312	-0.35071 265
835	-0.61599 297	+0.78775 165	885	-0.80109 851	+0.59853 252
836	+0.33004 774	+0.94396 424	886	+0.07081 237	+0.99748 965
837	+0.97264 407	+0.23230 046	887	+0.87761 869	+0.47935 940
838	+0.72099 594	-0.69293 929	888	+0.87754 643	-0.47949 167
839	-0.19353 254	-0.98109 386	889	+0.07066 203	-0.99750 031
840	-0.93012 809	-0.36723 525	890	-0.80118 871	-0.59841 177
841	-0.81156 816	+0.58425 775	891	-0.93643 025	+0.35085 380
842	+0.05314 379	+0.99858 687	892	-0.21072 213	+0.97754 600
843	+0.86899 559	+0.49481 983	893	+0.70872 294	+0.70548 692
844	+0.88589 685	-0.46388 228	894	+0.97657 141	-0.21519 358
845	+0.08830 863	-0.99609 316	895	+0.34656 463	-0.93802 610
846	-0.79047 014	-0.61250 058	896	-0.60207 208	-0.79844 174
847	-0.94249 431	+0.33422 221	897	-0.99716 649	+0.07522 627
848	-0.22799 356	+0.97366 264	898	-0.47547 063	+0.87973 159
849	+0.69612 342	+0.71792 213	899	+0.48337 073	+0.87541 575
850	+0.98022 773	-0.19787 267	900	+0.99780 327	+0.06624 670

CIRCULAR SINES AND COSINES FOR LARGE RADIAN ARGUMENTS Table 4.8

x	$\sin x$	$\cos x$	x	$\sin x$	$\cos x$
900	+0.99780 327	+0.06624 670	950	+0.94546 479	+0.32572 431
901	+0.59486 009	-0.80382 926	951	+0.78492 436	-0.61959 160
902	-0.35499 472	-0.93486 831	952	-0.09727 191	-0.99525 784
903	-0.97846 902	-0.20639 374	953	-0.89003 684	-0.45588 862
904	-0.70234 341	+0.71183 827	954	-0.86450 600	+0.50262 250
905	+0.21951 349	+0.97560 947	955	-0.04415 233	+0.99902 481
906	+0.93955 070	+0.34240 981	956	+0.81679 478	+0.57692 832
907	+0.79576 933	-0.60559 984	957	+0.92678 454	-0.37559 341
908	-0.07963 869	-0.99682 380	958	+0.18469 287	-0.98279 629
909	-0.88182 727	-0.47157 255	959	-0.72720 458	-0.68642 079
910	-0.87326 792	+0.48724 032	960	-0.97051 349	+0.24104 682
911	-0.06183 008	+0.99808 669	961	-0.32153 677	+0.94689 709
912	+0.80645 406	+0.59129 676	962	+0.62305 937	+0.78217 455
913	+0.93328 805	-0.35912 869	963	+0.99481 760	-0.10167 567
914	+0.20206 131	-0.97937 287	964	+0.45194 512	-0.89204 574
915	-0.71493 966	-0.69918 616	965	-0.50644 362	-0.86227 308
916	-0.97462 841	+0.22382 909	966	-0.99921 043	-0.03973 052
917	-0.33824 829	+0.94105 690	967	-0.57330 778	+0.81934 009
918	+0.60911 575	+0.79308 134	968	+0.37969 140	+0.92511 320
919	+0.99646 158	-0.08404 955	969	+0.98360 406	+0.18034 150
920	+0.46766 523	-0.88390 567	970	+0.68319 568	-0.73023 535
921	-0.49110 037	-0.87110 299	971	-0.24533 966	-0.96943 718
922	-0.99835 056	-0.05741 224	972	-0.94831 084	-0.31734 294
923	-0.58772 184	+0.80906 306	973	-0.77940 942	+0.62651 493
924	+0.36325 562	+0.93168 952	974	+0.10607 744	+0.99435 787
925	+0.98025 754	+0.19772 493	975	+0.89403 718	+0.44799 277
926	+0.69601 520	-0.71802 705	976	+0.86002 327	-0.51025 482
927	-0.22814 031	-0.97362 827	977	+0.03530 793	-0.99937 648
928	-0.94254 467	-0.33408 015	978	-0.82186 936	-0.56967 601
929	-0.79037 781	+0.61261 972	979	-0.92342 374	+0.38378 195
930	+0.08845 877	+0.99607 984	980	-0.17598 660	+0.98439 256
931	+0.88596 676	+0.46374 875	981	+0.73325 181	+0.67995 719
932	+0.86892 100	-0.49495 080	982	+0.96834 189	-0.24962 769
933	+0.05299 328	-0.99859 487	983	+0.31314 290	-0.94970 602
934	-0.81165 622	-0.58413 542	984	-0.62995 823	-0.77662 902
935	-0.93007 273	+0.36737 544	985	-0.99387 867	+0.11047 712
936	-0.19338 467	+0.98112 302	986	-0.44403 164	+0.89601 111
937	+0.72110 037	+0.69283 061	987	+0.51405 603	+0.85775 661
938	+0.97260 905	-0.23244 706	988	+0.99952 296	+0.03088 464
939	+0.32990 546	-0.94401 398	989	+0.56603 309	-0.82438 252
940	-0.61611 169	-0.78765 880	990	-0.38786 499	-0.92171 620
941	-0.99567 859	+0.09286 625	991	-0.98516 179	-0.17162 825
942	-0.45982 319	+0.88801 049	992	-0.67670 538	+0.73625 392
943	+0.49879 154	+0.86672 199	993	+0.25391 083	+0.96722 763
944	+0.99881 962	+0.04857 328	994	+0.95108 260	+0.30893 672
945	+0.58053 755	-0.81423 347	995	+0.77383 341	-0.63338 919
946	-0.37148 806	-0.92843 773	996	-0.11487 465	-0.99338 000
947	-0.98196 927	-0.18904 062	997	-0.89796 748	-0.44006 182
948	-0.68963 246	+0.72415 957	998	-0.85547 315	+0.51784 716
949	+0.23674 926	+0.97157 078	999	-0.02646 075	+0.99964 985
950	+0.94546 479	+0.32572 431	1000	+0.82687 954	+0.56237 908

For $x > 1000$ see Example 16.

Table 4.9

CIRCULAR TANGENTS, COTANGENTS, SECANTS AND COSECANTS FOR RADIAN ARGUMENTS

x	$\tan x$	$\cot x$	$\sec x$	$\csc x$	$x^{-1} - \cot x$	$\csc x - x^{-1}$
0.00	0.00000 0000	∞	1.00000 00	∞	0.00000 000	0.00000 000
0.01	0.01000 0333	99.99666 66	1.00005 00	100.00166 67	0.00333 335	0.00166 668
0.02	0.02000 2667	49.99333 32	1.00020 00	50.00333 35	0.00666 684	0.00333 349
0.03	0.03000 9003	33.32333 27	1.00045 02	33.33833 39	0.01000 060	0.00500 053
0.04	0.04002 1347	24.98666 52	1.00080 05	25.00666 79	0.01333 476	0.00666 791
0.05	0.05004 1708	19.98333 06	1.00125 13	20.00833 58	0.01666 944	0.00833 576
0.06	0.06007 2104	16.64666 19	1.00180 27	16.67667 09	0.02000 480	0.01000 420
0.07	0.07011 4558	14.26237 33	1.00245 50	14.29738 76	0.02334 096	0.01167 334
0.08	0.08017 1105	12.47332 19	1.00320 86	12.51334 32	0.02667 805	0.01334 330
0.09	0.09024 3790	11.08109 49	1.00406 37	11.12612 53	0.03001 621	0.01501 419
0.10	0.10033 467	9.96664 44	1.00502 09	10.01668 61	0.03335 558	0.01668 614
0.11	0.11044 582	9.05421 28	1.00608 07	9.10926 83	0.03669 628	0.01835 925
0.12	0.12057 934	8.29329 49	1.00724 35	8.35336 70	0.04003 845	0.02003 365
0.13	0.13073 732	7.64892 55	1.00850 99	7.71401 72	0.04338 223	0.02170 946
0.14	0.14092 189	7.09612 94	1.00988 07	7.16624 39	0.04672 776	0.02338 680
0.15	0.15113 522	6.61659 15	1.01135 64	6.69173 24	0.05007 516	0.02506 578
0.16	0.16137 946	6.19657 54	1.01293 80	6.27674 65	0.05342 458	0.02674 653
0.17	0.17165 682	5.82557 68	1.01462 61	5.91078 21	0.05677 615	0.02842 915
0.18	0.18196 953	5.49542 56	1.01642 16	5.58566 93	0.06013 000	0.03011 379
0.19	0.19231 984	5.19967 16	1.01832 55	5.29495 84	0.06348 628	0.03180 054
0.20	0.20271 004	4.93315 49	1.02033 88	5.03348 95	0.06684 512	0.03348 955
0.21	0.21314 244	4.69169 81	1.02246 26	4.79708 57	0.07020 667	0.03518 092
0.22	0.22361 942	4.47188 35	1.02469 78	4.58232 93	0.07357 105	0.03687 477
0.23	0.23414 336	4.27088 77	1.02704 58	4.38639 73	0.07693 841	0.03853 124
0.24	0.24471 670	4.08635 78	1.02950 78	4.20693 71	0.08030 889	0.04027 044
0.25	0.25534 192	3.91631 74	1.03208 50	4.04197 25	0.08368 264	0.04197 250
0.26	0.26602 154	3.75909 41	1.03477 89	3.88983 14	0.08705 978	0.04367 754
0.27	0.27675 814	3.61326 32	1.03759 10	3.74908 94	0.09044 046	0.04538 569
0.28	0.28755 433	3.47760 37	1.04052 27	3.61852 56	0.09382 483	0.04709 707
0.29	0.29841 279	3.35106 28	1.04357 57	3.49708 77	0.09721 302	0.04881 181
0.30	0.30933 625	3.23272 81	1.04675 16	3.38386 34	0.10060 519	0.05053 003
0.31	0.32032 751	3.12180 50	1.05005 22	3.27805 83	0.10400 147	0.05225 186
0.32	0.33138 941	3.01759 80	1.05347 94	3.17897 74	0.10740 202	0.05397 744
0.33	0.34252 487	2.91949 61	1.05703 51	3.08600 99	0.11080 697	0.05570 689
0.34	0.35373 688	2.82696 00	1.06072 13	2.99861 68	0.11421 648	0.05744 034
0.35	0.36502 849	2.73951 22	1.06454 02	2.91632 08	0.11763 070	0.05917 792
0.36	0.37640 285	2.65672 80	1.06849 38	2.83869 75	0.12104 976	0.06091 976
0.37	0.38786 316	2.57822 89	1.07258 47	2.76536 87	0.12447 383	0.06266 601
0.38	0.39941 272	2.50367 59	1.07681 50	2.69599 57	0.12790 306	0.06441 678
0.39	0.41105 492	2.43276 50	1.08118 74	2.63027 48	0.13133 759	0.06617 222
0.40	0.42279 322	2.36522 24	1.08570 44	2.56793 25	0.13477 758	0.06793 246
0.41	0.43463 120	2.30080 12	1.09036 89	2.50872 20	0.13822 318	0.06969 763
0.42	0.44657 255	2.23927 78	1.09518 36	2.45242 03	0.14167 456	0.07146 789
0.43	0.45862 102	2.18044 95	1.10015 15	2.39882 48	0.14513 185	0.07324 336
0.44	0.47078 053	2.12413 20	1.10527 57	2.34775 15	0.14859 524	0.07502 418
0.45	0.48305 507	2.07015 74	1.11055 94	2.29903 27	0.15206 486	0.07681 051
0.46	0.49544 877	2.01837 22	1.11600 60	2.25251 55	0.15554 089	0.07860 247
0.47	0.50796 590	1.96863 61	1.12161 91	2.20805 98	0.15902 348	0.08040 022
0.48	0.52061 084	1.92082 05	1.12740 22	2.16553 72	0.16251 280	0.08220 390
0.49	0.53338 815	1.87480 73	1.13335 91	2.12483 00	0.16600 901	0.08401 366
0.50	0.54630 249	1.83048 77	1.13949 39	2.08582 96	0.16951 228	0.08582 964
	$\left[\begin{smallmatrix} (-5)2 \\ 4 \end{smallmatrix} \right]$		$\left[\begin{smallmatrix} (-5)2 \\ 4 \end{smallmatrix} \right]$		$\left[\begin{smallmatrix} (-7)9 \\ 4 \end{smallmatrix} \right]$	$\left[\begin{smallmatrix} (-7)8 \\ 4 \end{smallmatrix} \right]$

Compilation of $\tan x$ and $\cot x$ from National Bureau of Standards, Table of circular and hyperbolic tangents and cotangents for radian arguments, 2d printing. Columbia Univ. Press, New York, N.Y., 1947 (with permission).

CIRCULAR TANGENTS, COTANGENTS, SECANTS AND COSECANTS **Table 4.9**
FOR RADIAN ARGUMENTS

x	$\tan x$	$\cot x$	$\sec x$	$\csc x$
0.50	0.54630 249	1.83048 772	1.13949 39	2.08582 96
0.51	0.55935 872	1.78776 154	1.14581 07	2.04843 63
0.52	0.57256 183	1.74653 626	1.15231 38	2.01255 78
0.53	0.58591 701	1.70672 634	1.15900 77	1.97810 89
0.54	0.59942 962	1.66825 255	1.16589 70	1.94501 07
0.55	0.61310 521	1.63104 142	1.17298 68	1.91319 00
0.56	0.62694 954	1.59502 471	1.18028 21	1.88257 90
0.57	0.64096 855	1.56013 894	1.18778 81	1.85311 45
0.58	0.65516 845	1.52632 503	1.19551 06	1.82473 78
0.59	0.66955 565	1.49352 784	1.20345 53	1.79739 41
0.60	0.68413 681	1.46169 595	1.21162 83	1.77103 22
0.61	0.69891 886	1.43078 125	1.22003 59	1.74560 45
0.62	0.71390 901	1.40073 873	1.22868 47	1.72106 62
0.63	0.72911 473	1.37152 626	1.23758 16	1.69737 57
0.64	0.74454 382	1.34310 429	1.24673 39	1.67449 37
0.65	0.76020 440	1.31543 569	1.25614 92	1.65238 34
0.66	0.77610 491	1.28848 559	1.26583 52	1.63101 05
0.67	0.79225 417	1.26222 118	1.27580 04	1.61034 23
0.68	0.80866 138	1.23661 155	1.28605 34	1.59034 84
0.69	0.82533 611	1.21162 759	1.29660 31	1.57100 01
0.70	0.84228 838	1.18724 183	1.30745 93	1.55227 03
0.71	0.85952 867	1.16342 833	1.31863 17	1.53413 35
0.72	0.87706 790	1.14016 258	1.33013 09	1.51656 54
0.73	0.89491 753	1.11742 140	1.34196 77	1.49954 35
0.74	0.91308 953	1.09518 285	1.35415 38	1.48304 60
0.75	0.93159 646	1.07342 615	1.36670 11	1.46705 27
0.76	0.95045 146	1.05213 158	1.37962 24	1.45154 43
0.77	0.96966 833	1.03128 046	1.39293 10	1.43650 25
0.78	0.98926 154	1.01085 503	1.40664 08	1.42190 99
0.79	1.00924 629	0.99083 842	1.42076 67	1.40775 03
0.80	1.02963 857	0.97121 460	1.43532 42	1.39400 78
0.81	1.05045 514	0.95196 830	1.45032 96	1.38066 78
0.82	1.07171 372	0.93308 500	1.46580 02	1.36771 62
0.83	1.09343 292	0.91455 085	1.48175 42	1.35513 96
0.84	1.11563 235	0.89635 264	1.49821 08	1.34292 52
0.85	1.13833 271	0.87847 778	1.51519 02	1.33106 09
0.86	1.16155 586	0.86091 426	1.53271 39	1.31953 53
0.87	1.18532 486	0.84365 058	1.55080 46	1.30833 72
0.88	1.20966 412	0.82667 575	1.56948 63	1.29745 63
0.89	1.23459 946	0.80997 930	1.58878 44	1.28688 25
0.90	1.26015 822	0.79355 115	1.60872 58	1.27660 62
0.91	1.28636 938	0.77738 169	1.62933 92	1.26661 84
0.92	1.31326 370	0.76146 169	1.65065 49	1.25691 05
0.93	1.34087 383	0.74578 232	1.67270 52	1.24747 40
0.94	1.36923 448	0.73033 510	1.69552 44	1.23830 10
0.95	1.39838 259	0.71511 188	1.71914 92	1.22938 40
0.96	1.42835 749	0.70010 485	1.74361 84	1.22071 57
0.97	1.45920 113	0.68530 649	1.76897 37	1.21228 91
0.98	1.49095 827	0.67070 959	1.79525 95	1.20409 77
0.99	1.52367 674	0.65630 719	1.82252 32	1.19613 51
1.00	1.55740 772	0.64209 262	1.85081 57	1.18839 51
	* $\left[\begin{matrix} (-4)1 \\ 5 \end{matrix} \right]$	$\left[\begin{matrix} (-4)2 \\ 6 \end{matrix} \right]$	$\left[\begin{matrix} (-4)1 \\ 5 \end{matrix} \right]$	$\left[\begin{matrix} (-4)2 \\ 5 \end{matrix} \right]$

*See page II.

Table 4.9 CIRCULAR TANGENTS, COTANGENTS, SECANTS AND COSECANTS
FOR RADIAN ARGUMENTS

x	$\tan x$	$\cot x$	$\sec x$	$\csc x$
1.00	1.55740 77	0.64209 262	1.85081 57	1.18839 51
1.01	1.59220 60	0.62805 942	1.88019 15	1.18087 20
1.02	1.62813 04	0.61420 141	1.91070 89	1.17356 01
1.03	1.66524 40	0.60051 260	1.94243 08	1.16645 42
1.04	1.70361 46	0.58698 722	1.97542 47	1.15954 90
1.05	1.74331 53	0.57361 970	2.00976 32	1.15283 98
1.06	1.78442 48	0.56040 467	2.04552 49	1.14632 17
1.07	1.82702 82	0.54733 693	2.08279 43	1.13999 02
1.08	1.87121 73	0.53441 147	2.12166 31	1.13384 11
1.09	1.91709 18	0.52162 342	2.16223 06	1.12787 01
1.10	1.96475 97	0.50896 811	2.20460 44	1.12207 33
1.11	2.01433 82	0.49644 096	2.24890 16	1.11644 69
1.12	2.06595 53	0.48403 759	2.29524 97	1.11098 71
1.13	2.11975 01	0.47175 371	2.34378 77	1.10569 05
1.14	2.17587 51	0.45958 520	2.39466 75	1.10055 37
1.15	2.23449 69	0.44752 802	2.44805 57	1.09557 35
1.16	2.29579 85	0.43557 829	2.50413 48	1.09074 67
1.17	2.35998 11	0.42373 221	2.56310 57	1.08607 04
1.18	2.42726 64	0.41198 610	2.62518 99	1.08154 17
1.19	2.49789 94	0.40033 638	2.69063 21	1.07715 79
1.20	2.57215 16	0.38877 957	2.75970 36	1.07291 64
1.21	2.65032 46	0.37731 227	2.83270 55	1.06881 46
1.22	2.73275 42	0.36593 119	2.90997 35	1.06485 01
1.23	2.81981 57	0.35463 310	2.99188 25	1.06102 06
1.24	2.91192 99	0.34341 486	3.07885 30	1.05732 39
1.25	3.00956 97	0.33227 342	3.17135 77	1.05375 79
1.26	3.11326 91	0.32120 577	3.26993 04	1.05032 05
1.27	3.22363 32	0.31020 899	3.37517 57	1.04700 98
1.28	3.34135 00	0.29928 023	3.48778 15	1.04382 41
1.29	3.46720 57	0.28841 670	3.60853 36	1.04076 14
1.30	3.60210 24	0.27761 565	3.73833 41	1.03782 00
1.31	3.74708 10	0.26687 440	3.87822 33	1.03499 85
1.32	3.90334 78	0.25619 034	4.02940 74	1.03229 53
1.33	4.07230 98	0.24556 088	4.19329 31	1.02970 88
1.34	4.25561 79	0.23498 350	4.37153 10	1.02723 77
1.35	4.45522 18	0.22445 572	4.56607 06	1.02488 07
1.36	4.67344 12	0.21397 509	4.77923 14	1.02263 65
1.37	4.91305 81	0.20353 922	5.01379 49	1.02050 39
1.38	5.17743 74	0.19314 574	5.27312 60	1.01848 18
1.39	5.47068 86	0.18279 234	5.56133 39	1.01656 93
1.40	5.79788 37	0.17247 673	5.88349 01	1.01476 51
1.41	6.16535 61	0.16219 663	6.24592 80	1.01306 85
1.42	6.58111 95	0.15194 983	6.65666 08	1.01147 85
1.43	7.05546 38	0.14173 413	7.12597 85	1.00999 43
1.44	7.60182 61	0.13154 734	7.66731 76	1.00861 52
1.45	8.23809 28	0.12138 732	8.29856 45	1.00734 05
1.46	8.98860 76	0.11125 194	9.04406 25	1.00616 95
1.47	9.88737 49	0.10113 908	9.93781 58	1.00510 15
1.48	10.98337 93	0.09104 6660	11.02880 87	1.00413 62
1.49	12.34985 64	0.08097 2601	12.39027 66	1.00327 29
1.50	14.10141 99	0.07091 4844	14.13683 29	1.00251 13
1.51	16.42809 17	0.06087 1343	16.45849 92	1.00185 09
1.52	19.66952 78	0.05084 0061	19.69493 14	1.00129 15
1.53	24.49841 04	0.04081 8975	24.51881 14	1.00083 27
1.54	32.46113 89	0.03080 6066	32.47653 83	1.00047 44
1.55	48.07848 25	0.02079 9325	48.08888 10	1.00021 63
1.56	92.62049 63	0.01079 6746	92.62589 45	1.00005 83
1.57	+1255.76559 15	+ 0.00079 6327	+1255.76598 97	1.00000 03
1.58	- 108.64920 36	- 0.00920 3933	- 108.65380 55	1.00004 24
1.59	- 52.06696 96	- 0.01920 6034	- 52.07657 18	1.00018 44
1.60	- 34.23253 27	- 0.02921 1978	- 34.24713 56	1.00042 66

For $x > 1.6$, use 4.3.4.4.

$$\left[\begin{array}{c} (-5)2 \\ 5 \end{array} \right]$$

$$\left[\begin{array}{c} (-5)3 \\ 4 \end{array} \right]$$

CIRCULAR SINES AND COSINES TO TENTHS OF A DEGREE

Table 4.10

θ	sin θ			cos θ			$90^\circ - \theta$
0.0°	0.0000	00000	00000	1.0000	00000	00000	90.0°
0.1	0.00174	53283	65898	0.99999	84769	13288	89.9
0.2	0.00349	06514	15224	0.99999	39076	57790	89.8
0.3	0.00523	59638	31420	0.99998	62922	47427	89.7
0.4	0.00698	12602	97962	0.99997	56307	05395	89.6
0.5	0.00872	65354	98374	0.99996	19230	64171	89.5
0.6	0.01047	17841	16246	0.99994	51693	65512	89.4
0.7	0.01221	70008	35247	0.99992	53696	60452	89.3
0.8	0.01396	21803	39145	0.99990	25240	09304	89.2
0.9	0.01570	73173	11821	0.99987	66324	81661	89.1
1.0	0.01745	24064	37284	0.99984	76951	56391	89.0
1.1	0.01919	74423	99690	0.99981	57121	21644	88.9
1.2	0.02094	24198	83357	0.99978	06834	74845	88.8
1.3	0.02268	73335	72781	0.99974	26093	22698	88.7
1.4	0.02443	21781	52653	0.99970	14897	81183	88.6
1.5	0.02617	69483	07873	0.99965	73249	75557	88.5
1.6	0.02792	16387	23569	0.99961	01150	40354	88.4
1.7	0.02966	62440	85111	0.99955	98601	19384	88.3
1.8	0.03141	07590	78128	0.99950	65603	65732	88.2
1.9	0.03315	51783	88526	0.99945	02159	41757	88.1
2.0	0.03489	94967	02501	0.99939	08270	19096	88.0
2.1	0.03664	37087	06556	0.99932	83937	78656	87.9
2.2	0.03838	78090	87520	0.99926	29164	10621	87.8
2.3	0.04013	17925	32560	0.99919	43951	14446	87.7
2.4	0.04187	56537	29200	0.99912	28300	98858	87.6
2.5	0.04361	93873	65336	0.99904	82215	81858	87.5
2.6	0.04536	29881	29254	0.99897	05697	90715	87.4
2.7	0.04710	64507	09643	0.99888	98749	61970	87.3
2.8	0.04884	97697	95613	0.99880	61373	41434	87.2
2.9	0.05059	29400	76713	0.99871	93571	84186	87.1
3.0	0.05233	59562	42944	0.99862	95347	54574	87.0
3.1	0.05407	88129	84775	0.99853	66703	26212	86.9
3.2	0.05582	15049	93164	0.99844	07641	81981	86.8
3.3	0.05756	40269	59567	0.99834	18166	14028	86.7
3.4	0.05930	63735	75962	0.99823	98279	23765	86.6
3.5	0.06104	85395	34857	0.99813	47984	21867	86.5
3.6	0.06279	05195	29313	0.99802	67284	28272	86.4
3.7	0.06453	23082	52958	0.99791	56182	72179	86.3
3.8	0.06627	39004	00000	0.99780	14682	92050	86.2
3.9	0.06801	52906	65248	0.99768	42788	35605	86.1
4.0	0.06975	64737	44125	0.99756	40502	59824	86.0
4.1	0.07149	74443	32686	0.99744	07829	30944	85.9
4.2	0.07323	81971	27632	0.99731	44772	24458	85.8
4.3	0.07497	87268	26328	0.99718	51335	25116	85.7
4.4	0.07671	90281	26819	0.99705	27522	26920	85.6
4.5	0.07845	90957	27845	0.99691	73337	33128	85.5
4.6	0.08019	89243	28859	0.99677	88784	56247	85.4
4.7	0.08193	85086	30041	0.99663	73868	18037	85.3
4.8	0.08367	78433	32315	0.99649	28592	49504	85.2
4.9	0.08541	69231	37367	0.99634	52961	90906	85.1
5.0	0.08715	57427	47658	0.99619	46980	91746	85.0
$90^\circ - \theta$	cos θ			sin θ			θ
	* $\left[\begin{matrix} (-8)3 \\ 5 \end{matrix} \right]$			$\left[\begin{matrix} (-7)4 \\ 5 \end{matrix} \right]$			

For conversion from radians to degrees see Example 14.

*See page II.

Table 4.10 CIRCULAR SINES AND COSINES TO TENTHS OF A DEGREE

θ	sin θ			cos θ			$90^\circ - \theta$
5.0°	0.08715	57427	47658	0.99619	46980	91746	85.0°
5.1	0.08889	42968	66442	0.99604	10654	10770	84.9
5.2	0.09063	25801	97780	0.99588	43986	15970	84.8
5.3	0.09237	05874	46562	0.99572	46981	84582	84.7
5.4	0.09410	83133	18514	0.99556	19646	03080	84.6
5.5	0.09584	57525	20224	0.99539	61983	67179	84.5
5.6	0.09758	28997	59149	0.99522	73999	81831	84.4
5.7	0.09931	97497	43639	0.99505	55699	61226	84.3
5.8	0.10105	62971	82946	0.99488	07088	28788	84.2
5.9	0.10279	25367	87247	0.99470	28171	17174	84.1
6.0	0.10452	84632	67653	0.99452	18953	68273	84.0
6.1	0.10626	40713	36233	0.99433	79441	33205	83.9
6.2	0.10799	93557	06023	0.99415	09639	72315	83.8
6.3	0.10973	43110	91045	0.99396	09554	55180	83.7
6.4	0.11146	89322	06325	0.99376	79191	60596	83.6
6.5	0.11320	32137	67907	0.99357	18556	76587	83.5
6.6	0.11493	71504	92867	0.99337	27656	00396	83.4
6.7	0.11667	07370	99333	0.99317	06495	38486	83.3
6.8	0.11840	39683	06501	0.99296	55081	06537	83.2
6.9	0.12013	68388	34647	0.99275	73419	29446	83.1
7.0	0.12186	93434	05147	0.99254	61516	41322	83.0
7.1	0.12360	14767	40493	0.99233	19378	85489	82.9
7.2	0.12533	32335	64304	0.99211	47013	14478	82.8
7.3	0.12706	46086	01350	0.99189	44425	90030	82.7
7.4	0.12879	55965	77563	0.99167	11623	83090	82.6
7.5	0.13052	61922	20052	0.99144	48613	73810	82.5
7.6	0.13225	63902	57122	0.99121	55402	51542	82.4
7.7	0.13398	61854	18292	0.99098	31997	14836	82.3
7.8	0.13571	55724	34304	0.99074	78404	71444	82.2
7.9	0.13744	45460	37147	0.99050	94632	38309	82.1
8.0	0.13917	31009	60065	0.99026	80687	41570	82.0
8.1	0.14090	12319	37583	0.99002	36577	16558	81.9
8.2	0.14262	89337	05512	0.98977	62309	07789	81.8
8.3	0.14435	62010	00973	0.98952	57890	68969	81.7
8.4	0.14608	30285	62412	0.98927	23329	62988	81.6
8.5	0.14780	94111	29611	0.98901	58633	61917	81.5
8.6	0.14953	53434	43710	0.98875	63810	47006	81.4
8.7	0.15126	08202	47219	0.98849	38868	08684	81.3
8.8	0.15298	58362	84038	0.98822	83814	46553	81.2
8.9	0.15471	03862	99468	0.98795	98657	69389	81.1
9.0	0.15643	44650	40231	0.98768	83405	95138	81.0
9.1	0.15815	80672	54484	0.98741	38067	50911	80.9
9.2	0.15988	11876	91835	0.98713	62650	72988	80.8
9.3	0.16160	38211	03361	0.98685	57164	06807	80.7
9.4	0.16332	59622	41622	0.98657	21616	06969	80.6
9.5	0.16504	76058	60678	0.98628	56015	37231	80.5
9.6	0.16676	87467	16102	0.98599	60370	70505	80.4
9.7	0.16848	93795	65003	0.98570	34690	88854	80.3
9.8	0.17020	94991	66033	0.98540	78984	83490	80.2
9.9	0.17192	91002	79410	0.98510	93261	54774	80.1
10.0	0.17364	81776	66930	0.98480	77530	12208	80.0
$90^\circ - \theta$	cos θ			sin θ			θ
	* $\left[\begin{smallmatrix} (-8)7 \\ 5 \end{smallmatrix} \right]$			$\left[\begin{smallmatrix} (-7)4 \\ 5 \end{smallmatrix} \right]$			

*See page II.

CIRCULAR SINES AND COSINES TO TENTHS OF A DEGREE

Table 4.10

θ	sin θ			cos θ			$90^\circ - \theta$
10.0°	0.17364	81776	66930	0.98480	77530	12208	80.0°
10.1	0.17536	67260	91987	0.98450	31799	74437	79.9
10.2	0.17708	47403	19583	0.98419	56079	69242	79.8
10.3	0.17880	22151	16350	0.98388	50379	33542	79.7
10.4	0.18051	91452	50560	0.98357	14708	13386	79.6
10.5	0.18223	55254	92147	0.98325	49075	63955	79.5
10.6	0.18395	13506	12720	0.98293	53491	49554	79.4
10.7	0.18566	66153	85577	0.98261	27965	43615	79.3
10.8	0.18738	13145	85725	0.98228	72507	28689	79.2
10.9	0.18909	54429	89891	0.98195	87126	96444	79.1
11.0	0.19080	89953	76545	0.98162	71834	47664	79.0
11.1	0.19252	19665	25907	0.98129	26639	92245	78.9
11.2	0.19423	43512	19972	0.98095	51553	49192	78.8
11.3	0.19594	61442	42518	0.98061	46585	46613	78.7
11.4	0.19765	73403	79126	0.98027	11746	21722	78.6
11.5	0.19936	79344	17197	0.97992	47046	20830	78.5
11.6	0.20107	79211	45965	0.97957	52495	99344	78.4
11.7	0.20278	72953	56512	0.97922	28106	21766	78.3
11.8	0.20449	60518	41790	0.97886	73887	61685	78.2
11.9	0.20620	41853	96630	0.97850	89851	01778	78.1
12.0	0.20791	16908	17759	0.97814	76007	33806	78.0
12.1	0.20961	85629	03822	0.97778	32367	58606	77.9
12.2	0.21132	47964	55389	0.97741	58942	86096	77.8
12.3	0.21303	03862	74977	0.97704	55744	35264	77.7
12.4	0.21473	53271	67063	0.97667	22783	34168	77.6
12.5	0.21643	96139	38103	0.97629	60071	19933	77.5
12.6	0.21814	32413	96543	0.97591	67619	38747	77.4
12.7	0.21984	62043	52838	0.97553	45439	45857	77.3
12.8	0.22154	84976	19467	0.97514	93543	05563	77.2
12.9	0.22325	01160	10951	0.97476	11941	91222	77.1
13.0	0.22495	10543	43865	0.97437	00647	85235	77.0
13.1	0.22665	13074	36855	0.97397	59672	79052	76.9
13.2	0.22835	08701	10656	0.97357	89028	73160	76.8
13.3	0.23004	97371	88104	0.97317	88727	77088	76.7
13.4	0.23174	79034	94157	0.97277	58782	09397	76.6
13.5	0.23344	53638	55905	0.97236	99203	97677	76.5
13.6	0.23514	21131	02590	0.97196	10005	78546	76.4
13.7	0.23683	81460	65619	0.97154	91199	97646	76.3
13.8	0.23853	34575	78581	0.97113	42799	09636	76.2
13.9	0.24022	80424	77264	0.97071	64815	78191	76.1
14.0	0.24192	18955	99668	0.97029	57262	75996	76.0
14.1	0.24361	50117	86023	0.96987	20152	84747	75.9
14.2	0.24530	73858	78803	0.96944	53498	95139	75.8
14.3	0.24699	90127	22743	0.96901	57314	06870	75.7
14.4	0.24868	98871	64855	0.96858	31611	28631	75.6
14.5	0.25038	00040	54441	0.96814	76403	78108	75.5
14.6	0.25206	93582	43114	0.96770	91704	81971	75.4
14.7	0.25375	79445	84806	0.96726	77527	75877	75.3
14.8	0.25544	57579	35791	0.96682	33886	04459	75.2
14.9	0.25713	27931	54696	0.96637	60793	21329	75.1
15.0	0.25881	90451	02521	0.96592	58262	89068	75.0
$90^\circ - \theta$		cos θ			sin θ		θ
	*	$\begin{bmatrix} (-7)1 \\ 5 \end{bmatrix}$			$\begin{bmatrix} (-7)4 \\ 5 \end{bmatrix}$		

*See page II.

Table 4.10 CIRCULAR SINES AND COSINES TO TENTHS OF A DEGREE

θ	sin θ			cos θ			$90^\circ - \theta$
15.0 ⁰	0.25881	90451	02521	0.96592	58262	89068	75.0 ⁰
15.1	0.26050	45086	42648	0.96547	26308	79225	74.9
15.2	0.26218	91786	40865	0.96501	64944	72311	74.8
15.3	0.26387	30499	65373	0.96455	74184	57798	74.7
15.4	0.26555	61174	86809	0.96409	54042	34110	74.6
15.5	0.26723	83760	78257	0.96363	04532	08623	74.5
15.6	0.26891	98206	15266	0.96316	25667	97658	74.4
15.7	0.27060	04459	75864	0.96269	17464	26479	74.3
15.8	0.27228	02470	40574	0.96221	79935	29285	74.2
15.9	0.27395	92186	92432	0.96174	13095	49211	74.1
16.0	0.27563	73558	16999	0.96126	16959	38319	74.0
16.1	0.27731	46533	02378	0.96077	91541	57594	73.9
16.2	0.27899	11060	39229	0.96029	36856	76943	73.8
16.3	0.28066	67089	20788	0.95980	52919	75187	73.7
16.4	0.28234	14568	42876	0.95931	39745	40058	73.6
16.5	0.28401	53447	03923	0.95881	97348	68193	73.5
16.6	0.28568	83674	04974	0.95832	25744	65133	73.4
16.7	0.28736	05198	49712	0.95782	24948	45315	73.3
16.8	0.28903	17969	44472	0.95731	94975	32067	73.2
16.9	0.29070	21935	98252	0.95681	35840	57607	73.1
17.0	0.29237	17047	22737	0.95630	47559	63035	73.0
17.1	0.29404	03252	32304	0.95579	30147	98330	72.9
17.2	0.29570	80500	44047	0.95527	83621	22344	72.8
17.3	0.29737	48740	77786	0.95476	07995	02797	72.7
17.4	0.29904	07922	56087	0.95424	03285	16277	72.6
17.5	0.30070	57995	04273	0.95371	69507	48227	72.5
17.6	0.30236	98907	50445	0.95319	06677	92947	72.4
17.7	0.30403	30609	25490	0.95266	14812	53586	72.3
17.8	0.30569	53049	63106	0.95212	93927	42139	72.2
17.9	0.30735	66177	99807	0.95159	44038	79438	72.1
18.0	0.30901	69943	74947	0.95105	65162	95154	72.0
18.1	0.31067	64296	30732	0.95051	57316	27784	71.9
18.2	0.31233	49185	12233	0.94997	20515	24653	71.8
18.3	0.31399	24559	67405	0.94942	54776	41904	71.7
18.4	0.31564	90369	47102	0.94887	60116	44497	71.6
18.5	0.31730	46564	05092	0.94832	36552	06199	71.5
18.6	0.31895	93092	98070	0.94776	84100	09586	71.4
18.7	0.32061	29905	85676	0.94721	02777	46029	71.3
18.8	0.32226	56952	30511	0.94664	92601	15696	71.2
18.9	0.32391	74181	98149	0.94608	53588	27545	71.1
19.0	0.32556	81544	57157	0.94551	85755	99317	71.0
19.1	0.32721	78989	79104	0.94494	89121	57531	70.9
19.2	0.32886	66467	38583	0.94437	63702	37481	70.8
19.3	0.33051	43927	13223	0.94380	09515	83229	70.7
19.4	0.33216	11318	83703	0.94322	26579	47601	70.6
19.5	0.33380	68592	33771	0.94264	14910	92178	70.5
19.6	0.33545	15697	50255	0.94205	74527	87297	70.4
19.7	0.33709	52584	23082	0.94147	05448	12038	70.3
19.8	0.33873	79202	45291	0.94088	07689	54225	70.2
19.9	0.34037	95502	13050	0.94028	81270	10419	70.1
20.0	0.34202	01433	25669	0.93969	26207	85908	70.0
$90^\circ - \theta$	cos θ			sin θ			θ
	* $\begin{bmatrix} (-7)1 \\ 5 \end{bmatrix}$			$\begin{bmatrix} (-7)4 \\ 5 \end{bmatrix}$			

*See page II.

CIRCULAR SINES AND COSINES TO TENTHS OF A DEGREE

Table 4.10

θ	sin θ			cos θ			$90^\circ - \theta$
20.0°	0.34202	01433	25669	0.93969	26207	85908	70.0°
20.1	0.34365	96945	85616	0.93909	42520	94709	69.9
20.2	0.34529	81989	98535	0.93849	30227	59556	69.8
20.3	0.34693	56515	73256	0.93788	89346	11898	69.7
20.4	0.34857	20473	21815	0.93728	19894	91892	69.6
20.5	0.35020	73812	59467	0.93667	21892	48398	69.5
20.6	0.35184	16484	04702	0.93605	95357	38973	69.4
20.7	0.35347	48437	79257	0.93544	40308	29867	69.3
20.8	0.35510	69624	08137	0.93482	56763	96014	69.2
20.9	0.35673	79993	19625	0.93420	44743	21030	69.1
21.0	0.35836	79495	45300	0.93358	04264	97202	69.0
21.1	0.35999	68081	20051	0.93295	35348	25489	68.9
21.2	0.36162	45700	82092	0.93232	38012	15512	68.8
21.3	0.36325	12304	72978	0.93169	12275	85549	68.7
21.4	0.36487	67843	37620	0.93105	58158	62528	68.6
21.5	0.36650	12267	24297	0.93041	75679	82025	68.5
21.6	0.36812	45526	84678	0.92977	64858	88251	68.4
21.7	0.36974	67572	73829	0.92913	25715	34056	68.3
21.8	0.37136	78355	50235	0.92848	58268	80914	68.2
21.9	0.37298	77825	75809	0.92783	62538	98920	68.1
22.0	0.37460	65934	15912	0.92718	38545	66787	68.0
22.1	0.37622	42631	39366	0.92652	86308	71837	67.9
22.2	0.37784	07868	18467	0.92587	05848	09995	67.8
22.3	0.37945	61595	29005	0.92520	97183	85782	67.7
22.4	0.38107	03763	50274	0.92454	60336	12313	67.6
22.5	0.38268	34323	65090	0.92387	95325	11287	67.5
22.6	0.38429	53226	59804	0.92321	02171	12981	67.4
22.7	0.38590	60423	24319	0.92253	80894	56246	67.3
22.8	0.38751	55864	52103	0.92186	31515	88501	67.2
22.9	0.38912	39501	40206	0.92118	54055	65721	67.1
23.0	0.39073	11284	89274	0.92050	48534	52440	67.0
23.1	0.39233	71166	03561	0.91982	14973	21738	66.9
23.2	0.39394	19095	90951	0.91913	53392	55234	66.8
23.3	0.39554	55025	62965	0.91844	63813	43087	66.7
23.4	0.39714	78906	34781	0.91775	46256	83981	66.6
23.5	0.39874	90689	25246	0.91706	00743	85124	66.5
23.6	0.40034	90325	56895	0.91636	27295	62240	66.4
23.7	0.40194	77766	55960	0.91566	25933	39561	66.3
23.8	0.40354	52963	52390	0.91495	96678	49825	66.2
23.9	0.40514	15867	79863	0.91425	39552	34264	66.1
24.0	0.40673	66430	75800	0.91354	54576	42601	66.0
24.1	0.40833	04603	81385	0.91283	41772	33043	65.9
24.2	0.40992	30338	41573	0.91212	01161	72273	65.8
24.3	0.41151	43586	05109	0.91140	32766	35445	65.7
24.4	0.41310	44298	24542	0.91068	36608	06177	65.6
24.5	0.41469	32426	56239	0.90996	12708	76543	65.5
24.6	0.41628	07922	60401	0.90923	61090	47069	65.4
24.7	0.41786	70738	01077	0.90850	81775	26722	65.3
24.8	0.41945	20824	46177	0.90777	74785	32909	65.2
24.9	0.42103	58133	67491	0.90704	40142	91465	65.1
25.0	0.42261	82617	40699	0.90630	77870	36650	65.0
$90^\circ - \theta$		cos θ			sin θ		θ
	*	$\left[\begin{matrix} (-7)2 \\ 5 \end{matrix} \right]$			$\left[\begin{matrix} (-7)4 \\ 5 \end{matrix} \right]$		

*See page II.

Table 4.10 CIRCULAR SINES AND COSINES TO TENTHS OF A DEGREE

θ	sin θ			cos θ			$90^\circ - \theta$
25.0 ⁰	0.42261	82617	40699	0.90630	77870	36650	65.0 ⁰
25.1	0.42419	94227	45390	0.90556	87990	11140	64.9
25.2	0.42577	92915	65073	0.90482	70524	66020	64.8
25.3	0.42735	78633	87192	0.90408	25496	60778	64.7
25.4	0.42893	51334	03146	0.90333	52928	63301	64.6
25.5	0.43051	10968	08295	0.90258	52843	49861	64.5
25.6	0.43208	57488	01982	0.90183	25264	05114	64.4
25.7	0.43365	90845	87544	0.90107	70213	22092	64.3
25.8	0.43523	10993	72328	0.90031	87714	02194	64.2
25.9	0.43680	17883	67702	0.89955	77789	55180	64.1
26.0	0.43837	11467	89077	0.89879	40462	99167	64.0
26.1	0.43993	91698	55915	0.89802	75757	60616	63.9
26.2	0.44150	58527	91745	0.89725	83696	74328	63.8
26.3	0.44307	11908	24180	0.89648	64303	83441	63.7
26.4	0.44463	51791	84927	0.89571	17602	39413	63.6
26.5	0.44619	78131	09809	0.89493	43616	02025	63.5
26.6	0.44775	90878	38770	0.89415	42368	39368	63.4
26.7	0.44931	89986	15897	0.89337	13883	27838	63.3
26.8	0.45087	75406	89431	0.89258	58184	52125	63.2
26.9	0.45243	47093	11783	0.89179	75296	05214	63.1
27.0	0.45399	04997	39547	0.89100	65241	88368	63.0
27.1	0.45554	49072	33516	0.89021	28046	11127	62.9
27.2	0.45709	79270	58694	0.88941	63732	91298	62.8
27.3	0.45864	95544	84315	0.88861	72326	54949	62.7
27.4	0.46019	97847	83852	0.88781	53851	36401	62.6
27.5	0.46174	86132	35034	0.88701	08331	78222	62.5
27.6	0.46329	60351	19862	0.88620	35792	31215	62.4
27.7	0.46484	20457	24620	0.88539	36257	54416	62.3
27.8	0.46638	66403	39891	0.88458	09752	15084	62.2
27.9	0.46792	98142	60573	0.88376	56300	88693	62.1
28.0	0.46947	15627	85891	0.88294	75928	58927	62.0
28.1	0.47101	18812	19410	0.88212	68660	17668	61.9
28.2	0.47255	07648	69054	0.88130	34520	64992	61.8
28.3	0.47408	82090	47116	0.88047	73535	09162	61.7
28.4	0.47562	42090	70275	0.87964	85728	66617	61.6
28.5	0.47715	87602	59608	0.87881	71126	61965	61.5
28.6	0.47869	18579	40607	0.87798	29754	27981	61.4
28.7	0.48022	34974	43189	0.87714	61637	05589	61.3
28.8	0.48175	36741	01715	0.87630	66800	43864	61.2
28.9	0.48328	23832	55002	0.87546	45270	00018	61.1
29.0	0.48480	96202	46337	0.87461	97071	39396	61.0
29.1	0.48633	53804	23490	0.87377	22230	35465	60.9
29.2	0.48785	96591	38733	0.87292	20772	69810	60.8
29.3	0.48938	24517	48846	0.87206	92724	32121	60.7
29.4	0.49090	37536	15141	0.87121	38111	20189	60.6
29.5	0.49242	35601	03467	0.87035	56959	39900	60.5
29.6	0.49394	18665	84231	0.86949	49295	05219	60.4
29.7	0.49545	86684	32408	0.86863	15144	38191	60.3
29.8	0.49697	39610	27555	0.86776	54533	68928	60.2
29.9	0.49848	77397	53830	0.86689	67489	35603	60.1
30.0	0.50000	00000	00000	0.86602	54037	84439	60.0
90° - θ		cos θ			sin θ		θ
	*	$\left[\begin{array}{c} (-7)2 \\ 5 \end{array} \right]$			$\left[\begin{array}{c} (-7)4 \\ 5 \end{array} \right]$		

*See page II.

CIRCULAR SINES AND COSINES TO TENTHS OF A DEGREE

Table 4.10

θ	sin θ			cos θ			$90^\circ - \theta$
30.0°	0.50000	00000	00000	0.86602	54037	84439	60.0°
30.1	0.50151	07371	59457	0.86515	14205	69704	59.9
30.2	0.50301	99466	30235	0.86427	48019	53705	59.8
30.3	0.50452	76238	15019	0.86339	55506	06772	59.7
30.4	0.50603	37641	21164	0.86251	36692	07257	59.6
30.5	0.50753	83629	60704	0.86162	91604	41526	59.5
30.6	0.50904	14157	50371	0.86074	20270	03944	59.4
30.7	0.51054	29179	11606	0.85985	22715	96873	59.3
30.8	0.51204	28648	70572	0.85895	98969	30664	59.2
30.9	0.51354	12520	58170	0.85806	49057	23645	59.1
31.0	0.51503	80749	10054	0.85716	73007	02112	59.0
31.1	0.51653	33288	66642	0.85626	70846	00328	58.9
31.2	0.51802	70093	73130	0.85536	42601	60507	58.8
31.3	0.51951	91118	79509	0.85445	88301	32807	58.7
31.4	0.52100	96318	40576	0.85355	07972	75327	58.6
31.5	0.52249	85647	15949	0.85264	01643	54092	58.5
31.6	0.52398	59059	70079	0.85172	69341	43048	58.4
31.7	0.52547	16510	72268	0.85081	11094	24051	58.3
31.8	0.52695	57954	96678	0.84989	26929	86864	58.2
31.9	0.52843	83347	22347	0.84897	16876	29141	58.1
32.0	0.52991	92642	33205	0.84804	80961	56426	58.0
32.1	0.53139	85795	18083	0.84712	19213	82137	57.9
32.2	0.53287	62760	70730	0.84619	31661	27564	57.8
32.3	0.53435	23493	89826	0.84526	18332	21856	57.7
32.4	0.53582	67949	78997	0.84432	79255	02015	57.6
32.5	0.53729	96083	46824	0.84339	14458	12886	57.5
32.6	0.53877	07850	06863	0.84245	23970	07148	57.4
32.7	0.54024	03204	77655	0.84151	07819	45306	57.3
32.8	0.54170	82102	82740	0.84056	66034	95684	57.2
32.9	0.54317	44499	50671	0.83961	98645	34413	57.1
33.0	0.54463	90350	15027	0.83867	05679	45424	57.0
33.1	0.54610	19610	14429	0.83771	87166	20439	56.9
33.2	0.54756	32234	92550	0.83676	43134	58962	56.8
33.3	0.54902	28179	98132	0.83580	73613	68270	56.7
33.4	0.55048	07400	84996	0.83484	78632	63407	56.6
33.5	0.55193	69853	12058	0.83388	58220	67168	56.5
33.6	0.55339	15492	43344	0.83292	12407	10099	56.4
33.7	0.55484	44274	47999	0.83195	41221	30483	56.3
33.8	0.55629	56155	00305	0.83098	44692	74328	56.2
33.9	0.55774	51089	79690	0.83001	22850	95367	56.1
34.0	0.55919	29034	70747	0.82903	75725	55042	56.0
34.1	0.56063	89945	63242	0.82806	03346	22494	55.9
34.2	0.56208	33778	52131	0.82708	05742	74562	55.8
34.3	0.56352	60489	37571	0.82609	82944	95764	55.7
34.4	0.56496	70034	24938	0.82511	34982	78295	55.6
34.5	0.56640	62369	24833	0.82412	61886	22016	55.5
34.6	0.56784	37450	53101	0.82313	63685	34442	55.4
34.7	0.56927	95234	30844	0.82214	40410	30737	55.3
34.8	0.57071	35676	84432	0.82114	92091	33704	55.2
34.9	0.57214	58734	45516	0.82015	18758	73772	55.1
35.0	0.57357	64363	51046	0.81915	20442	88992	55.0
$90^\circ - \theta$		cos θ			sin θ		θ
	*	$\left[\begin{matrix} (-7)2 \\ 5 \end{matrix} \right]$			$\left[\begin{matrix} (-7)3 \\ 5 \end{matrix} \right]$		

*See page II.

Table 4.10 CIRCULAR SINES AND COSINES TO TENTHS OF A DEGREE

θ	$\sin \theta$			$\cos \theta$			$90^\circ - \theta$
35.0°	0.57357	64363	51046	0.81915	20442	88992	55.0°
35.1	0.57500	52520	43279	0.81814	97174	25023	54.9
35.2	0.57643	23161	69793	0.81714	48983	35129	54.8
35.3	0.57785	76243	83505	0.81613	75900	80160	54.7
35.4	0.57928	11723	42679	0.81512	77957	28554	54.6
35.5	0.58070	29557	10940	0.81411	55183	56319	54.5
35.6	0.58212	29701	57289	0.81310	07610	47028	54.4
35.7	0.58354	12113	56118	0.81208	35268	91806	54.3
35.8	0.58495	76749	87215	0.81106	38189	89327	54.2
35.9	0.58637	23567	35789	0.81004	16404	45796	54.1
36.0	0.58778	52522	92473	0.80901	69943	74947	54.0
36.1	0.58919	63573	53342	0.80798	98838	98031	53.9
36.2	0.59060	56676	19925	0.80696	03121	43802	53.8
36.3	0.59201	31787	99220	0.80592	82822	48516	53.7
36.4	0.59341	88866	03701	0.80489	37973	55914	53.6
36.5	0.59482	27867	51341	0.80385	68606	17217	53.5
36.6	0.59622	48749	65616	0.80281	74751	91115	53.4
36.7	0.59762	51469	75521	0.80177	56442	43754	53.3
36.8	0.59902	35985	15586	0.80073	13709	48733	53.2
36.9	0.60042	02253	25884	0.79968	46584	87091	53.1
37.0	0.60181	50231	52048	0.79863	55100	47293	53.0
37.1	0.60320	79877	45282	0.79758	39288	25229	52.9
37.2	0.60459	91148	62375	0.79652	99180	24196	52.8
37.3	0.60598	84002	65711	0.79547	34808	54896	52.7
37.4	0.60737	58397	23287	0.79441	46205	35418	52.6
37.5	0.60876	14290	08721	0.79335	33402	91235	52.5
37.6	0.61014	51639	01268	0.79228	96433	55191	52.4
37.7	0.61152	70401	85831	0.79122	35329	67490	52.3
37.8	0.61290	70536	52976	0.79015	50123	75690	52.2
37.9	0.61428	52000	98943	0.78908	40848	34691	52.1
38.0	0.61566	14753	25658	0.78801	07536	06722	52.0
38.1	0.61703	58751	40749	0.78693	50219	61337	51.9
38.2	0.61840	83953	57554	0.78585	68931	75402	51.8
38.3	0.61977	90317	95140	0.78477	63705	33083	51.7
38.4	0.62114	77802	78310	0.78369	34573	25840	51.6
38.5	0.62251	46366	37620	0.78260	81568	52414	51.5
38.6	0.62387	95967	09386	0.78152	04724	18819	51.4
38.7	0.62524	26563	35705	0.78043	04073	38330	51.3
38.8	0.62660	38113	64461	0.77933	79649	31474	51.2
38.9	0.62796	30576	49338	0.77824	31485	26021	51.1
39.0	0.62932	03910	49837	0.77714	59614	56971	51.0
39.1	0.63067	58074	31286	0.77604	64070	66546	50.9
39.2	0.63202	93026	64851	0.77494	44887	04180	50.8
39.3	0.63338	08726	27550	0.77384	02097	26506	50.7
39.4	0.63473	05132	02268	0.77273	35734	97351	50.6
39.5	0.63607	82202	77764	0.77162	45833	87720	50.5
39.6	0.63742	39897	48690	0.77051	32427	75789	50.4
39.7	0.63876	78175	15598	0.76939	95550	46895	50.3
39.8	0.64010	96994	84955	0.76828	35235	93523	50.2
39.9	0.64144	96315	69158	0.76716	51518	15300	50.1
40.0	0.64278	76096	86539	0.76604	44431	18978	50.0
90° - θ		$\cos \theta$			$\sin \theta$		θ
	*	$\left[\begin{array}{c} (-7)2 \\ 5 \end{array} \right]$			$\left[\begin{array}{c} (-7)3 \\ 5 \end{array} \right]$		

*See page II.

CIRCULAR SINES AND COSINES TO TENTHS OF A DEGREE

Table 4.10

θ	sin θ			cos θ			$90^\circ - \theta$
40.0 ⁰	0.64278	76096	86539	0.76604	44431	18978	50.0 ⁰
40.1	0.64412	36297	61387	0.76492	14009	18432	49.9
40.2	0.64545	76877	23951	0.76379	60286	34642	49.8
40.3	0.64678	97795	10460	0.76266	83296	95688	49.7
40.4	0.64811	99010	63131	0.76153	83075	36737	49.6
40.5	0.64944	80483	30184	0.76040	59656	00031	49.5
40.6	0.65077	42172	65851	0.75927	13073	34881	49.4
40.7	0.65209	84038	30392	0.75813	43361	97652	49.3
40.8	0.65342	06039	90105	0.75699	50556	51756	49.2
40.9	0.65474	08137	17340	0.75585	34691	67640	49.1
41.0	0.65605	90289	90507	0.75470	95802	22772	49.0
41.1	0.65737	52457	94096	0.75356	33923	01638	48.9
41.2	0.65868	94601	18680	0.75241	49088	95724	48.8
41.3	0.66000	16679	60937	0.75126	41335	03511	48.7
41.4	0.66131	18653	23652	0.75011	10696	30460	48.6
41.5	0.66262	00482	15737	0.74895	57207	89002	48.5
41.6	0.66392	62126	52242	0.74779	80904	98532	48.4
41.7	0.66523	03546	54361	0.74663	81822	85391	48.3
41.8	0.66653	24702	49452	0.74547	59996	82862	48.2
41.9	0.66783	25554	71047	0.74431	15462	31154	48.1
42.0	0.66913	06063	58858	0.74314	48254	77394	48.0
42.1	0.67042	66189	58799	0.74197	58409	75616	47.9
42.2	0.67172	05893	22990	0.74080	45962	86750	47.8
42.3	0.67301	25135	09773	0.73963	10949	78610	47.7
42.4	0.67430	23875	83723	0.73845	53406	25884	47.6
42.5	0.67559	02076	15660	0.73727	73368	10124	47.5
42.6	0.67687	59696	82661	0.73609	70871	19734	47.4
42.7	0.67815	96698	68071	0.73491	45951	49960	47.3
42.8	0.67944	13042	61517	0.73372	98645	02876	47.2
42.9	0.68072	08689	58918	0.73254	28987	87379	47.1
43.0	0.68199	83600	62499	0.73135	37016	19170	47.0
43.1	0.68327	37736	80799	0.73016	22766	20752	46.9
43.2	0.68454	71059	28689	0.72896	86274	21412	46.8
43.3	0.68581	83529	27376	0.72777	27576	57210	46.7
43.4	0.68708	75108	04423	0.72657	46709	70976	46.6
43.5	0.68835	45756	93754	0.72537	43710	12288	46.5
43.6	0.68961	95437	35670	0.72417	18614	37468	46.4
43.7	0.69088	24110	76858	0.72296	71459	09568	46.3
43.8	0.69214	31738	70407	0.72176	02280	98362	46.2
43.9	0.69340	18282	75813	0.72055	11116	80330	46.1
44.0	0.69465	83704	58997	0.71933	98003	38651	46.0
44.1	0.69591	27965	92314	0.71812	62977	63189	45.9
44.2	0.69716	51028	54565	0.71691	06076	50483	45.8
44.3	0.69841	52854	31006	0.71569	27337	03736	45.7
44.4	0.69966	33405	13365	0.71447	26796	32803	45.6
44.5	0.70090	92642	99851	0.71325	04491	54182	45.5
44.6	0.70215	30529	95162	0.71202	60459	90996	45.4
44.7	0.70339	47028	10504	0.71079	94738	72992	45.3
44.8	0.70463	42099	63595	0.70957	07365	36521	45.2
44.9	0.70587	15706	78681	0.70833	98377	24529	45.1
45.0	0.70710	67811	86548	0.70710	67811	86548	45.0
$90^\circ - \theta$	cos θ			sin θ			θ
	* $\left[\begin{matrix} (-7)3 \\ 5 \end{matrix} \right]$			$\left[\begin{matrix} (-7)3 \\ 5 \end{matrix} \right]$			

*See page II.

Table 4.11 CIRCULAR TANGENTS, COTANGENTS, SECANTS AND COSECANTS TO FIVE TENTHS OF A DEGREE

θ	tan θ			cot θ			sec θ		csc θ		$90^\circ - \theta$
0.0°	0.00000	00000	00000	∞	∞	∞	1.00000	000	∞	∞	90.0°
0.5	0.00872	68677	90759	114.58865	01293	09608	1.00003	808	114.59301	348	89.5
1.0	0.01745	50649	28217	57.28996	16307	59424	1.00015	233	57.29868	850	89.0
1.5	0.02618	59215	69187	38.18845	92970	25609	1.00034	279	38.20155	001	88.5
2.0	0.03492	07694	91747	28.63625	32829	15603	1.00060	954	28.65370	835	88.0
2.5	0.04366	09429	08512	22.90376	55484	31198	1.00095	269	22.92558	563	87.5
3.0	0.05240	77792	83041	19.08113	66877	28211	1.00137	235	19.10732	261	87.0
3.5	0.06116	26201	50484	16.34985	54760	99672	1.00186	869	16.38040	824	86.5
4.0	0.06992	68119	43510	14.30066	62567	11928	1.00244	190	14.33558	703	86.0
4.5	0.07870	17068	24618	12.70620	47361	74704	1.00309	220	12.74549	484	85.5
5.0	0.08748	86635	25924	11.43005	23027	61343	1.00381	984	11.47371	325	85.0
5.5	0.09628	90481	97538	10.38539	70801	38159	1.00462	509	10.43343	052	84.5
6.0	0.10510	42352	65676	9.51436	44542	22585	1.00550	828	9.56677	223	84.0
6.5	0.11393	56083	01645	8.77688	73568	69956	1.00646	973	8.83367	147	83.5
7.0	0.12278	45609	02904	8.14434	64279	74594	1.00750	983	8.20550	905	83.0
7.5	0.13165	24975	87396	7.59575	41127	25150	1.00862	896	7.66129	758	82.5
8.0	0.14054	08347	02391	7.11536	97223	84209	1.00982	757	7.18529	653	82.0
8.5	0.14945	10013	49128	6.69115	62383	17409	1.01110	613	6.76546	908	81.5
9.0	0.15838	44403	24536	6.31375	15146	75043	1.01246	513	6.39245	322	81.0
9.5	0.16734	26090	81419	5.97576	43644	33065	1.01390	510	6.05885	796	80.5
10.0	0.17632	69807	08465	5.67128	18196	17709	1.01542	661	5.75877	049	80.0
10.5	0.18533	90449	31534	5.39551	71743	19137	1.01703	027	5.48740	427	79.5
11.0	0.19438	03091	37718	5.14455	40159	70310	1.01871	670	5.24084	307	79.0
11.5	0.20345	22994	23699	4.91515	70310	71205	1.02048	657	5.01585	174	78.5
12.0	0.21255	65616	70022	4.70463	01094	78454	1.02234	059	4.80973	435	78.0
12.5	0.22169	46626	42940	4.51070	85036	62057	1.02427	951	4.62022	632	77.5
13.0	0.23086	81911	25563	4.33147	58742	84155	1.02630	411	4.44541	148	77.0
13.5	0.24007	87590	80116	4.16529	97700	90417	1.02841	519	4.28365	757	76.5
14.0	0.24932	80028	43180	4.01078	09335	35844	1.03061	363	4.13356	550	76.0
14.5	0.25861	75843	55890	3.86671	30948	98738	1.03290	031	3.99392	916	75.5
15.0	0.26794	91924	31122	3.73205	08075	68877	1.03527	618	3.86370	331	75.0
15.5	0.27732	45440	59838	3.60588	35087	60874	1.03774	221	3.74197	754	74.5
16.0	0.28674	53857	58808	3.48741	44438	40908	1.04029	944	3.62795	528	74.0
16.5	0.29621	34949	62080	3.37594	34225	91246	1.04294	891	3.52093	652	73.5
17.0	0.30573	06814	58660	3.27085	26184	84141	1.04569	176	3.42030	362	73.0
17.5	0.31529	87888	78983	3.17159	48023	63212	1.04852	913	3.32550	952	72.5
18.0	0.32491	96962	32906	3.07768	35371	75253	1.05146	222	3.23606	798	72.0
18.5	0.33459	53195	02073	2.98868	49627	42893	1.05449	231	3.15154	530	71.5
19.0	0.34432	76132	89665	2.90421	08776	75823	1.05762	068	3.07155	349	71.0
19.5	0.35411	85725	30698	2.82391	28856	00801	1.06084	870	2.99574	431	70.5
20.0	0.36397	02342	66202	2.74747	74194	54622	1.06417	777	2.92380	440	70.0
20.5	0.37388	46794	84804	2.67462	14939	26824	1.06760	936	2.85545	095	69.5
21.0	0.38386	40350	35416	2.60508	90646	93801	1.07114	499	2.79042	811	69.0
21.5	0.39391	04756	14942	2.53864	78956	64307	1.07478	624	2.72850	383	68.5
22.0	0.40402	62258	35157	2.47508	68534	16296	1.07853	474	2.66946	716	68.0
22.5	0.41421	35623	73095	2.41421	35623	73095	1.08239	220	2.61312	593	67.5
$90^\circ - \theta$	cot θ			tan θ			csc θ		sec θ		θ
	[(-5)1] 8			[(-5)1] 4							

CIRCULAR TANGENTS, COTANGENTS, SECANTS AND COSECANTS Table 4.11
TO FIVE TENTHS OF A DEGREE

θ	tan θ			cot θ			sec θ		csc θ	$90^\circ - \theta$	
22.5°	0.41421	35623	73095	2.41421	35623	73095	1.08239	220	2.61312	593	67.5°
23.0	0.42447	48162	09604	2.35585	23658	23753	1.08636	038	2.55930	467	67.0
23.5	0.43481	23749	60933	2.29984	25472	36257	1.09044	110	2.50784	285	66.5
24.0	0.44522	86853	08536	2.24603	67739	04216	1.09463	628	2.45859	334	66.0
24.5	0.45572	62555	32584	2.19429	97311	65038	1.09894	787	2.41142	102	65.5
25.0	0.46630	76581	54998	2.14450	69205	09558	1.10337	792	2.36620	158	65.0
25.5	0.47697	55326	98160	2.09654	35990	88174	1.10792	854	2.32282	050	64.5
26.0	0.48773	25885	65861	2.05030	38415	79296	1.11260	194	2.28117	203	64.0
26.5	0.49858	16080	53431	2.00568	97082	59020	1.11740	038	2.24115	845	63.5
27.0	0.50952	54494	94429	1.96261	05055	05150	1.12232	624	2.20268	926	63.0
27.5	0.52056	70505	51746	1.92098	21269	71166	1.12738	195	2.16568	057	62.5
28.0	0.53170	94316	61479	1.88072	64653	46332	1.13257	005	2.13005	447	62.0
28.5	0.54295	56996	38437	1.84177	08860	33458	1.13789	318	2.09573	853	61.5
29.0	0.55430	90514	52769	1.80404	77552	71424	1.14335	407	2.06266	534	61.0
29.5	0.56577	27781	87770	1.76749	40162	42891	1.14895	554	2.03077	204	60.5
30.0	0.57735	02691	89626	1.73205	08075	68877	1.15470	054	2.00000	000	60.0
30.5	0.58904	50164	20551	1.69766	31193	26089	1.16059	210	1.97029	441	59.5
31.0	0.60086	06190	27560	1.66427	94823	50518	1.16663	340	1.94160	403	59.0
31.5	0.61280	07881	39932	1.63185	16871	28789	1.17282	770	1.91388	086	58.5
32.0	0.62486	93519	09327	1.60033	45290	41050	1.17917	840	1.88707	991	58.0
32.5	0.63707	02608	07493	1.56968	55771	17490	1.18568	905	1.86115	900	57.5
33.0	0.64940	75931	97510	1.53986	49638	14583	1.19236	329	1.83607	846	57.0
33.5	0.66188	55611	95691	1.51083	51936	14901	1.19920	494	1.81180	103	56.5
34.0	0.67450	85168	42426	1.48256	09685	12740	1.20621	795	1.78829	165	56.0
34.5	0.68728	09586	01613	1.45500	90286	72445	1.21340	641	1.76551	728	55.5
35.0	0.70020	75382	09710	1.42814	80067	42114	1.22077	459	1.74344	680	55.0
35.5	0.71329	30678	97005	1.40194	82944	76336	1.22832	691	1.72205	082	54.5
36.0	0.72654	25280	05361	1.37638	19204	71173	1.23606	798	1.70130	162	54.0
36.5	0.73996	10750	28487	1.35142	24379	45808	1.24400	257	1.68117	299	53.5
37.0	0.75355	40501	02794	1.32704	48216	20410	1.25213	566	1.66164	014	53.0
37.5	0.76732	69879	78960	1.30322	53728	41206	1.26047	241	1.64267	963	52.5
38.0	0.78128	56265	06717	1.27994	16321	93079	1.26901	822	1.62426	925	52.0
38.5	0.79543	59166	67828	1.25717	22989	18954	1.27777	866	1.60638	793	51.5
39.0	0.80978	40331	95007	1.23489	71565	35051	1.28675	957	1.58901	573	51.0
39.5	0.82433	63858	17495	1.21309	70040	92932	1.29596	700	1.57213	369	50.5
40.0	0.83909	96311	77280	1.19175	35925	94210	1.30540	729	1.55572	383	50.0
40.5	0.85408	06854	63466	1.17084	95661	12539	1.31508	700	1.53976	904	49.5
41.0	0.86928	67378	16226	1.15036	84072	21009	1.32501	299	1.52425	309	49.0
41.5	0.88472	52645	55944	1.13029	43863	61753	1.33519	242	1.50916	050	48.5
42.0	0.90040	40442	97840	1.11061	25148	29193	1.34563	273	1.49447	655	48.0
42.5	0.91633	11740	17423	1.09130	85010	69271	1.35634	170	1.48018	723	47.5
43.0	0.93251	50861	37661	1.07236	87100	24682	1.36732	746	1.46627	919	47.0
43.5	0.94896	45667	14880	1.05378	01252	80962	1.37859	847	1.45273	967	46.5
44.0	0.96568	87748	07074	1.03553	03137	90569	1.39016	359	1.43955	654	46.0
44.5	0.98269	72631	15690	1.01760	73929	72125	1.40203	206	1.42671	819	45.5
45.0	1.00000	00000	00000	1.00000	00000	00000	1.41421	356	1.41421	356	45.0
$90^\circ - \theta$	cot θ			tan θ			csc θ		sec θ		θ
	$\left[\begin{smallmatrix} (-5)4 \\ 9 \end{smallmatrix} \right]$			$\left[\begin{smallmatrix} (-4)3 \\ \end{smallmatrix} \right]$			$\left[\begin{smallmatrix} (-5)4 \\ 5 \end{smallmatrix} \right]$		$\left[\begin{smallmatrix} (-4)3 \\ 6 \end{smallmatrix} \right]$		

Table 4.12 CIRCULAR FUNCTIONS FOR THE ARGUMENT $\frac{\pi}{2}x$

x	$\sin \frac{\pi}{2}x$				$\cos \frac{\pi}{2}x$				$\tan \frac{\pi}{2}x$				$1-x$
0.00	0.00000	00000	00000	00000	1.00000	00000	00000	00000	0.00000	00000	00000	00000	1.00
0.01	0.01570	73173	11820	67575	0.99987	66324	81660	59864	0.01570	92553	23664	91632	0.99
0.02	0.03141	07590	78128	29384	0.99950	65603	65731	55700	0.03142	62660	43351	14782	0.98
0.03	0.04710	64507	09642	66090	0.99888	98749	61969	97264	0.04715	88028	77480	47448	0.97
0.04	0.06279	05195	29313	37607	0.99802	67284	28271	56195	0.06291	46672	53649	75722	0.96
0.05	0.07845	90957	27844	94503	0.99691	73337	33127	97620	0.07870	17068	24618	44806	0.95
0.06	0.09410	83133	18514	31847	0.99556	19646	03080	01290	0.09452	78311	79282	04901	0.94
0.07	0.10973	43110	91045	26802	0.99396	09554	55179	68775	0.11040	10278	15818	94497	0.93
0.08	0.12533	32335	64304	24537	0.99211	47013	14477	83105	0.12632	93784	46108	17478	0.92
0.09	0.14090	12319	37582	66116	0.99002	36577	16557	56725	0.14232	10757	02942	94229	0.91
0.10	0.15643	44650	40230	86901	0.98768	83405	95137	72619	0.15838	44403	24536	29384	0.90
0.11	0.17192	91002	79409	54661	0.98510	93261	54773	91802	0.17452	79388	94365	08461	0.89
0.12	0.18738	13145	85724	63054	0.98228	72507	28688	68108	0.19076	02022	18566	74856	0.88
0.13	0.20278	72953	56512	48344	0.97922	28106	21765	78086	0.20709	00444	27938	70402	0.87
0.14	0.21814	32413	96542	55202	0.97591	67619	38747	39896	0.22352	64828	97149	10184	0.86
0.15	0.23344	53638	55905	41177	0.97236	99203	97676	60183	0.24007	87590	80116	03926	0.85
0.16	0.24868	98871	64854	78824	0.96858	31611	28631	11949	0.25675	63603	67726	78332	0.84
0.17	0.26387	30499	65372	89696	0.96455	74184	57798	09366	0.27356	90430	82237	23655	0.83
0.18	0.27899	11060	39229	25185	0.96029	36856	76943	07175	0.29052	68567	31916	45432	0.82
0.19	0.29404	03252	32303	95777	0.95579	30147	98330	12664	0.30764	01696	59898	29067	0.81
0.20	0.30901	69943	74947	42410	0.95105	65162	95153	57211	0.32491	96962	32906	32615	0.80
0.21	0.32391	74181	98149	41440	0.94608	53588	27545	31853	0.34237	65257	28683	05965	0.79
0.22	0.33873	79202	45291	38122	0.94088	07689	54225	47232	0.36002	21530	95756	62634	0.78
0.23	0.35347	48437	79257	12472	0.93544	40308	29867	32518	0.37786	85117	75820	93670	0.77
0.24	0.36812	45526	84677	95915	0.92977	64858	88251	40366	0.39592	80087	97721	26049	0.76
0.25	0.38268	34323	65089	77173	0.92387	95325	11286	75613	0.41421	35623	73095	04880	0.75
0.26	0.39714	78906	34780	61375	0.91775	46256	83981	14114	0.43273	86422	47425	93197	0.74
0.27	0.41151	43586	05108	77405	0.91140	32766	35445	24821	0.45151	73130	86983	28945	0.73
0.28	0.42577	92915	65072	64886	0.90482	70524	66019	52771	0.47056	42812	12251	49308	0.72
0.29	0.43993	91698	55915	14083	0.89802	75757	60615	63093	0.48989	49450	22477	05270	0.71
0.30	0.45399	04997	39546	79156	0.89100	65241	88367	86236	0.50952	54494	94428	81051	0.70
0.31	0.46792	98142	60573	37723	0.88376	56300	88693	42432	0.52947	27451	82014	63252	0.69
0.32	0.48175	36741	01715	27498	0.87630	66800	43863	58731	0.54975	46521	92770	07429	0.68
0.33	0.49545	86684	32407	53805	0.86863	15144	38191	24777	0.57038	99296	73294	88698	0.67
0.34	0.50904	14157	50371	30028	0.86074	20270	03943	63716	0.59139	83513	99471	09817	0.66
0.35	0.52249	85647	15948	86499	0.85264	01643	54092	22152	0.61280	07881	39931	99664	0.65
0.36	0.53582	67949	78996	61827	0.84432	79255	02015	07855	0.63461	92975	44148	10071	0.64
0.37	0.54902	28179	98131	74352	0.83580	73613	68270	25847	0.65687	72224	01279	37691	0.63
0.38	0.56208	33778	52130	60010	0.82708	05742	74561	82492	0.67959	92982	24526	52184	0.62
0.39	0.57500	52520	43278	56590	0.81814	97174	25023	43213	0.70281	17712	40357	33761	0.61
0.40	0.58778	52522	92473	12917	0.80901	69943	74947	42410	0.72654	25280	05360	88589	0.60
0.41	0.60042	02253	25884	04976	0.79968	46584	87090	53868	0.75082	12380	38764	68575	0.59
0.42	0.61290	70536	52976	49336	0.79015	50123	75690	36516	0.77567	95110	49613	10378	0.58
0.43	0.62524	26563	35705	17290	0.78043	04073	38329	73585	0.80115	10705	58751	23382	0.57
0.44	0.63742	39897	48689	71017	0.77051	32427	75789	23080	0.82727	19459	72475	63403	0.56
0.45	0.64944	80483	30183	65572	0.76040	59656	00030	93817	0.85408	06854	63466	63752	0.55
0.46	0.66131	18653	23651	87657	0.75011	10696	30459	54151	0.88161	85923	63189	11465	0.54
0.47	0.67301	25135	09773	33872	0.73963	10949	78609	69747	0.90992	99881	77737	46579	0.53
0.48	0.68454	71059	28688	67373	0.72896	86274	21411	52314	0.93906	25058	17492	35255	0.52
0.49	0.69591	27965	92314	32549	0.71812	62977	63188	83037	0.96906	74171	93793	27618	0.51
0.50	0.70710	67811	86547	52440	0.70710	67811	86547	52440	1.00000	00000	00000	00000	0.50
$1-x$	$\cos \frac{\pi}{2}x$				$\sin \frac{\pi}{2}x$				$\cot \frac{\pi}{2}x$				x
	$\left[\begin{smallmatrix} (-5)2 \\ 10 \end{smallmatrix} \right]$				$\left[\begin{smallmatrix} (-5)3 \\ 10 \end{smallmatrix} \right]$				$\left[\begin{smallmatrix} (-4)1 \end{smallmatrix} \right]$				

CIRCULAR FUNCTIONS FOR THE ARGUMENT $\frac{\pi}{2}x$

Table 4.12

x	$\cot \frac{\pi}{2}x$				$\sec \frac{\pi}{2}x$				$\csc \frac{\pi}{2}x$				$1-x$	
0.00	∞				1.00000	00000	00000	00000					∞	1.00
0.01	63.65674	11628	71580	99500	1.00012	33827	39761	81169	63.66459	53060	00564	58546		0.99
0.02	31.82051	59537	73958	03934	1.00049	36832	37144	42400	31.83622	52090	97622	95566		0.98
0.03	21.20494	87896	88751	52283	1.00111	13587	85243	76109	21.22851	50958	16816	17580		0.97
0.04	15.89454	48438	65303	44576	1.00197	71730	71142	10978	15.92597	11099	08654	59358		0.96
0.05	12.70620	47361	74704	64602	1.00309	21984	82825	50283	12.74549	48431	82374	28619		0.95
0.06	10.57889	49934	05635	52417	1.00445	78193	57019	51480	10.62605	37962	83115	99865		0.94
0.07	9.05788	66862	38928	19329	1.00607	57361	86291	90575	9.11292	00161	49841	72675		0.93
0.08	7.91581	50883	05826	84427	1.00794	79708	09297	28943	7.97872	97555	59476	60149		0.92
0.09	7.02636	62290	41380	19848	1.01007	68726	13784	19104	7.09717	00264	69225	38129		0.91
0.10	6.31375	15146	75043	09898	1.01246	51257	88002	93136	6.39245	32214	99661	54704		0.90
0.11	5.72974	16467	24314	86192	1.01511	57576	62501	87437	5.81635	10329	24944	03199		0.89
0.12	5.24218	35811	13176	73758	1.01803	21481	91042	38259	5.33671	14122	92458	78659		0.88
0.13	4.82881	73521	92759	97818	1.02121	80406	26567	47910	4.93127	53949	49859	96253		0.87
0.14	4.47374	28292	11554	62415	1.02467	75534	55900	33566	4.58414	38570	27373	56913		0.86
0.15	4.16529	97700	90417	20387	1.02841	51936	65208	54585	4.28365	75697	31185	03924		0.85
0.16	3.89474	28549	29859	33474	1.03243	58714	17339	88710	4.02107	22333	75967	50952		0.84
0.17	3.65538	43546	52259	73004	1.03674	49162	32016	53065	3.78970	11465	59780	81919		0.83
0.18	3.44202	25766	69218	62809	1.04134	80947	70681	14007	3.58434	36523	72161	57038		0.82
0.19	3.25055	08012	99836	37634	1.04625	16303	39647	78848	3.40089	40753	61802	31848		0.81
0.20	3.07768	35371	75253	40257	1.05146	22242	38267	21205	3.23606	79774	99789	69641		0.80
0.21	2.92076	09892	98816	40048	1.05698	70790	93232	61183	3.08720	66268	08416	38088		0.79
0.22	2.77760	68539	14974	88865	1.06283	39243	36113	96396	2.95213	47928	09339	97327		0.78
0.23	2.64642	32102	86631	86514	1.06901	10439	98926	01199	2.82905	56388	91501	64260		0.77
0.24	2.52571	16894	47304	99451	1.07552	73070	22247	78234	2.71647	18916	65871	74307		0.76
0.25	2.41421	35623	73095	04880	1.08239	22002	92393	96880	2.61312	59297	52753	05571		0.75
0.26	2.31086	36538	82410	63708	1.08961	58646	48705	30888	2.51795	36983	10349	34110		0.74
0.27	2.21475	44978	13361	51875	1.09720	91341	29537	26252	2.43004	88648	55296	52041		0.73
0.28	2.12510	81731	57202	76115	1.10518	35787	56399	59380	2.34863	46560	54351	86300		0.72
0.29	2.04125	39671	21703	26026	1.11355	15511	90413	37268	2.27304	15214	61957	72361		0.71
0.30	1.96261	05055	05150	58230	1.12232	62376	34360	80715	2.20268	92645	85266	62156		0.70
0.31	1.88867	13416	31067	67620	1.13152	17133	97749	42882	2.13707	26325	27611	85837		0.69
0.32	1.81899	32472	81066	27571	1.14115	30035	92241	17245	2.07574	96076	48793	05903		0.68
0.33	1.75318	66324	72237	08332	1.15123	61494	81376	51287	2.01833	18280	89559	43676		0.67
0.34	1.69090	76557	85011	24674	1.16178	82810	72765	98515	1.96447	66988	67248	48330		0.66
0.35	1.63185	16871	28789	61767	1.17282	76966	14008	94955	1.91388	08554	30942	72280		0.65
0.36	1.57574	78599	68651	08688	1.18437	39497	36918	17500	1.86627	47167	00567	54120		0.64
0.37	1.52235	45068	96131	24085	1.19644	79450	89806	17366	1.82141	79214	74081	38479		0.63
0.38	1.47145	53158	19969	04283	1.20907	20434	06541	15436	1.77909	54854	79867	33350		0.62
0.39	1.42285	60774	31870	59031	1.22227	01770	86068	14117	1.73911	45497	30640	74960		0.61
0.40	1.37638	19204	71173	53820	1.23606	79774	99789	69641	1.70130	16167	04079	86436		0.60
0.41	1.33187	49515	02597	59439	1.25049	29154	09784	85573	1.66550	01910	65749	08074		0.59
0.42	1.28919	22317	85066	67042	1.26557	44560	72090	15648	1.63156	87575	13749	73007		0.58
0.43	1.24820	40363	53049	43751	1.28134	42308	20677	31999	1.59937	90408	68062	88301		0.57
0.44	1.20879	23504	09609	13115	1.29783	62271	84727	12712	1.56881	45035	05365	75750		0.56
0.45	1.17084	95661	12539	22520	1.31508	69998	90784	80424	1.53976	90432	22366	30748		0.55
0.46	1.13427	73492	55405	46422	1.33313	59054	50172	40410	1.51214	58610	31226	40092		0.54
0.47	1.09898	56505	36301	56382	1.35202	53634	40027	12805	1.48585	64735	81717	76608		0.53
0.48	1.06489	18403	24791	86700	1.37180	11480	64918	28453	1.46081	98491	22513	12750		0.52
0.49	1.03191	99492	80495	57182	1.39251	27141	49012	49662	1.43696	16493	57094	20394		0.51
0.50	1.00000	00000	00000	00000	1.41421	35623	73095	04880	1.41421	35623	73095	04880		0.50

$1-x$ $\tan \frac{\pi}{2}x$ $\csc \frac{\pi}{2}x$ $\sec \frac{\pi}{2}x$ x

$[(-4)1]$

Table 4.13

		HARMONIC ANALYSIS											
r	$\sin \frac{2\pi r}{s}$	$\cos \frac{2\pi r}{s}$	$\sin \frac{2\pi r}{s}$	$\cos \frac{2\pi r}{s}$	$\sin \frac{2\pi r}{s}$	$\cos \frac{2\pi r}{s}$	$\sin \frac{2\pi r}{s}$	$\cos \frac{2\pi r}{s}$	$\sin \frac{2\pi r}{s}$	$\cos \frac{2\pi r}{s}$	$\sin \frac{2\pi r}{s}$	$\cos \frac{2\pi r}{s}$	
$s=3$													
1	0.86602	54038	-0.50000	00000	1.00000	00000	+0.00000	00000	0.95105	65163	+0.30901	69944	
2					0.00000	00000	-1.00000	00000	0.58778	52523	-0.80901	69944	
$s=4$													
1	0.86602	54038	+0.50000	00000	0.78183	14824	+0.62348	98019	0.70710	67812	0.70710	67812	
2	0.86602	54038	-0.50000	00000	0.97492	79122	-0.22252	09340	1.00000	00000	+0.00000	00000	
3	0.00000	00000	-1.00000	00000	0.43388	37391	-0.90096	88679	0.70710	67812	-0.70710	67812	
4									0.00000	00000	-1.00000	00000	
$s=5$													
1	0.64278	76097	0.76604	44431	0.58778	52523	0.80901	69944	0.54064	08174	0.84125	35328	
2	0.98480	77530	+0.17364	81777	0.95105	65163	+0.30901	69944	0.90963	19953	+0.41541	50130	
3	0.86602	54038	-0.50000	00000	0.95105	65163	-0.30901	69944	0.98982	14419	-0.14231	48383	
4	0.34202	01433	-0.93969	26208	0.58778	52523	-0.80901	69944	0.75574	95743	-0.65486	07340	
5					0.00000	00000	-1.00000	00000	0.28173	25568	-0.95949	29736	
$s=6$													
1	0.86602	54038	+0.50000	00000	0.46472	31720	0.88545	60257	0.43388	37391	0.90096	88679	
2	0.86602	54038	0.50000	00000	0.82298	38659	0.56806	47468	0.78183	14825	0.62348	98019	
3	1.00000	00000	+0.00000	00000	0.99270	88741	+0.12053	66803	0.97492	79122	+0.22252	09340	
4	0.86602	54038	-0.50000	00000	0.93501	62427	-0.35460	48871	0.97492	79122	-0.22252	09340	
5	0.50000	00000	-0.86602	54038	0.66312	26582	-0.74851	07482	0.78183	14825	-0.62348	98019	
6	0.00000	00000	-1.00000	00000	0.23931	56643	-0.97094	18174	0.43388	37391	-0.90096	88679	
7									0.00000	00000	-1.00000	00000	
$s=7$													
1	0.40673	66431	0.91354	54576	0.38268	34324	0.92387	95325	0.36124	16662	0.93247	22294	
2	0.74314	48255	0.66913	06064	0.70710	67812	0.70710	67812	0.67369	56436	0.73900	89172	
3	0.95105	65163	+0.30901	69944	0.92387	95325	0.38268	34324	0.89516	32913	0.44573	83558	
4	0.99452	18954	-0.10452	84633	1.00000	00000	+0.00000	00000	0.99573	41763	+0.09226	83595	
5	0.86602	54038	-0.50000	00000	0.92387	95325	-0.38268	34324	0.96182	56432	-0.27366	29901	
6	0.58778	52523	-0.80901	69944	0.70710	67812	-0.70710	67812	0.79801	72273	-0.60263	46364	
7	0.20791	16908	-0.97814	76007	0.38268	34324	-0.92387	95325	0.52643	21629	-0.85021	71357	
8					0.00000	00000	-1.00000	00000	0.18374	95178	-0.98297	30997	
$s=8$													
1	0.34202	01433	0.93969	26208	0.32469	94692	0.94581	72417	0.30901	69944	0.95105	65163	
2	0.64278	76097	0.76604	44431	0.61421	27127	0.78914	05094	0.58778	52523	0.80901	69944	
3	0.86602	54038	0.50000	00000	0.83716	64782	0.54694	81581	0.80901	69944	0.58778	52523	
4	0.98480	77530	+0.17364	81777	0.96940	02659	+0.24548	54872	0.95105	65163	0.30901	69944	
5	0.98480	77530	-0.17364	81777	0.99658	44930	-0.08257	93455	1.00000	00000	+0.00000	00000	
6	0.86602	54038	-0.50000	00000	0.91577	33266	-0.40169	54247	0.95105	65163	-0.30901	69944	
7	0.64278	76097	-0.76604	44431	0.73572	39107	-0.67728	15716	0.80901	69944	-0.58778	52523	
8	0.34202	01433	-0.93969	26208	0.47594	73930	-0.87947	37512	0.58778	52523	-0.80901	69944	
9	0.00000	00000	-1.00000	00000	0.16459	45903	-0.98636	13034	0.30901	69944	-0.95105	65163	
10									0.00000	00000	-1.00000	00000	
$s=9$													
1	0.29475	51744	0.95557	28058	0.28173	25568	0.95949	29736	0.26979	67711	0.96291	72874	
2	0.56332	00580	0.82623	87743	0.54064	08174	0.84125	35328	0.51958	39500	0.85441	94046	
3	0.78183	14825	0.62348	98019	0.75574	95743	0.65486	07340	0.73083	59643	0.68255	31432	
4	0.93087	37486	0.36534	10244	0.90963	19953	0.41541	50130	0.88788	52184	0.46006	50378	
5	0.99720	37972	+0.07473	00936	0.98982	14419	+0.14231	48383	0.97908	40877	+0.20345	60131	
6	0.97492	79122	-0.22252	09340	0.98982	14419	-0.14231	48383	0.99766	87692	-0.06824	24134	
7	0.86602	54038	-0.50000	00000	0.90963	19953	-0.41541	50130	0.94226	09221	-0.33487	96122	
8	0.68017	27378	-0.73305	18718	0.75574	95743	-0.65486	07340	0.81696	98930	-0.57668	03221	
9	0.43388	37391	-0.90096	88679	0.54064	08174	-0.84125	35328	0.63108	79443	-0.77571	12907	
10	0.14904	22662	-0.98883	08262	0.28173	25568	-0.95949	29736	0.39840	10898	-0.91721	13015	
11					0.00000	00000	-1.00000	00000	0.13616	66491	-0.99068	59460	
$s=10$													
1	0.25881	90451	0.96592	58263	0.24868	98872	0.96858	31611					
2	0.50000	00000	0.86602	54038	0.48175	36741	0.87630	66801					
3	0.70710	67812	0.70710	67812	0.68454	71059	0.72896	86274					
4	0.86602	54038	0.50000	00000	0.84432	79255	0.53582	67950					
5	0.96592	58263	0.25881	90451	0.95105	65163	0.30901	69944					
6	1.00000	00000	+0.00000	00000	0.99802	67284	+0.06279	05196					
7	0.96592	58263	-0.25881	90451	0.98228	72507	-0.18738	13146					
8	0.86602	54038	-0.50000	00000	0.90482	70525	-0.42577	92916					
9	0.70710	67812	-0.70710	67812	0.77051	32428	-0.63742	39898					
10	0.50000	00000	-0.86602	54038	0.58778	52523	-0.80901	69944					
11	0.25881	90451	-0.96592	58263	0.36812	45527	-0.92977	64859					
12	0.00000	00000	-1.00000	00000	0.12533	32336	-0.99211	47013					

INVERSE CIRCULAR SINES AND TANGENTS

Table 4.14

x	arcsin x		arctan x		x	arcsin x		arctan x		
0.000	0.0000	0000	00	0.0000	0000	00	0.050	0.0500	08568	06
0.001	0.0010	0001	67	0.0009	9999	67	0.051	0.0510	21344	17
0.002	0.0020	0002	33	0.0019	9997	33	0.052	0.0520	34632	28
0.003	0.0030	0003	00	0.0029	9991	00	0.053	0.0530	48442	51
0.004	0.0040	0010	67	0.0039	9978	67	0.054	0.0540	62784	97
0.005	0.0050	0020	34	0.0049	9958	34	0.055	0.0550	77669	81
0.006	0.0060	0030	01	0.0059	9928	02	0.056	0.0560	93107	15
0.007	0.0070	0057	68	0.0069	9885	70	0.057	0.0570	09107	14
0.008	0.0080	0085	36	0.0079	9829	40	0.058	0.0580	25679	92
0.009	0.0090	0125	04	0.0089	9757	12	0.059	0.0590	42835	64
0.010	0.0100	0166	74	0.0099	9666	87	0.060	0.0600	60584	45
0.011	0.0110	0221	45	0.0109	9556	66	0.061	0.0610	78936	52
0.012	0.0120	0288	19	0.0119	9424	50	0.062	0.0620	97902	01
0.013	0.0130	0366	95	0.0129	9257	41	0.063	0.0630	17491	09
0.014	0.0140	0457	74	0.0139	9035	41	0.064	0.0640	37713	94
0.015	0.0150	0562	57	0.0149	8875	52	0.065	0.0650	58580	75
0.016	0.0160	0682	45	0.0159	8634	76	0.066	0.0660	80101	69
0.017	0.0170	0818	40	0.0169	8362	17	0.067	0.0670	02286	97
0.018	0.0180	0972	42	0.0179	8056	78	0.068	0.0680	25146	79
0.019	0.0190	1143	52	0.0189	7714	62	0.069	0.0690	48691	36
0.020	0.0200	1335	73	0.0199	7339	73	0.070	0.0700	72930	88
0.021	0.0210	1543	06	0.0209	6913	17	0.071	0.0710	97875	58
0.022	0.0220	1775	53	0.0219	6451	97	0.072	0.0720	23535	68
0.023	0.0230	2028	16	0.0229	5945	20	0.073	0.0730	49921	42
0.024	0.0240	2304	97	0.0239	5393	92	0.074	0.0740	77043	03
0.025	0.0250	2608	99	0.0249	4793	19	0.075	0.0750	04910	77
0.026	0.0260	2930	25	0.0259	4137	08	0.076	0.0760	33534	87
0.027	0.0270	3281	77	0.0269	3441	68	0.077	0.0770	62925	62
0.028	0.0280	3659	58	0.0279	2686	07	0.078	0.0780	93093	26
0.029	0.0290	4066	72	0.0289	1874	33	0.079	0.0790	24048	07
0.030	0.0300	4518	23	0.0299	1048	57	0.080	0.0800	55800	34
0.031	0.0310	4967	15	0.0309	0075	89	0.081	0.0810	88360	35
0.032	0.0320	5463	51	0.0319	8084	39	0.082	0.0820	21738	40
0.033	0.0330	5992	37	0.0329	8028	21	0.083	0.0830	55944	79
0.034	0.0340	6540	77	0.0339	6907	46	0.084	0.0840	90989	83
0.035	0.0350	7147	75	0.0349	5718	29	0.085	0.0850	26883	84
0.036	0.0360	7780	38	0.0359	4460	82	0.086	0.0860	63637	15
0.037	0.0370	8447	72	0.0369	3129	22	0.087	0.0871	01260	09
0.038	0.0380	9152	81	0.0379	1725	64	0.088	0.0881	39763	00
0.039	0.0390	9893	73	0.0389	0245	25	0.089	0.0891	79156	23
0.040	0.0400	0674	54	0.0399	8687	23	0.090	0.0901	19450	15
0.041	0.0410	1495	31	0.0409	7049	77	0.091	0.0911	60655	11
0.042	0.0420	2357	12	0.0419	5330	05	0.092	0.0921	02781	49
0.043	0.0430	3262	04	0.0429	3527	30	0.093	0.0931	45839	68
0.044	0.0440	4207	16	0.0439	1638	71	0.094	0.0941	89840	07
0.045	0.0450	5203	56	0.0449	9661	52	0.095	0.0951	34793	06
0.046	0.0460	6231	33	0.0459	7595	97	0.096	0.0961	80709	05
0.047	0.0470	7321	57	0.0469	5438	30	0.097	0.0971	27598	48
0.048	0.0480	8451	37	0.0479	3186	77	0.098	0.0981	75471	75
0.049	0.0490	9629	83	0.0489	0840	65	0.099	0.0991	24339	32
0.050	0.0500	08568	06	0.0499	8395	22	0.100	0.1001	74211	62
	$\left[\begin{smallmatrix} (-9)6 \\ 4 \end{smallmatrix} \right]$	$\left[\begin{smallmatrix} (-8)1 \\ 4 \end{smallmatrix} \right]$			$\left[\begin{smallmatrix} (-8)1 \\ 4 \end{smallmatrix} \right]$			$\left[\begin{smallmatrix} (-8)2 \\ 4 \end{smallmatrix} \right]$		

For use and extension of the table see Examples 21–25. For other inverse functions see 4.4 and 4.3.45.

$$\frac{\pi}{2} = 1.57079\ 63267\ 95$$

Compilation of arcsin x from National Bureau of Standards, Table of arcsin x . Columbia Univ. Press, New York, N.Y., 1945 (with permission).

Table 4.14

INVERSE CIRCULAR SINES AND TANGENTS

x	$\arcsin x$	$\arctan x$	x	$\arcsin x$	$\arctan x$
0.100	0.10016 74211 62	0.09966 86524 91	0.150	0.15056 82727 77	0.14888 99476 09
0.101	0.10117 25099 11	0.10065 86531 58	0.151	0.15157 97940 40	0.14986 77989 58
0.102	0.10217 77012 25	0.10164 84558 83	0.152	0.15259 14716 20	0.15084 53616 21
0.103	0.10318 29961 53	0.10263 80587 89	0.153	0.15360 33066 23	0.15182 26338 59
0.104	0.10418 83957 41	0.10362 74599 97	0.154	0.15461 53001 61	0.15279 96139 37
0.105	0.10519 39010 40	0.10461 66576 33	0.155	0.15562 74533 44	0.15377 63001 20
0.106	0.10619 95131 00	0.10560 56498 23	0.156	0.15663 97672 86	0.15475 26906 78
0.107	0.10720 52329 72	0.10659 44346 99	0.157	0.15765 22431 01	0.15572 87838 86
0.108	0.10821 10617 08	0.10758 30103 93	0.158	0.15866 48819 05	0.15670 45780 19
0.109	0.10921 70003 62	0.10857 13750 39	0.159	0.15967 76848 15	0.15768 00713 58
0.110	0.11022 30499 88	0.10955 95267 74	0.160	0.16069 06529 52	0.15865 52621 86
0.111	0.11122 92116 41	0.11054 74637 38	0.161	0.16170 37874 35	0.15963 01487 91
0.112	0.11223 54863 77	0.11153 51840 74	0.162	0.16271 70893 88	0.16060 47294 61
0.113	0.11324 18752 55	0.11252 26859 25	0.163	0.16373 05599 34	0.16157 90024 91
0.114	0.11424 83793 32	0.11350 99674 40	0.164	0.16474 42001 99	0.16255 29661 78
0.115	0.11525 49996 68	0.11449 70267 67	0.165	0.16575 80113 10	0.16352 66188 21
0.116	0.11626 17373 23	0.11548 38620 60	0.166	0.16677 19943 96	0.16449 99587 25
0.117	0.11726 85933 61	0.11647 04714 73	0.167	0.16778 61505 87	0.16547 29841 97
0.118	0.11827 55688 42	0.11745 68531 63	0.168	0.16880 04810 17	0.16644 56935 49
0.119	0.11928 26648 32	0.11844 30052 90	0.169	0.16981 49868 19	0.16741 80850 93
0.120	0.12028 98823 95	0.11942 89260 18	0.170	0.17082 96691 29	0.16839 01571 48
0.121	0.12129 72225 97	0.12041 46135 12	0.171	0.17184 45290 84	0.16936 19080 34
0.122	0.12230 46865 07	0.12140 00659 40	0.172	0.17285 95678 23	0.17033 33360 78
0.123	0.12331 22751 92	0.12238 52814 72	0.173	0.17387 47864 87	0.17130 44396 07
0.124	0.12431 99897 22	0.12337 02582 82	0.174	0.17489 01862 19	0.17227 52169 54
0.125	0.12532 78311 68	0.12435 49945 47	0.175	0.17590 57681 64	0.17324 56664 52
0.126	0.12633 58006 02	0.12533 94884 45	0.176	0.17692 15334 66	0.17421 57864 43
0.127	0.12734 38990 98	0.12632 37381 58	0.177	0.17793 74832 75	0.17518 55752 68
0.128	0.12835 21277 29	0.12730 77418 71	0.178	0.17895 36187 40	0.17615 50312 74
0.129	0.12936 04875 72	0.12829 14977 71	0.179	0.17996 99410 13	0.17712 41528 10
0.130	0.13036 89797 03	0.12927 50040 48	0.180	0.18098 64512 47	0.17809 29382 31
0.131	0.13137 76052 01	0.13025 82588 96	0.181	0.18200 31505 97	0.17906 13858 94
0.132	0.13238 63651 45	0.13124 12605 10	0.182	0.18302 00402 20	0.18002 94941 59
0.133	0.13339 52606 16	0.13222 40070 89	0.183	0.18403 71212 76	0.18099 72613 91
0.134	0.13440 42926 95	0.13320 64968 35	0.184	0.18505 43949 25	0.18196 46859 59
0.135	0.13541 34624 67	0.13418 87279 52	0.185	0.18607 18623 31	0.18293 17662 35
0.136	0.13642 27710 15	0.13517 06986 49	0.186	0.18708 95246 57	0.18389 85005 94
0.137	0.13743 22194 25	0.13615 24071 35	0.187	0.18810 73830 71	0.18486 48874 16
0.138	0.13844 18087 85	0.13713 38516 25	0.188	0.18912 54387 40	0.18583 09250 85
0.139	0.13945 15401 83	0.13811 50303 34	0.189	0.19014 36928 36	0.18679 66119 87
0.140	0.14046 14147 10	0.13909 59414 82	0.190	0.19116 21465 31	0.18776 19465 14
0.141	0.14147 14334 56	0.14007 65832 92	0.191	0.19218 08009 99	0.18872 69270 59
0.142	0.14248 15975 13	0.14105 69539 90	0.192	0.19319 96574 17	0.18969 15520 22
0.143	0.14349 19079 77	0.14203 70518 03	0.193	0.19421 87169 63	0.19065 58198 05
0.144	0.14450 23659 42	0.14301 68749 65	0.194	0.19523 79808 18	0.19161 97288 15
0.145	0.14551 29725 04	0.14399 64217 09	0.195	0.19625 74501 64	0.19258 32774 60
0.146	0.14652 37287 64	0.14497 56902 74	0.196	0.19727 71261 85	0.19354 64641 55
0.147	0.14753 46358 19	0.14595 46789 00	0.197	0.19829 70100 69	0.19450 92873 18
0.148	0.14854 56947 71	0.14693 33858 33	0.198	0.19931 71030 03	0.19547 17453 71
0.149	0.14955 69067 22	0.14791 18093 19	0.199	0.20033 74061 80	0.19643 38367 38
0.150	0.15056 82727 77	0.14888 99476 09	0.200	0.20135 79207 90	0.19739 55598 50

$$\frac{\pi}{2} = 1.57079 63267 95$$

INVERSE CIRCULAR SINES AND TANGENTS

Table 4.14

x	arcsin x	arctan x	x	arcsin x	arctan x
0.200	0.20135 79207 90	0.19739 55598 50	0.250	0.25268 02551 42	0.24497 86631 27
0.201	0.20237 86480 31	0.19835 69131 40	0.251	0.25371 31886 28	0.24591 96179 19
0.202	0.20339 95890 97	0.19931 78950 44	0.252	0.25474 63988 49	0.24686 01284 51
0.203	0.20442 07451 90	0.20027 85040 06	0.253	0.25577 98871 33	0.24780 01933 77
0.204	0.20544 21175 10	0.20123 87384 69	0.254	0.25681 36548 08	0.24873 98113 53
0.205	0.20646 37072 61	0.20219 85968 83	0.255	0.25784 77032 07	0.24967 89810 38
0.206	0.20748 55156 48	0.20315 80777 01	0.256	0.25888 20336 66	0.25061 77010 99
0.207	0.20850 75438 81	0.20411 71793 81	0.257	0.25991 66475 22	0.25155 59702 05
0.208	0.20952 97931 68	0.20507 59003 83	0.258	0.26095 15461 18	0.25249 37870 29
0.209	0.21055 22647 22	0.20603 42391 73	0.259	0.26198 67307 97	0.25343 11502 51
0.210	0.21157 49597 58	0.20699 21942 20	0.260	0.26302 22029 08	0.25436 80585 53
0.211	0.21259 78794 93	0.20794 97639 97	0.261	0.26405 79638 02	0.25530 45106 23
0.212	0.21362 10251 46	0.20890 69469 83	0.262	0.26509 40148 31	0.25624 05051 53
0.213	0.21464 43979 39	0.20986 37416 57	0.263	0.26613 03573 53	0.25717 60408 40
0.214	0.21566 79990 96	0.21082 01465 06	0.264	0.26716 69927 28	0.25811 11163 83
0.215	0.21669 18298 42	0.21177 61600 20	0.265	0.26820 39223 20	0.25904 57304 89
0.216	0.21771 58914 06	0.21273 17806 92	0.266	0.26924 11474 95	0.25997 98818 68
0.217	0.21874 01850 19	0.21368 70070 19	0.267	0.27027 86696 22	0.26091 35692 33
0.218	0.21976 47119 15	0.21464 18375 04	0.268	0.27131 64900 75	0.26184 67913 04
0.219	0.22078 94733 28	0.21559 62706 53	0.269	0.27235 46102 31	0.26277 95468 05
0.220	0.22181 44704 97	0.21655 03049 76	0.270	0.27339 30314 67	0.26371 18344 62
0.221	0.22283 97046 62	0.21750 39389 87	0.271	0.27443 17551 69	0.26464 36530 10
0.222	0.22386 51770 66	0.21845 71712 05	0.272	0.27547 07827 21	0.26557 50011 84
0.223	0.22489 08889 55	0.21941 00001 53	0.273	0.27651 01155 13	0.26650 58777 27
0.224	0.22591 68415 75	0.22036 24243 57	0.274	0.27754 97549 38	0.26743 62813 84
0.225	0.22694 30361 79	0.22131 44423 48	0.275	0.27858 97023 92	0.26836 62109 06
0.226	0.22796 94740 17	0.22226 60526 61	0.276	0.27962 99592 75	0.26929 56650 49
0.227	0.22899 61563 45	0.22321 72538 37	0.277	0.28067 05269 90	0.27022 46425 71
0.228	0.23002 30844 22	0.22416 80444 19	0.278	0.28171 14069 43	0.27115 31422 39
0.229	0.23105 02595 07	0.22511 84229 53	0.279	0.28275 26005 45	0.27208 11628 19
0.230	0.23207 76828 63	0.22606 83879 94	0.280	0.28379 41092 08	0.27300 87030 87
0.231	0.23310 53557 56	0.22701 79380 96	0.281	0.28483 59343 51	0.27393 57618 19
0.232	0.23413 32794 53	0.22796 70718 22	0.282	0.28587 80773 93	0.27486 23377 99
0.233	0.23516 14552 26	0.22891 57877 34	0.283	0.28692 05397 58	0.27578 84298 14
0.234	0.23618 98843 48	0.22986 40844 03	0.284	0.28796 33228 75	0.27671 40366 55
0.235	0.23721 85680 94	0.23081 19604 03	0.285	0.28900 64281 74	0.27763 91571 20
0.236	0.23824 75077 44	0.23175 94143 10	0.286	0.29004 98570 89	0.27856 37900 08
0.237	0.23927 67045 78	0.23270 64447 07	0.287	0.29109 36110 61	0.27948 79341 26
0.238	0.24030 61598 80	0.23365 30501 80	0.288	0.29213 76915 30	0.28041 15882 83
0.239	0.24133 58749 37	0.23459 92293 19	0.289	0.29318 20999 43	0.28133 47512 95
0.240	0.24236 58510 39	0.23554 49807 21	0.290	0.29422 68377 49	0.28225 74219 81
0.241	0.24339 60894 77	0.23649 03029 83	0.291	0.29527 19064 01	0.28317 95991 65
0.242	0.24442 65915 47	0.23743 51947 10	0.292	0.29631 73073 57	0.28410 12816 76
0.243	0.24545 73585 45	0.23837 96545 10	0.293	0.29736 30420 76	0.28502 24683 46
0.244	0.24648 83917 73	0.23932 36809 95	0.294	0.29840 91120 25	0.28594 31580 14
0.245	0.24751 96925 34	0.24026 72727 81	0.295	0.29945 55186 70	0.28686 33495 23
0.246	0.24855 12621 33	0.24121 04284 90	0.296	0.30050 22634 85	0.28778 30417 18
0.247	0.24958 31018 81	0.24215 31467 47	0.297	0.30154 93479 45	0.28870 22334 53
0.248	0.25061 52130 88	0.24309 54261 82	0.298	0.30259 67735 30	0.28962 09235 83
0.249	0.25164 75970 69	0.24403 72654 29	0.299	0.30364 45417 24	0.29053 91109 69
0.250	0.25268 02551 42	0.24497 86631 27	0.300	0.30469 26540 15	0.29145 67944 78

$$\frac{\pi}{2} = 1.57079 63267 95$$

Table 4.14

INVERSE CIRCULAR SINES AND TANGENTS

x	$\arcsin x$	$\arctan x$	x	$\arcsin x$	$\arctan x$
0.300	0.30469 26540 15	0.29145 67944 78	0.350	0.35757 11036 46	0.33667 48193 87
0.301	0.30574 11118 95	0.29237 39729 79	0.351	0.35863 88378 55	0.33756 54100 58
0.302	0.30678 99168 60	0.29329 06453 47	0.352	0.35970 69995 85	0.33845 54442 85
0.303	0.30783 90704 09	0.29420 68104 62	0.353	0.36077 55905 70	0.33934 49211 81
0.304	0.30888 85740 46	0.29512 24672 09	0.354	0.36184 46125 51	0.34023 38398 61
0.305	0.30993 84292 78	0.29603 76144 75	0.355	0.36291 40672 71	0.34112 21994 49
0.306	0.31098 86376 19	0.29695 22511 55	0.356	0.36398 39564 82	0.34200 99990 70
0.307	0.31203 92005 83	0.29786 63761 46	0.357	0.36505 42819 39	0.34289 72378 56
0.308	0.31309 01196 91	0.29877 99883 52	0.358	0.36612 50454 05	0.34378 39149 42
0.309	0.31414 13964 68	0.29969 30866 80	0.359	0.36719 62486 46	0.34467 00294 69
0.310	0.31519 30324 41	0.30060 56700 42	0.360	0.36826 78934 37	0.34555 55805 82
0.311	0.31624 50291 43	0.30151 77373 55	0.361	0.36933 99815 54	0.34644 05674 30
0.312	0.31729 73881 12	0.30242 92875 41	0.362	0.37041 25147 84	0.34732 49891 68
0.313	0.31835 01108 88	0.30334 03195 25	0.363	0.37148 54949 16	0.34820 88449 54
0.314	0.31940 31990 18	0.30425 08322 38	0.364	0.37255 89237 46	0.34909 21339 52
0.315	0.32045 66540 50	0.30516 08246 16	0.365	0.37363 28030 75	0.34997 48553 30
0.316	0.32151 04775 38	0.30607 02955 99	0.366	0.37470 71347 12	0.35085 70082 60
0.317	0.32256 46710 42	0.30697 92441 31	0.367	0.37578 19204 71	0.35173 85919 21
0.318	0.32361 92361 24	0.30788 76691 62	0.368	0.37685 71621 69	0.35261 96054 93
0.319	0.32467 41743 51	0.30879 55696 46	0.369	0.37793 28616 34	0.35350 00481 64
0.320	0.32572 94872 95	0.30970 29445 42	0.370	0.37900 90206 96	0.35437 99191 23
0.321	0.32678 51765 31	0.31060 97928 14	0.371	0.38008 56411 93	0.35525 92175 68
0.322	0.32784 12436 42	0.31151 61134 29	0.372	0.38116 27249 69	0.35613 79426 98
0.323	0.32889 76902 11	0.31242 19053 60	0.373	0.38224 02738 73	0.35701 60937 18
0.324	0.32995 45178 29	0.31332 71675 84	0.374	0.38331 82897 61	0.35789 36698 38
0.325	0.33101 17280 89	0.31423 18990 84	0.375	0.38439 67744 96	0.35877 06702 71
0.326	0.33206 93225 91	0.31513 60988 47	0.376	0.38547 57299 45	0.35964 70942 35
0.327	0.33312 73029 38	0.31603 97658 63	0.377	0.38655 51579 83	0.36052 29409 56
0.328	0.33418 56707 38	0.31694 28991 30	0.378	0.38763 50604 92	0.36139 82096 58
0.329	0.33524 44276 04	0.31784 54976 47	0.379	0.38871 54393 57	0.36227 28995 76
0.330	0.33630 35751 54	0.31874 75604 21	0.380	0.38979 62964 74	0.36314 70099 46
0.331	0.33736 31150 09	0.31964 90864 60	0.381	0.39087 76337 42	0.36402 05400 09
0.332	0.33842 30487 98	0.32055 00747 81	0.382	0.39195 94530 68	0.36489 34890 12
0.333	0.33948 33781 50	0.32145 05244 03	0.383	0.39304 17563 64	0.36576 58562 04
0.334	0.34054 41047 05	0.32235 04343 49	0.384	0.39412 45455 51	0.36663 76408 40
0.335	0.34160 52301 02	0.32324 98036 48	0.385	0.39520 78225 54	0.36750 88421 81
0.336	0.34266 67559 88	0.32414 86313 34	0.386	0.39629 15893 06	0.36837 94594 90
0.337	0.34372 86840 15	0.32504 69164 46	0.387	0.39737 58477 48	0.36924 94920 36
0.338	0.34479 10158 39	0.32594 46580 25	0.388	0.39846 05998 24	0.37011 89390 92
0.339	0.34585 37531 21	0.32684 18551 19	0.389	0.39954 58474 89	0.37098 77999 35
0.340	0.34691 68975 27	0.32773 85067 81	0.390	0.40063 15927 01	0.37185 60738 49
0.341	0.34798 04507 29	0.32863 46120 66	0.391	0.40171 78374 28	0.37272 37601 18
0.342	0.34904 44144 03	0.32953 01700 37	0.392	0.40280 45836 44	0.37359 08580 36
0.343	0.35010 87902 30	0.33042 51797 60	0.393	0.40389 18333 27	0.37445 73668 96
0.344	0.35117 35798 98	0.33131 96403 04	0.394	0.40497 95884 67	0.37532 32860 01
0.345	0.35223 87850 97	0.33221 35507 47	0.395	0.40606 78510 57	0.37618 86146 53
0.346	0.35330 44075 25	0.33310 69101 67	0.396	0.40715 66231 00	0.37705 33521 62
0.347	0.35437 04488 84	0.33399 97176 49	0.397	0.40824 59066 02	0.37791 74978 43
0.348	0.35543 69108 81	0.33489 19722 83	0.398	0.40933 57035 81	0.37878 10510 12
0.349	0.35650 37952 29	0.33578 36731 63	0.399	0.41042 60160 60	0.37964 40109 93
0.350	0.35757 11036 46	0.33667 48193 87	0.400	0.41151 68460 67	0.38050 63771 12
	$\left[\begin{smallmatrix} (-8)5 \\ 4 \end{smallmatrix} \right]$	$\left[\begin{smallmatrix} (-8)7 \\ 4 \end{smallmatrix} \right]$		$\left[\begin{smallmatrix} (-8)6 \\ 4 \end{smallmatrix} \right]$	$\left[\begin{smallmatrix} (-8)8 \\ 4 \end{smallmatrix} \right]$

$$\frac{\pi}{2} = 1.57079\ 63267\ 95$$

INVERSE CIRCULAR SINES AND TANGENTS

Table 4.14

x	arcsin x		arctan x		x	arcsin x		arctan x	
0.400	0.41151	68460 67	0.38050	63771 12	0.450	0.46676	53390 47	0.42285	39261 33
0.401	0.41260	81956 42	0.38136	81487 02	0.451	0.46788	54404 09	0.42368	52156 87
0.402	0.41370	00668 29	0.38222	93250 97	0.452	0.46900	61761 03	0.42451	58823 89
0.403	0.41479	24616 80	0.38308	99056 39	0.453	0.47012	75486 20	0.42534	59257 92
0.404	0.41588	53822 54	0.38394	98896 72	0.454	0.47124	95604 59	0.42617	53454 56
0.405	0.41697	88306 20	0.38480	92765 46	0.455	0.47237	22141 29	0.42700	41409 43
0.406	0.41807	28088 50	0.38566	80656 14	0.456	0.47349	55121 50	0.42783	23118 21
0.407	0.41916	73190 29	0.38652	62562 34	0.457	0.47461	94570 53	0.42865	98576 60
0.408	0.42026	23632 45	0.38738	38477 69	0.458	0.47574	40513 79	0.42948	67780 36
0.409	0.42135	79435 96	0.38824	08395 85	0.459	0.47686	92976 80	0.43031	30725 28
0.410	0.42245	40621 87	0.38909	72310 55	0.460	0.47799	51985 19	0.43113	87407 19
0.411	0.42355	07211 31	0.38995	30215 54	0.461	0.47912	17564 68	0.43196	37821 96
0.412	0.42464	79225 49	0.39080	82104 62	0.462	0.48024	89741 12	0.43278	81965 51
0.413	0.42574	56685 70	0.39166	27971 64	0.463	0.48137	68540 46	0.43361	19833 80
0.414	0.42684	39613 30	0.39251	67810 48	0.464	0.48250	53988 75	0.43443	51422 81
0.415	0.42794	28029 74	0.39337	01615 09	0.465	0.48363	46112 18	0.43525	76728 58
0.416	0.42904	21956 53	0.39422	29379 43	0.466	0.48476	44937 02	0.43607	95747 19
0.417	0.43014	21415 30	0.39507	51097 52	0.467	0.48589	50489 67	0.43690	08474 74
0.418	0.43124	26427 72	0.39592	66763 44	0.468	0.48702	62796 64	0.43772	14907 40
0.419	0.43234	37015 57	0.39677	76371 29	0.469	0.48815	81884 55	0.43854	15041 36
0.420	0.43344	53200 70	0.39762	79915 22	0.470	0.48929	07780 14	0.43936	08872 85
0.421	0.43454	75005 03	0.39847	77389 43	0.471	0.49042	40510 26	0.44017	96398 14
0.422	0.43565	02450 60	0.39932	68788 14	0.472	0.49155	80101 88	0.44099	77613 55
0.423	0.43675	35559 49	0.40017	54105 66	0.473	0.49269	26582 08	0.44181	52515 43
0.424	0.43785	74353 90	0.40102	33336 29	0.474	0.49382	79978 07	0.44263	21100 17
0.425	0.43896	18856 10	0.40187	06474 40	0.475	0.49496	40317 17	0.44344	83364 20
0.426	0.44006	69088 44	0.40271	73514 42	0.476	0.49610	07626 82	0.44426	39303 99
0.427	0.44117	25073 36	0.40356	34450 79	0.477	0.49723	81934 59	0.44507	88916 06
0.428	0.44227	86833 39	0.40440	89278 00	0.478	0.49837	63268 16	0.44589	32196 95
0.429	0.44338	54391 16	0.40525	37990 60	0.479	0.49951	51655 34	0.44670	69143 24
0.430	0.44449	27769 36	0.40609	80583 18	0.480	0.50065	47124 05	0.44751	99751 57
0.431	0.44560	06990 78	0.40694	17050 34	0.481	0.50179	49702 34	0.44833	24018 60
0.432	0.44670	92078 31	0.40778	47386 77	0.482	0.50293	59418 39	0.44914	41941 03
0.433	0.44781	83054 92	0.40862	71587 18	0.483	0.50407	76300 52	0.44995	53515 61
0.434	0.44892	79943 67	0.40946	89646 31	0.484	0.50522	00377 13	0.45076	58739 11
0.435	0.45003	82767 71	0.41031	01558 96	0.485	0.50636	31676 79	0.45157	57608 36
0.436	0.45114	91550 28	0.41115	07319 97	0.486	0.50750	70228 19	0.45238	50120 20
0.437	0.45226	06314 71	0.41199	06924 22	0.487	0.50865	16060 14	0.45319	36271 55
0.438	0.45337	27084 44	0.41283	00366 64	0.488	0.50979	69201 57	0.45400	16059 33
0.439	0.45448	53882 99	0.41366	87642 17	0.489	0.51094	29681 57	0.45480	89480 51
0.440	0.45559	86733 96	0.41450	68745 85	0.490	0.51208	97529 34	0.45561	56532 11
0.441	0.45671	25661 07	0.41534	43672 70	0.491	0.51323	72774 22	0.45642	17211 17
0.442	0.45782	70688 11	0.41618	12417 83	0.492	0.51438	55445 69	0.45722	71514 78
0.443	0.45894	21838 99	0.41701	74976 36	0.493	0.51553	45573 34	0.45803	19440 06
0.444	0.46005	79137 71	0.41785	31343 48	0.494	0.51668	43186 93	0.45883	60984 16
0.445	0.46117	42608 35	0.41868	81514 38	0.495	0.51783	48316 32	0.45963	96144 30
0.446	0.46229	12275 10	0.41952	25484 34	0.496	0.51898	60991 55	0.46044	24917 71
0.447	0.46340	88162 25	0.42035	63248 66	0.497	0.52013	81242 77	0.46124	47301 65
0.448	0.46452	70294 19	0.42118	94802 67	0.498	0.52129	09100 26	0.46204	63293 45
0.449	0.46564	58695 40	0.42202	20141 75	0.499	0.52244	44594 47	0.46284	72890 44
0.450	0.46676	53390 47	0.42285	39261 33	0.500	0.52359	87755 98	0.46364	76090 01
	$\left[\begin{smallmatrix} (-8)8 \\ 4 \end{smallmatrix} \right]$		$\left[\begin{smallmatrix} (-8)8 \\ 4 \end{smallmatrix} \right]$			$\left[\begin{smallmatrix} (-7)1 \\ 4 \end{smallmatrix} \right]$		$\left[\begin{smallmatrix} (-8)8 \\ 4 \end{smallmatrix} \right]$	

$$\frac{\pi}{2} = 1.57079\ 63267\ 95$$

Table 4.14

INVERSE CIRCULAR SINES AND TANGENTS

x	arcsin x		arctan x		x	arcsin x		arctan x	
0.500	0.52359	87755 98	0.46364	76090 01	0.550	0.58236	42378 69	0.50284	32109 28
0.501	0.52475	38615 51	0.46444	72889 58	0.551	0.58356	20792 89	0.50361	06410 37
0.502	0.52590	97203 91	0.46524	63286 62	0.552	0.58476	08688 33	0.50437	74226 73
0.503	0.52706	63552 20	0.46604	47278 61	0.553	0.58596	06104 84	0.50514	35557 57
0.504	0.52822	37691 54	0.46684	24863 09	0.554	0.58716	13082 43	0.50590	90402 12
0.505	0.52938	19653 22	0.46763	96037 63	0.555	0.58836	29661 37	0.50667	38759 68
0.506	0.53054	09468 69	0.46843	60799 83	0.556	0.58956	55882 10	0.50743	80629 53
0.507	0.53170	07169 56	0.46923	19147 34	0.557	0.59076	91785 32	0.50820	16011 02
0.508	0.53286	12787 56	0.47002	71077 82	0.558	0.59197	37411 92	0.50896	44903 52
0.509	0.53402	26354 61	0.47082	16589 00	0.559	0.59317	92803 04	0.50972	67306 43
0.510	0.53518	47902 76	0.47161	55678 62	0.560	0.59438	58000 01	0.51048	83219 17
0.511	0.53634	77464 20	0.47240	88344 48	0.561	0.59559	33044 41	0.51124	92641 21
0.512	0.53751	15071 30	0.47320	14584 38	0.562	0.59680	17978 05	0.51200	95572 04
0.513	0.53867	60756 57	0.47399	34396 20	0.563	0.59801	12842 95	0.51276	92011 19
0.514	0.53984	14552 69	0.47478	47777 82	0.564	0.59922	17681 37	0.51352	81958 22
0.515	0.54100	76492 49	0.47557	54727 17	0.565	0.60043	32535 81	0.51428	65412 69
0.516	0.54217	46608 96	0.47636	55242 22	0.566	0.60164	57448 99	0.51504	42374 25
0.517	0.54334	24935 25	0.47715	49320 97	0.567	0.60285	92463 89	0.51580	12842 52
0.518	0.54451	11504 67	0.47794	36961 45	0.568	0.60407	37623 71	0.51655	76817 18
0.519	0.54568	06350 69	0.47873	18161 73	0.569	0.60528	92971 89	0.51731	34297 96
0.520	0.54685	09506 96	0.47951	92919 93	0.570	0.60650	58552 13	0.51806	85284 57
0.521	0.54802	21007 28	0.48030	61234 17	0.571	0.60772	34408 36	0.51882	29776 79
0.522	0.54919	40885 61	0.48109	23102 64	0.572	0.60894	20584 75	0.51957	67774 41
0.523	0.55036	69176 11	0.48187	78523 54	0.573	0.61016	17125 74	0.52032	99277 27
0.524	0.55154	05913 07	0.48266	27495 12	0.574	0.61138	24076 01	0.52108	24285 22
0.525	0.55271	51130 97	0.48344	70015 67	0.575	0.61260	41480 49	0.52183	42798 14
0.526	0.55389	04864 46	0.48423	06083 50	0.576	0.61382	69384 37	0.52258	54815 96
0.527	0.55506	67148 37	0.48501	35696 94	0.577	0.61505	07833 09	0.52333	60338 62
0.528	0.55624	38017 69	0.48579	58854 40	0.578	0.61627	56872 37	0.52408	59366 09
0.529	0.55742	17507 59	0.48657	75554 29	0.579	0.61750	16548 17	0.52483	51898 38
0.530	0.55860	05653 43	0.48735	85795 05	0.580	0.61872	86906 72	0.52558	37935 52
0.531	0.55978	02490 72	0.48813	89575 18	0.581	0.61995	67994 52	0.52633	17477 57
0.532	0.56096	08055 18	0.48891	86893 19	0.582	0.62118	59858 34	0.52707	90524 63
0.533	0.56214	22382 69	0.48969	77747 65	0.583	0.62241	62545 21	0.52782	57076 82
0.534	0.56332	45509 33	0.49047	62137 12	0.584	0.62364	76102 44	0.52857	17134 28
0.535	0.56450	77471 34	0.49125	40060 25	0.585	0.62488	00577 61	0.52931	70697 19
0.536	0.56569	18305 17	0.49203	11515 68	0.586	0.62611	36018 60	0.53006	17765 76
0.537	0.56687	68047 44	0.49280	76502 10	0.587	0.62734	82473 54	0.53080	58340 23
0.538	0.56806	26734 97	0.49358	35018 23	0.588	0.62858	39990 87	0.53154	92420 86
0.539	0.56924	94404 76	0.49435	87062 83	0.589	0.62982	08619 28	0.53229	20007 93
0.540	0.57043	71094 00	0.49513	32634 68	0.590	0.63105	88407 78	0.53303	41101 77
0.541	0.57162	56840 08	0.49590	71732 62	0.591	0.63229	79405 66	0.53377	55702 73
0.542	0.57281	51680 58	0.49668	04355 48	0.592	0.63353	81662 50	0.53451	63811 18
0.543	0.57400	55653 28	0.49745	30502 17	0.593	0.63477	95228 17	0.53525	65427 53
0.544	0.57519	68796 15	0.49822	50171 59	0.594	0.63602	20152 84	0.53599	60552 20
0.545	0.57638	91147 36	0.49899	63362 71	0.595	0.63726	56487 00	0.53673	49185 66
0.546	0.57758	22745 29	0.49976	70074 50	0.596	0.63851	04281 42	0.53747	31328 39
0.547	0.57877	63628 51	0.50053	70305 98	0.597	0.63975	63587 17	0.53821	06980 90
0.548	0.57997	13835 79	0.50130	64056 22	0.598	0.64100	34455 66	0.53894	76143 74
0.549	0.58116	73406 12	0.50207	51324 28	0.599	0.64225	16938 57	0.53968	38817 48
0.550	0.58236	42378 69	0.50284	32109 28	0.600	0.64350	11087 93	0.54041	95002 71
	$\left[\begin{smallmatrix} (-7)1 \\ 4 \end{smallmatrix} \right]$		$\left[\begin{smallmatrix} (-8)8 \\ 4 \end{smallmatrix} \right]$			$\left[\begin{smallmatrix} (-7)2 \\ 5 \end{smallmatrix} \right]$		$\left[\begin{smallmatrix} (-8)8 \\ 4 \end{smallmatrix} \right]$	

$$\frac{\pi}{2} = 1.57079\ 63267\ 95$$

INVERSE CIRCULAR SINES AND TANGENTS

Table 4.14

x	arcsin x		arctan x		x	arcsin x		arctan x	
0.600	0.64350	11087 93	0.54041	95002 71	0.650	0.70758	44367 25	0.57637	52205 91
0.601	0.64475	16956 07	0.54115	44700 04	0.651	0.70890	10818 82	0.57707	78870 95
0.602	0.64600	34595 63	0.54188	87910 15	0.652	0.71021	92154 53	0.57777	99113 37
0.603	0.64725	64059 60	0.54262	24633 69	0.653	0.71153	88447 93	0.57848	12935 07
0.604	0.64851	05401 26	0.54335	54871 37	0.654	0.71285	99773 14	0.57918	20337 94
0.605	0.64976	58674 24	0.54408	78623 92	0.655	0.71418	26204 76	0.57988	21323 94
0.606	0.65102	23932 51	0.54481	95892 10	0.656	0.71550	67817 97	0.58058	15895 01
0.607	0.65228	01230 34	0.54555	06676 70	0.657	0.71683	24688 45	0.58128	04053 13
0.608	0.65353	90622 38	0.54628	10978 51	0.658	0.71815	96892 45	0.58197	85800 31
0.609	0.65479	92163 58	0.54701	08798 38	0.659	0.71948	84506 75	0.58267	61138 57
0.610	0.65606	05909 25	0.54774	00137 16	0.660	0.72081	87608 70	0.58337	30069 94
0.611	0.65732	31915 05	0.54846	84995 75	0.661	0.72215	06276 21	0.58406	92596 49
0.612	0.65858	70237 00	0.54919	63375 05	0.662	0.72348	40587 76	0.58476	48720 31
0.613	0.65985	20931 44	0.54992	35276 01	0.663	0.72481	90622 40	0.58545	98443 49
0.614	0.66111	84055 09	0.55065	00699 59	0.664	0.72615	56459 74	0.58615	41768 17
0.615	0.66238	59665 02	0.55137	59646 79	0.665	0.72749	38180 01	0.58684	78696 50
0.616	0.66365	47818 67	0.55210	12118 61	0.666	0.72883	35864 02	0.58754	09230 63
0.617	0.66492	48573 84	0.55282	58116 10	0.667	0.73017	49593 16	0.58823	33372 77
0.618	0.66619	61988 69	0.55354	97640 33	0.668	0.73151	79449 44	0.58892	51125 11
0.619	0.66746	88121 78	0.55427	30692 38	0.669	0.73286	25515 49	0.58961	62489 89
0.620	0.66874	27032 02	0.55499	57273 39	0.670	0.73420	87874 53	0.59030	67469 35
0.621	0.67001	78778 71	0.55571	77384 48	0.671	0.73555	66610 44	0.59099	66065 77
0.622	0.67129	43421 53	0.55643	91026 82	0.672	0.73690	61807 69	0.59168	58281 44
0.623	0.67257	21020 54	0.55715	98201 62	0.673	0.73825	73551 41	0.59237	44118 66
0.624	0.67385	11636 20	0.55787	98910 07	0.674	0.73961	01927 39	0.59306	23579 77
0.625	0.67513	15329 37	0.55859	93153 44	0.675	0.74096	47022 03	0.59374	96667 11
0.626	0.67641	32161 29	0.55931	80932 97	0.676	0.74232	08922 43	0.59443	63383 05
0.627	0.67769	62193 62	0.56003	62249 97	0.677	0.74367	87716 32	0.59512	23729 99
0.628	0.67898	05488 41	0.56075	37105 74	0.678	0.74503	83492 13	0.59580	77710 32
0.629	0.68026	62108 12	0.56147	05501 63	0.679	0.74639	96338 96	0.59649	25326 49
0.630	0.68155	32115 63	0.56218	67439 00	0.680	0.74776	26346 60	0.59717	66580 93
0.631	0.68284	15574 24	0.56290	22919 24	0.681	0.74912	73605 52	0.59786	01476 11
0.632	0.68413	12547 66	0.56361	71943 75	0.682	0.75049	38206 91	0.59854	30014 52
0.633	0.68542	23100 04	0.56433	14513 97	0.683	0.75186	20242 68	0.59922	52198 66
0.634	0.68671	47295 93	0.56504	50631 37	0.684	0.75323	19805 42	0.59990	68031 06
0.635	0.68800	85200 35	0.56575	80297 42	0.685	0.75460	36988 49	0.60058	77514 26
0.636	0.68930	36878 74	0.56647	03513 63	0.686	0.75597	71885 95	0.60126	80650 81
0.637	0.69060	02396 97	0.56718	20281 53	0.687	0.75735	24592 63	0.60194	77443 31
0.638	0.69189	81821 37	0.56789	30602 67	0.688	0.75872	95204 10	0.60262	67894 35
0.639	0.69319	75218 73	0.56860	34478 63	0.689	0.76010	83816 68	0.60330	52006 54
0.640	0.69449	82656 27	0.56931	31911 01	0.690	0.76148	90527 48	0.60398	29782 53
0.641	0.69580	04201 68	0.57002	22901 42	0.691	0.76287	15434 36	0.60466	01224 96
0.642	0.69710	39923 13	0.57073	07451 52	0.692	0.76425	58636 00	0.60533	66336 52
0.643	0.69840	89889 23	0.57143	85562 98	0.693	0.76564	20231 84	0.60601	25119 88
0.644	0.69971	54169 09	0.57214	57237 47	0.694	0.76703	00322 15	0.60668	77577 76
0.645	0.70102	32832 27	0.57285	22476 73	0.695	0.76841	99008 00	0.60736	23712 89
0.646	0.70233	25948 84	0.57355	81282 48	0.696	0.76981	16391 29	0.60803	63528 01
0.647	0.70364	33589 34	0.57426	33656 48	0.697	0.77120	52574 75	0.60870	97025 88
0.648	0.70495	55824 80	0.57496	79600 51	0.698	0.77260	07661 95	0.60938	24209 28
0.649	0.70626	92726 76	0.57567	19116 38	0.699	0.77399	81757 30	0.61005	45081 01
0.650	0.70758	44367 25	0.57637	52205 91	0.700	0.77539	74966 11	0.61072	59643 89
	$\left[\begin{matrix} (-7)2 \\ 5 \end{matrix} \right]$		$\left[\begin{matrix} (-8)8 \\ 4 \end{matrix} \right]$			$\left[\begin{matrix} (-7)2 \\ 5 \end{matrix} \right]$		$\left[\begin{matrix} (-8)8 \\ 4 \end{matrix} \right]$	

$$\frac{\pi}{2} = 1.57079\ 63267\ 95$$

Table 4.14 INVERSE CIRCULAR SINES AND TANGENTS

x	arcsin x		arctan x		x	arcsin x		arctan x	
0.700	0.77539	74966 11	0.61072	59643 89	0.750	0.84806	20789 81	0.64350	11087 93
0.701	0.77679	87394 52	0.61139	67900 75	0.751	0.84957	52355 56	0.64414	08016 53
0.702	0.77820	19149 57	0.61206	69854 44	0.752	0.85109	10007 70	0.64477	98804 75
0.703	0.77960	70339 20	0.61273	65507 83	0.753	0.85260	93916 63	0.64541	83456 20
0.704	0.78101	41072 23	0.61340	54863 79	0.754	0.85413	04254 45	0.64605	61974 52
0.705	0.78242	31458 43	0.61407	37925 25	0.755	0.85565	41195 04	0.64669	34363 37
0.706	0.78383	41608 47	0.61474	14695 10	0.756	0.85718	04914 02	0.64733	00626 40
0.707	0.78524	71633 95	0.61540	85176 29	0.757	0.85870	95588 84	0.64796	60767 30
0.708	0.78666	21647 44	0.61607	49371 78	0.758	0.86024	13398 74	0.64860	14789 75
0.709	0.78807	91762 45	0.61674	07284 52	0.759	0.86177	58524 85	0.64923	62697 45
0.710	0.78949	82093 46	0.61740	58917 52	0.760	0.86331	31150 16	0.64987	04494 12
0.711	0.79091	92755 96	0.61807	04273 76	0.761	0.86485	31459 55	0.65050	40183 48
0.712	0.79234	23866 39	0.61873	43356 27	0.762	0.86639	59639 86	0.65113	69769 28
0.713	0.79376	75542 24	0.61939	76168 09	0.763	0.86794	15879 89	0.65176	93255 25
0.714	0.79519	47901 99	0.62006	02712 26	0.764	0.86949	00370 42	0.65240	10645 18
0.715	0.79662	41065 16	0.62072	22991 86	0.765	0.87104	13304 26	0.65303	21942 83
0.716	0.79805	55152 32	0.62138	37009 97	0.766	0.87259	54876 26	0.65366	27151 99
0.717	0.79948	90285 08	0.62204	44769 70	0.767	0.87415	25283 38	0.65429	26276 46
0.718	0.80092	46586 13	0.62270	46274 14	0.768	0.87571	24724 65	0.65492	19320 05
0.719	0.80236	24179 26	0.62336	41526 45	0.769	0.87727	53401 29	0.65555	06286 59
0.720	0.80380	23189 33	0.62402	30529 77	0.770	0.87884	11516 69	0.65617	87179 91
0.721	0.80524	43742 33	0.62468	13287 26	0.771	0.88040	99276 42	0.65680	62003 87
0.722	0.80668	85965 35	0.62533	89802 10	0.772	0.88198	16888 33	0.65743	30762 31
0.723	0.80813	49986 66	0.62599	60077 48	0.773	0.88355	64562 55	0.65805	93459 11
0.724	0.80958	35935 64	0.62665	24116 63	0.774	0.88513	42511 51	0.65868	50098 15
0.725	0.81103	43942 88	0.62730	81922 76	0.775	0.88671	50950 00	0.65931	00683 33
0.726	0.81248	74140 11	0.62796	33499 11	0.776	0.88829	90095 19	0.65993	45218 55
0.727	0.81394	26660 28	0.62861	78848 95	0.777	0.88988	60166 70	0.66055	83707 72
0.728	0.81540	01637 58	0.62927	17975 54	0.778	0.89147	61386 58	0.66118	16154 79
0.729	0.81685	99207 37	0.62992	50882 17	0.779	0.89306	93979 43	0.66180	42563 67
0.730	0.81832	19506 32	0.63057	77572 15	0.780	0.89466	58172 34	0.66242	62938 33
0.731	0.81978	62672 31	0.63122	98048 79	0.781	0.89626	54195 03	0.66304	77282 73
0.732	0.82125	28844 52	0.63188	12315 41	0.782	0.89786	82279 83	0.66366	85600 83
0.733	0.82272	18163 44	0.63253	20375 38	0.783	0.89947	42661 72	0.66428	87896 62
0.734	0.82419	30770 85	0.63318	22232 04	0.784	0.90108	35578 41	0.66490	84174 09
0.735	0.82566	66809 86	0.63383	17888 78	0.785	0.90269	61270 38	0.66552	74437 26
0.736	0.82714	26424 94	0.63448	07348 99	0.786	0.90431	19980 87	0.66614	58690 12
0.737	0.82862	09761 92	0.63512	90616 06	0.787	0.90593	11956 01	0.66676	36936 71
0.738	0.83010	16968 01	0.63577	67693 42	0.788	0.90755	37444 80	0.66738	09181 07
0.739	0.83158	48191 83	0.63642	38584 50	0.789	0.90917	96699 17	0.66799	75427 24
0.740	0.83307	03583 42	0.63707	03292 76	0.790	0.91080	89974 07	0.66861	35679 28
0.741	0.83455	83294 24	0.63771	61821 64	0.791	0.91244	17527 48	0.66922	89941 25
0.742	0.83604	87477 24	0.63836	14174 63	0.792	0.91407	79620 46	0.66984	38217 24
0.743	0.83754	16286 83	0.63900	60355 21	0.793	0.91571	76517 23	0.67045	80511 32
0.744	0.83903	69878 93	0.63965	00366 89	0.794	0.91736	08485 19	0.67107	16827 61
0.745	0.84053	48410 98	0.64029	34213 19	0.795	0.91900	75795 02	0.67168	47170 20
0.746	0.84203	52041 95	0.64093	61897 63	0.796	0.92065	78720 67	0.67229	71543 22
0.747	0.84353	80932 39	0.64157	83423 76	0.797	0.92231	17539 49	0.67290	89950 79
0.748	0.84504	35244 42	0.64221	98795 14	0.798	0.92396	92532 24	0.67352	02397 05
0.749	0.84655	15141 77	0.64286	08015 33	0.799	0.92563	03983 15	0.67413	08886 15
0.750	0.84806	20789 81	0.64350	11087 93	0.800	0.92729	52180 02	0.67474	09422 24
	$\left[\begin{matrix} (-7)3 \\ 5 \end{matrix} \right]$		$\left[\begin{matrix} (-8)8 \\ 4 \end{matrix} \right]$			$\left[\begin{matrix} (-7)5 \\ 5 \end{matrix} \right]$		$\left[\begin{matrix} (-8)8 \\ 4 \end{matrix} \right]$	

$$\frac{\pi}{2} = 1.57079\ 63267\ 95$$

INVERSE CIRCULAR SINES AND TANGENTS

Table 4.14

x	arcsin x		arctan x		x	arcsin x		arctan x	
0.800	0.92729	52180 02	0.67474	09422 24	0.850	1.01598	52938 15	0.70449	40642 42
0.801	0.92896	37414 22	0.67535	04009 49	0.851	1.01788	65272 25	0.70507	43293 58
0.802	0.93063	59980 83	0.67595	92652 08	0.852	1.01979	36361 62	0.70565	40219 63
0.803	0.93231	20178 64	0.67656	75354 19	0.853	1.02170	66824 41	0.70623	31425 16
0.804	0.93399	18310 25	0.67717	52120 01	0.854	1.02362	57289 29	0.70681	16914 73
0.805	0.93567	54682 12	0.67778	22953 77	0.855	1.02555	08395 76	0.70738	96692 96
0.806	0.93736	29604 66	0.67838	87859 65	0.856	1.02748	20794 40	0.70796	70764 42
0.807	0.93905	43392 28	0.67899	46841 90	0.857	1.02941	95147 10	0.70854	39133 73
0.808	0.94074	96363 49	0.67959	99904 74	0.858	1.03136	32127 41	0.70912	01805 50
0.809	0.94244	88840 95	0.68020	47052 41	0.859	1.03331	32420 77	0.70969	58784 34
0.810	0.94415	21151 54	0.68080	88289 16	0.860	1.03526	96724 81	0.71027	10074 87
0.811	0.94585	93626 48	0.68141	23619 25	0.861	1.03723	25749 68	0.71084	55681 72
0.812	0.94757	06601 38	0.68201	53046 96	0.862	1.03920	20218 39	0.71141	95609 52
0.813	0.94928	60416 29	0.68261	76576 55	0.863	1.04117	80867 05	0.71199	29862 92
0.814	0.95100	55415 87	0.68321	94212 31	0.864	1.04316	08445 30	0.71256	58446 55
0.815	0.95272	91949 40	0.68382	05958 54	0.865	1.04515	03716 61	0.71313	81365 07
0.816	0.95445	70370 88	0.68442	11819 54	0.866	1.04714	67458 63	0.71370	98623 14
0.817	0.95618	91039 18	0.68502	11799 62	0.867	1.04915	00463 62	0.71428	10225 41
0.818	0.95792	54318 04	0.68562	05903 10	0.868	1.05116	03538 76	0.71485	16176 56
0.819	0.95966	60576 23	0.68621	94134 31	0.869	1.05317	77506 61	0.71542	16481 25
0.820	0.96141	10187 64	0.68681	76497 59	0.870	1.05520	23205 49	0.71599	11144 16
0.821	0.96316	03531 36	0.68741	52997 28	0.871	1.05723	41489 91	0.71656	00169 99
0.822	0.96491	40991 79	0.68801	23637 73	0.872	1.05927	33231 01	0.71712	83563 41
0.823	0.96667	22958 76	0.68860	88423 31	0.873	1.06131	99317 03	0.71769	61329 12
0.824	0.96843	49827 60	0.68920	47358 39	0.874	1.0633	40653 78	0.71826	33471 82
0.825	0.97020	21999 29	0.68980	00447 34	0.875	1.06543	58165 11	0.71882	99996 22
0.826	0.97197	39880 56	0.69039	47694 55	0.876	1.06750	52793 43	0.71939	60907 02
0.827	0.97375	03884 00	0.69098	89104 41	0.877	1.06958	25500 24	0.71996	16208 94
0.828	0.97553	14428 17	0.69158	24681 33	0.878	1.07166	77266 67	0.72052	65906 70
0.829	0.97731	71937 77	0.69217	54429 71	0.879	1.07376	09094 07	0.72109	10005 03
0.830	0.97910	76843 68	0.69276	78353 97	0.880	1.07586	22004 54	0.72165	48508 65
0.831	0.98090	29583 19	0.69335	96458 54	0.881	1.07797	17041 59	0.72221	81422 30
0.832	0.98270	30600 05	0.69395	08747 85	0.882	1.08008	95270 75	0.72278	08750 71
0.833	0.98450	80344 64	0.69454	15226 33	0.883	1.08221	57780 22	0.72334	30498 64
0.834	0.98631	79274 13	0.69513	15898 44	0.884	1.08435	05681 59	0.72390	46670 83
0.835	0.98813	27852 56	0.69572	10768 63	0.885	1.08649	40110 49	0.72446	57272 04
0.836	0.98995	26551 06	0.69630	99841 36	0.886	1.08864	62227 36	0.72502	62307 01
0.837	0.99177	75847 95	0.69689	83121 11	0.887	1.09080	73218 22	0.72558	61780 53
0.838	0.99360	76228 94	0.69748	60612 34	0.888	1.09297	74295 43	0.72614	55697 34
0.839	0.99544	28187 22	0.69807	32319 55	0.889	1.09515	66698 56	0.72670	44062 23
0.840	0.99728	32223 72	0.69865	98247 21	0.890	1.09734	51695 23	0.72726	26879 97
0.841	0.99912	88847 18	0.69924	58399 85	0.891	1.09954	30581 99	0.72782	04155 34
0.842	1.00097	98574 39	0.69983	12781 94	0.892	1.10175	04685 30	0.72837	75893 12
0.843	1.00283	61930 35	0.70041	61398 02	0.893	1.10396	75362 43	0.72893	42098 11
0.844	1.00469	79448 46	0.70100	04252 59	0.894	1.10619	44002 56	0.72949	02775 09
0.845	1.00656	51670 67	0.70158	41350 19	0.895	1.10843	12027 75	0.73004	57928 87
0.846	1.00843	79147 75	0.70216	72695 35	0.896	1.11067	80894 12	0.73060	07564 24
0.847	1.01031	62439 41	0.70274	98292 60	0.897	1.11293	52092 94	0.73115	51686 02
0.848	1.01220	02114 56	0.70333	18146 49	0.898	1.11520	27151 85	0.73170	90299 00
0.849	1.01408	98751 50	0.70391	32261 58	0.899	1.11748	07636 13	0.73226	23408 01
0.850	1.01598	52938 15	0.70449	40642 42	0.900	1.11976	95149 99	0.73281	51017 87

$$\frac{\pi}{2} = 1.57079\ 63267\ 95$$

Table 4.14

INVERSE CIRCULAR SINES AND TANGENTS

x	arcsin x		arctan x		x	arcsin x		arctan x		$f(x)$
0.900	1.11976	95149 99	0.73281	51017 87	0.950	1.25323	58975 03	0.75976	27548 76	1.00421 42513 02
0.901	1.12206	91337 93	0.73336	73133 38	0.951	1.25645	42223 06	0.76028	81166 70	1.00412 90197 55
0.902	1.12437	97886 21	0.73391	89759 38	0.952	1.25970	47250 03	0.76081	29540 28	1.00404 38274 04
0.903	1.12670	16524 29	0.73447	00900 70	0.953	1.26298	84259 28	0.76133	72674 43	1.00395 86742 15
0.904	1.12903	49026 45	0.73502	06562 16	0.954	1.26630	64000 67	0.76186	10574 14	1.00387 35601 52
0.905	1.13137	97213 39	0.73557	06748 62	0.955	1.26965	97812 42	0.76238	43244 37	1.00378 84851 78
0.906	1.13373	62953 96	0.73612	01464 89	0.956	1.27304	97667 20	0.76290	70690 08	1.00370 34492 58
0.907	1.13610	48166 99	0.73666	90715 84	0.957	1.27647	76222 92	0.76342	92916 23	1.00361 84523 57
0.908	1.13848	54823 12	0.73721	74506 30	0.958	1.27994	46878 88	0.76395	09927 81	1.00353 34944 39
0.909	1.14087	84946 83	0.73776	52841 13	0.959	1.28345	23838 00	0.76447	21729 78	1.00344 85754 69
0.910	1.14328	40618 50	0.73831	25725 17	0.960	1.28700	22175 87	0.76499	28327 11	1.00336 36954 10
0.911	1.14570	23976 58	0.73885	93163 30	0.961	1.29059	57917 69	0.76551	29724 78	1.00327 88542 28
0.912	1.14813	37219 91	0.73940	55160 36	0.962	1.29423	48124 14	0.76603	25927 75	1.00319 40518 88
0.913	1.15057	82610 10	0.73995	11721 22	0.963	1.29792	10987 43	0.76655	16941 02	1.00310 92883 53
0.914	1.15303	62474 12	0.74049	62850 76	0.964	1.30165	65939 20	0.76707	02769 55	1.00302 45635 89
0.915	1.15550	79206 90	0.74104	08553 83	0.965	1.30544	33771 97	0.76758	83418 33	1.00293 98775 61
0.916	1.15799	35274 19	0.74158	48835 32	0.966	1.30928	36776 35	0.76810	58892 33	1.00285 52302 33
0.917	1.16049	33215 50	0.74212	83700 10	0.967	1.31317	98896 52	0.76862	29196 53	1.00277 06215 71
0.918	1.16300	75647 25	0.74267	13153 04	0.968	1.31713	45907 19	0.76913	94335 92	1.00268 60515 39
0.919	1.16553	65266 04	0.74321	37199 05	0.969	1.32115	05615 54	0.76965	54315 49	1.00260 15201 02
0.920	1.16808	04852 14	0.74375	55842 99	0.970	1.32523	08092 80	0.77017	09140 20	1.00251 70272 25
0.921	1.17063	97273 16	0.74429	69089 76	0.971	1.32937	85940 93	0.77068	58815 06	1.00243 25728 74
0.922	1.17321	45487 95	0.74483	76944 25	0.972	1.33359	74601 02	0.77120	03345 05	1.00234 81570 13
0.923	1.17580	52550 71	0.74537	79411 35	0.973	1.33789	12711 79	0.77171	42735 14	1.00226 37796 07
0.924	1.17841	21615 31	0.74591	76495 97	0.974	1.34226	42528 47	0.77222	76990 34	1.00217 94406 23
0.925	1.18103	55939 97	0.74645	68203 00	0.975	1.34672	10414 93	0.77274	06115 63	1.00209 51400 25
0.926	1.18367	58892 09	0.74699	54537 35	0.976	1.35126	67425 45	0.77325	30116 01	1.00201 08777 78
0.927	1.18633	33953 44	0.74753	35503 92	0.977	1.35590	69996 85	0.77376	48996 45	1.00192 66538 49
0.928	1.18900	84725 71	0.74807	11107 62	0.978	1.36064	80777 70	0.77427	62761 95	1.00184 24682 01
0.929	1.19170	14936 35	0.74860	81353 36	0.979	1.36549	69629 42	0.77478	71417 51	1.00175 83208 02
0.930	1.19441	28444 77	0.74914	46246 06	0.980	1.37046	14844 72	0.77529	74968 12	1.00167 42116 16
0.931	1.19714	29249 00	0.74968	05790 63	0.981	1.37555	04644 29	0.77580	73418 77	1.00159 01406 08
0.932	1.19989	21492 75	0.75021	59991 99	0.982	1.38077	39033 32	0.77631	66774 45	1.00150 61077 45
0.933	1.20266	09472 92	0.75075	08855 06	0.983	1.38614	32129 70	0.77682	55040 17	1.00142 21129 93
0.934	1.20544	97647 69	0.75128	52384 76	0.984	1.39167	15119 16	0.77733	38220 91	1.00133 81563 16
0.935	1.20825	90645 07	0.75181	90586 03	0.985	1.39737	40056 99	0.77784	16321 67	1.00125 42376 80
0.936	1.21108	93272 10	0.75235	23463 79	0.986	1.40326	84832 96	0.77834	89347 44	1.00117 03570 52
0.937	1.21394	10524 70	0.75288	51022 96	0.987	1.40937	59766 46	0.77885	57303 23	1.00108 65143 98
0.938	1.21681	47598 22	0.75341	73268 49	0.988	1.41572	16538 31	0.77936	20194 04	1.00100 27096 82
0.939	1.21971	09898 74	0.75394	90205 30	0.989	1.42233	60557 98	0.77986	78024 85	1.00091 89428 72
0.940	1.22263	03055 22	0.75448	01838 34	0.990	1.42925	68534 70	0.78037	30800 67	1.00083 52139 33
0.941	1.22557	32932 59	0.75501	08172 55	0.991	1.43653	14207 77	0.78087	78526 49	1.00075 15228 31
0.942	1.22854	05645 81	0.75554	09212 86	0.992	1.44422	07408 32	0.78138	21207 32	1.00066 78695 32
0.943	1.23153	27575 05	0.75607	04964 22	0.993	1.45240	56012 67	0.78188	58848 15	1.00058 42540 02
0.944	1.23455	05382 02	0.75659	95431 57	0.994	1.46119	69689 63	0.78238	91453 98	1.00050 06762 08
0.945	1.23759	46027 74	0.75712	80619 86	0.995	1.47075	46131 83	0.78289	19029 81	1.00041 71361 15
0.946	1.24066	56791 62	0.75765	60534 05	0.996	1.48132	37665 90	0.78339	41580 64	1.00033 36336 91
0.947	1.24376	45292 24	0.75818	35179 08	0.997	1.49331	72818 71	0.78389	59111 47	1.00025 01689 01
0.948	1.24689	19509 90	0.75871	04559 90	0.998	1.50754	02279 20	0.78439	71627 31	1.00016 67417 11
0.949	1.25004	87811 06	0.75923	68681 48	0.999	1.52607	12396 26	0.78489	79133 14	1.00008 33520 89
0.950	1.25323	58975 03	0.75976	27548 76	1.000	1.57079	63267 95	0.78539	81633 97	1.00000 00000 00

$$\begin{bmatrix} (-6)4 \\ 6 \end{bmatrix}$$

$$\begin{bmatrix} (-8)7 \\ 4 \end{bmatrix}$$

$$\begin{bmatrix} (-8)7 \\ 4 \end{bmatrix}$$

$$\begin{bmatrix} (-9)5 \\ 4 \end{bmatrix}$$

For arctan x , $x > 1$ see Example 22.

$$\arcsin x = \frac{\pi}{2} - [2(1-x)]^{\frac{1}{2}} f(x)$$

$$\frac{\pi}{2} = 1.57079 63267 95$$

HYPERBOLIC FUNCTIONS

Table 4.15

x	$\sinh x$	$\cosh x$	$\tanh x$	$\coth x$
0.00	0.00000 0000	1.00000 0000	0.00000 000	∞
0.01	0.01000 0167	1.00005 0000	0.00999 967	100.00333 33
0.02	0.02000 1333	1.00020 0007	0.01999 733	50.00666 65
0.03	0.03000 4500	1.00045 0034	0.02999 100	33.34333 27
0.04	0.04001 0668	1.00080 0107	0.03997 868	25.01333 19
0.05	0.05002 0836	1.00125 0260	0.04995 838	20.01666 39
0.06	0.06003 6006	1.00180 0540	0.05992 810	16.68666 19
0.07	0.07005 7181	1.00245 1001	0.06988 589	14.30904 00
0.08	0.08008 5361	1.00320 1707	0.07982 977	12.52665 53
0.09	0.09012 1549	1.00405 2734	0.08975 779	11.14109 49
0.10	0.10016 6750	1.00500 4168	0.09966 800	10.03331 11
0.11	0.11022 1968	1.00605 6103	0.10955 847	9.12754 62
0.12	0.12028 8207	1.00720 8644	0.11942 730	8.37329 50
0.13	0.13036 6476	1.00846 1907	0.12927 258	7.73559 23
0.14	0.14045 7782	1.00981 6017	0.13909 245	7.18946 29
0.15	0.15056 3133	1.01127 1110	0.14888 503	6.71659 18
0.16	0.16068 3541	1.01282 7330	0.15864 850	6.30324 25
0.17	0.17082 0017	1.01448 4834	0.16838 105	5.93891 07
0.18	0.18097 3576	1.01624 3787	0.17808 087	5.61542 64
0.19	0.19114 5232	1.01810 4366	0.18774 621	5.32633 93
0.20	0.20133 6003	1.02006 6756	0.19737 532	5.06648 96
0.21	0.21154 6907	1.02213 1153	0.20696 650	4.83169 98
0.22	0.22177 8966	1.02429 7764	0.21651 806	4.61855 23
0.23	0.23203 3204	1.02656 6806	0.22602 835	4.42422 37
0.24	0.24231 0645	1.02893 8506	0.23549 575	4.24636 11
0.25	0.25261 2317	1.03141 3100	0.24491 866	4.08298 82
0.26	0.26293 9250	1.03399 0836	0.25429 553	3.93243 24
0.27	0.27329 2478	1.03667 1973	0.26362 484	3.79326 93
0.28	0.28367 3035	1.03945 6777	0.27290 508	3.66427 77
0.29	0.29408 1960	1.04234 5528	0.28213 481	3.54440 49
0.30	0.30452 0293	1.04533 8514	0.29131 261	3.43273 84
0.31	0.31498 9079	1.04843 6035	0.30043 710	3.32848 38
0.32	0.32548 9364	1.05163 8401	0.30950 692	3.23094 55
0.33	0.33602 2198	1.05494 5931	0.31852 078	3.13951 26
0.34	0.34658 8634	1.05835 8957	0.32747 740	3.05364 59
0.35	0.35718 9729	1.06187 7819	0.33637 554	2.97286 77
0.36	0.36782 6544	1.06550 2870	0.34521 403	2.89675 36
0.37	0.37850 0142	1.06923 4473	0.35399 171	2.82492 49
0.38	0.38921 1590	1.07307 2999	0.36270 747	2.75704 28
0.39	0.39996 1960	1.07701 8834	0.37136 023	2.69280 32
0.40	0.41075 2326	1.08107 2372	0.37994 896	2.63193 24
0.41	0.42158 3767	1.08523 4018	0.38847 268	2.57418 36
0.42	0.43245 7368	1.08950 4188	0.39693 043	2.51933 32
0.43	0.44337 4214	1.09388 3309	0.40532 131	2.46717 85
0.44	0.45433 5399	1.09837 1820	0.41364 444	2.41753 52
0.45	0.46534 2017	1.10297 0169	0.42189 901	2.37023 55
0.46	0.47639 5170	1.10767 8815	0.43008 421	2.32512 60
0.47	0.48749 5962	1.11249 8231	0.43819 932	2.28206 66
0.48	0.49864 5505	1.11742 8897	0.44624 361	2.24092 84
0.49	0.50984 4913	1.12247 1307	0.45421 643	2.20159 36
0.50	0.52109 5305	1.12762 5965	0.46211 716	2.16395 34

For $\coth x$, $x \leq .1$ use 4.5.67.

Compilation of $\tanh x$ and $\coth x$ from National Bureau of Standards, Table of circular and hyperbolic tangents and cotangents for radian arguments, 2d printing. Columbia Univ. Press, New York, N.Y., 1947 (with permission).

Table 4.15

HYPERBOLIC FUNCTIONS

x	$\sinh x$	$\cosh x$	$\tanh x$	$\coth x$
0.50	0.52109 5305	1.12762 5965	0.46211 716	2.16395 34
0.51	0.53239 7808	1.13289 3387	0.46994 520	2.12790 77
0.52	0.54375 3551	1.13827 4099	0.47770 001	2.09336 40
0.53	0.55516 3669	1.14376 8639	0.48538 109	2.06023 68
0.54	0.56662 9305	1.14937 7557	0.49298 797	2.02844 71
0.55	0.57815 1604	1.15510 1414	0.50052 021	1.99792 13
0.56	0.58973 1718	1.16094 0782	0.50797 743	1.96859 14
0.57	0.60137 0806	1.16689 6245	0.51535 928	1.94039 39
0.58	0.61307 0032	1.17296 8399	0.52266 543	1.91326 98
0.59	0.62483 0565	1.17915 7850	0.52989 561	1.88716 42
0.60	0.63665 3582	1.18546 5218	0.53704 957	1.86202 55
0.61	0.64854 0265	1.19189 1134	0.54412 710	1.83780 59
0.62	0.66049 1802	1.19843 6240	0.55112 803	1.81446 04
0.63	0.67250 9389	1.20510 1190	0.55805 222	1.79194 70
0.64	0.68459 4228	1.21188 6652	0.56489 955	1.77022 62
0.65	0.69674 7526	1.21879 3303	0.57166 997	1.74926 10
0.66	0.70897 0500	1.22582 1834	0.57836 341	1.72901 67
0.67	0.72126 4371	1.23297 2949	0.58497 988	1.70946 05
0.68	0.73363 0370	1.24024 7362	0.59151 940	1.69056 16
0.69	0.74606 9732	1.24764 5801	0.59798 200	1.67229 11
0.70	0.75858 3702	1.25516 9006	0.60436 778	1.65462 16
0.71	0.77117 3531	1.26281 7728	0.61067 683	1.63752 73
0.72	0.78384 0477	1.27059 2733	0.61690 930	1.62098 38
0.73	0.79658 5809	1.27849 4799	0.62306 535	1.60496 81
0.74	0.80941 0799	1.28652 4715	0.62914 516	1.58945 83
0.75	0.82231 6732	1.29468 3285	0.63514 895	1.57443 38
0.76	0.83530 4897	1.30297 1324	0.64107 696	1.55987 51
0.77	0.84837 6593	1.31138 9661	0.64692 945	1.54576 36
0.78	0.86153 3127	1.31993 9138	0.65270 671	1.53208 17
0.79	0.87477 5815	1.32862 0611	0.65840 904	1.51881 27
0.80	0.88810 5982	1.33743 4946	0.66403 677	1.50594 07
0.81	0.90152 4960	1.34638 3026	0.66959 026	1.49345 06
0.82	0.91503 4092	1.35546 5746	0.67506 987	1.48132 81
0.83	0.92863 4727	1.36468 4013	0.68047 601	1.46955 95
0.84	0.94232 8227	1.37403 8750	0.68580 906	1.45813 18
0.85	0.95611 5960	1.38353 0892	0.69106 947	1.44703 25
0.86	0.96999 9306	1.39316 1388	0.69625 767	1.43624 99
0.87	0.98397 9652	1.40293 1201	0.70137 413	1.42577 26
0.88	0.99805 8397	1.41284 1309	0.70641 932	1.41558 98
0.89	1.01223 6949	1.42289 2702	0.71139 373	1.40569 13
0.90	1.02651 6726	1.43308 6385	0.71629 787	1.39606 73
0.91	1.04089 9155	1.44342 3379	0.72113 225	1.38670 82
0.92	1.05538 5674	1.45390 4716	0.72589 742	1.37760 51
0.93	1.06997 7734	1.46453 1444	0.73059 390	1.36874 95
0.94	1.08467 6791	1.47530 4627	0.73522 225	1.36013 29
0.95	1.09948 4318	1.48622 5341	0.73978 305	1.35174 76
0.96	1.11440 1794	1.49729 4680	0.74427 687	1.34358 60
0.97	1.12943 0711	1.50851 3749	0.74870 429	1.33564 08
0.98	1.14457 2572	1.51988 3670	0.75306 591	1.32790 50
0.99	1.15982 8891	1.53140 5582	0.75736 232	1.32037 20
1.00	1.17520 1194 $\left[\begin{smallmatrix} (-5)1 \\ 4 \end{smallmatrix} \right]$	1.54308 0635 $\left[\begin{smallmatrix} (-5)2 \\ 4 \end{smallmatrix} \right]$	0.76159 416 $\left[\begin{smallmatrix} (-6)9 \\ 4 \end{smallmatrix} \right]$	1.31303 53 $\left[\begin{smallmatrix} (-4)2 \\ 5 \end{smallmatrix} \right]$

HYPERBOLIC FUNCTIONS

Table 4.15

x	$\sinh x$	$\cosh x$	$\tanh x$	$\coth x$
1.00	1.17520 1194	1.54308 0635	0.76159 416	1.31303 53
1.01	1.19069 1018	1.55490 9997	0.76576 202	1.30588 87
1.02	1.20629 9912	1.56689 4852	0.76986 654	1.29892 64
1.03	1.22202 9437	1.57903 6398	0.77390 834	1.29214 27
1.04	1.23788 1166	1.59133 5848	0.77788 807	1.28553 20
1.05	1.25385 6684	1.60379 4434	0.78180 636	1.27908 91
1.06	1.26995 7589	1.61641 3400	0.78566 386	1.27280 90
1.07	1.28618 5491	1.62919 4009	0.78946 122	1.26668 67
1.08	1.30254 2013	1.64213 7538	0.79319 910	1.26071 75
1.09	1.31902 8789	1.65524 5283	0.79687 814	1.25489 70
1.10	1.33564 7470	1.66851 8554	0.80049 902	1.24922 08
1.11	1.35239 9717	1.68195 8678	0.80406 239	1.24368 46
1.12	1.36928 7204	1.69556 6999	0.80756 892	1.23828 44
1.13	1.38631 1622	1.70934 4878	0.81101 926	1.23301 63
1.14	1.40347 4672	1.72329 3694	0.81441 409	1.22787 66
1.15	1.42077 8070	1.73741 4840	0.81775 408	1.22286 15
1.16	1.43822 3548	1.75170 9728	0.82103 988	1.21796 76
1.17	1.45581 2849	1.76617 9790	0.82427 217	1.21319 15
1.18	1.47354 7732	1.78082 6471	0.82745 161	1.20852 99
1.19	1.49142 9972	1.79565 1236	0.83057 887	1.20397 96
1.20	1.50946 1355	1.81065 5567	0.83365 461	1.19953 75
1.21	1.52764 3687	1.82584 0966	0.83667 949	1.19520 08
1.22	1.54597 8783	1.84120 8950	0.83965 418	1.19096 65
1.23	1.56446 8479	1.85676 1057	0.84257 933	1.18683 19
1.24	1.58311 4623	1.87249 8841	0.84545 560	1.18279 42
1.25	1.60191 9080	1.88842 3877	0.84828 364	1.17885 10
1.26	1.62088 3730	1.90453 7757	0.85106 411	1.17499 96
1.27	1.64001 0470	1.92084 2092	0.85379 765	1.17123 77
1.28	1.65930 1213	1.93733 8513	0.85648 492	1.16756 29
1.29	1.67875 7886	1.95402 8669	0.85912 654	1.16397 29
1.30	1.69838 2437	1.97091 4230	0.86172 316	1.16046 55
1.31	1.71817 6828	1.98799 6884	0.86427 541	1.15703 86
1.32	1.73814 3038	2.00527 8340	0.86678 393	1.15369 01
1.33	1.75828 3063	2.02276 0324	0.86924 933	1.15041 79
1.34	1.77859 8918	2.04044 4587	0.87167 225	1.14722 02
1.35	1.79909 2635	2.05833 2896	0.87405 329	1.14409 50
1.36	1.81976 6262	2.07642 7039	0.87639 307	1.14104 05
1.37	1.84062 1868	2.09472 8828	0.87869 219	1.13805 50
1.38	1.86166 1537	2.11324 0090	0.88095 127	1.13513 66
1.39	1.88288 7374	2.13196 2679	0.88317 089	1.13228 37
1.40	1.90430 1501	2.15089 8465	0.88535 165	1.12949 47
1.41	1.92590 6060	2.17004 9344	0.88749 413	1.12676 80
1.42	1.94770 3212	2.18941 7229	0.88959 892	1.12410 21
1.43	1.96969 5135	2.20900 4057	0.89166 660	1.12149 54
1.44	1.99188 4029	2.22881 1788	0.89369 773	1.11894 66
1.45	2.01427 2114	2.24884 2402	0.89569 287	1.11645 41
1.46	2.03686 1627	2.26909 7902	0.89765 260	1.11401 67
1.47	2.05965 4828	2.28958 0313	0.89957 745	1.11163 30
1.48	2.08265 3996	2.31029 1685	0.90146 799	1.10930 17
1.49	2.10586 1432	2.33123 4087	0.90332 474	1.10702 16
1.50	2.12927 9455	2.35240 9615	0.90514 825	1.10479 14
	$\left[\begin{smallmatrix} (-5)3 \\ 4 \end{smallmatrix} \right]$	$\left[\begin{smallmatrix} (-5)3 \\ 5 \end{smallmatrix} \right]$	$\left[\begin{smallmatrix} (-6)8 \\ 4 \end{smallmatrix} \right]$	$\left[\begin{smallmatrix} (-5)2 \\ 4 \end{smallmatrix} \right]$

Table 4.15

HYPERBOLIC FUNCTIONS

x	$\sinh x$	$\cosh x$	$\tanh x$	$\coth x$
1.50	2.12927 9455	2.35240 9615	0.90514 825	1.10479 14
1.51	2.15291 0408	2.37382 0386	0.90693 905	1.10260 99
1.52	2.17675 6654	2.39546 8541	0.90869 766	1.10047 60
1.53	2.20082 0577	2.41735 6245	0.91042 459	1.09838 86
1.54	2.22510 4585	2.43948 5686	0.91212 037	1.09634 65
1.55	2.24961 1104	2.46185 9078	0.91378 549	1.09434 87
1.56	2.27434 2587	2.48447 8658	0.91542 046	1.09239 42
1.57	2.29930 1506	2.50734 6688	0.91702 576	1.09048 19
1.58	2.32449 0357	2.53046 5455	0.91860 189	1.08861 09
1.59	2.34991 1658	2.55383 7270	0.92014 933	1.08678 01
1.60	2.37556 7953	2.57746 4471	0.92166 855	1.08498 87
1.61	2.40146 1807	2.60134 9421	0.92316 003	1.08323 58
1.62	2.42759 5809	2.62549 4508	0.92462 422	1.08152 04
1.63	2.45397 2572	2.64990 2146	0.92606 158	1.07984 18
1.64	2.48059 4735	2.67457 4777	0.92747 257	1.07819 90
1.65	2.50746 4959	2.69951 4868	0.92885 762	1.07659 13
1.66	2.53458 5932	2.72472 4912	0.93021 718	1.07501 78
1.67	2.56196 0366	2.75020 7431	0.93155 168	1.07347 77
1.68	2.58959 0998	2.77596 4974	0.93286 155	1.07197 04
1.69	2.61748 0591	2.80200 0115	0.93414 721	1.07049 51
1.70	2.64563 1934	2.82831 5458	0.93540 907	1.06905 10
1.71	2.67404 7843	2.85491 3635	0.93664 754	1.06763 75
1.72	2.70273 1158	2.88179 7306	0.93786 303	1.06625 38
1.73	2.73168 4749	2.90896 9159	0.93905 593	1.06489 93
1.74	2.76091 1511	2.93643 1912	0.94022 664	1.06357 34
1.75	2.79041 4366	2.96418 8310	0.94137 554	1.06227 53
1.76	2.82019 6265	2.99224 1129	0.94250 301	1.06100 46
1.77	2.85026 0186	3.02059 3175	0.94360 942	1.05976 05
1.78	2.88060 9136	3.04924 7283	0.94469 516	1.05854 25
1.79	2.91124 6148	3.07820 6318	0.94576 057	1.05735 01
1.80	2.94217 4288	3.10747 3176	0.94680 601	1.05618 26
1.81	2.97339 6648	3.13705 0785	0.94783 185	1.05503 95
1.82	3.00491 6349	3.16694 2100	0.94883 842	1.05392 02
1.83	3.03673 6545	3.19715 0113	0.94982 608	1.05282 43
1.84	3.06886 0417	3.22767 7844	0.95079 514	1.05175 13
1.85	3.10129 1178	3.25852 8344	0.95174 596	1.05070 05
1.86	3.13403 2071	3.28970 4701	0.95267 884	1.04967 17
1.87	3.16708 6369	3.32121 0031	0.95359 412	1.04866 42
1.88	3.20045 7378	3.35304 7484	0.95449 211	1.04767 76
1.89	3.23414 8436	3.38522 0245	0.95537 312	1.04671 15
1.90	3.26816 2912	3.41773 1531	0.95623 746	1.04576 53
1.91	3.30250 4206	3.45058 4593	0.95708 542	1.04483 88
1.92	3.33717 5754	3.48378 2716	0.95791 731	1.04393 14
1.93	3.37218 1022	3.51732 9220	0.95873 341	1.04304 28
1.94	3.40752 3510	3.55122 7460	0.95953 401	1.04217 25
1.95	3.44320 6754	3.58548 0826	0.96031 939	1.04132 02
1.96	3.47923 4322	3.62009 2743	0.96108 983	1.04048 55
1.97	3.51560 9816	3.65506 6672	0.96184 561	1.03966 79
1.98	3.55233 6874	3.69040 6111	0.96258 698	1.03886 72
1.99	3.58941 9168	3.72611 4594	0.96331 422	1.03808 29
2.00	3.62686 0408	3.76219 5691	0.96402 758	1.03731 47
	$\left[\begin{smallmatrix} (-5)4 \\ 5 \end{smallmatrix} \right]$	$\left[\begin{smallmatrix} (-5)5 \\ 5 \end{smallmatrix} \right]$	$\left[\begin{smallmatrix} (-6)4 \\ 4 \end{smallmatrix} \right]$	$\left[\begin{smallmatrix} (-6)6 \\ 3 \end{smallmatrix} \right]$

HYPERBOLIC FUNCTIONS

Table 4.15

x	$\sinh x$	$\cosh x$	$\tanh x$	$\coth x$
2.0	3.62686 0408	3.76219 5691	0.96402 75801	1.03731 47207
2.1	4.02185 6742	4.14431 3170	0.97045 19366	1.03044 77350
2.2	4.45710 5171	4.56790 8329	0.97574 31300	1.02485 98932
2.3	4.93696 1806	5.03722 0649	0.98009 63963	1.02030 78022
2.4	5.46622 9214	5.55694 7167	0.98367 48577	1.01659 60756
2.5	6.05020 4481	6.13228 9480	0.98661 42982	1.01356 73098
2.6	6.69473 2228	6.76900 5807	0.98902 74022	1.01109 43314
2.7	7.40626 3106	7.47346 8619	0.99100 74537	1.00907 41460
2.8	8.19191 8354	8.25272 8417	0.99263 15202	1.00742 31773
2.9	9.05956 1075	9.11458 4295	0.99396 31674	1.00607 34973
3.0	10.01787 4927	10.06766 1996	0.99505 47537	1.00496 98233
3.1	11.07645 1040	11.12150 0242	0.99594 93592	1.00406 71152
3.2	12.24588 3997	12.28664 6201	0.99668 23978	1.00332 86453
3.3	13.53787 7877	13.57476 1044	0.99728 29601	1.00272 44423
3.4	14.96536 3389	14.99873 6659	0.99777 49279	1.00223 00341
3.5	16.54262 7288	16.57282 4671	0.99817 78976	1.00182 54285
3.6	18.28545 5361	18.31277 9083	0.99850 79423	1.00149 42872
3.7	20.21129 0417	20.23601 3943	0.99877 82413	1.00122 32532
3.8	22.33940 6861	22.36177 7633	0.99899 95978	1.00100 14040
3.9	24.69110 3597	24.71134 5508	0.99918 08657	1.00081 98059
4.0	27.28991 7197	27.30823 2836	0.99932 92997	1.00067 11504
4.1	30.16185 7461	30.17843 0136	0.99945 08437	1.00054 94581
4.2	33.33566 7732	33.35066 3309	0.99955 03665	1.00044 98358
4.3	36.84311 2570	36.85668 1129	0.99963 18562	1.00036 82794
4.4	40.71929 5663	40.73157 3002	0.99969 85793	1.00030 15116
4.5	45.00301 1152	45.01412 0149	0.99975 32108	1.00024 68501
4.6	49.73713 1903	49.74718 3739	0.99979 79416	1.00020 20992
4.7	54.96903 8588	54.97813 3865	0.99983 45656	1.00016 54618
4.8	60.75109 3886	60.75932 3633	0.99986 45517	1.00013 54666
4.9	67.14116 6551	67.14861 3134	0.99988 91030	1.00011 09093
5.0	74.20321 0578	74.20994 8525	0.99990 92043	1.00009 08040
5.1	82.00790 5277	82.01400 2023	0.99992 56621	1.00007 43434
5.2	90.63336 2655	90.63887 9220	0.99993 91369	1.00006 08668
5.3	100.16590 9190	100.17090 0784	0.99995 01692	1.00004 98333
5.4	110.70094 9812	110.70546 6393	0.99995 92018	1.00004 07998
5.5	122.34392 2746	122.34800 9518	0.99996 65972	1.00003 34040
5.6	135.21135 4781	135.21505 2645	0.99997 26520	1.00002 73488
5.7	149.43202 7501	149.43537 3466	0.99997 76093	1.00002 23912
5.8	165.14826 6177	165.15129 3732	0.99998 16680	1.00001 83323
5.9	182.51736 4210	182.52010 3655	0.99998 49910	1.00001 50092
6.0	201.71315 7370	201.71563 6122	0.99998 77117	1.00001 22885
			$\left[\begin{matrix} (-4)1 \\ 6 \end{matrix} \right]$	$\left[\begin{matrix} (-4)2 \\ 9 \end{matrix} \right]$

Table 4.15

HYPERBOLIC FUNCTIONS

x	$\sinh x$		$\cosh x$		$\tanh x$		$\coth x$	
6.0	201.71315	7370	201.71563	6122	0.99998	77117	1.00001	22885
6.1	222.92776	3607	222.93000	6475	0.99998	99391	1.00001	00610
6.2	246.37350	5831	246.37553	5262	0.99999	17629	1.00000	82372
6.3	272.28503	6911	272.28687	3215	0.99999	32560	1.00000	67441
6.4	300.92168	8157	300.92334	9715	0.99999	44785	1.00000	55216
6.5	332.57006	4803	332.57156	8242	0.99999	54794	1.00000	45207
6.6	367.54691	4437	367.54827	4805	0.99999	62988	1.00000	37012
6.7	406.20229	7128	406.20352	8040	0.99999	69697	1.00000	30303
6.8	448.92308	8938	448.92420	2713	0.99999	75190	1.00000	24810
6.9	496.13685	3910	496.13786	1695	0.99999	79687	1.00000	20313
7.0	548.31612	3273	548.31703	5155	0.99999	83369	1.00000	16631
7.1	605.98312	4694	605.98394	9799	0.99999	86384	1.00000	13616
7.2	669.71500	8904	669.71575	5490	0.99999	88852	1.00000	11148
7.3	740.14962	6023	740.15030	1562	0.99999	90873	1.00000	09127
7.4	817.99190	9372	817.99252	0624	0.99999	92527	1.00000	07473
7.5	904.02093	0686	904.02148	3770	0.99999	93882	1.00000	06118
7.6	999.09769	7326	999.09819	7778	0.99999	94991	1.00000	05009
7.7	1104.17376	9530	1104.17422	2357	0.99999	95899	1.00000	04101
7.8	1220.30078	3945	1220.30119	3680	0.99999	96642	1.00000	03358
7.9	1348.64097	8762	1348.64134	9506	0.99999	97251	1.00000	02749
8.0	1490.47882	5790	1490.47916	1252	0.99999	97749	1.00000	02251
8.1	1647.23388	5872	1647.23418	9411	0.99999	98157	1.00000	01843
8.2	1820.47501	6339	1820.47529	0993	0.99999	98491	1.00000	01509
8.3	2011.93607	2653	2011.93632	1170	0.99999	98765	1.00000	01235
8.4	2223.53326	1416	2223.53348	6284	0.99999	98989	1.00000	01011
8.5	2457.38431	8415	2457.38452	1884	0.99999	99172	1.00000	00828
8.6	2715.82970	3629	2715.82988	7734	0.99999	99322	1.00000	00678
8.7	3001.45602	5338	3001.45619	1923	0.99999	99445	1.00000	00555
8.8	3317.12192	7772	3317.12207	8505	0.99999	99546	1.00000	00454
8.9	3665.98670	1384	3665.98683	7772	0.99999	99628	1.00000	00372
9.0	4051.54190	2083	4051.54202	5493	0.99999	99695	1.00000	00305
9.1	4477.64629	5908	4477.64640	7574	0.99999	99751	1.00000	00249
9.2	4948.56447	8852	4948.56457	9892	0.99999	99796	1.00000	00204
9.3	5469.00955	8370	5469.00964	9795	0.99999	99833	1.00000	00167
9.4	6044.19032	3746	6044.19040	6471	0.99999	99863	1.00000	00137
9.5	6679.86337	7405	6679.86345	2257	0.99999	99888	1.00000	00112
9.6	7382.39074	8924	7382.39081	6653	0.99999	99908	1.00000	00092
9.7	8158.80356	8366	8158.80362	9649	0.99999	99925	1.00000	00075
9.8	9016.87243	6188	9016.87249	1640	0.99999	99939	1.00000	00061
9.9	9965.18519	4028	9965.18524	4202	0.99999	99950	1.00000	00050
10.0	11013.23287	4703	11013.23292	0103	0.99999	99959	1.00000	00041
					*	$\left[\begin{smallmatrix} (-8)5 \\ 5 \end{smallmatrix} \right]$		$\left[\begin{smallmatrix} (-8)7 \\ 5 \end{smallmatrix} \right]$

For $x \gg 0$, $\sinh x \sim \cosh x \sim \frac{1}{2} e^x$. For $x > 10$, $\tanh x \sim 1 - 2e^{-2x}$, $\coth x \sim 1 + 2e^{-2x}$ to 10D.

*See page II.

EXPONENTIAL AND HYPERBOLIC FUNCTIONS FOR THE ARGUMENT πx

Table 4.16

x	$e^{\pi x}$	$e^{-\pi x}$	$\sinh \pi x$	$\cosh \pi x$	$\tanh \pi x$
0.00	1.00000 00000	1.00000 00000	0.00000 00000	1.00000 00000	0.00000 00000
0.01	1.03191 46153	0.96907 24263	0.03142 10945	1.00049 35208	0.03140 55952
0.02	1.06484 77733	0.93910 13674	0.06287 32029	1.00197 45704	0.06274 93000
0.03	1.09883 19803	0.91005 72407	0.09438 73698	1.00444 46105	0.09396 97111
0.04	1.13390 07803	0.88191 13783	0.12599 47010	1.00790 60793	0.12500 63906
0.05	1.17008 87875	0.85463 59992	0.15772 63942	1.01236 23933	0.15580 03292
0.06	1.20743 17210	0.82820 41813	0.18961 37699	1.01781 79512	0.18629 43856
0.07	1.24596 64399	0.80258 98355	0.22168 83022	1.02427 81377	0.21643 36952
0.08	1.28573 09795	0.77776 76792	0.25398 16502	1.03174 93294	0.24616 60434
0.09	1.32676 45892	0.75371 32120	0.28652 56886	1.04023 89006	0.27544 21974
0.10	1.36910 77706	0.73040 26910	0.31935 25398	1.04975 52308	0.30421 61929
0.11	1.41280 23184	0.70781 31080	0.35249 46052	1.06030 77132	0.33244 55730
0.12	1.45789 13610	0.68592 21659	0.38598 45975	1.07190 67634	0.36009 15776
0.13	1.50441 94029	0.66470 82576	0.41985 55727	1.08456 38303	0.38711 92833
0.14	1.55243 23694	0.64415 04440	0.45414 09627	1.09829 14067	0.41349 76928
0.15	1.60197 76513	0.62422 84336	0.48887 46088	1.11310 30425	0.43919 97777
0.16	1.65310 41518	0.60492 25628	0.52409 07945	1.12901 33573	0.46420 24748
0.17	1.70586 23348	0.58621 37756	0.55982 42796	1.14603 80552	0.48848 66406
0.18	1.76030 42750	0.56808 36059	0.59611 03346	1.16419 39405	0.51203 69673
0.19	1.81648 37088	0.55051 41583	0.63298 47753	1.18349 89335	0.53484 18637
0.20	1.87445 60876	0.53348 80911	0.67048 39982	1.20397 20893	0.55689 33069
0.21	1.93427 86325	0.51698 85988	0.70864 50169	1.22563 36157	0.57818 66683
0.22	1.99601 03910	0.50099 93958	0.74750 54976	1.24850 48934	0.59872 05188
0.23	2.05971 22948	0.48550 47001	0.78710 37973	1.27260 84975	0.61849 64181
0.24	2.12544 72203	0.47048 92177	0.82747 90013	1.29796 82190	0.63751 86920
0.25	2.19328 00507	0.45593 81278	0.86867 09615	1.32460 90893	0.65579 42026
0.26	2.26327 77398	0.44183 70677	0.91072 03361	1.35255 74038	0.67333 21140
0.27	2.33550 93782	0.42817 21192	0.95366 86295	1.38184 07487	0.69014 36583
0.28	2.41004 62616	0.41492 97945	0.99755 82336	1.41248 80280	0.70624 19035
0.29	2.48696 19609	0.40209 70227	1.04243 24691	1.44452 94918	0.72164 15276
0.30	2.56633 23952	0.38966 11374	1.08833 56289	1.47799 67663	0.73635 85995
0.31	2.64823 59064	0.37760 98638	1.13531 30213	1.51292 28851	0.75041 03695
0.32	2.73275 33366	0.36593 13069	1.18341 10148	1.54934 23218	0.76381 50706
0.33	2.81996 81081	0.35461 39395	1.23267 70843	1.58729 10238	0.77659 17313
0.34	2.90996 63054	0.34364 65907	1.28315 98573	1.62680 64481	0.78876 00021
0.35	3.00283 67606	0.33301 84355	1.33490 91626	1.66792 75980	0.80033 99933
0.36	3.09867 11407	0.32271 89833	1.38797 60787	1.71069 50620	0.81135 21279
0.37	3.19756 40381	0.31273 80681	1.44241 29850	1.75515 10531	0.82181 70068
0.38	3.29961 30643	0.30306 58385	1.49827 36129	1.80133 94514	0.83175 52873
0.39	3.40491 89460	0.29369 27474	1.55561 30993	1.84930 58467	0.84118 75743
0.40	3.51358 56243	0.28460 95433	1.61448 80405	1.89909 75838	0.85013 43239
0.41	3.62572 03579	0.27580 72607	1.67495 65486	1.95076 38093	0.85861 57589
0.42	3.74143 38283	0.26727 72113	1.73707 83085	2.00435 55198	0.86665 17947
0.43	3.86084 02496	0.25901 09757	1.80091 46370	2.05992 56127	0.87426 19762
0.44	3.98405 74810	0.25100 03946	1.86652 85432	2.11752 89378	0.88146 54241
0.45	4.11120 71429	0.24323 75614	1.93398 47907	2.17722 23522	0.88828 07899
0.46	4.24241 47373	0.23571 48138	2.00334 99617	2.23906 47756	0.89472 62194
0.47	4.37780 97717	0.22842 47266	2.07469 25226	2.30311 72491	0.90081 93236
0.48	4.51752 58864	0.22136 01040	2.14808 28912	2.36944 29952	0.90657 71557
0.49	4.66170 09873	0.21451 39731	2.22359 35071	2.43810 74802	0.91201 61950
0.50	4.81047 73810	0.20787 95764	2.30129 89023	2.50917 84787	0.91715 23357
	$\left[\begin{smallmatrix} (-4)6 \\ 6 \end{smallmatrix} \right]$	$\left[\begin{smallmatrix} (-4)1 \\ 6 \end{smallmatrix} \right]$	$\left[\begin{smallmatrix} (-4)3 \\ 6 \end{smallmatrix} \right]$	$\left[\begin{smallmatrix} (-4)3 \\ 6 \end{smallmatrix} \right]$	$\left[\begin{smallmatrix} (-5)9 \\ 7 \end{smallmatrix} \right]$

Compiled from British Association for the Advancement of Science, Mathematical Tables, vol. I. Circular and hyperbolic functions, exponential, sine and cosine integrals, factorial function and allied functions, Hermitian probability functions, 3d ed. Cambridge Univ. Press, Cambridge, England, 1951 (with permission). Known errors have been corrected.

Table 4.16 EXPONENTIAL AND HYPERBOLIC FUNCTIONS FOR THE ARGUMENT πx

x	$e^{\pi x}$	$e^{-\pi x}$	$\sinh \pi x$	$\cosh \pi x$	$\tanh \pi x$
0.50	4.81047 73810	0.20787 95764	2.30129 89023	2.50917 84787	0.91715 23357
0.51	4.96400 19160	0.20145 03654	2.38127 57753	2.58272 61407	0.92200 08803
0.52	5.12242 61276	0.19521 99944	2.46360 30666	2.65882 30610	0.92657 65378
0.53	5.28590 63869	0.18918 23136	2.54836 20366	2.73754 43503	0.93089 34251
0.54	5.45460 40558	0.18333 13637	2.63563 63461	2.81896 77098	0.93496 50714
0.55	5.62868 56460	0.17766 13694	2.72551 21383	2.90317 35077	0.93880 44259
0.56	5.80832 29831	0.17216 67343	2.81807 81244	2.99024 48587	0.94242 38675
0.57	5.99369 33767	0.16684 20350	2.91342 56709	3.08026 77058	0.94583 52160
0.58	6.18497 97951	0.16168 20156	3.01164 88897	3.17333 09054	0.94904 97460
0.59	6.38237 10460	0.15668 15832	3.11284 47314	3.26952 63146	0.95207 82009
0.60	6.58606 19627	0.15183 58020	3.21711 30804	3.36894 88823	0.95493 08086
0.61	6.79625 35967	0.14713 98890	3.32455 68538	3.47169 67428	0.95761 72978
0.62	7.01315 34158	0.14258 92093	3.43528 21032	3.57787 13125	0.96014 69151
0.63	7.23697 55091	0.13817 92710	3.54939 81191	3.68757 73901	0.96252 84417
0.64	7.46794 07985	0.13390 57214	3.66701 75386	3.80092 32600	0.96477 02118
0.65	7.70627 72563	0.12976 43423	3.78825 64570	3.91802 07993	0.96688 01293
0.66	7.95222 01304	0.12575 10461	3.91323 45422	4.03898 55883	0.96886 56859
0.67	8.20601 21768	0.12186 18713	4.04207 51527	4.16393 70240	0.97073 39783
0.68	8.46790 38986	0.11809 29793	4.17490 54597	4.29299 84390	0.97249 17255
0.69	8.73815 37941	0.11444 06500	4.31185 65720	4.42629 72220	0.97414 52857
0.70	9.01702 86109	0.11090 12784	4.45306 36663	4.56396 49447	0.97570 06726
0.71	9.30480 36103	0.10747 13709	4.59866 61197	4.70613 74906	0.97716 35718
0.72	9.60176 28381	0.10414 75422	4.74880 76480	4.85295 51901	0.97853 93563
0.73	9.90819 94054	0.10092 65114	4.90363 64470	5.00456 29584	0.97983 31019
0.74	10.22441 57779	0.09780 50993	5.06330 53393	5.16111 04386	0.98104 96015
0.75	10.55072 40742	0.09478 02248	5.22797 19247	5.32275 21495	0.98219 33800
0.76	10.88744 63743	0.09184 89025	5.39779 87359	5.48964 76384	0.98326 87071
0.77	11.23491 50371	0.08900 82388	5.57295 33992	5.66196 16379	0.98427 96111
0.78	11.59347 30285	0.08625 54299	5.75360 87993	5.83986 42292	0.98522 98912
0.79	11.96347 42604	0.08358 77587	5.93994 32508	6.02353 10095	0.98612 31297
0.80	12.34528 39392	0.08100 25922	6.13214 06735	6.21314 32657	0.98696 27033
0.81	12.73927 89270	0.07849 73785	6.33039 07743	6.40888 81528	0.98775 17946
0.82	13.14584 81133	0.07606 96451	6.53488 92341	6.61095 88792	0.98849 34022
0.83	13.56539 27988	0.07371 69955	6.74583 79017	6.81955 48972	0.98919 03509
0.84	13.99832 70916	0.07143 71077	6.96344 49919	7.03488 20996	0.98984 53014
0.85	14.44507 83157	0.06922 77313	7.18792 52922	7.25715 30235	0.99046 07591
0.86	14.90608 74333	0.06708 66855	7.41950 03739	7.48658 70594	0.99103 90830
0.87	15.38180 94795	0.06501 18571	7.65839 88112	7.72341 06683	0.99158 24938
0.88	15.87271 40119	0.06300 11981	7.90485 64069	7.96785 76050	0.99209 30818
0.89	16.37928 55735	0.06105 27239	8.15911 64248	8.22016 91487	0.99257 28142
0.90	16.90202 41717	0.05916 45113	8.42142 98302	8.48059 43415	0.99302 35419
0.91	17.44144 57711	0.05733 46965	8.69205 55373	8.74939 02338	0.99344 70066
0.92	17.99808 28034	0.05556 14735	8.97126 06650	9.02682 21384	0.99384 48468
0.93	18.57248 46925	0.05384 30919	9.25932 08003	9.31316 38922	0.99421 86036
0.94	19.16521 83968	0.05217 78557	9.55652 02706	9.60869 81263	0.99456 97268
0.95	19.77686 89693	0.05056 41212	9.86315 24240	9.91371 65453	0.99489 95797
0.96	20.40804 01345	0.04900 02956	10.17951 99195	10.22852 02151	0.99520 94443
0.97	21.05935 48847	0.04748 48354	10.50593 50247	10.55341 98601	0.99550 05263
0.98	21.73145 60946	0.04601 62446	10.84271 99250	10.88873 61696	0.99577 39591
0.99	22.42500 71560	0.04459 30738	11.19020 70411	11.23480 01149	0.99603 08084
1.00	23.14069 26328	0.04321 39183	11.54873 93573	11.59195 32755	0.99627 20762
	$\left[\begin{smallmatrix} (-3)3 \\ 6 \end{smallmatrix} \right]$	$\left[\begin{smallmatrix} (-5)3 \\ 5 \end{smallmatrix} \right]$	$\left[\begin{smallmatrix} (-3)1 \\ 6 \end{smallmatrix} \right]$	$\left[\begin{smallmatrix} (-3)1 \\ 6 \end{smallmatrix} \right]$	$\left[\begin{smallmatrix} (-5)4 \\ 6 \end{smallmatrix} \right]$

INVERSE HYPERBOLIC FUNCTIONS

Table 4.17

x	$\operatorname{arcsinh} x$	$\operatorname{artanh} x$	x	$\operatorname{arcsinh} x$	$\operatorname{artanh} x$
0.00	0.00000 0000	0.00000 0000	0.50	0.48121 1825	0.54930 6144
0.01	0.00999 9833	0.01000 0333	0.51	0.49013 8161	0.56272 9769
0.02	0.01999 8667	0.02000 2667	0.52	0.49902 8444	0.57633 9754
0.03	0.02999 5502	0.03000 9004	0.53	0.50788 2413	0.59014 5160
0.04	0.03998 9341	0.04002 1353	0.54	0.51669 9824	0.60415 5603
0.05	0.04997 9190	0.05004 1729	0.55	0.52548 0448	0.61838 1313
0.06	0.05996 4058	0.06007 2156	0.56	0.53422 4074	0.63283 3186
0.07	0.06994 2959	0.07011 4671	0.57	0.54293 0505	0.64752 2844
0.08	0.07991 4912	0.08017 1325	0.58	0.55159 9562	0.66246 2707
0.09	0.08987 8941	0.09024 4188	0.59	0.56023 1077	0.67766 6068
0.10	0.09983 4079	0.10033 5347	0.60	0.56882 4899	0.69314 7180
0.11	0.10977 9366	0.11044 6915	0.61	0.57738 0892	0.70892 1359
0.12	0.11971 3851	0.12058 1028	0.62	0.58589 8932	0.72500 5087
0.13	0.12963 6590	0.13073 9850	0.63	0.59437 8911	0.74141 6144
0.14	0.13954 6654	0.14092 5576	0.64	0.60282 0733	0.75817 3745
0.15	0.14944 3120	0.15114 0436	0.65	0.61122 4314	0.77529 8706
0.16	0.15932 5080	0.16138 6696	0.66	0.61958 9584	0.79281 3631
0.17	0.16919 1636	0.17166 6663	0.67	0.62791 6485	0.81074 3125
0.18	0.17904 1904	0.18198 2689	0.68	0.63620 4970	0.82911 4038
0.19	0.18887 5015	0.19233 7169	0.69	0.64445 5005	0.84795 5755
0.20	0.19869 0110	0.20273 2554	0.70	0.65266 6566	0.86730 0527
0.21	0.20848 6350	0.21317 1346	0.71	0.66083 9641	0.88718 3863
0.22	0.21826 2908	0.22365 6109	0.72	0.66897 4227	0.90764 4983
0.23	0.22801 8972	0.23418 9466	0.73	0.67707 0332	0.92872 7364
0.24	0.23775 3749	0.24477 4112	0.74	0.68512 7974	0.95047 9381
0.25	0.24746 6462	0.25541 2812	0.75	0.69314 7181	0.97295 5074
0.26	0.25715 6349	0.26610 8407	0.76	0.70112 7988	0.99621 5082
0.27	0.26682 2667	0.27686 3823	0.77	0.70907 0441	1.02032 7758
0.28	0.27646 4691	0.28768 2072	0.78	0.71697 4594	1.04537 0548
0.29	0.28608 1715	0.29856 6264	0.79	0.72484 0509	1.07143 1684
0.30	0.29567 3048	0.30951 9604	0.80	0.73266 8256	1.09861 2289
0.31	0.30523 8020	0.32054 5409	0.81	0.74045 7912	1.12702 9026
0.32	0.31477 5980	0.33164 7108	0.82	0.74820 9563	1.15681 7465
0.33	0.32428 6295	0.34282 8254	0.83	0.75592 3300	1.18813 6404
0.34	0.33376 8352	0.35409 2528	0.84	0.76359 9222	1.22117 3518
0.35	0.34322 1555	0.36544 3754	0.85	0.77123 7433	1.25615 2811
0.36	0.35264 5330	0.37688 5901	0.86	0.77883 8046	1.29334 4672
0.37	0.36203 9121	0.38842 3100	0.87	0.78640 1177	1.33307 9629
0.38	0.37140 2391	0.40005 9650	0.88	0.79392 6950	1.37576 7657
0.39	0.38073 4624	0.41180 0034	0.89	0.80141 5491	1.42192 5871
0.40	0.39003 5320	0.42364 8930	0.90	0.80886 6936	1.47221 9490
0.41	0.39930 4001	0.43561 1223	0.91	0.81628 1421	1.52752 4425
0.42	0.40854 0208	0.44769 2023	0.92	0.82365 9091	1.58902 6915
0.43	0.41774 3500	0.45989 6681	0.93	0.83100 0091	1.65839 0020
0.44	0.42691 3454	0.47223 0804	0.94	0.83830 4575	1.73804 9345
0.45	0.43604 9669	0.48470 0279	0.95	0.84557 2697	1.83178 0823
0.46	0.44515 1759	0.49731 1288	0.96	0.85280 4617	1.94591 0149
0.47	0.45421 9359	0.51007 0337	0.97	0.86000 0498	2.09229 5720
0.48	0.46325 2120	0.52298 4278	0.98	0.86716 0507	2.29755 9925
0.49	0.47224 9713	0.53606 0337	0.99	0.87428 4812	2.64665 2412
0.50	0.48121 1825	0.54930 6144	1.00	0.88137 3587	∞
	$\left[\begin{smallmatrix} (-6)5 \\ 4 \end{smallmatrix} \right]$	$\left[\begin{smallmatrix} (-5)2 \\ 5 \end{smallmatrix} \right]$		$\left[\begin{smallmatrix} (-6)5 \\ 4 \end{smallmatrix} \right]$	

For use of the table see Examples 26–28.

$$Q_0(x) \text{ (Legendre Function—Second Kind)} = \operatorname{arctanh} x \text{ (}|x| < 1)$$

$$= \operatorname{arccoth} x \text{ (}|x| > 1)$$

Compiled from Harvard Computation Laboratory, Tables of inverse hyperbolic functions. Harvard Univ. Press, Cambridge, Mass., 1949 (with permission).

Table 4.17

INVERSE HYPERBOLIC FUNCTIONS

x	$\operatorname{arsinh} x$	$\frac{\operatorname{arcosh} x}{(x^2-1)^{\frac{1}{2}}}$	x	$\operatorname{arsinh} x$	$\frac{\operatorname{arcosh} x}{(x^2-1)^{\frac{1}{2}}}$
1.00	0.88137 3587	1.00000 000	1.50	1.19476 3217	0.86081 788
1.01	0.88842 7007	0.99667 995	1.51	1.20029 7449	0.85849 554
1.02	0.89544 5249	0.99338 621	1.52	1.20580 6263	0.85618 806
1.03	0.90242 8496	0.99011 848	1.53	1.21128 9840	0.85389 528
1.04	0.90937 6928	0.98687 641	1.54	1.21674 8362	0.85161 706
1.05	0.91629 0732	0.98365 968	1.55	1.22218 2008	0.84935 324
1.06	0.92317 0094	0.98046 798	1.56	1.22759 0958	0.84710 368
1.07	0.93001 5204	0.97730 099	1.57	1.23297 5390	0.84486 823
1.08	0.93682 6251	0.97415 841	1.58	1.23833 5478	0.84264 676
1.09	0.94360 3429	0.97103 994	1.59	1.24367 1400	0.84043 913
1.10	0.95034 6930	0.96794 529	1.60	1.24898 3328	0.83824 520
1.11	0.95705 6950	0.96487 415	1.61	1.25427 1436	0.83606 483
1.12	0.96373 3684	0.96182 625	1.62	1.25953 5895	0.83389 788
1.13	0.97037 7331	0.95880 131	1.63	1.26477 6877	0.83174 424
1.14	0.97698 8088	0.95579 904	1.64	1.26999 4549	0.82960 376
1.15	0.98356 6154	0.95281 918	1.65	1.27518 9081	0.82747 632
1.16	0.99011 1729	0.94986 146	1.66	1.28036 0639	0.82536 179
1.17	0.99662 5013	0.94692 561	1.67	1.28550 9389	0.82326 005
1.18	1.00310 6208	0.94401 139	1.68	1.29063 5495	0.82117 097
1.19	1.00955 5514	0.94111 853	1.69	1.29573 9120	0.81909 443
1.20	1.01597 3134	0.93824 678	1.70	1.30082 0427	0.81703 032
1.21	1.02235 9270	0.93539 589	1.71	1.30587 9576	0.81497 850
1.22	1.02871 4123	0.93256 563	1.72	1.31091 6727	0.81293 888
1.23	1.03503 7896	0.92975 576	1.73	1.31593 2038	0.81091 132
1.24	1.04133 0792	0.92696 604	1.74	1.32092 5666	0.80889 572
1.25	1.04759 3013	0.92419 624	1.75	1.32589 7767	0.80689 197
1.26	1.05382 4760	0.92144 613	1.76	1.33084 8496	0.80489 994
1.27	1.06002 6237	0.91871 550	1.77	1.33577 8006	0.80291 954
1.28	1.06619 7645	0.91600 411	1.78	1.34068 6450	0.80095 066
1.29	1.07233 9185	0.91331 175	1.79	1.34557 3978	0.79899 318
1.30	1.07845 1059	0.91063 821	1.80	1.35044 0740	0.79704 701
1.31	1.08453 3467	0.90798 328	1.81	1.35528 6886	0.79511 203
1.32	1.09058 6610	0.90534 676	1.82	1.36011 2562	0.79318 816
1.33	1.09661 0688	0.90272 843	1.83	1.36491 7914	0.79127 527
1.34	1.10260 5899	0.90012 810	1.84	1.36970 3089	0.78937 328
1.35	1.10857 2442	0.89754 557	1.85	1.37446 8228	0.78748 209
1.36	1.11451 0515	0.89498 064	1.86	1.37921 3477	0.78560 160
1.37	1.12042 0317	0.89243 313	1.87	1.38393 8975	0.78373 170
1.38	1.12630 2042	0.88990 284	1.88	1.38864 4863	0.78187 231
1.39	1.13215 5887	0.88738 959	1.89	1.39333 1280	0.78002 334
1.40	1.13798 2046	0.88489 320	1.90	1.39799 8365	0.77818 468
1.41	1.14378 0715	0.88241 348	1.91	1.40264 6254	0.77635 625
1.42	1.14955 2086	0.87995 026	1.92	1.40727 5083	0.77453 796
1.43	1.15529 6351	0.87750 336	1.93	1.41188 4987	0.77272 971
1.44	1.16101 3703	0.87507 261	1.94	1.41647 6099	0.77093 142
1.45	1.16670 4331	0.87265 784	1.95	1.42104 8552	0.76914 300
1.46	1.17236 8425	0.87025 888	1.96	1.42560 2476	0.76736 437
1.47	1.17800 6174	0.86787 557	1.97	1.43013 8002	0.76559 544
1.48	1.18361 7765	0.86550 774	1.98	1.43465 5259	0.76383 612
1.49	1.18920 3384	0.86315 523	1.99	1.43915 4374	0.76208 633
1.50	1.19476 3217	0.86081 788	2.00	1.44363 5475	0.76034 600
	$\left[\begin{smallmatrix} (-6)4 \\ 4 \end{smallmatrix} \right]$	$\left[\begin{smallmatrix} (-6)3 \\ 4 \end{smallmatrix} \right]$		$\left[\begin{smallmatrix} (-6)3 \\ 4 \end{smallmatrix} \right]$	$\left[\begin{smallmatrix} (-6)2 \\ 4 \end{smallmatrix} \right]$

INVERSE HYPERBOLIC FUNCTIONS

Table 4.17

x^{-1}	$\operatorname{arsinh} x - \ln x$	$\operatorname{arcosh} x - \ln x$	$\langle x \rangle$	x^{-1}	$\operatorname{arsinh} x - \ln x$	$\operatorname{arcosh} x - \ln x$	$\langle x \rangle$
0.50	0.75048 82946	0.62381 07164	2	0.25	0.70841 81861	0.67714 27078	4
0.49	0.74839 16011	0.62685 90940	2	0.24	0.70724 57326	0.67842 57947	4
0.48	0.74632 48341	0.62981 77884	2	0.23	0.70611 72820	0.67965 18411	4
0.47	0.74428 85962	0.63268 90778	2	0.22	0.70503 32895	0.68082 14660	5
0.46	0.74228 34908	0.63547 51194	2	0.21	0.70399 41963	0.68193 52541	5
0.45	0.74031 01215	0.63817 79566	2	0.20	0.70300 04288	0.68299 37571	5
0.44	0.73836 90921	0.64079 95268	2	0.19	0.70205 23983	0.68399 74947	5
0.43	0.73646 10057	0.64334 16670	2	0.18	0.70115 05002	0.68494 69555	6
0.42	0.73458 64641	0.64580 61207	2	0.17	0.70029 51134	0.68584 25981	6
0.41	0.73274 60676	0.64819 45429	2	0.16	0.69948 66000	0.68668 48518	6
0.40	0.73094 04145	0.65050 85051	3	0.15	0.69872 53043	0.68747 41175	7
0.39	0.72917 01001	0.65274 95004	3	0.14	0.69801 15527	0.68821 07683	7
0.38	0.72743 57167	0.65491 89477	3	0.13	0.69734 56533	0.68889 51504	8
0.37	0.72573 78524	0.65701 81952	3	0.12	0.69672 78946	0.68952 75836	8
0.36	0.72407 70912	0.65904 85249	3	0.11	0.69615 85462	0.69010 83616	9
0.35	0.72245 40117	0.66101 11555	3	0.10	0.69563 78573	0.69063 77531	10
0.34	0.72086 91873	0.66290 72458	3	0.09	0.69516 60572	0.69111 60018	11
0.33	0.71932 31846	0.66473 78974	3	0.08	0.69474 33542	0.69154 33269	13
0.32	0.71781 65636	0.66650 41577	3	0.07	0.69436 99357	0.69191 99235	14
0.31	0.71634 98766	0.66820 70226	3	0.06	0.69404 59680	0.69224 59631	17
0.30	0.71492 36678	0.66984 74382	3	0.05	0.69377 15954	0.69252 15938	20
0.29	0.71353 84725	0.67142 63038	3	0.04	0.69354 69408	0.69274 69403	25
0.28	0.71219 48165	0.67294 44732	4	0.03	0.69337 21047	0.69292 21046	33
0.27	0.71089 32154	0.67440 27575	4	0.02	0.69324 71656	0.69304 71656	50
0.26	0.70963 41742	0.67580 19258	4	0.01	0.69317 21796	0.69312 21796	100
0.25	0.70841 81861	0.67714 27078	4	0.00	0.69314 71806	0.69314 71806	∞
	$\left[\begin{smallmatrix} (-6)5 \\ 5 \end{smallmatrix} \right]$	$\left[\begin{smallmatrix} (-5)1 \\ 6 \end{smallmatrix} \right]$			$\left[\begin{smallmatrix} (-6)6 \\ 5 \end{smallmatrix} \right]$	* $\left[\begin{smallmatrix} (-6)7 \\ 5 \end{smallmatrix} \right]$	

$\langle x \rangle$ = nearest integer to x .

ROOTS x_n OF $\cos x_n \cosh x_n = 1$

Table 4.18

n	x_n
1	4.73004 07
2	7.85320 46
3	10.99560 78
4	14.13716 55
5	17.27875 96

For $n \geq 5$, $x_n = \frac{1}{2} [2n+1]\pi$

ROOTS x_n OF $\cos x_n \cosh x_n = -1$

n	x_n
1	1.87510 41
2	4.69409 11
3	7.85475 74
4	10.99554 07
5	14.13716 84

For $n > 5$, $x_n = \frac{1}{2} [2n-1]\pi$

*See page II.

Table 4.19

ROOTS x_n OF $\tan x = \lambda x$

$-\lambda$	x_1	x_2	x_3	x_4	x_5	x_6	x_7	x_8	x_9	
0.00	3.14159	6.28319	9.42478	12.56637	15.70796	18.84956	21.99115	25.13274	28.27433	
0.05	2.99304	5.99209	9.00185	12.02503	15.06247	18.11361	21.17717	24.25156	27.33519	
0.10	2.86277	5.76056	8.70831	11.70268	14.73347	17.79083	20.86724	23.95737	27.05755	
0.15	2.75032	5.58578	8.51805	11.52018	14.56638	17.64009	20.73148	23.83468	26.94607	
0.20	2.65366	5.45435	8.39135	11.40863	14.46987	17.55621	20.65782	23.76928	26.88740	
0.25	2.57043	5.35403	8.30293	11.33482	14.40797	17.50343	20.61203	23.72894	26.85142	
0.30	2.49840	5.27587	8.23845	11.28284	14.36517	17.46732	20.58092	23.70166	26.82716	
0.35	2.43566	5.21370	8.18965	11.24440	14.33391	17.44113	20.55844	23.68201	26.80971	
0.40	2.38064	5.16331	8.15156	11.21491	14.31012	17.42129	20.54146	23.66719	26.79656	
0.45	2.33208	5.12176	8.12108	11.19159	14.29142	17.40574	20.52818	23.65561	26.78631	
0.50	2.28893	5.08698	8.09616	11.17271	14.27635	17.39324	20.51752	23.64632	26.77809	
0.55	2.25037	5.05750	8.07544	11.15712	14.26395	17.38298	20.50877	23.63871	26.77135	
0.60	2.21571	5.03222	8.05794	11.14403	14.25357	17.37439	20.50147	23.63235	26.76572	
0.65	2.18440	5.01031	8.04298	11.13289	14.24475	17.36711	20.49528	23.62697	26.76096	
0.70	2.15598	4.99116	8.03004	11.12330	14.23717	17.36086	20.48996	23.62235	26.75688	
0.75	2.13008	4.97428	8.01875	11.11496	14.23059	17.35543	20.48535	23.61834	26.75333	
0.80	2.10638	4.95930	8.00881	11.10764	14.22482	17.35068	20.48131	23.61483	26.75023	
0.85	2.08460	4.94592	7.99999	11.10116	14.21971	17.34648	20.47774	23.61173	26.74749	
0.90	2.06453	4.93389	7.99212	11.09538	14.21517	17.34274	20.47457	23.60897	26.74506	
0.95	2.04597	4.92303	7.98505	11.09021	14.21110	17.33939	20.47172	23.60651	26.74288	
1.00	2.02876	4.91318	7.97867	11.08554	14.20744	17.33638	20.46917	23.60428	26.74092	
λ^{-1}	x_1	x_2	x_3	x_4	x_5	x_6	x_7	x_8	x_9	$\langle \lambda \rangle$
-1.00	2.02876	4.91318	7.97867	11.08554	14.20744	17.33638	20.46917	23.60428	26.74092	-1
-0.95	2.01194	4.90375	7.97258	11.08110	14.20395	17.33351	20.46673	23.60217	26.73905	-1
-0.90	1.99465	4.89425	7.96648	11.07665	14.20046	17.33064	20.46430	23.60006	26.73718	-1
-0.85	1.97687	4.88468	7.96036	11.07219	14.19697	17.32777	20.46187	23.59795	26.73532	-1
-0.80	1.95857	4.87504	7.95422	11.06773	14.19347	17.32490	20.45943	23.59584	26.73345	-1
-0.75	1.93974	4.86534	7.94807	11.06326	14.18997	17.32203	20.45700	23.59372	26.73159	-1
-0.70	1.92035	4.85557	7.94189	11.05879	14.18647	17.31915	20.45456	23.59161	26.72972	-1
-0.65	1.90036	4.84573	7.93571	11.05431	14.18296	17.31628	20.45212	23.58949	26.72785	-2
-0.60	1.87976	4.83583	7.92950	11.04982	14.17946	17.31340	20.44968	23.58738	26.72598	-2
-0.55	1.85852	4.82587	7.92329	11.04533	14.17594	17.31052	20.44724	23.58526	26.72411	-2
-0.50	1.83660	4.81584	7.91705	11.04083	14.17243	17.30764	20.44480	23.58314	26.72225	-2
-0.45	1.81396	4.80575	7.91080	11.03633	14.16892	17.30476	20.44236	23.58102	26.72038	-2
-0.40	1.79058	4.79561	7.90454	11.03182	14.16540	17.30187	20.43992	23.57891	26.71851	-3
-0.35	1.76641	4.78540	7.89827	11.02730	14.16188	17.29899	20.43748	23.57679	26.71664	-3
-0.30	1.74140	4.77513	7.89198	11.02278	14.15835	17.29610	20.43503	23.57467	26.71477	-3
-0.25	1.71551	4.76481	7.88567	11.01826	14.15483	17.29321	20.43259	23.57255	26.71290	-4
-0.20	1.68868	4.75443	7.87936	11.01373	14.15130	17.29033	20.43014	23.57043	26.71102	-5
-0.15	1.66087	4.74400	7.87303	11.00920	14.14777	17.28744	20.42769	23.56831	26.70915	-7
-0.10	1.63199	4.73351	7.86669	11.00466	14.14424	17.28454	20.42525	23.56619	26.70728	-10
-0.05	1.60200	4.72298	7.86034	11.00012	14.14070	17.28165	20.42280	23.56407	26.70541	-20
0.00	1.57080	4.71239	7.85398	10.99557	14.13717	17.27875	20.42035	23.56194	26.70354	∞
0.05	1.53830	4.70176	7.84761	10.99102	14.13363	17.27586	20.41790	23.55982	26.70166	20
0.10	1.50442	4.69108	7.84123	10.98647	14.13009	17.27297	20.41545	23.55770	26.69979	10
0.15	1.46904	4.68035	7.83484	10.98192	14.12655	17.27007	20.41300	23.55558	26.69792	7
0.20	1.43203	4.66958	7.82844	10.97736	14.12301	17.26718	20.41055	23.55345	26.69604	5
0.25	1.39325	4.65878	7.82203	10.97279	14.11946	17.26428	20.40810	23.55133	26.69417	4
0.30	1.35252	4.64793	7.81562	10.96823	14.11592	17.26138	20.40565	23.54921	26.69230	3
0.35	1.30965	4.63705	7.80919	10.96366	14.11237	17.25848	20.40320	23.54708	26.69042	3
0.40	1.26440	4.62614	7.80276	10.95909	14.10882	17.25558	20.40075	23.54496	26.68855	3
0.45	1.21649	4.61519	7.79633	10.95452	14.10527	17.25268	20.39829	23.54283	26.68668	2
0.50	1.16556	4.60422	7.78988	10.94994	14.10172	17.24978	20.39584	23.54071	26.68480	2
0.55	1.11118	4.59321	7.78344	10.94537	14.09817	17.24688	20.39339	23.53858	26.68293	2
0.60	1.05279	4.58219	7.77698	10.94079	14.09462	17.24398	20.39094	23.53646	26.68105	2
0.65	0.98966	4.57114	7.77053	10.93621	14.09107	17.24108	20.38848	23.53433	26.67918	2
0.70	0.92079	4.56007	7.76407	10.93163	14.08752	17.23817	20.38603	23.53221	26.67730	1
0.75	0.84473	4.54899	7.75760	10.92704	14.08396	17.23527	20.38357	23.53008	26.67543	1
0.80	0.75931	4.53789	7.75114	10.92246	14.08041	17.23237	20.38112	23.52796	26.67355	1
0.85	0.66086	4.52678	7.74467	10.91788	14.07686	17.22946	20.37867	23.52583	26.67168	1
0.90	0.54228	4.51566	7.73820	10.91329	14.07330	17.22656	20.37621	23.52370	26.66980	1
0.95	0.38537	4.50454	7.73172	10.90871	14.06975	17.22366	20.37376	23.52158	26.66793	1
1.00	0.00000	4.49341	7.72525	10.90412	14.06619	17.22075	20.37130	23.51945	26.66605	1

For $\lambda=0$, see j_{λ} of Table 10.6.

$\langle \lambda \rangle$ = nearest integer to λ .

ROOTS x_n OF $\cot x_n = \lambda x_n$

Table 4.20

λ	x_1	x_2	x_3	x_4	x_5	x_6	x_7	x_8	x_9
0.00	1.57080	4.71239	7.85398	10.99557	14.13717	17.27876	20.42035	23.56194	26.70354
0.05	1.49613	4.49148	7.49541	10.51167	13.54198	16.58639	19.64394	22.71311	25.79232
0.10	1.42887	4.30580	7.22811	10.20026	13.21418	16.25936	19.32703	22.41085	25.50638
0.15	1.36835	4.15504	7.04126	10.01222	13.03901	16.10053	19.18401	22.28187	25.38952
0.20	1.31384	4.03357	6.90960	9.89275	12.93522	16.01066	19.10552	22.21256	25.32765
0.25	1.26459	3.93516	6.81401	9.81188	12.86775	15.95363	19.05645	22.16965	25.28961
0.30	1.21995	3.85460	6.74233	9.75407	12.82073	15.91443	19.02302	22.14058	25.26392
0.35	1.17933	3.78784	6.68698	9.71092	12.78621	15.88591	18.99882	22.11960	25.24544
0.40	1.14223	3.73184	6.64312	9.67758	12.75985	15.86426	18.98052	22.10377	25.23150
0.45	1.10820	3.68433	6.60761	9.65109	12.73907	15.84728	18.96619	22.09140	25.22062
0.50	1.07687	3.64360	6.57833	9.62956	12.72230	15.83361	18.95468	22.08147	25.21190
0.55	1.04794	3.60834	6.55380	9.61173	12.70847	15.82237	18.94523	22.07333	25.20475
0.60	1.02111	3.57756	6.53297	9.59673	12.69689	15.81297	18.93734	22.06653	25.19878
0.65	0.99617	3.55048	6.51508	9.58394	12.68704	15.80500	18.93065	22.06077	25.19373
0.70	0.97291	3.52649	6.49954	9.57292	12.67857	15.79814	18.92490	22.05583	25.18939
0.75	0.95116	3.50509	6.48593	9.56331	12.67121	15.79219	18.91991	22.05154	25.18563
0.80	0.93076	3.48590	6.47392	9.55486	12.66475	15.78698	18.91554	22.04778	25.18234
0.85	0.91158	3.46859	6.46324	9.54738	12.65904	15.78237	18.91168	22.04447	25.17943
0.90	0.89352	3.45292	6.45368	9.54072	12.65395	15.77827	18.90825	22.04151	25.17684
0.95	0.87647	3.43865	6.44508	9.53473	12.64939	15.77459	18.90518	22.03887	25.17453
1.00	0.86033	3.42562	6.43730	9.52933	12.64529	15.77128	18.90241	22.03650	25.17245

λ^{-1}	x_1	x_2	x_3	x_4	x_5	x_6	x_7	x_8	x_9	$\langle \lambda \rangle$
1.00	0.86033	3.42562	6.43730	9.52933	12.64529	15.77128	18.90241	22.03650	25.17245	1
0.95	0.84426	3.41306	6.42987	9.52419	12.64138	15.76814	18.89978	22.03424	25.17047	1
0.90	0.82740	3.40034	6.42241	9.51904	12.63747	15.76499	18.89715	22.03197	25.16848	1
0.85	0.80968	3.38744	6.41492	9.51388	12.63355	15.76184	18.89451	22.02971	25.16650	1
0.80	0.79103	3.37438	6.40740	9.50871	12.62963	15.75868	18.89188	22.02745	25.16452	1
0.75	0.77136	3.36113	6.39984	9.50353	12.62570	15.75553	18.88924	22.02519	25.16254	1
0.70	0.75056	3.34772	6.39226	9.49834	12.62177	15.75237	18.88660	22.02292	25.16055	1
0.65	0.72851	3.33413	6.38464	9.49314	12.61784	15.74921	18.88396	22.02066	25.15857	2
0.60	0.70507	3.32037	6.37700	9.48793	12.61390	15.74605	18.88132	22.01839	25.15659	2
0.55	0.68006	3.30643	6.36932	9.48271	12.60996	15.74288	18.87868	22.01612	25.15460	2
0.50	0.65327	3.29231	6.36162	9.47749	12.60601	15.73972	18.87604	22.01386	25.15262	2
0.45	0.62444	3.27802	6.35389	9.47225	12.60206	15.73655	18.87339	22.01159	25.15063	2
0.40	0.59324	3.26355	6.34613	9.46700	12.59811	15.73338	18.87075	22.00932	25.14864	3
0.35	0.55922	3.24891	6.33835	9.46175	12.59415	15.73021	18.86810	22.00705	25.14666	3
0.30	0.52179	3.23409	6.33054	9.45649	12.59019	15.72704	18.86546	22.00478	25.14467	3
0.25	0.48009	3.21910	6.32270	9.45122	12.58623	15.72386	18.86281	22.00251	25.14268	4
0.20	0.43284	3.20393	6.31485	9.44595	12.58226	15.72068	18.86016	22.00024	25.14070	5
0.15	0.37788	3.18860	6.30696	9.44067	12.57829	15.71751	18.85751	21.99797	25.13871	7
0.10	0.31105	3.17310	6.29906	9.43538	12.57432	15.71433	18.85486	21.99569	25.13672	10
0.05	0.22176	3.15743	6.29113	9.43008	12.57035	15.71114	18.85221	21.99342	25.13473	20
0.00	0.00000	3.14159	6.28319	9.42478	12.56637	15.70796	18.84956	21.99115	25.13274	∞
*		$\begin{bmatrix} (-5)2 \\ 3 \end{bmatrix}$	$\begin{bmatrix} (-5)1 \\ 2 \end{bmatrix}$	$\begin{bmatrix} (-5)1 \\ 2 \end{bmatrix}$	$\begin{bmatrix} (-5)1 \\ 2 \end{bmatrix}$	$\begin{bmatrix} (-5)1 \\ 2 \end{bmatrix}$	$\begin{bmatrix} (-5)1 \\ 2 \end{bmatrix}$	$\begin{bmatrix} (-5)1 \\ 2 \end{bmatrix}$	$\begin{bmatrix} (-5)1 \\ 2 \end{bmatrix}$	$\begin{bmatrix} (-5)1 \\ 2 \end{bmatrix}$

$\langle \lambda \rangle$ = nearest integer to λ .

For $\lambda^{-1} > .20$, the maximum error in linear interpolation is $(-4)7$; five-point interpolation gives $5D$.

For $\lambda^{-1} \leq .20$,

$$x_1 \approx \frac{1}{\sqrt{\lambda}} \left[1 - \frac{1}{6\lambda} + \frac{11}{360\lambda} 2 - \frac{1}{432\lambda} 3 + \dots \right].$$

*See page II.

5. Exponential Integral and Related Functions

WALTER GAUTSCHI¹ AND WILLIAM F. CAHILL²

Contents

	Page
Mathematical Properties	228
5.1. Exponential Integral	228
5.2. Sine and Cosine Integrals	231
Numerical Methods	233
5.3. Use and Extension of the Tables	233
References	235
Table 5.1. Sine, Cosine and Exponential Integrals ($0 \leq x \leq 10$)	238
$x^{-1}\text{Si}(x)$, $x^{-2}[\text{Ci}(x) - \ln x - \gamma]$	
$x^{-1}[\text{Ei}(x) - \ln x - \gamma]$, $x^{-1}[E_1(x) + \ln x + \gamma]$, $x=0(.01).5$, 10S	
$\text{Si}(x)$, $\text{Ci}(x)$, 10D; $\text{Ei}(x)$, $E_1(x)$, 9D; $x=.5(.01)2$	
$\text{Si}(x)$, $\text{Ci}(x)$, 10D; $xe^{-x}\text{Ei}(x)$, $xe^x E_1(x)$, 9D; $x=2(.1)10$	
Table 5.2. Sine, Cosine and Exponential Integrals for Large Arguments ($10 \leq x \leq \infty$)	243
$xf(x)$, 9D; $x^2g(x)$, 7D; $xe^{-x}\text{Ei}(x)$, 8D; $xe^x E_1(x)$, 10D	
$f(x) = -\text{si}(x) \cos x + \text{Ci}(x) \sin x$, $g(x) = -\text{si}(x) \sin x - \text{Ci}(x) \cos x$	
$x^{-1} = .1(-.005)0$	
Table 5.3. Sine and Cosine Integrals for Arguments πx ($0 \leq x \leq 10$)	244
$\text{Si}(\pi x)$, $\text{Cin}(\pi x)$, $x=0(.1)10$, 7D	
Table 5.4. Exponential Integrals $E_n(x)$ ($0 \leq x \leq 2$)	245
$E_2(x) - x \ln x$, $E_n(x)$, $n=3, 4, 10, 20$, $x=0(.01).5$	
$E_n(x)$, $n=2, 3, 4, 10, 20$, $x=.5(.01)2$, 7D	
Table 5.5. Exponential Integrals $E_n(x)$ for Large Arguments ($2 \leq x \leq \infty$)	248
$(x+n)e^x E_n(x)$, $n=2, 3, 4, 10, 20$, $x^{-1} = .5(-.05).1(-.01)0$, 5D	
Table 5.6. Exponential Integral for Complex Arguments ($ z < 29$)	249
$ze^z E_1(z)$, $z=x+iy$, $x=-19(1)20$, $y=0(1)20$, 6D	
Table 5.7. Exponential Integral for Small Complex Arguments ($ z < 5$)	251
$e^z E_1(z)$, $z=x+iy$, $x=-4(.5)-2$, $y=0(.2)1$, 6D	
$E_1(z) + \ln z$, $z=x+iy$, $x=-2(.5)2.5$, $y=0(.2)1$, 6D	

The authors acknowledge the assistance of David S. Liepman in the preparation and checking of the tables, Robert L. Durrah for the computation of **Table 5.2**, and Alfred E. Beam for the computation of **Table 5.6**.

¹ Guest worker, National Bureau of Standards, from the American University. (Presently Purdue University.)

² National Bureau of Standards. (Presently NASA.)

5. Exponential Integral and Related Functions

Mathematical Properties

5.1. Exponential Integral

Definitions

$$5.1.1 \quad E_1(z) = \int_z^\infty \frac{e^{-t}}{t} dt \quad (|\arg z| < \pi)$$

$$5.1.2 \quad \text{Ei}(x) = -\int_{-x}^\infty \frac{e^{-t}}{t} dt = \int_{-\infty}^x \frac{e^t}{t} dt \quad (x > 0)$$

$$5.1.3 \quad \text{li}(x) = \int_0^x \frac{dt}{\ln t} = \text{Ei}(\ln x) \quad (x > 1)$$

5.1.4

$$E_n(z) = \int_1^\infty \frac{e^{-zt}}{t^n} dt \quad (n=0, 1, 2, \dots; \Re z > 0)$$

5.1.5

$$\alpha_n(z) = \int_1^\infty t^n e^{-zt} dt \quad (n=0, 1, 2, \dots; \Re z > 0)$$

$$5.1.6 \quad \beta_n(z) = \int_{-1}^1 t^n e^{-zt} dt \quad (n=0, 1, 2, \dots)$$

In 5.1.1 it is assumed that the path of integration excludes the origin and does not cross the negative real axis.

Analytic continuation of the functions in 5.1.1, 5.1.2, and 5.1.4 for $n > 0$ yields multi-valued functions with branch points at $z=0$ and $z=\infty$.³ They are single-valued functions in the z -plane cut along the negative real axis.⁴ The function $\text{li}(z)$, the logarithmic integral, has an additional branch point at $z=1$.

Interrelations

5.1.7

$$E_1(-x \pm i0) = -\text{Ei}(x) \mp i\pi, \\ -\text{Ei}(x) = \frac{1}{2}[E_1(-x+i0) + E_1(-x-i0)] \quad (x > 0)$$

³ Some authors [5.14], [5.16] use the entire function $\int_0^z (1-e^{-t})dt/t$ as the basic function and denote it by $\text{Ein}(z)$. We have $\text{Ein}(z) = E_1(z) + \ln z + \gamma$.

⁴ Various authors define the integral $\int_{-\infty}^z (e^t/t)dt$ in the z -plane cut along the positive real axis and denote it also by $\text{Ei}(z)$. For $z=x > 0$ additional notations such as $\overline{\text{Ei}}(x)$ (e.g., in [5.10], [5.25]), $E^*(x)$ (in [5.2]), $\text{Ei}^*(x)$ (in [5.6]) are then used to designate the principal value of the integral. Correspondingly, $E_1(x)$ is often denoted by $-\text{Ei}(-x)$.

Explicit Expressions for $\alpha_n(z)$ and $\beta_n(z)$

$$5.1.8 \quad \alpha_n(z) = n! z^{-n-1} e^{-z} \left(1 + z + \frac{z^2}{2!} + \dots + \frac{z^n}{n!} \right)$$

5.1.9

$$\beta_n(z) = n! z^{-n-1} \left\{ e^z \left[1 - z + \frac{z^2}{2!} - \dots + (-1)^n \frac{z^n}{n!} \right] - e^{-z} \left(1 + z + \frac{z^2}{2!} + \dots + \frac{z^n}{n!} \right) \right\}$$

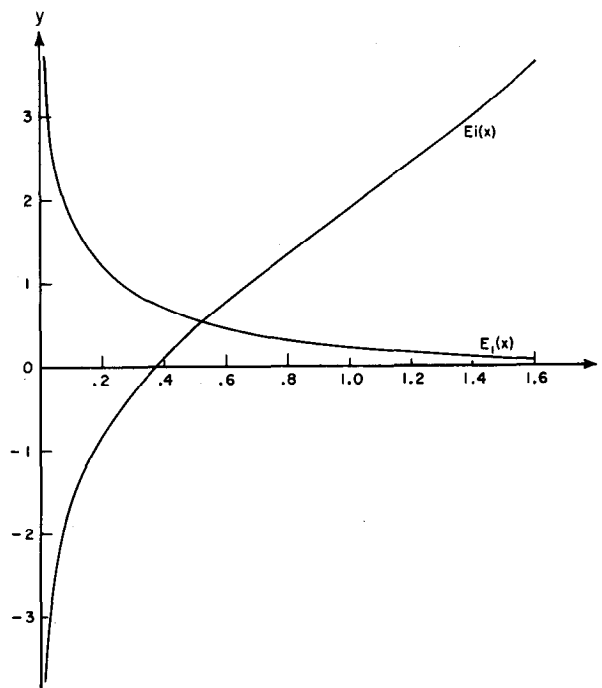

FIGURE 5.1. $y = \text{Ei}(x)$ and $y = E_1(x)$.

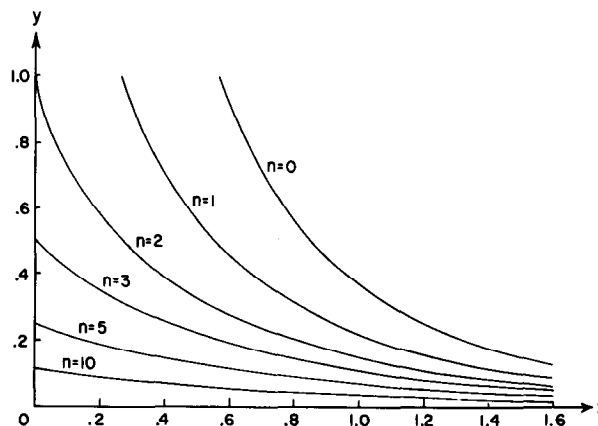

FIGURE 5.2. $y = E_n(x)$
 $n=0, 1, 2, 3, 5, 10$

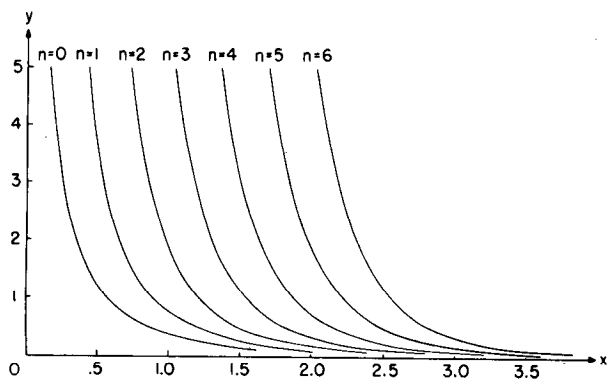

FIGURE 5.3. $y = \alpha_n(x)$
 $n = 0(1)6$

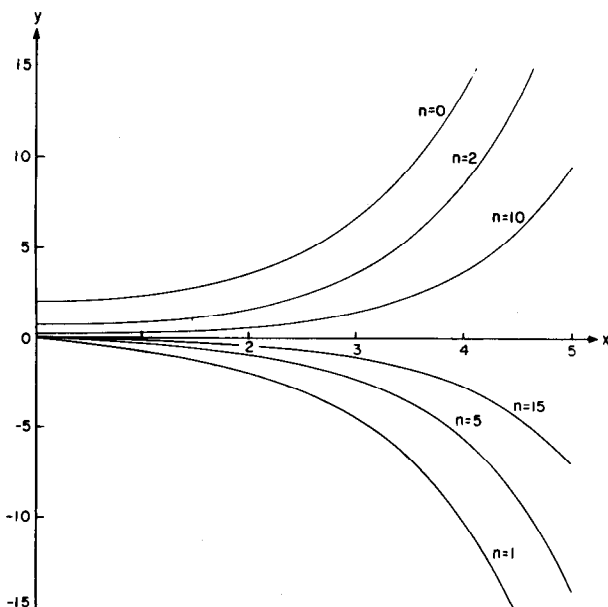

FIGURE 5.4. $y = \beta_n(x)$
 $n = 0, 1, 2, 5, 10, 15$

Series Expansions

5.1.10 $Ei(x) = \gamma + \ln x + \sum_{n=1}^{\infty} \frac{x^n}{nn!}$ ($x > 0$)

5.1.11 $E_1(z) = -\gamma - \ln z - \sum_{n=1}^{\infty} \frac{(-1)^n z^n}{nn!}$ ($|\arg z| < \pi$)

5.1.12 $E_n(z) = \frac{(-z)^{n-1}}{(n-1)!} [-\ln z + \psi(n)] - \sum_{\substack{m=0 \\ m \neq n-1}}^{\infty} \frac{(-z)^m}{(m-n+1)m!}$ ($|\arg z| < \pi$)

$\psi(1) = -\gamma, \psi(n) = -\gamma + \sum_{m=1}^{n-1} \frac{1}{m}$ ($n > 1$)

$\gamma = .57721\ 56649 \dots$ is Euler's constant.

Symmetry Relation

5.1.13 $E_n(\bar{z}) = \overline{E_n(z)}$

Recurrence Relations

5.1.14 $E_{n+1}(z) = \frac{1}{n} [e^{-z} - zE_n(z)]$ ($n = 1, 2, 3, \dots$)

5.1.15 $z\alpha_n(z) = e^{-z} + n\alpha_{n-1}(z)$ ($n = 1, 2, 3, \dots$)

5.1.16 $z\beta_n(z) = (-1)^n e^z - e^{-z} + n\beta_{n-1}(z)$ ($n = 1, 2, 3, \dots$)

Inequalities [5.8], [5.4]

5.1.17 $\frac{n-1}{n} E_n(x) < E_{n+1}(x) < E_n(x)$ ($x > 0; n = 1, 2, 3, \dots$)

5.1.18 $E_n^2(x) < E_{n-1}(x)E_{n+1}(x)$ ($x > 0; n = 1, 2, 3, \dots$)

5.1.19 $\frac{1}{x+n} < e^x E_n(x) \leq \frac{1}{x+n-1}$ ($x > 0; n = 1, 2, 3, \dots$)

5.1.20 $\frac{1}{2} \ln \left(1 + \frac{2}{x}\right) < e^x E_1(x) < \ln \left(1 + \frac{1}{x}\right)$ ($x > 0$)

5.1.21 $\frac{d}{dx} \left[\frac{E_n(x)}{E_{n-1}(x)} \right] > 0$ ($x > 0; n = 1, 2, 3, \dots$)

Continued Fraction

5.1.22 $E_n(z) = e^{-z} \left(\frac{1}{z+1} \frac{n}{1+z} \frac{1}{z+1} \frac{n+1}{z+1} \frac{2}{z+1} \dots \right)$ ($|\arg z| < \pi$)

Special Values

5.1.23 $E_n(0) = \frac{1}{n-1}$ ($n > 1$)

5.1.24 $E_0(z) = \frac{e^{-z}}{z}$

5.1.25 $\alpha_0(z) = \frac{e^{-z}}{z}, \beta_0(z) = \frac{2}{z} \sinh z$

Derivatives

$$5.1.26 \quad \frac{dE_n(z)}{dz} = -E_{n-1}(z) \quad (n=1, 2, 3, \dots)$$

5.1.27

$$\frac{d^n}{dz^n} [e^z E_1(z)] = \frac{d^{n-1}}{dz^{n-1}} [e^z E_1(z)] + \frac{(-1)^n (n-1)!}{z^n} \quad (n=1, 2, 3, \dots)$$

Definite and Indefinite Integrals

(For more extensive tables of integrals see [5.3], [5.6], [5.11], [5.12], [5.13]. For integrals involving $E_n(x)$ see [5.9].)

$$5.1.28 \quad \int_0^\infty \frac{e^{-at}}{b+t} dt = e^{ab} E_1(ab)$$

5.1.29

$$\int_0^\infty \frac{e^{iat}}{b+t} dt = e^{-iab} E_1(-iab) \quad (a > 0, b > 0)$$

5.1.30

$$\int_0^\infty \frac{t-ib}{t^2+b^2} e^{iat} dt = e^{ab} E_1(ab) \quad (a > 0, b > 0)$$

5.1.31

$$\int_0^\infty \frac{t+ib}{t^2+b^2} e^{iat} dt = e^{-ab} (-\text{Ei}(ab) + i\pi) \quad (a > 0, b > 0)$$

5.1.32

$$\int_0^\infty \frac{e^{-at} - e^{-bt}}{t} dt = \ln \frac{b}{a}$$

5.1.33

$$\int_0^\infty E_1^2(t) dt = 2 \ln 2$$

5.1.34

$$\int_0^\infty e^{-at} E_n(t) dt = \frac{(-1)^{n-1}}{a^n} \left[\ln(1+a) + \sum_{k=1}^{n-1} \frac{(-1)^k a^k}{k} \right] \quad (a > -1)$$

5.1.35

$$\int_0^1 \frac{e^{at} \sin bt}{t} dt = \pi - \arctan \frac{b}{a} + \mathcal{I} E_1(-a+ib) \quad (a > 0, b > 0)$$

5.1.36

$$\int_0^1 \frac{e^{-at} \sin bt}{t} dt = \arctan \frac{b}{a} + \mathcal{I} E_1(a+ib) \quad (a > 0, b \text{ real})$$

5.1.37

$$\int_0^1 \frac{e^{at}(1-\cos bt)}{t} dt = \frac{1}{2} \ln \left(1 + \frac{b^2}{a^2} \right) + \text{Ei}(a) + \mathcal{R} E_1(-a+ib) \quad (a > 0, b \text{ real})$$

5.1.38

$$\int_0^1 \frac{e^{-at}(1-\cos bt)}{t} dt = \frac{1}{2} \ln \left(1 + \frac{b^2}{a^2} \right) - E_1(a) + \mathcal{R} E_1(a+ib) \quad (a > 0, b \text{ real})$$

$$5.1.39 \quad \int_0^z \frac{1-e^{-t}}{t} dt = E_1(z) + \ln z + \gamma$$

$$5.1.40 \quad \int_0^x \frac{e^t-1}{t} dt = \text{Ei}(x) - \ln x - \gamma \quad (x > 0)$$

5.1.41

$$\int \frac{e^{ix}}{a^2+x^2} dx = \frac{i}{2a} [e^{-a} E_1(-a-ix) - e^a E_1(a-ix)] + \text{const.}$$

5.1.42

$$\int \frac{x e^{ix}}{a^2+x^2} dx = -\frac{1}{2} [e^{-a} E_1(-a-ix) + e^a E_1(a-ix)] + \text{const.}$$

5.1.43

$$\int \frac{e^x}{a^2+x^2} dx = -\frac{1}{a} \mathcal{I} (e^{ia} E_1(-x+ia)) + \text{const.} \quad (a > 0)$$

5.1.44

$$\int \frac{x e^x}{a^2+x^2} dx = -\mathcal{R} (e^{ia} E_1(-x+ia)) + \text{const.} \quad (a > 0)$$

Relation to Incomplete Gamma Function (see 6.5)

$$5.1.45 \quad E_n(z) = z^{n-1} \Gamma(1-n, z)$$

$$5.1.46 \quad \alpha_n(z) = z^{-n-1} \Gamma(n+1, z)$$

$$5.1.47 \quad \beta_n(z) = z^{-n-1} [\Gamma(n+1, -z) - \Gamma(n+1, z)]$$

Relation to Spherical Bessel Functions (see 10.2)

$$5.1.48 \quad \alpha_0(z) = \sqrt{\frac{2}{\pi z}} K_{1/2}(z), \quad \beta_0(z) = \sqrt{\frac{2\pi}{z}} I_{1/2}(z)$$

$$5.1.49 \quad \alpha_1(z) = \sqrt{\frac{2}{\pi z}} K_{3/2}(z), \quad \beta_1(z) = -\sqrt{\frac{2\pi}{z}} I_{3/2}(z)$$

Number-Theoretic Significance of $\text{li}(x)$

(Assuming Riemann's hypothesis that all non-real zeros of $\zeta(z)$ have a real part of $\frac{1}{2}$)

5.1.50 $\text{li}(x) - \pi(x) = O(\sqrt{x} \ln x)$ ($x \rightarrow \infty$)

$\pi(x)$ is the number of primes less than or equal to x .

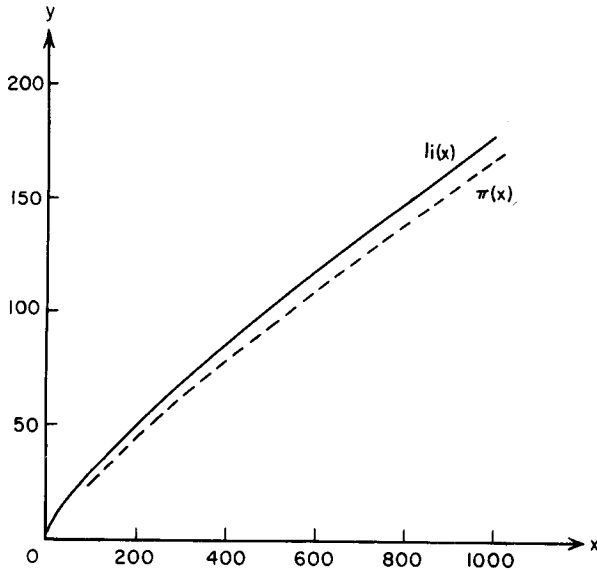

FIGURE 5.5. $y = \text{li}(x)$ and $y = \pi(x)$

Asymptotic Expansion

5.1.51

$$E_n(z) \sim \frac{e^{-z}}{z} \left\{ 1 - \frac{n}{z} + \frac{n(n+1)}{z^2} - \frac{n(n+1)(n+2)}{z^3} + \dots \right\}$$

($|\arg z| < \frac{3}{2}\pi$)

Representation of $E_n(x)$ for Large n

5.1.52

$$E_n(x) = \frac{e^{-x}}{x+n} \left\{ 1 + \frac{n}{(x+n)^2} + \frac{n(n-2x)}{(x+n)^4} + \frac{n(6x^2 - 8nx + n^2)}{(x+n)^6} + R(n, x) \right\}$$

$$-.36n^{-4} \leq R(n, x) \leq \left(1 + \frac{1}{x+n-1} \right) n^{-4} \quad (x > 0)$$

Polynomial and Rational Approximations⁶

5.1.53

$$0 \leq x \leq 1$$

$$E_1(x) + \ln x = a_0 + a_1x + a_2x^2 + a_3x^3 + a_4x^4 + a_5x^5 + \epsilon(x)$$

$$|\epsilon(x)| < 2 \times 10^{-7}$$

⁶ The approximation 5.1.53 is from E. E. Allen, Note 169, MTAC 8, 240 (1954); approximations 5.1.54 and 5.1.56 are from C. Hastings, Jr., Approximations for digital computers, Princeton Univ. Press, Princeton, N.J., 1955; approximation 5.1.55 is from C. Hastings, Jr., Note 143, MTAC 7, 68 (1953) (with permission).

$$a_0 = -.57721\ 566 \quad a_3 = .05519\ 968$$

$$a_1 = .99999\ 193 \quad a_4 = -.00976\ 004$$

$$a_2 = -.24991\ 055 \quad a_5 = .00107\ 857$$

5.1.54

$$1 \leq x < \infty$$

$$xe^x E_1(x) = \frac{x^2 + a_1x + a_2}{x^2 + b_1x + b_2} + \epsilon(x)$$

$$|\epsilon(x)| < 5 \times 10^{-5}$$

$$a_1 = 2.334733 \quad b_1 = 3.330657$$

$$a_2 = .250621 \quad b_2 = 1.681534$$

5.1.55

$$10 \leq x < \infty$$

$$xe^x E_1(x) = \frac{x^2 + a_1x + a_2}{x^2 + b_1x + b_2} + \epsilon(x)$$

$$|\epsilon(x)| < 10^{-7}$$

$$a_1 = 4.03640 \quad b_1 = 5.03637$$

$$a_2 = 1.15198 \quad b_2 = 4.19160$$

5.1.56

$$1 \leq x < \infty$$

$$xe^x E_1(x) = \frac{x^4 + a_1x^3 + a_2x^2 + a_3x + a_4}{x^4 + b_1x^3 + b_2x^2 + b_3x + b_4} + \epsilon(x)$$

$$|\epsilon(x)| < 2 \times 10^{-8}$$

$$a_1 = 8.57332\ 87401 \quad b_1 = 9.57332\ 23454$$

$$a_2 = 18.05901\ 69730 \quad b_2 = 25.63295\ 61486$$

$$a_3 = 8.63476\ 08925 \quad b_3 = 21.09965\ 30827$$

$$a_4 = .26777\ 37343 \quad b_4 = 3.95849\ 69228$$

5.2. Sine and Cosine Integrals

Definitions

5.2.1

$$\text{Si}(z) = \int_0^z \frac{\sin t}{t} dt$$

5.2.2⁶

$$\text{Ci}(z) = \gamma + \ln z + \int_0^z \frac{\cos t - 1}{t} dt \quad (|\arg z| < \pi)$$

5.2.3⁷

$$\text{Shi}(z) = \int_0^z \frac{\sinh t}{t} dt$$

5.2.4⁷

$$\text{Chi}(z) = \gamma + \ln z + \int_0^z \frac{\cosh t - 1}{t} dt \quad (|\arg z| < \pi)$$

⁶ Some authors [5.14], [5.16] use the entire function $\int_0^z (1 - \cos t) dt/t$ as the basic function and denote it by $\text{Cin}(z)$. We have

$$\text{Cin}(z) = -\text{Ci}(z) + \ln z + \gamma.$$

⁷ The notations $\text{Sih}(z) = \int_0^z \sinh t dt/t$, $\text{Cinh}(z) = \int_0^z (\cosh t - 1) dt/t$ have also been proposed [5.14.]

$$5.2.5 \quad \text{si}(z) = \text{Si}(z) - \frac{\pi}{2}$$

Auxiliary Functions

$$5.2.6 \quad f(z) = \text{Ci}(z) \sin z - \text{si}(z) \cos z$$

$$5.2.7 \quad g(z) = -\text{Ci}(z) \cos z - \text{si}(z) \sin z$$

Sine and Cosine Integrals in Terms of Auxiliary Functions

$$5.2.8 \quad \text{Si}(z) = \frac{\pi}{2} - f(z) \cos z - g(z) \sin z$$

$$5.2.9 \quad \text{Ci}(z) = f(z) \sin z - g(z) \cos z$$

Integral Representations

$$5.2.10 \quad \text{si}(z) = - \int_0^{\frac{\pi}{2}} e^{-z \cos t} \cos(z \sin t) dt$$

$$5.2.11 \quad \text{Ci}(z) + E_1(z) = \int_0^{\frac{\pi}{2}} e^{-z \cos t} \sin(z \sin t) dt$$

$$5.2.12 \quad f(z) = \int_0^{\infty} \frac{\sin t}{t+z} dt = \int_0^{\infty} \frac{e^{-zt}}{t^2+1} dt \quad (\Re z > 0)$$

$$5.2.13 \quad g(z) = \int_0^{\infty} \frac{\cos t}{t+z} dt = \int_0^{\infty} \frac{te^{-zt}}{t^2+1} dt \quad (\Re z > 0)$$

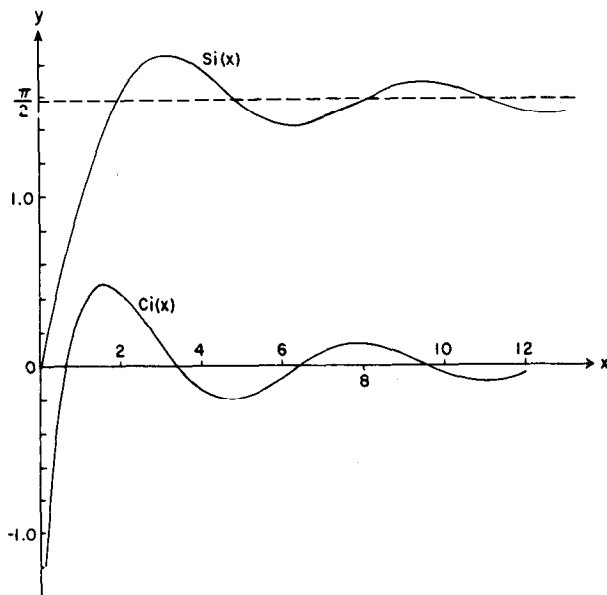

FIGURE 5.6. $y = \text{Si}(x)$ and $y = \text{Ci}(x)$

Series Expansions

$$5.2.14 \quad \text{Si}(z) = \sum_{n=0}^{\infty} \frac{(-1)^n z^{2n+1}}{(2n+1)(2n+1)!}$$

$$5.2.15 \quad \text{Si}(z) = \pi \sum_{n=0}^{\infty} J_{n+\frac{1}{2}}^2\left(\frac{z}{2}\right)$$

$$5.2.16 \quad \text{Ci}(z) = \gamma + \ln z + \sum_{n=1}^{\infty} \frac{(-1)^n z^{2n}}{2n(2n)!}$$

$$5.2.17 \quad \text{Shi}(z) = \sum_{n=0}^{\infty} \frac{z^{2n+1}}{(2n+1)(2n+1)!}$$

$$5.2.18 \quad \text{Chi}(z) = \gamma + \ln z + \sum_{n=1}^{\infty} \frac{z^{2n}}{2n(2n)!}$$

Symmetry Relations

$$5.2.19 \quad \text{Si}(-z) = -\text{Si}(z), \quad \text{Si}(\bar{z}) = \overline{\text{Si}(z)}$$

5.2.20

$$\text{Ci}(-z) = \text{Ci}(z) - i\pi \quad (0 < \arg z < \pi)$$

$$\text{Ci}(\bar{z}) = \overline{\text{Ci}(z)}$$

Relation to Exponential Integral

5.2.21

$$\text{Si}(z) = \frac{1}{2i} [E_1(iz) - E_1(-iz)] + \frac{\pi}{2} \quad (|\arg z| < \frac{\pi}{2})$$

$$5.2.22 \quad \text{Si}(ix) = \frac{i}{2} [\text{Ei}(x) + E_1(x)] \quad (x > 0)$$

5.2.23

$$\text{Ci}(z) = -\frac{1}{2} [E_1(iz) + E_1(-iz)] \quad (|\arg z| < \frac{\pi}{2})$$

$$5.2.24 \quad \text{Ci}(ix) = \frac{1}{2} [\text{Ei}(x) - E_1(x)] + i\frac{\pi}{2} \quad (x > 0)$$

Value at Infinity

$$5.2.25 \quad \lim_{x \rightarrow \infty} \text{Si}(x) = \frac{\pi}{2}$$

Integrals

(For more extensive tables of integrals see [5.3], [5.6], [5.11], [5.12], [5.13].)

$$5.2.26 \quad \int_z^{\infty} \frac{\sin t}{t} dt = -\text{si}(z) \quad (|\arg z| < \pi)$$

$$5.2.27 \quad \int_z^{\infty} \frac{\cos t}{t} dt = -\text{Ci}(z) \quad (|\arg z| < \pi)$$

$$5.2.28 \quad \int_0^{\infty} e^{-at} \text{Ci}(t) dt = -\frac{1}{2a} \ln(1+a^2) \quad (\Re a > 0)^*$$

$$5.2.29 \quad \int_0^{\infty} e^{-at} \text{si}(t) dt = -\frac{1}{a} \arctan a \quad (\Re a > 0)$$

$$5.2.30 \quad \int_0^{\infty} \cos t \text{Ci}(t) dt = \int_0^{\infty} \sin t \text{si}(t) dt = -\frac{\pi}{4}$$

*See page 11.

5.2.31 $\int_0^\infty \text{Ci}^2(t) dt = \int_0^\infty \text{si}^2(t) dt = \frac{\pi}{2}$

5.2.32* $\int_0^\infty \text{Ci}(t) \text{si}(t) dt = \ln 2$

5.2.33 $\int_0^1 \frac{(1-e^{-at}) \cos bt}{t} dt = \frac{1}{2} \ln \left(1 + \frac{a^2}{b^2} \right) + \text{Ci}(b)$
 $+ \mathcal{O}E_1(a+ib)$ (a real, $b > 0$)

Asymptotic Expansions

5.2.34 $f(z) \sim \frac{1}{z} \left(1 - \frac{2!}{z^2} + \frac{4!}{z^4} - \frac{6!}{z^6} + \dots \right)$ ($|\arg z| < \pi$)

5.2.35 $g(z) \sim \frac{1}{z^2} \left(1 - \frac{3!}{z^2} + \frac{5!}{z^4} - \frac{7!}{z^6} + \dots \right)$ ($|\arg z| < \pi$)

Rational Approximations⁸

5.2.36 $1 \leq x < \infty$

$$f(x) = \frac{1}{x} \left(\frac{x^4 + a_1 x^2 + a_2}{x^4 + b_1 x^2 + b_2} \right) + \epsilon(x)$$

$$|\epsilon(x)| < 2 \times 10^{-4}$$

$a_1 = 7.241163$	$b_1 = 9.068580$
$a_2 = 2.463936$	$b_2 = 7.157433$

5.2.37 $1 \leq x < \infty$

$$g(x) = \frac{1}{x^2} \left(\frac{x^4 + a_1 x^2 + a_2}{x^4 + b_1 x^2 + b_2} \right) + \epsilon(x)$$

$$|\epsilon(x)| < 10^{-4}$$

$a_1 = 7.547478$	$b_1 = 12.723684$	*
$a_2 = 1.564072$	$b_2 = 15.723606$	*

5.2.38 $1 \leq x < \infty$

$$f(x) = \frac{1}{x} \left(\frac{x^8 + a_1 x^6 + a_2 x^4 + a_3 x^2 + a_4}{x^8 + b_1 x^6 + b_2 x^4 + b_3 x^2 + b_4} \right) + \epsilon(x)$$

$$|\epsilon(x)| < 5 \times 10^{-7}$$

$a_1 = 38.027264$	$b_1 = 40.021433$
$a_2 = 265.187033$	$b_2 = 322.624911$
$a_3 = 335.677320$	$b_3 = 570.236280$
$a_4 = 38.102495$	$b_4 = 157.105423$

5.2.39 $1 \leq x < \infty$

$$g(x) = \frac{1}{x^2} \left(\frac{x^8 + a_1 x^6 + a_2 x^4 + a_3 x^2 + a_4}{x^8 + b_1 x^6 + b_2 x^4 + b_3 x^2 + b_4} \right) + \epsilon(x)$$

$$|\epsilon(x)| < 3 \times 10^{-7}$$

$a_1 = 42.242855$	$b_1 = 48.196927$
$a_2 = 302.757865$	$b_2 = 482.485984$
$a_3 = 352.018498$	$b_3 = 1114.978885$
$a_4 = 21.821899$	$b_4 = 449.690326$

Numerical Methods

5.3. Use and Extension of the Tables

Example 1. Compute Ci (.25) to 5D. From Tables 5.1 and 4.2 we have

$$\frac{\text{Ci}(.25) - \ln(.25) - \gamma}{(.25)^2} = -.249350,$$

$$\text{Ci}(.25) = (.25)^2(-.249350) + (-1.38629) + .577216 = -.82466.$$

Example 2. Compute Ei (8) to 5S.

From Table 5.1 we have $xe^{-x}\text{Ei}(x) = 1.18185$ for $x=8$. From Table 4.4, $e^8 = 2.98096 \times 10^3$. Thus $\text{Ei}(8) = 440.38$.

⁸See page II.

⁸From C. Hastings, Jr., Approximations for digital computers, Princeton Univ. Press, Princeton, N.J., 1955 (with permission).

Example 3. Compute Si (20) to 5D.

Since $1/20 = .05$ from Table 5.2 we find $f(20) = .049757$, $g(20) = .002464$. From Table 4.8, $\sin 20 = .912945$, $\cos 20 = .408082$. Using 5.2.8

$$\begin{aligned} \text{Si}(20) &= \frac{\pi}{2} - f(20) \cos 20 - g(20) \sin 20 \\ &= 1.570796 - .022555 = 1.54824. \end{aligned}$$

Example 4. Compute $E_n(x)$, $n=1(1)N$, to 5S for $x=1.275$, $N=10$.

If x is less than about five, the recurrence relation 5.1.14 can be used in increasing order of n without serious loss of accuracy.

By quadratic interpolation in Table 5.1 we get $E_1(1.275) = .1408099$, and from Table 4.4, $e^{-1.275} = .2794310$. The recurrence formula 5.1.14 then yields

n	$E_n(1.275)$	$E_n(1.275)$
1	.1408099	6 .0430168
2	.0998984	7 .0374307
3	.0760303	8 .0331009
4	.0608307	9 .0296534
5	.0504679	10 .0268469

Interpolating directly in Table 5.4 for $n=10$ we get $E_{10}(1.275)=.0268470$ as a check.

Example 5. Compute $E_n(x)$, $n=1(1)N$, to 5S for $x=10$, $N=10$.

If, as in this example, x is appreciably larger than five and $N \leq x$, then the recurrence relation 5.1.14 may be safely used in decreasing order of n ([5.5]). From Table 5.5 for $x^{-1}=.1$ we get $(x+10)e^x E_{10}(x)=1.02436$ so that $E_{10}(10)=2.32529 \times 10^{-6}$. Using this as the initial value we obtain column (2).

n	$10^6 E_n(10)$ (1)	$10^6 E_n(10)$ (2)
1	.41570	.41570
2	.38300	.38302
3	.35500	.35488
4	.33000	.33041
5	.31000	.30898
6	.28800	.29005
7	.27667	.27325
8	.25333	.25822
9	.25084	.24472
10	.22573	.23253

From Table 5.2 we get $xe^x E_1(x)=.915633$ so that $E_1(10)=4.15697 \times 10^{-6}$ as a check. Forward recurrence starting with $E_1(10)=4.1570 \times 10^{-6}$ yields the values in column (1). The underlined figures are in error.

Example 6. Compute $E_n(x)$, $n=1(1)N$, to 5S for $x=12.3$, $N=20$.

If N is appreciably larger than x , and x appreciably larger than five, then the recurrence relation 5.1.14 should be used in the backward direction to generate $E_n(x)$ for $n < n_0$, and in the forward direction to generate $E_n(x)$ for $n > n_0$, where $n_0 = \langle x \rangle$.

From 5.1.52, with $n_0=12$, $x=12.3$, we have

$$E_{n_0}(x) = \frac{e^{-12.3}}{24.3} (1 + .02032 - .00043 - .00001) = 1.91038 \times 10^{-7}.$$

Using the recurrence relation 5.1.14, as indicated, we get

n	$10^6 E_n(12.3)$	$10^6 E_n(12.3)$	n
12	.191038	.191038	12
11	.199213	.183498	13
10	.208098	.176516	14
9	.217793	.170042	15
8	.228406	.164015	16
7	.240073	.158397	17
6	.252951	.153144	18
5	.267234	.148226	19
4	.283155	.143608	20
3	.300998		
2	.321117		
1	.343953		

From Tables 5.2 and 5.5 we find $E_1(12.3)=.343953 \times 10^{-6}$, $E_{20}(12.3)=.143609 \times 10^{-6}$ as a check.

Example 7. Compute $\alpha_n(2)$ to 6S for $n=1(1)5$.

The recurrence formula 5.1.15 can be used for all $x > 0$ in increasing order of n without loss of accuracy. From 5.1.25 we have $\alpha_0(2) = \frac{1}{2} e^{-2} = .0676676$, so we get

n	$\alpha_n(2)$
0	.0676676
1	.101501
2	.169169
3	.321421
4	.710510
5	1.84394

Independent calculation with 5.1.8 yields the same result for $\alpha_5(2)$.

The functions $\alpha_0(x)$ and $\alpha_1(x)$ can be obtained from Table 10.8 using 5.1.48, 5.1.49.

Example 8. Compute $\beta_n(x)$, $n=0(1)N$ to 6S for $x=1$, $N=5$.

Use the recurrence relation 5.1.16 in increasing order of n if

$$x > .368N + .184 \ln N + .821$$

and in decreasing order of n otherwise [5.5].

From 5.1.9 with $n=5$ we get $\beta_5(1) = -.324297$ correctly rounded to 6D. Using the recurrence formula 5.1.16 in decreasing order of n and carrying 9D we get the values in column (2).

n	$\beta_n(1)$ (1)	$\beta_n(1)$ (2)
0	2.35040 2	2.35040 2389
1	-.73575 9269	-.73575 8880
2	.87888 3849	.87888 4629
3	-.44950 9722	-.44950 7383
4	.55236 3499	.55237 2854
5	-.32434 3774	-.32429 7

Using forward recurrence instead, starting with

$\beta_0(1)=2 \sinh 1=2.350402$ and again carrying 9D, we obtain column (1). The underlined figures are in error. The above shows that three significant figures are lost in forward recurrence, whereas about three significant figures are gained in backward recurrence!

An alternative procedure is to start with an arbitrary value for n sufficiently large (see also [5.1]). To illustrate, starting with the value zero at $n=11$ we get

n	$\beta_n(1)$	n	$\beta_n(1)$
11	0.	5	-.324297
10	.280560	4	.552373
9	-.206984	3	-.449507
8	.319908	2	.878885
7	-.253812	1	-.735759
6	.404621	0	2.350402

The functions $\beta_0(x)$ and $\beta_1(x)$ can be obtained from Table 10.8 using 5.1.48, 5.1.49.

Example 9. Compute $E_1(z)$ for $z=3.2578+6.8943i$.

From Table 5.6 we have for $z_0=x_0+iy_0=3+7i$

$$z_0 e^{z_0} E_1(z_0) = .934958 + .095598i,$$

$$e^{z_0} E_1(z_0) = .059898 - .107895i.$$

From Taylor's formula with $f(z)=e^z E_1(z)$ we have

$$f(z) = f(z_0 + \Delta z) = f(z_0) + \frac{f'(z_0)}{1!} \Delta z$$

$$+ \frac{f''(z_0)}{2!} (\Delta z)^2 + \dots$$

with $\Delta z = z - z_0 = .2578 - .1057i$. Thus with 5.1.27 we get

k	$f^{(k)}(z_0)/k!$	$(\Delta z)^k f^{(k)}(z_0)/k!$
0	.059898 - .107895i	.059898 - .107895i
1	.008174 + .012795i	.003460 + .002435i
2	-.001859 + .000155i	-.000094 + .000110i
3	.000088 - .000212i	-.000003 - .000004i

$$f(z) = .063261 - .105354i$$

$$e^{-z} = .031510 - .022075i$$

$$E_1(z) = -.000332 - .004716i$$

Repeating the calculation with $z_0=3+6i$ and $\Delta z = .2578 + .8943i$ we get the same result.

An alternative procedure is to perform bivariate interpolation in the real and imaginary parts of $z e^z E_1(z)$.

Example 10. Compute $E_1(z)$ for $z=-4.2+12.7i$.

Using the formula at the bottom of Table 5.6

$$e^z E_1(z) \approx \frac{.711093}{-3.784225 + 12.7i}$$

$$+ \frac{.278518}{-1.90572 + 12.7i} + \frac{.010389}{2.0900 + 12.7i}$$

$$= -.0184106 - .0736698i$$

$$E_1(z) \approx -1.87133 - 4.70540i.$$

References

Texts

[5.1] F. J. Corbató, On the computation of auxiliary functions for two-center integrals by means of a high-speed computer, *J. Chem. Phys.* **24**, 452-453 (1956).

[5.2] A. Erdélyi et al., Higher transcendental functions, vol. 2 (McGraw-Hill Book Co., Inc., New York, N.Y., 1953).

[5.3] A. Erdélyi et al., Tables of integral transforms, vols. 1, 2 (McGraw-Hill Book Co., Inc., New York, N.Y., 1954).

[5.4] W. Gautschi, Some elementary inequalities relating to the gamma and incomplete gamma function, *J. Math. Phys.* **38**, 77-81 (1959).

[5.5] W. Gautschi, Recursive computation of certain integrals, *J. Assoc. Comput. Mach.* **8**, 21-40 (1961).

[5.6] W. Gröbner and N. Hofreiter, *Integraltafel* (Springer-Verlag, Wien and Innsbruck, Austria, 1949-50).

[5.7] C. Hastings, Jr., *Approximations for digital computers* (Princeton Univ. Press, Princeton, N.J., 1955).

[5.8] E. Hopf, *Mathematical problems of radiative equilibrium*, Cambridge Tracts in Mathematics and Mathematical Physics, No. 31 (Cambridge Univ. Press, Cambridge, England, 1934).

[5.9] V. Kourganoff, *Basic methods in transfer problems* (Oxford Univ. Press, London, England, 1952).

[5.10] F. Löscher and F. Schoblik, *Die Fakultät und verwandte Funktionen* (B. G. Teubner, Leipzig, Germany, 1951).

[5.11] N. Nielsen, *Theorie des Integrallogarithmus* (B. G. Teubner, Leipzig, Germany, 1906).

- [5.12] F. Oberhettinger, Tabellen zur Fourier Transformation (Springer-Verlag, Berlin, Göttingen, Heidelberg, Germany, 1957).
- [5.13] I. M. Ryshik and I. S. Gradstein, Tables of series, products and integrals (VEB Deutscher Verlag der Wissenschaften, Berlin, Germany, 1957).
- [5.14] S. A. Schelkunoff, Proposed symbols for the modified cosine and exponential integral, Quart. Appl. Math. **2**, 90 (1944).
- [5.15] J. Todd, Evaluation of the exponential integral for large complex arguments, J. Research NBS **52**, 313-317 (1954) RP 2508.
- [5.16] F. G. Tricomi, Funzioni ipergeometriche confluenti (Edizioni Cremonese, Rome, Italy, 1954).

Tables

- [5.17] British Association for the Advancement of Science, Mathematical Tables, vol. I. Circular and hyperbolic functions, exponential, sine and cosine integrals, etc., 3d ed. (Cambridge Univ. Press, Cambridge, England, 1951). $Ei(x) - \ln x$, $-E_1(x) - \ln x$, $Ci(x) - \ln x$, $Si(x)$, $x=0(.1)5$, 11D; $Ei(x)$, $x=5(.1)15$, 10-11S; $E_1(x)$, $x=5(.1)15$, 13-14D; $Si(x)$, $Ci(x)$, $x=5(.1)20(.2)40$, 10D.
- [5.18] L. Fox, Tables of Weber parabolic cylinder functions and other functions for large arguments, Mathematical Tables, vol. 4, National Physical Laboratory (Her Majesty's Stationery Office, London, England, 1960). $e^{-x}Ei(x)$, $e^xE_1(x)$, $x^{-1}=0(.001).1$, 10D; $f(x)$, $g(x)$, $x^{-1}=0(.001).1$, 10D.
- [5.19] J. W. L. Glaisher, Tables of the numerical values of the sine-integral, cosine-integral and exponential integral, Philos. Trans. Roy. Soc. London **160**, 367-388 (1870). $Si(x)$, $Ci(x)$, $Ei(x)$, $-E_1(x)$, $x=0(.01)1$, 18D, $x=1(.1)5(1)15$, 11D.
- [5.20] B. S. Gourary and M. E. Lynam, Tables of the auxiliary molecular integrals $A_n(x)$ and the auxiliary functions $C_n(x)$, The Johns Hopkins Univ. Applied Physics Laboratory, CM Report 905, Baltimore, Md. (1957). $\alpha_n(x)$, $n!e_n(x)$, $x=.05(.05)15$, $n=0(1)18$, 9S.
- [5.21] F. E. Harris, Tables of the exponential integral $Ei(x)$, Math. Tables Aids Comp. **11**, 9-16 (1957). $E_1(x)$, $e^xE_1(x)$, $Ei(x)$, $e^{-x}Ei(x)$, $x=1(1)4(.4)8(1)50$, 18-19S.
- [5.22] Harvard University, The Annals of the Computation Laboratory, vols. 18, 19; Tables of the generalized sine- and cosine-integral functions, parts I, II (Harvard Univ. Press, Cambridge, Mass., 1949). $S(a, x) = \int_0^x \frac{\sin u}{u} dx$, $C(a, x) = \int_0^x \frac{1 - \cos u}{u} dx$, 6D; $Ss(a, x) = \int_0^x \frac{\sin u}{u} \sin x dx$, $Sc(a, x) = \int_0^x \frac{\sin u}{u} \cos x dx$, 6D; $Cs(a, x) = \int_0^x \frac{\cos u}{u} \sin x dx$, $Cc(a, x) = \int_0^x \frac{\cos u}{u} (1 - \cos x) dx$, 6D; $u = \sqrt{x^2 + a^2}$, $0 \leq a < 25$, $0 \leq x \leq 25$.
- [5.23] Harvard University, The Annals of the Computation Laboratory, vol. 21; Tables of the generalized exponential-integral functions (Harvard Univ. Press, Cambridge, Mass., 1949). $E(a, x) = \int_0^x \frac{1 - e^{-u}}{u} dx$, $Es(a, x) = \int_0^x \frac{e^{-u} \sin u}{u} dx$, $Ec(a, x) = \int_0^x \frac{1 - e^{-u} \cos u}{u} dx$, 6D; $u = \sqrt{x^2 + a^2}$, $0 \leq a < 10$, $0 \leq x < 10$.
- [5.24] A. V. Hershey, Computing programs for the complex exponential integral, U.S. Naval Proving Ground, Dahlgren, Va., NPG Report No. 1646 (1959). $-E_1(-z)$, $z = x + iy$, $x = -20(1)20$, $y = 0(1)20$, 13S.
- [5.25] E. Jahnke and F. Emde, Tables of functions, 4th ed. (Dover Publications, Inc., New York, N.Y., 1945). $-E_1(x)$, $Ei(x)$, $x=0(.01)1(.1)5(1)15$, 4-6S; $Si(x)$, $Ci(x)$, $x=0(.01)1(.1)5(1)15(5)100(10)200(100)10^3(10)^7$, generally 4-5S; maxima and minima of $Ci(x)$ and $si(x)$, $0 < x < 16$, 5S.
- [5.26] K. A. Karpov and S. N. Razumovskii, Tablitsy integral' nogo logarifma (Izdat. Akad. Nauk SSSR., Moscow, U.S.S.R., 1956). $li(x)$, $x=0(.0001)2.5(.001)20(.01)200(.1)500(1)10000(10)25000$, 7S; $li(x) - \ln |1-x|$, $x=.95(.0001)1.05$, 6D.
- [5.27] M. Kotani, A. Amemiya, E. Ishiguro, T. Kimura, Table of molecular integrals (Maruzen Co., Ltd., Tokyo, Japan, 1955). $\alpha_n(x)$, $x=.25(.25)9(.5)19(1)25$, $n=0(1)15$, 11S; $\beta_n(x)$, $x=.25(.25)8(.5)19(1)25$, $n=0(1)8$, 11S.
- [5.28] M. Mashiko, Tables of generalized exponential, sine- and cosine-integrals, Numerical Computation Bureau Report No. 7, Tokyo, Japan (1953). $E_1(z) + \ln |z| = C_\alpha(\xi) + \ln \xi - iS_\alpha(\xi)$, $z = \xi e^{i\alpha}$, $\xi = 0(.05)5$, $\alpha = 0^\circ(2^\circ)60^\circ(1^\circ)90^\circ$, 6D; $ze^z E_1(z) = A_\alpha(\eta) \exp[i\Phi_\alpha(\eta)]$, $z = \frac{1}{\eta} e^{i\alpha}$, $\eta = .01(.01).2$, $\alpha = 0^\circ(2^\circ)60^\circ(1^\circ)90^\circ$, 5-6D.
- [5.29] G. F. Miller, Tables of generalized exponential integrals, Mathematical Tables, vol. 3, National Physical Laboratory (Her Majesty's Stationery Office, London, England, 1958). $(x+n)e^xE_n(x)$, $x=0(.01)1$, $n=1(1)8$, $x=0(1)20$, $n=1(1)24$, $x^{-1}=0(.001).05$, $n=1(1)24$; 8D.
- [5.30] J. Miller, J. M. Gerhauser, and F. A. Matsen, Quantum chemistry integrals and tables (Univ. of Texas Press, Austin, Tex., 1959). $\alpha_n(x)$, $x=.125(.125)25$, $n=0(1)16$, 14S; $\beta_n(x)$, $x=0(.125)24.875$, $n=0(1)16$, 12-14S.
- [5.31] J. Miller and R. P. Hurst, Simplified calculation of the exponential integral, Math. Tables Aids Comp. **12**, 187-193 (1958). $e^{-x}Ei(x)$, $Ei(x)$, $e^xE_1(x)$, $E_1(x)$, $x=.2(.05)5(.1)10(.2)20(.5)50(1)80$; 16S.
- [5.32] National Bureau of Standards, Tables of sine, cosine and exponential integrals, vol. I (U.S. Government Printing Office, Washington, D.C., 1940). $Si(x)$, $Ci(x)$, $Ei(x)$, $E_1(x)$, $x=0(.0001)2$, $x=0(1)10$; 9D.
- [5.33] National Bureau of Standards, Tables of sine, cosine and exponential integrals, vol. II (U.S. Government Printing Office, Washington, D.C., 1940). $Si(x)$, $Ci(x)$, $Ei(x)$, $E_1(x)$, $x=0(.001)10$, 9-10 D or S; $Si(x)$, $Ci(x)$, $x=10(.1)40$, 10D; $Ei(x)$, $E_1(x)$, $x=10(.1)15$, 7-11S.

- [5.34] National Bureau of Standards, Table of sine and cosine integrals for arguments from 10 to 100, Applied Math. Series 32 (U.S. Government Printing Office, Washington, D.C., 1954). $\text{Si}(x)$, $\text{Ci}(x)$, $x=10(.01)100$, 10D.
- [5.35] National Bureau of Standards, Tables of functions and of zeros of functions, Collected short tables of the Computation Laboratory, Applied Math. Series 37 (U.S. Government Printing Office, Washington, D.C., 1954). $E_n(x)$, $n=0(1)20$, $x=0(.01)2(.1)10$, 4-9S; $E_2(x)-x \ln x$, $x=0(.01).5$, 7S; $E_3(x)+\frac{1}{2}x^2 \ln x$, $x=0(.01).1$, 7S.
- [5.36] National Bureau of Standards, Tables of the exponential integral for complex arguments, Applied Math. Series 51 (U.S. Government Printing Office, Washington, D.C., 1958). $E_1(z)+\ln z$, 6D, $x=0(.02)1$, $y=0(.02)1$, $x=-1(.1)0$, $y=0(.1)1$; $E_1(z)$, 6D, $x=0(.02)4$, $y=0(.02)3(.05)10$, $x=0(1)20$, $y=0(1)20$, $x=-3.1(.1)0$, $y=0(.1)3.1$, $x=-4.5(.5)0$, $y=0(.1)4(.5)10$, $x=-10(.5)-4.5$, $y=0(.5)10$, $x=-20(1)0$, $y=0(1)20$; $e^z E_1(z)$, 6D, $x=4(.1)10$, $y=0(.5)10$.
- [5.37] S. Oberländer, Tabellen von Exponentialfunktionen und-integralen zur Anwendung auf Gebieten der Thermodynamik, Halbleitertheorie und Gaskinetik (Akademie-Verlag, Berlin, Germany, 1959). $\frac{\Delta E}{kT}$, $\frac{kT}{\Delta E}$, $\exp\left(\frac{-\Delta E}{kT}\right)$, $\frac{kT}{\Delta E} \exp\left(\frac{-\Delta E}{kT}\right)$, $E_1\left(\frac{\Delta E}{kT}\right)$, $\frac{k}{\Delta E} \int_0^T \exp\left(\frac{-\Delta E}{kT}\right) dT$, $\frac{\Delta E}{kT} \exp\left(\frac{\Delta E}{kT}\right) \times$
- $E_1\left(\frac{\Delta E}{kT}\right)$, $1 - \frac{\Delta E}{kT} \exp\left(\frac{\Delta E}{kT}\right) E_1\left(\frac{\Delta E}{kT}\right)$; $\Delta E = .2(.2)2$, $T = 25(25)1000$, $T = 150(10)390$, 3-4S; x^{-1} , $\exp(-x^{-1})$, $x \exp(-x^{-1})$, $E_1(x^{-1})$, $\int_0^x \exp(-t^{-1}) dt$, $x^{-1} \exp(x^{-1}) E_1(x^{-1})$, $1 - x^{-1} \exp(x^{-1}) E_1(x^{-1})$; $x = .01(.0001).1$, 5-6S.
- [5.38] V. I. Pagurova, Tables of the exponential integral $E_\nu(x) = \int_1^\infty e^{-xu} u^{-\nu} du$. Translated from the Russian by D. G. Fry (Pergamon Press, New York, N.Y.; Oxford, London, England; Paris, France, 1961). $E_n(x)$, $n=0(1)20$, $x=0(.01)2(.1)10$, 4-9S; $E_2(x)-x \ln x$, $x=0(.01)5$, 7S; $E_3(x)+\frac{1}{2}x^2 \ln x$, $x=0(.01).1$, 7S; $e^x E_n(x)$, $n=2(1)10$, $x=10(.1)20$, 7D; $e^x E_\nu(x)$, $\nu=0(.1)1$, $x=.01(.01)7(.05)12(.1)20$, 7 S or D.
- [5.39] Tablitsy integral'nogo sinusa i kosinusa (Izdat. Akad. Nauk SSSR., Moscow, U.S.S.R., 1954). $\text{Si}(x)$, $\text{Ci}(x)$, $x=0(.0001)2(.001)10(.005)100$, 7D; $\text{Ci}(x)-\ln x$, $x=0(.0001).01$, 7D.
- [5.40] Tablitsy integral'noi pokazatel'noi funktsii (Izdat. Akad. Nauk SSSR., Moscow, U.S.S.R., 1954). $\text{Ei}(x)$, $E_1(x)$, $x=0(.0001)1.3(.001)3(.0005)10(.1)15$, 7D.
- [5.41] D. K. Trubey, A table of three exponential integrals, Oak Ridge National Laboratory Report 2750, Oak Ridge, Tenn. (June 1959). $E_1(x)$, $E_2(x)$, $E_3(x)$, $x=0(.0005).1(.001)2(.01)10(.1)20$, 6S.

Table 5.1

SINE, COSINE AND EXPONENTIAL INTEGRALS

x	$x^{-1}\text{Si}(x)$	$x^{-2}[\text{Ci}(x) - \ln x - \gamma]$	$x^{-1}[\text{Ei}(x) - \ln x - \gamma]$	$x^{-1}[\text{E}_1(x) + \ln x + \gamma]$
0.00	1.00000 00000	-0.25000 00000	1.00000 0000	1.00000 00000
0.01	0.99999 44444	-0.24999 89583	1.00250 5566	0.99750 55452
0.02	0.99997 77781	-0.24999 58333	1.00502 2306	0.99502 21392
0.03	0.99995 00014	-0.24999 06250	1.00755 0283	0.99254 97201
0.04	0.99991 11154	-0.24998 33339	1.01008 9560	0.99008 82265
0.05	0.99986 11215	-0.24997 39598	1.01264 0202	0.98763 75971
0.06	0.99980 00216	-0.24996 25030	1.01520 2272	0.98519 77714
0.07	0.99972 78178	-0.24994 89639	1.01777 5836	0.98276 86889
0.08	0.99964 45127	-0.24993 33429	1.02036 0958	0.98035 02898
0.09	0.99955 01094	-0.24991 56402	1.02295 7705	0.97794 25142
0.10	0.99944 46111	-0.24989 58564	1.02556 6141	0.97554 53033
0.11	0.99932 80218	-0.24987 39923	1.02818 6335	0.97315 85980
0.12	0.99920 03455	-0.24985 00480	1.03081 8352	0.97078 23399
0.13	0.99906 15870	-0.24982 40244	1.03346 2259	0.96841 64710
0.14	0.99891 17512	-0.24979 59223	1.03611 8125	0.96606 09336
0.15	0.99875 08435	-0.24976 57422	1.03878 6018	0.96371 56702
0.16	0.99857 88696	-0.24973 34850	1.04146 6006	0.96138 06240
0.17	0.99839 58357	-0.24969 91516	1.04415 8158	0.95905 57383
0.18	0.99820 17486	-0.24966 27429	1.04686 2544	0.95674 09569
0.19	0.99799 66151	-0.24962 42598	1.04957 9234	0.95443 62237
0.20	0.99778 04427	-0.24958 37035	1.05230 8298	0.95214 14833
0.21	0.99755 32390	-0.24954 10749	1.05504 9807	0.94985 66804
0.22	0.99731 50122	-0.24949 63752	1.05780 3833	0.94758 17603
0.23	0.99706 57709	-0.24944 96056	1.06057 0446	0.94531 66684
0.24	0.99680 55242	-0.24940 07674	1.06334 9719	0.94306 13506
0.25	0.99653 42813	-0.24934 98618	1.06614 1726	0.94081 57528
0.26	0.99625 20519	-0.24929 68902	1.06894 6539	0.93857 98221
0.27	0.99595 88464	-0.24924 18540	1.07176 4232	0.93635 35046
0.28	0.99565 46750	-0.24918 47546	1.07459 4879	0.93413 67481
0.29	0.99533 95489	-0.24912 55938	1.07743 8555	0.93192 94997
0.30	0.99501 34793	-0.24906 43727	1.08029 5334	0.92973 17075
0.31	0.99467 64779	-0.24900 10933	1.08316 5293	0.92754 33196
0.32	0.99432 85570	-0.24893 57573	1.08604 8507	0.92536 42845
0.33	0.99396 97288	-0.24886 83662	1.08894 5053	0.92319 45510
0.34	0.99360 00064	-0.24879 89219	1.09185 5008	0.92103 40684
0.35	0.99321 94028	-0.24872 74263	1.09477 8451	0.91888 27858
0.36	0.99282 79320	-0.24865 38813	1.09771 5458	0.91674 06533
0.37	0.99242 56078	-0.24857 82887	1.10066 6108	0.91460 76209
0.38	0.99201 24449	-0.24850 06507	1.10363 0481	0.91248 36388
0.39	0.99158 84579	-0.24842 09693	1.10660 8656	0.91036 86582
0.40	0.99115 36619	-0.24833 92466	1.10960 0714	0.90826 26297
0.41	0.99070 80728	-0.24825 54849	1.11260 6735	0.90616 55048
0.42	0.99025 17063	-0.24816 96860	1.11562 6800	0.90407 72350
0.43	0.98978 45790	-0.24808 18528	1.11866 0991	0.90199 77725
0.44	0.98930 67074	-0.24799 19870	1.12170 9391	0.89992 70693
0.45	0.98881 81089	-0.24790 00913	1.12477 2082	0.89786 50778
0.46	0.98831 88008	-0.24780 61685	1.12784 9147	0.89581 17511
0.47	0.98780 88010	-0.24771 02206	1.13094 0671	0.89376 70423
0.48	0.98728 81278	-0.24761 22500	1.13404 6738	0.89173 09048
0.49	0.98675 67998	-0.24751 22600	1.13716 7432	0.88970 32920
0.50	0.98621 48361	-0.24741 02526	1.14030 2841	0.88768 41584
	$\begin{bmatrix} (-6)1 \\ 4 \end{bmatrix}$	$\begin{bmatrix} (-7)3 \\ 4 \end{bmatrix}$	$\begin{bmatrix} (-6)2 \\ 4 \end{bmatrix}$	$\begin{bmatrix} (-6)2 \\ 4 \end{bmatrix}$

$\gamma = 0.57721 56649$

See Examples 1-2.

SINE, COSINE AND EXPONENTIAL INTEGRALS Table 5.1

x	$Si(x)$	$Ci(x)$	$Ei(x)$	$E_1(x)$
0.50	0.49310 74180	-0.17778 40788	0.45421 9905	0.55977 3595
0.51	0.50268 77506	-0.16045 32390	0.48703 2167	0.54782 2352
0.52	0.51225 15212	-0.14355 37358	0.51953 0633	0.53621 9798
0.53	0.52179 84228	-0.12707 07938	0.55173 0445	0.52495 1510
0.54	0.53132 81492	-0.11099 04567	0.58364 5931	0.51400 3886
0.55	0.54084 03951	-0.09529 95274	0.61529 0657	0.50336 4081
0.56	0.55033 48563	-0.07998 55129	0.64667 7490	0.49301 9959
0.57	0.55981 12298	-0.06503 65744	0.67781 8642	0.48296 0034
0.58	0.56926 92137	-0.05044 14815	0.70872 5720	0.47317 3433
0.59	0.57870 85069	-0.03618 95707	0.73940 9764	0.46364 9849
0.60	0.58812 88096	-0.02227 07070	0.76988 1290	0.45437 9503
0.61	0.59752 98233	-0.00867 52486	0.80015 0320	0.44535 3112
0.62	0.60691 12503	+0.00460 59849	0.83022 6417	0.43656 1854
0.63	0.61627 27944	0.01758 17424	0.86011 8716	0.42799 7338
0.64	0.62561 41603	0.03026 03686	0.88983 5949	0.41965 1581
0.65	0.63493 50541	0.04264 98293	0.91938 6468	0.41151 6976
0.66	0.64423 51831	0.05475 77343	0.94877 8277	0.40358 6275
0.67	0.65351 42557	0.06659 13594	0.97801 9042	0.39585 2563
0.68	0.66277 19817	0.07815 76659	1.00711 6121	0.38830 9243
0.69	0.67200 80721	0.08946 33195	1.03607 6576	0.38095 0010
0.70	0.68122 22391	0.10051 47070	1.06490 7195	0.37376 8843
0.71	0.69041 41965	0.11131 79525	1.09361 4501	0.36675 9981
0.72	0.69958 36590	0.12187 89322	1.12220 4777	0.35991 7914
0.73	0.70873 03430	0.13220 32879	1.15068 4069	0.35323 7364
0.74	0.71785 39660	0.14229 64404	1.17905 8208	0.34671 3279
0.75	0.72695 42472	0.15216 36010	1.20733 2816	0.34034 0813
0.76	0.73603 09067	0.16180 97827	1.23551 3319	0.33411 5321
0.77	0.74508 36664	0.17123 98110	1.26360 4960	0.32803 2346
0.78	0.75411 22494	0.18045 83335	1.29161 2805	0.32208 7610
0.79	0.76311 63804	0.18946 98290	1.31954 1753	0.31627 7004
0.80	0.77209 57855	0.19827 86160	1.34739 6548	0.31059 6579
0.81	0.78105 01921	0.20688 88610	1.37518 1783	0.30504 2539
0.82	0.78997 93293	0.21530 45859	1.40290 1910	0.29961 1236
0.83	0.79888 29277	0.22352 96752	1.43056 1245	0.29429 9155
0.84	0.80776 07191	0.23156 78824	1.45816 3978	0.28910 2918
0.85	0.81661 24372	0.23942 28368	1.48571 4176	0.28401 9269
0.86	0.82543 78170	0.24709 80486	1.51321 5791	0.27904 5070
0.87	0.83423 65953	0.25459 69153	1.54067 2664	0.27417 7301
0.88	0.84300 85102	0.26192 27264	1.56808 8534	0.26941 3046
0.89	0.85175 33016	0.26907 86687	1.59546 7036	0.26474 9496
0.90	0.86047 07107	0.27606 78305	1.62281 1714	0.26018 3939
0.91	0.86916 04808	0.28289 32065	1.65012 6019	0.25571 3758
0.92	0.87782 23564	0.28955 77018	1.67741 3317	0.25133 6425
0.93	0.88645 60839	0.29606 41358	1.70467 6891	0.24704 9501
0.94	0.89506 14112	0.30241 52458	1.73191 9946	0.24285 0627
0.95	0.90363 80880	0.30861 36908	1.75914 5612	0.23873 7524
0.96	0.91218 58656	0.31466 20547	1.78635 6947	0.23470 7988
0.97	0.92070 44970	0.32056 28495	1.81355 6941	0.23075 9890
0.98	0.92919 37370	0.32631 85183	1.84074 8519	0.22689 1167
0.99	0.93765 33420	0.33193 14382	1.86793 4543	0.22309 9826
1.00	0.94608 30704	0.33740 39229	1.89511 7816	0.21938 3934
	$\left[\begin{smallmatrix} (-6)4 \\ 4 \end{smallmatrix} \right]$	$\left[\begin{smallmatrix} (-5)5 \\ 6 \end{smallmatrix} \right]$	$\left[\begin{smallmatrix} (-5)4 \\ 5 \end{smallmatrix} \right]$	$\left[\begin{smallmatrix} (-5)4 \\ 5 \end{smallmatrix} \right]$

Table 5.1 SINE, COSINE AND EXPONENTIAL INTEGRALS

x	$Si(x)$	$Ci(x)$	$Ei(x)$	$E_1(x)$
1.00	0.94608 30704	0.33740 39229	1.89511 7816	0.21938 3934
1.01	0.95448 26820	0.34273 82254	1.92230 1085	0.21574 1624
1.02	0.96285 19387	0.34793 65405	1.94948 7042	0.21217 1083
1.03	0.97119 06039	0.35300 10067	1.97667 8325	0.20867 0559
1.04	0.97949 84431	0.35793 37091	2.00387 7525	0.20523 8352
1.05	0.98777 52233	0.36273 66810	2.03108 7184	0.20187 2813
1.06	0.99602 07135	0.36741 19060	2.05830 9800	0.19857 2347
1.07	1.00423 46846	0.37196 13201	2.08554 7825	0.19533 5403
1.08	1.01241 69091	0.37638 68132	2.11280 3672	0.19216 0479
1.09	1.02056 71617	0.38069 02312	2.14007 9712	0.18904 6118
1.10	1.02868 52187	0.38487 33774	2.16737 8280	0.18599 0905
1.11	1.03677 08583	0.38893 80142	2.19470 1672	0.18299 3465
1.12	1.04482 38608	0.39288 58645	2.22205 2152	0.18005 2467
1.13	1.05284 40082	0.39671 86134	2.24943 1949	0.17716 6615
1.14	1.06083 10845	0.40043 79090	2.27684 3260	0.17433 4651
1.15	1.06878 48757	0.40404 53647	2.30428 8252	0.17155 5354
1.16	1.07670 51696	0.40754 25593	2.33176 9062	0.16882 7535
1.17	1.08459 17561	0.41093 10390	2.35928 7800	0.16615 0040
1.18	1.09244 44270	0.41421 23185	2.38684 6549	0.16352 1748
1.19	1.10026 29760	0.41738 78816	2.41444 7367	0.16094 1567
1.20	1.10804 71990	0.42045 91829	2.44209 2285	0.15840 8437
1.21	1.11579 68937	0.42342 76482	2.46978 3315	0.15592 1324
1.22	1.12351 18599	0.42629 46760	2.49752 2442	0.15347 9226
1.23	1.13119 18994	0.42906 16379	2.52531 1634	0.15108 1164
1.24	1.13883 68160	0.43172 98802	2.55315 2836	0.14872 6188
1.25	1.14644 64157	0.43430 07240	2.58104 7974	0.14641 3373
1.26	1.15402 05063	0.43677 54665	2.60899 8956	0.14414 1815
1.27	1.16155 88978	0.43915 53815	2.63700 7673	0.14191 0639
1.28	1.16906 14023	0.44144 17205	2.66507 5997	0.13971 8989
1.29	1.17652 78340	0.44363 57130	2.69320 5785	0.13756 6032
1.30	1.18395 80091	0.44573 85675	2.72139 8880	0.13545 0958
1.31	1.19135 17459	0.44775 14723	2.74965 7110	0.13337 2975
1.32	1.19870 88649	0.44967 55955	2.77798 2287	0.13133 1314
1.33	1.20602 91886	0.45151 20863	2.80637 6214	0.12932 5224
1.34	1.21331 25418	0.45326 20753	2.83484 0677	0.12735 3972
1.35	1.22055 87513	0.45492 66752	2.86337 7453	0.12541 6844
1.36	1.22776 76460	0.45650 69811	2.89198 8308	0.12351 3146
1.37	1.23493 90571	0.45800 40711	2.92067 4997	0.12164 2198
1.38	1.24207 28180	0.45941 90071	2.94943 9263	0.11980 3337
1.39	1.24916 87640	0.46075 28349	2.97828 2844	0.11799 5919
1.40	1.25622 67328	0.46200 65851	3.00720 7464	0.11621 9313
1.41	1.26324 65642	0.46318 12730	3.03621 4843	0.11447 2903
1.42	1.27022 81004	0.46427 78995	3.06530 6691	0.11275 6090
1.43	1.27717 11854	0.46529 74513	3.09448 4712	0.11106 8287
1.44	1.28407 56658	0.46624 09014	3.12375 0601	0.10940 8923
1.45	1.29094 13902	0.46710 92094	3.15310 6049	0.10777 7440
1.46	1.29776 82094	0.46790 33219	3.18255 2741	0.10617 3291
1.47	1.30455 59767	0.46862 41732	3.21209 2355	0.10459 5946
1.48	1.31130 45473	0.46927 26848	3.24172 6566	0.10304 4882
1.49	1.31801 37788	0.46984 97667	3.27145 7042	0.10151 9593
1.50	1.32468 35312	0.47035 63172	3.30128 5449	0.10001 9582
	$\left[\begin{smallmatrix} (-6)5 \\ 4 \end{smallmatrix} \right]$	$\left[\begin{smallmatrix} (-5)2 \\ 5 \end{smallmatrix} \right]$	$\left[\begin{smallmatrix} (-5)1 \\ 5 \end{smallmatrix} \right]$	$\left[\begin{smallmatrix} (-6)9 \\ 5 \end{smallmatrix} \right]$

SINE, COSINE AND EXPONENTIAL INTEGRALS

Table 5.1

x	Si(x)		Ci(x)		Ei(x)		$E_1(x)$	
1.50	1.32468	35312	0.47035	63172	3.30128	5449	0.10001	9582
1.51	1.33131	36664	0.47079	32232	3.33121	3449	0.09854	4365
1.52	1.33790	40489	0.47116	13608	3.36124	2701	0.09709	3466
1.53	1.34445	45453	0.47146	15952	3.39137	4858	0.09566	6424
1.54	1.35096	50245	0.47169	47815	3.42161	1576	0.09426	2786
1.55	1.35743	53577	0.47186	17642	3.45195	4503	0.09288	2108
1.56	1.36386	54183	0.47196	33785	3.48240	5289	0.09152	3960
1.57	1.37025	50823	0.47200	04495	3.51296	5580	0.09018	7917
1.58	1.37660	42275	0.47197	37932	3.54363	7024	0.08887	3566
1.59	1.38291	27345	0.47188	42164	3.57442	1266	0.08758	0504
1.60	1.38918	04859	0.47173	25169	3.60531	9949	0.08630	8334
1.61	1.39540	73666	0.47151	94840	3.63633	4719	0.08505	6670
1.62	1.40159	32640	0.47124	58984	3.66746	7221	0.08382	5133
1.63	1.40773	80678	0.47091	25325	3.69871	9099	0.08261	3354
1.64	1.41384	16698	0.47052	01507	3.73009	1999	0.08142	0970
1.65	1.41990	39644	0.47006	95096	3.76158	7569	0.08024	7627
1.66	1.42592	48482	0.46956	13580	3.79320	7456	0.07909	2978
1.67	1.43190	42202	0.46899	64372	3.82495	3310	0.07795	6684
1.68	1.43784	19816	0.46837	54812	3.85682	6783	0.07683	8412
1.69	1.44373	80361	0.46769	92169	3.88882	9528	0.07573	7839
1.70	1.44959	22897	0.46696	83642	3.92096	3201	0.07465	4644
1.71	1.45540	46507	0.46618	36359	3.95322	9462	0.07358	8518
1.72	1.46117	50299	0.46534	57385	3.98562	9972	0.07253	9154
1.73	1.46690	33404	0.46445	53716	4.01816	6395	0.07150	6255
1.74	1.47258	94974	0.46351	32286	4.05084	0400	0.07048	9527
1.75	1.47823	34189	0.46251	99967	4.08365	3659	0.06948	8685
1.76	1.48383	50249	0.46147	63568	4.11660	7847	0.06850	3447
1.77	1.48939	42379	0.46038	29839	4.14970	4645	0.06753	3539
1.78	1.49491	09830	0.45924	05471	4.18294	5736	0.06657	8691
1.79	1.50038	51872	0.45804	97097	4.21633	2809	0.06563	8641
1.80	1.50581	67803	0.45681	11294	4.24986	7557	0.06471	3129
1.81	1.51120	56942	0.45552	54585	4.28355	1681	0.06380	1903
1.82	1.51655	18633	0.45419	33436	4.31738	6883	0.06290	4715
1.83	1.52185	52243	0.45281	54262	4.35137	4872	0.06202	1320
1.84	1.52711	57165	0.45139	23427	4.38551	7364	0.06115	1482
1.85	1.53233	32813	0.44992	47241	4.41981	6080	0.06029	4967
1.86	1.53750	78626	0.44841	31966	4.45427	2746	0.05945	1545
1.87	1.54263	94066	0.44685	83813	4.48888	9097	0.05862	0994
1.88	1.54772	78621	0.44526	08948	4.52366	6872	0.05780	3091
1.89	1.55277	31800	0.44362	13486	4.55860	7817	0.05699	7623
1.90	1.55777	53137	0.44194	03497	4.59371	3687	0.05620	4378
1.91	1.56273	42192	0.44021	85005	4.62898	6242	0.05542	3149
1.92	1.56764	98545	0.43845	63991	4.66442	7249	0.05465	3731
1.93	1.57252	21801	0.43665	46388	4.70003	8485	0.05389	5927
1.94	1.57735	11591	0.43481	38088	4.73582	1734	0.05314	9540
1.95	1.58213	67567	0.43293	44941	4.77177	8785	0.05241	4380
1.96	1.58687	89407	0.43101	72752	4.80791	1438	0.05169	0257
1.97	1.59157	76810	0.42906	27288	4.84422	1501	0.05097	6988
1.98	1.59623	29502	0.42707	14273	4.88071	0791	0.05027	4392
1.99	1.60084	47231	0.42504	39391	4.91738	1131	0.04958	2291
2.00	1.60541	29768	0.42298	08288	4.95423	4356	0.04890	0511
		$\left[\begin{smallmatrix} (-6)5 \\ 4 \end{smallmatrix} \right]$		$\left[\begin{smallmatrix} (-6)9 \\ 5 \end{smallmatrix} \right]$		$\left[\begin{smallmatrix} (-5)2 \\ 4 \end{smallmatrix} \right]$		$\left[\begin{smallmatrix} (-6)3 \\ 4 \end{smallmatrix} \right]$

Table 5.1

SINE, COSINE AND EXPONENTIAL INTEGRALS

x	$Si(x)$	$Ci(x)$	$xe^{-x}Ei(x)$	$xe^xE_1(x)$
2.0	1.60541 29768	0.42298 08288	1.34096 5420	0.72265 7234
2.1	1.64869 86362	0.40051 19878	1.37148 6802	0.73079 1502
2.2	1.68762 48272	0.37507 45990	1.39742 1992	0.73843 1132
2.3	1.72220 74818	0.34717 56175	1.41917 1534	0.74562 2149
2.4	1.75248 55008	0.31729 16174	1.43711 8315	0.75240 4829
2.5	1.77852 01734	0.28587 11964	1.45162 5159	0.75881 4592
2.6	1.80039 44505	0.25333 66161	1.46303 3397	0.76488 2722
2.7	1.81821 20765	0.22008 48786	1.47166 2153	0.77063 6987
2.8	1.83209 65891	0.18648 83896	1.47780 8187	0.77610 2123
2.9	1.84219 01946	0.15289 53242	1.48174 6162	0.78130 0252
3.0	1.84865 25280	0.11962 97860	1.48372 9204	0.78625 1221
3.1	1.85165 93077	0.08699 18312	1.48398 9691	0.79097 2900
3.2	1.85140 08970	0.05525 74117	1.48274 0191	0.79548 1422
3.3	1.84808 07828	+0.02467 82846	1.48017 4491	0.79979 1408
3.4	1.84191 39833	-0.00451 80779	1.47646 8706	0.80391 6127
3.5	1.83312 53987	-0.03212 85485	1.47178 2389	0.80786 7661
3.6	1.82194 81156	-0.05797 43519	1.46625 9659	0.81165 7037
3.7	1.80862 16809	-0.08190 10013	1.46003 0313	0.81529 4342
3.8	1.79339 03548	-0.10377 81504	1.45321 0902	0.81878 8821
3.9	1.77650 13604	-0.12349 93492	1.44590 5765	0.82214 8967
4.0	1.75820 31389	-0.14098 16979	1.43820 8032	0.82538 2600
4.1	1.73874 36265	-0.15616 53918	1.43020 0557	0.82849 6926
4.2	1.71836 85637	-0.16901 31568	1.42195 6813	0.83149 8602
4.3	1.69731 98507	-0.17950 95725	1.41354 1719	0.83439 3794
4.4	1.67583 39594	-0.18766 02868	1.40501 2424	0.83718 8207
4.5	1.65414 04144	-0.19349 11221	1.39641 9030	0.83988 7144
4.6	1.63246 03525	-0.19704 70797	1.38780 5263	0.84249 5539
4.7	1.61100 51718	-0.19839 12468	1.37920 9093	0.84501 7971
4.8	1.58997 52782	-0.19760 36133	1.37066 3313	0.84745 8721
4.9	1.56955 89381	-0.19477 98060	1.36219 6054	0.84982 1778
5.0	1.54993 12449	-0.19002 97497	1.35383 1278	0.85211 0880
5.1	1.53125 32047	-0.18347 62632	1.34558 9212	0.85432 9519
5.2	1.51367 09468	-0.17525 36023	1.33748 6755	0.85648 0958
5.3	1.49731 50636	-0.16550 59586	1.32953 7845	0.85856 8275
5.4	1.48230 00826	-0.15438 59262	1.32175 3788	0.86059 4348
5.5	1.46872 40727	-0.14205 29476	1.31414 3566	0.86256 1885
5.6	1.45666 83847	-0.12867 17494	1.30671 4107	0.86447 3436
5.7	1.44619 75285	-0.11441 07808	1.29947 0536	0.86633 1399
5.8	1.43735 91823	-0.09944 06647	1.29241 6395	0.86813 8040
5.9	1.43018 43341	-0.08393 26741	1.28555 3849	0.86989 5494
6.0	1.42468 75513	-0.06805 72439	1.27888 3860	0.87160 5775
6.1	1.42086 73734	-0.05198 25290	1.27240 6357	0.87327 0793
6.2	1.41870 68241	-0.03587 30193	1.26612 0373	0.87489 2347
6.3	1.41817 40348	-0.01988 82206	1.26002 4184	0.87647 2150
6.4	1.41922 29740	-0.00418 14110	1.25411 5417	0.87801 1816
6.5	1.42179 42744	+0.01110 15195	1.24839 1155	0.87951 2881
6.6	1.42581 61486	0.02582 31381	1.24284 8032	0.88097 6797
6.7	1.43120 53853	0.03985 54400	1.23748 2309	0.88240 4955
6.8	1.43786 84161	0.05308 07167	1.23228 9952	0.88379 8662
6.9	1.44570 24427	0.06539 23140	1.22726 6684	0.88515 9176
7.0	1.45459 66142	0.07669 52785	1.22240 8053	0.88648 7675
	$\left[\begin{smallmatrix} (-4)5 \\ 7 \end{smallmatrix} \right]$	$\left[\begin{smallmatrix} (-4)4 \\ 8 \end{smallmatrix} \right]$	$\left[\begin{smallmatrix} (-4)6 \\ 7 \end{smallmatrix} \right]$	$\left[\begin{smallmatrix} (-5)6 \\ 6 \end{smallmatrix} \right]$

SINE, COSINE AND EXPONENTIAL INTEGRALS

Table 5.1

x	$\text{Si}(x)$	$\text{Ci}(x)$	$x e^{-x} \text{Ei}(x)$	$x e^x E_1(x)$
7.0	1.45459 66142	0.07669 52785	1.22240 8053	0.88648 7675
7.1	1.46443 32441	0.08690 68881	1.21770 9472	0.88778 5294
7.2	1.47508 90554	0.09595 70643	1.21316 6264	0.88905 3119
7.3	1.48643 64451	0.10378 86664	1.20877 3699	0.89029 2173
7.4	1.49834 47533	0.11035 76658	1.20452 7026	0.89150 3440
7.5	1.51068 15309	0.11563 32032	1.20042 1500	0.89268 7854
7.6	1.52331 37914	0.11959 75293	1.19645 2401	0.89384 6312
7.7	1.53610 92381	0.12224 58319	1.19261 5063	0.89497 9666
7.8	1.54893 74581	0.12358 59542	1.18890 4881	0.89608 8737
7.9	1.56167 10702	0.12363 80071	1.18531 7334	0.89717 4302
8.0	1.57418 68217	0.12243 38825	1.18184 7987	0.89823 7113
8.1	1.58636 66225	0.12001 66733	1.17849 2509	0.89927 7888
8.2	1.59809 85106	0.11644 00055	1.17524 6676	0.90029 7306
8.3	1.60927 75419	0.11176 72931	1.17210 6376	0.90129 6033
8.4	1.61980 65968	0.10607 09196	1.16906 7617	0.90227 4695
8.5	1.62959 70996	0.09943 13586	1.16612 6526	0.90323 3900
8.6	1.63856 96454	0.09193 62396	1.16327 9354	0.90417 4228
8.7	1.64665 45309	0.08367 93696	1.16052 2476	0.90509 6235
8.8	1.65379 21861	0.07475 97196	1.15785 2390	0.90600 0459
8.9	1.65993 35052	0.06528 03850	1.15526 5719	0.90688 7415
9.0	1.66504 00758	0.05534 75313	1.15275 9209	0.90775 7602
9.1	1.66908 43056	0.04506 93325	1.15032 9724	0.90861 1483
9.2	1.67204 94480	0.03455 49134	1.14797 4251	0.90944 9530
9.3	1.67392 95283	0.02391 33045	1.14568 9889	0.91027 2177
9.4	1.67472 91725	0.01325 24187	1.14347 3855	0.91107 9850
9.5	1.67446 33423	+0.00267 80588	1.14132 3476	0.91187 2958
9.6	1.67315 69801	-0.00770 70361	1.13923 6185	0.91265 1897
9.7	1.67084 45697	-0.01780 40977	1.13720 9523	0.91341 7043
9.8	1.66756 96169	-0.02751 91811	1.13524 1130	0.91416 8766
9.9	1.66338 40566	-0.03676 39563	1.13332 8746	0.91490 7418
10.0	1.65834 75942 $\left[\begin{smallmatrix} (-4)1 \\ 7 \end{smallmatrix} \right]$	-0.04545 64330 $\left[\begin{smallmatrix} (-4)2 \\ 7 \end{smallmatrix} \right]$	1.13147 0205 $\left[\begin{smallmatrix} (-5)2 \\ 5 \end{smallmatrix} \right]$	0.91563 3339 $\left[\begin{smallmatrix} (-6)4 \\ 4 \end{smallmatrix} \right]$

Table 5.2

SINE, COSINE AND EXPONENTIAL INTEGRALS FOR LARGE ARGUMENTS

x^{-1}	$x f(x)$	$x^2 g(x)$	$x e^{-x} \text{Ei}(x)$	$x e^x E_1(x)$	$\langle x \rangle$
0.100	0.98191 0351	0.94885 39	1.13147 021	0.91563 33394	10
0.095	0.98353 4427	0.95323 18	1.12249 671	0.91925 68286	11
0.090	0.98509 9171	0.95748 44	1.11389 377	0.92293 15844	11
0.085	0.98660 1776	0.96160 17	1.10564 739	0.92665 90998	12
0.080	0.98803 9405	0.96557 23	1.09773 775	0.93044 09399	13
0.075	0.98940 9188	0.96938 56	1.09014 087	0.93427 87466	13
0.070	0.99070 8244	0.97302 98	1.08283 054	0.93817 42450	14
0.065	0.99193 3695	0.97649 35	1.07578 038	0.94212 92486	15
0.060	0.99308 2682	0.97976 47	1.06896 548	0.94614 56670	17
0.055	0.99415 2385	0.98283 17	1.06236 365	0.95022 55126	18
0.050	0.99514 0052	0.98568 24	1.05595 591	0.95437 09099	20
0.045	0.99604 3013	0.98830 52	1.04972 640	0.95858 41038	22
0.040	0.99685 8722	0.99068 81	1.04366 194	0.96286 74711	25
0.035	0.99758 4771	0.99282 12	1.03775 135	0.96722 35311	29
0.030	0.99821 8937	0.99469 37	1.03198 503	0.97165 49596	33
0.025	0.99875 9204	0.99629 57	1.02635 451	0.97616 46031	40
0.020	0.99920 3795	0.99761 89	1.02085 228	0.98075 54965	50
0.015	0.99955 1207	0.99865 60	1.01547 157	0.98543 08813	67
0.010	0.99980 0239	0.99940 12	1.01020 625	0.99019 42287	100
0.005	0.99995 0015	0.99985 01	1.00505 077	0.99504 92646	200
0.000	1.00000 0000 $\left[\begin{smallmatrix} (-5)1 \\ 5 \end{smallmatrix} \right]$	1.00000 00 $\left[\begin{smallmatrix} (-5)4 \\ 4 \end{smallmatrix} \right]$	1.00000 000 $\left[\begin{smallmatrix} (-5)5 \\ 6 \end{smallmatrix} \right]$	1.00000 00000 $\left[\begin{smallmatrix} (-5)1 \\ 6 \end{smallmatrix} \right]$	∞

$\text{Si}(x) = \frac{\pi}{2} - f(x) \cos x - g(x) \sin x$ $\text{Ci}(x) = f(x) \sin x - g(x) \cos x$
 $\frac{\pi}{2} = 1.57079 63268$ $\langle x \rangle =$ nearest integer to x .

See Example 3.

Table 5.3 SINE AND COSINE INTEGRALS FOR ARGUMENTS πx

x	Si(πx)	Cin(πx)	x	Si(πx)	Cin(πx)
0.0	0.00000 00	0.00000 00	5.0	1.63396 48	3.32742 23
0.1	0.31244 18	0.02457 28	5.1	1.63088 98	3.36670 50
0.2	0.61470 01	0.09708 67	5.2	1.62211 92	3.40335 81
0.3	0.89718 92	0.21400 75	5.3	1.60871 21	3.43582 68
0.4	1.15147 74	0.36970 10	5.4	1.59212 99	3.46297 82
0.5	1.37076 22	0.55679 77	5.5	1.57408 24	3.48419 47
0.6	1.55023 35	0.76666 63	5.6	1.55635 75	3.49941 45
0.7	1.68729 94	0.98995 93	5.7	1.54064 82	3.50911 89
0.8	1.78166 12	1.21719 42	5.8	1.52839 53	3.51426 89
0.9	1.83523 65	1.43932 68	5.9	1.52065 96	3.51619 81
1.0	1.85193 70	1.64827 75	6.0	1.51803 39	3.51647 44
1.1	1.83732 28	1.83737 48	6.1	1.52060 20	3.51674 38
1.2	1.79815 90	2.00168 51	6.2	1.52794 77	3.51857 25
1.3	1.74191 10	2.13821 22	6.3	1.53921 04	3.52330 06
1.4	1.67621 68	2.24595 41	6.4	1.55318 17	3.53192 30
1.5	1.60837 27	2.32581 82	6.5	1.56843 12	3.54500 55
1.6	1.54487 36	2.38040 96	6.6	1.58344 97	3.56264 55
1.7	1.49103 51	2.41370 98	6.7	1.59679 62	3.58447 72
1.8	1.45072 37	2.43067 75	6.8	1.60723 30	3.60972 10
1.9	1.42621 05	2.43680 30	6.9	1.61383 85	3.63727 15
2.0	1.41815 16	2.43765 34	7.0	1.61608 55	3.66581 26
2.1	1.42569 13	2.43844 23	7.1	1.61388 08	3.69395 05
2.2	1.44667 38	2.44365 73	7.2	1.60756 18	3.72034 97
2.3	1.47794 03	2.45676 95	7.3	1.59785 21	3.74385 98
2.4	1.51568 40	2.48004 47	7.4	1.58578 13	3.76362 13
2.5	1.55583 10	2.51446 40	7.5	1.57257 88	3.77914 01
2.6	1.59441 60	2.55975 53	7.6	1.55954 96	3.79032 64
2.7	1.62792 16	2.61452 59	7.7	1.54794 81	3.79749 22
2.8	1.65355 62	2.67647 93	7.8	1.53885 84	3.80131 21
2.9	1.66945 05	2.74269 41	7.9	1.53309 50	3.80274 91
3.0	1.67476 18	2.80993 76	8.0	1.53113 13	3.80295 56
3.1	1.66968 11	2.87498 49	8.1	1.53306 26	3.80315 83
3.2	1.65535 02	2.93491 77	8.2	1.53860 67	3.80453 88
3.3	1.63369 82	2.98737 63	8.3	1.54713 99	3.80812 16
3.4	1.60721 88	3.03074 73	8.4	1.55776 52	3.81467 97
3.5	1.57870 92	3.06427 25	8.5	1.56940 54	3.82466 68
3.6	1.55099 62	3.08807 51	8.6	1.58091 06	3.83818 15
3.7	1.52667 49	3.10310 38	8.7	1.59117 06	3.85496 61
3.8	1.50788 19	3.11100 53	8.8	1.59922 11	3.87444 05
3.9	1.49612 20	3.11393 95	8.9	1.60433 29	3.89576 52
4.0	1.49216 12	3.11435 65	9.0	1.60607 69	3.91792 84
4.1	1.49599 24	3.11475 82	9.1	1.60435 85	3.93984 77
4.2	1.50687 40	3.11746 60	9.2	1.59942 00	3.96047 61
4.3	1.52343 40	3.12441 61	9.3	1.59180 91	3.97890 22
4.4	1.54382 74	3.13699 91	9.4	1.58232 00	3.99443 58
4.5	1.56593 04	3.15595 79	9.5	1.57191 16	4.00666 94
4.6	1.58755 15	3.18134 84	9.6	1.56161 12	4.01551 22
4.7	1.60664 04	3.21256 74	9.7	1.55241 46	4.02119 22
4.8	1.62147 45	3.24843 85	9.8	1.54519 00	4.02422 80
4.9	1.63080 69	3.28734 92	9.9	1.54059 74	4.02537 29
5.0	1.63396 48	3.32742 23	10.0	1.53902 91	4.02553 78
	$\left[\begin{smallmatrix} (-3)5 \\ 8 \end{smallmatrix} \right]$	$\left[\begin{smallmatrix} (-3)6 \\ 8 \end{smallmatrix} \right]$		$\left[\begin{smallmatrix} (-4)7 \\ 7 \end{smallmatrix} \right]$	$\left[\begin{smallmatrix} (-4)7 \\ 7 \end{smallmatrix} \right]$

$$Ci(\pi x) = \gamma + \ln \pi + \ln x - Cin(\pi x)$$

$$\gamma + \ln \pi = 1.72194 55508$$

Si($n\pi$) are maximum values of Si(x) if $n > 0$ is odd, and minimum values if $n > 0$ is even.

Ci $\left[\left(n + \frac{1}{2} \right) \pi \right]$ are maximum values of Ci(x) if $n > 0$ is even, and minimum values if $n > 0$ is odd. We have

$$Si(n\pi) \sim \frac{\pi}{2} - \frac{(-1)^n}{n\pi} \left[1 - \frac{2!}{n^2 \pi^2} + \frac{4!}{n^4 \pi^4} - \dots \right] \quad (n \rightarrow \infty)$$

$$Ci \left[\left(n + \frac{1}{2} \right) \pi \right] \sim \frac{(-1)^n}{\left(n + \frac{1}{2} \right) \pi} \left[1 - \frac{2!}{\left(n + \frac{1}{2} \right)^2 \pi^2} + \frac{4!}{\left(n + \frac{1}{2} \right)^4 \pi^4} - \dots \right] \quad (n \rightarrow \infty)$$

EXPONENTIAL INTEGRALS $E_n(x)$

Table 5.4

x	$E_2(x) - x \ln x$	$E_3(x)$	$E_4(x)$	$E_{10}(x)$	$E_{20}(x)$
0.00	1.00000 00	0.50000 00	0.33333 33	0.11111 11	0.05263 16
0.01	0.99572 22	0.49027 66	0.32838 24	0.10986 82	0.05207 90
0.02	0.99134 50	0.48096 83	0.32352 64	0.10863 95	0.05153 21
0.03	0.98686 87	0.47199 77	0.31876 19	0.10742 46	0.05099 11
0.04	0.98229 39	0.46332 39	0.31408 55	0.10622 36	0.05045 58
0.05	0.97762 11	0.45491 88	0.30949 45	0.10503 63	0.04992 60
0.06	0.97285 08	0.44676 09	0.30498 63	0.10386 24	0.04940 19
0.07	0.96798 34	0.43883 27	0.30055 85	0.10270 18	0.04888 33
0.08	0.96301 94	0.43111 97	0.29620 89	0.10155 44	0.04837 02
0.09	0.95795 93	0.42360 96	0.29193 54	0.10042 00	0.04786 24
0.10	0.95280 35	0.41629 15	0.28773 61	0.09929 84	0.04736 00
0.11	0.94755 26	0.40915 57	0.28360 90	0.09818 96	0.04686 29
0.12	0.94220 71	0.40219 37	0.27955 24	0.09709 34	0.04637 10
0.13	0.93676 72	0.39539 77	0.27556 46	0.09600 95	0.04588 43
0.14	0.93123 36	0.38876 07	0.27164 39	0.09493 80	0.04540 27
0.15	0.92560 67	0.38227 61	0.26778 89	0.09387 86	0.04492 62
0.16	0.91988 70	0.37593 80	0.26399 79	0.09283 12	0.04445 47
0.17	0.91407 48	0.36974 08	0.26026 96	0.09179 56	0.04398 82
0.18	0.90817 06	0.36367 95	0.25660 26	0.09077 18	0.04352 66
0.19	0.90217 50	0.35774 91	0.25299 56	0.08975 95	0.04306 98
0.20	0.89608 82	0.35194 53	0.24944 72	0.08875 87	0.04261 79
0.21	0.88991 09	0.34626 38	0.24595 63	0.08776 93	0.04217 07
0.22	0.88364 33	0.34070 05	0.24252 16	0.08679 10	0.04172 82
0.23	0.87728 60	0.33525 18	0.23914 19	0.08582 38	0.04129 03
0.24	0.87083 93	0.32991 42	0.23581 62	0.08486 75	0.04085 71
0.25	0.86430 37	0.32468 41	0.23254 32	0.08392 20	0.04042 85
0.26	0.85767 97	0.31955 85	0.22932 21	0.08298 72	0.04000 43
0.27	0.85096 76	0.31453 43	0.22615 17	0.08206 30	0.03958 46
0.28	0.84416 78	0.30960 86	0.22303 11	0.08114 92	0.03916 93
0.29	0.83728 08	0.30477 87	0.21995 93	0.08024 57	0.03875 84
0.30	0.83030 71	0.30004 18	0.21693 52	0.07935 24	0.03835 18
0.31	0.82324 69	0.29539 56	0.21395 81	0.07846 93	0.03794 95
0.32	0.81610 07	0.29083 74	0.21102 70	0.07759 60	0.03755 15
0.33	0.80886 90	0.28636 52	0.20814 11	0.07673 27	0.03715 76
0.34	0.80155 21	0.28197 65	0.20529 94	0.07587 90	0.03676 78
0.35	0.79415 04	0.27766 93	0.20250 13	0.07503 50	0.03638 22
0.36	0.78666 44	0.27344 16	0.19974 58	0.07420 06	0.03600 06
0.37	0.77909 43	0.26929 13	0.19703 22	0.07337 55	0.03562 31
0.38	0.77144 07	0.26521 65	0.19435 97	0.07255 97	0.03524 95
0.39	0.76370 39	0.26121 55	0.19172 76	0.07175 31	0.03487 98
0.40	0.75588 43	0.25728 64	0.18913 52	0.07095 57	0.03451 40
0.41	0.74798 23	0.25342 76	0.18658 16	0.07016 71	0.03415 21
0.42	0.73999 82	0.24963 73	0.18406 64	0.06938 75	0.03379 39
0.43	0.73193 24	0.24591 41	0.18158 87	0.06861 67	0.03343 96
0.44	0.72378 54	0.24225 63	0.17914 79	0.06785 45	0.03308 89
0.45	0.71555 75	0.23866 25	0.17674 33	0.06710 09	0.03274 20
0.46	0.70724 91	0.23513 13	0.17437 44	0.06635 58	0.03239 87
0.47	0.69886 05	0.23166 12	0.17204 05	0.06561 91	0.03205 90
0.48	0.69039 21	0.22825 08	0.16974 10	0.06489 07	0.03172 29
0.49	0.68184 43	0.22489 90	0.16747 53	0.06417 04	0.03139 03
0.50	0.67321 75	0.22160 44	0.16524 28	0.06345 83	0.03106 12
	$\left[\begin{smallmatrix} (-5)1 \\ 3 \end{smallmatrix} \right]$	$\left[\begin{smallmatrix} (-5)5 \\ 6 \end{smallmatrix} \right]$	$\left[\begin{smallmatrix} (-5)1 \\ 4 \end{smallmatrix} \right]$	$\left[\begin{smallmatrix} (-6)2 \\ 3 \end{smallmatrix} \right]$	$\left[\begin{smallmatrix} (-7)7 \\ 3 \end{smallmatrix} \right]$

See Examples 4-6.

Table 5.4

EXPONENTIAL INTEGRALS $E_n(x)$

x	$E_2(x)$	$E_3(x)$	$E_4(x)$	$E_{10}(x)$	$E_{20}(x)$
0.50	0.32664 39	0.22160 44	0.16524 28	0.06345 83	0.03106 12
0.51	0.32110 62	0.21836 57	0.16304 30	0.06275 42	0.03073 56
0.52	0.31568 63	0.21518 18	0.16087 53	0.06205 80	0.03041 34
0.53	0.31038 07	0.21205 16	0.15873 92	0.06136 96	0.03009 46
0.54	0.30518 62	0.20897 39	0.15663 41	0.06068 89	0.02977 91
0.55	0.30009 96	0.20594 75	0.15455 96	0.06001 59	0.02946 70
0.56	0.29511 79	0.20297 15	0.15251 50	0.05935 05	0.02915 81
0.57	0.29023 82	0.20004 48	0.15050 00	0.05869 25	0.02885 25
0.58	0.28545 78	0.19716 64	0.14851 39	0.05804 19	0.02855 01
0.59	0.28077 39	0.19433 53	0.14655 65	0.05739 86	0.02825 08
0.60	0.27618 39	0.19155 06	0.14462 71	0.05676 26	0.02795 48
0.61	0.27168 55	0.18881 14	0.14272 53	0.05613 36	0.02766 18
0.62	0.26727 61	0.18611 66	0.14085 07	0.05551 18	0.02737 19
0.63	0.26295 35	0.18346 56	0.13900 28	0.05489 69	0.02708 50
0.64	0.25871 54	0.18085 73	0.13718 13	0.05428 89	0.02680 12
0.65	0.25455 97	0.17829 10	0.13538 55	0.05368 77	0.02652 04
0.66	0.25048 44	0.17576 58	0.13361 53	0.05309 33	0.02624 25
0.67	0.24648 74	0.17328 10	0.13187 01	0.05250 55	0.02596 75
0.68	0.24256 67	0.17083 58	0.13014 95	0.05192 43	0.02569 54
0.69	0.23872 06	0.16842 94	0.12845 33	0.05134 97	0.02542 62
0.70	0.23494 71	0.16606 12	0.12678 08	0.05078 15	0.02515 98
0.71	0.23124 46	0.16373 03	0.12513 19	0.05021 96	0.02489 62
0.72	0.22761 14	0.16143 60	0.12350 61	0.04966 40	0.02463 53
0.73	0.22404 57	0.15917 78	0.12190 31	0.04911 47	0.02437 72
0.74	0.22054 61	0.15695 49	0.12032 24	0.04857 15	0.02412 19
0.75	0.21711 09	0.15476 67	0.11876 38	0.04803 44	0.02386 92
0.76	0.21373 88	0.15261 25	0.11722 70	0.04750 33	0.02361 91
0.77	0.21042 82	0.15049 17	0.11571 15	0.04697 81	0.02337 17
0.78	0.20717 77	0.14840 37	0.11421 70	0.04645 88	0.02312 69
0.79	0.20398 60	0.14634 79	0.11274 33	0.04594 53	0.02288 46
0.80	0.20085 17	0.14432 38	0.11129 00	0.04543 76	0.02264 49
0.81	0.19777 36	0.14233 07	0.10985 67	0.04493 56	0.02240 78
0.82	0.19475 04	0.14036 81	0.10844 33	0.04443 91	0.02217 31
0.83	0.19178 10	0.13843 55	0.10704 93	0.04394 82	0.02194 08
0.84	0.18886 41	0.13653 24	0.10567 44	0.04346 28	0.02171 11
0.85	0.18599 86	0.13465 81	0.10431 85	0.04298 29	0.02148 37
0.86	0.18318 33	0.13281 22	0.10298 12	0.04250 82	0.02125 87
0.87	0.18041 73	0.13099 43	0.10166 22	0.04203 89	0.02103 61
0.88	0.17769 94	0.12920 37	0.10036 12	0.04157 49	0.02081 58
0.89	0.17502 87	0.12744 01	0.09907 80	0.04111 60	0.02059 78
0.90	0.17240 41	0.12570 30	0.09781 23	0.04066 22	0.02038 21
0.91	0.16982 47	0.12399 19	0.09656 39	0.04021 35	0.02016 87
0.92	0.16728 95	0.12230 63	0.09533 24	0.03976 98	0.01995 75
0.93	0.16479 77	0.12064 59	0.09411 77	0.03933 11	0.01974 86
0.94	0.16234 82	0.11901 02	0.09291 94	0.03889 73	0.01954 18
0.95	0.15994 04	0.11739 88	0.09173 74	0.03846 83	0.01933 72
0.96	0.15757 32	0.11581 13	0.09057 13	0.03804 41	0.01913 47
0.97	0.15524 59	0.11424 72	0.08942 11	0.03762 46	0.01893 44
0.98	0.15295 78	0.11270 63	0.08828 63	0.03720 98	0.01873 62
0.99	0.15070 79	0.11118 80	0.08716 69	0.03679 96	0.01854 01
1.00	0.14849 55 $\left[\begin{smallmatrix} (-5)1 \\ 4 \end{smallmatrix} \right]$	0.10969 20 $\left[\begin{smallmatrix} (-6)7 \\ 3 \end{smallmatrix} \right]$	0.08606 25 $\left[\begin{smallmatrix} (-6)4 \\ 3 \end{smallmatrix} \right]$	0.03639 40 $\left[\begin{smallmatrix} (-6)1 \\ 3 \end{smallmatrix} \right]$	0.01834 60 $\left[\begin{smallmatrix} (-7)4 \\ 3 \end{smallmatrix} \right]$

EXPONENTIAL INTEGRALS $E_n(x)$

Table 5.4

x	$E_2(x)$	$E_3(x)$	$E_4(x)$	$E_{10}(x)$	$E_{20}(x)$
1.00	0.14849 55	0.10969 20	0.08606 25	0.03639 40	0.01834 60
1.01	0.14631 99	0.10821 79	0.08497 30	0.03599 29	0.01815 39
1.02	0.14418 04	0.10676 54	0.08389 81	0.03559 63	0.01796 39
1.03	0.14207 63	0.10533 42	0.08283 76	0.03520 41	0.01777 59
1.04	0.14000 68	0.10392 38	0.08179 13	0.03481 63	0.01758 98
1.05	0.13797 13	0.10253 39	0.08075 90	0.03443 28	0.01740 57
1.06	0.13596 91	0.10116 43	0.07974 06	0.03405 35	0.01722 35
1.07	0.13399 96	0.09981 45	0.07873 57	0.03367 85	0.01704 33
1.08	0.13206 22	0.09848 42	0.07774 42	0.03330 77	0.01686 49
1.09	0.13015 62	0.09717 31	0.07676 59	0.03294 10	0.01668 84
1.10	0.12828 11	0.09588 09	0.07580 07	0.03257 84	0.01651 37
1.11	0.12643 62	0.09460 74	0.07484 83	0.03221 98	0.01634 09
1.12	0.12462 10	0.09335 21	0.07390 85	0.03186 52	0.01616 99
1.13	0.12283 50	0.09211 49	0.07298 12	0.03151 45	0.01600 07
1.14	0.12107 75	0.09089 53	0.07206 61	0.03116 78	0.01583 33
1.15	0.11934 81	0.08969 32	0.07116 32	0.03082 49	0.01566 76
1.16	0.11764 62	0.08850 83	0.07027 22	0.03048 58	0.01550 31
1.17	0.11597 14	0.08734 02	0.06939 30	0.03015 05	0.01534 14
1.18	0.11432 31	0.08618 88	0.06852 53	0.02981 89	0.01518 09
1.19	0.11270 08	0.08505 37	0.06766 91	0.02949 10	0.01502 21
1.20	0.11110 41	0.08393 47	0.06682 42	0.02916 68	0.01486 49
1.21	0.10953 25	0.08283 15	0.06599 04	0.02884 61	0.01470 94
1.22	0.10798 55	0.08174 39	0.06516 75	0.02852 90	0.01455 55
1.23	0.10646 27	0.08067 17	0.06435 55	0.02821 55	0.01440 32
1.24	0.10496 37	0.07961 46	0.06355 40	0.02790 54	0.01425 26
1.25	0.10348 81	0.07857 23	0.06276 31	0.02759 88	0.01410 35
1.26	0.10203 53	0.07754 47	0.06198 25	0.02729 55	0.01395 59
1.27	0.10060 51	0.07653 16	0.06121 22	0.02699 57	0.01381 00
1.28	0.09919 70	0.07553 26	0.06045 19	0.02669 91	0.01366 55
1.29	0.09781 06	0.07454 76	0.05970 15	0.02640 59	0.01352 26
1.30	0.09644 55	0.07357 63	0.05896 09	0.02611 59	0.01338 11
1.31	0.09510 15	0.07261 86	0.05822 99	0.02582 91	0.01324 22
1.32	0.09377 80	0.07167 42	0.05750 85	0.02554 55	0.01310 27
1.33	0.09247 47	0.07074 29	0.05679 64	0.02526 51	0.01296 57
1.34	0.09119 13	0.06982 46	0.05609 36	0.02498 78	0.01283 01
1.35	0.08992 75	0.06891 91	0.05539 98	0.02471 35	0.01269 59
1.36	0.08868 29	0.06802 60	0.05471 51	0.02444 23	0.01256 31
1.37	0.08745 71	0.06714 53	0.05403 93	0.02417 41	0.01243 17
1.38	0.08624 99	0.06627 68	0.05337 22	0.02390 88	0.01230 17
1.39	0.08506 10	0.06542 03	0.05271 37	0.02364 65	0.01217 31
1.40	0.08388 99	0.06457 55	0.05206 37	0.02338 72	0.01204 58
1.41	0.08273 65	0.06374 24	0.05142 22	0.02313 06	0.01191 98
1.42	0.08160 04	0.06292 07	0.05078 89	0.02287 70	0.01179 52
1.43	0.08048 13	0.06211 04	0.05016 37	0.02262 61	0.01167 19
1.44	0.07937 89	0.06131 11	0.04954 66	0.02237 80	0.01154 99
1.45	0.07829 30	0.06052 27	0.04893 74	0.02213 27	0.01142 91
1.46	0.07722 33	0.05974 52	0.04833 61	0.02189 01	0.01130 96
1.47	0.07616 94	0.05897 82	0.04774 25	0.02165 01	0.01119 14
1.48	0.07513 13	0.05822 17	0.04715 65	0.02141 28	0.01107 44
1.49	0.07410 85	0.05747 55	0.04657 80	0.02117 82	0.01095 86
1.50	0.07310 08	0.05673 95	0.04600 70	0.02094 61	0.01084 40
1.51	0.07210 80	0.05601 35	0.04544 32	0.02071 67	0.01073 07
1.52	0.07112 98	0.05529 73	0.04488 67	0.02048 97	0.01061 85
1.53	0.07016 60	0.05459 08	0.04433 72	0.02026 53	0.01050 75
1.54	0.06921 64	0.05389 39	0.04379 48	0.02004 33	0.01039 77
1.55	0.06828 07	0.05320 64	0.04325 93	0.01982 38	0.01028 90
1.56	0.06735 87	0.05252 83	0.04273 07	0.01960 67	0.01018 15
1.57	0.06645 02	0.05185 92	0.04220 87	0.01939 21	0.01007 50
1.58	0.06555 49	0.05119 92	0.04169 35	0.01917 98	0.00996 97
1.59	0.06467 26	0.05054 81	0.04118 47	0.01896 98	0.00986 56
1.60	0.06380 32 $\left[\begin{smallmatrix} (-6)5 \\ 3 \end{smallmatrix} \right]$	0.04990 57 $\left[\begin{smallmatrix} (-6)3 \\ 3 \end{smallmatrix} \right]$	0.04068 25 $\left[\begin{smallmatrix} (-6)2 \\ 3 \end{smallmatrix} \right]$	0.01876 22 $\left[\begin{smallmatrix} (-7)6 \\ 3 \end{smallmatrix} \right]$	0.00976 24 $\left[\begin{smallmatrix} (-7)3 \\ 3 \end{smallmatrix} \right]$

Table 5.4 EXPONENTIAL INTEGRALS $E_n(x)$

x	$E_2(x)$	$E_3(x)$	$E_4(x)$	$E_{10}(x)$	$E_{20}(x)$
1.60	0.06380 32	0.04990 57	0.04068 25	0.01876 22	0.00976 24
1.61	0.06294 64	0.04927 20	0.04018 66	0.01855 68	0.00966 04
1.62	0.06210 20	0.04864 67	0.03969 70	0.01835 38	0.00955 95
1.63	0.06126 98	0.04802 99	0.03921 36	0.01815 30	0.00945 96
1.64	0.06044 97	0.04742 13	0.03873 64	0.01795 43	0.00936 07
1.65	0.05964 13	0.04682 09	0.03826 52	0.01775 79	0.00926 29
1.66	0.05884 46	0.04622 84	0.03779 99	0.01756 37	0.00916 61
1.67	0.05805 94	0.04564 39	0.03734 06	0.01737 16	0.00907 03
1.68	0.05728 54	0.04506 72	0.03688 70	0.01718 16	0.00897 56
1.69	0.05652 26	0.04449 82	0.03643 92	0.01699 37	0.00888 18
1.70	0.05577 06	0.04393 67	0.03599 70	0.01680 79	0.00878 90
1.71	0.05502 94	0.04338 27	0.03556 04	0.01662 42	0.00869 72
1.72	0.05429 88	0.04283 61	0.03512 93	0.01644 24	0.00860 63
1.73	0.05357 86	0.04229 67	0.03470 37	0.01626 27	0.00851 64
1.74	0.05286 86	0.04176 45	0.03428 34	0.01608 50	0.00842 74
1.75	0.05216 87	0.04123 93	0.03386 84	0.01590 92	0.00833 94
1.76	0.05147 88	0.04072 11	0.03345 86	0.01573 54	0.00825 22
1.77	0.05079 86	0.04020 97	0.03305 39	0.01556 34	0.00816 60
1.78	0.05012 81	0.03970 51	0.03265 44	0.01539 34	0.00808 07
1.79	0.04946 70	0.03920 71	0.03225 98	0.01522 53	0.00799 63
1.80	0.04881 53	0.03871 57	0.03187 02	0.01505 90	0.00791 28
1.81	0.04817 27	0.03823 08	0.03148 55	0.01489 45	0.00783 02
1.82	0.04753 92	0.03775 22	0.03110 56	0.01473 18	0.00774 84
1.83	0.04691 46	0.03728 00	0.03073 04	0.01457 10	0.00766 74
1.84	0.04629 87	0.03681 39	0.03035 99	0.01441 19	0.00758 74
1.85	0.04569 15	0.03635 40	0.02999 41	0.01425 46	0.00750 81
1.86	0.04509 28	0.03590 01	0.02963 28	0.01409 90	0.00742 97
1.87	0.04450 24	0.03545 21	0.02927 61	0.01394 51	0.00735 21
1.88	0.04392 03	0.03501 00	0.02892 38	0.01379 29	0.00727 53
1.89	0.04334 63	0.03457 37	0.02857 59	0.01364 24	0.00719 93
1.90	0.04278 03	0.03414 30	0.02823 23	0.01349 35	0.00712 42
1.91	0.04222 22	0.03371 80	0.02789 30	0.01334 63	0.00704 98
1.92	0.04167 18	0.03329 86	0.02755 79	0.01320 07	0.00697 62
1.93	0.04112 91	0.03288 46	0.02722 70	0.01305 67	0.00690 33
1.94	0.04059 38	0.03247 59	0.02690 02	0.01291 43	0.00683 12
1.95	0.04006 60	0.03207 27	0.02657 75	0.01277 34	0.00675 99
1.96	0.03954 55	0.03167 46	0.02625 87	0.01263 41	0.00668 93
1.97	0.03903 22	0.03128 17	0.02594 40	0.01249 64	0.00661 95
1.98	0.03852 59	0.03089 39	0.02563 31	0.01236 01	0.00655 04
1.99	0.03802 67	0.03051 12	0.02532 61	0.01222 54	0.00648 20
2.00	0.03753 43 $\left[\begin{smallmatrix} (-6)2 \\ 3 \end{smallmatrix} \right]$	0.03013 34 $\left[\begin{smallmatrix} (-6)1 \\ 3 \end{smallmatrix} \right]$	0.02502 28 $\left[\begin{smallmatrix} (-7)8 \\ 3 \end{smallmatrix} \right]$	0.01209 21 $\left[\begin{smallmatrix} (-7)3 \\ 3 \end{smallmatrix} \right]$	0.00641 43 $\left[\begin{smallmatrix} (-7)1 \\ 3 \end{smallmatrix} \right]$

Table 5.5 EXPONENTIAL INTEGRALS $E_n(x)$ FOR LARGE ARGUMENTS

$x-1$	$(x+2)e^x E_2(x)$	$(x+3)e^x E_3(x)$	$(x+4)e^x E_4(x)$	$(x+10)e^x E_{10}(x)$	$(x+20)e^x E_{20}(x)$	$\langle x \rangle$
0.50	1.10937	1.11329	1.10937	1.07219	1.04270	2
0.45	1.09750	1.10285	1.10071	1.06926	1.04179	2
0.40	1.08533	1.09185	1.09136	1.06586	1.04067	3
0.35	1.07292	1.08026	1.08125	1.06187	1.03932	3
0.30	1.06034	1.06808	1.07031	1.05712	1.03762	3
0.25	1.04770	1.05536	1.05850	1.05138	1.03543	4
0.20	1.03522	1.04222	1.04584	1.04432	1.03249	5
0.15	1.02325	1.02895	1.03247	1.03550	1.02837	7
0.10	1.01240	1.01617	1.01889	1.02436	1.02222	10
0.09	1.01045	1.01377	1.01624	1.02182	1.02060	11
0.08	1.00861	1.01147	1.01366	1.01917	1.01883	13
0.07	1.00688	1.00927	1.01116	1.01642	1.01688	14
0.06	1.00528	1.00721	1.00878	1.01360	1.01472	17
0.05	1.00384	1.00531	1.00654	1.01074	1.01234	20
0.04	1.00258	1.00361	1.00451	1.00790	1.00973	25
0.03	1.00152	1.00217	1.00275	1.00516	1.00692	33
0.02	1.00071	1.00103	1.00133	1.00271	1.00401	50
0.01	1.00019	1.00027	1.00036	1.00081	1.00137	100
0.00	1.00000 $\left[\begin{smallmatrix} (-4)1 \\ 4 \end{smallmatrix} \right]$	1.00000 $\left[\begin{smallmatrix} (-5)7 \\ 4 \end{smallmatrix} \right]$	1.00000 $\left[\begin{smallmatrix} (-4)1 \\ 4 \end{smallmatrix} \right]$	1.00000 $\left[\begin{smallmatrix} (-4)3 \\ 4 \end{smallmatrix} \right]$	1.00000 $\left[\begin{smallmatrix} (-4)3 \\ 4 \end{smallmatrix} \right]$	∞

$\langle x \rangle$ - nearest integer to x .

EXPONENTIAL INTEGRAL FOR COMPLEX ARGUMENTS Table 5.6

$y \backslash x$	$ze^z E_1(z)$									
	11		12		13		14		15	
0	0.922260	0.000000	0.927914	0.000000	0.932796	0.000000	0.937055	0.000000	0.940804	0.000000
1	0.922740	0.006063	0.928295	0.005212	0.933105	0.004528	0.937308	0.003972	0.941014	0.003512
2	0.924143	0.011902	0.929416	0.010258	0.934013	0.008932	0.938055	0.007847	0.941636	0.006949
3	0.926370	0.017321	0.931205	0.014991	0.935473	0.013098	0.939261	0.011540	0.942643	0.010242
4	0.929270	0.022171	0.933560	0.019295	0.937408	0.016934	0.940870	0.014974	0.943994	0.013331
5	0.932672	0.026361	0.936356	0.023091	0.939729	0.020373	0.942816	0.018095	0.945640	0.016169
6	0.936400	0.029857	0.939462	0.026339	0.942338	0.023378	0.945024	0.020867	0.947522	0.018725
7	0.940297	0.032670	0.942757	0.029036	0.945140	0.025934	0.947419	0.023273	0.949589	0.020980
8	0.944229	0.034847	0.946132	0.031205	0.948047	0.028052	0.949933	0.025315	0.951765	0.022931
9	0.948093	0.036453	0.949500	0.032887	0.950985	0.029756	0.952502	0.027004	0.954018	0.024582
10	0.951816	0.037566	0.952792	0.034134	0.953895	0.031081	0.955075	0.028365	0.956296	0.025949
11	0.955347	0.038261	0.955958	0.035004	0.956729	0.032068	0.957610	0.029426	0.958563	0.027052
12	0.958659	0.038612	0.958968	0.035552	0.959454	0.032761	0.960073	0.030221	0.960787	0.027915
13	0.961739	0.038684	0.961800	0.035833	0.962049	0.033201	0.962443	0.030781	0.962947	0.028564
14	0.964583	0.038534	0.964447	0.035893	0.964499	0.033428	0.964702	0.031140	0.965026	0.029024
15	0.967199	0.038211	0.966907	0.035775	0.966799	0.033479	0.966843	0.031327	0.967011	0.029320
16	0.969597	0.037756	0.969184	0.035515	0.968947	0.033384	0.968860	0.031370	0.968897	0.029476
17	0.971789	0.037200	0.971285	0.035144	0.970946	0.033172	0.970752	0.031293	0.970680	0.029512
18	0.973792	0.036572	0.973220	0.034687	0.972802	0.032865	0.972521	0.031117	0.972359	0.029448
19	0.975621	0.035893	0.974999	0.034166	0.974521	0.032485	0.974172	0.030862	0.973936	0.029301
20	0.977290	0.035179	0.976634	0.033597	0.976112	0.032049	0.975709	0.030542	0.975414	0.029086
16	0.944130	0.000000	0.947100	0.000000	0.949769	0.000000	0.952181	0.000000	0.954371	0.000000
1	0.944306	0.003128	0.947250	0.002804	0.949897	0.002527	0.952291	0.002290	0.954467	0.002085
2	0.944829	0.006196	0.947693	0.005560	0.950277	0.005016	0.952619	0.004549	0.954752	0.004144
3	0.945678	0.009150	0.948416	0.008223	0.950898	0.007430	0.953156	0.006745	0.955219	0.006151
4	0.946824	0.011940	0.949395	0.010754	0.951741	0.009735	0.953887	0.008853	0.955856	0.008084
5	0.948226	0.014529	0.950600	0.013121	0.952782	0.011904	0.954793	0.010847	0.956650	0.009922
6	0.949842	0.016886	0.951995	0.015296	0.953995	0.013916	0.955853	0.012709	0.957581	0.011649
7	0.951624	0.018994	0.953545	0.017265	0.955349	0.015753	0.957043	0.014425	0.958631	0.013253
8	0.953527	0.020847	0.955212	0.019019	0.956815	0.017409	0.958337	0.015986	0.959779	0.014723
9	0.955509	0.022445	0.956960	0.020555	0.958363	0.018878	0.959712	0.017387	0.961004	0.016056
10	0.957530	0.023797	0.958758	0.021878	0.959966	0.020163	0.961144	0.018628	0.962288	0.017250
11	0.959559	0.024917	0.960576	0.022998	0.961598	0.021270	0.962612	0.019712	0.963611	0.018305
12	0.961568	0.025823	0.962391	0.023927	0.963238	0.022207	0.964097	0.020645	0.964956	0.019227
13	0.963534	0.026534	0.964181	0.024679	0.964868	0.022984	0.965582	0.021436	0.966310	0.020021
14	0.965443	0.027070	0.965931	0.025271	0.966472	0.023616	0.967052	0.022094	0.967658	0.020694
15	0.967280	0.027453	0.967628	0.025720	0.968039	0.024114	0.968496	0.022629	0.968990	0.021255
16	0.969038	0.027700	0.969264	0.026041	0.969558	0.024493	0.969906	0.023052	0.970297	0.021712
17	0.970712	0.027831	0.970832	0.026249	0.971023	0.024765	0.971273	0.023375	0.971571	0.022075
18	0.972300	0.027862	0.972328	0.026361	0.972430	0.024943	0.972594	0.023607	0.972808	0.022352
19	0.973800	0.027809	0.973751	0.026388	0.973775	0.025038	0.973863	0.023760	0.974004	0.022552
20	0.975215	0.027685	0.975099	0.026343	0.975057	0.025062	0.975079	0.023842	0.975155	0.022684

EXPONENTIAL INTEGRAL FOR SMALL COMPLEX ARGUMENTS Table 5.7

$y \backslash x$	$e^z E_1(z)$									
	-4.0		-3.5		-3.0		-2.5		-2.0	
0.0	-0.359552	-0.057540	-0.420509	-0.094868	-0.494576	-0.156411	-0.580650	-0.257878	-0.670483	-0.425168
0.2	-0.347179	-0.078283	-0.400596	-0.119927	-0.462493	-0.185573	-0.528987	-0.289009	-0.587558	-0.451225
0.4	-0.333373	-0.096648	-0.379278	-0.141221	-0.429554	-0.208800	-0.478303	-0.310884	-0.510543	-0.463193
0.6	-0.318556	-0.112633	-0.357202	-0.158890	-0.396730	-0.226575	-0.429978	-0.324774	-0.441128	-0.464163
0.8	-0.303109	-0.126301	-0.334923	-0.173169	-0.364785	-0.239500	-0.384941	-0.332047	-0.380013	-0.457088
1.0	-0.287369	-0.137768	-0.312894	-0.184355	-0.334280	-0.248231	-0.343719	-0.334043	-0.327140	-0.444528
0.0	-4.261087	0.000000	-2.895820	0.000000	-1.895118	0.000000	-1.147367	0.000000	-0.577216	0.000000
0.2	-4.219228	0.636779	-2.867070	0.462804	-1.875155	0.342700	-1.133341	0.258840	-0.567232	0.199556
0.4	-4.094686	1.260867	-2.781497	0.917127	-1.815717	0.679691	-1.091560	0.513806	-0.537482	0.396461
0.6	-3.890531	1.859922	-2.641121	1.354712	-1.718135	1.005410	-1.022911	0.761122	-0.488555	0.588128
0.8	-3.611783	2.422284	-2.449241	1.767748	-1.584591	1.314586	-0.928842	0.997200	-0.421423	0.772095
1.0	-3.265262	2.937296	-2.210344	2.149077	-1.418052	1.602372	-0.811327	1.218731	-0.337404	0.946083
0.0	-0.133374	0.000000	0.219384	0.000000	0.505485	0.000000	0.742048	0.000000	0.941206	0.000000
0.2	-0.126168	0.157081	0.224661	0.126210	0.509410	0.103432	0.745014	0.086359	0.943484	0.073355
0.4	-0.104687	0.312331	0.240402	0.251143	0.521123	0.205962	0.753871	0.172075	0.950289	0.146246
0.6	-0.069328	0.463961	0.266336	0.373547	0.540441	0.306707	0.768490	0.256515	0.961532	0.218215
0.8	-0.020743	0.610264	0.302022	0.492229	0.567061	0.404823	0.788664	0.339075	0.977068	0.288822
1.0	+0.040177	0.749655	0.346856	0.606074	0.600568	0.499516	0.814107	0.419185	0.996699	0.357653

6. Gamma Function and Related Functions

PHILIP J. DAVIS¹

Contents

	Page
Mathematical Properties.	255
6.1. Gamma Function.	255
6.2. Beta Function	258
6.3. Psi (Digamma) Function.	258
6.4. Polygamma Functions.	260
6.5. Incomplete Gamma Function.	260
6.6. Incomplete Beta Function.	263
Numerical Methods	263
6.7. Use and Extension of the Tables.	263
6.8. Summation of Rational Series by Means of Polygamma Functions.	264
References.	265
Table 6.1. Gamma, Digamma and Trigamma Functions ($1 \leq x \leq 2$)	267
$\Gamma(x), \ln \Gamma(x), \psi(x), \psi'(x), x=1(.005)2, 10D$	
Table 6.2. Tetragamma and Pentagamma Functions ($1 \leq x \leq 2$)	271
$\psi''(x), \psi^{(3)}(x), x=1(.01)2, 10D$	
Table 6.3. Gamma and Digamma Functions for Integer and Half-Integer Values ($1 \leq n \leq 101$)	272
$\Gamma(n), 11S \quad \psi(n), 10D$	
$1/\Gamma(n), 9S \quad n!/[(2\pi)^{\frac{1}{2}} n^{n+\frac{1}{2}}] e^{-n}, 8D$	
$\Gamma(n+\frac{1}{2}), 8S \quad \ln n - \psi(n), 8D$	
$n=1(1)101$	
Table 6.4. Logarithms of the Gamma Function ($1 \leq n \leq 101$).	274
$\log_{10} \Gamma(n), 8S \quad \log_{10} \Gamma(n+\frac{2}{3}), 8S$	
$\log_{10} \Gamma(n+\frac{1}{3}), 8S \quad \ln \Gamma(n) - (n-\frac{1}{2}) \ln n + n, 8D$	
$\log_{10} \Gamma(n+\frac{1}{2}), 8S$	
$n=1(1)101$	

¹ National Bureau of Standards.

	Page
Table 6.5. Auxiliary Functions for Gamma and Digamma Functions ($66 \leq x \leq \infty$)	276
$x! / [(2\pi)^{\frac{1}{2}} x^{x+\frac{1}{2}} e^{-x}], \ln \Gamma(x) - (x - \frac{1}{2}) \ln x + x, \ln x - \psi(x)$ $x^{-1} = .015 (-.001)0, \quad 8D$	
Table 6.6. Factorials for Large Arguments ($100 \leq n \leq 1000$)	276
$n!, n = 100(100)1000, \quad 20S$	
Table 6.7. Gamma Function for Complex Arguments	277
$\ln \Gamma(x + iy), x = 1(.1)2, y = 0(.1)10, \quad 12D$	
Table 6.8. Digamma Function for Complex Arguments	288
$\psi(x + iy), x = 1(.1)2, y = 0(.1)10, \quad 5D$ $\Re \psi(1 + iy), \quad 10D$ $\Re \psi(1 + iy) - \ln y, y^{-1} = .11 (-.01)0, \quad 8D$	

The author acknowledges the assistance of Mary Orr in the preparation and checking of the tables; and the assistance of Patricia Farrant in checking the formulas.

6. Gamma Function and Related Functions

Mathematical Properties

6.1. Gamma (Factorial) Function

Euler's Integral

$$6.1.1 \quad \Gamma(z) = \int_0^{\infty} t^{z-1} e^{-t} dt \quad (\Re z > 0)$$

$$= k^z \int_0^{\infty} t^{z-1} e^{-kt} dt \quad (\Re z > 0, \Re k > 0)$$

Euler's Formula

$$6.1.2 \quad \Gamma(z) = \lim_{n \rightarrow \infty} \frac{n! n^z}{z(z+1) \dots (z+n)} \quad (z \neq 0, -1, -2, \dots)$$

Euler's Infinite Product

$$6.1.3 \quad \frac{1}{\Gamma(z)} = z e^{\gamma z} \prod_{n=1}^{\infty} \left[\left(1 + \frac{z}{n}\right) e^{-z/n} \right] \quad (|z| < \infty)$$

$$\gamma = \lim_{m \rightarrow \infty} \left[1 + \frac{1}{2} + \frac{1}{3} + \frac{1}{4} + \dots + \frac{1}{m} - \ln m \right]$$

$$= .57721\ 56649 \dots$$

γ is known as Euler's constant and is given to 25 decimal places in chapter 1. $\Gamma(z)$ is single valued and analytic over the entire complex plane, save for the points $z = -n$ ($n = 0, 1, 2, \dots$) where it possesses simple poles with residue $(-1)^n/n!$. Its reciprocal $1/\Gamma(z)$ is an entire function possessing simple zeros at the points $z = -n$ ($n = 0, 1, 2, \dots$).

Hankel's Contour Integral

$$6.1.4 \quad \frac{1}{\Gamma(z)} = \frac{i}{2\pi} \int_C (-t)^{-z} e^{-t} dt \quad (|z| < \infty)$$

The path of integration C starts at $+\infty$ on the real axis, circles the origin in the counterclockwise direction and returns to the starting point.

Factorial and Π Notations

$$6.1.5 \quad \Pi(z) = z! = \Gamma(z+1)$$

Integer Values

$$6.1.6 \quad \Gamma(n+1) = 1 \cdot 2 \cdot 3 \dots (n-1)n = n!$$

6.1.7

$$\lim_{z \rightarrow n} \frac{1}{\Gamma(-z)} = 0 = \frac{1}{(-n-1)!} \quad (n = 0, 1, 2, \dots)$$

Fractional Values

$$6.1.8 \quad \Gamma\left(\frac{1}{2}\right) = 2 \int_0^{\infty} e^{-t^2} dt = \pi^{\frac{1}{2}} = 1.77245\ 38509 \dots = \left(-\frac{1}{2}\right)!$$

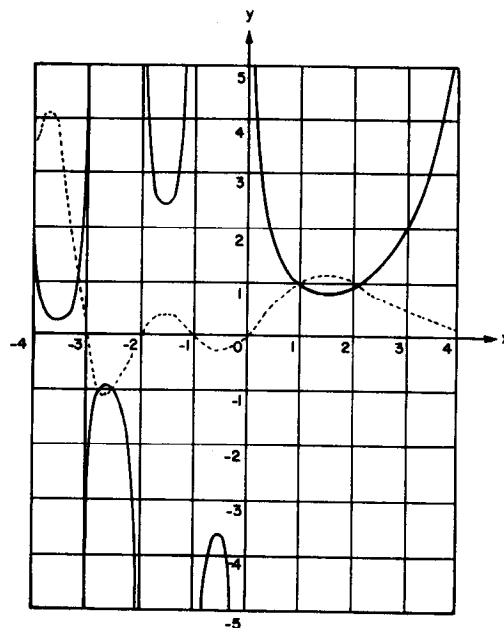

FIGURE 6.1. Gamma function. *

—, $y = \Gamma(x)$, - - - - , $y = 1/\Gamma(x)$

$$6.1.9 \quad \Gamma\left(\frac{3}{2}\right) = \frac{1}{2} \pi^{\frac{1}{2}} = .88622\ 69254 \dots = \left(\frac{1}{2}\right)!$$

$$6.1.10 \quad \Gamma\left(n + \frac{1}{2}\right) = \frac{1 \cdot 5 \cdot 9 \cdot 13 \dots (4n-3)}{4^n} \Gamma\left(\frac{1}{2}\right)$$

$$\Gamma\left(\frac{1}{2}\right) = 3.62560\ 99082 \dots$$

$$6.1.11 \quad \Gamma\left(n + \frac{1}{3}\right) = \frac{1 \cdot 4 \cdot 7 \cdot 10 \dots (3n-2)}{3^n} \Gamma\left(\frac{1}{3}\right)$$

$$\Gamma\left(\frac{1}{3}\right) = 2.67893\ 85347 \dots$$

$$6.1.12 \quad \Gamma\left(n + \frac{1}{2}\right) = \frac{1 \cdot 3 \cdot 5 \cdot 7 \dots (2n-1)}{2^n} \Gamma\left(\frac{1}{2}\right)$$

$$6.1.13 \quad \Gamma\left(n + \frac{2}{3}\right) = \frac{2 \cdot 5 \cdot 8 \cdot 11 \dots (3n-1)}{3^n} \Gamma\left(\frac{2}{3}\right)$$

$$\Gamma\left(\frac{2}{3}\right) = 1.35411\ 79394 \dots$$

$$6.1.14 \quad \Gamma\left(n + \frac{3}{4}\right) = \frac{3 \cdot 7 \cdot 11 \cdot 15 \dots (4n-1)}{4^n} \Gamma\left(\frac{3}{4}\right)$$

$$\Gamma\left(\frac{3}{4}\right) = 1.22541\ 67024 \dots$$

*See page II.

*Demo
Positive*

Recurrence Formulas

6.1.15 $\Gamma(z+1) = z\Gamma(z) = z! = z(z-1)!$

6.1.16

$$\Gamma(n+z) = (n-1+z)(n-2+z) \dots (1+z)\Gamma(1+z)$$

$$= (n-1+z)!$$

$$= (n-1+z)(n-2+z) \dots (1+z)z!$$

Reflection Formula

6.1.17 $\Gamma(z)\Gamma(1-z) = -z\Gamma(-z)\Gamma(z) = \pi \csc \pi z$

$$= \int_0^{\infty} \frac{t^{z-1}}{1+t} dt \quad (0 < \Re z < 1)$$

Duplication Formula

6.1.18 $\Gamma(2z) = (2\pi)^{-\frac{1}{2}} 2^{2z-\frac{1}{2}} \Gamma(z) \Gamma(z+\frac{1}{2})$

Triplification Formula

6.1.19 $\Gamma(3z) = (2\pi)^{-1} 3^{3z-\frac{1}{2}} \Gamma(z) \Gamma(z+\frac{1}{3}) \Gamma(z+\frac{2}{3})$

Gauss' Multiplication Formula

6.1.20 $\Gamma(nz) = (2\pi)^{\frac{1}{2}(1-n)} n^{nz-\frac{1}{2}} \prod_{k=0}^{n-1} \Gamma(z + \frac{k}{n})$

Binomial Coefficient

6.1.21 $\binom{z}{w} = \frac{z!}{w!(z-w)!} = \frac{\Gamma(z+1)}{\Gamma(w+1)\Gamma(z-w+1)}$

Pochhammer's Symbol

6.1.22

$(z)_0 = 1,$

$$(z)_n = z(z+1)(z+2) \dots (z+n-1) = \frac{\Gamma(z+n)}{\Gamma(z)}$$

Gamma Function in the Complex Plane

6.1.23 $\Gamma(\bar{z}) = \overline{\Gamma(z)}; \ln \Gamma(\bar{z}) = \overline{\ln \Gamma(z)}$

6.1.24 $\arg \Gamma(z+1) = \arg \Gamma(z) + \arctan \frac{y}{x}$

6.1.25 $\left| \frac{\Gamma(x+iy)}{\Gamma(x)} \right|^2 = \prod_{n=0}^{\infty} \left[1 + \frac{y^2}{(x+n)^2} \right]^{-1}$

6.1.26 $|\Gamma(x+iy)| \leq |\Gamma(x)|$

6.1.27

$$\arg \Gamma(x+iy) = \mathcal{N}(x) + \sum_{n=0}^{\infty} \left(\frac{y}{x+n} - \arctan \frac{y}{x+n} \right)$$

$(x+iy \neq 0, -1, -2, \dots)$

where $\psi(z) = \Gamma'(z)/\Gamma(z)$

6.1.28 $\Gamma(1+iy) = iy \Gamma(iy)$

6.1.29 $\Gamma(iy)\Gamma(-iy) = |\Gamma(iy)|^2 = \frac{\pi}{y \sinh \pi y}$

6.1.30 $\Gamma(\frac{1}{2}+iy)\Gamma(\frac{1}{2}-iy) = |\Gamma(\frac{1}{2}+iy)|^2 = \frac{\pi}{\cosh \pi y}$

6.1.31 $\Gamma(1+iy)\Gamma(1-iy) = |\Gamma(1+iy)|^2 = \frac{\pi y}{\sinh \pi y}$

6.1.32 $\Gamma(\frac{1}{4}+iy)\Gamma(\frac{3}{4}-iy) = \frac{\pi\sqrt{2}}{\cosh \pi y + i \sinh \pi y}$

Power Series

6.1.33

$$\ln \Gamma(1+z) = -\ln(1+z) + z(1-\gamma)$$

$$+ \sum_{n=2}^{\infty} (-1)^n [\zeta(n)-1] z^n/n \quad (|z| < 2)$$

$\zeta(n)$ is the Riemann Zeta Function (see chapter 23).

Series Expansion² for $1/\Gamma(z)$

6.1.34 $\frac{1}{\Gamma(z)} = \sum_{k=1}^{\infty} c_k z^k \quad (|z| < \infty)$

k	c_k
1	1.00000 00000 000000
2	0.57721 56649 015329
3	-0.65587 80715 202538
4	-0.04200 26350 340952
5	0.16653 86113 822915
6	-0.04219 77345 555443
7	-0.00962 19715 278770
8	0.00721 89432 466630
9	-0.00116 51675 918591
10	-0.00021 52416 741149
11	0.00012 80502 823882
12	-0.00002 01348 547807
13	-0.00000 12504 934821
14	0.00000 11330 272320
15	-0.00000 02056 338417
16	0.00000 00061 160950
17	0.00000 00050 020075
18	-0.00000 00011 812746
19	0.00000 00001 043427
20	0.00000 00000 077823
21	-0.00000 00000 036968
22	0.00000 00000 005100
23	-0.00000 00000 000206
24	-0.00000 00000 000054
25	0.00000 00000 000014
26	0.00000 00000 000001

² The coefficients c_k are from H. T. Davis, Tables of higher mathematical functions, 2 vols., Principia Press, Bloomington, Ind., 1933, 1935 (with permission); with corrections due to H. E. Salzer.

Polynomial Approximations³

6.1.35 $0 \leq x \leq 1$

$$\Gamma(x+1) = x! = 1 + a_1x + a_2x^2 + a_3x^3 + a_4x^4 + a_5x^5 + \epsilon(x)$$

$$|\epsilon(x)| \leq 5 \times 10^{-5}$$

$$\begin{aligned} a_1 &= -.57486\ 46 & a_4 &= .42455\ 49 \\ a_2 &= .95123\ 63 & a_5 &= -.10106\ 78 \\ a_3 &= -.69985\ 88 \end{aligned}$$

6.1.36 $0 \leq x \leq 1$

$$\Gamma(x+1) = x! = 1 + b_1x + b_2x^2 + \dots + b_8x^8 + \epsilon(x)$$

$$|\epsilon(x)| \leq 3 \times 10^{-7}$$

$$\begin{aligned} b_1 &= -.57719\ 1652 & b_5 &= -.75670\ 4078 \\ b_2 &= .98820\ 5891 & b_6 &= .48219\ 9394 \\ b_3 &= -.89705\ 6937 & b_7 &= -.19352\ 7818 \\ b_4 &= .91820\ 6857 & b_8 &= .03586\ 8343 \end{aligned}$$

Stirling's Formula

6.1.37

$$\Gamma(z) \sim e^{-z} z^{z-\frac{1}{2}} (2\pi)^{\frac{1}{2}} \left[1 + \frac{1}{12z} + \frac{1}{288z^2} - \frac{139}{51840z^3} - \frac{571}{2488320z^4} + \dots \right] \quad (z \rightarrow \infty \text{ in } |\arg z| < \pi)$$

6.1.38

$$x! = \sqrt{2\pi} x^{x+\frac{1}{2}} \exp\left(-x + \frac{\theta}{12x}\right) \quad (x > 0, 0 < \theta < 1)$$

Asymptotic Formulas

6.1.39

$$\Gamma(az+b) \sim \sqrt{2\pi} e^{-az} (az)^{az+b-\frac{1}{2}} \quad (|\arg z| < \pi, a > 0)$$

6.1.40

$$\ln \Gamma(z) \sim (z - \frac{1}{2}) \ln z - z + \frac{1}{2} \ln(2\pi) + \sum_{m=1}^{\infty} \frac{B_{2m}}{2m(2m-1)z^{2m-1}} \quad (z \rightarrow \infty \text{ in } |\arg z| < \pi)$$

For B_n see chapter 23

6.1.41

$$\ln \Gamma(z) \sim (z - \frac{1}{2}) \ln z - z + \frac{1}{2} \ln(2\pi) + \frac{1}{12z} - \frac{1}{360z^3} + \frac{1}{1260z^5} - \frac{1}{1680z^7} + \dots \quad (z \rightarrow \infty \text{ in } |\arg z| < \pi)$$

³ From C. Hastings, Jr., Approximations for digital computers, Princeton Univ. Press, Princeton, N.J., 1955 (with permission).

Error Term for Asymptotic Expansion

6.1.42

If

$$R_n(z) = \ln \Gamma(z) - (z - \frac{1}{2}) \ln z + z - \frac{1}{2} \ln(2\pi) - \sum_{m=1}^n \frac{B_{2m}}{2m(2m-1)z^{2m-1}}$$

then

$$|R_n(z)| \leq \frac{|B_{2n+2}|K(z)}{(2n+1)(2n+2)|z|^{2n+1}}$$

where

$$K(z) = \text{upper bound } |z^2/(u^2+z^2)|_{u \geq 0}$$

For z real and positive, R_n is less in absolute value than the first term neglected and has the same sign.

6.1.43

$$\begin{aligned} \mathcal{H} \ln \Gamma(iy) &= \mathcal{H} \ln \Gamma(-iy) \\ &= \frac{1}{2} \ln \left(\frac{\pi}{y \sinh \pi y} \right) \\ &\sim \frac{1}{2} \ln(2\pi) - \frac{1}{2} \pi y - \frac{1}{2} \ln y, \quad (y \rightarrow +\infty) \end{aligned}$$

6.1.44

$$\begin{aligned} \mathcal{J} \ln \Gamma(iy) &= \arg \Gamma(iy) = -\arg \Gamma(-iy) \\ &= -\mathcal{J} \ln \Gamma(-iy) \\ &\sim y \ln y - y - \frac{1}{4} \pi - \sum_{n=1}^{\infty} \frac{(-1)^{n-1} B_{2n}}{(2n-1)(2n)y^{2n-1}} \quad (y \rightarrow +\infty) \end{aligned}$$

6.1.45 $\lim_{|y| \rightarrow \infty} (2\pi)^{-\frac{1}{2}} |\Gamma(x+iy)| e^{\frac{1}{2}\pi|y|} |y|^{\frac{1}{2}-x} = 1$

6.1.46 $\lim_{n \rightarrow \infty} n^{b-a} \frac{\Gamma(n+a)}{\Gamma(n+b)} = 1$

6.1.47

$$\begin{aligned} z^{b-a} \frac{\Gamma(z+a)}{\Gamma(z+b)} &\sim 1 + \frac{(a-b)(a+b-1)}{2z} \\ &\quad + \frac{1}{12} \binom{a-b}{2} \left(3(a+b-1)^2 - a+b-1 \right) \frac{1}{z^2} + \dots \end{aligned}$$

as $z \rightarrow \infty$ along any curve joining $z=0$ and $z=\infty$, providing $z \neq -a, -a-1, \dots; z \neq -b, -b-1, \dots$

Continued Fraction

6.1.48

$$\ln \Gamma(z) + z - (z - \frac{1}{2}) \ln z - \frac{1}{2} \ln(2\pi) = \frac{a_0}{z +} \frac{a_1}{z +} \frac{a_2}{z +} \frac{a_3}{z +} \frac{a_4}{z +} \frac{a_5}{z +} \dots \quad (\Re z > 0)$$

$$a_0 = \frac{1}{12}, a_1 = \frac{1}{30}, a_2 = \frac{53}{210}, a_3 = \frac{195}{371}$$

$$a_4 = \frac{22999}{22737}, a_5 = \frac{29944523}{19733142}, a_6 = \frac{109535241009}{48264275462}$$

Wallis' Formula⁴

6.1.49

$$\begin{aligned} \frac{2}{\pi} \int_0^{\pi/2} (\sin x)^{2n} dx &= \frac{1 \cdot 3 \cdot 5 \dots (2n-1)}{2 \cdot 4 \cdot 6 \dots (2n)} \\ &= \frac{(2n)!}{2^{2n} (n!)^2} = \frac{1}{2^{2n}} \binom{2n}{n} = \frac{\Gamma(n + \frac{1}{2})}{\pi^{1/2} \Gamma(n+1)} \\ &\sim \frac{1}{\pi^{1/2} n^{1/2}} \left[1 - \frac{1}{8n} + \frac{1}{128n^2} - \dots \right] \end{aligned} \quad (n \rightarrow \infty)$$

Some Definite Integrals

6.1.50

$$\begin{aligned} \ln \Gamma(z) &= \int_0^\infty \left[(z-1) e^{-t} - \frac{e^{-t} - e^{-zt}}{1 - e^{-t}} \right] \frac{dt}{t} \quad (\Re z > 0) \\ &= (z - \frac{1}{2}) \ln z - z + \frac{1}{2} \ln 2\pi \\ &\quad + 2 \int_0^\infty \frac{\arctan(t/z)}{e^{2\pi t} - 1} dt \quad (\Re z > 0) \end{aligned}$$

6.2. Beta Function

6.2.1

$$\begin{aligned} B(z, w) &= \int_0^1 t^{z-1} (1-t)^{w-1} dt = \int_0^\infty \frac{t^{z-1}}{(1+t)^{z+w}} dt \\ &= 2 \int_0^{\pi/2} (\sin t)^{2z-1} (\cos t)^{2w-1} dt \end{aligned} \quad (\Re z > 0, \Re w > 0)$$

6.2.2 $B(z, w) = \frac{\Gamma(z)\Gamma(w)}{\Gamma(z+w)} = B(w, z)$

6.3. Psi (Digamma) Function⁵

6.3.1 $\psi(z) = d[\ln \Gamma(z)]/dz = \Gamma'(z)/\Gamma(z)$

⁴ Some authors employ the special double factorial notation as follows:

$$\begin{aligned} (2n)!! &= 2 \cdot 4 \cdot 6 \dots (2n) = 2^n n! \\ (2n-1)!! &= 1 \cdot 3 \cdot 5 \dots (2n-1) = \pi^{-1/2} 2^n \Gamma(n + \frac{1}{2}) \end{aligned}$$

⁵ Some authors write $\psi(z) = \frac{d}{dz} \ln \Gamma(z+1)$ and similarly for the polygamma functions.

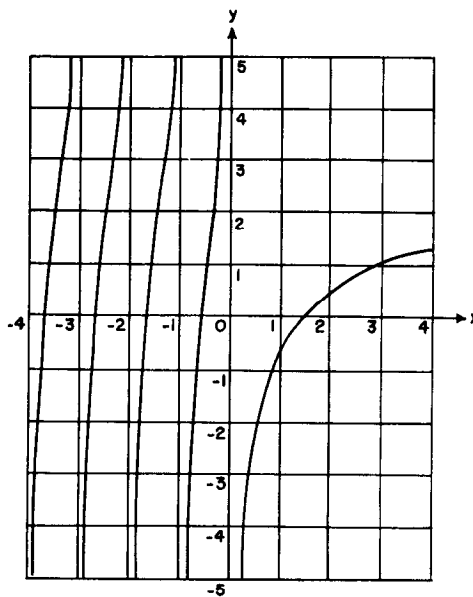

FIGURE 6.2. Psi function.

$y = \psi(x) = d \ln \Gamma(x) / dx$

Integer Values

6.3.2 $\psi(1) = -\gamma, \psi(n) = -\gamma + \sum_{k=1}^{n-1} k^{-1} \quad (n \geq 2)$

Fractional Values

6.3.3

$\psi(\frac{1}{2}) = -\gamma - 2 \ln 2 = -1.96351 00260 21423 \dots$

6.3.4

$\psi(n + \frac{1}{2}) = -\gamma - 2 \ln 2 + 2 \left(1 + \frac{1}{3} + \dots + \frac{1}{2n-1} \right) \quad (n \geq 1)$

Recurrence Formulas

6.3.5 $\psi(z+1) = \psi(z) + \frac{1}{z}$

6.3.6

$$\begin{aligned} \psi(n+z) &= \frac{1}{(n-1)+z} + \frac{1}{(n-2)+z} + \dots \\ &\quad + \frac{1}{2+z} + \frac{1}{1+z} + \psi(1+z) \end{aligned}$$

Reflection Formula

6.3.7 $\psi(1-z) = \psi(z) + \pi \cot \pi z$

Duplication Formula

6.3.8 $\psi(2z) = \frac{1}{2}\psi(z) + \frac{1}{2}\psi(z + \frac{1}{2}) + \ln 2$

Psi Function in the Complex Plane

6.3.9 $\psi(\bar{z}) = \overline{\psi(z)}$

6.3.10

$\Re \psi(iy) = \Re \psi(-iy) = \Re \psi(1+iy) = \Re \psi(1-iy)$

6.3.11 $\Im \psi(iy) = \frac{1}{2}y^{-1} + \frac{1}{2}\pi \coth \pi y$

6.3.12 $\Im \psi(\frac{1}{2} + iy) = \frac{1}{2}\pi \tanh \pi y$

6.3.13 $\Im \psi(1+iy) = -\frac{1}{2y} + \frac{1}{2}\pi \coth \pi y$
 $= y \sum_{n=1}^{\infty} (n^2 + y^2)^{-1}$

Series Expansions

6.3.14 $\psi(1+z) = -\gamma + \sum_{n=2}^{\infty} (-1)^n \zeta(n) z^{n-1} \quad (|z| < 1)$

6.3.15

$\psi(1+z) = \frac{1}{2}z^{-1} - \frac{1}{2}\pi \cot \pi z - (1-z^2)^{-1} + 1 - \gamma$
 $- \sum_{n=1}^{\infty} [\zeta(2n+1) - 1] z^{2n} \quad (|z| < 2)$

6.3.16

$\psi(1+z) = -\gamma + \sum_{n=1}^{\infty} \frac{z}{n(n+z)} \quad (z \neq -1, -2, -3, \dots)$

6.3.17

$\Re \psi(1+iy) = 1 - \gamma - \frac{1}{1+y^2}$
 $+ \sum_{n=1}^{\infty} (-1)^{n+1} [\zeta(2n+1) - 1] y^{2n} \quad (|y| < 2)$
 $= -\gamma + y^2 \sum_{n=1}^{\infty} n^{-1} (n^2 + y^2)^{-1} \quad (-\infty < y < \infty)$

Asymptotic Formulas

6.3.18

$\psi(z) \sim \ln z - \frac{1}{2z} - \sum_{n=1}^{\infty} \frac{B_{2n}}{2nz^{2n}}$
 $= \ln z - \frac{1}{2z} - \frac{1}{12z^2} + \frac{1}{120z^4} - \frac{1}{252z^6} + \dots$
 $(z \rightarrow \infty \text{ in } |\arg z| < \pi)$

6.3.19

$\Re \psi(1+iy) \sim \ln y + \sum_{n=1}^{\infty} \frac{(-1)^{n-1} B_{2n}}{2ny^{2n}}$
 $= \ln y + \frac{1}{12y^2} + \frac{1}{120y^4} + \frac{1}{252y^6} + \dots$
 $(y \rightarrow \infty)$

Extrema⁶ of $\Gamma(x)$ — Zeros of $\psi(x)$

$\Gamma'(x_n) = \psi(x_n) = 0$

n	x_n	$\Gamma(x_n)$
0	+1.462	+0.886
1	-0.504	-3.545
2	-1.573	+2.302
3	-2.611	-0.888
4	-3.635	+0.245
5	-4.653	-0.053
6	-5.667	+0.009
7	-6.678	-0.001

H 379
821

$x_0 = 1.46163 \quad 21449 \quad 68362 \approx 1 + \frac{6}{13}$
 $\Gamma(x_0) = .88560 \quad 31944 \quad 10889$

6.3.20 $x_n = -n + (\ln n)^{-1} + o[(\ln n)^{-2}]$

Definite Integrals

6.3.21

$\psi(z) = \int_0^{\infty} \left[\frac{e^{-t}}{t} - \frac{e^{-zt}}{1-e^{-t}} \right] dt \quad (\Re z > 0)$
 $= \int_0^{\infty} \left[e^{-t} - \frac{1}{(1+t)^z} \right] \frac{dt}{t}$
 $= \ln z - \frac{1}{2z} - 2 \int_0^{\infty} \frac{t dt}{(t^2+z^2)(e^{2\pi t}-1)}$
 $(|\arg z| < \frac{\pi}{2})$

6.3.22

$\psi(z) + \gamma = \int_0^{\infty} \frac{e^{-t} - e^{-zt}}{1-e^{-t}} dt = \int_0^1 \frac{1-t^{z-1}}{1-t} dt$
 $\gamma = \int_0^{\infty} \left(\frac{1}{e^t-1} - \frac{1}{te^t} \right) dt$
 $= \int_0^{\infty} \left(\frac{1}{1+t} - e^{-t} \right) \frac{dt}{t}$

⁶ From W. Sibagaki, Theory and applications of the gamma function, Iwanami Syoten, Tokyo, Japan, 1952 (with permission).

6.4. Polygamma Functions⁷

6.4.1

$$\psi^{(n)}(z) = \frac{d^n}{dz^n} \psi(z) = \frac{d^{n+1}}{dz^{n+1}} \ln \Gamma(z) \quad (n=1, 2, 3, \dots)$$

$$= (-1)^{n+1} \int_0^\infty \frac{t^n e^{-zt}}{1 - e^{-t}} dt \quad (\Re z > 0)$$

$\psi^{(n)}(z)$, ($n=0, 1, \dots$), is a single valued analytic function over the entire complex plane save at the points $z = -m$ ($m=0, 1, 2, \dots$) where it possesses poles of order $(n+1)$.

Integer Values

6.4.2*

$$\psi^{(n)}(1) = (-1)^{n+1} n! \zeta(n+1) \quad (n=1, 2, 3, \dots)$$

6.4.3

$$\psi^{(m)}(n+1) = (-1)^m m! \left[-\zeta(m+1) + 1 + \frac{1}{2^{m+1}} + \dots + \frac{1}{n^{m+1}} \right]$$

Fractional Values

6.4.4

$$\psi^{(n)}\left(\frac{1}{2}\right) = (-1)^{n+1} n! (2^{n+1} - 1) \zeta(n+1) \quad (n=1, 2, \dots)$$

$$6.4.5 \quad \psi'(n + \frac{1}{2}) = \frac{1}{2} \pi^2 - 4 \sum_{k=1}^n (2k-1)^{-2}$$

Recurrence Formula

$$6.4.6 \quad \psi^{(n)}(z+1) = \psi^{(n)}(z) + (-1)^n n! z^{-n-1}$$

Reflection Formula

6.4.7

$$\psi^{(n)}(1-z) + (-1)^{n+1} \psi^{(n)}(z) = (-1)^n \pi \frac{d^n}{dz^n} \cot \pi z$$

Multiplication Formula

6.4.8

$$* \quad \psi^{(n)}(mz) = \delta \ln m + \frac{1}{m^{n+1}} \sum_{k=0}^{m-1} \psi^{(n)}\left(z + \frac{k}{m}\right)$$

$$\delta = 1, \quad n = 0$$

$$\delta = 0, \quad n > 0$$

⁷ ψ' is known as the trigamma function. ψ'' , $\psi^{(3)}$, $\psi^{(4)}$ are the tetra-, penta-, and hexagramma functions respectively. Some authors write $\psi(z) = d[\ln \Gamma(z+1)]/dz$, and similarly for the polygamma functions.

* See page II.

Series Expansions

6.4.9

$$\psi^{(n)}(1+z) = (-1)^{n+1} \left[n! \zeta(n+1) - \frac{(n+1)!}{1!} \zeta(n+2)z + \frac{(n+2)!}{2!} \zeta(n+3)z^2 - \dots \right] \quad (|z| < 1)$$

6.4.10

$$\psi^{(n)}(z) = (-1)^{n+1} n! \sum_{k=0}^{\infty} (z+k)^{-n-1} \quad (z \neq 0, -1, -2, \dots)$$

Asymptotic Formulas

6.4.11

$$\psi^{(n)}(z) \sim (-1)^{n-1} \left[\frac{(n-1)!}{z^n} + \frac{n!}{2z^{n+1}} + \sum_{k=1}^{\infty} B_{2k} \frac{(2k+n-1)!}{(2k)! z^{2k+n}} \right] \quad (z \rightarrow \infty \text{ in } |\arg z| < \pi)$$

6.4.12

$$\psi'(z) \sim \frac{1}{z} + \frac{1}{2z^2} + \frac{1}{6z^3} - \frac{1}{30z^5} + \frac{1}{42z^7} - \frac{1}{30z^9} + \dots \quad (z \rightarrow \infty \text{ in } |\arg z| < \pi)$$

6.4.13

$$\psi''(z) \sim -\frac{1}{z^2} - \frac{1}{z^3} - \frac{1}{2z^4} + \frac{1}{6z^6} - \frac{1}{6z^8} + \frac{3}{10z^{10}} - \frac{5}{6z^{12}} + \dots \quad (z \rightarrow \infty \text{ in } |\arg z| < \pi)$$

6.4.14

$$\psi^{(3)}(z) \sim \frac{2}{z^3} + \frac{3}{z^4} + \frac{2}{z^5} - \frac{1}{z^7} + \frac{4}{3z^9} - \frac{3}{z^{11}} + \frac{10}{z^{13}} - \dots \quad (z \rightarrow \infty \text{ in } |\arg z| < \pi)$$

6.5. Incomplete Gamma Function
(see also 26.4)

6.5.1

$$P(a, x) = \frac{1}{\Gamma(a)} \int_0^x e^{-t} t^{a-1} dt \quad (\Re a > 0)$$

6.5.2

$$\gamma(a, x) = P(a, x) \Gamma(a) = \int_0^x e^{-t} t^{a-1} dt \quad (\Re a > 0)$$

6.5.3

$$\Gamma(a, x) = \Gamma(a) - \gamma(a, x) = \int_x^\infty e^{-t} t^{a-1} dt$$

6.5.4

$$\gamma^*(a, x) = x^{-a} P(a, x) = \frac{x^{-a}}{\Gamma(a)} \gamma(a, x)$$

γ^* is a single valued analytic function of a and x possessing no finite singularities.

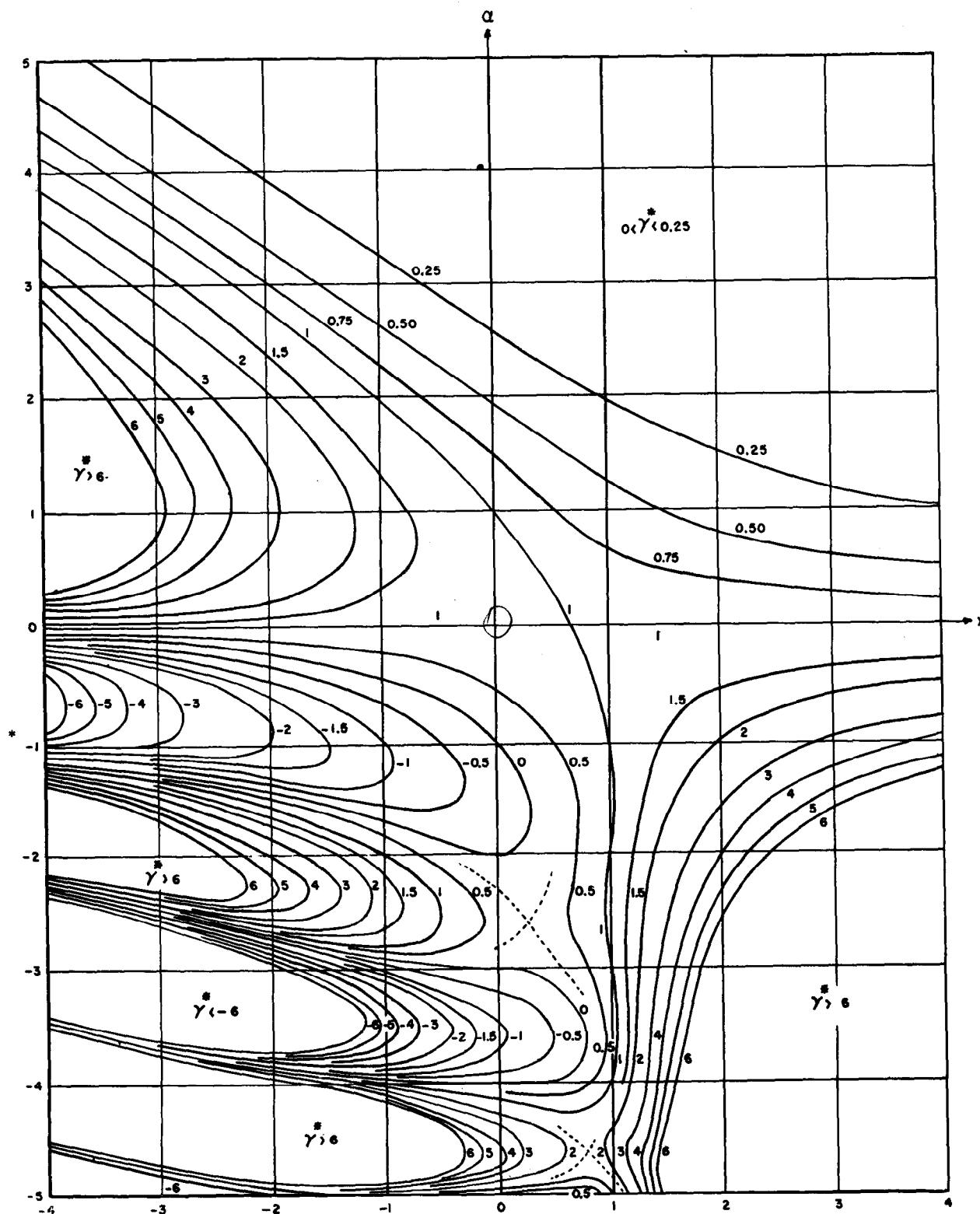

FIGURE 6.3. Incomplete gamma function.

$$\gamma^*(a, x) = \frac{x^{-a}}{\Gamma(a)} \int_0^x e^{-t} t^{a-1} dt$$

From F. G. Tricomi, Sulla funzione gamma incompleta, Annali di Matematica, IV, 33, 1950 (with permission).

*See page II.

6.5.5

Probability Integral of the χ^2 -Distribution

$$P(\chi^2|\nu) = \frac{1}{2^{\frac{1}{2}\nu}\Gamma\left(\frac{\nu}{2}\right)} \int_0^{\chi^2} t^{\frac{1}{2}\nu-1} e^{-\frac{t}{2}} dt$$

6.5.6

(Pearson's Form of the Incomplete Gamma Function)

$$I(u, p) = \frac{1}{\Gamma(p+1)} \int_0^{u\sqrt{p+1}} e^{-t^2} t^p dt \\ = P(p+1, u\sqrt{p+1})$$

$$6.5.7 \quad C(x, a) = \int_x^\infty t^{a-1} \cos t dt \quad (\Re a < 1)$$

$$6.5.8 \quad S(x, a) = \int_x^\infty t^{a-1} \sin t dt \quad (\Re a < 1)$$

6.5.9

$$E_n(x) = \int_1^\infty e^{-xt} t^{-n} dt = x^{n-1} \Gamma(1-n, x)$$

6.5.10

$$\alpha_n(x) = \int_1^\infty e^{-xt} t^n dt = x^{-n-1} \Gamma(1+n, x)$$

6.5.11

$$e_n(x) = \sum_{j=0}^n \frac{x^j}{j!}$$

Incomplete Gamma Function as a Confluent Hypergeometric Function (see chapter 13)

$$6.5.12 \quad \gamma(a, x) = a^{-1} x^a e^{-x} M(1, 1+a, x) \\ = a^{-1} x^a M(a, 1+a, -x)$$

Special Values

6.5.13

$$P(n, x) = 1 - \left(1 + x + \frac{x^2}{2!} + \dots + \frac{x^{n-1}}{(n-1)!}\right) e^{-x} \\ = 1 - e_{n-1}(x) e^{-x}$$

For relation to the Poisson distribution, see 26.4.

$$6.5.14 \quad \gamma^*(-n, x) = x^n$$

$$6.5.15 \quad \Gamma(0, x) = \int_x^\infty e^{-t} t^{-1} dt = E_1(x)$$

$$6.5.16 \quad \gamma\left(\frac{1}{2}, x^2\right) = 2 \int_0^x e^{-t^2} dt = \sqrt{\pi} \operatorname{erf} x$$

$$6.5.17 \quad \Gamma\left(\frac{1}{2}, x^2\right) = 2 \int_x^\infty e^{-t^2} dt = \sqrt{\pi} \operatorname{erfc} x$$

$$6.5.18 \quad \frac{1}{2} \sqrt{\pi} x \gamma^*\left(\frac{1}{2}, -x^2\right) = \int_0^x e^{t^2} dt$$

$$6.5.19 \quad \Gamma(-n, x) = \frac{(-1)^n}{n!} \left[E_1(x) - e^{-x} \sum_{j=0}^{n-1} \frac{(-1)^j j!}{x^{j+1}} \right]$$

$$6.5.20 \quad \Gamma(a, ix) = e^{\frac{1}{2}\pi ia} [C(x, a) - iS(x, a)]$$

Recurrence Formulas

$$6.5.21 \quad P(a+1, x) = P(a, x) - \frac{x^a e^{-x}}{\Gamma(a+1)}$$

$$6.5.22 \quad \gamma(a+1, x) = a\gamma(a, x) - x^a e^{-x}$$

$$6.5.23 \quad \gamma^*(a-1, x) = x\gamma^*(a, x) + \frac{e^{-x}}{\Gamma(a)}$$

Derivatives and Differential Equations

6.5.24

$$\left(\frac{\partial \gamma^*}{\partial \alpha}\right)_{\alpha=0} = - \int_x^\infty \frac{e^{-t} dt}{t} - \ln x = -E_1(x) - \ln x$$

$$6.5.25 \quad \frac{\partial \gamma(a, x)}{\partial x} = - \frac{\partial \Gamma(a, x)}{\partial x} = x^{a-1} e^{-x}$$

6.5.26

$$\frac{\partial^n}{\partial x^n} [x^{-a} \Gamma(a, x)] = (-1)^n x^{-a-n} \Gamma(a+n, x) \\ (n=0, 1, 2, \dots)$$

6.5.27

$$\frac{\partial^n}{\partial x^n} [e^x x^a \gamma^*(a, x)] = e^x x^{a-n} \gamma^*(a-n, x) \\ (n=0, 1, 2, \dots)$$

$$6.5.28 \quad x \frac{\partial^2 \gamma^*}{\partial x^2} + (a+1+x) \frac{\partial \gamma^*}{\partial x} + a\gamma^* = 0$$

Series Developments

6.5.29

$$\gamma^*(a, z) = e^{-z} \sum_{n=0}^{\infty} \frac{z^n}{\Gamma(a+n+1)} = \frac{1}{\Gamma(a)} \sum_{n=0}^{\infty} \frac{(-z)^n}{(a+n)n!} \\ (|z| < \infty)$$

6.5.30

$$\gamma(a, x+y) - \gamma(a, x) = e^{-x} x^{a-1} \sum_{n=0}^{\infty} \frac{(a-1)(a-2)\dots(a-n)}{x^n} [1 - e^{-y} e_n(y)] \quad (|y| < |x|)$$

Continued Fraction

6.5.31

$$\Gamma(a, x) = e^{-x} x^a \left(\frac{1}{x+1} + \frac{1-a}{1+x} + \frac{1}{x+1} + \frac{2-a}{1+x} + \frac{2}{x+1} + \dots \right) \quad (x > 0, |a| < \infty)$$

Asymptotic Expansions

6.5.32

$$\Gamma(a, z) \sim z^{a-1} e^{-z} \left[1 + \frac{a-1}{z} + \frac{(a-1)(a-2)}{z^2} + \dots \right] \quad \left(z \rightarrow \infty \text{ in } |\arg z| < \frac{3\pi}{2} \right)$$

Suppose $R_n(a, z) = u_{n+1}(a, z) + \dots$ is the remainder after n terms in this series. Then if a, z are real, we have for $n > a - 2$

$$|R_n(a, z)| \leq |u_{n+1}(a, z)|$$

and $\text{sign } R_n(a, z) = \text{sign } u_{n+1}(a, z)$.

6.5.33 $\gamma(a, z) \sim \sum_{n=0}^{\infty} \frac{(-1)^n z^{a+n}}{(a+n)n!} \quad (a \rightarrow +\infty)$

6.5.34 $\lim_{n \rightarrow \infty} \frac{e_n(\alpha n)}{e^{\alpha n}} = \begin{cases} 0 & \text{for } \alpha > 1 \\ \frac{1}{2} & \text{for } \alpha = 1 \\ 1 & \text{for } 0 \leq \alpha < 1 \end{cases}$

6.5.35

$$\Gamma(z+1, z) \sim e^{-z} z^z \left(\sqrt{\frac{\pi}{2}} z^{\frac{1}{2}} + \frac{2}{3} + \frac{\sqrt{2\pi}}{24} \frac{1}{z^{\frac{1}{2}}} + \dots \right) \quad (z \rightarrow \infty \text{ in } |\arg z| < \frac{1}{2}\pi)$$

Definite Integrals

6.5.36

$$\int_0^{\infty} e^{-at} \Gamma(b, ct) dt = \frac{\Gamma(b)}{a} \left[1 - \frac{c^b}{(a+c)^b} \right] \quad (\Re(a+c) > 0, \Re b > -1)$$

6.5.37

$$\int_0^{\infty} t^{a-1} \Gamma(b, t) dt = \frac{\Gamma(a+b)}{a} \quad (\Re(a+b) > 0, \Re a > 0)$$

6.6. Incomplete Beta Function

6.6.1 $B_x(a, b) = \int_0^x t^{a-1} (1-t)^{b-1} dt$

6.6.2 $I_x(a, b) = B_x(a, b) / B(a, b)$

For statistical applications, see 26.5.

Symmetry

6.6.3 $I_x(a, b) = 1 - I_{1-x}(b, a)$

Relation to Binomial Expansion

6.6.4 $I_p(a, n-a+1) = \sum_{j=a}^n \binom{n}{j} p^j (1-p)^{n-j}$

For binomial distribution, see 26.1.

Recurrence Formulas

6.6.5 $I_x(a, b) = x I_x(a-1, b) + (1-x) I_x(a, b-1)$

6.6.6 $(a+b-ax) I_x(a, b) = a(1-x) I_x(a+1, b-1) + b I_x(a, b+1)$

6.6.7 $(a+b) I_x(a, b) = a I_x(a+1, b) + b I_x(a, b+1)$

Relation to Hypergeometric Function

6.6.8 $B_x(a, b) = a^{-1} x^a F(a, 1-b; a+1; x)$

Numerical Methods

6.7. Use and Extension of the Tables

Example 1. Compute $\Gamma(6.38)$ to 8S. Using the recurrence relation 6.1.16 and Table 6.1 we have,

$$\Gamma(6.38) = [(5.38)(4.38)(3.38)(2.38)(1.38)]\Gamma(1.38) = 232.43671.$$

Example 2. Compute $\ln \Gamma(56.38)$, using Table 6.4 and linear interpolation in f_2 . We have

$$\ln \Gamma(56.38) = (56.38 - \frac{1}{2}) \ln(56.38) - (56.38) + f_2(56.38)$$

The error of linear interpolation in the table of the function f_2 is smaller than 10^{-7} in this region. Hence, $f_2(56.38) = .9204167$ and $\ln \Gamma(56.38) = 169.8549742$.

Direct interpolation in Table 6.4 of $\log_{10} \Gamma(n)$ eliminates the necessity of employing logarithms. However, the error of linear interpolation is .002 so that $\log_{10} \Gamma(n)$ is obtained with a relative error of 10^{-5} .

*See page 11.

Example 3. Compute $\psi(6.38)$ to 8S. Using the recurrence relation 6.3.6 and Table 6.1.

$$\begin{aligned} \psi(6.38) &= \frac{1}{5.38} + \frac{1}{4.38} + \frac{1}{3.38} + \frac{1}{2.38} + \frac{1}{1.38} + \psi(1.38) \\ &= 1.77275\ 59. \end{aligned}$$

Example 4. Compute $\psi(56.38)$. Using Table 6.3 we have $\psi(56.38) = \ln 56.38 - f_3(56.38)$.

The error of linear interpolation in the table of the function f_3 is smaller than 8×10^{-7} in this region. Hence, $f_3(56.38) = .00889\ 53$ and $\psi(56.38) = 4.023219$.

Example 5. Compute $\ln \Gamma(1-i)$. From the reflection principle 6.1.23 and Table 6.7, $\ln \Gamma(1-i) = \overline{\ln \Gamma(1+i)} = -.6509 + .3016i$.

Example 6. Compute $\ln \Gamma(\frac{1}{2} + \frac{1}{2}i)$. Taking the logarithm of the recurrence relation 6.1.15 we have,

$$\begin{aligned} \ln \Gamma(\frac{1}{2} + \frac{1}{2}i) &= \ln \Gamma(\frac{3}{2} + \frac{1}{2}i) - \ln(\frac{1}{2} + \frac{1}{2}i) \\ &= -.23419 + .03467i \\ &\quad - (\frac{1}{2} \ln \frac{1}{2} + i \arctan 1) \\ &= .11239 - .75073i \end{aligned}$$

The logarithms of complex numbers are found from 4.1.2.

Example 7. Compute $\ln \Gamma(3+7i)$ using the duplication formula 6.1.18. Taking the logarithm of 6.1.18, we have

$$\begin{aligned} -\frac{1}{2} \ln 2\pi &= -.91894 \\ (\frac{3}{2} + 7i) \ln 2 &= 1.73287 + 4.85203i \\ \ln \Gamma(\frac{3}{2} + \frac{7}{2}i) &= -3.31598 + 2.32553i \\ \ln \Gamma(2 + \frac{7}{2}i) &= -2.66047 + 2.93869i \\ \ln \Gamma(3+7i) &= -5.16252 + 10.11625i \end{aligned}$$

Example 8. Compute $\ln \Gamma(3+7i)$ to 5D using the asymptotic formula 6.1.41. We have

$$\ln(3+7i) = 2.03022\ 15 + 1.16590\ 45i.$$

Then,

$$\begin{aligned} (2.5+7i) \ln(3+7i) &= -3.0857779 + 17.1263119i \\ -(3+7i) &= -3.0000000 - 7.0000000i \\ \frac{1}{2} \ln(2\pi) &= .9189385 \\ [12(3+7i)]^{-1} &= .0043103 - .0100575i \\ -[360(3+7i)^3]^{-1} &= .0000059 - .0000022i \end{aligned}$$

$$\ln \Gamma(3+7i) = -5.16252 + 10.11625i$$

6.8. Summation of Rational Series by Means of Polygamma Functions

An infinite series whose general term is a rational function of the index may always be reduced to a finite series of psi and polygamma functions. The method will be illustrated by writing the explicit formula when the denominator contains a triple root.

Let the general term of an infinite series have the form

$$u_n = \frac{p(n)}{d_1(n)d_2(n)d_3(n)}$$

where

$$d_1(n) = (n + \alpha_1)(n + \alpha_2) \dots (n + \alpha_m)$$

$$d_2(n) = (n + \beta_1)^2(n + \beta_2)^2 \dots (n + \beta_r)^2$$

$$d_3(n) = (n + \gamma_1)^3(n + \gamma_2)^3 \dots (n + \gamma_s)^3$$

where $p(n)$ is a polynomial of degree $m + 2r + 3s - 2$ at most and where the constants α_i , β_i , and γ_i are distinct. Expand u_n in partial fractions as follows

$$\begin{aligned} u_n &= \sum_{k=1}^m \frac{a_k}{(n + \alpha_k)} + \sum_{k=1}^r \frac{b_{1k}}{(n + \beta_k)} + \frac{b_{2k}}{(n + \beta_k)^2} \\ &\quad + \sum_{k=1}^s \frac{c_{1k}}{(n + \gamma_k)} + \frac{c_{2k}}{(n + \gamma_k)^2} + \frac{c_{3k}}{(n + \gamma_k)^3} \\ \sum_{k=1}^m a_k + \sum_{k=1}^r b_{1k} + \sum_{k=1}^s c_{1k} &= 0. \end{aligned}$$

Then, we may express $\sum_{n=1}^{\infty} u_n$ in terms of the constants appearing in this partial fraction expansion as follows

$$\begin{aligned} \sum_{n=1}^{\infty} u_n &= -\sum_{j=1}^m a_j \psi(1 + \alpha_j) \\ &\quad - \sum_{j=1}^r b_{1j} \psi(1 + \beta_j) + \sum_{j=1}^r b_{2j} \psi'(1 + \beta_j) \\ &\quad - \sum_{j=1}^s c_{1j} \psi(1 + \gamma_j) + \sum_{j=1}^s c_{2j} \psi'(1 + \gamma_j) \\ &\quad - \sum_{j=1}^s \frac{c_{3j}}{2!} \psi''(1 + \gamma_j). \end{aligned}$$

Higher order repetitions in the denominator are handled similarly. If the denominator contains

only simple or double roots, omit the corresponding lines.

Example 9. Find

$$s = \sum_{n=1}^{\infty} \frac{1}{(n+1)(2n+1)(4n+1)}$$

Since

$$\frac{1}{(n+1)(2n+1)(4n+1)} = \frac{\frac{1}{3}}{n+1} - \frac{1}{n+\frac{1}{2}} + \frac{\frac{2}{3}}{n+\frac{1}{4}}$$

we have

$$\alpha_1=1, \alpha_2=\frac{1}{2}, \alpha_3=\frac{1}{4}, a_1=\frac{1}{3}, a_2=-1, a_3=\frac{2}{3}.$$

Thus,

$$s = -\frac{1}{3}\psi(2) + \psi(1\frac{1}{2}) - \frac{2}{3}\psi(1\frac{1}{4}) = .047198.$$

Example 10.

Find $s = \sum_{n=1}^{\infty} \frac{1}{n^2(8n+1)^2}$.

Since $\frac{1}{n^2(8n+1)^2} = -\frac{16}{n} + \frac{16}{n+\frac{1}{8}} + \frac{1}{n^2} + \frac{1}{(n+\frac{1}{8})^2}$,

we have,

$$\beta_1=0, \beta_2=\frac{1}{8}, b_{11}=-16, b_{12}=16, b_{21}=1, b_{22}=1.$$

Therefore

$$s = 16\psi(1) - 16\psi(1\frac{1}{8}) + \psi'(1) + \psi'(1\frac{1}{8}) = .013499.$$

Example 11.

Evaluate $s = \sum_{n=1}^{\infty} \frac{1}{(n^2+1)(n^2+4)}$ (see also 6.3.13).



We have, $\frac{1}{(n^2+1)(n^2+4)} = \frac{i}{6} \left(\frac{1}{n+i} - \frac{1}{n-i} \right) - \frac{i}{12} \left(\frac{1}{n+2i} - \frac{1}{n-2i} \right)$.

Hence, $a_1 = \frac{i}{6}, a_2 = -\frac{i}{6}, a_3 = -\frac{i}{12}, a_4 = \frac{i}{12}$,

$$\alpha_1=i, \alpha_2=-i, \alpha_3=2i, \alpha_4=-2i,$$

and therefore

$$s = \frac{-i}{6} [\psi(1+i) - \psi(1-i)] + \frac{i}{12} [\psi(1+2i) - \psi(1-2i)].$$

By 6.3.9, this reduces to

$$s = \frac{1}{3} \mathcal{I} \psi(1+i) - \frac{1}{6} \mathcal{I} \psi(1+2i).$$

From Table 6.8, $s = .13876$.

References

Texts

[6.1] E. Artin, Einführung in die Theorie der Gammafunktion (Leipzig, Germany, 1931).
 [6.2] P. E. Böhmer, Differenzgleichungen und bestimmte Integrale, chs. 3, 4, 5 (K. F. Koehler, Leipzig, Germany, 1939).
 [6.3] G. Doetsch, Handbuch der Laplace-Transformation, vol. II, pp. 52-61 (Birkhauser, Basel, Switzerland, 1955).
 [6.4] A. Erdélyi et al., Higher transcendental functions, vol. 1, ch. 1, ch. 2, sec. 5; vol. 2, ch. 9 (McGraw-Hill Book Co., Inc., New York, N.Y., 1953).
 [6.5] C. Hastings, Jr., Approximations for digital computers (Princeton Univ. Press, Princeton, N.J., 1955).
 [6.6] F. Lösch and F. Schoblik, Die Fakultät und verwandte Funktionen (B. G. Teubner, Leipzig, Germany, 1951).
 [6.7] W. Sibagaki, Theory and applications of the gamma function (Iwanami Syoten, Tokyo, Japan, 1952).
 [6.8] E. T. Whittaker and G. N. Watson, A course of modern analysis, ch. 12, 4th ed. (Cambridge Univ. Press, Cambridge, England, 1952).

Tables

[6.9] A. Abramov, Tables of $\ln \Gamma(z)$ for complex argument. Translated from the Russian by D. G. Fry (Pergamon Press, New York, N.Y., 1960). In $\Gamma(x+iy)$, $x=0(.01)10$, $y=0(.01)4, 6D$.
 [6.10] Ballistic Research Laboratory, A table of the factorial numbers and their reciprocals from $1!$ through $1000!$ to 20 significant digits. Technical Note No. 381, Aberdeen Proving Ground, Md., 1951.
 [6.11] British Association for the Advancement of Science, Mathematical tables, vol. 1, 3d ed., pp. 40-59 (Cambridge Univ. Press, Cambridge, England, 1951). The gamma and polygamma functions. Also $1 + \int_0^x \log_{10}(t)! dt$, $x=0(.01)1, 10D$.
 [6.12] H. T. Davis, Tables of the higher mathematical functions, 2 vols. (Principia Press, Bloomington, Ind., 1933, 1935). Extensive, many place tables of the gamma and polygamma functions up to $\psi^{(4)}(x)$ and of their logarithms.
 [6.13] F. J. Duarte, Nouvelles tables de $\log_{10} n!$ à 33 décimales depuis $n=1$ jusqu'à $n=3000$ (Kundig, Geneva, Switzerland; Index Generalis, Paris, France, 1927).

- [6.14] National Bureau of Standards, Tables of $n!$ and $\Gamma(n+\frac{1}{2})$ for the first thousand values of n , Applied Math. Series 16 (U.S. Government Printing Office, Washington, D.C., 1951). $n!$, 16S; $\Gamma(n+\frac{1}{2})$, 8S.
- [6.15] National Bureau of Standards, Table of Coulomb wave functions, vol. I, pp. 114–135, Applied Math. Series 17 (U.S. Government Printing Office, Washington, D.C., 1952).
 $\mathcal{R}[\Gamma'(1+i\eta)/\Gamma(1+i\eta), \eta=0(.005)2(.01)6(.02)10(.1)20(.2)60(.5)110, 10D; \arg \Gamma(1+i\eta), \eta=0(.01)1(.02)3(.05)10(.2)20(.4)30(.5)85, 8D.$
- [6.16] National Bureau of Standards, Table of the gamma function for complex arguments, Applied Math. Series 34 (U.S. Government Printing Office, Washington, D.C., 1954).
 $\ln \Gamma(x+iy), x=0(.1)10, y=0(.1)10, 12D.$
 Contains an extensive bibliography.
- [6.17] National Physical Laboratory, Tables of Weber parabolic cylinder functions, pp. 226–233 (Her Majesty's Stationery Office, London, England, 1955).
 Real and imaginary parts of $\ln \Gamma(\frac{1}{2}k + \frac{1}{2}ia), k=0(1)3, a=0(.1)5(.2)20, 8D; (|\Gamma(\frac{1}{2}k + \frac{1}{2}ia)/\Gamma(\frac{1}{2} + \frac{1}{2}ia)|)^{-1/2}$
 $a=0(.02)1(.1)5(.2)20, 8D.$
- [6.18] E. S. Pearson, Table of the logarithms of the complete Γ -function, arguments 2 to 1200, Tracts for Computers No. VIII (Cambridge Univ. Press, Cambridge, England, 1922). $\log_{10} \Gamma(p), p=2(.1)5(.2)70(1)1200, 10D.$
- [6.19] J. Peters, Ten-place logarithm tables, vol. I, Appendix, pp. 58–68 (Frederick Ungar Publ. Co., New York, N.Y., 1957). $n!$, $n=1(1)60$, exact; $(n!)^{-1}$, $n=1(1)43, 54D; \log_{10}(n!), n=1(1)1200, 18D.$
- [6.20] J. P. Stanley and M. V. Wilkes, Table of the reciprocal of the gamma function for complex argument (Univ. of Toronto Press, Toronto, Canada, 1950). $x=-.5(.01).5, y=0(.01)1, 6D.$
- [6.21] M. Zyczkowski, Tablice funkcji eulera i pokrewnych (Panstwowe Wydawnictwo Naukowe, Warsaw, Poland, 1954). Extensive tables of integrals involving gamma and beta functions.

For references to tabular material on the incomplete gamma and incomplete beta functions, see the references in chapter 26.

Voir aussi M.O.C.

GAMMA, DIGAMMA AND TRIGAMMA FUNCTIONS

Table 6.1

x	$\Gamma(x)$	$\ln \Gamma(x)$	$\psi(x)$	$\psi'(x)$	
1.000	1.00000 00000	0.00000 00000	-0.57721 56649	1.64493 40668	0.000
1.005	0.99713 85354	-0.00286 55666	-0.56902 09113	1.63299 41567	0.005
1.010	0.99432 58512	-0.00569 03079	-0.56088 54579	1.62121 35283	0.010
1.015	0.99156 12888	-0.00847 45187	-0.55280 85156	1.60958 91824	0.015
1.020	0.98884 42033	-0.01121 84893	-0.54478 93105	1.59811 81919	0.020
1.025	0.98617 39633	-0.01392 25067	-0.53682 70828	1.58679 76993	0.025
1.030	0.98354 99506	-0.01658 68539	-0.52892 10873	1.57562 49154	0.030
1.035	0.98097 15606	-0.01921 18101	-0.52107 05921	1.56459 71163	0.035
1.040	0.97843 82009	-0.02179 76511	-0.51327 48789	1.55371 16426	0.040
1.045	0.97594 92919	-0.02434 46490	-0.50553 32428	1.54296 58968	0.045
1.050	0.97350 42656	-0.02685 30725	-0.49784 49913	1.53235 73421	0.050
1.055	0.97110 25663	-0.02932 31868	-0.49020 94448	1.52188 35001	0.055
1.060	0.96874 36495	-0.03175 52537	-0.48262 59358	1.51154 19500	0.060
1.065	0.96642 69823	-0.03414 95318	-0.47509 38088	1.50133 03259	0.065
1.070	0.96415 20425	-0.03650 62763	-0.46761 24199	1.49124 63164	0.070
1.075	0.96191 83189	-0.03882 57395	-0.46018 11367	1.48128 76622	0.075
1.080	0.95972 53107	-0.04110 81702	-0.45279 93380	1.47145 21556	0.080
1.085	0.95757 25273	-0.04335 38143	-0.44546 64135	1.46173 76377	0.085
1.090	0.95545 94882	-0.04556 29148	-0.43818 17635	1.45214 19988	0.090
1.095	0.95338 57227	-0.04773 57114	-0.43094 47988	1.44266 31755	0.095
1.100	0.95135 07699	-0.04987 24413	-0.42375 49404	1.43329 91508	0.100
1.105	0.94935 41778	-0.05197 33384	-0.41661 16193	1.42404 79514	0.105
1.110	0.94739 55040	-0.05403 86341	-0.40951 42761	1.41490 76482	0.110
1.115	0.94547 43149	-0.05606 85568	-0.40246 23611	1.40587 63535	0.115
1.120	0.94359 01856	-0.05806 33325	-0.39545 53339	1.39695 22213	0.120
1.125	0.94174 26997	-0.06002 31841	-0.38849 26633	1.38813 34449	0.125
1.130	0.93993 14497	-0.06194 83322	-0.38157 38268	1.37941 82573	0.130
1.135	0.93815 60356	-0.06383 89946	-0.37469 83110	1.37080 49288	0.135
1.140	0.93641 60657	-0.06569 53867	-0.36786 56106	1.36229 17670	0.140
1.145	0.93471 11562	-0.06751 77212	-0.36107 52291	1.35387 71152	0.145
1.150	0.93304 09311	-0.06930 62087	-0.35432 66780	1.34555 93520	0.150
1.155	0.93140 50217	-0.07106 10569	-0.34761 94768	1.33733 68900	0.155
1.160	0.92980 30666	-0.07278 24716	-0.34095 31528	1.32920 81752	0.160
1.165	0.92823 47120	-0.07447 06558	-0.33432 72413	1.32117 16859	0.165
1.170	0.92669 96106	-0.07612 58106	-0.32774 12847	1.31322 59322	0.170
1.175	0.92519 74225	-0.07774 81345	-0.32119 48332	1.30536 94548	0.175
1.180	0.92372 78143	-0.07933 78240	-0.31468 74438	1.29760 08248	0.180
1.185	0.92229 04591	-0.08089 50733	-0.30821 86809	1.28991 86421	0.185
1.190	0.92088 50371	-0.08242 00745	-0.30178 81156	1.28232 15358	0.190
1.195	0.91951 12341	-0.08391 30174	-0.29539 53259	1.27480 81622	0.195
1.200	0.91816 87424	-0.08537 40900	-0.28903 98966	1.26737 72054	0.200
1.205	0.91685 72606	-0.08680 34780	-0.28272 14187	1.26002 73755	0.205
1.210	0.91557 64930	-0.08820 13651	-0.27643 94897	1.25275 74090	0.210
1.215	0.91432 61500	-0.08956 79331	-0.27019 37135	1.24556 60671	0.215
1.220	0.91310 59475	-0.09090 33619	-0.26398 37000	1.23845 21360	0.220
1.225	0.91191 56071	-0.09220 78291	-0.25780 90652	1.23141 44258	0.225
1.230	0.91075 48564	-0.09348 15108	-0.25166 94307	1.22445 17702	0.230
1.235	0.90962 34274	-0.09472 45811	-0.24556 44243	1.21756 30254	0.235
1.240	0.90852 10583	-0.09593 72122	-0.23949 36791	1.21074 70707	0.240
1.245	0.90744 74922	-0.09711 95744	-0.23345 68341	1.20400 28063	0.245
1.250	0.90640 24771	-0.09827 18364	-0.22745 35334	1.19732 91545	0.250
	$y!$	$\ln y!$	$\frac{d}{dy} \ln y!$	$\frac{d^2}{dy^2} \ln y!$	y
	$\left[\begin{smallmatrix} (-6)6 \\ 5 \end{smallmatrix} \right]$	$\left[\begin{smallmatrix} (-6)5 \\ 5 \end{smallmatrix} \right]$	$\left[\begin{smallmatrix} (-6)7 \\ 5 \end{smallmatrix} \right]$	$\left[\begin{smallmatrix} (-5)2 \\ 5 \end{smallmatrix} \right]$	

For $x > 2$ see Examples 1-4.

$\log_{10} e = 0.43429 44819$

Compiled from H. T. Davis, Tables of the higher mathematical functions, 2 vols. (Principia Press, Bloomington, Ind., 1933, 1935) (with permission). Known error has been corrected.

Table 6.1 GAMMA, DIGAMMA AND TRIGAMMA FUNCTIONS

x	$\Gamma(x)$	$\ln \Gamma(x)$	$\psi(x)$	$\psi'(x)$		
1.250	0.90640 24771	-0.09827 18364	-0.22745 35334	1.19732 91545		0.250
1.255	0.90538 57663	-0.09939 41651	-0.22148 34266	1.19072 50579		0.255
1.260	0.90439 71178	-0.10048 67254	-0.21554 61686	1.18418 94799		0.260
1.265	0.90343 62946	-0.10154 96809	-0.20964 14193	1.17772 14030		0.265
1.270	0.90250 30645	-0.10258 31932	-0.20376 88437	1.17131 98301		0.270
1.275	0.90159 71994	-0.10358 74224	-0.19792 81118	1.16498 37821		0.275
1.280	0.90071 84765	-0.10456 25269	-0.19211 88983	1.15871 22990		0.280
1.285	0.89986 66769	-0.10550 86634	-0.18634 08828	1.15250 44385		0.285
1.290	0.89904 15863	-0.10642 59872	-0.18059 37494	1.14635 92764		0.290
1.295	0.89824 29947	-0.10731 46519	-0.17487 71870	1.14027 59053		0.295
1.300	0.89747 06963	-0.10817 48095	-0.16919 08889	1.13425 34350		0.300
1.305	0.89672 44895	-0.10900 66107	-0.16353 45526	1.12829 09915		0.305
1.310	0.89600 41767	-0.10981 02045	-0.15790 78803	1.12238 77175		0.310
1.315	0.89530 95644	-0.11058 57384	-0.15231 05782	1.11654 27706		0.315
1.320	0.89464 04630	-0.11133 33587	-0.14674 23568	1.11075 53246		0.320
1.325	0.89399 66866	-0.11205 32100	-0.14120 29305	1.10502 45678		0.325
1.330	0.89337 80535	-0.11274 54356	-0.13569 20180	1.09934 97037		0.330
1.335	0.89278 43850	-0.11341 01772	-0.13020 93416	1.09372 99497		0.335
1.340	0.89221 55072	-0.11404 75756	-0.12475 46279	1.08816 45379		0.340
1.345	0.89167 12485	-0.11465 77697	-0.11932 76069	1.08265 27136		0.345
1.350	0.89115 14420	-0.11524 08974	-0.11392 80127	1.07719 37361		0.350
1.355	0.89065 59235	-0.11579 70951	-0.10855 55827	1.07178 68773		0.355
1.360	0.89018 45324	-0.11632 64980	-0.10321 00582	1.06643 14226		0.360
1.365	0.88973 71116	-0.11682 92401	-0.09789 11840	1.06112 66696		0.365
1.370	0.88931 35074	-0.11730 54539	-0.09259 87082	1.05587 19286		0.370
1.375	0.88891 35692	-0.11775 52707	-0.08733 23825	1.05066 65216		0.375
1.380	0.88853 71494	-0.11817 88209	-0.08209 19619	1.04550 97829		0.380
1.385	0.88818 41041	-0.11857 62331	-0.07687 72046	1.04040 10578		0.385
1.390	0.88785 42918	-0.11894 76353	-0.07168 78723	1.03533 97036		0.390
1.395	0.88754 75748	-0.11929 31538	-0.06652 37297	1.03032 50881		0.395
1.400	0.88726 38175	-0.11961 29142	-0.06138 45446	1.02535 65905		0.400
1.405	0.88700 28884	-0.11990 70405	-0.05627 00879	1.02043 36002		0.405
1.410	0.88676 46576	-0.12017 56559	-0.05118 01337	1.01555 55173		0.410
1.415	0.88654 89993	-0.12041 88823	-0.04611 44589	1.01072 17518		0.415
1.420	0.88635 57896	-0.12063 68406	-0.04107 28433	1.00593 17241		0.420
1.425	0.88618 49081	-0.12082 96505	-0.03605 50697	1.00118 48640		0.425
1.430	0.88603 62361	-0.12099 74307	-0.03106 09237	0.99648 06113		0.430
1.435	0.88590 96587	-0.12114 02987	-0.02609 01935	0.99181 84147		0.435
1.440	0.88580 50635	-0.12125 83713	-0.02114 26703	0.98719 77326		0.440
1.445	0.88572 23397	-0.12135 17638	-0.01621 81479	0.98261 80318		0.445
1.450	0.88566 13803	-0.12142 05907	-0.01131 64226	0.97807 87886		0.450
1.455	0.88562 20800	-0.12146 49657	-0.00643 72934	0.97357 94874		0.455
1.460	0.88560 43364	-0.12148 50010	-0.00158 05620	0.96911 96215		0.460
1.465	0.88560 80495	-0.12148 08083	+0.00325 39677	0.96469 86921		0.465
1.470	0.88563 31217	-0.12145 24980	0.00806 64890	0.96031 62091		0.470
1.475	0.88567 94575	-0.12140 01797	0.01285 71930	0.95597 16896		0.475
1.480	0.88574 69646	-0.12132 39621	0.01762 62684	0.95166 46592		0.480
1.485	0.88583 55520	-0.12122 39528	0.02237 39013	0.94739 46509		0.485
1.490	0.88594 51316	-0.12110 02585	0.02710 02758	0.94316 12052		0.490
1.495	0.88607 56174	-0.12095 29852	0.03180 55736	0.93896 38700		0.495
1.500	0.88622 69255	-0.12078 22376	0.03648 99740	0.93480 22005		0.500

$$\begin{array}{ccccccc}
 y! & \ln y! & * \frac{d}{dy} \ln y! & * \frac{d^2}{dy^2} \ln y! & y \\
 \left[\begin{matrix} (-6)4 \\ 5 \end{matrix} \right] & \left[\begin{matrix} (-6)4 \\ 4 \end{matrix} \right] & \left[\begin{matrix} (-6)4 \\ 5 \end{matrix} \right] & \left[\begin{matrix} (-6)9 \\ 5 \end{matrix} \right] &
 \end{array}$$

$\log_{10} e = 0.43429 44819$

*See page II.

GAMMA, DIGAMMA AND TRIGAMMA FUNCTIONS

Table 6.1

x	$\Gamma(x)$	$\ln \Gamma(x)$	$\psi(x)$	$\psi'(x)$		
1.500	0.88622 69255	-0.12078 22376	0.03648 99740	0.93480 22005	0.500	
1.505	0.88639 89744	-0.12058 81200	0.04115 36543	0.93067 57588	0.505	
1.510	0.88659 16850	-0.12037 07353	0.04579 67896	0.92658 41142	0.510	
1.515	0.88680 49797	-0.12013 01860	0.05041 95527	0.92252 68425	0.515	
1.520	0.88703 87833	-0.11986 65735	0.05502 21146	0.91850 35265	0.520	
1.525	0.88729 30231	-0.11957 99983	0.05960 46439	0.91451 37552	0.525	
1.530	0.88756 76278	-0.11927 05601	0.06416 73074	0.91055 71245	0.530	
1.535	0.88786 25287	-0.11893 83580	0.06871 02697	0.90663 32361	0.535	
1.540	0.88817 76586	-0.11858 34900	0.07323 36936	0.90274 16984	0.540	
1.545	0.88851 29527	-0.11820 60534	0.07773 77400	0.89888 21253	0.545	
1.550	0.88886 83478	-0.11780 61446	0.08222 25675	0.89505 41371	0.550	
1.555	0.88924 37830	-0.11738 38595	0.08668 83334	0.89125 73596	0.555	
1.560	0.88963 91990	-0.11693 92928	0.09113 51925	0.88749 14249	0.560	
1.565	0.89005 45387	-0.11647 25388	0.09556 32984	0.88375 59699	0.565	
1.570	0.89048 97463	-0.11598 36908	0.09997 28024	0.88005 06378	0.570	
1.575	0.89094 47686	-0.11547 28415	0.10436 38544	0.87637 50766	0.575	
1.580	0.89141 95537	-0.11494 00828	0.10873 66023	0.87272 89402	0.580	
1.585	0.89191 40515	-0.11438 55058	0.11309 11923	0.86911 18871	0.585	
1.590	0.89242 82141	-0.11380 92009	0.11742 77690	0.86552 35815	0.590	
1.595	0.89296 19949	-0.11321 12579	0.12174 64754	0.86196 36921	0.595	
1.600	0.89351 53493	-0.11259 17657	0.12604 74528	0.85843 18931	0.600	
1.605	0.89408 82342	-0.11195 08127	0.13033 08407	0.85492 78630	0.605	
1.610	0.89468 06085	-0.11128 84864	0.13459 67772	0.85145 12856	0.610	
1.615	0.89529 24327	-0.11060 48737	0.13884 53988	0.84800 18488	0.615	
1.620	0.89592 36685	-0.10990 00610	0.14307 68404	0.84457 92455	0.620	
1.625	0.89657 42800	-0.10917 41338	0.14729 12354	0.84118 31730	0.625	
1.630	0.89724 42326	-0.10842 71769	0.15148 87158	0.83781 33330	0.630	
1.635	0.89793 34930	-0.10765 92746	0.15566 94120	0.83446 94315	0.635	
1.640	0.89864 20302	-0.10687 05105	0.15983 34529	0.83115 11790	0.640	
1.645	0.89936 98138	-0.10606 09676	0.16398 09660	0.82785 82897	0.645	
1.650	0.90011 68163	-0.10523 07282	0.16811 20776	0.82459 04826	0.650	
1.655	0.90088 30104	-0.10437 98739	0.17222 69122	0.82134 74802	0.655	
1.660	0.90166 83712	-0.10350 84860	0.17632 55933	0.81812 90092	0.660	
1.665	0.90247 28748	-0.10261 66447	0.18040 82427	0.81493 48001	0.665	
1.670	0.90329 64995	-0.10170 44301	0.18447 49813	0.81176 45875	0.670	
1.675	0.90413 92243	-0.10077 19212	0.18852 59282	0.80861 81094	0.675	
1.680	0.90500 10302	-0.09981 91969	0.19256 12015	0.80549 51079	0.680	
1.685	0.90588 18996	-0.09884 63351	0.19658 09180	0.80239 53282	0.685	
1.690	0.90678 18160	-0.09785 34135	0.20058 51931	0.79931 85198	0.690	
1.695	0.90770 07650	-0.09684 05088	0.20457 41410	0.79626 44350	0.695	
1.700	0.90863 87329	-0.09580 76974	0.20854 78749	0.79323 28302	0.700	
1.705	0.90959 57079	-0.09475 50552	0.21250 65064	0.79022 34645	0.705	
1.710	0.91057 16796	-0.09368 26573	0.21645 01462	0.78723 61012	0.710	
1.715	0.91156 66390	-0.09259 05785	0.22037 89037	0.78427 05060	0.715	
1.720	0.91258 05779	-0.09147 88929	0.22429 28871	0.78132 64486	0.720	
1.725	0.91361 34904	-0.09034 76741	0.22819 22037	0.77840 37011	0.725	
1.730	0.91466 53712	-0.08919 69951	0.23207 69593	0.77550 20396	0.730	
1.735	0.91573 62171	-0.08802 69286	0.23594 72589	0.77262 12424	0.735	
1.740	0.91682 60252	-0.08683 75466	0.23980 32061	0.76976 10915	0.740	
1.745	0.91793 47950	-0.08562 89203	0.24364 49038	0.76692 13714	0.745	
1.750	0.91906 25268	-0.08440 11210	0.24747 24535	0.76410 18699	0.750	

$$\begin{array}{cccccc}
 y! & \ln y! & \frac{d}{dy} \ln y! & \frac{d^2}{dy^2} \ln y! & y & \\
 \left[\begin{matrix} (-6)3 \\ 4 \end{matrix} \right] & \left[\begin{matrix} (-6)3 \\ 4 \end{matrix} \right] & \left[\begin{matrix} (-6)3 \\ 4 \end{matrix} \right] & \left[\begin{matrix} (-6)4 \\ 5 \end{matrix} \right] & & \\
 \log_{10} e = 0.43429 44819 & & & & &
 \end{array}$$

Table 6.1 GAMMA, DIGAMMA AND TRIGAMMA FUNCTIONS

x	$\Gamma(x)$	$\ln \Gamma(x)$	$\psi(x)$	$\psi'(x)$		
1.750	0.91906 25268	-0.08440 11210	0.24747 24535	0.76410 18699	0.750	
1.755	0.92020 92224	-0.08315 42192	0.25128 59559	0.76130 23773	0.755	
1.760	0.92137 48846	-0.08188 82847	0.25508 55103	0.75852 26870	0.760	
1.765	0.92255 95178	-0.08060 33871	0.25887 12154	0.75576 25950	0.765	
1.770	0.92376 31277	-0.07929 95955	0.26264 31686	0.75302 19003	0.770	
1.775	0.92498 57211	-0.07797 69782	0.26640 14664	0.75030 04040	0.775	
1.780	0.92622 73062	-0.07663 56034	0.27014 62043	0.74759 79107	0.780	
1.785	0.92748 78926	-0.07527 55386	0.27387 74769	0.74491 42268	0.785	
1.790	0.92876 74904	-0.07389 68509	0.27759 53776	0.74224 91617	0.790	
1.795	0.93006 61123	-0.07249 96070	0.28129 99992	0.73960 25271	0.795	
1.800	0.93138 37710	-0.07108 38729	0.28499 14333	0.73697 41375	0.800	
1.805	0.93272 04811	-0.06964 97145	0.28866 97707	0.73436 38093	0.805	
1.810	0.93407 62585	-0.06819 71969	0.29233 51012	0.73177 13620	0.810	
1.815	0.93545 11198	-0.06672 63850	0.29598 75138	0.72919 66166	0.815	
1.820	0.93684 50832	-0.06523 73431	0.29962 70966	0.72663 93972	0.820	
1.825	0.93825 81682	-0.06373 01353	0.30325 39367	0.72409 95297	0.825	
1.830	0.93969 03951	-0.06220 48248	0.30686 81205	0.72157 68426	0.830	
1.835	0.94114 17859	-0.06066 14750	0.31046 97335	0.71907 11662	0.835	
1.840	0.94261 23634	-0.05910 01483	0.31405 88602	0.71658 23333	0.840	
1.845	0.94410 21519	-0.05752 09071	0.31763 55846	0.71411 01788	0.845	
1.850	0.94561 11764	-0.05592 38130	0.32119 99895	0.71165 45396	0.850	
1.855	0.94713 94637	-0.05430 89276	0.32475 21572	0.70921 52546	0.855	
1.860	0.94868 70417	-0.05267 63117	0.32829 21691	0.70679 21650	0.860	
1.865	0.95025 39389	-0.05102 60260	0.33182 01056	0.70438 51138	0.865	
1.870	0.95184 01855	-0.04935 81307	0.33533 60467	0.70199 39461	0.870	
1.875	0.95344 58127	-0.04767 26854	0.33884 00713	0.69961 85089	0.875	
1.880	0.95507 08530	-0.04596 97497	0.34233 22577	0.69725 86512	0.880	
1.885	0.95671 53398	-0.04424 93824	0.34581 26835	0.69491 42236	0.885	
1.890	0.95837 93077	-0.04251 16423	0.34928 14255	0.69258 50790	0.890	
1.895	0.96006 27927	-0.04075 65875	0.35273 85596	0.69027 10717	0.895	
1.900	0.96176 58319	-0.03898 42759	0.35618 41612	0.68797 20582	0.900	
1.905	0.96348 84632	-0.03719 47650	0.35961 83049	0.68568 78965	0.905	
1.910	0.96523 07261	-0.03538 81118	0.36304 10646	0.68341 84465	0.910	
1.915	0.96699 26608	-0.03356 43732	0.36645 25136	0.68116 35696	0.915	
1.920	0.96877 43090	-0.03172 36054	0.36985 27244	0.67892 31293	0.920	
1.925	0.97057 57134	-0.02986 58646	0.37324 17688	0.67669 69903	0.925	
1.930	0.97239 69178	-0.02799 12062	0.37661 97179	0.67448 50194	0.930	
1.935	0.97423 79672	-0.02609 96858	0.37998 66424	0.67228 70846	0.935	
1.940	0.97609 89075	-0.02419 13581	0.38334 26119	0.67010 30559	0.940	
1.945	0.97797 97861	-0.02226 62778	0.38668 76959	0.66793 28044	0.945	
1.950	0.97988 06513	-0.02032 44991	0.39002 19627	0.66577 62034	0.950	
1.955	0.98180 15524	-0.01836 60761	0.39334 54805	0.66363 31270	0.955	
1.960	0.98374 25404	-0.01639 10621	0.39665 83163	0.66150 34514	0.960	
1.965	0.98570 36664	-0.01439 95106	0.39996 05371	0.65938 70538	0.965	
1.970	0.98768 49838	-0.01239 14744	0.40325 22088	0.65728 38134	0.970	
1.975	0.98968 65462	-0.01036 70060	0.40653 33970	0.65519 36104	0.975	
1.980	0.99170 84087	-0.00832 61578	0.40980 41664	0.65311 63266	0.980	
1.985	0.99375 06274	-0.00626 89816	0.41306 45816	0.65105 18450	0.985	
1.990	0.99581 32598	-0.00419 55291	0.41631 47060	0.64900 00505	0.990	
1.995	0.99789 63643	-0.00210 58516	0.41955 46030	0.64696 08286	0.995	
2.000	1.00000 00000	0.00000 00000	0.42278 43351	0.64493 40668	1.000	

$$\begin{array}{ccccccc}
 & y! & \ln y! & \frac{d}{dy} \ln y! & \frac{d^2}{dy^2} \ln y! & y & \\
 & \left[\begin{matrix} (-6)2 \\ 4 \end{matrix} \right] & \left[\begin{matrix} (-6)2 \\ 4 \end{matrix} \right] & \left[\begin{matrix} (-6)2 \\ 4 \end{matrix} \right] & \left[\begin{matrix} (-6)2 \\ 4 \end{matrix} \right] & & \\
 & & \log_{10} e = 0.43429 & 44819 & & &
 \end{array}$$

TETRAGAMMA AND PENTAGAMMA FUNCTIONS

Table 6.2

x	$\psi''(x)$	$\psi^{(3)}(x)$		x	$\psi''(x)$	$\psi^{(3)}(x)$	
1.00	-2.40411 38063	6.49393 94023	0.00	1.50	-0.82879 66442	1.40909 10340	0.50
1.01	-2.34039 86771	6.25106 18729	0.01	1.51	-0.81487 76121	1.37489 70527	0.51
1.02	-2.27905 42052	6.01969 49890	0.02	1.52	-0.80129 51399	1.34177 21104	0.52
1.03	-2.21996 85963	5.79918 38573	0.03	1.53	-0.78803 87419	1.30967 56244	0.53
1.04	-2.16303 63855	5.58891 68399	0.04	1.54	-0.77509 83287	1.27856 88154	0.54
1.05	-2.10815 80219	5.38832 23132	0.05	1.55	-0.76246 41904	1.24841 46160	0.55
1.06	-2.05523 94833	5.19686 56970	0.06	1.56	-0.75012 69793	1.21917 75841	0.56
1.07	-2.00419 19194	5.01404 67303	0.07	1.57	-0.73807 76946	1.19082 38216	0.57
1.08	-1.95493 13213	4.83939 69702	0.08	1.58	-0.72630 76669	1.16332 08979	0.58
1.09	-1.90737 82154	4.67247 74947	0.09	1.59	-0.71480 85441	1.13663 77770	0.59
1.10	-1.86145 73783	4.51287 67903	0.10	1.60	-0.70357 22779	1.11074 47490	0.60
1.11	-1.81709 75731	4.36020 88083	0.11	1.61	-0.69259 11105	1.08561 33658	0.61
1.12	-1.77423 13035	4.21411 11755	0.12	1.62	-0.68185 75627	1.06121 63792	0.62
1.13	-1.73279 45852	4.07424 35447	0.13	1.63	-0.67136 44220	1.03752 76835	0.63
1.14	-1.69272 67342	3.94028 60737	0.14	1.64	-0.66110 47316	1.01452 22608	0.64
1.15	-1.65397 01677	3.81193 80220	0.15	1.65	-0.65107 17793	0.99217 61290	0.65
1.16	-1.61647 02206	3.68891 64540	0.16	1.66	-0.64125 90881	0.97046 62927	0.66
1.17	-1.58017 49731	3.57095 50416	0.17	1.67	-0.63166 04061	0.94937 06973	0.67
1.18	-1.54503 50903	3.45780 29554	0.18	1.68	-0.62226 96973	0.92886 81843	0.68
1.19	-1.51100 36723	3.34922 38402	0.19	1.69	-0.61308 11332	0.90893 84502	0.69
1.20	-1.47803 61144	3.24499 48647	0.20	1.70	-0.60408 90841	0.88956 20066	0.70
1.21	-1.44608 99765	3.14490 58422	0.21	1.71	-0.59528 81112	0.87072 61433	0.71
1.22	-1.41512 48602	3.04875 84139	0.22	1.72	-0.58667 29593	0.85239 48922	0.72
1.23	-1.38510 22950	2.95636 52925	0.23	1.73	-0.57823 85490	0.83456 89940	0.73
1.24	-1.35598 56308	2.86754 95589	0.24	1.74	-0.56997 99702	0.81722 58660	0.74
1.25	-1.32773 99375	2.78214 40092	0.25	1.75	-0.56189 24756	0.80034 95719	0.75
1.26	-1.30033 19112	2.69999 05478	0.26	1.76	-0.55397 14738	0.78392 47929	0.76
1.27	-1.27372 97857	2.62093 96227	0.27	1.77	-0.54621 25238	0.76793 68005	0.77
1.28	-1.24790 32496	2.54484 97000	0.28	1.78	-0.53861 13291	0.75237 14300	0.78
1.29	-1.22282 33691	2.47158 67746	0.29	1.79	-0.53116 37320	0.73721 50564	0.79
1.30	-1.19846 25147	2.40102 39143	0.30	1.80	-0.52386 57084	0.72245 45705	0.80
1.31	-1.17479 42923	2.33304 08348	0.31	1.81	-0.51671 33630	0.70807 73565	0.81
1.32	-1.15179 34794	2.26752 35032	0.32	1.82	-0.50970 29242	0.69407 12710	0.82
1.33	-1.12943 59642	2.20436 37678	0.33	1.83	-0.50283 07396	0.68042 46226	0.83
1.34	-1.10769 86881	2.14345 90132	0.34	1.84	-0.49609 32712	0.66712 61527	0.84
1.35	-1.08655 95925	2.08471 18367	0.35	1.85	-0.48948 70921	0.65416 50169	0.85
1.36	-1.06599 75682	2.02802 97472	0.36	1.86	-0.48300 88813	0.64153 07680	0.86
1.37	-1.04599 24073	1.97332 48830	0.37	1.87	-0.47665 54207	0.62921 33389	0.87
1.38	-1.02652 47586	1.92051 37473	0.38	1.88	-0.47042 35909	0.61720 30270	0.88
1.39	-1.00757 60850	1.86951 69616	0.39	1.89	-0.46431 03677	0.60549 04793	0.89
1.40	-0.98912 86236	1.82025 90339	0.40	1.90	-0.45831 28188	0.59406 66772	0.90
1.41	-0.97116 53479	1.77266 81419	0.41	1.91	-0.45242 81007	0.58292 29238	0.91
1.42	-0.95366 99322	1.72667 59295	0.42	1.92	-0.44665 34549	0.57205 08299	0.92
1.43	-0.93662 67177	1.68221 73161	0.43	1.93	-0.44098 62055	0.56144 23020	0.93
1.44	-0.92002 06808	1.63923 03178	0.44	1.94	-0.43542 37563	0.55108 95304	0.94
1.45	-0.90383 74031	1.59765 58792	0.45	1.95	-0.42996 35876	0.54098 49774	0.95
1.46	-0.88806 30426	1.55743 77157	0.46	1.96	-0.42460 32537	0.53112 13668	0.96
1.47	-0.87268 43070	1.51852 21649	0.47	1.97	-0.41934 03805	0.52149 16733	0.97
1.48	-0.85768 84281	1.48085 80478	0.48	1.98	-0.41417 26631	0.51208 91127	0.98
1.49	-0.84306 31376	1.44439 65370	0.49	1.99	-0.40909 78630	0.50290 71324	0.99
1.50	-0.82879 66442	1.40909 10340	0.50	2.00	-0.40411 38063	0.49393 94023	1.00

* $\frac{d^3}{dy^3} \ln y!$ $\frac{d^4}{dy^4} \ln y!$ y $\frac{d^3}{dy^3} \ln y!$ $\frac{d^4}{dy^4} \ln y!$ y *

$\left[\begin{matrix} (-4)3 \\ 7 \end{matrix} \right]$ $\left[\begin{matrix} (-3)1 \\ 7 \end{matrix} \right]$ $\left[\begin{matrix} (-5)4 \\ 6 \end{matrix} \right]$ $\left[\begin{matrix} (-4)1 \\ 6 \end{matrix} \right]$

Compiled from H. T. Davis, Tables of the higher mathematical functions, 2 vols. (Principia Press, Bloomington, Ind., 1933, 1935) (with permission).

*See page 11.

Table 6.3 GAMMA AND DIGAMMA FUNCTIONS FOR INTEGER AND HALF-INTEGER VALUES

n	$\Gamma(n)$	$1/\Gamma(n)$	$\Gamma(n+\frac{1}{2})$	$\psi(n)$	$f_1(n)$	$f_3(n)$
1	(0) 1.00000 00000	(0) 1.00000 000	(-1) 8.86226 93	-0.57721 56649	1.08443 755	0.57721 566
2	(0) 1.00000 00000	(0) 1.00000 000	(0) 1.32934 04	+0.42278 43351	1.04220 712	0.27036 285
3	(0) 2.00000 00000	(- 1) 5.00000 000	(0) 3.32335 10	0.92278 43351	1.02806 452	0.17582 795
4	(0) 6.00000 00000	(- 1) 1.66666 667	(1) 1.16317 28	1.25611 76684	1.02100 830	0.13017 669
5	(1) 2.40000 00000	(- 2) 4.16666 667	(1) 5.23427 78	1.50611 76684	1.01678 399	0.10332 024
6	(2) 1.20000 00000	(- 3) 8.33333 333	(2) 2.87885 28	1.70611 76684	1.01397 285	0.08564 180
7	(2) 7.20000 00000	(- 3) 1.38888 889	(3) 1.87125 43	1.87278 43351	1.01196 776	0.07312 581
8	(3) 5.04000 00000	(- 4) 1.98412 698	(4) 1.40344 07	2.01564 14780	1.01046 565	0.06380 006
9	(4) 4.03200 00000	(- 5) 2.48015 873	(5) 1.19292 46	2.14064 14780	1.00929 843	0.05658 310
10	(5) 3.62880 00000	(- 6) 2.75573 192	(6) 1.13327 84	2.25175 25891	1.00836 536	0.05083 250
11	(6) 3.62880 00000	(- 7) 2.75573 192	(7) 1.18994 23	2.35175 25891	1.00760 243	0.04614 268
12	(7) 3.99168 00000	(- 8) 2.50521 084	(8) 1.36843 37	2.44266 16800	1.00696 700	0.04224 497
13	(8) 4.79001 60000	(- 9) 2.08767 570	(9) 1.71054 21	2.52599 50133	1.00642 958	0.03895 434
14	(9) 6.22702 08000	(-10) 1.60590 438	(10) 2.30923 18	2.60291 80902	1.00596 911	0.03613 924
15	(10) 8.71782 91200	(-11) 1.14707 456	(11) 3.34838 61	2.67434 66617	1.00557 019	0.03370 354
16	(12) 1.30767 43680	(-13) 7.64716 373	(12) 5.18999 85	2.74101 33283	1.00522 124	0.03157 539
17	(13) 2.09227 89888	(-14) 4.77947 733	(13) 8.56349 74	2.80351 33283	1.00491 343	0.02970 002
18	(14) 3.55687 42810	(-15) 2.81145 725	(15) 1.49861 21	2.86233 68577	1.00463 988	0.02803 490
19	(15) 6.40237 37057	(-16) 1.56192 070	(16) 2.77243 23	2.91789 24133	1.00439 519	0.02654 657
20	(17) 1.21645 10041	(-18) 8.22063 525	(17) 5.40624 30	2.97052 39922	1.00417 501	0.02520 828
21	(18) 2.43290 20082	(-19) 4.11031 762	(19) 1.10827 98	3.02052 39922	1.00397 584	0.02399 845
22	(19) 5.10909 42172	(-20) 1.95729 411	(20) 2.38280 16	3.06814 30399	1.00379 480	0.02289 941
23	(21) 1.12400 07278	(-22) 8.89679 139	(21) 5.36130 36	3.11359 75853	1.00362 953	0.02189 663
24	(22) 2.58520 16739	(-23) 3.86817 017	(23) 1.25990 63	3.15707 58462	1.00347 806	0.02097 798
25	(23) 6.20448 40173	(-24) 1.61173 757	(24) 3.08677 05	3.19874 25129	1.00333 872	0.02013 331
26	(25) 1.55112 10043	(-26) 6.44695 029	(25) 7.87126 49	3.23874 25129	1.00321 011	0.01935 403
27	(26) 4.03291 46113	(-27) 2.47959 626	(27) 2.08588 52	3.27720 40513	1.00309 105	0.01863 281
28	(28) 1.08888 69450	(-29) 9.18368 986	(28) 5.73618 43	3.31424 10884	1.00298 050	0.01796 342
29	(29) 3.04888 34461	(-30) 3.27988 924	(30) 1.63481 25	3.34995 53741	1.00287 758	0.01734 046
30	(30) 8.84176 19937	(-31) 1.13099 629	(31) 4.82269 69	3.38443 81327	1.00278 154	0.01675 925
31	(32) 2.65252 85981	(-33) 3.76998 763	(33) 1.47092 26	3.41777 14660	1.00269 170	0.01621 574
32	(33) 8.22283 86542	(-34) 1.21612 504	(34) 4.63340 61	3.45002 95305	1.00260 748	0.01570 637
33	(35) 2.63130 83693	(-36) 3.80039 076	(36) 1.50585 70	3.48127 95305	1.00252 837	0.01522 803
34	(36) 8.68331 76188	(-37) 1.15163 356	(37) 5.04462 09	3.51158 25608	1.00245 392	0.01477 796
35	(38) 2.95232 79904	(-39) 3.38715 754	(39) 1.74039 42	3.54099 43255	1.00238 372	0.01435 374
36	(40) 1.03331 47966	(-41) 9.67759 296	(40) 6.17839 94	3.56956 57541	1.00231 744	0.01395 318
37	(41) 3.71993 32679	(-42) 2.68822 027	(42) 2.25511 58	3.59734 35319	1.00225 474	0.01357 438
38	(43) 1.37637 53091	(-44) 7.26546 018	(43) 8.45668 42	3.62437 05589	1.00219 534	0.01321 560
39	(44) 5.23022 61747	(-45) 1.91196 320	(45) 3.25582 34	3.65068 63484	1.00213 899	0.01287 530
40	(46) 2.03978 82081	(-47) 4.90246 976	(47) 1.28605 02	3.67632 73740	1.00208 546	0.01255 208
41	(47) 8.15915 28325	(-48) 1.22561 744	(48) 5.20850 35	3.70132 73740	1.00203 455	0.01224 469
42	(49) 3.34525 26613	(-50) 2.98931 083	(50) 2.16152 90	3.72571 76179	1.00198 606	0.01195 200
43	(51) 1.40500 61178	(-52) 7.11740 673	(51) 9.18649 81	3.74952 71417	1.00193 983	0.01167 297
44	(52) 6.04152 63063	(-53) 1.65521 087	(53) 3.99612 67	3.77278 29557	1.00189 570	0.01140 668
45	(54) 2.65827 15748	(-55) 3.76184 288	(55) 1.77827 64	3.79551 02284	1.00185 354	0.01115 226
46	(56) 1.19622 22087	(-57) 8.35965 084	(56) 8.09115 74	3.81773 24506	1.00181 321	0.01090 895
47	(57) 5.50262 21598	(-58) 1.81731 540	(58) 3.76238 82	3.83947 15811	1.00177 460	0.01067 602
48	(59) 2.58623 24151	(-60) 3.86662 851	(60) 1.78713 44	3.86074 81768	1.00173 759	0.01045 283
49	(61) 1.24139 15593	(-62) 8.05547 607	(61) 8.66760 18	3.88158 15102	1.00170 210	0.01023 879
50	(62) 6.08281 86403	(-63) 1.64397 471	(63) 4.29046 29	3.90198 96734	1.00166 803	0.01003 333
51	(64) 3.04140 93202	(-65) 3.28794 942	(65) 2.16668 38	3.92198 96734	1.00163 530	0.00983 596

$$\begin{aligned}
 & (n-1)! \qquad \qquad \qquad 1/(n-1)! \qquad \qquad \qquad (n-\frac{1}{2})! \qquad \qquad \frac{d}{dn} \ln(n-1)! * \\
 & n! = (2\pi)^{\frac{1}{2}} n^{n+\frac{1}{2}} e^{-n} f_1(n) \qquad \Gamma(n) = (2\pi)^{\frac{1}{2}} n^{n-\frac{1}{2}} e^{-n} f_1(n) \qquad \psi(n) = \ln n - f_3(n) \qquad (2\pi)^{\frac{1}{2}} = 2.50662 82746 31001
 \end{aligned}$$

$\psi(n)$ compiled from H. T. Davis, Tables of the higher mathematical functions, 2 vols. (Principia Press, Bloomington, Ind., 1933, 1935) (with permission).

*See page II.

GAMMA AND DIGAMMA FUNCTIONS FOR INTEGER AND HALF-INTEGER VALUES Table 6.3

n	$\Gamma(n)$	$1/\Gamma(n)$	$\Gamma(n+\frac{1}{2})$	$\psi(n)$	$f_1(n)$	$f_3(n)$
51	(64) 3.04140 93202	(-65) 3.28794 942	(65) 2.16668 38	3.92198 96734	1.00163 530	0.00983 596
52	(66) 1.55111 87533	(-67) 6.44695 964	(67) 1.11584 21	3.94159 75166	1.00160 383	0.00964 620
53	(67) 8.06581 75171	(-68) 1.23979 993	(68) 5.85817 12	3.96082 82858	1.00157 355	0.00946 363
54	(69) 4.27488 32841	(-70) 2.33924 515	(70) 3.13412 16	3.97969 62103	1.00154 438	0.00928 784
55	(71) 2.30843 69734	(-72) 4.33193 547	(72) 1.70809 63	3.99821 47288	1.00151 628	0.00911 846
56	(73) 1.26964 03354	(-74) 7.87624 631	(73) 9.47993 44	4.01639 65470	1.00148 919	0.00895 514
57	(74) 7.10998 58780	(-75) 1.40647 255	(75) 5.35616 29	4.03425 36899	1.00146 304	0.00879 758
58	(76) 4.05269 19505	(-77) 2.46749 571	(77) 3.07979 37	4.05179 75495	1.00143 780	0.00864 546
59	(78) 2.35056 13313	(-79) 4.25430 295	(79) 1.80167 93	4.06903 89288	1.00141 341	0.00849 852
60	(80) 1.38683 11855	(-81) 7.21068 296	(81) 1.07199 92	4.08598 80814	1.00138 984	0.00835 648
61	(81) 8.32098 71127	(-82) 1.20178 049	(82) 6.48559 51	4.10265 47481	1.00136 704	0.00821 912
62	(83) 5.07580 21388	(-84) 1.97013 196	(84) 3.98864 10	4.11904 81907	1.00134 498	0.00808 619
63	(85) 3.14699 73260	(-86) 3.17763 219	(86) 2.49290 06	4.13517 72229	1.00132 362	0.00795 750
64	(87) 1.98260 83154	(-88) 5.04386 062	(88) 1.58299 19	4.15105 02388	1.00130 292	0.00783 284
65	(89) 1.26886 93219	(-90) 7.88103 221	(90) 1.02102 98	4.16667 52388	1.00128 286	0.00771 203
66	(90) 8.24765 05921	(-91) 1.21246 649	(91) 6.68774 50	4.18205 98542	1.00126 341	0.00759 489
67	(92) 5.44344 93908	(-93) 1.83707 044	(93) 4.44735 04	4.19721 13693	1.00124 455	0.00748 125
68	(94) 3.64711 10918	(-95) 2.74189 619	(95) 3.00196 15	4.21213 67425	1.00122 623	0.00737 096
69	(96) 2.48003 55424	(-97) 4.03220 028	(97) 2.05634 36	4.22684 26248	1.00120 845	0.00726 388
70	(98) 1.71122 45243	(-99) 5.84376 852	(99) 1.42915 88	4.24133 53785	1.00119 118	0.00715 986
71	(100) 1.19785 71670	(-101) 8.34824 074	(101) 1.00755 70	4.25562 10927	1.00117 439	0.00705 878
72	(101) 8.50478 58857	(-102) 1.17580 856	(102) 7.20403 24	4.26970 55998	1.00115 807	0.00696 052
73	(103) 6.12344 58377	(-104) 1.63306 744	(104) 5.22292 35	4.28359 44887	1.00114 220	0.00686 495
74	(105) 4.47011 54615	(-106) 2.23707 868	(106) 3.83884 87	4.29729 31188	1.00112 675	0.00677 197
75	(107) 3.30788 54415	(-108) 3.02307 930	(108) 2.85994 23	4.31080 66323	1.00111 172	0.00668 148
76	(109) 2.48091 40811	(-110) 4.03077 240	(110) 2.15925 64	4.32413 99657	1.00109 709	0.00659 337
77	(111) 1.88549 47017	(-112) 5.30364 789	(112) 1.65183 12	4.33729 78604	1.00108 283	0.00650 756
78	(113) 1.45183 09203	(-114) 6.88785 441	(114) 1.28016 92	4.35028 48734	1.00106 894	0.00642 395
79	(115) 1.13242 81178	(-116) 8.83058 257	(116) 1.00493 28	4.36310 53862	1.00105 540	0.00634 247
80	(116) 8.94618 21308	(-117) 1.11779 526	(117) 7.98921 57	4.37576 36140	1.00104 220	0.00626 302
81	(118) 7.15694 57046	(-119) 1.39724 408	(119) 6.43131 87	4.38826 36140	1.00102 933	0.00618 554
82	(120) 5.79712 60207	(-121) 1.72499 269	(121) 5.24152 47	4.40060 92931	1.00101 677	0.00610 995
83	(122) 4.75364 33370	(-123) 2.10364 962	(123) 4.32425 79	4.41280 44150	1.00100 452	0.00603 619
84	(124) 3.94552 39697	(-125) 2.53451 761	(125) 3.61075 53	4.42485 26078	1.00099 255	0.00596 419
85	(126) 3.31424 01346	(-127) 3.01728 287	(127) 3.05108 83	4.43675 73697	1.00098 087	0.00589 389
86	(128) 2.81710 41144	(-129) 3.54974 456	(129) 2.60868 05	4.44852 20756	1.00096 946	0.00582 522
87	(130) 2.42270 95384	(-131) 4.12760 995	(131) 2.25650 86	4.46014 99825	1.00095 831	0.00575 814
88	(132) 2.10775 72984	(-133) 4.74437 926	(133) 1.97444 50	4.47164 42354	1.00094 741	0.00569 258
89	(134) 1.85482 64226	(-135) 5.39134 006	(135) 1.74738 38	4.48300 78718	1.00093 676	0.00562 850
90	(136) 1.65079 55161	(-137) 6.05768 546	(137) 1.56390 85	4.49424 38268	1.00092 635	0.00556 584
91	(138) 1.48571 59645	(-139) 6.73076 163	(139) 1.41533 72	4.50535 49379	1.00091 617	0.00550 457
92	(140) 1.35200 15277	(-141) 7.39644 134	(141) 1.29503 36	4.51634 39489	1.00090 620	0.00544 463
93	(142) 1.24384 14055	(-143) 8.03961 016	(143) 1.19790 60	4.52721 35142	1.00089 646	0.00538 598
94	(144) 1.15677 25071	(-145) 8.64474 211	(145) 1.12004 22	4.53796 62023	1.00088 691	0.00532 858
95	(146) 1.08736 61567	(-147) 9.19653 415	(147) 1.05843 98	4.54860 45002	1.00087 757	0.00527 239
96	(148) 1.03299 78488	(-149) 9.68056 227	(149) 1.01081 00	4.55913 08160	1.00086 843	0.00521 738
97	(149) 9.91677 93487	(-150) 1.00839 190	(150) 9.75431 69	4.56954 74827	1.00085 947	0.00516 350
98	(151) 9.61927 59682	(-152) 1.03957 928	(152) 9.51045 90	4.57985 67610	1.00085 070	0.00511 072
99	(153) 9.42689 04489	(-154) 1.06079 519	(154) 9.36780 21	4.59006 08426	1.00084 210	0.00505 901
100	(155) 9.33262 15444	(-156) 1.07151 029	(156) 9.32096 31	4.60016 18527	1.00083 368	0.00500 833
101	(157) 9.33262 15444	(-158) 1.07151 029	(158) 9.36756 79	4.61016 18527	1.00082 542	0.00495 866
	$(n-1)!$	$1/(n-1)!$	$(n-\frac{1}{2})!$	$* \frac{d}{dn} \ln(n-1)!$	$\left[\begin{matrix} (-7) \\ 3 \end{matrix} \right]$	$\left[\begin{matrix} 6 \\ 4 \end{matrix} \right]$
	$n! = (2\pi)^{\frac{1}{2}} n^{n+\frac{1}{2}} e^{-n} \Gamma(n)$	$\Gamma(n) = (2\pi)^{\frac{1}{2}} n^{n-\frac{1}{2}} e^{-n} \Gamma(n)$	$\psi(n) = \ln n - f_3(n)$	$(2\pi)^{\frac{1}{2}} = 2.50662 82746 31001$		

*See page II.

Table 6.4

LOGARITHMS OF THE GAMMA FUNCTION

n	$\log_{10} \Gamma(n)$	$\log_{10} \Gamma(n+\frac{1}{3})$	$\log_{10} \Gamma(n+\frac{1}{2})$	$\log_{10} \Gamma(n+\frac{2}{3})$	$f_2(n)$
1	0.00000 000	-0.04915 851	-0.05245 506	-0.04443 477	1.00000 000
2	0.00000 000	+0.07578 023	+0.12363 620	+0.17741 398	0.96027 923
3	0.30103 000	0.44375 702	0.52157 621	0.60338 271	0.94661 646
4	0.77815 125	0.96663 576	1.06564 43	1.16765 41	0.93972 921
5	1.38021 12	1.60345 79	1.71885 68	1.83666 09	0.93558 323
6	2.07918 12	2.33045 66	2.45921 95	2.58998 86	0.93281 466
7	2.85733 25	3.13208 89	3.27213 28	3.41389 73	0.93083 524
8	3.70243 05	3.99739 04	4.14719 41	4.29850 39	0.92934 980
9	4.60552 05	4.91820 91	5.07661 30	5.23635 60	0.92819 400
10	5.55976 30	5.88824 59	6.05433 66	6.22163 27	0.92726 910
11	6.55976 30	6.90248 63	7.07552 59	7.24966 15	0.92651 221
12	7.60115 57	7.95684 40	8.13622 37	8.31660 83	0.92588 137
13	8.68033 70	9.04792 45	9.23313 38	9.41927 06	0.92534 753
14	9.79428 03	10.17286 3	10.36346 8	10.55493 3	0.92488 990
15	10.94040 8	11.32921 0	11.52483 6	11.72126 5	0.92449 327
16	12.116500	12.514847	12.715167	12.916241	0.92414 619
17	13.320620	13.727922	13.932651	14.138090	0.92383 993
18	14.551069	14.966804	15.175689	15.385245	0.92356 769
19	15.806341	16.230045	16.442861	16.656311	0.92332 409
20	17.085095	17.516352	17.732896	17.950042	0.92310 485
21	18.386125	18.824561	19.044649	19.265313	0.92290 649
22	19.708344	20.153619	20.377088	20.601105	0.92272 615
23	21.050767	21.502573	21.729270	21.956492	0.92256 149
24	22.412494	22.870550	23.100338	23.330629	0.92241 055
25	23.792706	24.256751	24.489504	24.722740	0.92227 169
26	25.190646	25.660444	25.896045	26.132109	0.92214 350
27	26.605619	27.080949	27.319290	27.558078	0.92202 481
28	28.036983	28.517642	28.758623	29.000035	0.92191 460
29	29.484141	29.969940	30.213468	30.457412	0.92181 198
30	30.946539	31.437301	31.683290	31.929681	0.92171 621
31	32.423660	32.919221	33.167590	33.416347	0.92162 661
32	33.915022	34.415228	34.665900	34.916950	0.92154 262
33	35.420172	35.924878	36.177784	36.431055	0.92146 371
34	36.938686	37.447757	37.702829	37.958255	0.92138 944
35	38.470165	38.983473	39.240648	39.498167	0.92131 942
36	40.014233	40.531658	40.790876	41.050429	0.92125 329
37	41.570535	42.091963	42.353169	42.614701	0.92119 073
38	43.138737	43.664060	43.927200	44.190658	0.92113 146
39	44.718520	45.247636	45.512661	45.777995	0.92107 524
40	46.309585	46.842397	47.109258	47.376420	0.92102 182
41	47.911645	48.448061	48.716713	48.985659	0.92097 101
42	49.524429	50.064362	50.334761	50.605448	0.92092 262
43	51.147678	51.691044	51.963150	52.235536	0.92087 648
44	52.781147	53.327866	53.601639	53.875686	0.92083 244
45	54.424599	54.974597	55.249999	55.525670	0.92079 035
46	56.077812	56.631014	56.908011	57.185269	0.92075 010
47	57.740570	58.296908	58.575464	58.854276	0.92071 156
48	59.412668	59.972075	60.252157	60.532491	0.92067 462
49	61.093909	61.656322	61.937899	62.219723	0.92063 919
50	62.784105	63.349462	63.632504	63.915788	0.92060 518
51	64.483075	65.051318	65.335796	65.620510	0.92057 250
	$\log_{10} (n-1)!$	$\log_{10} (n-\frac{2}{3})!$	$\log_{10} (n-\frac{1}{2})!$	$\log_{10} (n-\frac{1}{3})!$	
	$\ln \Gamma(n) = \ln (n-1)! - (n-\frac{1}{2}) \ln n - n + f_2(n)$			$\ln 10 = 2.30258 509299$	

$\log_{10} \Gamma(n)$ compiled from E. S. Pearson, Table of the logarithms of the complete Γ -function, arguments 2 to 1200. Tracts for Computers No. VIII (Cambridge Univ. Press, Cambridge, England, 1922) (with permission).

LOGARITHMS OF THE GAMMA FUNCTION

Table 6.4

n	$\log_{10} \Gamma(n)$	$\log_{10} \Gamma(n + \frac{1}{3})$	$\log_{10} \Gamma(n + \frac{1}{2})$	$\log_{10} \Gamma(n + \frac{2}{3})$	$f_2(n)$
51	64.483075	65.051318	65.335796	65.620510	0.92057 250
52	66.190645	66.761717	67.047603	67.333720	0.92054 108
53	67.906648	68.480496	68.767762	69.055256	0.92051 084
54	69.630924	70.207494	70.496116	70.784961	0.92048 173
55	71.363318	71.942561	72.232512	72.522683	0.92045 367
56	73.103681	73.685548	73.976805	74.268279	0.92042 661
57	74.851869	75.436313	75.728854	76.021606	0.92040 051
58	76.607744	77.194720	77.488522	77.782531	0.92037 530
59	78.371172	78.960637	79.255677	79.550922	0.92035 095
60	80.142024	80.733936	81.030194	81.326654	0.92032 741
61	81.920175	82.514493	82.811950	83.109604	0.92030 464
62	83.705505	84.302190	84.600825	84.899655	0.92028 261
63	85.497896	86.096910	86.396705	86.696691	0.92026 127
64	87.297237	87.898542	88.199479	88.500604	0.92024 061
65	89.103417	89.706978	90.009038	90.311284	0.92022 057
66	90.916330	91.522113	91.825280	92.128629	0.92020 115
67	92.735874	93.343845	93.648101	93.952538	0.92018 231
68	94.561949	95.172075	95.477405	95.782913	0.92016 401
69	96.394458	97.006708	97.313096	97.619659	0.92014 625
70	98.233307	98.847650	99.155080	99.462684	0.92012 900
71	100.07841	100.69481	101.00327	101.31190	0.92011 223
72	101.92966	102.54810	102.85758	103.16722	0.92009 593
73	103.78700	104.40744	104.71791	105.02855	0.92008 008
74	105.65032	106.27274	106.58420	106.89582	0.92006 465
75	107.51955	108.14393	108.45636	108.76895	0.92004 964
76	109.39461	110.02091	110.33430	110.64785	0.92003 502
77	111.27543	111.90363	112.21797	112.53246	0.92002 078
78	113.16192	113.79200	114.10727	114.42269	0.92000 690
79	115.05401	115.68594	116.00214	116.31848	0.91999 338
80	116.95164	117.58540	117.90250	118.21976	0.91998 019
81	118.85473	119.49029	119.80830	120.12646	0.91996 733
82	120.76321	121.40056	121.71946	122.03850	0.91995 479
83	122.67703	123.31614	123.63591	123.95583	0.91994 254
84	124.59610	125.23696	125.55760	125.87838	0.91993 059
85	126.52038	127.16296	127.48445	127.80610	0.91991 892
86	128.44980	129.09407	129.41642	129.73891	0.91990 752
87	130.38430	131.03025	131.35344	131.67676	0.91989 638
88	132.32382	132.97143	133.29545	133.61959	0.91988 550
89	134.26830	134.91756	135.24239	135.56735	0.91987 486
90	136.21769	136.86857	137.19421	137.51999	0.91986 446
91	138.17194	138.82442	139.15086	139.47743	0.91985 428
92	140.13098	140.78505	141.11228	141.43964	0.91984 433
93	142.09477	142.75041	143.07842	143.40657	0.91983 459
94	144.06325	144.72044	145.04923	145.37815	0.91982 505
95	146.03638	146.69511	147.02467	147.35435	0.91981 572
96	148.01410	148.67435	149.00467	149.33511	0.91980 659
97	149.99637	150.65813	150.98920	151.32039	0.91979 764
98	151.98314	152.64639	152.97820	153.31013	0.91978 887
99	153.97437	154.63909	154.97164	155.30430	0.91978 028
100	155.97000	156.63619	156.96946	157.30285	0.91977 186
101	157.97000	158.63763	158.97163	159.30574	0.91976 361

$$\log_{10} (n-1)!$$

$$\log_{10} (n-\frac{2}{3})!$$

$$\log_{10} (n-\frac{1}{2})!$$

$$\log_{10} (n-\frac{1}{3})!$$

$$\left[\begin{matrix} (-7)2 \\ 3 \end{matrix} \right]$$

$$\ln \Gamma(n) = \ln (n-1)! = (n-\frac{1}{2}) \ln n - n + f_2(n)$$

$$\ln 10 = 2.30258 509299$$

Table 6.5 AUXILIARY FUNCTIONS FOR GAMMA AND DIGAMMA FUNCTIONS

x^{-1}	$f_1(x)$	$f_2(x)$	$f_3(x)$	$\langle x \rangle$
0.015	1.00125 077	0.92018 852	0.00751 875	67
0.014	1.00116 735	0.92010 519	0.00701 633	71
0.013	1.00108 391	0.92002 186	0.00651 408	77
0.012	1.00100 050	0.91993 853	0.00601 200	83
0.011	1.00091 708	0.91985 520	0.00551 008	91
0.010	1.00083 368	0.91977 186	0.00500 833	100
0.009	1.00075 028	0.91968 853	0.00450 675	111
0.008	1.00066 689	0.91960 520	0.00400 533	125
0.007	1.00058 350	0.91952 187	0.00350 408	143
0.006	1.00050 012	0.91943 853	0.00300 300	167
0.005	1.00041 675	0.91935 520	0.00250 208	200
0.004	1.00033 339	0.91927 187	0.00200 133	250
0.003	1.00025 003	0.91918 853	0.00150 075	333
0.002	1.00016 668	0.91910 520	0.00100 033	500
0.001	1.00008 334	0.91902 187	0.00050 008	1000
0.000	1.00000 000	0.91893 853	0.00000 000	∞

$$\left[\begin{matrix} (-8)1 \\ 2 \end{matrix} \right] \quad \left[\begin{matrix} (-8)1 \\ 2 \end{matrix} \right] \quad \left[\begin{matrix} (-8)2 \\ 3 \end{matrix} \right]$$

$$x! = (2\pi)^{\frac{1}{2}} x^{x+\frac{1}{2}} e^{-x} f_1(x)$$

$$\Gamma(x) = (2\pi)^{\frac{1}{2}} x^{x-\frac{1}{2}} e^{-x} f_1(x)$$

$$\ln \Gamma(x) = \ln(x-1)! = (x-\frac{1}{2}) \ln x - x + f_2(x)$$

$$\psi(x) = \ln x - f_3(x)$$

$$(2\pi)^{\frac{1}{2}} = 2.50662 82746 31001$$

$\langle x \rangle$ = nearest integer to x .

Table 6.6 FACTORIALS FOR LARGE ARGUMENTS

n	$n!$	n	$n!$
100	(157) 9.3326 21544 39441 52682	600	(1408) 1.2655 72316 22543 07425
200	(374) 7.8865 78673 64790 50355	700	(1689) 2.4220 40124 75027 21799
300	(614) 3.0605 75122 16440 63604	800	(1976) 7.7105 30113 35386 00414
400	(868) 6.4034 52284 66238 95262	900	(2269) 6.7526 80220 96458 41584
500	(1134) 1.2201 36825 99111 00687	1000	(2567) 4.0238 72600 77093 77354

$\Gamma(n+1)$

$\Gamma(n+1)$

Compiled from Ballistic Research Laboratory, A table of the factorial numbers and their reciprocals from 1! to 1000! to 20 significant digits, Technical Note No. 381, Aberdeen Proving Ground, Md.(1951) (with permission).

GAMMA FUNCTION FOR COMPLEX ARGUMENTS

Table 6.7

$x=1.0$					
y	$\Re \ln \Gamma(z)$	$\Im \ln \Gamma(z)$	y	$\Re \ln \Gamma(z)$	$\Im \ln \Gamma(z)$
0.0	0.00000 00000 00	0.00000 00000 00	5.0	- 6.13032 41445 53	3.81589 85746 15
0.1	- 0.00819 77805 65	- 0.05732 29404 17	5.1	- 6.27750 24635 84	3.97816 38691 88
0.2	- 0.03247 62923 18	- 0.11230 22226 44	5.2	- 6.42487 30533 35	4.14237 74050 86
0.3	- 0.07194 62509 00	- 0.16282 06721 68	5.3	- 6.57242 85885 29	4.30850 21885 83
0.4	- 0.12528 93748 21	- 0.20715 58263 16	5.4	- 6.72016 21547 03	4.47650 25956 68
0.5	- 0.19094 54991 87	- 0.24405 82989 05	5.5	- 6.86806 72180 48	4.64634 42978 70
0.6	- 0.26729 00682 14	- 0.27274 38104 91	5.6	- 7.01613 75979 76	4.81799 41933 05
0.7	- 0.35276 86908 60	- 0.29282 63511 87	5.7	- 7.16436 74421 06	4.99142 03424 89
0.8	- 0.44597 87835 49	- 0.30422 56029 76	5.8	- 7.31275 12034 30	5.16659 19085 37
0.9	- 0.54570 51286 05	- 0.30707 43756 42	5.9	- 7.46128 36194 29	5.34347 91013 53
1.0	- 0.65092 31993 02	- 0.30164 03204 68	6.0	- 7.60995 96929 51	5.52205 31255 15
1.1	- 0.76078 39588 41	- 0.28826 66142 39	6.1	- 7.75877 46746 55	5.70228 61315 35
1.2	- 0.87459 04638 95	- 0.26733 05805 81	6.2	- 7.90772 40468 98	5.88415 11702 39
1.3	- 0.99177 27669 59	- 0.23921 67844 65	6.3	- 8.05680 35089 04	6.06762 21500 13
1.4	- 1.11186 45664 26	- 0.20430 07241 49	6.4	- 8.20600 89631 00	6.25267 37967 05
1.5	- 1.23448 30515 47	- 0.16293 97694 80	6.5	- 8.35533 65025 11	6.43928 16159 76
1.6	- 1.35931 22484 65	- 0.11546 87935 89	6.6	- 8.50478 23991 25	6.62742 18579 12
1.7	- 1.48608 96127 57	- 0.06219 86983 29	6.7	- 8.65434 30931 23	6.81707 14837 44
1.8	- 1.61459 53960 00	- 0.00341 66314 77	6.8	- 8.80401 51829 10	7.00820 81345 02
1.9	- 1.74464 42761 74	+ 0.06061 28742 95	6.9	- 8.95379 54158 79	7.20081 01014 93
2.0	- 1.87607 87864 31	0.12964 63163 10	7.0	- 9.10368 06798 32	7.39485 62984 36
2.1	- 2.00876 41504 71	0.20345 94738 33	7.1	- 9.25366 79950 15	7.59032 62351 84
2.2	- 2.14258 42092 96	0.28184 56584 26	7.2	- 9.40375 45067 08	7.78719 99928 77
2.3	- 2.27743 81922 04	0.36461 40489 50	7.3	- 9.55393 74783 21	7.98545 82004 68
2.4	- 2.41323 81411 84	0.45158 81524 41	7.4	- 9.70421 42849 72	8.18508 20125 03
2.5	- 2.54990 68424 95	0.54260 44058 52	7.5	- 9.85458 24074 86	8.38605 30880 89
2.6	- 2.68737 61537 50	0.63751 09190 46	7.6	-10.00503 94267 90	8.58835 35709 62
2.7	- 2.82558 56411 91	0.73616 63516 79	7.7	-10.15558 30186 86	8.79196 60705 87
2.8	- 2.96448 14617 89	0.83843 89130 96	7.8	-10.30621 09489 48	8.99687 36442 29
2.9	- 3.10401 54399 01	0.94420 54730 39	7.9	-10.45692 10687 39	9.20305 97799 25
3.0	- 3.24414 42995 90	1.05335 07710 69	8.0	-10.60771 13103 15	9.41050 83803 12
3.1	- 3.38482 90223 77	1.16576 67132 86	8.1	-10.75857 96829 95	9.61920 37472 42
3.2	- 3.52603 43067 09	1.28135 17459 32	8.2	-10.90952 42693 78	9.82913 05671 62
3.3	- 3.66772 81104 88	1.40001 02965 76	8.3	-11.06054 32217 92	10.04027 38971 80
3.4	- 3.80988 12618 23	1.52165 22746 73	8.4	-11.21163 47589 48	10.25261 91518 09
3.5	- 3.95246 71261 89	1.64619 26242 69	8.5	-11.36279 71628 04	10.46615 20903 24
3.6	- 4.09546 13204 51	1.77355 09225 91	8.6	-11.51402 87756 02	10.68085 88047 12
3.7	- 4.23884 14660 71	1.90365 10190 19	8.7	-11.66532 79970 81	10.89672 57081 77
3.8	- 4.38258 69752 28	2.03642 07096 93	8.8	-11.81669 32818 48	11.11373 95241 57
3.9	- 4.52667 88647 16	2.17179 14436 05	8.9	-11.96812 31369 01	11.33188 72758 53
4.0	- 4.67109 95934 09	2.30969 80565 73	9.0	-12.11961 61192 81	11.55115 62762 02
4.1	- 4.81583 29197 96	2.45007 85299 47	9.1	-12.27117 08338 67	11.77153 41183 09
4.2	- 4.96086 37766 87	2.59287 37713 19	9.2	-12.42278 59312 81	11.99300 86662 85
4.3	- 5.10617 81606 63	2.73802 74148 20	9.3	-12.57446 01059 08	12.21556 80464 79
4.4	- 5.25176 30342 30	2.88548 56389 27	9.4	-12.72619 20940 29	12.43920 06390 90
4.5	- 5.39760 62389 84	3.03519 69999 22	9.5	-12.87798 06720 44	12.66389 50701 28
4.6	- 5.54369 64183 04	3.18711 22793 89	9.6	-13.02982 46547 89	12.88964 02037 08
4.7	- 5.69002 29483 73	3.34118 43443 27	9.7	-13.18172 28939 51	13.11642 51346 66
4.8	- 5.83657 58764 54	3.49736 80186 15	9.8	-13.33367 42765 47	13.34423 91814 77
4.9	- 5.98334 58655 32	3.65561 99647 12	9.9	-13.48567 77234 95	13.57307 18794 55
5.0	- 6.13032 41445 53	3.81589 85746 15	10.0	-13.63773 21882 47	13.80291 29742 30

Linear interpolation will yield about three figures; eight-point interpolation will yield about eight figures.

For z outside the range of the table, see Examples 5-8.

$$\Re \ln \Gamma(z) = \ln |\Gamma(z)|$$

$$\Im \ln \Gamma(z) = \arg \Gamma(z)$$

Table 6.7

GAMMA FUNCTION FOR COMPLEX ARGUMENTS

$r=1.1$

y	$\Re \ln \Gamma(z)$	$\Im \ln \Gamma(z)$	y	$\Re \ln \Gamma(z)$	$\Im \ln \Gamma(z)$
0.0	- 0.04987 24412 60	0.00000 00000 00	5.0	- 5.96893 91493 52	3.96198 63258 60
0.1	- 0.05702 02290 38	- 0.04206 65443 76	5.1	- 6.11415 43840 05	4.12446 68364 90
0.2	- 0.07824 35801 68	- 0.08230 97383 98	5.2	- 6.25959 93585 61	4.28888 73284 80
0.3	- 0.11291 43470 17	- 0.11905 06275 18	5.3	- 6.40526 53566 40	4.45521 12743 47
0.4	- 0.16008 21257 99	- 0.15086 79240 09	5.4	- 6.55114 41480 20	4.62340 34819 04
0.5	- 0.21858 96764 09	- 0.17666 11398 43	5.5	- 6.69722 79531 89	4.79343 00232 04
0.6	- 0.28718 99839 43	- 0.19566 16788 64	5.6	- 6.84350 94110 69	4.96525 81683 67
0.7	- 0.36464 38731 53	- 0.20740 35526 60	5.7	- 6.98998 15495 70	5.13885 63238 91
0.8	- 0.44978 83131 87	- 0.21167 10325 55	5.8	- 7.13663 77586 96	5.31419 39750 77
0.9	- 0.54157 54093 11	- 0.20843 91333 00	5.9	- 7.28347 17659 19	5.49124 16322 40
1.0	- 0.63908 78153 48	- 0.19781 78257 67	6.0	- 7.43047 76136 25	5.66997 07803 94
1.1	- 0.74153 80620 74	- 0.18000 55175 74	6.1	- 7.57764 96383 95	5.85035 38321 46
1.2	- 0.84825 85646 26	- 0.15525 33222 12	6.2	- 7.72498 24519 72	6.03236 40835 50
1.3	- 0.95868 73364 97	- 0.12383 93047 38	6.3	- 7.87247 09237 38	6.21597 56726 90
1.4	- 1.07235 26519 67	- 0.08605 08957 00	6.4	- 8.02011 01645 61	6.40116 35407 92
1.5	- 1.18885 84815 22	- 0.04217 34907 11	6.5	- 8.16789 55118 88	6.58790 33956 67
1.6	- 1.30787 15575 95	+ 0.00751 65191 79	6.6	- 8.31582 25159 69	6.77617 16773 32
1.7	- 1.42911 03402 04	0.06275 56777 30	6.7	- 8.46388 69271 17	6.96594 55256 30
1.8	- 1.55233 58336 11	0.12329 53847 15	6.8	- 8.61208 46838 95	7.15720 27497 24
1.9	- 1.67734 40572 49	0.18890 25358 69	6.9	- 8.76041 19021 72	7.34992 17993 20
2.0	- 1.80395 99248 63	0.25935 93780 23	7.0	- 8.90886 48649 60	7.54408 17375 09
2.1	- 1.93203 22878 13	0.33446 29085 79	7.1	- 9.05744 00129 63	7.73966 22151 13
2.2	- 2.06142 99239 46	0.41402 40321 50	7.2	- 9.20613 39357 92	7.93664 34464 25
2.3	- 2.19203 82866 29	0.49786 66085 82	7.3	- 9.35494 33637 73	8.13500 61862 70
2.4	- 2.32375 68617 01	0.58582 64745 04	7.4	- 9.50386 51603 25	8.33473 17082 71
2.5	- 2.45649 70097 26	0.67775 04868 09	7.5	- 9.65289 63148 29	8.53580 17842 76
2.6	- 2.59018 01959 43	0.77349 56148 91	7.6	- 9.80203 39359 83	8.73819 86648 33
2.7	- 2.72473 65306 67	0.87292 80949 66	7.7	- 9.95127 52455 81	8.94190 50606 84
2.8	- 2.86010 35591 81	0.97592 26515 07	7.8	-10.10061 75726 94	9.14690 41251 84
2.9	- 2.99622 52529 98	1.08236 17859 08	7.9	-10.25005 83482 21	9.35317 94376 01
3.0	- 3.13305 11644 50	1.19213 51297 05	8.0	-10.39959 50997 80	9.56071 49872 49
3.1	- 3.27053 57144 30	1.30513 88581 77	8.1	-10.54922 54469 17	9.76949 51583 85
3.2	- 3.40863 75892 32	1.42127 51595 43	8.2	-10.69894 70966 06	9.97950 47158 43
3.3	- 3.54731 92273 03	1.54045 17547 76	8.3	-10.84875 78390 24	10.19072 87913 49
3.4	- 3.68654 63804 17	1.66258 14631 94	8.4	-10.99865 55435 72	10.40315 28704 84
3.5	- 3.82628 77368 25	1.78758 18092 68	8.5	-11.14863 81551 38	10.61676 27802 52
3.6	- 3.96651 45962 20	1.91537 46664 26	8.6	-11.29870 36905 72	10.83154 46772 22
3.7	- 4.10720 05882 64	2.04588 59340 24	8.7	-11.44885 02353 71	11.04748 50362 14
3.8	- 4.24832 14278 81	2.17904 52440 32	8.8	-11.59907 59405 42	11.26457 06394 86
3.9	- 4.38985 47017 40	2.31478 56943 26	8.9	-11.74937 90196 53	11.48278 85664 18
4.0	- 4.53177 96812 84	2.45304 36058 25	9.0	-11.89975 77460 43	11.70212 61836 32
4.1	- 4.67407 71584 70	2.59375 83010 13	9.1	-12.05021 04501 83	11.92257 11355 62
4.2	- 4.81672 93009 83	2.73687 19016 54	9.2	-12.20073 55171 88	12.14411 13354 15
4.3	- 4.95971 95242 44	2.88232 91437 48	9.3	-12.35133 13844 58	12.36673 49565 33
4.4	- 5.10303 23779 21	3.03007 72080 09	9.4	-12.50199 65394 43	12.59043 04241 06
4.5	- 5.24665 34450 28	3.18006 55643 29	9.5	-12.65272 95175 33	12.81518 64072 43
4.6	- 5.39056 92519 72	3.33224 58288 43	9.6	-12.80352 89000 52	13.04099 18113 65
4.7	- 5.53476 71881 64	3.48657 16324 07	9.7	-12.95439 33123 60	13.26783 57709 12
4.8	- 5.67923 54339 89	3.64299 84993 84	9.8	-13.10532 14220 44	13.49570 76423 49
4.9	- 5.82396 28961 29	3.80148 37357 79	9.9	-13.25631 19372 14	13.72459 69974 44
5.0	- 5.96893 91493 52	3.96198 63258 60	10.0	-13.40736 36048 74	13.95449 36168 27

GAMMA FUNCTION FOR COMPLEX ARGUMENTS

Table 6.7

$x=1.2$

y	$\Re \ln \Gamma(z)$	$\Im \ln \Gamma(z)$	y	$\Re \ln \Gamma(z)$	$\Im \ln \Gamma(z)$
0.0	- 0.08537 40900 03	0.00000 00000 00	5.0	- 5.80731 52672 85	4.10609 64053 70
0.1	- 0.09169 75124 13	- 0.02865 84973 21	5.1	- 5.95057 66519 39	4.26883 00575 53
0.2	- 0.11050 89067 86	- 0.05586 39903 67	5.2	- 6.09410 47211 91	4.43349 40204 01
0.3	- 0.14135 09532 62	- 0.08025 91592 09	5.3	- 6.23788 94064 81	4.60005 23089 91
0.4	- 0.18352 07443 57	- 0.10066 05658 03	5.4	- 6.38192 11972 10	4.76847 02339 50
0.5	- 0.23614 32688 51	- 0.11610 77219 87	5.5	- 6.52619 11003 82	4.93871 43339 56
0.6	- 0.29824 98509 35	- 0.12588 00935 13	5.6	- 6.67069 06038 24	5.11075 23127 64
0.7	- 0.36884 83560 49	- 0.12948 68069 28	5.7	- 6.81541 16425 98	5.28455 29803 68
0.8	- 0.44697 73864 90	- 0.12663 80564 16	5.8	- 6.96034 65682 97	5.46008 61980 02
0.9	- 0.53174 22756 96	- 0.11720 77278 71	5.9	- 7.10548 81209 15	5.63732 28266 55
1.0	- 0.62233 46814 87	- 0.10119 48344 90	6.0	- 7.25082 94030 54	5.81623 46788 41
1.1	- 0.71803 95313 44	- 0.07868 85726 52	6.1	- 7.39636 38562 29	5.99679 44733 73
1.2	- 0.81823 34133 20	- 0.04983 92764 14	6.2	- 7.54208 52390 70	6.17897 57929 16
1.3	- 0.92237 79303 78	- 0.01483 57562 65	6.3	- 7.68798 76072 47	6.36275 30441 11
1.4	- 1.03001 06294 86	+ 0.02611 15201 47	6.4	- 7.83406 52949 57	6.54810 14200 83
1.5	- 1.14073 52341 62	0.07278 23932 61	6.5	- 7.98031 28978 26	6.73499 68651 55
1.6	- 1.25421 22047 39	0.12495 51937 38	6.6	- 8.12672 52570 99	6.92341 60416 24
1.7	- 1.37015 01536 37	0.18241 21090 01	6.7	- 8.27329 74450 10	7.11333 62984 34
1.8	- 1.48829 83245 09	0.24494 25273 48	6.8	- 8.42002 47512 17	7.30473 56416 32
1.9	- 1.60844 01578 57	0.31234 49712 35	6.9	- 8.56690 26702 20	7.49759 27064 69
2.0	- 1.73038 78680 93	0.38442 80719 73	7.0	- 8.71392 68896 74	7.69188 67310 43
2.1	- 1.85397 79144 87	0.46101 09100 87	7.1	- 8.86109 32795 24	7.88759 75313 86
2.2	- 1.97906 72374 32	0.54192 29484 31	7.2	- 9.00839 78818 89	8.08470 54778 77
2.3	- 2.10553 01371 17	0.62700 37140 16	7.3	- 9.15583 69016 37	8.28319 14729 22
2.4	- 2.23325 56848 33	0.71610 23338 39	7.4	- 9.30340 66975 98	8.48303 69297 94
2.5	- 2.36214 55727 43	0.80907 69945 69	7.5	- 9.45110 37743 60	8.68422 37525 82
2.6	- 2.49211 23232 46	0.90579 43715 71	7.6	- 9.59892 47746 01	8.88673 43171 55
2.7	- 2.62307 77928 95	1.00612 90561 43	7.7	- 9.74686 64719 23	9.09055 14530 96
2.8	- 2.75497 19177 39	1.10996 29987 33	7.8	- 9.89492 57641 38	9.29565 84265 39
2.9	- 2.88773 16568 77	1.21718 49784 62	7.9	-10.04309 96669 84	9.50203 89238 50
3.0	- 3.02130 00992 07	1.32769 01044 18	8.0	-10.19138 53082 31	9.70967 70361 08
3.1	- 3.15562 57049 65	1.44137 93510 29	8.1	-10.33977 99221 46	9.91855 72443 36
3.2	- 3.29066 16590 00	1.55815 91278 68	8.2	-10.48828 08443 04	10.12866 44054 34
3.3	- 3.42636 53170 56	1.67794 08829 56	8.3	-10.63688 55067 01	10.33998 37387 77
3.4	- 3.56269 77297 54	1.80064 07379 67	8.4	-10.78559 14331 66	10.55250 08134 40
3.5	- 3.69962 32317 85	1.92617 91533 49	8.5	-10.93439 62350 38	10.76620 15360 05
3.6	- 3.83710 90860 24	2.05448 06211 84	8.6	-11.08329 76070 93	10.98107 21389 38
3.7	- 3.97512 51741 07	2.18547 33836 08	8.7	-11.23229 33237 11	11.19709 91694 76
3.8	- 4.11364 37264 61	2.31908 91746 67	8.8	-11.38138 12352 53	11.41426 94790 19
3.9	- 4.25263 90859 57	2.45526 29835 70	8.9	-11.53055 92646 46	11.63257 02129 90
4.0	- 4.39208 75003 42	2.59393 28374 55	9.0	-11.67982 54041 57	11.85198 88011 32
4.1	- 4.53196 69393 70	2.73503 96019 03	9.1	-11.82917 77123 44	12.07251 29482 35
4.2	- 4.67225 69332 23	2.87852 67976 01	9.2	-11.97861 43111 70	12.29413 06252 48
4.3	- 4.81293 84293 30	3.02434 04316 86	9.3	-12.12813 33832 78	12.51683 00607 77
4.4	- 4.95399 36651 50	3.17242 88424 26	9.4	-12.27773 31694 04	12.74059 97329 36
4.5	- 5.09540 60548 36	3.32274 25560 43	9.5	-12.42741 19659 29	12.96542 83615 35
4.6	- 5.23716 00880 20	3.47523 41545 72	9.6	-12.57716 81225 64	13.19130 49005 92
4.7	- 5.37924 12391 93	3.62985 81537 79	9.7	-12.72700 00401 42	13.41821 85311 47
4.8	- 5.52163 58863 97	3.78657 08902 31	9.8	-12.87690 61685 35	13.64615 86543 64
4.9	- 5.66433 12381 00	3.94533 04167 32	9.9	-13.02688 50046 68	13.87511 48849 16
5.0	- 5.80731 52672 85	4.10609 64053 70	10.0	-13.17693 50906 38	14.10507 70446 23

Table 6.7

GAMMA FUNCTION FOR COMPLEX ARGUMENTS

 $x=1.3$

y	$\Re \ln \Gamma(z)$	$\Im \ln \Gamma(z)$	y	$\Re \ln \Gamma(z)$	$\Im \ln \Gamma(z)$
0.0	- 0.10817 48095 08	0.00000 00000 00	5.0	- 5.64541 41381 33	4.24823 90621 27
0.1	- 0.11383 61080 85	- 0.01671 99199 34	5.1	- 5.78673 23355 37	4.41126 31957 95
0.2	- 0.13070 20636 90	- 0.03225 84033 35	5.2	- 5.92835 35606 66	4.57620 66023 67
0.3	- 0.15843 10081 49	- 0.04549 95427 81	5.3	- 6.07026 64370 51	4.74303 39118 17
0.4	- 0.19649 12771 78	- 0.05544 82296 06	5.4	- 6.21246 02140 03	4.91171 10050 12
0.5	- 0.24420 93680 45	- 0.06126 78750 55	5.5	- 6.35492 47217 66	5.08220 49501 77
0.6	- 0.30082 34434 02	- 0.06229 79103 48	5.6	- 6.49765 03305 97	5.25448 39434 72
0.7	- 0.36553 39002 19	- 0.05805 28252 04	5.7	- 6.64062 79133 72	5.42851 72533 50
0.8	- 0.43754 53407 27	- 0.04820 73993 35	5.8	- 6.78384 88113 55	5.60427 51684 12
0.9	- 0.51609 74046 40	- 0.03257 37450 94	5.9	- 6.92730 48028 21	5.78172 89485 09
1.0	- 0.60048 45154 05	- 0.01107 52190 48	6.0	- 7.07098 80742 52	5.96085 07788 45
1.1	- 0.69006 62005 12	+ 0.01627 90894 04	6.1	- 7.21489 11938 62	6.14161 37268 52
1.2	- 0.78427 03001 02	0.04941 70710 23	6.2	- 7.35900 70872 13	6.32399 17016 49
1.3	- 0.88259 13601 03	0.08822 25250 96	6.3	- 7.50332 90147 58	6.50795 94158 99
1.4	- 0.98458 61322 90	0.13255 01649 50	6.4	- 7.64785 05510 98	6.69349 23498 81
1.5	- 1.08986 76158 16	0.18223 70479 17	6.5	- 7.79256 55658 27	6.88056 67176 38
1.6	- 1.19809 86148 04	0.23711 09920 47	6.6	- 7.93746 82058 02	7.06915 94350 45
1.7	- 1.30898 54162 82	0.29699 65855 44	6.7	- 8.08255 28787 24	7.25924 80896 76
1.8	- 1.42227 19237 14	0.36171 93463 93	6.8	- 8.22781 42379 13	7.45081 09123 38
1.9	- 1.53773 44011 63	0.43110 85022 51	6.9	- 8.37324 71681 76	7.64382 67501 64
2.0	- 1.65517 68709 10	0.50499 87656 67	7.0	- 8.51884 67726 68	7.83827 50411 67
2.1	- 1.77442 71431 91	0.58323 13926 09	7.1	- 8.66460 83606 78	8.03413 57901 50
2.2	- 1.89533 34239 28	0.66565 47394 67	7.2	- 8.81052 74362 48	8.23138 95458 91
2.3	- 2.01776 14331 34	0.75212 44759 30	7.3	- 8.95659 96875 66	8.43001 73795 19
2.4	- 2.14159 19646 87	0.84250 35670 42	7.4	- 9.10282 09770 73	8.63000 08640 04
2.5	- 2.26671 88222 04	0.93666 21049 03	7.5	- 9.24918 73322 19	8.83132 20546 97
2.6	- 2.39304 70725 18	1.03447 70464 53	7.6	- 9.39569 49368 29	9.03396 34708 43
2.7	- 2.52049 15659 37	1.13583 18965 15	7.7	- 9.54234 01230 14	9.23790 80780 23
2.8	- 2.64897 56799 18	1.24061 63628 56	7.8	- 9.68911 93636 11	9.44313 92714 58
2.9	- 2.77843 02497 03	1.34872 60013 87	7.9	- 9.83602 92650 88	9.64964 08601 22
3.0	- 2.90879 26554 06	1.46006 18633 96	8.0	- 9.98306 65608 89	9.85739 70516 25
3.1	- 3.04000 60402 26	1.57453 01525 07	8.1	-10.13022 81051 96	10.06639 24378 12
3.2	- 3.17201 86387 60	1.69204 18960 57	8.2	-10.27751 08670 60	10.27661 19810 47
3.3	- 3.30478 31979 94	1.81251 26335 69	8.3	-10.42491 19248 88	10.48804 10011 24
3.4	- 3.43825 64765 05	1.93586 21235 97	8.4	-10.57242 84612 54	10.70066 51627 91
3.5	- 3.57239 88099 07	2.06201 40693 37	8.5	-10.72005 77580 15	10.91447 04638 39
3.6	- 3.70717 37325 19	2.19089 58627 45	8.6	-10.86779 71917 09	11.12944 32237 30
3.7	- 3.84254 76469 59	2.32243 83465 44	8.7	-11.01564 42292 16	11.34557 00727 24
3.8	- 3.97848 95346 95	2.45657 55932 86	8.8	-11.16359 64236 64	11.56283 79415 00
3.9	- 4.11497 07016 98	2.59324 47004 59	8.9	-11.31165 14105 63	11.78123 40512 20
4.0	- 4.25196 45543 18	2.73238 56006 34	9.0	-11.45980 69041 59	12.00074 59040 23
4.1	- 4.38944 64012 12	2.87394 08855 80	9.1	-11.60806 06939 74	12.22136 12739 31
4.2	- 4.52739 32778 30	3.01785 56433 48	9.2	-11.75641 06415 49	12.44306 81981 38
4.3	- 4.66578 37904 84	3.16407 73073 22	9.3	-11.90485 46773 52	12.66585 49686 64
4.4	- 4.80459 79774 65	3.31255 55163 23	9.4	-12.05339 07978 49	12.88971 01243 51
4.5	- 4.94381 71850 33	3.46324 19848 78	9.5	-12.20201 70627 34	13.11462 24431 99
4.6	- 5.08342 39564 42	3.61609 03828 59	9.6	-12.35073 15923 02	13.34058 09350 03
4.7	- 5.22340 19323 94	3.77105 62237 32	9.7	-12.49953 25649 49	13.56757 48342 95
4.8	- 5.36373 57615 52	3.92809 67607 19	9.8	-12.64841 82148 10	13.79559 35935 62
4.9	- 5.50441 10199 31	4.08717 08902 55	9.9	-12.79738 68295 12	14.02462 68767 33
5.0	- 5.64541 41381 33	4.24823 90621 27	10.0	-12.94643 67480 34	14.25466 45529 28

GAMMA FUNCTION FOR COMPLEX ARGUMENTS

Table 6.7

$r=1.4$

y	$\mathcal{R} \ln \Gamma(z)$	$\mathcal{I} \ln \Gamma(z)$	y	$\mathcal{R} \ln \Gamma(z)$	$\mathcal{I} \ln \Gamma(z)$
0.0	- 0.11961 29141 72	0.00000 00000 00	5.0	- 5.48319 80511 50	4.38842 59888 87
0.1	- 0.12473 21357 76	- 0.00597 40017 43	5.1	- 5.62258 51037 75	4.55177 72808 10
0.2	- 0.14000 01552 88	- 0.01097 08056 66	5.2	- 5.76231 08530 59	4.71703 54898 14
0.3	- 0.16515 59551 89	- 0.01405 93840 03	5.3	- 5.90236 26637 68	4.88416 59286 80
0.4	- 0.19978 93616 12	- 0.01439 47989 49	5.4	- 6.04272 85898 90	5.05313 51119 86
0.5	- 0.24337 34438 09	- 0.01124 72025 18	5.5	- 6.18339 73257 62	5.22391 06968 84
0.6	- 0.29530 16779 62	- 0.00401 77865 38	5.6	- 6.32435 81614 11	5.39646 14275 35
0.7	- 0.35492 46161 10	+ 0.00775 78473 84	5.7	- 6.46560 09417 01	5.57075 70829 41
0.8	- 0.42158 20669 55	0.02441 65124 32	5.8	- 6.60711 60288 99	5.74676 84279 33
0.9	- 0.49462 85345 46	0.04618 11610 42	5.9	- 6.74889 42683 24	5.92446 71670 92
1.0	- 0.57345 12921 03	0.07317 82199 73	6.0	- 6.89092 69567 80	6.10382 59013 94
1.1	- 0.65748 16506 41	0.10545 58409 92	6.1	- 7.03320 58135 18	6.28481 80874 01
1.2	- 0.74620 06322 98	0.14300 11986 37	6.2	- 7.17572 29534 78	6.46741 79988 09
1.3	- 0.83914 04638 04	0.18575 57618 52	6.3	- 7.31847 08625 98	6.65160 06901 96
1.4	- 0.93588 32199 21	0.23362 80933 40	6.4	- 7.46144 23750 25	6.83734 19628 28
1.5	- 1.03605 77156 27	0.28650 41540 26	6.5	- 7.60463 06520 25	7.02461 83323 73
1.6	- 1.13933 54742 88	0.34425 53337 92	6.6	- 7.74802 91624 64	7.21340 69984 03
1.7	- 1.24542 63479 49	0.40674 45404 87	6.7	- 7.89163 16647 23	7.40368 58155 67
1.8	- 1.35407 41615 64	0.47383 07041 21	6.8	- 8.03543 21899 02	7.59543 32663 20
1.9	- 1.46505 26007 14	0.54537 20299 26	6.9	- 8.17942 50262 34	7.78862 84351 12
2.0	- 1.57816 14562 85	0.62122 82885 81	7.0	- 8.32360 47045 82	7.98325 09839 40
2.1	- 1.69322 32702 19	0.70126 23803 49	7.1	- 8.46796 59849 44	8.17928 11291 83
2.2	- 1.81008 03838 54	0.78534 13608 50	7.2	- 8.61250 38438 82	8.37669 96196 29
2.3	- 1.92859 23663 09	0.87333 70735 61	7.3	- 8.75721 34627 90	8.57548 77156 28
2.4	- 2.04863 37884 08	0.96512 64991 00	7.4	- 8.90209 02169 54	8.77562 71692 98
2.5	- 2.17009 23032 73	1.06059 19035 92	7.5	- 9.04712 96653 17	8.97710 02057 23
2.6	- 2.29286 69947 17	1.15962 08468 95	7.6	- 9.19232 75409 21	9.17988 95050 80
2.7	- 2.41686 69570 58	1.26210 60952 18	7.7	- 9.33767 97419 53	9.38397 81856 34
2.8	- 2.54201 00734 84	1.36794 54704 02	7.8	- 9.48318 23233 58	9.58934 97875 68
2.9	- 2.66822 19640 86	1.47704 16591 47	7.9	- 9.62883 14889 78	9.79598 82575 76
3.0	- 2.79543 50784 95	1.58930 19987 43	8.0	- 9.77462 35841 76	10.00387 79341 91
3.1	- 2.92358 79116 75	1.70463 82510 60	8.1	- 9.92055 50889 05	10.21300 35337 97
3.2	- 3.05262 43245 92	1.82296 63729 35	8.2	-10.06662 26112 05	10.42335 01372 94
3.3	- 3.18249 29542 71	1.94420 62885 89	8.3	-10.21282 28810 76	10.63490 31773 72
3.4	- 3.31314 67001 61	2.06828 16678 10	8.4	-10.35915 27447 20	10.84764 84263 58
3.5	- 3.44454 22757 38	2.19511 97123 13	8.5	-10.50560 91591 10	11.06157 19846 19
3.6	- 3.57663 98160 21	2.32465 09517 70	8.6	-10.65218 91868 81	11.27666 02694 74
3.7	- 3.70940 25331 00	2.45680 90502 77	8.7	-10.79888 99915 05	11.49290 00045 92
3.8	- 3.84279 64130 02	2.59153 06235 98	8.8	-10.94570 88327 39	11.71027 82098 57
3.9	- 3.97678 99482 49	2.72875 50671 88	8.9	-11.09264 30623 27	11.92878 21916 70
4.0	- 4.11135 39012 79	2.86842 43947 56	9.0	-11.23969 01199 39	12.14839 95336 59
4.1	- 4.24646 10946 69	3.01048 30870 18	9.1	-11.38684 75293 27	12.36911 80877 89
4.2	- 4.38208 62246 51	3.15487 79501 77	9.2	-11.53411 28946 97	12.59092 59658 40
4.3	- 4.51820 56949 47	3.30155 79836 24	9.3	-11.68148 38972 65	12.81381 15312 39
4.4	- 4.65479 74683 75	3.45047 42563 18	9.4	-11.82895 82920 01	13.03776 33912 29
4.5	- 4.79184 09340 18	3.60157 97913 33	9.5	-11.97653 39045 38	13.26277 03893 53
4.6	- 4.92931 67880 70	3.75482 94580 13	9.6	-12.12420 86282 47	13.48882 15982 45
4.7	- 5.06720 69267 30	3.91017 98712 52	9.7	-12.27198 04214 52	13.71590 63127 03
4.8	- 5.20549 43497 23	4.06758 92973 81	9.8	-12.41984 73048 02	13.94401 40430 46
4.9	- 5.34416 30732 30	4.22701 75662 27	9.9	-12.56780 73587 55	14.17313 45087 16
5.0	- 5.48319 80511 50	4.38842 59888 87	10.0	-12.71585 87212 03	14.40325 76321 42

Table 6.7

GAMMA FUNCTION FOR COMPLEX ARGUMENTS

 $r=1.5$

y	$\mathcal{R} \ln \Gamma(z)$	$\mathcal{I} \ln \Gamma(z)$	y	$\mathcal{R} \ln \Gamma(z)$	$\mathcal{I} \ln \Gamma(z)$
0.0	- 0.12078 22376 35	0.00000 00000 00	5.0	- 5.32063 00229 09	4.52667 02683 19
0.1	- 0.12545 03928 11	0.00378 68415 10	5.1	- 5.45809 92990 12	4.69038 46594 51
0.2	- 0.13938 53175 79	0.00839 39012 17	5.2	- 5.59594 21987 69	4.85599 23475 89
0.3	- 0.16238 37050 76	0.01460 80536 11	5.3	- 5.73414 48816 77	5.02345 93914 30
0.4	- 0.19412 35254 45	0.02315 34211 15	5.4	- 5.87269 42552 05	5.19275 29984 42
0.5	- 0.23418 63474 70	0.03466 89612 75	5.5	- 6.01157 79223 61	5.36384 14702 24
0.6	- 0.28208 36136 63	0.04969 46638 36	5.6	- 6.15078 41337 33	5.53669 41510 65
0.7	- 0.33728 34790 33	0.06866 64150 66	5.7	- 6.29030 17435 55	5.71128 13794 95
0.8	- 0.39923 54301 20	0.09191 83319 43	5.8	- 6.43012 01693 96	5.88757 44426 18
0.9	- 0.46739 08704 08	0.11969 06415 60	5.9	- 6.57022 93551 39	6.06554 55330 63
1.0	- 0.54121 88685 47	0.15214 09934 52	6.0	- 6.71061 97369 14	6.24516 77083 65
1.1	- 0.62021 70896 71	0.18935 73091 01	6.1	- 6.85128 22117 36	6.42641 48526 40
1.2	- 0.70391 84698 97	0.23137 07067 73	6.2	- 6.99220 81085 67	6.60926 16403 83
1.3	- 0.79189 44573 28	0.27816 75270 32	6.3	- 7.13338 91616 09	6.79368 35022 65
1.4	- 0.88375 56946 74	0.32969 99180 52	6.4	- 7.27481 74856 07	6.97965 65928 01
1.5	- 0.97915 09391 81	0.38589 47712 67	6.5	- 7.41648 55529 97	7.16715 77597 60
1.6	- 1.07776 48736 47	0.44666 10201 49	6.6	- 7.55838 61727 29	7.35616 45152 22
1.7	- 1.17931 53061 81	0.51189 54441 75	6.7	- 7.70051 24706 26	7.54665 50081 65
1.8	- 1.28355 01134 19	0.58148 71805 09	6.8	- 7.84285 78711 49	7.73860 79984 87
1.9	- 1.39024 41643 92	0.65532 11610 93	6.9	- 7.98541 60804 40	7.93200 28323 86
2.0	- 1.49919 63725 85	0.73328 06816 91	7.0	- 8.12818 10705 51	8.12681 94190 02
2.1	- 1.61022 69592 23	0.81524 92850 60	7.1	- 8.27114 70647 52	8.32303 82082 45
2.2	- 1.72317 49667 28	0.90111 21116 92	7.2	- 8.41430 85238 40	8.52064 01697 48
2.3	- 1.83789 60327 96	0.99075 68430 94	7.3	- 8.55766 01333 52	8.71960 67728 67
2.4	- 1.95426 04180 71	1.08407 43370 92	7.4	- 8.70119 67916 34	8.91991 99676 60
2.5	- 2.07215 12706 83	1.18095 90329 08	7.5	- 8.84491 35986 81	9.12156 21668 12
2.6	- 2.19146 31061 38	1.28130 91860 05	7.6	- 8.98880 58456 98	9.32451 62284 17
2.7	- 2.31210 04795 77	1.38502 69784 97	7.7	- 9.13286 90053 22	9.52876 54395 97
2.8	- 2.43397 68277 27	1.49201 85397 98	7.8	- 9.27709 87224 65	9.73429 35008 92
2.9	- 2.55701 34593 17	1.60219 39035 70	7.9	- 9.42149 08057 13	9.94108 45113 82
3.0	- 2.68113 86746 74	1.71546 69204 67	8.0	- 9.56604 12192 67	10.14912 29545 01
3.1	- 2.80628 69972 89	1.83175 51411 18	8.1	- 9.71074 60753 60	10.35839 36845 06
3.2	- 2.93239 85022 62	1.95097 96800 61	8.2	- 9.85560 16271 36	10.56888 19135 53
3.3	- 3.05941 82284 63	2.07306 50684 28	8.3	-10.00060 42619 46	10.78057 31993 69
3.4	- 3.18729 56630 57	2.19793 91011 06	8.4	-10.14575 04950 41	10.99345 34334 60
3.5	- 3.31598 42885 64	2.32553 26824 38	8.5	-10.29103 69636 22	11.20750 88298 51
3.6	- 3.44544 11840 65	2.45577 96733 92	8.6	-10.43646 04212 40	11.42272 59143 12
3.7	- 3.57562 66733 10	2.58861 67421 82	8.7	-10.58201 77325 09	11.63909 15140 53
3.8	- 3.70650 40135 44	2.72398 32197 35	8.8	-10.72770 58681 09	11.85659 27478 60
3.9	- 3.83803 91197 27	2.86182 09608 36	8.9	-10.87352 19000 77	12.07521 70166 56
4.0	- 3.97020 03195 93	3.00207 42115 08	9.0	-11.01946 29973 44	12.29495 19944 46
4.1	- 4.10295 81356 26	3.14468 94828 47	9.1	-11.16552 64215 28	12.51578 56196 58
4.2	- 4.23628 50905 75	3.28961 54314 23	9.2	-11.31170 95229 33	12.73770 60868 20
4.3	- 4.37015 55336 09	3.43680 27461 51	9.3	-11.45800 97367 84	12.96070 18385 99
4.4	- 4.50454 54845 89	3.58620 40415 07	9.4	-11.60442 45796 38	13.18476 15581 47
4.5	- 4.63943 24943 00	3.73777 37568 62	9.5	-11.75095 16459 94	13.40987 41617 61
4.6	- 4.77479 55187 51	3.89146 80616 79	9.6	-11.89758 86050 76	13.63602 87918 31
4.7	- 4.91061 48059 11	4.04724 47663 05	9.7	-12.04433 31977 78	13.86321 48100 75
4.8	- 5.04687 17934 63	4.20506 32380 55	9.8	-12.19118 32337 59	14.09142 17910 27
4.9	- 5.18354 90163 32	4.36488 43223 09	9.9	-12.33813 65886 95	14.32063 95157 82
5.0	- 5.32063 00229 09	4.52667 02683 19	10.0	-12.48519 12016 51	14.55085 79659 84

GAMMA FUNCTION FOR COMPLEX ARGUMENTS

Table 6.7

$x=1.6$					
y	$\Re \ln \Gamma(z)$	$\Im \ln \Gamma(z)$	y	$\Re \ln \Gamma(z)$	$\Im \ln \Gamma(z)$
0.0	- 0.11259 17656 97	0.00000 00000 00	5.0	- 5.15767 38696 89	4.66298 63139 40
0.1	- 0.11687 93076 07	0.01272 17953 11	5.1	- 5.29324 00046 70	4.82709 89421 23
0.2	- 0.12968 70233 13	0.02614 08547 67	5.2	- 5.42921 38858 50	4.99309 00410 26
0.3	- 0.15085 38452 14	0.04092 98346 69	5.3	- 5.56558 05247 67	5.16092 64732 77
0.4	- 0.18012 29875 82	0.05771 47266 93	5.4	- 5.70232 57347 10	5.33057 61938 29
0.5	- 0.21715 76591 72	0.07705 74009 90	5.5	- 5.83943 60752 49	5.50200 82001 33
0.6	- 0.26155 99560 50	0.09944 39491 75	5.6	- 5.97689 88014 04	5.67519 24850 30
0.7	- 0.31289 07142 69	0.12527 90746 90	5.7	- 6.11470 18170 24	5.85009 99922 08
0.8	- 0.37068 83847 40	0.15488 59553 99	5.8	- 6.25283 36319 59	6.02670 25740 71
0.9	- 0.43448 55339 80	0.18851 04588 87	5.9	- 6.39128 33226 66	6.20497 29518 79
1.0	- 0.50382 21960 58	0.22632 83631 44	6.0	- 6.53004 04959 33	6.38488 46780 37
1.1	- 0.57825 58588 66	0.26845 42738 89	6.1	- 6.66909 52554 28	6.56641 21003 90
1.2	- 0.65736 82809 44	0.31495 11405 00	6.2	- 6.80843 81708 20	6.74953 03284 11
1.3	- 0.74076 95833 61	0.36583 95580 78	6.3	- 6.94806 02492 33	6.93421 52011 79
1.4	- 0.82810 01661 20	0.42110 63293 75	6.4	- 7.08795 29088 41	7.12044 32570 25
1.5	- 0.91903 10002 05	0.48071 20031 31	6.5	- 7.22810 79544 00	7.30819 17047 52
1.6	- 1.01326 27864 52	0.54459 72874 22	6.6	- 7.36851 75545 64	7.49743 83963 44
1.7	- 1.11052 43845 66	0.61268 83586 73	6.7	- 7.50917 42208 19	7.68816 18010 67
1.8	- 1.21057 08228 70	0.68490 11588 51	6.8	- 7.65007 07879 17	7.88034 09808 64
1.9	- 1.31318 11150 50	0.76114 48080 60	6.9	- 7.79120 03956 68	8.07395 55670 43
2.0	- 1.41815 60399 85	0.84132 42695 09	7.0	- 7.93255 64719 90	8.26898 57380 27
2.1	- 1.52531 59861 47	0.92534 23984 61	7.1	- 8.07413 27171 08	8.46541 21983 05
2.2	- 1.63449 89215 98	1.01310 14934 56	7.2	- 8.21592 30888 20	8.66321 61583 45
2.3	- 1.74555 85219 99	1.10450 44515 88	7.3	- 8.35792 17887 32	8.86237 93155 10
2.4	- 1.85836 24696 22	1.19945 56127 07	7.4	- 8.50012 32493 99	9.06288 38358 78
2.5	- 1.97279 09238 15	1.29786 13618 36	7.5	- 8.64252 21222 97	9.26471 23369 30
2.6	- 2.08873 51557 24	1.39963 05453 39	7.6	- 8.78511 32665 62	9.46784 78710 61
2.7	- 2.20609 63358 10	1.50467 47448 81	7.7	- 8.92789 17384 38	9.67227 39098 48
2.8	- 2.32478 44606 95	1.61290 84436 93	7.8	- 9.07085 27813 87	9.87797 43290 61
2.9	- 2.44471 74052 94	1.72424 91120 48	7.9	- 9.21399 18168 02	10.08493 33943 44
3.0	- 2.56582 00865 46	1.83861 72327 21	8.0	- 9.35730 44352 92	10.29313 57475 61
3.1	- 2.68802 37258 40	1.95593 62824 65	8.1	- 9.50078 63884 89	10.50256 63937 51
3.2	- 2.81126 51983 53	2.07613 26817 55	8.2	- 9.64443 35813 39	10.71321 06886 60
3.3	- 2.93548 64586 59	2.19913 57221 55	8.3	- 9.78824 20648 48	10.92505 43268 31
3.4	- 3.06063 40331 69	2.32487 74784 17	8.4	- 9.93220 80292 58	11.13808 33302 08
3.5	- 3.18665 85710 48	2.45329 27106 82	8.5	-10.07632 77975 98	11.35228 40372 42
3.6	- 3.31351 44463 00	2.58431 87608 00	8.6	-10.22059 78196 20	11.56764 30924 55
3.7	- 3.44115 94046 31	2.71789 54457 96	8.7	-10.36501 46660 67	11.78414 74364 58
3.8	- 3.56955 42495 22	2.85396 49506 80	8.8	-10.50957 50232 55	12.00178 42963 80
3.9	- 3.69866 25626 62	2.99247 17222 46	8.9	-10.65427 56879 66	12.22054 11767 06
4.0	- 3.82845 04545 47	3.13336 23649 89	9.0	-10.79911 35626 11	12.44040 58504 89
4.1	- 3.95888 63415 67	3.27658 55399 89	9.1	-10.94408 56506 53	12.66136 63509 22
4.2	- 4.08994 07464 23	3.42209 18672 73	9.2	-11.08918 90522 76	12.88341 09632 56
4.3	- 4.22158 61190 90	3.56983 38320 36	9.3	-11.23442 09602 86	13.10652 82170 40
4.4	- 4.35379 66759 32	3.71976 56948 92	9.4	-11.37977 86562 21	13.33070 68786 75
4.5	- 4.48654 82548 65	3.87184 34062 62	9.5	-11.52525 95066 64	13.55593 59442 57
4.6	- 4.61981 81847 38	4.02602 45248 92	9.6	-11.67086 09597 45	13.78220 46327 06
4.7	- 4.75358 51673 33	4.18226 81404 46	9.7	-11.81658 05418 21	14.00950 23791 60
4.8	- 4.88782 91705 81	4.34053 48000 81	9.8	-11.96241 58543 24	14.23781 88286 23
4.9	- 5.02253 13317 74	4.50078 64388 72	9.9	-12.10836 45707 60	14.46714 38298 57
5.0	- 5.15767 38696 89	4.66298 63139 40	10.0	-12.25442 44338 60	14.69746 74295 03

Table 6.7

GAMMA FUNCTION FOR COMPLEX ARGUMENTS

$x=1.7$					
y	$\Re \ln \Gamma(z)$	$\Im \ln \Gamma(z)$	y	$\Re \ln \Gamma(z)$	$\Im \ln \Gamma(z)$
0.0	- 0.09580 76974 07	0.00000 00000 00	5.0	- 4.99429 42740 24	4.79738 98064 85
0.1	- 0.09977 01624 55	0.02095 53101 47	5.1	- 5.12797 31077 01	4.96193 49448 28
0.2	- 0.11161 35203 43	0.04250 99781 99	5.2	- 5.26209 29486 79	5.12834 25830 88
0.3	- 0.13120 82417 20	0.06524 48506 20	5.3	- 5.39663 77210 79	5.29658 04404 97
0.4	- 0.15834 67099 43	0.08970 54480 34	5.4	- 5.53159 21994 12	5.46661 72692 91
0.5	- 0.19275 44989 43	0.11638 82473 83	5.5	- 5.66694 19505 53	5.63842 28098 55
0.6	- 0.23410 41754 11	0.14573 09476 06	5.6	- 5.80267 32805 14	5.81196 77481 03
0.7	- 0.28203 01468 30	0.17810 70108 82	5.7	- 5.93877 31855 28	5.98722 36749 88
0.8	- 0.33614 32007 35	0.21382 42284 85	5.8	- 6.07522 93070 61	6.16416 30480 45
0.9	- 0.39604 36829 33	0.25312 66649 29	5.9	- 6.21202 98903 76	6.34275 91548 66
1.0	- 0.46133 26441 19	0.29619 91243 57	6.0	- 6.34916 37463 25	6.52298 60784 05
1.1	- 0.53162 06562 78	0.34317 32455 42	6.1	- 6.48662 02160 75	6.70481 86640 24
1.2	- 0.60653 43029 30	0.39413 44205 39	6.2	- 6.62438 91385 04	6.88823 24881 89
1.3	- 0.68572 05552 37	0.44912 88915 80	6.3	- 6.76246 08200 42	7.07320 38287 20
1.4	- 0.76884 93610 19	0.50817 05624 82	6.4	- 6.90082 60067 27	7.25970 96365 25
1.5	- 0.85561 48134 32	0.57124 72307 84	6.5	- 7.03947 58582 98	7.44772 75087 22
1.6	- 0.94573 52538 42	0.63832 60866 03	6.6	- 7.17840 19241 47	7.63723 56630 84
1.7	- 1.03895 26210 76	0.70935 84280 02	6.7	- 7.31759 61209 77	7.82821 29137 39
1.8	- 1.13503 13039 83	0.78428 36123 89	6.8	- 7.45705 07120 18	8.02063 86480 35
1.9	- 1.23375 66975 90	0.86303 23052 04	6.9	- 7.59675 82876 82	8.21449 28045 37
2.0	- 1.33493 36116 09	0.94552 91079 51	7.0	- 7.73671 17475 34	8.40975 58520 62
2.1	- 1.43838 46369 05	1.03169 46541 37	7.1	- 7.87690 42834 81	8.60640 87697 25
2.2	- 1.54394 85411 53	1.12144 72591 94	7.2	- 8.01732 93640 69	8.80443 30279 13
2.3	- 1.65147 87389 10	1.21470 42030 73	7.3	- 8.15798 07198 22	9.00381 05701 63
2.4	- 1.76084 18623 15	1.31138 27144 41	7.4	- 8.29885 23295 23	9.20452 37958 73
2.5	- 1.87191 64452 44	1.41140 07152 26	7.5	- 8.43993 84073 80	9.40655 55438 14
2.6	- 1.98459 17246 80	1.51467 73744 45	7.6	- 8.58123 33910 02	9.60988 90763 93
2.7	- 2.09876 65571 99	1.62113 35114 76	7.7	- 8.72273 19301 22	9.81450 80646 38
2.8	- 2.21434 84448 82	1.73069 18813 34	7.8	- 8.86442 88760 30	10.02039 65738 46
2.9	- 2.33125 26629 53	1.84327 73680 71	7.9	- 9.00631 92716 38	10.22753 90498 84
3.0	- 2.44940 14805 61	1.95881 71071 34	8.0	- 9.14839 83421 51	10.43592 03060 85
3.1	- 2.56872 34658 89	2.07724 05531 98	8.1	- 9.29066 14862 98	10.64552 55107 28
3.2	- 2.68915 28670 03	2.19847 95064 74	8.2	- 9.43310 42680 75	10.85634 01750 59
3.3	- 2.81062 90603 59	2.32246 81077 41	8.3	- 9.57572 24089 73	11.06835 01418 23
3.4	- 2.93309 60594 79	2.44914 28100 87	8.4	- 9.71851 17806 54	11.28154 15743 00
3.5	- 3.05650 20770 24	2.57844 23336 16	8.5	- 9.86146 83980 47	11.49590 09457 89
3.6	- 3.18079 91341 33	2.71030 76079 67	8.6	-10.00458 84128 32	11.71141 50295 52
3.7	- 3.30594 27115 93	2.84468 17064 22	8.7	-10.14786 81072 85	11.92807 08891 58
3.8	- 3.43189 14379 84	2.98150 97744 80	8.8	-10.29130 38884 74	12.14585 58692 46
3.9	- 3.55860 68105 24	3.12073 89551 42	8.9	-10.43489 22827 58	12.36475 75866 47
4.0	- 3.68605 29448 47	3.26231 83125 99	9.0	-10.57862 99305 96	12.58476 39218 81
4.1	- 3.81419 63503 82	3.40619 87555 93	9.1	-10.72251 35816 27	12.80586 30109 93
4.2	- 3.94300 57284 13	3.55233 29614 33	9.2	-10.86654 00900 14	13.02804 32377 08
4.3	- 4.07245 17902 59	3.70067 53013 46	9.3	-11.01070 64100 32	13.25129 32259 06
4.4	- 4.20250 70933 22	3.85118 17677 02	9.4	-11.15500 95918 83	13.47560 18323 86
4.5	- 4.33314 58930 01	4.00380 99034 45	9.5	-11.29944 67777 28	13.70095 81399 16
4.6	- 4.46434 40087 52	4.15851 87339 90	9.6	-11.44401 51979 25	13.92735 14505 47
4.7	- 4.59607 87027 47	4.31526 87017 23	9.7	-11.58871 21674 47	14.15477 12791 90
4.8	- 4.72832 85697 79	4.47402 16031 94	9.8	-11.73353 50824 91	14.38320 73474 23
4.9	- 4.86107 34372 26	4.63474 05290 18	9.9	-11.87848 14172 43	14.61264 95775 51
5.0	- 4.99429 42740 24	4.79738 98064 85	10.0	-12.02354 87208 09	14.84308 80868 68

GAMMA FUNCTION FOR COMPLEX ARGUMENTS

Table 6.7

$x=1.8$

y	$\Re \ln \Gamma(z)$	$\Im \ln \Gamma(z)$	y	$\Re \ln \Gamma(z)$	$\Im \ln \Gamma(z)$
0.0	- 0.07108 38729 14	0.00000 00000 00	5.0	- 4.83045 68451 13	4.92989 76263 84
0.1	- 0.07476 57386 86	0.02858 63331 36	5.1	- 4.96226 53555 54	5.09490 86275 80
0.2	- 0.08577 55297 09	0.05769 29209 31	5.2	- 5.09454 72216 70	5.26176 50781 04
0.3	- 0.10400 76857 32	0.08782 58538 91	5.3	- 5.22728 53433 89	5.43043 56009 62
0.4	- 0.12929 22486 30	0.11946 40495 57	5.4	- 5.36046 35143 73	5.60088 97905 12
0.5	- 0.16140 31015 52	0.15304 83729 82	5.5	- 5.49406 63619 68	5.77309 81726 78
0.6	- 0.20006 82029 53	0.18897 35429 70	5.6	- 5.62807 92920 13	5.94703 21669 16
0.7	- 0.24498 08149 51	0.22758 31014 17	5.7	- 5.76248 84380 56	6.12266 40498 86
0.8	- 0.29581 07721 71	0.26916 73612 58	5.8	- 5.89728 06145 63	6.29996 69207 68
0.9	- 0.35221 50054 25	0.31396 39650 50	5.9	- 6.03244 32737 64	6.47891 46681 58
1.0	- 0.41384 67690 74	0.36216 05120 09	6.0	- 6.16796 44658 02	6.65948 19384 99
1.1	- 0.48036 32669 52	0.41389 86472 00	6.1	- 6.30383 28019 05	6.84164 41059 65
1.2	- 0.55143 15880 74	0.46927 90315 88	6.2	- 6.44003 74202 92	7.02537 72437 42
1.3	- 0.62673 30272 43	0.52836 66950 54	6.3	- 6.57656 79546 04	7.21065 80966 53
1.4	- 0.70596 59713 03	0.59119 63857 23	6.4	- 6.71341 45046 23	7.39746 40550 43
1.5	- 0.78884 75850 80	0.65777 76436 65	6.5	- 6.85056 76090 92	7.58577 31298 85
1.6	- 0.87511 45440 57	0.72809 94297 11	6.6	- 6.98801 82204 65	7.77556 39290 39
1.7	- 0.96452 30468 26	0.80213 42229 48	6.7	- 7.12575 76814 17	7.96681 56346 11
1.8	- 1.05684 83111 80	0.87984 15616 08	6.8	- 7.26377 77029 87	8.15950 79813 46
1.9	- 1.15188 37223 02	0.96117 10434 30	6.9	- 7.40207 03441 98	8.35362 12360 30
2.0	- 1.24943 97659 29	1.04606 48267 65	7.0	- 7.54062 79930 63	8.54913 61778 15
2.1	- 1.34934 28469 99	1.13445 96865 98	7.1	- 7.67944 33488 49	8.74603 40794 54
2.2	- 1.45143 40669 35	1.22628 86841 72	7.2	- 7.81850 94055 06	8.94429 66893 74
2.3	- 1.55556 80105 11	1.32148 25078 65	7.3	- 7.95781 94361 78	9.14390 62145 64
2.4	- 1.66161 15761 22	1.41997 05387 49	7.4	- 8.09736 69787 03	9.34484 53042 25
2.5	- 1.76944 28703 84	1.52168 16884 90	7.5	- 8.23714 58220 35	9.54709 70341 42
2.6	- 1.87895 01786 38	1.62654 50508 69	7.6	- 8.37714 99935 16	9.75064 48917 54
2.7	- 1.99003 10163 61	1.73449 04020 35	7.7	- 8.51737 37469 39	9.95547 27618 74
2.8	- 2.10259 12619 95	1.84544 85788 28	7.8	- 8.65781 15513 42	10.16156 49130 30
2.9	- 2.21654 43688 12	1.95935 17594 45	7.9	- 8.79845 80804 75	10.36890 59844 02
3.0	- 2.33181 06516 27	2.07613 36663 29	8.0	- 8.93930 82029 08	10.57748 09733 12
3.1	- 2.44831 66432 13	2.19572 97074 49	8.1	- 9.08035 69727 14	10.78727 52232 56
3.2	- 2.56599 45147 78	2.31807 70690 52	8.2	- 9.22159 96207 08	10.99827 44124 32
3.3	- 2.68478 15548 41	2.44311 47704 17	8.3	- 9.36303 15461 81	11.21046 45427 62
3.4	- 2.80461 97009 53	2.57078 36890 62	8.4	- 9.50464 83091 20	11.42383 19293 59
3.5	- 2.92545 51190 19	2.70102 65631 50	8.5	- 9.64644 56228 63	11.63836 31904 38
3.6	- 3.04723 78253 42	2.83378 79764 90	8.6	- 9.78841 93471 63	11.85404 52376 37
3.7	- 3.16992 13469 31	2.96901 43304 05	8.7	- 9.93056 54816 43	12.07086 52667 34
3.8	- 3.29346 24159 89	3.10665 38058 79	8.8	-10.07288 01596 06	12.28881 07487 37
3.9	- 3.41782 06949 39	3.24665 63186 51	8.9	-10.21535 96421 85	12.50786 94213 31
4.0	- 3.54295 85286 89	3.38897 34693 93	9.0	-10.35800 03128 01	12.72802 92806 69
4.1	- 3.66884 07212 13	3.53355 84906 21	9.1	-10.50079 86719 24	12.94927 85734 79
4.2	- 3.79543 43338 26	3.68036 61916 47	9.2	-10.64375 13321 05	13.17160 57894 90
4.3	- 3.92270 85028 21	3.82935 29025 75	9.3	-10.78685 50132 67	13.39499 96541 43
4.4	- 4.05063 42744 24	3.98047 64181 31	9.4	-10.93010 65382 43	13.61944 91215 87
4.5	- 4.17918 44552 05	4.13369 59419 14	9.5	-11.07350 28285 39	13.84494 33679 42
4.6	- 4.30833 34763 48	4.28897 20315 17	9.6	-11.21704 09003 12	14.07147 17848 17
4.7	- 4.43805 72703 06	4.44626 65448 66	9.7	-11.36071 78605 47	14.29902 39730 75
4.8	- 4.56833 31585 96	4.60554 25879 92	9.8	-11.50453 09034 33	14.52758 97368 21
4.9	- 4.69913 97495 61	4.76676 44644 38	9.9	-11.64847 73069 06	14.75715 90776 29
5.0	- 4.83045 68451 13	4.92989 76263 84	10.0	-11.79255 44293 69	14.98772 21889 61

Table 6.7 GAMMA FUNCTION FOR COMPLEX ARGUMENTS

$r=1.9$					
y	$\Re \ln \Gamma(z)$	$\Im \ln \Gamma(z)$	y	$\Re \ln \Gamma(z)$	$\Im \ln \Gamma(z)$
0.0	- 0.03898 42759 23	0.00000 00000 00	5.0	- 4.66612 81728 77	5.06052 77830 38
0.1	- 0.04242 16648 18	0.03569 47077 36	5.1	- 4.79608 44074 24	5.22603 70297 75
0.2	- 0.05270 43596 13	0.07184 49288 73	5.2	- 4.92654 53878 64	5.39337 36626 27
0.3	- 0.06974 53071 16	0.10889 51730 33	5.3	- 5.05749 30552 47	5.56250 72499 47
0.4	- 0.09340 38158 25	0.14726 87453 39	5.4	- 5.18891 02823 51	5.73340 82679 93
0.5	- 0.12349 16727 26	0.18735 90383 60	5.5	- 5.32078 08121 05	5.90604 80662 49
0.6	- 0.15978 08372 30	0.22952 28050 02	5.6	- 5.45308 92008 98	6.08039 88340 38
0.7	- 0.20201 20244 82	0.27407 56544 06	5.7	- 5.58582 07663 21	6.25643 35684 02
0.8	- 0.24990 35004 09	0.32128 97690 64	5.8	- 5.71896 15389 41	6.43412 60432 49
0.9	- 0.30315 95035 34	0.37139 36389 55	5.9	- 5.85249 82177 50	6.61345 07797 49
1.0	- 0.36147 78527 10	0.42457 34706 81	6.0	- 5.98641 81289 78	6.79438 30179 35
1.1	- 0.42455 64621 11	0.48097 58618 37	6.1	- 6.12070 91879 56	6.97689 86894 96
1.2	- 0.49209 86372 39	0.54071 13247 70	6.2	- 6.25535 98637 85	7.16097 43917 16
1.3	- 0.56381 71504 20	0.60385 82827 52	6.3	- 6.39035 91465 66	7.34658 73625 14
1.4	- 0.63943 71834 98	0.67046 72268 81	6.4	- 6.52569 65169 71	7.53371 54565 59
1.5	- 0.71869 82795 42	0.74056 47971 47	6.5	- 6.66136 19179 75	7.72233 71224 13
1.6	- 0.80135 54698 30	0.81415 76239 52	6.6	- 6.79734 57285 54	7.91243 13806 57
1.7	- 0.88717 97447 03	0.89123 58296 55	6.7	- 6.93363 87392 01	8.10397 78029 64
1.8	- 0.97595 80247 42	0.97177 61401 47	6.8	- 7.07023 21291 12	8.29695 64920 80
1.9	- 1.06749 27687 53	1.05574 45936 43	6.9	- 7.20711 74449 04	8.49134 80626 65
2.0	- 1.16160 13318 68	1.14309 88592 34	7.0	- 7.34428 65807 56	8.68713 36229 72
2.1	- 1.25811 51641 83	1.23379 01934 57	7.1	- 7.48173 17598 49	8.88429 47573 07
2.2	- 1.35687 89195 14	1.32776 50714 39	7.2	- 7.61944 55170 18	9.08281 35092 45
2.3	- 1.45774 95259 72	1.42496 65323 75	7.3	- 7.75742 06825 11	9.28267 23655 74
2.4	- 1.56059 52554 63	1.52533 52787 28	7.4	- 7.89565 03667 87	9.48385 42409 11
2.5	- 1.66529 48176 11	1.62881 05662 06	7.5	- 8.03412 79462 62	9.68634 24629 88
2.6	- 1.77173 64947 51	1.73533 09179 80	7.6	- 8.17284 70499 43	9.89012 07585 45
2.7	- 1.87981 73280 00	1.84483 46926 69	7.7	- 8.31180 15468 79	10.09517 32398 33
2.8	- 1.98944 23595 80	1.95726 05315 67	7.8	- 8.45098 55343 75	10.30148 43916 76
2.9	- 2.10052 39332 16	2.07254 77068 08	7.9	- 8.59039 33269 14	10.50903 90590 64
3.0	- 2.21298 10520 42	2.19063 63887 13	8.0	- 8.73001 94457 32	10.71782 24352 78
3.1	- 2.32673 87919 77	2.31146 78475 36	8.1	- 8.86985 86090 10	10.92782 00504 91
3.2	- 2.44172 77675 72	2.43498 46022 00	8.2	- 9.00990 57226 31	11.13901 77608 39
3.3	- 2.55788 36468 15	2.56113 05263 98	8.3	- 9.15015 58714 69	11.35140 17379 39
3.4	- 2.67514 67111 48	2.68985 09205 60	8.4	- 9.29060 43111 75	11.56495 84588 29
3.5	- 2.79346 14569 24	2.82109 25566 19	8.5	- 9.43124 64604 23	11.77967 46963 13
3.6	- 2.91277 62346 38	2.95480 37012 40	8.6	- 9.57207 78935 85	11.99553 75096 87
3.7	- 3.03304 29224 14	3.09093 41220 91	8.7	- 9.71309 43338 13	12.21253 42358 42
3.8	- 3.15421 66305 10	3.22943 50808 91	8.8	- 9.85429 16464 97	12.43065 24807 06
3.9	- 3.27625 54337 96	3.37025 93162 16	8.9	- 9.99566 58330 75	12.64988 01110 27
4.0	- 3.39912 01294 42	3.51336 10185 24	9.0	-10.13721 30251 72	12.87020 52464 75
4.1	- 3.52277 40173 08	3.65869 57993 21	9.1	-10.27892 94790 52	13.09161 62520 42
4.2	- 3.64718 27007 49	3.80622 06560 50	9.2	-10.42081 15703 58	13.31410 17307 41
4.3	- 3.77231 39057 84	3.95589 39339 63	9.3	-10.56285 57891 26	13.53765 05165 78
4.4	- 3.89813 73167 71	4.10767 52859 66	9.4	-10.70505 87350 54	13.76225 16677 85
4.5	- 4.02462 44269 53	4.26152 56312 41	9.5	-10.84741 71130 08	13.98789 44603 16
4.6	- 4.15174 84023 59	4.41740 71132 72	9.6	-10.98992 77287 64	14.21456 83815 73
4.7	- 4.27948 39577 56	4.57528 30577 67	9.7	-11.13258 74849 48	14.44226 31243 75
4.8	- 4.40780 72434 44	4.73511 79308 60	9.8	-11.27539 33771 93	14.67096 85811 36
4.9	- 4.53669 57418 38	4.89687 72979 01	9.9	-11.41834 24904 66	14.90067 48382 65
5.0	- 4.66612 81728 77	5.06052 77830 38	10.0	-11.56143 19955 88	15.13137 21707 60

GAMMA FUNCTION FOR COMPLEX ARGUMENTS

Table 6.7

$x=2.0$					
y	$\Re \ln \Gamma(z)$	$\Im \ln \Gamma(z)$	y	$\Re \ln \Gamma(z)$	$\Im \ln \Gamma(z)$
0.0	0.00000 00000 00	0.00000 00000 00	5.0	- 4.50127 58755 42	5.18929 93415 60
0.1	- 0.00322 26151 39	0.04234 57120 74	5.1	- 4.62939 88796 82	5.35533 82031 27
0.2	- 0.01286 59357 41	0.08509 33372 06	5.2	- 4.75805 70222 52	5.52318 54439 62
0.3	- 0.02885 74027 79	0.12863 61223 10	5.3	- 4.88723 13522 76	5.69281 16137 11
0.4	- 0.05107 93722 62	0.17335 05507 97	5.4	- 5.01690 38831 33	5.86418 81052 00
0.5	- 0.07937 37235 30	0.21958 93100 95	5.5	- 5.14705 75299 57	6.03728 71248 73
0.6	- 0.11354 77183 40	0.26767 56897 80	5.6	- 5.27767 60518 81	6.21208 16640 30
0.7	- 0.15338 06308 81	0.31789 96132 02	5.7	- 5.40874 39987 03	6.38854 54709 43
0.8	- 0.19863 06626 31	0.37051 53392 47	5.8	- 5.54024 66615 82	6.56665 30238 56
0.9	- 0.24904 17059 66	0.42574 07261 44	5.9	- 5.67217 00274 24	6.74637 95048 97
1.0	- 0.30434 96090 22	0.48375 78429 30	6.0	- 5.80450 07366 29	6.92770 07748 95
1.1	- 0.36428 77010 76	0.54471 46524 35	6.1	- 5.93722 60439 25	7.11059 33491 13
1.2	- 0.42859 14442 42	0.60872 74700 17	6.2	- 6.07033 37820 31	7.29503 43738 76
1.3	- 0.49700 21701 52	0.67588 39160 88	6.3	- 6.20381 23278 98	7.48100 16040 81
1.4	- 0.56926 99322 58	0.74624 61166 63	6.4	- 6.33765 05713 36	7.66847 33815 76
1.5	- 0.64515 55533 76	0.81985 39537 67	6.5	- 6.47183 78858 22	7.85742 86143 76
1.6	- 0.72443 19760 33	0.89672 82178 63	6.6	- 6.60636 41013 16	8.04784 67567 00
1.7	- 0.80688 50339 42	0.97687 35612 07	6.7	- 6.74121 94789 19	8.23970 77898 07
1.8	- 0.89231 37613 78	1.06028 11909 26	6.8	- 6.87639 46872 45	8.43299 22035 86
1.9	- 0.98053 03476 69	1.14693 12720 53	6.9	- 7.01188 07803 50	8.62768 09788 99
2.0	- 1.07135 98302 14	1.23679 50341 04	7.0	- 7.14766 91771 18	8.82375 55706 27
2.1	- 1.16463 96040 42	1.32983 65907 26	7.1	- 7.28375 16419 82	9.02119 78914 05
2.2	- 1.26021 88108 76	1.42601 44920 94	7.2	- 7.42012 02668 81	9.21999 02960 14
2.3	- 1.35795 76568 48	1.52528 30352 04	7.3	- 7.55676 74543 62	9.42011 55664 09
2.4	- 1.45772 66961 57	1.62759 33595 36	7.4	- 7.69368 59017 46	9.62155 68973 45
2.5	- 1.55940 61080 61	1.73289 43555 35	7.5	- 7.83086 85862 69	9.82429 78825 87
2.6	- 1.66288 49866 52	1.84113 34120 22	7.6	- 7.96830 87511 38	10.02832 25016 83
2.7	- 1.76806 06566 17	1.95225 70264 63	7.7	- 8.10599 98924 36	10.23361 51072 54
2.8	- 1.87483 80234 65	2.06621 12994 71	7.8	- 8.24393 57468 08	10.44016 04128 09
2.9	- 1.98312 89631 02	2.18294 23322 91	7.9	- 8.38211 02798 83	10.64794 34810 35
3.0	- 2.09285 17530 93	2.30239 65434 67	8.0	- 8.52051 76753 67	10.85694 97125 60
3.1	- 2.20393 05460 64	2.42452 09185 18	8.1	- 8.65915 23247 82	11.06716 48351 59
3.2	- 2.31629 48844 77	2.54926 32043 52	8.2	- 8.79800 88177 87	11.27857 48933 86
3.3	- 2.42987 92551 37	2.67657 20582 60	8.3	- 8.93708 19330 47	11.49116 62386 10
3.4	- 2.54462 26813 03	2.80639 71597 50	8.4	- 9.07636 66296 28	11.70492 55194 45
3.5	- 2.66046 83499 73	2.93868 92920 59	8.5	- 9.21585 80388 55	11.91983 96725 52
3.6	- 2.77736 32717 84	3.07340 03990 47	8.6	- 9.35555 14566 37	12.13589 59137 86
3.7	- 2.89525 79709 78	3.21048 36221 88	8.7	- 9.49544 23361 92	12.35308 17297 01
3.8	- 3.01410 62029 30	3.34989 33215 16	8.8	- 9.63552 62811 84	12.57138 48693 62
3.9	- 3.13386 46968 42	3.49158 50837 57	8.9	- 9.77579 90392 11	12.79079 33364 76
4.0	- 3.25449 29213 81	3.63551 57202 41	9.0	- 9.91625 64956 49	13.01129 53818 23
4.1	- 3.37595 28711 45	3.78164 32567 78	9.1	-10.05689 46678 12	13.23287 94959 63
4.2	- 3.49820 88720 59	3.92992 69172 45	9.2	-10.19770 96994 20	13.45553 44022 19
4.3	- 3.62122 74039 03	4.08032 71023 23	9.3	-10.33869 78553 49	13.67924 90499 21
4.4	- 3.74497 69383 89	4.23280 53645 81	9.4	-10.47985 55166 49	13.90401 26078 95
4.5	- 3.86942 77912 99	4.38732 43808 43	9.5	-10.62117 91758 12	14.12981 44581 93
4.6	- 3.99455 19873 65	4.54384 79226 20	9.6	-10.76266 54322 81	14.35664 41900 46
4.7	- 4.12032 31366 90	4.70234 08252 48	9.7	-10.90431 09881 75	14.58449 15940 42
4.8	- 4.24671 63216 20	4.86276 89562 20	9.8	-11.04611 26442 29	14.81334 66565 09
4.9	- 4.37370 79930 87	5.02509 91831 32	9.9	-11.18806 72959 27	15.04319 95540 92
5.0	- 4.50127 58755 42	5.18929 93415 60	10.0	-11.33017 19298 27	15.27404 06485 34

Table 6.8 DIGAMMA FUNCTION FOR COMPLEX ARGUMENTS
 $x=1.0$

y	$\Re\psi(z)$	$\Im\psi(z)$	y	$\Re\psi(z)$	$\Im\psi(z)$
0.0	-0.57721 56649	0.00000	5.0	1.61278 48446	1.47080
0.1	-0.56529 77902	0.16342	5.1	1.63245 69889	1.47276
0.2	-0.53073 04055	0.32064	5.2	1.65175 20861	1.47464
0.3	-0.47675 48934	0.46653	5.3	1.67068 42228	1.47646
0.4	-0.40786 79442	0.59770	5.4	1.68926 67162	1.47820
0.5	-0.32888 63572	0.71269	5.5	1.70751 21687	1.47989
0.6	-0.24419 65809	0.81160	5.6	1.72543 25175	1.48151
0.7	-0.15733 61258	0.89563	5.7	1.74303 90807	1.48308
0.8	-0.07088 34022	0.96655	5.8	1.76034 25988	1.48459
0.9	+0.01345 20154	1.02628	5.9	1.77735 32733	1.48605
1.0	0.09465 03206	1.07667	6.0	1.79408 08018	1.48746
1.1	0.17219 05426	1.11938	6.1	1.81053 44105	1.48883
1.2	0.24588 65515	1.15580	6.2	1.82672 28842	1.49015
1.3	0.31576 20906	1.18707	6.3	1.84265 45939	1.49143
1.4	0.38196 28134	1.21413	6.4	1.85833 75219	1.49267
1.5	0.44469 79402	1.23772	6.5	1.87377 92858	1.49387
1.6	0.50420 34618	1.25843	6.6	1.88898 71602	1.49504
1.7	0.56072 00645	1.27675	6.7	1.90396 80964	1.49617
1.8	0.61448 06554	1.29306	6.8	1.91872 87422	1.49727
1.9	0.66570 39172	1.30766	6.9	1.93327 54582	1.49833
2.0	0.71459 15154	1.32081	7.0	1.94761 43346	1.49937
2.1	0.76132 74328	1.33271	7.1	1.96175 12062	1.50037
2.2	0.80607 84807	1.34353	7.2	1.97569 16663	1.50135
2.3	0.84899 54079	1.35341	7.3	1.98944 10799	1.50230
2.4	0.89021 42662	1.36246	7.4	2.00300 45959	1.50323
2.5	0.92985 78387	1.37080	7.5	2.01638 71585	1.50413
2.6	0.96803 70243	1.37849	7.6	2.02959 35177	1.50501
2.7	1.00485 21252	1.38561	7.7	2.04262 82397	1.50586
2.8	1.04039 40175	1.39222	7.8	2.05549 57159	1.50669
2.9	1.07474 51976	1.39838	7.9	2.06820 01717	1.50751
3.0	1.10798 07107	1.40413	8.0	2.08074 56749	1.50830
3.1	1.14016 89703	1.40951	8.1	2.09313 61434	1.50907
3.2	1.17137 24783	1.41455	8.2	2.10537 53524	1.50982
3.3	1.20164 84581	1.41928	8.3	2.11746 69410	1.51056
3.4	1.23104 94107	1.42374	8.4	2.12941 44191	1.51127
3.5	1.25962 36033	1.42794	8.5	2.14122 11731	1.51197
3.6	1.28741 54995	1.43191	8.6	2.15289 04718	1.51266
3.7	1.31446 61381	1.43566	8.7	2.16442 54716	1.51332
3.8	1.34081 34679	1.43922	8.8	2.17582 92217	1.51398
3.9	1.36649 26435	1.44259	8.9	2.18710 46687	1.51462
4.0	1.39153 62879	1.44580	9.0	2.19825 46616	1.51524
4.1	1.41597 47255	1.44885	9.1	2.20928 19555	1.51585
4.2	1.43983 61892	1.45175	9.2	2.22018 92160	1.51645
4.3	1.46314 70060	1.45452	9.3	2.23097 90229	1.51703
4.4	1.48593 17620	1.45716	9.4	2.24165 38740	1.51760
4.5	1.50821 34505	1.45969	9.5	2.25221 61882	1.51816
4.6	1.53001 36052	1.46210	9.6	2.26266 83093	1.51871
4.7	1.55135 24197	1.46441	9.7	2.27301 25085	1.51925
4.8	1.57224 88550	1.46663	9.8	2.28325 09877	1.51978
4.9	1.59272 07370	1.46876	9.9	2.29338 58823	1.52029
5.0	1.61278 48446	1.47080	10.0	2.30341 92637	1.52080

$$\left[\begin{matrix} (-3) \\ 5 \end{matrix} \right] \quad \left[\begin{matrix} (-5) \\ 6 \end{matrix} \right] \quad \left[\begin{matrix} (-5) \\ 2 \end{matrix} \right]$$

$$\Re\psi(1+iy) = \frac{1}{2}\pi \coth \pi y - \frac{1}{2y}$$

$\psi(z)$ to 5D, computed by M. Goldstein, Los Alamos Scientific Laboratory.

AUXILIARY FUNCTION FOR $\Re\psi(1+iy)$

y^{-1}	$f_4(y)$	$\langle y \rangle$	y^{-1}	$f_4(y)$	$\langle y \rangle$
0.11	0.00100 956	9	0.05	0.00020 839	20
0.10	0.00083 417	10	0.04	0.00013 335	25
0.09	0.00067 555	11	0.03	0.00007 501	33
0.08	0.00053 368	13	0.02	0.00003 333	50
0.07	0.00040 853	14	0.01	0.00000 833	100
0.06	0.00030 011	17	0.00	0.00000 000	∞

$$\left[\begin{matrix} (-6) \\ 3 \end{matrix} \right] \quad \Re\psi(1+iy) = \ln y + f_4(y) \quad \left[\begin{matrix} (-6) \\ 3 \end{matrix} \right]$$

$\langle y \rangle =$ nearest integer to y .

DIGAMMA FUNCTION FOR COMPLEX ARGUMENTS

Table 6.8

$x=1.1$						$x=1.2$					
y	$\Re\psi(z)$	$\Im\psi(z)$	y	$\Re\psi(z)$	$\Im\psi(z)$	y	$\Re\psi(z)$	$\Im\psi(z)$	y	$\Re\psi(z)$	$\Im\psi(z)$
0.0	-0.42375	0.00000	5.0	1.61498	1.45097	0.0	-0.28904	0.00000	5.0	1.61756	1.43125
0.1	-0.41451	0.14258	5.1	1.63457	1.45332	0.1	-0.28169	0.12620	5.1	1.63705	1.43396
0.2	-0.38753	0.28082	5.2	1.65378	1.45557	0.2	-0.26014	0.24926	5.2	1.65617	1.43658
0.3	-0.34490	0.41099	5.3	1.67264	1.45774	0.3	-0.22578	0.36640	5.3	1.67494	1.43910
0.4	-0.28961	0.53042	5.4	1.69115	1.45983	0.4	-0.18064	0.47552	5.4	1.69336	1.44152
0.5	-0.22498	0.63764	5.5	1.70933	1.46184	0.5	-0.12710	0.57530	5.5	1.71146	1.44386
0.6	-0.15426	0.73229	5.6	1.72718	1.46378	0.6	-0.06753	0.66517	5.6	1.72924	1.44612
0.7	-0.08023	0.81484	5.7	1.74473	1.46565	0.7	-0.00412	0.74519	5.7	1.74672	1.44829
0.8	-0.00509	0.88630	5.8	1.76197	1.46746	0.8	+0.06130	0.81589	5.8	1.76390	1.45039
0.9	+0.06954	0.94792	5.9	1.77893	1.46921	0.9	0.12730	0.87806	5.9	1.78079	1.45243
1.0	0.14255	1.00102	6.0	1.79561	1.47090	1.0	0.19280	0.93260	6.0	1.79740	1.45439
1.1	0.21327	1.04687	6.1	1.81201	1.47253	1.1	0.25707	0.98046	6.1	1.81375	1.45629
1.2	0.28131	1.08660	6.2	1.82815	1.47411	1.2	0.31960	1.02252	6.2	1.82983	1.45813
1.3	0.34649	1.12119	6.3	1.84404	1.47565	1.3	0.38012	1.05960	6.3	1.84567	1.45991
1.4	0.40880	1.15146	6.4	1.85968	1.47713	1.4	0.43846	1.09240	6.4	1.86126	1.46164
1.5	0.46829	1.17810	6.5	1.87508	1.47857	1.5	0.49459	1.12153	6.5	1.87661	1.46331
1.6	0.52507	1.20169	6.6	1.89025	1.47996	1.6	0.54851	1.14752	6.6	1.89173	1.46493
1.7	0.57930	1.22269	6.7	1.90519	1.48132	1.7	0.60028	1.17082	6.7	1.90663	1.46651
1.8	0.63111	1.24148	6.8	1.91992	1.48263	1.8	0.64999	1.19179	6.8	1.92132	1.46803
1.9	0.68067	1.25839	6.9	1.93443	1.48391	1.9	0.69774	1.21074	6.9	1.93579	1.46952
2.0	0.72813	1.27368	7.0	1.94874	1.48515	2.0	0.74362	1.22794	7.0	1.95006	1.47096
2.1	0.77363	1.28755	7.1	1.96284	1.48635	2.1	0.78775	1.24362	7.1	1.96413	1.47236
2.2	0.81730	1.30021	7.2	1.97675	1.48752	2.2	0.83022	1.25796	7.2	1.97800	1.47372
2.3	0.85928	1.31179	7.3	1.99047	1.48866	2.3	0.87114	1.27112	7.3	1.99169	1.47505
2.4	0.89967	1.32243	7.4	2.00401	1.48977	2.4	0.91060	1.28323	7.4	2.00519	1.47634
2.5	0.93858	1.33224	7.5	2.01736	1.49085	2.5	0.94868	1.29442	7.5	2.01852	1.47760
2.6	0.97610	1.34131	7.6	2.03054	1.49190	2.6	0.98546	1.30478	7.6	2.03167	1.47882
2.7	1.01234	1.34972	7.7	2.04356	1.49292	2.7	1.02103	1.31441	7.7	2.04465	1.48001
2.8	1.04736	1.35753	7.8	2.05640	1.49392	2.8	1.05546	1.32337	7.8	2.05746	1.48117
2.9	1.08124	1.36482	7.9	2.06908	1.49489	2.9	1.08881	1.33173	7.9	2.07012	1.48230
3.0	1.11405	1.37162	8.0	2.08160	1.49584	3.0	1.12113	1.33955	8.0	2.08262	1.48341
3.1	1.14586	1.37800	8.1	2.09397	1.49676	3.1	1.15250	1.34688	8.1	2.09496	1.48448
3.2	1.17671	1.38398	8.2	2.10619	1.49767	3.2	1.18295	1.35377	8.2	2.10716	1.48553
3.3	1.20667	1.38960	8.3	2.11826	1.49855	3.3	1.21254	1.36024	8.3	2.11921	1.48656
3.4	1.23578	1.39489	8.4	2.13019	1.49940	3.4	1.24132	1.36635	8.4	2.13111	1.48756
3.5	1.26409	1.39989	8.5	2.14198	1.50024	3.5	1.26932	1.37211	8.5	2.14288	1.48853
3.6	1.29164	1.40461	8.6	2.15363	1.50106	3.6	1.29659	1.37756	8.6	2.15451	1.48949
3.7	1.31847	1.40907	8.7	2.16515	1.50186	3.7	1.32315	1.38272	8.7	2.16601	1.49042
3.8	1.34461	1.41331	8.8	2.17654	1.50265	3.8	1.34905	1.38761	8.8	2.17738	1.49133
3.9	1.37010	1.41732	8.9	2.18780	1.50341	3.9	1.37432	1.39226	8.9	2.18862	1.49222
4.0	1.39496	1.42114	9.0	2.19893	1.50416	4.0	1.39898	1.39667	9.0	2.19973	1.49310
4.1	1.41924	1.42478	9.1	2.20995	1.50489	4.1	1.42306	1.40088	9.1	2.21073	1.49395
4.2	1.44294	1.42824	9.2	2.22084	1.50561	4.2	1.44659	1.40489	9.2	2.22160	1.49478
4.3	1.46611	1.43154	9.3	2.23161	1.50631	4.3	1.46959	1.40871	9.3	2.23236	1.49560
4.4	1.48876	1.43469	9.4	2.24228	1.50699	4.4	1.49209	1.41236	9.4	2.24301	1.49640
4.5	1.51092	1.43771	9.5	2.25283	1.50766	4.5	1.51410	1.41586	9.5	2.25354	1.49718
4.6	1.53261	1.44059	9.6	2.26326	1.50832	4.6	1.53565	1.41920	9.6	2.26397	1.49794
4.7	1.55384	1.44335	9.7	2.27360	1.50896	4.7	1.55676	1.42240	9.7	2.27429	1.49869
4.8	1.57463	1.44600	9.8	2.28382	1.50960	4.8	1.57743	1.42547	9.8	2.28450	1.49943
4.9	1.59501	1.44854	9.9	2.29395	1.51021	4.9	1.59769	1.42842	9.9	2.29461	1.50015
5.0	1.61498	1.45097	10.0	2.30397	1.51082	5.0	1.61756	1.43125	10.0	2.30462	1.50085
	$\begin{bmatrix} (-3)2 \\ 5 \end{bmatrix}$	$\begin{bmatrix} (-3)2 \\ 5 \end{bmatrix}$		$\begin{bmatrix} (-5)5 \\ 3 \end{bmatrix}$	$\begin{bmatrix} (-5)1 \\ 2 \end{bmatrix}$		$\begin{bmatrix} (-3)1 \\ 5 \end{bmatrix}$	$\begin{bmatrix} (-3)1 \\ 5 \end{bmatrix}$		$\begin{bmatrix} (-5)5 \\ 3 \end{bmatrix}$	$\begin{bmatrix} (-5)1 \\ 2 \end{bmatrix}$

Table 6.8

DIGAMMA FUNCTION FOR COMPLEX ARGUMENTS

$x=1.3$			$x=1.4$			$x=1.3$			$x=1.4$		
y	$\Re\psi(z)$	$\Im\psi(z)$	y	$\Re\psi(z)$	$\Im\psi(z)$	y	$\Re\psi(z)$	$\Im\psi(z)$	y	$\Re\psi(z)$	$\Im\psi(z)$
0.0	-0.16919	0.00000	5.0	1.62052	1.41163	0.0	-0.06138	0.00000	5.0	1.62386	1.39213
0.1	-0.16323	0.11303	5.1	1.63990	1.41472	0.1	-0.05646	0.10223	5.1	1.64311	1.39559
0.2	-0.14567	0.22372	5.2	1.65891	1.41769	0.2	-0.04192	0.20269	5.2	1.66200	1.39891
0.3	-0.11748	0.32997	5.3	1.67758	1.42055	0.3	-0.01844	0.29974	5.3	1.68055	1.40211
0.4	-0.08009	0.43011	5.4	1.69591	1.42331	0.4	+0.01295	0.39204	5.4	1.69878	1.40519
0.5	-0.03520	0.52298	5.5	1.71392	1.42597	0.5	0.05100	0.47862	5.5	1.71668	1.40817
0.6	+0.01541	0.60796	5.6	1.73161	1.42853	0.6	0.09436	0.55886	5.6	1.73428	1.41103
0.7	0.07003	0.68491	5.7	1.74900	1.43101	0.7	0.14171	0.63250	5.7	1.75158	1.41380
0.8	0.12718	0.75404	5.8	1.76611	1.43340	0.8	0.19183	0.69957	5.8	1.76860	1.41648
0.9	0.18561	0.81582	5.9	1.78292	1.43571	0.9	0.24367	0.76033	5.9	1.78533	1.41907
1.0	0.24434	0.87085	6.0	1.79947	1.43794	1.0	0.29635	0.81517	6.0	1.80180	1.42157
1.1	0.30262	0.91983	6.1	1.81575	1.44011	1.1	0.34918	0.86457	6.1	1.81800	1.42399
1.2	0.35994	0.96341	6.2	1.83177	1.44220	1.2	0.40163	0.90903	6.2	1.83395	1.42634
1.3	0.41593	1.00227	6.3	1.84754	1.44423	1.3	0.45331	0.94907	6.3	1.84966	1.42861
1.4	0.47035	1.03698	6.4	1.86308	1.44619	1.4	0.50395	0.98517	6.4	1.86513	1.43081
1.5	0.52310	1.06809	6.5	1.87837	1.44810	1.5	0.55336	1.01778	6.5	1.88036	1.43294
1.6	0.57409	1.09605	6.6	1.89344	1.44995	1.6	0.60144	1.04730	6.6	1.89537	1.43502
1.7	0.62333	1.12126	6.7	1.90829	1.45174	1.7	0.64811	1.07409	6.7	1.91017	1.43702
1.8	0.67084	1.14409	6.8	1.92293	1.45348	1.8	0.69337	1.09849	6.8	1.92475	1.43898
1.9	0.71667	1.16483	6.9	1.93735	1.45517	1.9	0.73722	1.12075	6.9	1.93912	1.44087
2.0	0.76087	1.18373	7.0	1.95158	1.45681	2.0	0.77968	1.14113	7.0	1.95330	1.44271
2.1	0.80353	1.20102	7.1	1.96560	1.45841	2.1	0.82078	1.15984	7.1	1.96727	1.44450
2.2	0.84470	1.21688	7.2	1.97944	1.45996	2.2	0.86058	1.17707	7.2	1.98106	1.44625
2.3	0.88447	1.23148	7.3	1.99309	1.46147	2.3	0.89913	1.19296	7.3	1.99467	1.44794
2.4	0.92290	1.24495	7.4	2.00655	1.46294	2.4	0.93647	1.20768	7.4	2.00809	1.44959
2.5	0.96007	1.25743	7.5	2.01984	1.46438	2.5	0.97265	1.22133	7.5	2.02134	1.45119
2.6	0.99604	1.26900	7.6	2.03296	1.46577	2.6	1.00775	1.23402	7.6	2.03442	1.45276
2.7	1.03088	1.27976	7.7	2.04591	1.46713	2.7	1.04179	1.24585	7.7	2.04733	1.45428
2.8	1.06464	1.28980	7.8	2.05869	1.46845	2.8	1.07484	1.25689	7.8	2.06008	1.45576
2.9	1.09739	1.29918	7.9	2.07131	1.46974	2.9	1.10693	1.26723	7.9	2.07267	1.45721
3.0	1.12917	1.30797	8.0	2.08378	1.47100	3.0	1.13813	1.27693	8.0	2.08510	1.45862
3.1	1.16004	1.31621	8.1	2.09610	1.47223	3.1	1.16846	1.28604	8.1	2.09739	1.46000
3.2	1.19005	1.32396	8.2	2.10827	1.47342	3.2	1.19797	1.29461	8.2	2.10952	1.46134
3.3	1.21923	1.33126	8.3	2.12029	1.47459	3.3	1.22670	1.30269	8.3	2.12151	1.46266
3.4	1.24763	1.33814	8.4	2.13217	1.47573	3.4	1.25469	1.31032	8.4	2.13337	1.46394
3.5	1.27529	1.34464	8.5	2.14391	1.47685	3.5	1.28196	1.31753	8.5	2.14508	1.46519
3.6	1.30223	1.35080	8.6	2.15552	1.47794	3.6	1.30855	1.32436	8.6	2.15666	1.46641
3.7	1.32851	1.35663	8.7	2.16700	1.47900	3.7	1.33450	1.33084	8.7	2.16811	1.46760
3.8	1.35413	1.36216	8.8	2.17834	1.48004	3.8	1.35983	1.33699	8.8	2.17943	1.46877
3.9	1.37915	1.36742	8.9	2.18956	1.48106	3.9	1.38456	1.34283	8.9	2.19063	1.46991
4.0	1.40357	1.37242	9.0	2.20066	1.48205	4.0	1.40873	1.34840	9.0	2.20170	1.47103
4.1	1.42744	1.37718	9.1	2.21163	1.48302	4.1	1.43235	1.35370	9.1	2.21265	1.47212
4.2	1.45077	1.38172	9.2	2.22249	1.48397	4.2	1.45546	1.35876	9.2	2.22349	1.47319
4.3	1.47358	1.38606	9.3	2.23323	1.48490	4.3	1.47806	1.36359	9.3	2.23421	1.47423
4.4	1.49590	1.39020	9.4	2.24386	1.48582	4.4	1.50019	1.36821	9.4	2.24481	1.47525
4.5	1.51775	1.39416	9.5	2.25437	1.48671	4.5	1.52185	1.37263	9.5	2.25531	1.47626
4.6	1.53914	1.39795	9.6	2.26478	1.48758	4.6	1.54307	1.37686	9.6	2.26570	1.47724
4.7	1.56010	1.40158	9.7	2.27508	1.48844	4.7	1.56387	1.38092	9.7	2.27598	1.47820
4.8	1.58064	1.40507	9.8	2.28528	1.48927	4.8	1.58425	1.38481	9.8	2.28616	1.47914
4.9	1.60078	1.40841	9.9	2.29537	1.49010	4.9	1.60425	1.38854	9.9	2.29623	1.48006
5.0	1.62052	1.41163	10.0	2.30537	1.49090	5.0	1.62386	1.39213	10.0	2.30621	1.48096
	$\begin{bmatrix} (-3)2 \\ 5 \end{bmatrix}$	$\begin{bmatrix} (-3)1 \\ 5 \end{bmatrix}$		$\begin{bmatrix} (-5)5 \\ 3 \end{bmatrix}$	$\begin{bmatrix} (-5)2 \\ 3 \end{bmatrix}$		$\begin{bmatrix} (-3)1 \\ 4 \end{bmatrix}$	$\begin{bmatrix} (-4)8 \\ 4 \end{bmatrix}$		$\begin{bmatrix} (-5)5 \\ 3 \end{bmatrix}$	$\begin{bmatrix} (-5)2 \\ 3 \end{bmatrix}$

DIGAMMA FUNCTION FOR COMPLEX ARGUMENTS

Table 6.8

$x=1.5$						$x=1.6$					
y	$\Re \psi(z)$	$\Im \psi(z)$	y	$\Re \psi(z)$	$\Im \psi(z)$	y	$\Re \psi(z)$	$\Im \psi(z)$	y	$\Re \psi(z)$	$\Im \psi(z)$
0.0	0.03649	0.00000	5.0	1.62756	1.37278	0.0	0.12605	0.00000	5.0	1.63162	1.35357
0.1	0.04062	0.09325	5.1	1.64667	1.37658	0.1	0.12955	0.08566	5.1	1.65057	1.35773
0.2	0.05284	0.18511	5.2	1.66543	1.38025	0.2	0.13995	0.17023	5.2	1.66919	1.36173
0.3	0.07266	0.27432	5.3	1.68386	1.38378	0.3	0.15687	0.25268	5.3	1.68748	1.36558
0.4	0.09932	0.35978	5.4	1.70196	1.38719	0.4	0.17976	0.33214	5.4	1.70546	1.36930
0.5	0.13189	0.44066	5.5	1.71976	1.39047	0.5	0.20790	0.40789	5.5	1.72313	1.37289
0.6	0.16935	0.51640	5.6	1.73725	1.39364	0.6	0.24050	0.47942	5.6	1.74051	1.37635
0.7	0.21064	0.58668	5.7	1.75445	1.39670	0.7	0.27674	0.54642	5.7	1.75760	1.37969
0.8	0.25479	0.65144	5.8	1.77137	1.39965	0.8	0.31581	0.60875	5.8	1.77441	1.38293
0.9	0.30091	0.71078	5.9	1.78801	1.40251	0.9	0.35697	0.66642	5.9	1.79095	1.38605
1.0	0.34824	0.76494	6.0	1.80439	1.40528	1.0	0.39957	0.71957	6.0	1.80724	1.38908
1.1	0.39614	0.81424	6.1	1.82051	1.40796	1.1	0.44305	0.76840	6.1	1.82327	1.39200
1.2	0.44411	0.85907	6.2	1.83638	1.41055	1.2	0.48692	0.81319	6.2	1.83906	1.39484
1.3	0.49175	0.89980	6.3	1.85201	1.41306	1.3	0.53082	0.85423	6.3	1.85460	1.39759
1.4	0.53878	0.93684	6.4	1.86741	1.41549	1.4	0.57445	0.89183	6.4	1.86992	1.40025
1.5	0.58497	0.97054	6.5	1.88258	1.41786	1.5	0.61757	0.92629	6.5	1.88501	1.40284
1.6	0.63018	1.00127	6.6	1.89752	1.42015	1.6	0.66001	0.95790	6.6	1.89989	1.40534
1.7	0.67432	1.02932	6.7	1.91225	1.42237	1.7	0.70167	0.98693	6.7	1.91455	1.40778
1.8	0.71732	1.05500	6.8	1.92677	1.42453	1.8	0.74244	1.01363	6.8	1.92900	1.41014
1.9	0.75916	1.07855	6.9	1.94109	1.42663	1.9	0.78228	1.03824	6.9	1.94326	1.41244
2.0	0.79983	1.10020	7.0	1.95521	1.42866	2.0	0.82115	1.06096	7.0	1.95731	1.41467
2.1	0.83935	1.12015	7.1	1.96914	1.43065	2.1	0.85905	1.08197	7.1	1.97118	1.41684
2.2	0.87772	1.13857	7.2	1.98287	1.43257	2.2	0.89597	1.10144	7.2	1.98487	1.41895
2.3	0.91499	1.15563	7.3	1.99643	1.43445	2.3	0.93193	1.11953	7.3	1.99837	1.42101
2.4	0.95118	1.17146	7.4	2.00981	1.43628	2.4	0.96694	1.13635	7.4	2.01169	1.42301
2.5	0.98634	1.18618	7.5	2.02301	1.43805	2.5	1.00102	1.15204	7.5	2.02485	1.42496
2.6	1.02050	1.19990	7.6	2.03604	1.43978	2.6	1.03421	1.16668	7.6	2.03784	1.42686
2.7	1.05370	1.21271	7.7	2.04891	1.44147	2.7	1.06653	1.18039	7.7	2.05066	1.42871
2.8	1.08598	1.22469	7.8	2.06162	1.44312	2.8	1.09801	1.19324	7.8	2.06332	1.43051
2.9	1.11738	1.23592	7.9	2.07417	1.44472	2.9	1.12867	1.20530	7.9	2.07583	1.43227
3.0	1.14794	1.24647	8.0	2.08657	1.44628	3.0	1.15856	1.21664	8.0	2.08819	1.43398
3.1	1.17769	1.25639	8.1	2.09882	1.44781	3.1	1.18770	1.22733	8.1	2.10040	1.43565
3.2	1.20667	1.26574	8.2	2.11092	1.44930	3.2	1.21611	1.23741	8.2	2.11246	1.43728
3.3	1.23491	1.27457	8.3	2.12288	1.45075	3.3	1.24383	1.24693	8.3	2.12439	1.43888
3.4	1.26245	1.28290	8.4	2.13470	1.45217	3.4	1.27089	1.25594	8.4	2.13617	1.44043
3.5	1.28931	1.29080	8.5	2.14638	1.45355	3.5	1.29731	1.26448	8.5	2.14782	1.44195
3.6	1.31552	1.29828	8.6	2.15794	1.45491	3.6	1.32311	1.27257	8.6	2.15934	1.44344
3.7	1.34112	1.30537	8.7	2.16936	1.45623	3.7	1.34833	1.28026	8.7	2.17073	1.44489
3.8	1.36612	1.31212	8.8	2.18065	1.45753	3.8	1.37297	1.28757	8.8	2.18199	1.44631
3.9	1.39055	1.31853	8.9	2.19182	1.45879	3.9	1.39707	1.29454	8.9	2.19313	1.44770
4.0	1.41443	1.32464	9.0	2.20286	1.46003	4.0	1.42065	1.30117	9.0	2.20415	1.44905
4.1	1.43779	1.33047	9.1	2.21379	1.46124	4.1	1.44373	1.30750	9.1	2.21504	1.45038
4.2	1.46065	1.33603	9.2	2.22460	1.46242	4.2	1.46632	1.31354	9.2	2.22583	1.45168
4.3	1.48302	1.34134	9.3	2.23530	1.46358	4.3	1.48844	1.31932	9.3	2.23650	1.45295
4.4	1.50493	1.34642	9.4	2.24588	1.46471	4.4	1.51012	1.32485	9.4	2.24706	1.45420
4.5	1.52639	1.35128	9.5	2.25635	1.46582	4.5	1.53136	1.33014	9.5	2.25751	1.45542
4.6	1.54742	1.35594	9.6	2.26672	1.46691	4.6	1.55219	1.33522	9.6	2.26785	1.45661
4.7	1.56804	1.36041	9.7	2.27698	1.46798	4.7	1.57262	1.34009	9.7	2.27809	1.45778
4.8	1.58826	1.36470	9.8	2.28714	1.46902	4.8	1.59265	1.34476	9.8	2.28822	1.45892
4.9	1.60810	1.36882	9.9	2.29720	1.47004	4.9	1.61232	1.34925	9.9	2.29826	1.46005
5.0	1.62756	1.37278	10.0	2.30716	1.47105	5.0	1.63162	1.35357	10.0	2.30820	1.46115
	$\begin{bmatrix} (-3)1 \\ 4 \end{bmatrix}$	$\begin{bmatrix} (-4)7 \\ 4 \end{bmatrix}$		$\begin{bmatrix} (-5)4 \\ 3 \end{bmatrix}$	$\begin{bmatrix} (-5)2 \\ 3 \end{bmatrix}$		$\begin{bmatrix} (-4)9 \\ 4 \end{bmatrix}$	$\begin{bmatrix} (-4)6 \\ 4 \end{bmatrix}$		$\begin{bmatrix} (-5)4 \\ 3 \end{bmatrix}$	$\begin{bmatrix} (-5)2 \\ 3 \end{bmatrix}$

$$\Im \psi(1.5+iy) = \frac{1}{2}\pi \tanh \pi y - \frac{4y}{4y^2+1}$$

Table 6.8 DIGAMMA FUNCTION FOR COMPLEX ARGUMENTS

$x=1.7$						$x=1.8$					
y	$\Re\psi(z)$	$\Im\psi(z)$	y	$\Re\psi(z)$	$\Im\psi(z)$	y	$\Re\psi(z)$	$\Im\psi(z)$	y	$\Re\psi(z)$	$\Im\psi(z)$
0.0	0.20855	0.00000	5.0	1.63603	1.33453	0.0	0.28499	0.00000	5.0	1.64078	1.31566
0.1	0.21156	0.07918	5.1	1.65482	1.33902	0.1	0.28760	0.07358	5.1	1.65939	1.32048
0.2	0.22050	0.15747	5.2	1.67328	1.34335	0.2	0.29537	0.14644	5.2	1.67769	1.32513
0.3	0.23511	0.23407	5.3	1.69142	1.34752	0.3	0.30809	0.21792	5.3	1.69567	1.32961
0.4	0.25494	0.30824	5.4	1.70926	1.35154	0.4	0.32541	0.28740	5.4	1.71336	1.33393
0.5	0.27945	0.37937	5.5	1.72680	1.35543	0.5	0.34693	0.35437	5.5	1.73076	1.33810
0.6	0.30803	0.44701	5.6	1.74405	1.35918	0.6	0.37215	0.41842	5.6	1.74787	1.34213
0.7	0.34001	0.51086	5.7	1.76102	1.36280	0.7	0.40053	0.47928	5.7	1.76472	1.34603
0.8	0.37474	0.57074	5.8	1.77772	1.36630	0.8	0.43155	0.53675	5.8	1.78130	1.34979
0.9	0.41161	0.62661	5.9	1.79416	1.36969	0.9	0.46469	0.59076	5.9	1.79762	1.35344
1.0	0.45005	0.67852	6.0	1.81034	1.37297	1.0	0.49947	0.64131	6.0	1.81369	1.35697
1.1	0.48957	0.72661	6.1	1.82627	1.37614	1.1	0.53546	0.68847	6.1	1.82952	1.36038
1.2	0.52973	0.77107	6.2	1.84196	1.37922	1.2	0.57226	0.73237	6.2	1.84511	1.36369
1.3	0.57018	0.81211	6.3	1.85742	1.38220	1.3	0.60955	0.77316	6.3	1.86047	1.36690
1.4	0.61063	0.84996	6.4	1.87266	1.38509	1.4	0.64706	0.81103	6.4	1.87561	1.37001
1.5	0.65085	0.88488	6.5	1.88767	1.38789	1.5	0.68455	0.84617	6.5	1.89053	1.37303
1.6	0.69065	0.91710	6.6	1.90246	1.39061	1.6	0.72184	0.87877	6.6	1.90525	1.37596
1.7	0.72990	0.94685	6.7	1.91705	1.39326	1.7	0.75879	0.90903	6.7	1.91975	1.37881
1.8	0.76849	0.97436	6.8	1.93143	1.39582	1.8	0.79528	0.93713	6.8	1.93406	1.38158
1.9	0.80636	0.99982	6.9	1.94562	1.39832	1.9	0.83122	0.96326	6.9	1.94817	1.38426
2.0	0.84345	1.02342	7.0	1.95961	1.40074	2.0	0.86655	0.98757	7.0	1.96210	1.38688
2.1	0.87973	1.04533	7.1	1.97342	1.40310	2.1	0.90123	1.01022	7.1	1.97583	1.38942
2.2	0.91519	1.06570	7.2	1.98704	1.40539	2.2	0.93523	1.03136	7.2	1.98939	1.39189
2.3	0.94981	1.08468	7.3	2.00048	1.40762	2.3	0.96853	1.05110	7.3	2.00277	1.39430
2.4	0.98362	1.10238	7.4	2.01375	1.40980	2.4	1.00111	1.06957	7.4	2.01598	1.39664
2.5	1.01661	1.11893	7.5	2.02685	1.41191	2.5	1.03299	1.08687	7.5	2.02903	1.39892
2.6	1.04879	1.13441	7.6	2.03979	1.41398	2.6	1.06416	1.10310	7.6	2.04191	1.40115
2.7	1.08020	1.14893	7.7	2.05256	1.41599	2.7	1.09463	1.11836	7.7	2.05463	1.40332
2.8	1.11084	1.16257	7.8	2.06518	1.41794	2.8	1.12442	1.13270	7.8	2.06719	1.40543
2.9	1.14075	1.17539	7.9	2.07764	1.41986	2.9	1.15353	1.14622	7.9	2.07960	1.40749
3.0	1.16993	1.18747	8.0	2.08996	1.42172	3.0	1.18200	1.15898	8.0	2.09187	1.40950
3.1	1.19842	1.19886	8.1	2.10212	1.42354	3.1	1.20982	1.17103	8.1	2.10399	1.41146
3.2	1.22625	1.20962	8.2	2.11415	1.42531	3.2	1.23703	1.18243	8.2	2.11597	1.41338
3.3	1.25342	1.21981	8.3	2.12603	1.42704	3.3	1.26363	1.19322	8.3	2.12781	1.41525
3.4	1.27997	1.22945	8.4	2.13778	1.42874	3.4	1.28965	1.20345	8.4	2.13952	1.41708
3.5	1.30592	1.23859	8.5	2.14939	1.43039	3.5	1.31511	1.21317	8.5	2.15109	1.41886
3.6	1.33129	1.24727	8.6	2.16087	1.43200	3.6	1.34003	1.22241	8.6	2.16253	1.42061
3.7	1.35610	1.25553	8.7	2.17222	1.43358	3.7	1.36441	1.23119	8.7	2.17385	1.42231
3.8	1.38037	1.26338	8.8	2.18345	1.43513	3.8	1.38829	1.23956	8.8	2.18504	1.42398
3.9	1.40413	1.27087	8.9	2.19456	1.43664	3.9	1.41168	1.24754	8.9	2.19611	1.42561
4.0	1.42738	1.27800	9.0	2.20555	1.43811	4.0	1.43459	1.25516	9.0	2.20707	1.42720
4.1	1.45015	1.28481	9.1	2.21642	1.43956	4.1	1.45704	1.26243	9.1	2.21790	1.42876
4.2	1.47246	1.29132	9.2	2.22717	1.44097	4.2	1.47904	1.26939	9.2	2.22862	1.43029
4.3	1.49432	1.29755	9.3	2.23781	1.44235	4.3	1.50062	1.27605	9.3	2.23923	1.43178
4.4	1.51574	1.30351	9.4	2.24834	1.44371	4.4	1.52178	1.28242	9.4	2.24974	1.43324
4.5	1.53675	1.30922	9.5	2.25877	1.44503	4.5	1.54254	1.28854	9.5	2.26013	1.43468
4.6	1.55736	1.31470	9.6	2.26908	1.44633	4.6	1.56292	1.29440	9.6	2.27042	1.43608
4.7	1.57758	1.31996	9.7	2.27930	1.44760	4.7	1.58291	1.30004	9.7	2.28061	1.43745
4.8	1.59742	1.32501	9.8	2.28941	1.44885	4.8	1.60255	1.30545	9.8	2.29069	1.43880
4.9	1.61690	1.32986	9.9	2.29942	1.45007	4.9	1.62183	1.31065	9.9	2.30068	1.44012
5.0	1.63603	1.33453	10.0	2.30933	1.45127	5.0	1.64078	1.31566	10.0	2.31057	1.44142
	$\begin{bmatrix} (-4)7 \\ 4 \end{bmatrix}$	$\begin{bmatrix} (-4)5 \\ 4 \end{bmatrix}$		$\begin{bmatrix} (-5)4 \\ 3 \end{bmatrix}$	$\begin{bmatrix} (-5)2 \\ 3 \end{bmatrix}$		$\begin{bmatrix} (-4)6 \\ 4 \end{bmatrix}$	$\begin{bmatrix} (-4)4 \\ 4 \end{bmatrix}$		$\begin{bmatrix} (-5)4 \\ 3 \end{bmatrix}$	$\begin{bmatrix} (-5)2 \\ 3 \end{bmatrix}$

*See page II.

DIGAMMA FUNCTION FOR COMPLEX ARGUMENTS

Table 6.8

x=1.9						x=2.0					
y	$\Re\psi(z)$	$\Im\psi(z)$	y	$\Re\psi(z)$	$\Im\psi(z)$	y	$\Re\psi(z)$	$\Im\psi(z)$	y	$\Re\psi(z)$	$\Im\psi(z)$
0.0	0.35618	0.00000	5.0	1.64585	1.29698	0.0	0.42278	0.00000	5.0	1.65125	1.27849
0.1	0.35847	0.06870	5.1	1.66428	1.30212	0.1	0.42480	0.06441	5.1	1.66948	1.28394
0.2	0.36528	0.13681	5.2	1.68240	1.30707	0.2	0.43081	0.12833	5.2	1.68742	1.28919
0.3	0.37644	0.20377	5.3	1.70022	1.31185	0.3	0.44068	0.19130	5.3	1.70506	1.29426
0.4	0.39169	0.26908	5.4	1.71775	1.31647	0.4	0.45420	0.25288	5.4	1.72242	1.29916
0.5	0.41071	0.33229	5.5	1.73500	1.32092	0.5	0.47111	0.31269	5.5	1.73951	1.30389
0.6	0.43309	0.39306	5.6	1.75197	1.32522	0.6	0.49110	0.37042	5.6	1.75633	1.30846
0.7	0.45842	0.45110	5.7	1.76868	1.32938	0.7	0.51380	0.42583	5.7	1.77290	1.31288
0.8	0.48625	0.50624	5.8	1.78513	1.33341	0.8	0.53887	0.47874	5.8	1.78921	1.31715
0.9	0.51614	0.55838	5.9	1.80133	1.33730	0.9	0.56594	0.52904	5.9	1.80528	1.32129
1.0	0.54770	0.60749	6.0	1.81728	1.34107	1.0	0.59465	0.57667	6.0	1.82111	1.32530
1.1	0.58053	0.65359	6.1	1.83300	1.34473	1.1	0.62468	0.62165	6.1	1.83671	1.32918
1.2	0.61431	0.69677	6.2	1.84848	1.34827	1.2	0.65572	0.66400	6.2	1.85208	1.33295
1.3	0.64872	0.73714	6.3	1.86374	1.35170	1.3	0.68751	0.70380	6.3	1.86723	1.33660
1.4	0.68351	0.77483	6.4	1.87878	1.35503	1.4	0.71980	0.74116	6.4	1.88217	1.34015
1.5	0.71846	0.80999	6.5	1.89361	1.35826	1.5	0.75239	0.77618	6.5	1.89690	1.34358
1.6	0.75338	0.84278	6.6	1.90824	1.36140	1.6	0.78510	0.80899	6.6	1.91143	1.34692
1.7	0.78814	0.87335	6.7	1.92266	1.36445	1.7	0.81779	0.83973	6.7	1.92576	1.35017
1.8	0.82261	0.90188	6.8	1.93688	1.36741	1.8	0.85033	0.86853	6.8	1.93990	1.35332
1.9	0.85669	0.92851	6.9	1.95092	1.37029	1.9	0.88262	0.89551	6.9	1.95385	1.35639
2.0	0.89031	0.95338	7.0	1.96476	1.37308	2.0	0.91459	0.92081	7.0	1.96761	1.35937
2.1	0.92342	0.97664	7.1	1.97843	1.37581	2.1	0.94617	0.94454	7.1	1.98120	1.36227
2.2	0.95598	0.99840	7.2	1.99192	1.37846	2.2	0.97731	0.96681	7.2	1.99462	1.36509
2.3	0.98795	1.01879	7.3	2.00523	1.38104	2.3	1.00798	0.98775	7.3	2.00786	1.36784
2.4	1.01932	1.03792	7.4	2.01838	1.38355	2.4	1.03814	1.00743	7.4	2.02094	1.37052
2.5	1.05008	1.05588	7.5	2.03136	1.38599	2.5	1.06779	1.02597	7.5	2.03385	1.37313
2.6	1.08022	1.07278	7.6	2.04418	1.38838	2.6	1.09690	1.04344	7.6	2.04661	1.37567
2.7	1.10975	1.08868	7.7	2.05684	1.39070	2.7	1.12548	1.05992	7.7	2.05921	1.37815
2.8	1.13867	1.10367	7.8	2.06935	1.39297	2.8	1.15352	1.07548	7.8	2.07167	1.38056
2.9	1.16698	1.11782	7.9	2.08171	1.39518	2.9	1.18102	1.09020	7.9	2.08397	1.38292
3.0	1.19470	1.13119	8.0	2.09393	1.39734	3.0	1.20798	1.10413	8.0	2.09613	1.38522
3.1	1.22184	1.14384	8.1	2.10600	1.39944	3.1	1.23442	1.11733	8.1	2.10815	1.38746
3.2	1.24841	1.15583	8.2	2.11793	1.40149	3.2	1.26034	1.12985	8.2	2.12003	1.38966
3.3	1.27442	1.16719	8.3	2.12973	1.40350	3.3	1.28575	1.14174	8.3	2.13178	1.39180
3.4	1.29990	1.17798	8.4	2.14139	1.40546	3.4	1.31067	1.15304	8.4	2.14339	1.39389
3.5	1.32485	1.18823	8.5	2.15292	1.40738	3.5	1.33510	1.16379	8.5	2.15487	1.39593
3.6	1.34929	1.19798	8.6	2.16432	1.40925	3.6	1.35905	1.17403	8.6	2.16623	1.39793
3.7	1.37324	1.20727	8.7	2.17560	1.41108	3.7	1.38254	1.18379	8.7	2.17746	1.39988
3.8	1.39670	1.21613	8.8	2.18675	1.41286	3.8	1.40558	1.19310	8.8	2.18858	1.40179
3.9	1.41970	1.22458	8.9	2.19778	1.41461	3.9	1.42818	1.20200	8.9	2.19957	1.40366
4.0	1.44226	1.23265	9.0	2.20870	1.41632	4.0	1.45036	1.21050	9.0	2.21045	1.40548
4.1	1.46437	1.24037	9.1	2.21950	1.41800	4.1	1.47212	1.21864	9.1	2.22121	1.40727
4.2	1.48606	1.24775	9.2	2.23019	1.41964	4.2	1.49348	1.22643	9.2	2.23187	1.40902
4.3	1.50734	1.25482	9.3	2.24077	1.42124	4.3	1.51446	1.23389	9.3	2.24241	1.41074
4.4	1.52822	1.26160	9.4	2.25124	1.42281	4.4	1.53505	1.24105	9.4	2.25284	1.41241
4.5	1.54872	1.26810	9.5	2.26160	1.42435	4.5	1.55527	1.24792	9.5	2.26318	1.41406
4.6	1.56885	1.27434	9.6	2.27186	1.42586	4.6	1.57514	1.25452	9.6	2.27340	1.41566
4.7	1.58861	1.28033	9.7	2.28202	1.42733	4.7	1.59466	1.26086	9.7	2.28353	1.41724
4.8	1.60803	1.28610	9.8	2.29207	1.42878	4.8	1.61385	1.26696	9.8	2.29356	1.41879
4.9	1.62710	1.29164	9.9	2.30203	1.43020	4.9	1.63270	1.27283	9.9	2.30349	1.42030
5.0	1.64585	1.29698	10.0	2.31190	1.43159	5.0	1.65125	1.27849	10.0	2.31332	1.42179
	$\left[\begin{smallmatrix} (-4)6 \\ 4 \end{smallmatrix} \right]$	$\left[\begin{smallmatrix} (-4)4 \\ 4 \end{smallmatrix} \right]$		$\left[\begin{smallmatrix} (-5)4 \\ 3 \end{smallmatrix} \right]$	$\left[\begin{smallmatrix} (-5)2 \\ 3 \end{smallmatrix} \right]$		$\left[\begin{smallmatrix} (-4)5 \\ 4 \end{smallmatrix} \right]$	$\left[\begin{smallmatrix} (-4)3 \\ 4 \end{smallmatrix} \right]$		$\left[\begin{smallmatrix} (-5)4 \\ 3 \end{smallmatrix} \right]$	$\left[\begin{smallmatrix} (-5)3 \\ 3 \end{smallmatrix} \right]$

$$\Im\psi(2+iy) = \frac{1}{2}\pi \coth \pi y - \frac{1+3y^2}{2y(1+y^2)}$$

7. Error Function and Fresnel Integrals

WALTER GAUTSCHI¹

Contents

	Page
Mathematical Properties	297
7.1. Error Function	297
7.2. Repeated Integrals of the Error Function	299
7.3. Fresnel Integrals	300
7.4. Definite and Indefinite Integrals	302
Numerical Methods	304
7.5. Use and Extension of the Tables	304
References	308
Table 7.1. Error Function and its Derivative ($0 \leq x \leq 2$)	310
$(2/\sqrt{\pi})e^{-x^2}$, $\operatorname{erf} x = (2/\sqrt{\pi}) \int_0^x e^{-t^2} dt$, $x=0(.01)2$, 10D	
Table 7.2. Derivative of the Error Function ($2 \leq x \leq 10$)	312
$(2/\sqrt{\pi})e^{-x^2}$, $x=2(.01)10$, 8S	
Table 7.3. Complementary Error Function ($2 \leq x \leq \infty$).	316
$xe^{x^2} \operatorname{erfc} x = (2/\sqrt{\pi})xe^{x^2} \int_x^\infty e^{-t^2} dt$, $x^{-2}=.25(-.005)0$, 7D	
$\operatorname{erfc} \sqrt{n\pi}$, $n=1(1)10$, 15D	
Table 7.4. Repeated Integrals of the Error Function ($0 \leq x \leq 5$)	317
$2^n \Gamma\left(\frac{n}{2}+1\right) i^n \operatorname{erfc} x = 2^{n+1} \Gamma\left(\frac{n}{2}+1\right) \sqrt{\pi} \int_x^\infty \frac{(t-x)^n}{n!} e^{-t^2} dt$	
$x=0(.1)5$, $n=1(1)6, 10, 11$, 6S	
Table 7.5. Dawson's Integral ($0 \leq x \leq \infty$)	319
$e^{-x^2} \int_0^x e^{t^2} dt$, $x=0(.02)2$, 10D	
$xe^{-x^2} \int_0^x e^{t^2} dt$, $x^{-2}=.25(-.005)0$, 9D	

¹ Guest worker, National Bureau of Standards, from The American University. (Presently Purdue University.)

	Page
Table 7.6. $(3/\Gamma(1/3)) \int_0^x e^{-t^3} dt$ ($0 \leq x \leq 2.3$)	320
$x=0(.02)1.7(.04)2.3$, 7D	
Table 7.7. Fresnel Integrals ($0 \leq x \leq 5$).	321
$C(x) = \int_0^x \cos\left(\frac{\pi}{2} t^2\right) dt$, $S(x) = \int_0^x \sin\left(\frac{\pi}{2} t^2\right) dt$, $x=0(.02)5$, 7D	
Table 7.8. Auxiliary Functions ($0 \leq x \leq \infty$)	323
$f(x) = \left[\frac{1}{2} - S(x)\right] \cos\left(\frac{\pi}{2} x^2\right) - \left[\frac{1}{2} - C(x)\right] \sin\left(\frac{\pi}{2} x^2\right)$ $g(x) = \left[\frac{1}{2} - C(x)\right] \cos\left(\frac{\pi}{2} x^2\right) + \left[\frac{1}{2} - S(x)\right] \sin\left(\frac{\pi}{2} x^2\right)$ $x=0(.02)1$, $x^{-1}=1(-.02)0$, 15D	
Table 7.9. Error Function for Complex Arguments ($0 \leq x \leq 3.9, 0 \leq y \leq 3$) .	325
$w(z) = e^{-z^2} \operatorname{erfc}(-iz)$, $z = x + iy$, $x=0(.1)3.9$, $y=0(.1)3$, 6D	
Table 7.10. Complex Zeros of the Error Function ($1 \leq n \leq 10$)	329
$z_n, \operatorname{erf} z_n = 0$, $n=1(1)10$, 8D	
Table 7.11. Complex Zeros of Fresnel Integrals ($0 \leq n \leq 5$)	329
$z_n, z_n^*, C(z_n) = 0, S(z_n^*) = 0$, $n=0(1)5$, 4D	
Table 7.12. Maxima and Minima of Fresnel Integrals ($0 \leq n \leq 5$) . . .	329
$C(\sqrt{4n+1}), C(\sqrt{4n+3}), S(\sqrt{4n+2}), S(\sqrt{4n+4})$, $n=0(1)5$, 6D	

The author acknowledges the assistance of Alfred E. Beam, Ruth E. Capuano, Lois K. Cherwinski, Elizabeth F. Godefroy, David S. Liepman, Mary Orr, Bertha H. Walter, and Ruth Zucker in the preparation and checking of the tables.

7. Error Function and Fresnel Integrals

Mathematical Properties

7.1. Error Function

Definitions

7.1.1
$$\operatorname{erf} z = \frac{2}{\sqrt{\pi}} \int_0^z e^{-t^2} dt$$

7.1.2
$$\operatorname{erfc} z = \frac{2}{\sqrt{\pi}} \int_z^\infty e^{-t^2} dt = 1 - \operatorname{erf} z$$

7.1.3
$$w(z) = e^{-z^2} \left(1 + \frac{2i}{\sqrt{\pi}} \int_0^z e^{t^2} dt \right) = e^{-z^2} \operatorname{erfc}(-iz)$$

In 7.1.2 the path of integration is subject to the restriction $\arg t \rightarrow \alpha$ with $|\alpha| < \frac{\pi}{4}$ as $t \rightarrow \infty$ along the path. ($\alpha = \frac{\pi}{4}$ is permissible if $\Re t^2$ remains bounded to the left.)

Integral Representation

7.1.4
$$w(z) = \frac{i}{\pi} \int_{-\infty}^{\infty} \frac{e^{-t^2} dt}{z-t} = \frac{2iz}{\pi} \int_0^{\infty} \frac{e^{-t^2} dt}{z^2-t^2} \quad (\Im z > 0)$$

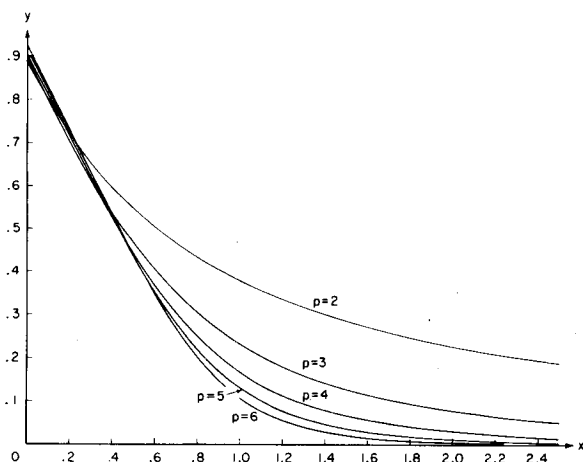

FIGURE 7.1. $y = e^{-x^p} \int_x^\infty e^{-t^p} dt$.
p=2(1)6

Series Expansions

7.1.5
$$\operatorname{erf} z = \frac{2}{\sqrt{\pi}} \sum_{n=0}^{\infty} \frac{(-1)^n z^{2n+1}}{n!(2n+1)}$$

7.1.6
$$= \frac{2}{\sqrt{\pi}} e^{-z^2} \sum_{n=0}^{\infty} \frac{2^n}{1 \cdot 3 \dots (2n+1)} z^{2n+1}$$

7.1.7
$$= \sqrt{2} \sum_{n=0}^{\infty} (-1)^n [I_{2n+1/2}(z^2) - I_{2n+3/2}(z^2)]$$

7.1.8
$$w(z) = \sum_{n=0}^{\infty} \frac{(iz)^n}{\Gamma\left(\frac{n}{2}+1\right)}$$

For $I_{n-1}(x)$, see chapter 10.

Symmetry Relations

7.1.9
$$\operatorname{erf}(-z) = -\operatorname{erf} z$$

7.1.10
$$\operatorname{erf} \bar{z} = \overline{\operatorname{erf} z}$$

7.1.11
$$w(-z) = 2e^{-z^2} - w(z)$$

7.1.12
$$w(\bar{z}) = \overline{w(-z)}$$

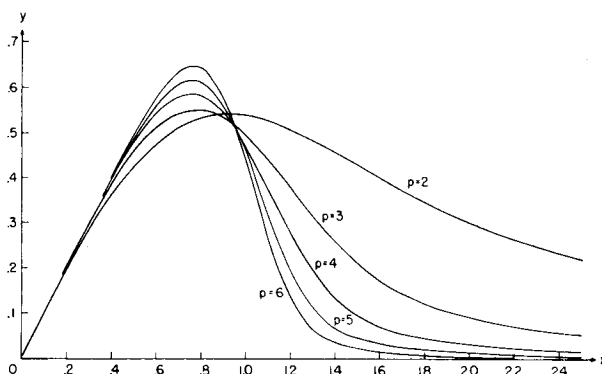

FIGURE 7.2. $y = e^{-x^p} \int_0^x e^{t^p} dt$.
p=2(1)6

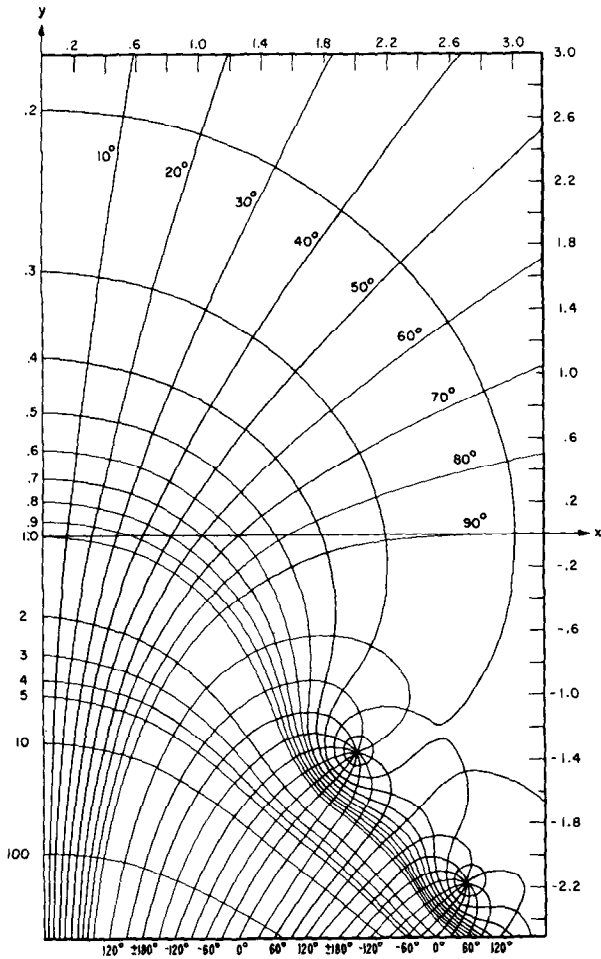

FIGURE 7.3. Altitude Chart of $w(z)$.

Inequalities [7.11], [7.17]

7.1.13

$$\frac{1}{x + \sqrt{x^2 + 2}} < e^{x^2} \int_x^\infty e^{-t^2} dt \leq \frac{1}{x + \sqrt{x^2 + \frac{4}{\pi}}} \quad (x \geq 0)$$

(For other inequalities see [7.2].)

Continued Fractions

7.1.14

$$2e^{z^2} \int_z^\infty e^{-t^2} dt = \frac{1}{z} + \frac{1/2}{z} + \frac{1}{z} + \frac{3/2}{z} + \frac{2}{z} + \dots \quad (\Re z > 0)$$

7.1.15

$$\frac{1}{\sqrt{\pi}} \int_{-\infty}^\infty \frac{e^{-t^2} dt}{z-t} = \frac{1}{z} - \frac{1/2}{z^2} + \frac{1}{z^3} - \frac{3/2}{z^4} + \frac{2}{z^5} - \dots$$

$$= \frac{1}{\sqrt{\pi}} \lim_{n \rightarrow \infty} \sum_{k=1}^n \frac{H_k^{(n)}}{z - x_k^{(n)}} \quad (\Im z \neq 0)$$

$x_k^{(n)}$ and $H_k^{(n)}$ are the zeros and weight factors of the Hermite polynomials. For numerical values see chapter 25.

Value at Infinity

7.1.16 $\operatorname{erf} z \rightarrow 1 \quad (z \rightarrow \infty \text{ in } |\arg z| < \frac{\pi}{4})$

Maximum and Inflection Points for Dawson's Integral [7.31]

$$F(x) = e^{-x^2} \int_0^x e^{t^2} dt$$

7.1.17 $F(.92413 \ 88730 \ \dots) = .54104 \ 42246 \ \dots$

7.1.18 $F(1.50197 \ 52682 \ \dots) = .42768 \ 66160 \ \dots$

Derivatives

7.1.19

$$\frac{d^{n+1}}{dz^{n+1}} \operatorname{erf} z = (-1)^n \frac{2}{\sqrt{\pi}} H_n(z) e^{-z^2} \quad (n=0, 1, 2, \dots)$$

7.1.20

$$w^{(n+2)}(z) + 2zw^{(n+1)}(z) + 2(n+1)w^{(n)}(z) = 0 \quad (n=0, 1, 2, \dots)$$

$$w^{(0)}(z) = w(z), \quad w'(z) = -2zw(z) + \frac{2i}{\sqrt{\pi}}$$

(For the Hermite polynomials $H_n(z)$ see chapter 22.)

Relation to Confluent Hypergeometric Function (see chapter 13)

7.1.21

$$\operatorname{erf} z = \frac{2z}{\sqrt{\pi}} M\left(\frac{1}{2}, \frac{3}{2}, -z^2\right) = \frac{2z}{\sqrt{\pi}} e^{-z^2} M\left(1, \frac{3}{2}, z^2\right)$$

The Normal Distribution Function With Mean m and Standard Deviation σ (see chapter 26)

7.1.22 $\frac{1}{\sigma\sqrt{2\pi}} \int_{-\infty}^x e^{-\frac{(t-m)^2}{2\sigma^2}} dt = \frac{1}{2} \left(1 + \operatorname{erf} \left(\frac{x-m}{\sigma\sqrt{2}} \right) \right)$

Asymptotic Expansion

7.1.23

$$\sqrt{\pi} z e^{z^2} \operatorname{erfc} z \sim 1 + \sum_{m=1}^{\infty} (-1)^m \frac{1 \cdot 3 \dots (2m-1)}{(2z^2)^m}$$

$$(z \rightarrow \infty, |\arg z| < \frac{3\pi}{4})$$

If $R_n(z)$ is the remainder after n terms then

7.1.24

$$R_n(z) = (-1)^n \frac{1 \cdot 3 \dots (2n-1)}{(2z^2)^n} \theta,$$

$$\theta = \int_0^\infty e^{-t} \left(1 + \frac{t}{z^2}\right)^{-n-\frac{1}{2}} dt \quad \left(|\arg z| < \frac{\pi}{2}\right)$$

$$|\theta| < 1 \quad \left(|\arg z| < \frac{\pi}{4}\right)$$

For x real, $R_n(x)$ is less in absolute value than the first neglected term and of the same sign.

Rational Approximations² ($0 \leq x < \infty$)

7.1.25

$$\operatorname{erf} x = 1 - (a_1 t + a_2 t^2 + a_3 t^3) e^{-x^2} + \epsilon(x), \quad t = \frac{1}{1+px}$$

$$|\epsilon(x)| \leq 2.5 \times 10^{-5}$$

$p = .47047 \quad a_1 = .34802 \ 42 \quad a_2 = -.09587 \ 98$
 $a_3 = .74785 \ 56$

7.1.26

$$\operatorname{erf} x = 1 - (a_1 t + a_2 t^2 + a_3 t^3 + a_4 t^4 + a_5 t^5) e^{-x^2} + \epsilon(x),$$

$$t = \frac{1}{1+px}$$

$$|\epsilon(x)| \leq 1.5 \times 10^{-7}$$

$p = .32759 \ 11 \quad a_1 = .25482 \ 9592$
 $a_2 = -.28449 \ 6736 \quad a_3 = 1.42141 \ 3741$
 $a_4 = -1.45315 \ 2027 \quad a_5 = 1.06140 \ 5429$

7.1.27

$$\operatorname{erf} x = 1 - \frac{1}{[1 + a_1 x + a_2 x^2 + a_3 x^3 + a_4 x^4]^4} + \epsilon(x)$$

$$|\epsilon(x)| \leq 5 \times 10^{-4}$$

$a_1 = .278393 \quad a_2 = .230389$
 $a_3 = .000972 \quad a_4 = .078108$

7.1.28

$$\operatorname{erf} x = 1 - \frac{1}{[1 + a_1 x + a_2 x^2 + \dots + a_6 x^6]^{16}} + \epsilon(x)$$

$$|\epsilon(x)| \leq 3 \times 10^{-7}$$

$a_1 = .07052 \ 30784 \quad a_2 = .04228 \ 20123$
 $a_3 = .00927 \ 05272 \quad a_4 = .00015 \ 20143$
 $a_5 = .00027 \ 65672 \quad a_6 = .00004 \ 30638$

² Approximations 7.1.25-7.1.28 are from C. Hastings, Jr., Approximations for digital computers. Princeton Univ. Press, Princeton, N. J., 1955 (with permission).

Infinite Series Approximation for Complex Error Function [7.19]

7.1.29

$$\operatorname{erf}(x+iy) = \operatorname{erf} x + \frac{e^{-x^2}}{2\pi x} [(1 - \cos 2xy) + i \sin 2xy]$$

$$+ \frac{2}{\pi} e^{-x^2} \sum_{n=1}^{\infty} \frac{e^{-4n^2}}{n^2 + 4x^2} [f_n(x, y) + i g_n(x, y)] + \epsilon(x, y)$$

where

$$f_n(x, y) = 2x - 2x \cosh ny \cos 2xy + n \sinh ny \sin 2xy$$

$$g_n(x, y) = 2x \cosh ny \sin 2xy + n \sinh ny \cos 2xy$$

$$|\epsilon(x, y)| \approx 10^{-16} |\operatorname{erf}(x+iy)|$$

7.2. Repeated Integrals of the Error Function

Definition

7.2.1

$$i^n \operatorname{erfc} z = \int_z^\infty i^{n-1} \operatorname{erfc} t \, dt \quad (n=0, 1, 2, \dots)$$

$$i^{-1} \operatorname{erfc} z = \frac{2}{\sqrt{\pi}} e^{-z^2}, \quad i^0 \operatorname{erfc} z = \operatorname{erfc} z$$

Differential Equation

7.2.2

$$\frac{d^2 y}{dz^2} + 2z \frac{dy}{dz} - 2ny = 0$$

$$y = Ai^n \operatorname{erfc} z + Bi^n \operatorname{erfc}(-z)$$

(A and B are constants.)

Expression as a Single Integral

7.2.3

$$i^n \operatorname{erfc} z = \frac{2}{\sqrt{\pi}} \int_z^\infty \frac{(t-z)^n}{n!} e^{-t^2} dt$$

Power Series³

7.2.4

$$i^n \operatorname{erfc} z = \sum_{k=0}^{\infty} \frac{(-1)^k z^k}{2^{n-k} k! \Gamma\left(1 + \frac{n-k}{2}\right)}$$

Recurrence Relations

7.2.5

$$i^n \operatorname{erfc} z = -\frac{z}{n} i^{n-1} \operatorname{erfc} z + \frac{1}{2n} i^{n-2} \operatorname{erfc} z$$

$$(n=1, 2, 3, \dots)$$

7.2.6

$$2(n+1)(n+2) i^{n+2} \operatorname{erfc} z$$

$$= (2n+1+2z^2) i^n \operatorname{erfc} z - \frac{1}{2} i^{n-2} \operatorname{erfc} z$$

$$(n=1, 2, 3, \dots)$$

³ The terms in this series corresponding to $k=n+2, n+4, n+6, \dots$ are understood to be zero.

Value at Zero

7.2.7

$$i^n \operatorname{erfc} 0 = \frac{1}{2^n \Gamma\left(\frac{n}{2} + 1\right)} \quad (n = -1, 0, 1, 2, \dots)$$

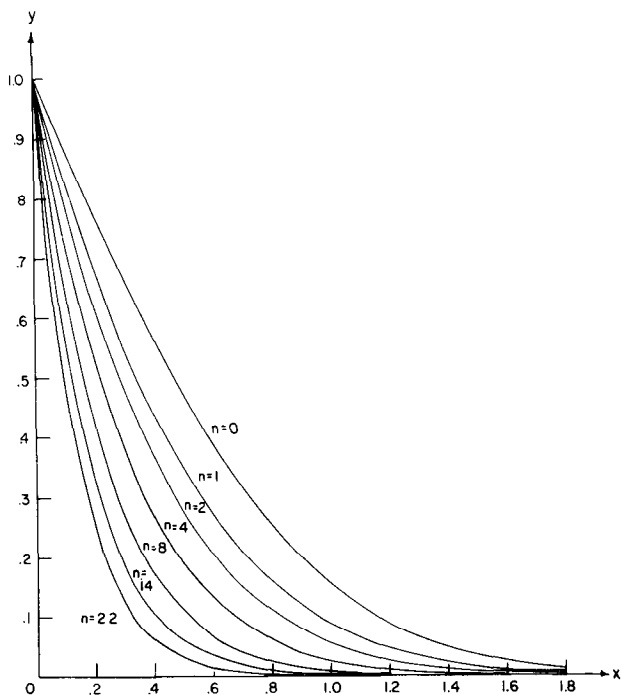

FIGURE 7.4. Repeated Integrals of the Error Function.

$$y = 2^n \Gamma\left(\frac{n}{2} + 1\right) i^n \operatorname{erfc} z$$

$$n = 0, 1, 2, 4, 8, 14, 22$$

Derivatives

$$7.2.8 \quad \frac{d}{dz} i^n \operatorname{erfc} z = -i^{n-1} \operatorname{erfc} z \quad (n = 0, 1, 2, \dots)$$

7.2.9

$$\frac{d^n}{dz^n} (e^{z^2} \operatorname{erfc} z) = (-1)^n 2^n n! e^{z^2} i^n \operatorname{erfc} z$$

$$(n = 0, 1, 2, \dots)$$

Relation to $Hh_n(z)$ (see 19.14)

$$7.2.10 \quad i^n \operatorname{erfc} z = \frac{1}{(2^{n-1} \pi)^{\frac{1}{2}}} Hh_n(\sqrt{2}z)$$

Relation to Hermite Polynomials (see chapter 22)

$$7.2.11 \quad (-1)^n i^n \operatorname{erfc} z + i^n \operatorname{erfc} (-z) = \frac{i^{-n}}{2^{n-1} n!} H_n(iz)$$

Relation to the Confluent Hypergeometric Function
(see chapter 13)

7.2.12

$$i^n \operatorname{erfc} z = e^{-z^2} \left[\frac{1}{2^n \Gamma\left(\frac{n}{2} + 1\right)} M\left(\frac{n+1}{2}, \frac{1}{2}, z^2\right) - \frac{z}{2^{n-1} \Gamma\left(\frac{n+1}{2}\right)} M\left(\frac{n}{2} + 1, \frac{3}{2}, z^2\right) \right]$$

Relation to Parabolic Cylinder Functions (see chapter 19)

$$7.2.13 \quad i^n \operatorname{erfc} z = \frac{e^{-\frac{1}{2}z^2}}{(2^{n-1} \pi)^{\frac{1}{2}}} D_{-n-1}(z\sqrt{2})$$

Asymptotic Expansion

7.2.14

$$i^n \operatorname{erfc} z \sim \frac{2}{\sqrt{\pi}} \frac{e^{-z^2}}{(2z)^{n+1}} \sum_{m=0}^{\infty} \frac{(-1)^m (2m+n)!}{n! m! (2z)^{2m}}$$

$$(z \rightarrow \infty, |\arg z| < \frac{3\pi}{4})$$

7.3. Fresnel Integrals

Definition

$$7.3.1 \quad C(z) = \int_0^z \cos\left(\frac{\pi}{2} t^2\right) dt$$

$$7.3.2 \quad S(z) = \int_0^z \sin\left(\frac{\pi}{2} t^2\right) dt$$

The following functions are also in use:

7.3.3

$$C_1(x) = \sqrt{\frac{2}{\pi}} \int_0^x \cos t^2 dt, \quad C_2(x) = \frac{1}{\sqrt{2\pi}} \int_0^x \frac{\cos t}{\sqrt{t}} dt$$

7.3.4

$$S_1(x) = \sqrt{\frac{2}{\pi}} \int_0^x \sin t^2 dt, \quad S_2(x) = \frac{1}{\sqrt{2\pi}} \int_0^x \frac{\sin t}{\sqrt{t}} dt$$

Auxiliary Functions

7.3.5

$$f(z) = \left[\frac{1}{2} - S(z)\right] \cos\left(\frac{\pi}{2} z^2\right) - \left[\frac{1}{2} - C(z)\right] \sin\left(\frac{\pi}{2} z^2\right)$$

7.3.6

$$g(z) = \left[\frac{1}{2} - C(z)\right] \cos\left(\frac{\pi}{2} z^2\right) + \left[\frac{1}{2} - S(z)\right] \sin\left(\frac{\pi}{2} z^2\right)$$

Interrelations

$$7.3.7 \quad C(x) = C_1\left(x\sqrt{\frac{\pi}{2}}\right) = C_2\left(\frac{\pi}{2} x^2\right)$$

7.3.8 $S(x) = S_1\left(x\sqrt{\frac{\pi}{2}}\right) = S_2\left(\frac{\pi}{2}x^2\right)$

7.3.9 $C(z) = \frac{1}{2} + f(z) \sin\left(\frac{\pi}{2}z^2\right) - g(z) \cos\left(\frac{\pi}{2}z^2\right)$

7.3.10 $S(z) = \frac{1}{2} - f(z) \cos\left(\frac{\pi}{2}z^2\right) - g(z) \sin\left(\frac{\pi}{2}z^2\right)$

Series Expansions

7.3.11 $C(z) = \sum_{n=0}^{\infty} \frac{(-1)^n (\pi/2)^{2n}}{(2n)!(4n+1)} z^{4n+1}$

7.3.12

$$C(z) = \cos\left(\frac{\pi}{2}z^2\right) \sum_{n=0}^{\infty} \frac{(-1)^n \pi^{2n}}{1 \cdot 3 \dots (4n+1)} z^{4n+1} + \sin\left(\frac{\pi}{2}z^2\right) \sum_{n=0}^{\infty} \frac{(-1)^n \pi^{2n+1}}{1 \cdot 3 \dots (4n+3)} z^{4n+3}$$

7.3.13 $S(z) = \sum_{n=0}^{\infty} \frac{(-1)^n (\pi/2)^{2n+1}}{(2n+1)!(4n+3)} z^{4n+3}$

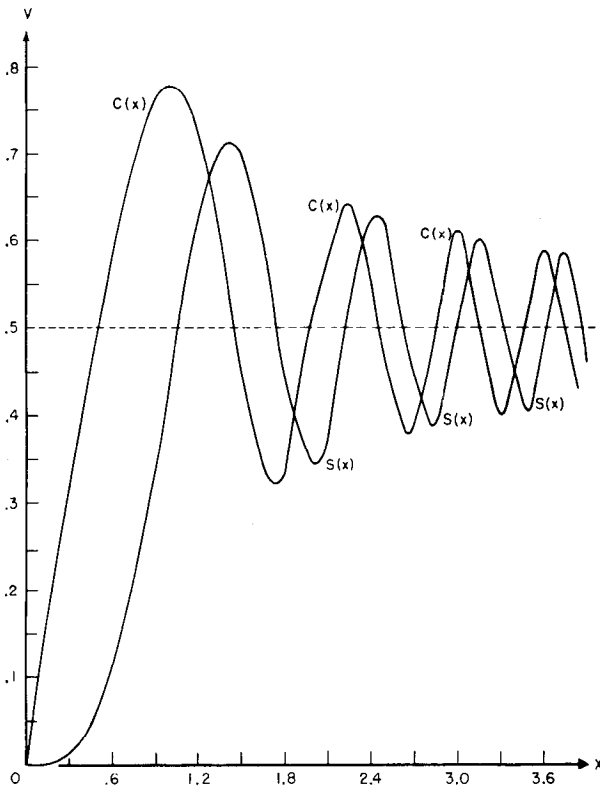

FIGURE 7.5. Fresnel Integrals.
 $y = C(x), y = S(x)$

7.3.14

$$S(z) = -\cos\left(\frac{\pi}{2}z^2\right) \sum_{n=0}^{\infty} \frac{(-1)^n \pi^{2n+1}}{1 \cdot 3 \dots (4n+3)} z^{4n+3} + \sin\left(\frac{\pi}{2}z^2\right) \sum_{n=0}^{\infty} \frac{(-1)^n \pi^{2n}}{1 \cdot 3 \dots (4n+1)} z^{4n+1}$$

7.3.15 $C_2(z) = J_{1/2}(z) + J_{5/2}(z) + J_{9/2}(z) + \dots$

7.3.16 $S_2(z) = J_{3/2}(z) + J_{7/2}(z) + J_{11/2}(z) + \dots$

For Bessel functions $J_{n+1/2}(z)$ see chapter 10.

Symmetry Relations

7.3.17 $C(-z) = -C(z), S(-z) = -S(z)$

7.3.18 $C(iz) = iC(z), S(iz) = -iS(z)$

7.3.19 $C(\bar{z}) = \overline{C(z)}, S(\bar{z}) = \overline{S(z)}$

Value at Infinity

7.3.20 $C(x) \rightarrow \frac{1}{2}, S(x) \rightarrow \frac{1}{2} \quad (x \rightarrow \infty)$

Derivatives

7.3.21 $\frac{df(x)}{dx} = -\pi x g(x), \frac{dg(x)}{dx} = \pi x f(x) - 1$

Relation to Error Function (see 7.1.1, 7.1.3)

7.3.22

$$C(z) + iS(z) = \frac{1+i}{2} \operatorname{erf}\left[\frac{\sqrt{\pi}}{2}(1-i)z\right] = \frac{1+i}{2} \left\{ 1 - e^{-\frac{\pi}{2}z^2} w\left[\frac{\sqrt{\pi}}{2}(1+i)z\right] \right\}$$

7.3.23 $g(x) = \mathcal{R}\left\{\frac{1+i}{2} w\left[\frac{\sqrt{\pi}}{2}(1+i)x\right]\right\}$

7.3.24 $f(x) = \mathcal{I}\left\{\frac{1+i}{2} w\left[\frac{\sqrt{\pi}}{2}(1+i)x\right]\right\}$

Relation to Confluent Hypergeometric Function (see chapter 13)

7.3.25

$$C(z) + iS(z) = zM\left(\frac{1}{2}, \frac{3}{2}, i\frac{\pi}{2}z^2\right) = ze^{i\frac{\pi}{2}z^2} M\left(1, \frac{3}{2}, -i\frac{\pi}{2}z^2\right)$$

Relation to Spherical Bessel Functions (see chapter 10)

7.3.26 $C_2(z) = \frac{1}{2} \int_0^z J_{-1}(t) dt, S_2(z) = \frac{1}{2} \int_0^z J_1(t) dt$

Asymptotic Expansions

7.3.27

$$\pi z f(z) \sim 1 + \sum_{m=1}^{\infty} (-1)^m \frac{1 \cdot 3 \dots (4m-1)}{(\pi z^2)^{2m}} \quad \left(z \rightarrow \infty, |\arg z| < \frac{\pi}{2} \right)$$

7.3.28

$$\pi z g(z) \sim \sum_{m=0}^{\infty} (-1)^m \frac{1 \cdot 3 \dots (4m+1)}{(\pi z^2)^{2m+1}} \quad \left(z \rightarrow \infty, |\arg z| < \frac{\pi}{2} \right)$$

If $R_n^{(f)}(z)$, $R_n^{(g)}(z)$ are the remainders after n terms in 7.3.27, 7.3.28, respectively, then

7.3.29

$$R_n^{(f)}(z) = (-1)^n \frac{1 \cdot 3 \dots (4n-1)}{(\pi z^2)^{2n}} \theta^{(f)},$$

$$\theta^{(f)} = \frac{1}{\Gamma(2n + \frac{1}{2})} \int_0^{\infty} \frac{e^{-t} t^{2n-1}}{1 + \left(\frac{2t}{\pi z^2}\right)^2} dt \quad \left(|\arg z| < \frac{\pi}{4} \right)$$

7.3.30

$$R_n^{(g)}(z) = (-1)^n \frac{1 \cdot 3 \dots (4n+1)}{(\pi z^2)^{2n}} \theta^{(g)},$$

$$\theta^{(g)} = \frac{1}{\Gamma(2n + \frac{3}{2})} \int_0^{\infty} \frac{e^{-t} t^{2n+1}}{1 + \left(\frac{2t}{\pi z^2}\right)^2} dt \quad \left(|\arg z| < \frac{\pi}{4} \right)$$

$$7.3.31 \quad |\theta^{(f)}| < 1, |\theta^{(g)}| < 1 \quad \left(|\arg z| \leq \frac{\pi}{8} \right)$$

For x real, $R_n^{(f)}(x)$ and $R_n^{(g)}(x)$ are less in absolute value than the first neglected term and of the same sign.

Rational Approximations⁴ ($0 \leq x \leq \infty$)

7.3.32

$$f(x) = \frac{1 + .926x}{2 + 1.792x + 3.104x^2} + \epsilon(x) \quad |\epsilon(x)| \leq 2 \times 10^{-3}$$

7.3.33

$$g(x) = \frac{1}{2 + 4.142x + 3.492x^2 + 6.670x^3} + \epsilon(x)$$

$$|\epsilon(x)| \leq 2 \times 10^{-3}$$

(For more accurate approximations see [7.1].)

7.4. Definite and Indefinite Integrals

For a more extensive list of integrals see [7.5], [7.8], [7.15].

$$7.4.1 \quad \int_0^{\infty} e^{-t^2} dt = \frac{\sqrt{\pi}}{2}$$

⁴ Approximations 7.3.32, 7.3.33 are based on those given in C. Hastings, Jr., Approximations for calculating Fresnel integrals, Approximation Newsletter, April 1956, Note 10. [See also MTAC 10, 173, 1956.]

7.4.2

$$\int_0^{\infty} e^{-(at^2+2bt+c)} dt = \frac{1}{2} \sqrt{\frac{\pi}{a}} e^{\frac{b^2-ac}{a}} \operatorname{erfc} \frac{b}{\sqrt{a}} \quad (\Re a > 0)$$

7.4.3

$$\int_0^{\infty} e^{-at^2 - \frac{b}{i^2}} dt = \frac{1}{2} \sqrt{\frac{\pi}{a}} e^{-2\sqrt{ab}} \quad (\Re a > 0, \Re b > 0)$$

7.4.4

$$\int_0^{\infty} t^{2n} e^{-at^2} dt = \frac{1 \cdot 3 \dots (2n-1)}{2^{n+1} a^n} \sqrt{\frac{\pi}{a}}$$

$$= \frac{\Gamma(n + \frac{1}{2})}{2a^{n+\frac{1}{2}}} \quad (\Re a > 0; n=0, 1, 2, \dots)$$

7.4.5

$$\int_0^{\infty} t^{2n+1} e^{-at^2} dt = \frac{n!}{2a^{n+1}} \quad (\Re a > 0; n=0, 1, 2, \dots)$$

7.4.6

$$\int_0^{\infty} e^{-at^2} \cos(2xt) dt = \frac{1}{2} \sqrt{\frac{\pi}{a}} e^{-\frac{x^2}{a}} \quad (\Re a > 0)$$

7.4.7

$$\int_0^{\infty} e^{-at^2} \sin(2xt) dt = \frac{1}{\sqrt{a}} e^{-x^2/a} \int_0^{x/\sqrt{a}} e^{t^2} dt$$

$$(\Re a > 0)$$

7.4.8

$$\int_0^{\infty} \frac{e^{-at} dt}{\sqrt{t+z^2}} = \sqrt{\frac{\pi}{a}} e^{az^2} \operatorname{erfc} \sqrt{az} \quad (\Re a > 0, \Re z > 0)$$

7.4.9

$$\int_0^{\infty} \frac{e^{-at} dt}{\sqrt{t(t+z)}} = \frac{\pi}{\sqrt{z}} e^{az} \operatorname{erfc} \sqrt{az}$$

$$(\Re a > 0, z \neq 0, |\arg z| < \pi)$$

7.4.10

$$\int_0^{\infty} \frac{e^{-at^2} dt}{t+x} = e^{-ax^2} \left[\sqrt{\pi} \int_0^{\sqrt{ax}} e^{t^2} dt - \frac{1}{2} \operatorname{Ei}(ax^2) \right]$$

$$(\Re a > 0, x > 0)$$

7.4.11

$$\int_0^{\infty} \frac{e^{-at^2} dt}{t^2+x^2} = \frac{\pi}{2x} e^{ax^2} \operatorname{erfc} \sqrt{ax} \quad (a > 0, x > 0)$$

$$7.4.12 \quad \int_0^1 \frac{e^{-at^2} dt}{t^2+1} = \frac{\pi}{4} e^a [1 - (\operatorname{erf} \sqrt{a})^2] \quad (a > 0)$$

7.4.13

$$\int_{-\infty}^{\infty} \frac{ye^{-t^2} dt}{(x-t)^2+y^2} = \pi \mathcal{R}w(x+iy) \quad (x \text{ real}, y > 0)$$

7.4.14

$$\int_{-\infty}^{\infty} \frac{(x-t)e^{-t^2} dt}{(x-t)^2 + y^2} = \pi \mathcal{F} w(x+iy) \quad (x \text{ real}, y > 0)$$

7.4.15

$$\int_0^{\infty} \frac{[t^2 - (x^2 - y^2)]e^{-t^2} dt}{t^4 - 2(x^2 - y^2)t^2 + (x^2 + y^2)^2} = \frac{\pi}{2} \mathcal{R} \frac{w(x+iy)}{y-ix}$$

(x real, y > 0)

7.4.16

$$\int_0^{\infty} \frac{2xye^{-t^2} dt}{t^4 - 2(x^2 - y^2)t^2 + (x^2 + y^2)^2} = \frac{\pi}{2} \mathcal{F} \frac{w(x+iy)}{y-ix}$$

(x real, y > 0)

7.4.17

$$\int_0^{\infty} e^{-at} \operatorname{erf} bt \, dt = \frac{1}{a} e^{\frac{a^2}{4b^2}} \operatorname{erfc} \frac{a}{2b}$$

(ℜa > 0, |arg b| < π/4)

7.4.18

$$\int_0^{\infty} \sin(2at) \operatorname{erfc} bt \, dt = \frac{1}{2a} [1 - e^{-(a/b)^2}] \quad (a > 0, \mathcal{R}b > 0)$$

7.4.19

$$\int_0^{\infty} e^{-at} \operatorname{erf} \sqrt{bt} \, dt = \frac{1}{a} \sqrt{\frac{b}{a+b}} \quad (\mathcal{R}(a+b) > 0)$$

7.4.20

$$\int_0^{\infty} e^{-at} \operatorname{erfc} \sqrt{\frac{b}{t}} \, dt = \frac{1}{a} e^{-2\sqrt{ab}} \quad (\mathcal{R}a > 0, \mathcal{R}b > 0)$$

7.4.21

$$\int_0^{\infty} e^{(a-b)t} \operatorname{erfc} \left(\sqrt{at} + \sqrt{\frac{c}{t}} \right) dt = \frac{e^{-2(\sqrt{ac} + \sqrt{bc})}}{\sqrt{b}(\sqrt{a} + \sqrt{b})}$$

(ℜb > 0, ℜc > 0)

7.4.22

$$\int_0^{\infty} e^{-at} \cos(t^2) dt = \sqrt{\frac{\pi}{2}} \left\{ \left[\frac{1}{2} - S\left(\frac{a}{2}\sqrt{\frac{2}{\pi}}\right) \right] \cos\left(\frac{a^2}{4}\right) - \left[\frac{1}{2} - C\left(\frac{a}{2}\sqrt{\frac{2}{\pi}}\right) \right] \sin\left(\frac{a^2}{4}\right) \right\} \quad (\mathcal{R}a > 0)$$

7.4.23

$$\int_0^{\infty} e^{-at} \sin(t^2) dt = \sqrt{\frac{\pi}{2}} \left\{ \left[\frac{1}{2} - C\left(\frac{a}{2}\sqrt{\frac{2}{\pi}}\right) \right] \cos\left(\frac{a^2}{4}\right) + \left[\frac{1}{2} - S\left(\frac{a}{2}\sqrt{\frac{2}{\pi}}\right) \right] \sin\left(\frac{a^2}{4}\right) \right\} \quad (\mathcal{R}a > 0)$$

7.4.24

$$\int_0^{\infty} e^{-at} \frac{\sin(t^2)}{t} dt = \frac{\pi}{2} \left[\frac{1}{2} - C\left(\frac{a}{2}\sqrt{\frac{2}{\pi}}\right) \right]^2 + \frac{\pi}{2} \left[\frac{1}{2} - S\left(\frac{a}{2}\sqrt{\frac{2}{\pi}}\right) \right]^2 \quad (\mathcal{R}a > 0)$$

7.4.25

$$\int_0^{\infty} \frac{e^{-at}\sqrt{t}}{t^2 + b^2} dt = \pi \sqrt{\frac{2}{b}} \left\{ \left[\frac{1}{2} - C\left(\sqrt{\frac{2ab}{\pi}}\right) \right] \cos(ab) + \left[\frac{1}{2} - S\left(\sqrt{\frac{2ab}{\pi}}\right) \right] \sin(ab) \right\} \quad (\mathcal{R}a > 0, \mathcal{R}b > 0)$$

7.4.26

$$\int_0^{\infty} \frac{e^{-at} dt}{\sqrt{t}(t^2 + b^2)} = \frac{\pi}{b} \sqrt{\frac{2}{b}} \left\{ \left[\frac{1}{2} - S\left(\sqrt{\frac{2ab}{\pi}}\right) \right] \cos(ab) - \left[\frac{1}{2} - C\left(\sqrt{\frac{2ab}{\pi}}\right) \right] \sin(ab) \right\} \quad (\mathcal{R}a > 0, \mathcal{R}b > 0)$$

7.4.27

$$\int_0^{\infty} e^{-at} C(t) dt = \frac{1}{a} \left\{ \left[\frac{1}{2} - S\left(\frac{a}{\pi}\right) \right] \cos\left(\frac{a^2}{2\pi}\right) - \left[\frac{1}{2} - C\left(\frac{a}{\pi}\right) \right] \sin\left(\frac{a^2}{2\pi}\right) \right\} \quad (\mathcal{R}a > 0)$$

7.4.28

$$\int_0^{\infty} e^{-at} S(t) dt = \frac{1}{a} \left\{ \left[\frac{1}{2} - C\left(\frac{a}{\pi}\right) \right] \cos\left(\frac{a^2}{2\pi}\right) + \left[\frac{1}{2} - S\left(\frac{a}{\pi}\right) \right] \sin\left(\frac{a^2}{2\pi}\right) \right\} \quad (\mathcal{R}a > 0)$$

7.4.29

$$\int_0^{\infty} e^{-at} C\left(\sqrt{\frac{2t}{\pi}}\right) dt = \frac{1}{2a(\sqrt{a^2+1}-a)\sqrt{a^2+1}} \quad (\mathcal{R}a > 0)$$

7.4.30

$$\int_0^{\infty} e^{-at} S\left(\sqrt{\frac{2t}{\pi}}\right) dt = \frac{1}{2a(\sqrt{a^2+1}+a)\sqrt{a^2+1}} \quad (\mathcal{R}a > 0)$$

7.4.31 $\int_0^{\infty} \left\{ \left[\frac{1}{2} - C(t) \right]^2 + \left[\frac{1}{2} - S(t) \right]^2 \right\} dt = \frac{1}{\pi}$

7.4.32

$$\int e^{-(ax^2+2bx+c)} dx = \frac{1}{2} \sqrt{\frac{\pi}{a}} e^{\frac{b^2-ac}{a}} \operatorname{erf}\left(\sqrt{ax} + \frac{b}{\sqrt{a}}\right) + \text{const.} \quad (a \neq 0)$$

7.4.33

$$\int e^{-ax^2 - \frac{b^2}{x^2}} dx = \frac{\sqrt{\pi}}{4a} \left[e^{2ab} \operatorname{erf} \left(ax + \frac{b}{x} \right) + e^{-2ab} \operatorname{erf} \left(ax - \frac{b}{x} \right) \right] + \text{const.} \quad (a \neq 0)$$

7.4.34

$$\int e^{-ax^2 + \frac{b^2}{x^2}} dx = -\frac{\sqrt{\pi}}{4a} e^{-a^2 x^2 + \frac{b^2}{x^2}} \left[w \left(\frac{b}{x} + iax \right) + w \left(-\frac{b}{x} + iax \right) \right] + \text{const.} \quad (a \neq 0)$$

$$7.4.35 \quad \int \operatorname{erf} x dx = x \operatorname{erf} x + \frac{1}{\sqrt{\pi}} e^{-x^2} + \text{const.}$$

7.4.36

$$\int e^{ax} \operatorname{erf} bx dx = \frac{1}{a} \left[e^{ax} \operatorname{erf} bx - e^{\frac{a^2}{4b^2}} \operatorname{erf} \left(bx - \frac{a}{2b} \right) \right] + \text{const.} \quad (a \neq 0)$$

7.4.37

$$\int e^{ax} \operatorname{erf} \sqrt{\frac{b}{x}} dx = \frac{1}{a} \left\{ e^{ax} \operatorname{erf} \sqrt{\frac{b}{x}} + \frac{1}{2} e^{ax - \frac{b}{x}} \left[w \left(\sqrt{ax} + i \sqrt{\frac{b}{x}} \right) + w \left(-\sqrt{ax} + i \sqrt{\frac{b}{x}} \right) \right] \right\} + \text{const.} \quad (a \neq 0)$$

7.4.38

$$\int \cos(ax^2 + 2bx + c) dx = -\sqrt{\frac{\pi}{2a}} \left\{ \cos \left(\frac{b^2 - ac}{a} \right) C \left[\sqrt{\frac{2}{a\pi}} (ax + b) \right] + \sin \left(\frac{b^2 - ac}{a} \right) S \left[\sqrt{\frac{2}{a\pi}} (ax + b) \right] \right\} + \text{const.}$$

7.4.39

$$\int \sin(ax^2 + 2bx + c) dx = \sqrt{\frac{\pi}{2a}} \left\{ \cos \left(\frac{b^2 - ac}{a} \right) S \left[\sqrt{\frac{2}{a\pi}} (ax + b) \right] - \sin \left(\frac{b^2 - ac}{a} \right) C \left[\sqrt{\frac{2}{a\pi}} (ax + b) \right] \right\} + \text{const.}$$

$$7.4.40 \quad \int C(x) dx = xC(x) - \frac{1}{\pi} \sin \left(\frac{\pi}{2} x^2 \right) + \text{const.}$$

$$7.4.41 \quad \int S(x) dx = xS(x) + \frac{1}{\pi} \cos \left(\frac{\pi}{2} x^2 \right) + \text{const.}$$

Numerical Methods

7.5. Use and Extension of the Tables

Example 1. Compute $\operatorname{erf} .745$ and $e^{-(.745)^2}$ using Taylor's series.

With the aid of Taylor's theorem and 7.1.19 it can be shown that

$$\operatorname{erf} (x_0 + ph) = \operatorname{erf} x_0 + \frac{2}{\sqrt{\pi}} e^{-x_0^2} ph \left[1 - phx_0 + \frac{1}{3} p^2 h^2 (2x_0^2 - 1) \right] + \epsilon$$

$$e^{-(x_0 + ph)^2} = e^{-x_0^2} \left[1 - 2phx_0 + p^2 h^2 (2x_0^2 - 1) - \frac{2}{3} p^3 h^3 x_0 (2x_0^2 - 3) \right] + \eta$$

where $|\epsilon| < 1.2 \times 10^{-10}$, $|\eta| < 3.2 \times 10^{-10}$ if $h = 10^{-2}$, $|p| \leq \frac{1}{2}$. With $x_0 = .74$, $p = .5$ and using Table 7.1

$$\begin{aligned} \operatorname{erf} .745 &= .70467 80779 + (.5)(.00652 58247) \times \\ & \quad [1 - (.005)(.74) + (.00000 83333)(.0952)] \\ & = .70792 8920 \end{aligned}$$

$$\begin{aligned} e^{-(.745)^2} &= \frac{\sqrt{\pi}}{2} (.65258 24665) [1 - .0074 \\ & \quad + (.000025)(.0952) + (.00000 00833)(.74)(1.9048)] \\ & = .57405 7910. \end{aligned}$$

As a check the computation was repeated with $x_0 = .75$, $p = -.5$.

Example 2. Compute $\operatorname{erfc} x$ to 5S for $x = 4.8$. We have $1/x^2 = .0434028$. With Table 7.2 and linear interpolation in Table 7.3, we obtain

$$\begin{aligned} \operatorname{erfc} 4.8 &= \frac{1}{4.8} (1.11253)(10^{-10})(.552669) \frac{\sqrt{\pi}}{2} \\ & = (1.1352)10^{-11}. \end{aligned}$$

Example 3. Compute $e^{-x^2} \int_0^x e^{t^2} dt$ to 5S for $x=6.5$.

With $1/x^2=.0236686$ and linear interpolation in **Table 7.5**

$$e^{-(6.5)^2} \int_0^{6.5} e^{t^2} dt = (.506143)/(6.5) = .077868.$$

Example 4. Compute $i^2 \operatorname{erfc} 1.72$ using the recurrence relation and **Table 7.1**.

By **7.2.1**, using **Table 7.1**,

$$i^{-1} \operatorname{erfc} 1.72 = .05856 \ 50.$$

Using the recurrence relation **7.2.5** and **Table 7.1**

$$i \operatorname{erfc} 1.72 = -(1.72)(.01499 \ 72) + (.5)(.05856 \ 50) = .0034873$$

$$i^2 \operatorname{erfc} 1.72 = -(86)(.0034873) + (.25)(.01499 \ 72) = .0007502.$$

Note the loss of two significant digits.

Example 5. Compute $i^k \operatorname{erfc} 1.72$ for $k=1, 2, 3$ by backward recurrence.

Let the sequence $w_\mu^m(x)$ ($\mu=m, m-1, \dots, 1, 0, -1$) be generated by backward use of the recurrence relation **7.2.5** starting with $w_{m+2}^m=0, w_{m+1}^m=1$. Then, for any fixed k , (see [7.7]),

$$\lim_{m \rightarrow \infty} \frac{w_k^m(x)}{w_{-1}^m(x)} = \frac{\sqrt{\pi}}{2} e^{x^2} i^k \operatorname{erfc} x \quad (x > 0).$$

With $x=1.72, m=15$ we obtain

μ	$w_\mu^{15}(1.72)$	μ	$w_\mu^{15}(1.72)$	μ	$w_\mu^{15}(1.72)$	μ	$w_\mu^{15}(1.72)$
17	0	12	(3) 2.1011	7	(7) 2.5879	2	(11) 1.2920
16	1	11	(4) 1.3831	6	(8) 1.5569	1	(11) 6.0064
15	3.44	10	(4) 9.8005	5	(8) 8.9787	0	(12) 2.5330
14	(1) 4.3834	9	(5) 6.4143	4	(9) 4.9570	-1	(13) 1.0087
13	(2) 2.5399	8	(6) 4.1666	3	(10) 2.6031		

From **Table 7.1** we have $\frac{2}{\sqrt{\pi}} e^{-(1.72)^2} = .058565$.

Thus,

$$i \operatorname{erfc} 1.72 \approx (.058565)(6.0064 \times 10^{11})/1.0087 \times 10^{13} = 3.4873 \times 10^{-3}$$

$$i^2 \operatorname{erfc} 1.72 \approx (.058565)(1.2920 \times 10^{11})/1.0087 \times 10^{13} = 7.5013 \times 10^{-4}$$

$$i^3 \operatorname{erfc} 1.72 \approx (.058565)(2.6031 \times 10^{10})/1.0087 \times 10^{13} = 1.5114 \times 10^{-4}.$$

Example 6. Compute $C(8.65)$ using **Table 7.8**.

With $x=8.65, 1/x=.115607$ we have from **Table 7.8** by linear interpolation

$$f(8.65) = .036797, \quad g(8.65) = .000159.$$

From **Table 4.6**

$$\sin\left(\frac{\pi}{2} x^2\right) = -.961382, \quad \cos\left(\frac{\pi}{2} x^2\right) = -.275218.$$

Using **7.3.9**

$$C(8.65) = .5 + (.036797)(-.961382) - (.000159)(-.275218) = .46467.$$

Example 7. Compute $S_1(1.1)$ to 10D.

Using **7.3.8** and **7.3.10** we obtain by 6-pt interpolation in **Table 7.8**

$$S_1(1.1) = S\left(1.1 \sqrt{\frac{2}{\pi}}\right) = S(.87767 \ 30169) = .31865 \ 57172.$$

Example 8. Compute $S_2(5.24)$ to 6D.

Enter **Table 7.7** in the column headed by u . Using Aitken's scheme of interpolation

u	$S_2(u)$					
5.20310 58	.43280 06	.03689 42				
5.31808 80	.41573 97	-.07808 80	.42732 63			
5.08938 01	.45093 88	.15061 99	691 63	.42718 63		
5.43432 70	.39999 44	-.19432 70	756 60	6 52	.42717 71	
4.97691 11	.46990 94	.26308 89	674 79	9 39	61	.42717 67

$$S_2(5.24) = .427177$$

Example 9. Compute $S_2(5.24)$ using Taylor's series and **Table 7.8**.

Using **7.3.21** we can write Taylor's series for $f_2(u)$

$$= f\left(\sqrt{\frac{2u}{\pi}}\right) \text{ and } g_2(u) = g\left(\sqrt{\frac{2u}{\pi}}\right) \text{ in the form}$$

$$f_2(u) = c_0 + c_1(u - u_0) + \frac{c_2}{2!}(u - u_0)^2 + \frac{c_3}{3!}(u - u_0)^3 + \dots,$$

$$g_2(u) = -\left[c_1 + c_2(u - u_0) + \frac{c_3}{2!}(u - u_0)^2 + \frac{c_4}{3!}(u - u_0)^3 + \dots \right],$$

where

$$c_0 = f_2(u_0), c_1 = -g_2(u_0),$$

$$c_{k+2} = -c_k + (-1)^k \frac{1 \cdot 3 \dots (2k-1)}{\sqrt{2\pi} u_0 (2u_0)^k}$$

($k = 0, 1, 2, \dots$).

Consulting **Table 7.8** we chose $u_0 = 1/.185638 = 5.386819$, thus having $u - u_0 = 5.24 - 5.386819 = -.146819$. From **Table 7.8**

$$f_2(u_0) = .168270, g_2(u_0) = .014483.$$

Hence, applying the series above,

$$f_2(5.24) = .170436, g_2(5.24) = .015030.$$

Using the 4th formula at the bottom of **Table 7.8**

$$S_2(5.24) = .5 - (.170436)(.503471) - (.015030)(-.864012) = .42718.$$

Example 10. Compute $S_2(2)$ using **7.3.16**.

Generating the values of $J_{n+1/2}(2)$ as described in chapter 10 we find

$$S_2(2) = J_{3/2}(2) + J_{7/2}(2) + J_{11/2}(2) + J_{15/2}(2) + \dots = .49129 + .06852 + .00297 + .00006 = .56284.$$

Example 11. Compute $\int_1^\infty \frac{Y_0(t)}{t} dt$ by numerical integration using **Tables 9.1** and **7.8**. [$Y_0(t)$ is the Bessel function of the second kind defined in **9.1.16**.]

We decompose the integral into three parts

$$\int_1^\infty Y_0(t) \frac{dt}{t} = \int_1^{10} Y_0(t) \frac{dt}{t} + \int_{10}^\infty [Y_0(t) - \tilde{Y}_0(t)] \frac{dt}{t} + \int_{10}^\infty \tilde{Y}_0(t) \frac{dt}{t}$$

where

$$\tilde{Y}_0(t) = \left(1 - \frac{9}{128t^2}\right) \frac{\sin\left(t - \frac{\pi}{4}\right)}{\sqrt{\frac{1}{2}\pi t}} - \left(1 - \frac{75}{128t^2}\right) \frac{\cos\left(t - \frac{\pi}{4}\right)}{8t\sqrt{\frac{1}{2}\pi t}}$$

represents the first two terms of the asymptotic expansion **9.2.2**.

By numerical integration, using **Table 9.1**,

$$\int_1^{10} Y_0(t) \frac{dt}{t} = .41826 \ 00.$$

Using the fact that the remainder terms of the asymptotic expansion are less in absolute value than the first neglected terms, we can estimate

$$\left| \int_{10}^\infty [Y_0(t) - \tilde{Y}_0(t)] \frac{dt}{t} \right| \leq \sqrt{\frac{2}{\pi}} \int_{10}^\infty \left[\frac{3^2 \cdot 5^2 \cdot 7^2}{2^{12} \cdot 4!} t^{-11/2} + \frac{3^2 \cdot 5^2 \cdot 7^2 \cdot 9^2}{2^{15} \cdot 5!} t^{-13/2} \right] dt = 7.33 \times 10^{-7}.$$

Finally,

$$\int_{10}^\infty \tilde{Y}_0(t) \frac{dt}{t} = \frac{14659}{6720} \sqrt{2} [1 - C_2(10) - S_2(10)] - \frac{5953819 \cos 10 - \sin 10}{2688000 \sqrt{10\pi}} - \frac{23107 \cos 10 + \sin 10}{2150400 \sqrt{10\pi}} = -.02298 \ 78,$$

using **Tables 7.8** and **4.8**. Hence

$$\int_1^\infty Y_0(t) \frac{dt}{t} = .41826 \ 00 - .02298 \ 78 = .39527 \ 22.$$

The answer correct to 8D is .39527 290 (**Table 11.2**).

Example 12. Compute $w(.44 + .67i)$ using bivariate linear interpolation.

By linear interpolation in **Table 7.9** along the x -direction at $y = .6$ and $y = .7$

$$w(.44 + .6i) \approx .6(.522246 + .167880i) + .4(.498591 + .202666i) = .512784 + .181794i$$

$$w(.44 + .7i) \approx .6(.487556 + .147975i) + .4(.467521 + .179123i) = .479542 + .160434i.$$

By linear interpolation along the y -direction at $x = .44$

$$w(.44 + .67i) \approx .3(.512784 + .181794i) + .7(.479542 + .160434i) = .489515 + .166842i.$$

The correct answer is .489557 + .166889i.

Example 13. Compute $\mathcal{R}w(z)$ for $z = .44 + .61i$.

Bivariate linear interpolation, as described in **Example 12**, is most accurate if z lies near the center or along a diagonal of one of the squares of the tabular grid [7.6]. It is not as accurate for z near the midpoint of a side of a square, as in this example. However, we may introduce an auxil-

ary square (see diagram) which contains z close to its center. Bivariate linear interpolation can then be applied within this auxiliary square.

The values of $w(z)$ needed at $z=\zeta_1$, and $z=\zeta_2$ are easily approximated by the average of the four neighboring tabular values. Furthermore the parts to be used are given by

$$\frac{|z_0 - \lambda_1|}{|z_0 - \zeta_1|} = p_1 + p_2, \quad \frac{|z_0 - \lambda_2|}{|z_0 - \zeta_2|} = p_1 - p_2$$

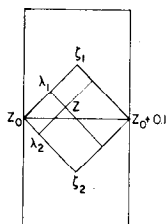

where $z = z_0 + .1(p_1 + ip_2)$. Thus, with $z_0 = .4 + .6i$, $\zeta_1 = .45 + .65i$, $\zeta_2 = .45 + .55i$, $p_1 = .4$, $p_2 = .1$, we get from Table 7.9

$$\mathcal{R}w(\zeta_1) \approx \frac{1}{4}(.522246 + .498591 + .487556 + .467521) = .493979$$

$$\mathcal{R}w(\zeta_2) \approx \frac{1}{4}(.522246 + .498591 + .561252 + .533157) = .528812$$

$$\mathcal{R}w(z) \approx [1 - (.4 + .1)]\{[1 - (.4 - .1)].522246 + (.4 - .1).528812\} + (.4 + .1) \times \{[1 - (.4 - .1)].493979 + (.4 - .1).498591\} = .509789.$$

The correct answer is .509756. Straightforward bivariate interpolation gives .509460.

Example 14. Compute $\mathcal{I}w(.39 + .61i)$ to 6D using Taylor's series.

Let $z = .39 + .61i$, $z_0 = .4 + .6i$. From 7.1.20, and using Table 7.9, we have

$$w(z_0) = .522246 + .167880i$$

$$w'(z_0) = -.21634 + .36738i, \quad z - z_0 = (-1 + i)10^{-2}$$

$$\frac{1}{2}w''(z_0) = -.215 - .185i, \quad (z - z_0)^2 = -2i \times 10^{-4}$$

$$\mathcal{I}w(z) = .167880 - .0021634 - .0036738 + .0000430 = .162086.$$

Example 15. Compute $w(.4 - 1.3i)$.

From 7.1.11, 7.1.12

$$w(.4 - 1.3i) = \overline{w(-.4 - 1.3i)} = 2e^{-(.4 - 1.3i)^2} - \overline{w(.4 + 1.3i)}.$$

Using Tables 7.9, 4.4 and 4.6

$$w(.4 - 1.3i) = 4.33342 + 8.04201i.$$

Example 16. Compute $w(7 + 2i)$.

Using the second formula at the end of Table 7.9

$$w(7 + 2i) = (-2 + 7i) \left(\frac{.5124242}{44.72474 + 28i} + \frac{.05176536}{42.27525 + 28i} \right) = .021853 + .075010i.$$

Example 17. Compute $\text{erf}(2 + i)$.

From 7.1.3, 7.1.12 we have

$$\text{erf } z = 1 - e^{-z^2}w(iz) = 1 - e^{y^2 - x^2}(\cos 2xy - i \sin 2xy)\overline{w(y + ix)} \quad (z = x + iy).$$

Using Tables 7.9, 4.4, 4.6

$$\text{erf}(2 + i) = 1 - e^{-3}(\cos 4 - i \sin 4)\overline{w(1 + 2i)} = 1.003606 - .0112590i.$$

Example 18. Compute $S_1\left(\left(\frac{1}{2} + i\right)\sqrt{2}\right)$.

From 7.3.22, 7.3.8, 7.3.18 we have

$$S_1(z) = \frac{1}{2} - \frac{1-i}{4} e^{iz^2}w\left[(1+i)\frac{z}{\sqrt{2}}\right] - \frac{1+i}{4} e^{-iz^2}w\left[(i-1)\frac{z}{\sqrt{2}}\right].$$

Setting $z = \left(\frac{1}{2} + i\right)\sqrt{2}$ and making use of 7.1.11, 7.1.12, and Table 7.9

$$S_1\left(\left(\frac{1}{2} + i\right)\sqrt{2}\right) = -\frac{i}{2} - \frac{1-i}{4} e^{-2} \left(\cos \frac{3}{2} - i \sin \frac{3}{2}\right) \overline{w\left(\frac{1}{2} + \frac{3}{2}i\right)} + \frac{1+i}{4} e^2 \left(\cos \frac{3}{2} + i \sin \frac{3}{2}\right) w\left(\frac{3}{2} + \frac{1}{2}i\right) = -.990734 - .681619i.$$

Example 19. Compute $\int_0^\infty e^{-(1/4)t^2 - 3t} \cos(2t) dt$ using Table 7.9.

Setting $b = y + ix$, $c = 0$ in 7.4.2 and using 7.1.3, 7.1.12 we find

$$\int_0^\infty e^{-at^2 - 2yt} \cos(2xt) dt = \frac{1}{2} \sqrt{\frac{\pi}{a}} \mathcal{R}w\left(\frac{x + iy}{\sqrt{a}}\right) \quad (a > 0, x, y \text{ real}).$$

Hence from Table 7.9

$$\int_0^\infty e^{-(1/4)t^2 - 3t} \cos(2t) dt = \sqrt{\pi} \mathcal{R}w(2 + 3i) = .231761.$$

References

Texts

- [7.1] J. Boersma, Computation of Fresnel integrals, *Math. Comp.* **14**, 380 (1960).
- [7.2] A. V. Boyd, Inequalities for Mills' ratio, *Rep. Statist. Appl. Res. Un. Jap. Sci. Engrs.* **6**, 44-46 (1959).
- [7.3] O. Emersleben, Numerische Werte des Fehlerintegrals für $\sqrt{n\pi}$, *Z. Angew. Math. Mech.* **31**, 393-394 (1951).
- [7.4] A. Erdélyi et al., Higher transcendental functions, vol. 2 (McGraw-Hill Book Co., Inc., New York, N.Y., Toronto, Canada, London, England, 1953).
- [7.5] A. Erdélyi et al., Tables of integral transforms, vol. 1 (McGraw-Hill Book Co., Inc., New York, N.Y., Toronto, Canada, London, England, 1954).
- [7.6] W. Gautschi, Note on bivariate linear interpolation for analytic functions, *Math. Tables Aids Comp.* **13**, 91-96 (1959).
- [7.7] W. Gautschi, Recursive computation of the repeated integrals of the error function, *Math. Comp.* **15**, 227-232 (1961).
- [7.8] W. Gröbner and N. Hofreiter, *Integraltafel* (Springer-Verlag, Wien and Innsbruck, Austria, 1949-50).
- [7.9] D. R. Hartree, Some properties and applications of the repeated integrals of the error function, *Mem. Proc. Manchester Lit. Philos. Soc.* **80**, 85-102 (1936).
- [7.10] C. Hastings, Jr., Approximations for digital computers (Princeton Univ. Press, Princeton, N.J., 1955).
- [7.11] Y. Komatu, Elementary inequalities for Mills' ratio, *Rep. Statist. Appl. Res. Un. Jap. Sci. Engrs.* **4**, 69-70 (1955-57).
- [7.12] E. Kreyszig, On the zeros of the Fresnel integrals, *Canad. J. Math.* **9**, 118-131 (1957).
- [7.13] Th. Laible, Höhenkarte des Fehlerintegrals, *Z. Angew. Math. Phys.* **2**, 484-486 (1951).
- [7.14] F. Löscher and F. Schoblik, *Die Fakultät* (B. G. Teubner, Leipzig, Germany, 1951).
- [7.15] F. Oberhettinger, Tabellen zur Fourier Transformation (Springer-Verlag, Berlin, Göttingen, Heidelberg, Germany, 1957).
- [7.16] J. R. Philip, The function $\operatorname{inv} \operatorname{erfc} \theta$, *Austral. J. Phys.* **13**, 13-20 (1960).
- [7.17] H. O. Pollak, A remark on "Elementary inequalities for Mills' ratio" by Yūsaku Komatu, *Rep. Statist. Appl. Res. Un. Jap. Sci. Engrs.* **4**, 110 (1955-57).
- [7.18] J. B. Rosser, Theory and application of $\int_0^x e^{-x^2} dx$ and $\int_0^x e^{-x^2} dy \int_0^y e^{-x^2} dx$ (Mapleton House, Brooklyn, N.Y., 1948).
- [7.19] H. E. Salzer, Formulas for calculating the error function of a complex variable, *Math. Tables Aids Comp.* **5**, 67-70 (1951).
- [7.20] H. E. Salzer, Complex zeros of the error function, *J. Franklin Inst.* **260**, 209-211 (1955).
- [7.21] F. G. Tricomi, *Funzioni ipergeometriche confluenti* (Edizioni Cremonese, Rome, Italy, 1954).

Tables

- [7.22] G. N. Watson, A treatise on the theory of Bessel functions, 2d ed. (Cambridge Univ. Press, London, England, 1958).
- [7.23] M. Abramowitz, Table of the integral $\int_0^x e^{-u^3} du$, *J. Math. Phys.* **30**, 162-163 (1951). $x=0(.01)2.5$, 8D.
- [7.24] P. C. Clemmow and Cara M. Munford, A table of $\sqrt{(\frac{1}{2}\pi)} e^{i\pi\rho^2} \int_0^\infty e^{-i\pi\lambda^2} d\lambda$ for complex values of ρ , *Philos. Trans. Roy. Soc. London {A}*, **245**, 189-211 (1952). $|\rho|=0(.01).8$, $\arg \rho=0^\circ(1^\circ)45^\circ$, 4D.
- [7.25] R. B. Dingle, Doreen Arndt and S. K. Roy, The integrals
- $$C_p(x) = (p!)^{-1} \int_0^\infty e^{\rho(e^2+x^2)^{-1}} e^{-t} dt$$
- and
- $$D_p(x) = (p!)^{-1} \int_0^\infty e^{\rho(e^2+x^2)^{-2}} e^{-t} dt$$
- and their tabulation, *Appl. Sci. Res. B* **6**, 155-164 (1956). $C(x)$, $S(x)$, $x=0(1)20$, 12D.
- [7.26] V. N. Faddeeva and N. M. Terent'ev, Tables of values of the function $w(z) = e^{-z^2} \left(1 + \frac{2i}{\sqrt{\pi}} \int_0^z e^{t^2} dt \right)$ for complex argument. Translated from the Russian by D. G. Fry (Pergamon Press, New York, N.Y., 1961). $w(z)$, $z=x+iy$; $x, y=0(.02)3$; $x=3(.1)5$, $y=0(.1)3$; $x=0(.1)5$, $y=3(.1)5$; 6D.
- [7.27] B. D. Fried and S. D. Conte, The plasma dispersion function (Academic Press, New York, N.Y. and London, England, 1961). $i\sqrt{\pi}w(z)$, $i\sqrt{\pi}w'(z)$, $z=x+iy$; $x=0(.1)9.9$, $y=-9.1(.1)10$; $x=\operatorname{var}(.1)9.9$, $y=-10(.1)-9.2$; 6S.
- [7.28] K. A. Karpov, *Tablitsy funktsii $w(z) = e^{-z^2} \int_0^z e^{t^2} dx$ v kompleksnoi oblasti* (Izdat. Akad. Nauk SSSR., Moscow, U.S.S.R., 1954).
 $z=x$; $x=0(.001)2(.01)10$; 5D;
 $z=\rho e^{i\theta}$; $\theta=2.5^\circ(2.5^\circ)30^\circ(1.25^\circ)35^\circ(.625^\circ)40^\circ$;
 $\rho=\rho_\theta(.001)\rho'_\theta(.01)\rho''_\theta(.0002)5$, $0 \leq \rho_\theta \leq \rho'_\theta \leq \rho''_\theta \leq 5$, 5D;
 $z=iy$; $y=0(.001)3(.0002)5$, 5S.
- [7.29] K. A. Karpov, *Tablitsy funktsii $F(z) = \int_0^z e^{x^2} dx$ v kompleksnoi oblasti* (Izdat. Akad. Nauk SSSR., Moscow, U.S.S.R., 1958). $z=\rho e^{i\theta}$;
 $\theta=45^\circ(.3125^\circ)48.75^\circ(.625^\circ)55^\circ(1.25^\circ)65^\circ(2.5^\circ)90^\circ$;
 $\rho=\rho_\theta(.001)\rho'_\theta(.01)\rho''_\theta$, $0 \leq \rho_\theta < \rho'_\theta \leq \rho''_\theta \leq 5$, 5D;
 $z=x$; $x=0(.001)10$, 5S.
- [7.30] J. Kaye, A table of the first eleven repeated integrals of the error function, *J. Math. Phys.* **34**, 119-125 (1955). $i^n \operatorname{erfc} x$, $x=0(.01).2(.05)1(.1)3$, $n=-1(1)11$, 6D.
- [7.31] B. Lohmander and S. Rittsten, Table of the function $y = e^{-x^2} \int_0^x e^{t^2} dt$, *Kungl. Fysiogr. Sällsk. i Lund Förh.* **28**, 45-52 (1958). $x=0(.01)3(.02)5$, $x^{-1}=0(.005).2$, 10D; $x=.5(.5)10$, 20D. Contains also 20D values for maximum and inflection points.

- [7.32] W. Lash Miller and A. R. Gordon, Numerical evaluation of infinite series and integrals which arise in certain problems of linear heat flow, electrochemical diffusion, etc., *J. Phys. Chem.* **35**, 2785-2884 (1931).

$$F(x) = e^{-x^2} \int_0^x e^{t^2} dt; x=0(.01)1.99, \quad 6D;$$

$$x=2(.01)4(.05)7.5(.1)10(.2)12, \quad 8S.$$

- [7.33] National Bureau of Standards, Tables of the error function and its derivative, *Applied Math. Series* 41, 2d ed. (U.S. Government Printing Office, Washington, D.C., 1954).

$$(2/\sqrt{\pi})e^{-x^2}, \operatorname{erf} x, x=0(.0001)1(.001)5.6, \quad 15D;$$

$$(2/\sqrt{\pi})e^{-x^2}, \operatorname{erfc} x, x=4(.01)10, \quad 8S.$$

- [7.34] T. Pearcey, Table of the Fresnel integral (Cambridge Univ. Press, London, England, 1956).

$$C\left(\sqrt{\frac{2x}{\pi}}\right), S\left(\sqrt{\frac{2x}{\pi}}\right), x=0(.01)50, \quad 6-7D.$$

- [7.35] *Tablitsy integralov Frenelya* (Izdat. Akad. Nauk SSSR., Moscow, U.S.S.R., 1953). $C(x), S(x), x=0(.001)25, 7D$; $S(x), x=0(.001) .58, 7S$; $C(x), x=0(.001) .101, 7S$.

- [7.36] A. van Wijngaarden and W. L. Scheen, Table of Fresnel integrals, *Verh. Nederl. Akad. Wetensch., Afd. Natuurk. Sec. I*, 19, No. 4, 1-26 (1949). $C(x), S(x), x=0(.01)20, 5D$. (Also contains numerical values of the coefficients in Taylor and asymptotic expansions.)

Table 7.1

ERROR FUNCTION AND ITS DERIVATIVE

x	$\frac{2}{\sqrt{\pi}} e^{-x^2}$	$\operatorname{erf} x$	x	$\frac{2}{\sqrt{\pi}} e^{-x^2}$	$\operatorname{erf} x$
0.00	1.12837 91671	0.00000 00000	0.50	0.87878 25789	0.52049 98778
0.01	1.12826 63348	0.01128 34156	0.51	0.86995 15467	0.52924 36198
0.02	1.12792 79057	0.02256 45747	0.52	0.86103 70343	0.53789 86305
0.03	1.12736 40827	0.03384 12223	0.53	0.85204 34444	0.54646 40969
0.04	1.12657 52040	0.04511 11061	0.54	0.84297 51813	0.55493 92505
0.05	1.12556 17424	0.05637 19778	0.55	0.83383 66473	0.56332 33663
0.06	1.12432 43052	0.06762 15944	0.56	0.82463 22395	0.57161 57638
0.07	1.12286 36333	0.07885 77198	0.57	0.81536 63461	0.57981 58062
0.08	1.12118 06004	0.09007 81258	0.58	0.80604 33431	0.58792 29004
0.09	1.11927 62126	0.10128 05939	0.59	0.79666 75911	0.59593 64972
0.10	1.11715 16068	0.11246 29160	0.60	0.78724 34317	0.60385 60908
0.11	1.11480 80500	0.12362 28962	0.61	0.77777 51846	0.61168 12189
0.12	1.11224 69379	0.13475 83518	0.62	0.76826 71442	0.61941 14619
0.13	1.10946 97934	0.14586 71148	0.63	0.75872 35764	0.62704 64433
0.14	1.10647 82654	0.15694 70331	0.64	0.74914 87161	0.63458 58291
0.15	1.10327 41267	0.16799 59714	0.65	0.73954 67634	0.64202 93274
0.16	1.09985 92726	0.17901 18132	0.66	0.72992 18814	0.64937 66880
0.17	1.09623 57192	0.18999 24612	0.67	0.72027 81930	0.65662 77023
0.18	1.09240 56008	0.20093 58390	0.68	0.71061 97784	0.66378 22027
0.19	1.08837 11683	0.21183 98922	0.69	0.70095 06721	0.67084 00622
0.20	1.08413 47871	0.22270 25892	0.70	0.69127 48604	0.67780 11938
0.21	1.07969 89342	0.23352 19230	0.71	0.68159 62792	0.68466 55502
0.22	1.07506 61963	0.24429 59116	0.72	0.67191 88112	0.69143 31231
0.23	1.07023 92672	0.25502 25996	0.73	0.66224 62838	0.69810 39429
0.24	1.06522 09449	0.26570 00590	0.74	0.65258 24665	0.70467 80779
0.25	1.06001 41294	0.27632 63902	0.75	0.64293 10692	0.71115 56337
0.26	1.05462 18194	0.28689 97232	0.76	0.63329 57399	0.71753 67528
0.27	1.04904 71098	0.29741 82185	0.77	0.62368 00626	0.72382 16140
0.28	1.04329 31885	0.30788 00680	0.78	0.61408 75556	0.73001 04313
0.29	1.03736 33334	0.31828 34959	0.79	0.60452 16696	0.73610 34538
0.30	1.03126 09096	0.32862 67595	0.80	0.59498 57863	0.74210 09647
0.31	1.02498 93657	0.33890 81503	0.81	0.58548 32161	0.74800 32806
0.32	1.01855 22310	0.34912 59948	0.82	0.57601 71973	0.75381 07509
0.33	1.01195 31119	0.35927 86550	0.83	0.56659 08944	0.75952 37569
0.34	1.00519 56887	0.36936 45293	0.84	0.55720 73967	0.76514 27115
0.35	0.99828 37121	0.37938 20536	0.85	0.54786 97173	0.77066 80576
0.36	0.99122 10001	0.38932 97011	0.86	0.53858 07918	0.77610 02683
0.37	0.98401 14337	0.39920 59840	0.87	0.52934 34773	0.78143 98455
0.38	0.97665 89542	0.40900 94534	0.88	0.52016 05514	0.78668 73192
0.39	0.96916 75592	0.41873 87001	0.89	0.51103 47116	0.79184 32468
0.40	0.96154 12988	0.42839 23550	0.90	0.50196 85742	0.79690 82124
0.41	0.95378 42727	0.43796 90902	0.91	0.49296 46742	0.80188 28258
0.42	0.94590 06256	0.44746 76184	0.92	0.48402 54639	0.80676 77215
0.43	0.93789 45443	0.45688 66945	0.93	0.47515 33132	0.81156 35586
0.44	0.92977 02537	0.46622 51153	0.94	0.46635 05090	0.81627 10190
0.45	0.92153 20130	0.47548 17198	0.95	0.45761 92546	0.82089 08073
0.46	0.91318 41122	0.48465 53900	0.96	0.44896 16700	0.82542 36496
0.47	0.90473 08685	0.49374 50509	0.97	0.44037 97913	0.82987 02930
0.48	0.89617 66223	0.50274 96707	0.98	0.43187 55710	0.83423 15043
0.49	0.88752 57337	0.51166 82612	0.99	0.42345 08779	0.83850 80696
0.50	0.87878 25789	0.52049 98778	1.00	0.41510 74974	0.84270 07929
	$\left[\begin{smallmatrix} (-5)3 \\ 5 \end{smallmatrix} \right]$	$\left[\begin{smallmatrix} (-5)1 \\ 5 \end{smallmatrix} \right]$		$\left[\begin{smallmatrix} (-5)1 \\ 5 \end{smallmatrix} \right]$	$\left[\begin{smallmatrix} (-5)1 \\ 5 \end{smallmatrix} \right]$

See Example 1.

$$\operatorname{erf} x = \frac{2}{\sqrt{\pi}} \int_0^x e^{-t^2} dt$$

$$\frac{\sqrt{\pi}}{2} = 0.88622 69255$$

ERROR FUNCTION AND ITS DERIVATIVE

Table 7.1

x	$\frac{2}{\sqrt{\pi}} e^{-x^2}$	$\operatorname{erf} x$	x	$\frac{2}{\sqrt{\pi}} e^{-x^2}$	$\operatorname{erf} x$
1.00	0.41510 74974	0.84270 07929	1.50	0.11893 02892	0.96610 51465
1.01	0.40684 71315	0.84681 04962	1.51	0.11540 38270	0.96727 67481
1.02	0.39867 13992	0.85083 80177	1.52	0.11195 95356	0.96841 34969
1.03	0.39058 18368	0.85478 42115	1.53	0.10859 63195	0.96951 62091
1.04	0.38257 98986	0.85864 99465	1.54	0.10531 30683	0.97058 56899
1.05	0.37466 69570	0.86243 61061	1.55	0.10210 86576	0.97162 27333
1.06	0.36684 43034	0.86614 35866	1.56	0.09898 19506	0.97262 81220
1.07	0.35911 31488	0.86977 32972	1.57	0.09593 17995	0.97360 26275
1.08	0.35147 46245	0.87332 61584	1.58	0.09295 70461	0.97454 70093
1.09	0.34392 97827	0.87680 31019	1.59	0.09005 65239	0.97546 20158
1.10	0.33647 95978	0.88020 50696	1.60	0.08722 90586	0.97634 83833
1.11	0.32912 49667	0.88353 30124	1.61	0.08447 34697	0.97720 68366
1.12	0.32186 67103	0.88678 78902	1.62	0.08178 85711	0.97803 80884
1.13	0.31470 55742	0.88997 06704	1.63	0.07917 31730	0.97884 28397
1.14	0.30764 22299	0.89308 23276	1.64	0.07662 60821	0.97962 17795
1.15	0.30067 72759	0.89612 38429	1.65	0.07414 61034	0.98037 55850
1.16	0.29381 12389	0.89909 62029	1.66	0.07173 20405	0.98110 49213
1.17	0.28704 45748	0.90200 03990	1.67	0.06938 26972	0.98181 04416
1.18	0.28037 76702	0.90483 74269	1.68	0.06709 68781	0.98249 28780
1.19	0.27381 08437	0.90760 82860	1.69	0.06487 33895	0.98315 25869
1.20	0.26734 43470	0.91031 39782	1.70	0.06271 10405	0.98379 04586
1.21	0.26097 83664	0.91295 55080	1.71	0.06060 86436	0.98440 70075
1.22	0.25471 30243	0.91553 38810	1.72	0.05856 50157	0.98500 28274
1.23	0.24854 83805	0.91805 01041	1.73	0.05657 89788	0.98557 84998
1.24	0.24248 44335	0.92050 51843	1.74	0.05464 93607	0.98613 45950
1.25	0.23652 11224	0.92290 01283	1.75	0.05277 49959	0.98667 16712
1.26	0.23065 83281	0.92523 59418	1.76	0.05095 47262	0.98719 02752
1.27	0.22489 58748	0.92751 36293	1.77	0.04918 74012	0.98769 09422
1.28	0.21923 35317	0.92973 41930	1.78	0.04747 18791	0.98817 41959
1.29	0.21367 10145	0.93189 86327	1.79	0.04580 70274	0.98864 05487
1.30	0.20820 79868	0.93400 79449	1.80	0.04419 17233	0.98909 05016
1.31	0.20284 40621	0.93606 31228	1.81	0.04262 48543	0.98952 45446
1.32	0.19757 88048	0.93806 51551	1.82	0.04110 53185	0.98994 31565
1.33	0.19241 17326	0.94001 50262	1.83	0.03963 20255	0.99034 68051
1.34	0.18734 23172	0.94191 37153	1.84	0.03820 38966	0.99073 59476
1.35	0.18236 99865	0.94376 21961	1.85	0.03681 98653	0.99111 10301
1.36	0.17749 41262	0.94556 14366	1.86	0.03547 88774	0.99147 24883
1.37	0.17271 40811	0.94731 23980	1.87	0.03417 98920	0.99182 07476
1.38	0.16802 91568	0.94901 60353	1.88	0.03292 18811	0.99215 62228
1.39	0.16343 86216	0.95067 32958	1.89	0.03170 38307	0.99247 93184
1.40	0.15894 17077	0.95228 51198	1.90	0.03052 47404	0.99279 04292
1.41	0.15453 76130	0.95385 24394	1.91	0.02938 36241	0.99308 99398
1.42	0.15022 55027	0.95537 61786	1.92	0.02827 95101	0.99337 82251
1.43	0.14600 45107	0.95685 72531	1.93	0.02721 14412	0.99365 56502
1.44	0.14187 37413	0.95829 65696	1.94	0.02617 84752	0.99392 25709
1.45	0.13783 22708	0.95969 50256	1.95	0.02517 96849	0.99417 93336
1.46	0.13387 91486	0.96105 35095	1.96	0.02421 41583	0.99442 62755
1.47	0.13001 33993	0.96237 28999	1.97	0.02328 09986	0.99466 37246
1.48	0.12623 40239	0.96365 40654	1.98	0.02237 93244	0.99489 20004
1.49	0.12254 00011	0.96489 78648	1.99	0.02150 82701	0.99511 14132
1.50	0.11893 02892	0.96610 51465	2.00	0.02066 69854	0.99532 22650

$$\frac{\sqrt{\pi}}{2} = 0.88622 69255$$

$$\left[\begin{matrix} (-5)1 \\ 5 \end{matrix} \right]$$

$$\left[\begin{matrix} (-5)1 \\ 5 \end{matrix} \right]$$

$$\left[\begin{matrix} (-5)1 \\ 5 \end{matrix} \right]$$

$$\left[\begin{matrix} (-6)4 \\ 5 \end{matrix} \right]$$

Table 7.2

DERIVATIVE OF THE ERROR FUNCTION

x	$\frac{2}{\sqrt{\pi}} e^{-x^2}$	x	$\frac{2}{\sqrt{\pi}} e^{-x^2}$	x	$\frac{2}{\sqrt{\pi}} e^{-x^2}$	x	$\frac{2}{\sqrt{\pi}} e^{-x^2}$
2.00	(- 2) 2.0666 985	2.50	(- 3) 2.1782 842	3.00	(- 4) 1.3925 305	3.50	(- 6) 5.3994 268
2.01	(- 2) 1.9854 636	2.51	(- 3) 2.0718 409	3.01	(- 4) 1.3113 047	3.51	(- 6) 5.0338 887
2.02	(- 2) 1.9070 402	2.52	(- 3) 1.9702 048	3.02	(- 4) 1.2345 698	3.52	(- 6) 4.6921 589
2.03	(- 2) 1.8313 482	2.53	(- 3) 1.8731 800	3.03	(- 4) 1.1620 929	3.53	(- 6) 4.3727 530
2.04	(- 2) 1.7583 088	2.54	(- 3) 1.7805 771	3.04	(- 4) 1.0936 521	3.54	(- 6) 4.0742 749
2.05	(- 2) 1.6878 448	2.55	(- 3) 1.6922 136	3.05	(- 4) 1.0290 362	3.55	(- 6) 3.7954 113
2.06	(- 2) 1.6198 806	2.56	(- 3) 1.6079 137	3.06	(- 5) 9.6804 434	3.56	(- 6) 3.5349 275
2.07	(- 2) 1.5543 422	2.57	(- 3) 1.5275 078	3.07	(- 5) 9.1048 542	3.57	(- 6) 3.2916 626
2.08	(- 2) 1.4911 571	2.58	(- 3) 1.4508 325	3.08	(- 5) 8.5617 765	3.58	(- 6) 3.0645 257
2.09	(- 2) 1.4302 545	2.59	(- 3) 1.3777 304	3.09	(- 5) 8.0494 817	3.59	(- 6) 2.8524 914
2.10	(- 2) 1.3715 650	2.60	(- 3) 1.3080 500	3.10	(- 5) 7.5663 267	3.60	(- 6) 2.6545 968
2.11	(- 2) 1.3150 207	2.61	(- 3) 1.2416 455	3.11	(- 5) 7.1107 499	3.61	(- 6) 2.4699 374
2.12	(- 2) 1.2605 554	2.62	(- 3) 1.1783 764	3.12	(- 5) 6.6812 674	3.62	(- 6) 2.2976 636
2.13	(- 2) 1.2081 043	2.63	(- 3) 1.1181 075	3.13	(- 5) 6.2764 699	3.63	(- 6) 2.1369 782
2.14	(- 2) 1.1576 041	2.64	(- 3) 1.0607 090	3.14	(- 5) 5.8950 187	3.64	(- 6) 1.9871 328
2.15	(- 2) 1.1089 930	2.65	(- 3) 1.0060 558	3.15	(- 5) 5.5356 429	3.65	(- 6) 1.8474 250
2.16	(- 2) 1.0622 108	2.66	(- 4) 9.5402 778	3.16	(- 5) 5.1971 360	3.66	(- 6) 1.7171 961
2.17	(- 2) 1.0171 986	2.67	(- 4) 9.0450 949	3.17	(- 5) 4.8783 532	3.67	(- 6) 1.5958 281
2.18	(- 3) 9.7389 910	2.68	(- 4) 8.5738 992	3.18	(- 5) 4.5782 082	3.68	(- 6) 1.4827 416
2.19	(- 3) 9.3225 623	2.69	(- 4) 8.1256 247	3.19	(- 5) 4.2956 707	3.69	(- 6) 1.3773 933
2.20	(- 3) 8.9221 551	2.70	(- 4) 7.6992 476	3.20	(- 5) 4.0297 636	3.70	(- 6) 1.2792 741
2.21	(- 3) 8.5372 378	2.71	(- 4) 7.2937 850	3.21	(- 5) 3.7795 604	3.71	(- 6) 1.1879 068
2.22	(- 3) 8.1672 930	2.72	(- 4) 6.9082 932	3.22	(- 5) 3.5441 831	3.72	(- 6) 1.1028 445
2.23	(- 3) 7.8118 164	2.73	(- 4) 6.5418 671	3.23	(- 5) 3.3227 997	3.73	(- 6) 1.0236 686
2.24	(- 3) 7.4703 176	2.74	(- 4) 6.1936 378	3.24	(- 5) 3.1146 217	3.74	(- 7) 9.4998 679
2.25	(- 3) 7.1423 190	2.75	(- 4) 5.8627 725	3.25	(- 5) 2.9189 025	3.75	(- 7) 8.8143 219
2.26	(- 3) 6.8273 562	2.76	(- 4) 5.5484 722	3.26	(- 5) 2.7349 351	3.76	(- 7) 8.1766 120
2.27	(- 3) 6.5249 776	2.77	(- 4) 5.2499 713	3.27	(- 5) 2.5620 500	3.77	(- 7) 7.5835 232
2.28	(- 3) 6.2347 440	2.78	(- 4) 4.9665 360	3.28	(- 5) 2.3996 135	3.78	(- 7) 7.0320 473
2.29	(- 3) 5.9562 287	2.79	(- 4) 4.6974 632	3.29	(- 5) 2.2470 263	3.79	(- 7) 6.5193 709
2.30	(- 3) 5.6890 172	2.80	(- 4) 4.4420 794	3.30	(- 5) 2.1037 210	3.80	(- 7) 6.0428 629
2.31	(- 3) 5.4327 069	2.81	(- 4) 4.1997 400	3.31	(- 5) 1.9691 613	3.81	(- 7) 5.6000 632
2.32	(- 3) 5.1869 067	2.82	(- 4) 3.9698 274	3.32	(- 5) 1.8428 397	3.82	(- 7) 5.1886 725
2.33	(- 3) 4.9512 374	2.83	(- 4) 3.7517 508	3.33	(- 5) 1.7242 768	3.83	(- 7) 4.8065 419
2.34	(- 3) 4.7253 306	2.84	(- 4) 3.5449 449	3.34	(- 5) 1.6130 192	3.84	(- 7) 4.4516 637
2.35	(- 3) 4.5088 292	2.85	(- 4) 3.3488 688	3.35	(- 5) 1.5086 387	3.85	(- 7) 4.1221 624
2.36	(- 3) 4.3013 869	2.86	(- 4) 3.1630 053	3.36	(- 5) 1.4107 306	3.86	(- 7) 3.8162 867
2.37	(- 3) 4.1026 681	2.87	(- 4) 2.9868 598	3.37	(- 5) 1.3189 127	3.87	(- 7) 3.5324 013
2.38	(- 3) 3.9123 473	2.88	(- 4) 2.8199 597	3.38	(- 5) 1.2328 243	3.88	(- 7) 3.2689 796
2.39	(- 3) 3.7301 092	2.89	(- 4) 2.6618 533	3.39	(- 5) 1.1521 246	3.89	(- 7) 3.0245 971
2.40	(- 3) 3.5556 487	2.90	(- 4) 2.5121 089	3.40	(- 5) 1.0764 921	3.90	(- 7) 2.7979 245
2.41	(- 3) 3.3886 700	2.91	(- 4) 2.3703 144	3.41	(- 5) 1.0056 235	3.91	(- 7) 2.5877 218
2.42	(- 3) 3.2288 871	2.92	(- 4) 2.2360 761	3.42	(- 6) 9.3923 243	3.92	(- 7) 2.3928 327
2.43	(- 3) 3.0760 230	2.93	(- 4) 2.1090 184	3.43	(- 6) 8.7704 910	3.93	(- 7) 2.2121 788
2.44	(- 3) 2.9298 098	2.94	(- 4) 1.9887 824	3.44	(- 6) 8.1881 894	3.94	(- 7) 2.0447 548
2.45	(- 3) 2.7899 886	2.95	(- 4) 1.8750 262	3.45	(- 6) 7.6430 199	3.95	(- 7) 1.8896 240
2.46	(- 3) 2.6563 089	2.96	(- 4) 1.7674 231	3.46	(- 6) 7.1327 211	3.96	(- 7) 1.7459 135
2.47	(- 3) 2.5285 285	2.97	(- 4) 1.6656 619	3.47	(- 6) 6.6551 620	3.97	(- 7) 1.6128 098
2.48	(- 3) 2.4064 136	2.98	(- 4) 1.5694 459	3.48	(- 6) 6.2083 353	3.98	(- 7) 1.4895 557
2.49	(- 3) 2.2897 383	2.99	(- 4) 1.4784 919	3.49	(- 6) 5.7903 503	3.99	(- 7) 1.3754 458
2.50	(- 3) 2.1782 842	3.00	(- 4) 1.3925 305	3.50	(- 6) 5.3994 268	4.00	(- 7) 1.2698 235

$$\frac{\sqrt{\pi}}{2} = 0.88622 69255$$

DERIVATIVE OF THE ERROR FUNCTION

Table 7.2

x	$\frac{2}{\sqrt{\pi}} e^{-x^2}$	x	$\frac{2}{\sqrt{\pi}} e^{-x^2}$	x	$\frac{2}{\sqrt{\pi}} e^{-x^2}$	x	$\frac{2}{\sqrt{\pi}} e^{-x^2}$
4.00	(- 7) 1.2698 235	4.50	(- 9) 1.8113 059	5.00	(-11) 1.5670 866	5.50	(-14) 8.2233 160
4.01	(- 7) 1.1720 776	4.51	(- 9) 1.6552 434	5.01	(-11) 1.4178 169	5.51	(-14) 7.3659 906
4.02	(- 7) 1.0816 394	4.52	(- 9) 1.5123 248	5.02	(-11) 1.2825 089	5.52	(-14) 6.5967 265
4.03	(- 8) 9.9797 993	4.53	(- 9) 1.3814 699	5.03	(-11) 1.1598 820	5.53	(-14) 5.9066 187
4.04	(- 8) 9.2060 694	4.54	(- 9) 1.2616 849	5.04	(-11) 1.0487 702	5.54	(-14) 5.2876 480
4.05	(- 8) 8.4906 281	4.55	(- 9) 1.1520 559	5.05	(-12) 9.4811 285	5.55	(-14) 4.7325 943
4.06	(- 8) 7.8292 207	4.56	(- 9) 1.0517 423	5.06	(-12) 8.5694 483	5.56	(-14) 4.2349 585
4.07	(- 8) 7.2178 923	4.57	(-10) 9.5997 127	5.07	(-12) 7.7438 839	5.57	(-14) 3.7888 917
4.08	(- 8) 6.6529 674	4.58	(-10) 8.7603 264	5.08	(-12) 6.9964 533	5.58	(-14) 3.3891 310
4.09	(- 8) 6.1310 313	4.59	(-10) 7.9927 363	5.09	(-12) 6.3198 998	5.59	(-14) 3.0309 422
4.10	(- 8) 5.6489 121	4.60	(-10) 7.2909 450	5.10	(-12) 5.7076 270	5.60	(-14) 2.7100 675
4.11	(- 8) 5.2036 639	4.61	(-10) 6.6494 435	5.11	(-12) 5.1536 405	5.61	(-14) 2.4226 780
4.12	(- 8) 4.7925 517	4.62	(-10) 6.0631 724	5.12	(-12) 4.6524 937	5.62	(-14) 2.1653 317
4.13	(- 8) 4.4130 364	4.63	(-10) 5.5274 864	5.13	(-12) 4.1992 391	5.63	(-14) 1.9349 346
4.14	(- 8) 4.0627 618	4.64	(-10) 5.0381 209	5.14	(-12) 3.7893 835	5.64	(-14) 1.7287 067
4.15	(- 8) 3.7395 414	4.65	(-10) 4.5911 621	5.15	(-12) 3.4188 470	5.65	(-14) 1.5441 499
4.16	(- 8) 3.4413 471	4.66	(-10) 4.1830 187	5.16	(-12) 3.0839 257	5.66	(-14) 1.3790 206
4.17	(- 8) 3.1662 977	4.67	(-10) 3.8103 962	5.17	(-12) 2.7812 580	5.67	(-14) 1.2313 037
4.18	(- 8) 2.9126 490	4.68	(-10) 3.4702 727	5.18	(-12) 2.5077 937	5.68	(-14) 1.0991 900
4.19	(- 8) 2.6787 841	4.69	(-10) 3.1598 772	5.19	(-12) 2.2607 652	5.69	(-15) 9.8105 529
4.20	(- 8) 2.4632 041	4.70	(-10) 2.8766 694	5.20	(-12) 2.0376 626	5.70	(-15) 8.7544 193
4.21	(- 8) 2.2645 204	4.71	(-10) 2.6183 207	5.21	(-12) 1.8362 094	5.71	(-15) 7.8104 192
4.22	(- 8) 2.0814 463	4.72	(-10) 2.3826 973	5.22	(-12) 1.6543 420	5.72	(-15) 6.9668 183
4.23	(- 8) 1.9127 901	4.73	(-10) 2.1678 441	5.23	(-12) 1.4901 896	5.73	(-15) 6.2130 917
4.24	(- 8) 1.7574 484	4.74	(-10) 1.9719 702	5.24	(-12) 1.3420 568	5.74	(-15) 5.5398 013
4.25	(- 8) 1.6143 994	4.75	(-10) 1.7934 357	5.25	(-12) 1.2084 075	5.75	(-15) 4.9384 851
4.26	(- 8) 1.4826 974	4.76	(-10) 1.6307 388	5.26	(-12) 1.0878 501	5.76	(-15) 4.4015 583
4.27	(- 8) 1.3614 673	4.77	(-10) 1.4825 049	5.27	(-13) 9.7912 433	5.77	(-15) 3.9222 232
4.28	(- 8) 1.2498 993	4.78	(-10) 1.3474 759	5.28	(-13) 8.8108 899	5.78	(-15) 3.4943 893
4.29	(- 8) 1.1472 445	4.79	(-10) 1.2245 007	5.29	(-13) 7.9271 093	5.79	(-15) 3.1126 008
4.30	(- 8) 1.0528 102	4.80	(-10) 1.1125 261	5.30	(-13) 7.1305 505	5.80	(-15) 2.7719 710
4.31	(- 9) 9.6595 598	4.81	(-10) 1.0105 888	5.31	(-13) 6.4127 516	5.81	(-15) 2.4681 247
4.32	(- 9) 8.8608 977	4.82	(-11) 9.1780 821	5.32	(-13) 5.7660 568	5.82	(-15) 2.1971 447
4.33	(- 9) 8.1266 442	4.83	(-11) 8.3337 894	5.33	(-13) 5.1835 412	5.83	(-15) 1.9555 249
4.34	(- 9) 7.4517 438	4.84	(-11) 7.5656 500	5.34	(-13) 4.6589 423	5.84	(-15) 1.7401 279
4.35	(- 9) 6.8315 260	4.85	(-11) 6.8669 377	5.35	(-13) 4.1865 979	5.85	(-15) 1.5481 468
4.36	(- 9) 6.2616 772	4.86	(-11) 6.2315 074	5.36	(-13) 3.7613 895	5.86	(-15) 1.3770 708
4.37	(- 9) 5.7382 144	4.87	(-11) 5.6537 456	5.37	(-13) 3.3786 913	5.87	(-15) 1.2246 543
4.38	(- 9) 5.2574 603	4.88	(-11) 5.1285 259	5.38	(-13) 3.0343 233	5.88	(-15) 1.0888 898
4.39	(- 9) 4.8160 210	4.89	(-11) 4.6511 675	5.39	(-13) 2.7245 096	5.89	(-16) 9.6798 241
4.40	(- 9) 4.4107 647	4.90	(-11) 4.2173 976	5.40	(-13) 2.4458 396	5.90	(-16) 8.6032 817
4.41	(- 9) 4.0388 018	4.91	(-11) 3.8233 166	5.41	(-13) 2.1952 336	5.91	(-16) 7.6449 380
4.42	(- 9) 3.6974 673	4.92	(-11) 3.4653 660	5.42	(-13) 1.9699 112	5.92	(-16) 6.7919 883
4.43	(- 9) 3.3843 033	4.93	(-11) 3.1402 998	5.43	(-13) 1.7673 627	5.93	(-16) 6.0329 959
4.44	(- 9) 3.0970 439	4.94	(-11) 2.8451 570	5.44	(-13) 1.5853 234	5.94	(-16) 5.3577 479
4.45	(- 9) 2.8336 002	4.95	(-11) 2.5772 379	5.45	(-13) 1.4217 499	5.95	(-16) 4.7571 261
4.46	(- 9) 2.5920 474	4.96	(-11) 2.3340 811	5.46	(-13) 1.2747 989	5.96	(-16) 4.2229 913
4.47	(- 9) 2.3706 118	4.97	(-11) 2.1134 428	5.47	(-13) 1.1428 081	5.97	(-16) 3.7480 801
4.48	(- 9) 2.1676 596	4.98	(-11) 1.9132 785	5.48	(-13) 1.0242 785	5.98	(-16) 3.3259 113
4.49	(- 9) 1.9816 862	4.99	(-11) 1.7317 254	5.49	(-14) 9.1785 895	5.99	(-16) 2.9507 038
4.50	(- 9) 1.8113 059	5.00	(-11) 1.5670 866	5.50	(-14) 8.2233 160	6.00	(-16) 2.6173 012

$$\frac{\sqrt{\pi}}{2} = 0.88622 69255$$

Table 7.2

DERIVATIVE OF THE ERROR FUNCTION

x	$\frac{2}{\sqrt{\pi}} e^{-x^2}$	x	$\frac{2}{\sqrt{\pi}} e^{-x^2}$	x	$\frac{2}{\sqrt{\pi}} e^{-x^2}$	x	$\frac{2}{\sqrt{\pi}} e^{-x^2}$
6.00	(-16) 2.6173 012	6.50	(-19) 5.0525 800	7.00	(-22) 5.9159 630	7.50	(-25) 4.2013 654
6.01	(-16) 2.3211 058	6.51	(-19) 4.4362 038	7.01	(-22) 5.1425 768	7.51	(-25) 3.6157 871
6.02	(-16) 2.0580 187	6.52	(-19) 3.8942 418	7.02	(-22) 4.4694 005	7.52	(-25) 3.1112 033
6.03	(-16) 1.8243 864	6.53	(-19) 3.4178 066	7.03	(-22) 3.8835 679	7.53	(-25) 2.6764 989
6.04	(-16) 1.6169 533	6.54	(-19) 2.9990 603	7.04	(-22) 3.3738 492	7.54	(-25) 2.3020 719
6.05	(-16) 1.4328 188	6.55	(-19) 2.6310 921	7.05	(-22) 2.9304 450	7.55	(-25) 1.9796 292
6.06	(-16) 1.2693 992	6.56	(-19) 2.3078 100	7.06	(-22) 2.5448 057	7.56	(-25) 1.7020 094
6.07	(-16) 1.1243 934	6.57	(-19) 2.0238 447	7.07	(-22) 2.2094 736	7.57	(-25) 1.4630 299
6.08	(-17) 9.9575 277	6.58	(-19) 1.7744 651	7.08	(-22) 1.9179 450	7.58	(-25) 1.2573 541
6.09	(-17) 8.8165 340	6.59	(-19) 1.5555 031	7.09	(-22) 1.6645 491	7.59	(-25) 1.0803 765
6.10	(-17) 7.8047 211	6.60	(-19) 1.3632 874	7.10	(-22) 1.4443 426	7.60	(-26) 9.2812 353
6.11	(-17) 6.9076 453	6.61	(-19) 1.1945 852	7.11	(-22) 1.2530 171	7.61	(-26) 7.9716 752
6.12	(-17) 6.1124 570	6.62	(-19) 1.0465 500	7.12	(-22) 1.0868 181	7.62	(-26) 6.8455 216
6.13	(-17) 5.4077 268	6.63	(-20) 9.1667 618	7.13	(-23) 9.4247 516	7.63	(-26) 5.8772 834
6.14	(-17) 4.7832 911	6.64	(-20) 8.0275 879	7.14	(-23) 8.1713 928	7.64	(-26) 5.0449 849
6.15	(-17) 4.2301 135	6.65	(-20) 7.0285 758	7.15	(-23) 7.0832 963	7.65	(-26) 4.3296 844
6.16	(-17) 3.7401 616	6.66	(-20) 6.1526 575	7.16	(-23) 6.1388 620	7.66	(-26) 3.7150 594
6.17	(-17) 3.3062 970	6.67	(-20) 5.3848 212	7.17	(-23) 5.3192 876	7.67	(-26) 3.1870 466
6.18	(-17) 2.9221 768	6.68	(-20) 4.7118 664	7.18	(-23) 4.6082 095	7.68	(-26) 2.7335 323
6.19	(-17) 2.5821 666	6.69	(-20) 4.1221 880	7.19	(-23) 3.9913 893	7.69	(-26) 2.3440 839
6.20	(-17) 2.2812 620	6.70	(-20) 3.6055 852	7.20	(-23) 3.4564 408	7.70	(-26) 2.0097 185
6.21	(-17) 2.0150 194	6.71	(-20) 3.1530 937	7.21	(-23) 2.9925 904	7.71	(-26) 1.7227 031
6.22	(-17) 1.7794 936	6.72	(-20) 2.7568 372	7.22	(-23) 2.5904 701	7.72	(-26) 1.4763 822
6.23	(-17) 1.5711 830	6.73	(-20) 2.4098 972	7.23	(-23) 2.2419 351	7.73	(-26) 1.2650 285
6.24	(-17) 1.3869 801	6.74	(-20) 2.1061 973	7.24	(-23) 1.9399 057	7.74	(-26) 1.0837 147
6.25	(-17) 1.2241 281	6.75	(-20) 1.8404 021	7.25	(-23) 1.6782 295	7.75	(-27) 9.2820 251
6.26	(-17) 1.0801 812	6.76	(-20) 1.6078 278	7.26	(-23) 1.4515 608	7.76	(-27) 7.9484 723
6.27	(-18) 9.5297 064	6.77	(-20) 1.4043 634	7.27	(-23) 1.2552 558	7.77	(-27) 6.8051 505
6.28	(-18) 8.4057 325	6.78	(-20) 1.2264 013	7.28	(-23) 1.0852 815	7.78	(-27) 5.8251 209
6.29	(-18) 7.4128 421	6.79	(-20) 1.0707 765	7.29	(-24) 9.3813 574	7.79	(-27) 4.9852 310
6.30	(-18) 6.5359 252	6.80	(-21) 9.3471 286	7.30	(-24) 8.1077 830	7.80	(-27) 4.2655 868
6.31	(-18) 5.7615 925	6.81	(-21) 8.1577 565	7.31	(-24) 7.0057 026	7.81	(-27) 3.6490 970
6.32	(-18) 5.0779 819	6.82	(-21) 7.1183 018	7.32	(-24) 6.0522 159	7.82	(-27) 3.1210 820
6.33	(-18) 4.4745 863	6.83	(-21) 6.2100 515	7.33	(-24) 5.2274 546	7.83	(-27) 2.6689 356
6.34	(-18) 3.9421 013	6.84	(-21) 5.4166 048	7.34	(-24) 4.5141 841	7.84	(-27) 2.2818 346
6.35	(-18) 3.4722 886	6.85	(-21) 4.7235 904	7.35	(-24) 3.8974 577	7.85	(-27) 1.9504 883
6.36	(-18) 3.0578 557	6.86	(-21) 4.1184 183	7.36	(-24) 3.3643 153	7.86	(-27) 1.6669 236
6.37	(-18) 2.6923 486	6.87	(-21) 3.5900 610	7.37	(-24) 2.9035 220	7.87	(-27) 1.4242 990
6.38	(-18) 2.3700 568	6.88	(-21) 3.1288 615	7.38	(-24) 2.5053 400	7.88	(-27) 1.2167 456
6.39	(-18) 2.0859 281	6.89	(-21) 2.7263 649	7.39	(-24) 2.1613 315	7.89	(-27) 1.0392 297
6.40	(-18) 1.8354 945	6.90	(-21) 2.3751 704	7.40	(-24) 1.8641 859	7.90	(-28) 8.8743 478
6.41	(-18) 1.6148 045	6.91	(-21) 2.0688 010	7.41	(-24) 1.6075 712	7.91	(-28) 7.5766 022
6.42	(-18) 1.4203 650	6.92	(-21) 1.8015 892	7.42	(-24) 1.3860 036	7.92	(-28) 6.4673 396
6.43	(-18) 1.2490 883	6.93	(-21) 1.5685 776	7.43	(-24) 1.1947 351	7.93	(-28) 5.5193 762
6.44	(-18) 1.0982 455	6.94	(-21) 1.3654 297	7.44	(-24) 1.0296 557	7.94	(-28) 4.7094 204
6.45	(-19) 9.6542 574	6.95	(-21) 1.1883 540	7.45	(-25) 8.8720 826	7.95	(-28) 4.0175 202
6.46	(-19) 8.4849 924	6.96	(-21) 1.0340 356	7.46	(-25) 7.6431 480	7.96	(-28) 3.4265 874
6.47	(-19) 7.4558 503	6.97	(-22) 8.9957 684	7.47	(-25) 6.5831 250	7.97	(-28) 2.9219 899
6.48	(-19) 6.5502 224	6.98	(-22) 7.8244 565	7.48	(-25) 5.6689 820	7.98	(-28) 2.4912 008
6.49	(-19) 5.7534 461	6.99	(-22) 6.8042 967	7.49	(-25) 4.8808 021	7.99	(-28) 2.1234 982
6.50	(-19) 5.0525 800	7.00	(-22) 5.9159 630	7.50	(-25) 4.2013 654	8.00	(-28) 1.8097 068

$$\frac{\sqrt{\pi}}{2} = 0.88622 69255$$

DERIVATIVE OF THE ERROR FUNCTION

Table 7.2

x	$\frac{2}{\sqrt{\pi}} e^{-x^2}$	x	$\frac{2}{\sqrt{\pi}} e^{-x^2}$	x	$\frac{2}{\sqrt{\pi}} e^{-x^2}$	x	$\frac{2}{\sqrt{\pi}} e^{-x^2}$
8.00	(-28) 1.8097 068	8.50	(-32) 4.7280 139	9.00	(-36) 7.4920 734	9.50	(-40) 7.2007 555
8.01	(-28) 1.5419 762	8.51	(-32) 3.9884 601	9.01	(-36) 6.2572 800	9.51	(-40) 5.9541 351
8.02	(-28) 1.3135 913	8.52	(-32) 3.3639 141	9.02	(-36) 5.2249 519	9.52	(-40) 4.9223 495
8.03	(-28) 1.1188 091	8.53	(-32) 2.8365 973	9.03	(-36) 4.3620 651	9.53	(-40) 4.0685 471
8.04	(-29) 9.5271 911	8.54	(-32) 2.3914 628	9.04	(-36) 3.6409 535	9.54	(-40) 3.3621 678
8.05	(-29) 8.1112 334	8.55	(-32) 2.0157 780	9.05	(-36) 3.0384 441	9.55	(-40) 2.7778 742
8.06	(-29) 6.9043 382	8.56	(-32) 1.6987 713	9.06	(-36) 2.5351 317	9.56	(-40) 2.2946 629
8.07	(-29) 5.8758 453	8.57	(-32) 1.4313 316	9.07	(-36) 2.1147 690	9.57	(-40) 1.8951 272
8.08	(-29) 4.9995 601	8.58	(-32) 1.2057 541	9.08	(-36) 1.7637 559	9.58	(-40) 1.5648 437
8.09	(-29) 4.2531 077	8.59	(-32) 1.0155 245	9.09	(-36) 1.4707 105	9.59	(-40) 1.2918 638
8.10	(-29) 3.6173 797	8.60	(-33) 8.5513 598	9.10	(-36) 1.2261 088	9.60	(-40) 1.0662 907
8.11	(-29) 3.0760 612	8.61	(-33) 7.1993 468	9.11	(-36) 1.0219 837	9.61	(-41) 8.7992 901
8.12	(-29) 2.6152 245	8.62	(-33) 6.0598 819	9.12	(-37) 8.5167 148	9.62	(-41) 7.2599 363
8.13	(-29) 2.2229 829	8.63	(-33) 5.0997 438	9.13	(-37) 7.0959 960	9.63	(-41) 5.9886 802
8.14	(-29) 1.8891 933	8.64	(-33) 4.2908 734	9.14	(-37) 5.9110 925	9.64	(-41) 4.9390 403
8.15	(-29) 1.6052 025	8.65	(-33) 3.6095 760	9.15	(-37) 4.9230 619	9.65	(-41) 4.0725 570
8.16	(-29) 1.3636 296	8.66	(-33) 3.0358 465	9.16	(-37) 4.0993 592	9.66	(-41) 3.3574 141
8.17	(-29) 1.1581 801	8.67	(-33) 2.5527 988	9.17	(-37) 3.4127 918	9.67	(-41) 2.7672 971
8.18	(-30) 9.8348 778	8.68	(-33) 2.1461 817	9.18	(-37) 2.8406 437	9.68	(-41) 2.2804 460
8.19	(-30) 8.3497 786	8.69	(-33) 1.8039 709	9.19	(-37) 2.3639 423	9.69	(-41) 1.8788 710
8.20	(-30) 7.0875 167	8.70	(-33) 1.5160 228	9.20	(-37) 1.9668 449	9.70	(-41) 1.5477 017
8.21	(-30) 6.0148 717	8.71	(-33) 1.2737 818	9.21	(-37) 1.6361 251	9.71	(-41) 1.2746 493
8.22	(-30) 5.1035 431	8.72	(-33) 1.0700 339	9.22	(-37) 1.3607 427	9.72	(-41) 1.0495 600
8.23	(-30) 4.3294 262	8.73	(-34) 8.9869 668	9.23	(-37) 1.1314 847	9.73	(-42) 8.6404 628
8.24	(-30) 3.6719 947	8.74	(-34) 7.5464 360	9.24	(-38) 9.4066 395	9.74	(-42) 7.1118 055
8.25	(-30) 3.1137 725	8.75	(-34) 6.3355 422	9.25	(-38) 7.8186 802	9.75	(-42) 5.8524 252
8.26	(-30) 2.6398 841	8.76	(-34) 5.3178 836	9.26	(-38) 6.4974 888	9.76	(-42) 4.8150 968
8.27	(-30) 2.2376 697	8.77	(-34) 4.4627 957	9.27	(-38) 5.3984 710	9.77	(-42) 3.9608 401
8.28	(-30) 1.8963 577	8.78	(-34) 3.7444 525	9.28	(-38) 4.4844 496	9.78	(-42) 3.2574 873
8.29	(-30) 1.6067 846	8.79	(-34) 3.1411 074	9.29	(-38) 3.7244 373	9.79	(-42) 2.6784 979
8.30	(-30) 1.3611 569	8.80	(-34) 2.6344 525	9.30	(-38) 3.0926 112	9.80	(-42) 2.2019 782
8.31	(-30) 1.1528 476	8.81	(-34) 2.2090 784	9.31	(-38) 2.5674 566	9.81	(-42) 1.8098 720
8.32	(-31) 9.7622 228	8.82	(-34) 1.8520 172	9.32	(-38) 2.1310 520	9.82	(-42) 1.4872 907
8.33	(-31) 8.2649 206	8.83	(-34) 1.5523 585	9.33	(-38) 1.7684 718	9.83	(-42) 1.2219 600
8.34	(-31) 6.9958 710	8.84	(-34) 1.3009 248	9.34	(-38) 1.4672 880	9.84	(-42) 1.0037 632
8.35	(-31) 5.9204 954	8.85	(-34) 1.0899 975	9.35	(-38) 1.2171 545	9.85	(-43) 8.2436 338
8.36	(-31) 5.0094 199	8.86	(-35) 9.1308 655	9.36	(-38) 1.0094 602	9.86	(-43) 6.7689 179
8.37	(-31) 4.2376 977	8.87	(-35) 7.6473 600	9.37	(-39) 8.3703 932	9.87	(-43) 5.5569 047
8.38	(-31) 3.5841 456	8.88	(-35) 6.4036 010	9.38	(-39) 6.9392 997	9.88	(-43) 4.5609 970
8.39	(-31) 3.0307 803	8.89	(-35) 5.3610 534	9.39	(-39) 5.7517 311	9.89	(-43) 3.7428 271
8.40	(-31) 2.5623 380	8.90	(-35) 4.4873 418	9.40	(-39) 4.7664 456	9.90	(-43) 3.0708 096
8.41	(-31) 2.1658 657	8.91	(-35) 3.7552 711	9.41	(-39) 3.9491 520	9.91	(-43) 2.5189 477
8.42	(-31) 1.8303 736	8.92	(-35) 3.1420 030	9.42	(-39) 3.2713 439	9.92	(-43) 2.0658 489
8.43	(-31) 1.5465 399	8.93	(-35) 2.6283 611	9.43	(-39) 2.7093 286	9.93	(-43) 1.6939 130
8.44	(-31) 1.3064 586	8.94	(-35) 2.1982 476	9.44	(-39) 2.2434 186	9.94	(-43) 1.3886 628
8.45	(-31) 1.1034 263	8.95	(-35) 1.8381 516	9.45	(-39) 1.8572 574	9.95	(-43) 1.1381 922
8.46	(-32) 9.3176 012	8.96	(-35) 1.5367 357	9.46	(-39) 1.5372 589	9.96	(-44) 9.3271 204
8.47	(-32) 7.8664 369	8.97	(-35) 1.2844 884	9.47	(-39) 1.2721 404	9.97	(-44) 7.6417 477
8.48	(-32) 6.6399 552	8.98	(-35) 1.0734 315	9.48	(-39) 1.0525 343	9.98	(-44) 6.2596 629
8.49	(-32) 5.6035 774	8.99	(-36) 8.9687 435	9.49	(-40) 8.7066 400	9.99	(-44) 5.1265 162
8.50	(-32) 4.7280 139	9.00	(-36) 7.4920 734	9.50	(-40) 7.2007 555	10.00	(-44) 4.1976 562

$$\frac{\sqrt{\pi}}{2} = 0.88622\ 69255$$

Table 7.3

COMPLEMENTARY ERROR FUNCTION

x^{-2}	$xe^{x^2} \operatorname{erfc} x$	$\langle x \rangle$	x^{-2}	$xe^{x^2} \operatorname{erfc} x$	$\langle x \rangle$
0.250	0.51079 14	2	0.125	0.53406 72	3
0.245	0.51163 07	2	0.120	0.53511 47	3
0.240	0.51247 67	2	0.115	0.53617 29	3
0.235	0.51332 94	2	0.110	0.53724 20	3
0.230	0.51418 90	2	0.105	0.53832 23	3
0.225	0.51505 55	2	0.100	0.53941 41	3
0.220	0.51592 92	2	0.095	0.54051 76	3
0.215	0.51681 01	2	0.090	0.54163 32	3
0.210	0.51769 83	2	0.085	0.54276 11	3
0.205	0.51859 40	2	0.080	0.54390 16	4
0.200	0.51949 74	2	0.075	0.54505 51	4
0.195	0.52040 85	2	0.070	0.54622 19	4
0.190	0.52132 75	2	0.065	0.54740 24	4
0.185	0.52225 45	2	0.060	0.54859 69	4
0.180	0.52318 98	2	0.055	0.54980 58	4
0.175	0.52413 33	2	0.050	0.55102 95	4
0.170	0.52508 55	2	0.045	0.55226 85	5
0.165	0.52604 63	2	0.040	0.55352 32	5
0.160	0.52701 59	3	0.035	0.55479 41	5
0.155	0.52799 46	3	0.030	0.55608 17	6
0.150	0.52898 25	3	0.025	0.55738 65	6
0.145	0.52997 98	3	0.020	0.55870 90	7
0.140	0.53098 67	3	0.015	0.56005 00	8
0.135	0.53200 35	3	0.010	0.56140 99	10
0.130	0.53303 02	3	0.005	0.56278 96	14
0.125	0.53406 72	3	0.000	0.56418 96	∞
	$\left[\begin{smallmatrix} (-6)1 \\ 3 \end{smallmatrix} \right]$			$\left[\begin{smallmatrix} (-6)3 \\ 3 \end{smallmatrix} \right]$	

See Example 2.

$\langle x \rangle$ = nearest integer to x .

n	$\operatorname{erfc} \sqrt{n\pi}$	n	$\operatorname{erfc} \sqrt{n\pi}$
1	0.01218 88821 84803	6	0.00000 00008 25422
2	0.00039 27505 88282	7	0.00000 00000 33136
3	0.00001 41444 02689	8	0.00000 00000 01343
4	0.00000 05351 64662	9	0.00000 00000 00055
5	0.00000 00208 26552	10	0.00000 00000 00002

$$\operatorname{erfc} x = \frac{2}{\sqrt{\pi}} \int_x^\infty e^{-t^2} dt = 1 - \operatorname{erf} x$$

$\operatorname{erfc} \sqrt{n\pi}$ compiled from O. Emersleben, Numerische Werte des Fehlerintegrals für $\sqrt{n\pi}$, Z. Angew. Math. Mech. 31, 393-394, 1951 (with permission).

REPEATED INTEGRALS OF THE ERROR FUNCTION

Table 7.4

x	$2^n \Gamma\left(\frac{n}{2}+1\right) i^n \operatorname{erfc} x$			
	$n=1$	$n=2$	$n=3$	$n=4$
0.0	1.00000	1.00000	1.00000	1.00000
0.1	(-1) 8.32738	(-1) 7.93573	(-1) 7.62409	(-1) 7.36220
0.2	(-1) 6.85245	(-1) 6.22654	(-1) 5.74882	(-1) 5.36163
0.3	(-1) 5.56938	(-1) 4.82842	(-1) 4.28565	(-1) 3.86125
0.4	(-1) 4.46884	(-1) 3.69906	(-1) 3.15756	(-1) 2.74894
0.5	(-1) 3.53855	(-1) 2.79859	(-1) 2.29846	(-1) 1.93408
0.6	(-1) 2.76388	(-1) 2.09021	(-1) 1.65244	(-1) 1.34438
0.7	(-1) 2.12869	(-1) 1.54061	(-1) 1.17295	(-2) 9.22962
0.8	(-1) 1.61601	(-1) 1.12021	(-2) 8.21802	(-2) 6.25650
0.9	(-1) 1.20884	(-2) 8.03288	(-2) 5.68138	(-2) 4.18643
1.0	(-2) 8.90739	(-2) 5.67901	(-2) 3.87449	(-2) 2.76442
1.1	(-2) 6.46332	(-2) 3.95711	(-2) 2.60573	(-2) 1.80092
1.2	(-2) 4.61706	(-2) 2.71686	(-2) 1.72776	(-2) 1.15720
1.3	(-2) 3.24613	(-2) 1.83748	(-2) 1.12918	(-3) 7.33229
1.4	(-2) 2.24570	(-2) 1.22388	(-3) 7.27211	(-3) 4.58017
1.5	(-2) 1.52836	(-3) 8.02626	(-3) 4.61400	(-3) 2.81992
1.6	(-2) 1.02305	(-3) 5.18140	(-3) 2.88347	(-3) 1.71085
1.7	(-3) 6.73408	(-3) 3.29192	(-3) 1.77452	(-3) 1.02261
1.8	(-3) 4.35805	(-3) 2.05795	(-3) 1.07519	(-4) 6.02074
1.9	(-3) 2.77245	(-3) 1.26566	(-4) 6.41281	(-4) 3.49094
2.0	(-3) 1.73350	(-4) 7.65644	(-4) 3.76431	(-4) 1.99301
2.1	(-3) 1.06515	(-4) 4.55498	(-4) 2.17431	(-4) 1.12014
2.2	(-4) 6.43074	(-4) 2.66457	(-4) 1.23562	(-5) 6.19670
2.3	(-4) 3.81436	(-4) 1.53245	(-5) 6.90731	(-5) 3.37364
2.4	(-4) 2.2250	(-5) 8.66372	(-5) 3.79773	(-5) 1.80727
2.5	(-4) 1.27195	(-5) 4.81417	(-5) 2.05339	(-6) 9.52500
2.6	(-5) 7.14929	(-5) 2.62896	(-5) 1.09167	(-6) 4.93818
2.7	(-5) 3.94619	(-5) 1.41072	(-6) 5.70591	(-6) 2.51807
2.8	(-5) 2.13882	(-6) 7.43784	(-6) 2.93172	(-6) 1.26274
2.9	(-5) 1.13820	(-6) 3.85260	(-6) 1.48058	(-7) 6.22654
3.0	(-6) 5.94664	(-6) 1.96029	(-7) 7.34867	(-7) 3.01870
3.1	(-6) 3.05003	(-7) 9.79725	(-7) 3.58429	(-7) 1.43874
3.2	(-6) 1.53562	(-7) 4.80916	(-7) 1.71780	(-8) 6.74044
3.3	(-7) 7.58899	(-7) 2.31835	(-8) 8.08871	(-8) 3.10379
3.4	(-7) 3.68109	(-7) 1.09748	(-8) 3.74180	(-8) 1.40460
3.5	(-7) 1.75241	(-8) 5.10148	(-8) 1.70036	(-9) 6.24636
3.6	(-8) 8.18726	(-8) 2.32831	(-9) 7.58967	(-9) 2.72947
3.7	(-8) 3.75373	(-8) 1.04329	(-9) 3.32733	(-9) 1.17184
3.8	(-8) 1.68883	(-9) 4.58945	(-9) 1.43260	(-10) 4.94271
3.9	(-9) 7.45575	(-9) 1.98190	(-10) 6.05736	(-10) 2.04800
4.0	(-9) 3.22966	(-10) 8.40124	(-10) 2.51501	(-11) 8.33554
4.1	(-9) 1.37267	(-10) 3.49560	(-10) 1.02533	(-11) 3.33230
4.2	(-10) 5.72405	(-10) 1.42757	(-11) 4.10427	(-11) 1.30837
4.3	(-10) 2.34181	(-11) 5.72196	(-11) 1.61297	(-12) 5.04508
4.4	(-11) 9.39929	(-11) 2.25085	(-12) 6.22316	(-12) 1.91041
4.5	(-11) 3.70102	(-12) 8.68930	(-12) 2.35705	(-13) 7.10366
4.6	(-11) 1.42960	(-12) 3.29184	(-13) 8.76348	(-13) 2.59364
4.7	(-12) 5.41708	(-12) 1.22375	(-13) 3.19826	(-14) 9.29786
4.8	(-12) 2.01353	(-13) 4.46407	(-13) 1.14567	(-14) 3.27252
4.9	(-13) 7.34149	(-13) 1.59785	(-14) 4.02809	(-14) 1.13080
5.0	(-13) 2.62561	(-14) 5.61169	(-14) 1.38998	(-15) 3.83592
				$\left[2^n \Gamma\left(\frac{n}{2}+1\right)\right]^{-1}$
	(-1) 5.64189 58355	(-1) 2.50000 00000	(-2) 9.40315 97258	(-2) 3.12500

See Examples 4 and 5.

Table 7.4

REPEATED INTEGRALS OF THE ERROR FUNCTION

	$2^n \Gamma\left(\frac{n}{2}+1\right) i^n \operatorname{erfc} x$			
x	$n=5$	$n=6$	$n=10$	$n=11$
0.0	1.00000	1.00000	1.00000	1.00000
0.1	(-1)7.13475	(-1)6.93283	(-1)6.28971	(-1)6.15727
0.2	(-1)5.03608	(-1)4.75548	(-1)3.91490	(-1)3.75188
0.3	(-1)3.51572	(-1)3.22652	(-1)2.41089	(-1)2.26201
0.4	(-1)2.42671	(-1)2.16478	(-1)1.46861	(-1)1.34906
0.5	(-1)1.65569	(-1)1.43588	(-2)8.84744	(-2)7.95749
0.6	(-1)1.11630	(-2)9.41309	(-2)5.27007	(-2)4.64127
0.7	(-2)7.43528	(-2)6.09742	(-2)3.10323	(-2)2.67626
0.8	(-2)4.89121	(-2)3.90166	(-2)1.80600	(-2)1.52533
0.9	(-2)3.17704	(-2)2.46567	(-2)1.03859	(-3)8.59126
1.0	(-2)2.03707	(-2)1.53850	(-3)5.90062	(-3)4.78106
1.1	(-2)1.28901	(-3)9.47623	(-3)3.31130	(-3)2.62835
1.2	(-3)8.04765	(-3)5.76033	(-3)1.83510	(-3)1.42708
1.3	(-3)4.95614	(-3)3.45489	(-3)1.00415	(-4)7.65146
1.4	(-3)3.01008	(-3)2.04411	(-4)5.42413	(-4)4.05030
1.5	(-3)1.80252	(-3)1.19278	(-4)2.89186	(-4)2.11641
1.6	(-3)1.06403	(-4)6.86307	(-4)1.52145	(-4)1.09146
1.7	(-4)6.19032	(-4)3.89303	(-5)7.89765	(-5)5.55435
1.8	(-4)3.54870	(-4)2.17663	(-5)4.04407	(-5)2.78871
1.9	(-4)2.00419	(-4)1.19930	(-5)2.04244	(-5)1.38116
2.0	(-4)1.11492	(-5)6.51088	(-5)1.01722	(-6)6.74666
2.1	(-5)6.10810	(-5)3.48211	(-6)4.99509	(-6)3.24987
2.2	(-5)3.29497	(-5)1.83427	(-6)2.41807	(-6)1.54350
2.3	(-5)1.74988	(-6)9.51547	(-6)1.15378	(-7)7.22681
2.4	(-6)9.14767	(-6)4.86044	(-7)5.42553	(-7)3.33519
2.5	(-6)4.70641	(-6)2.44418	(-7)2.51397	(-7)1.51693
2.6	(-6)2.38278	(-6)1.20988	(-7)1.14766	(-8)6.79864
2.7	(-6)1.18695	(-7)5.89435	(-8)5.16116	(-8)3.00212
2.8	(-7)5.81672	(-7)2.82592	(-8)2.28612	(-8)1.30595
2.9	(-7)2.80391	(-7)1.33308	(-9)9.97266	(-9)5.59577
3.0	(-7)1.32935	(-8)6.18684	(-9)4.28380	(-9)2.36143
3.1	(-8)6.19798	(-8)2.82454	(-9)1.81176	(-10)9.81330
3.2	(-8)2.84151	(-8)1.26835	(-10)7.54345	(-10)4.01541
3.3	(-8)1.28082	(-9)5.60145	(-10)3.09165	(-10)1.61759
3.4	(-9)5.67576	(-9)2.43265	(-10)1.24712	(-11)6.41479
3.5	(-9)2.47236	(-9)1.03880	(-11)4.95086	(-11)2.50393
3.6	(-9)1.05855	(-10)4.36132	(-11)1.93401	(-12)9.61928
3.7	(-10)4.45435	(-10)1.80009	(-12)7.43354	(-12)3.63661
3.8	(-10)1.84200	(-11)7.30331	(-12)2.81094	(-12)1.35283
3.9	(-11)7.48503	(-11)2.91245	(-12)1.04564	(-13)4.95149
4.0	(-11)2.98854	(-11)1.14149	(-13)3.82601	(-13)1.78294
4.1	(-11)1.17234	(-12)4.39668	(-13)1.37691	(-14)6.31544
4.2	(-12)4.51802	(-12)1.66412	(-14)4.87328	(-14)2.20038
4.3	(-12)1.71044	(-13)6.18894	(-14)1.69612	(-15)7.54020
4.4	(-13)6.36069	(-13)2.26147	(-15)5.80461	(-15)2.54109
4.5	(-13)2.32332	(-14)8.11851	(-15)1.95316	(-16)8.42124
4.6	(-14)8.33482	(-14)2.86315	(-16)6.46126	(-16)2.74419
4.7	(-14)2.93656	(-15)9.91898	(-16)2.10125	(-17)8.79230
4.8	(-14)1.01604	(-15)3.37534	(-17)6.71719	(-17)2.76954
4.9	(-15)3.45215	(-15)1.12815	(-17)2.11065	(-18)8.57626
5.0	(-15)1.15173	(-16)3.70336	(-18)6.51829	(-18)2.61062
	$\left[2^n \Gamma\left(\frac{n}{2}+1\right)\right]^{-1}$			
	(-3)9.40315 97258	(-3)2.60416 66667	(-6)8.13802 08333	(-6)1.69609 66316

DAWSON'S INTEGRAL

Table 7.5

x	$e^{-x^2} \int_0^x e^{t^2} dt$	x	$e^{-x^2} \int_0^x e^{t^2} dt$	x^{-2}	$xe^{-x^2} \int_0^x e^{t^2} dt$	$\langle x \rangle$
0.00	0.00000 00000	1.00	0.53807 95069	0.250	0.60268 0777	2
0.02	0.01999 46675	1.02	0.53637 44359	0.245	0.60046 6027	2
0.04	0.03995 73606	1.04	0.53431 71471	0.240	0.59819 8606	2
0.06	0.05985 62071	1.06	0.53192 50787	0.235	0.59588 1008	2
0.08	0.07965 95389	1.08	0.52921 57454	0.230	0.59351 6018	2
0.10	0.09933 59924	1.10	0.52620 66800	0.225	0.59110 6724	2
0.12	0.11885 46083	1.12	0.52291 53777	0.220	0.58865 6517	2
0.14	0.13818 49287	1.14	0.51935 92435	0.215	0.58616 9107	2
0.16	0.15729 70920	1.16	0.51555 55409	0.210	0.58364 8516	2
0.18	0.17616 19254	1.18	0.51152 13448	0.205	0.58109 9080	2
0.20	0.19475 10334	1.20	0.50727 34964	0.200	0.57852 5444	2
0.22	0.21303 68833	1.22	0.50282 85611	0.195	0.57593 2550	2
0.24	0.23099 28865	1.24	0.49820 27897	0.190	0.57332 5618	2
0.26	0.24859 34747	1.26	0.49341 20827	0.185	0.57071 0126	2
0.28	0.26581 41727	1.28	0.48847 19572	0.180	0.56809 1778	2
0.30	0.28263 16650	1.30	0.48339 75174	0.175	0.56547 6462	2
0.32	0.29902 38575	1.32	0.47820 34278	0.170	0.56287 0205	2
0.34	0.31496 99336	1.34	0.47290 38898	0.165	0.56027 9114	2
0.36	0.33045 04051	1.36	0.46751 26208	0.160	0.55770 9305	2
0.38	0.34544 71562	1.38	0.46204 28368	0.155	0.55516 6829	3
0.40	0.35994 34819	1.40	0.45650 72375	0.150	0.55265 7582	3
0.42	0.37392 41210	1.42	0.45091 79943	0.145	0.55018 7208	3
0.44	0.38737 52812	1.44	0.44528 67410	0.140	0.54776 0994	3
0.46	0.40028 46599	1.46	0.43962 45670	0.135	0.54538 3766	3
0.48	0.41264 14572	1.48	0.43394 20135	0.130	0.54305 9774	3
0.50	0.42443 63835	1.50	0.42824 90711	0.125	0.54079 2591	3
0.52	0.43566 16609	1.52	0.42255 51804	0.120	0.53858 5013	3
0.54	0.44631 10184	1.54	0.41686 92347	0.115	0.53643 8983	3
0.56	0.45637 96813	1.56	0.41119 95842	0.110	0.53435 5529	3
0.58	0.46586 43551	1.58	0.40555 40424	0.105	0.53233 4747	3
0.60	0.47476 32037	1.60	0.39993 98943	0.100	0.53037 5810	3
0.62	0.48307 58219	1.62	0.39436 39058	0.095	0.52847 7031	3
0.64	0.49080 32040	1.64	0.38883 23346	0.090	0.52663 5967	3
0.66	0.49794 77064	1.66	0.38335 09429	0.085	0.52484 9575	3
0.68	0.50451 30066	1.68	0.37792 50103	0.080	0.52311 4393	4
0.70	0.51050 40576	1.70	0.37255 93490	0.075	0.52142 6749	4
0.72	0.51592 70382	1.72	0.36725 83182	0.070	0.51978 2972	4
0.74	0.52078 93010	1.74	0.36202 58410	0.065	0.51817 9571	4
0.76	0.52509 93152	1.76	0.35686 54206	0.060	0.51661 3369	4
0.78	0.52886 66089	1.78	0.35178 01580	0.055	0.51508 1573	4
0.80	0.53210 17071	1.80	0.34677 27691	0.050	0.51358 1788	4
0.82	0.53481 60684	1.82	0.34184 56029	0.045	0.51211 1971	5
0.84	0.53702 20202	1.84	0.33700 06597	0.040	0.51067 0372	5
0.86	0.53873 26921	1.86	0.33223 96091	0.035	0.50925 5466	5
0.88	0.53996 19480	1.88	0.32756 38080	0.030	0.50786 5903	6
0.90	0.54072 43187	1.90	0.32297 43193	0.025	0.50650 0473	6
0.92	0.54103 49328	1.92	0.31847 19293	0.020	0.50515 8078	7
0.94	0.54090 94485	1.94	0.31405 71655	0.015	0.50383 7717	8
0.96	0.54036 39857	1.96	0.30973 03141	0.010	0.50253 8471	10
0.98	0.53941 50580	1.98	0.30549 14372	0.005	0.50125 9494	14
1.00	0.53807 95069 $\left[\begin{smallmatrix} (-5)7 \\ 4 \end{smallmatrix} \right]$	2.00	0.30134 03889 $\left[\begin{smallmatrix} (-5)4 \\ 4 \end{smallmatrix} \right]$	0.000	0.50000 0000 $\left[\begin{smallmatrix} (-6)8 \\ 6 \end{smallmatrix} \right]$	∞

See Example 3.

$\langle x \rangle$ = nearest integer to x .

Compiled from J. B. Rosser, Theory and application of $\int_0^z e^{-x^2} dx$ and $\int_0^z e^{-p^2 y^2} dy \int_0^y e^{-x^2} dx$. Mapleton House, Brooklyn, N.Y., 1948; and B. Lohmander and S. Rittsten, Table of the function $y = e^{-x^2} \int_0^x e^{t^2} dt$, Kungl. Fysiogr. Sällsk. i Lund Förh. 28, 45-52, 1958 (with permission).

Table 7.6

$$\frac{3}{\Gamma\left(\frac{1}{3}\right)} \int_0^x e^{-t^3} dt$$

x	$\frac{3}{\Gamma\left(\frac{1}{3}\right)} \int_0^x e^{-t^3} dt$	x	$\frac{3}{\Gamma\left(\frac{1}{3}\right)} \int_0^x e^{-t^3} dt$	x	$\frac{3}{\Gamma\left(\frac{1}{3}\right)} \int_0^x e^{-t^3} dt$
0.00	0.00000 00	0.70	0.72276 69	1.40	0.98973 54
0.02	0.02239 69	0.72	0.73842 49	1.42	0.99109 36
0.04	0.04479 31	0.74	0.75360 34	1.44	0.99229 70
0.06	0.06718 72	0.76	0.76829 12	1.46	0.99335 97
0.08	0.08957 63	0.78	0.78247 88	1.48	0.99429 49
0.10	0.11195 67	0.80	0.79615 78	1.50	0.99511 49
0.12	0.13432 36	0.82	0.80932 16	1.52	0.99583 14
0.14	0.15667 11	0.84	0.82196 48	1.54	0.99645 52
0.16	0.17899 22	0.86	0.83408 41	1.56	0.99699 62
0.18	0.20127 90	0.88	0.84567 73	1.58	0.99746 38
0.20	0.22352 24	0.90	0.85674 42	1.60	0.99786 63
0.22	0.24571 24	0.92	0.86728 62	1.62	0.99821 16
0.24	0.26783 80	0.94	0.87730 62	1.64	0.99850 65
0.26	0.28988 71	0.96	0.88680 89	1.66	0.99875 75
0.28	0.31184 70	0.98	0.89580 05	1.68	0.99897 03
0.30	0.33370 37	1.00	0.90428 86	1.70	0.99914 99
0.32	0.35544 26	1.02	0.91228 25		
0.34	0.37704 82	1.04	0.91979 27		
0.36	0.39850 45	1.06	0.92683 11		
0.38	0.41979 45	1.08	0.93341 06		
0.40	0.44090 07	1.10	0.93954 56	1.70	0.99914 99
0.42	0.46180 52	1.12	0.94525 09	1.74	0.99942 75
0.44	0.48248 96	1.14	0.95054 27	1.78	0.99962 05
0.46	0.50293 51	1.16	0.95543 76	1.82	0.99975 26
0.48	0.52312 25	1.18	0.95995 30	1.86	0.99984 14
0.50	0.54303 28	1.20	0.96410 64	1.90	0.99990 01
0.52	0.56264 66	1.22	0.96791 62	1.94	0.99993 82
0.54	0.58194 46	1.24	0.97140 05	1.98	0.99996 24
0.56	0.60090 80	1.26	0.97457 79	2.02	0.99997 76
0.58	0.61951 78	1.28	0.97746 66	2.06	0.99998 69
0.60	0.63775 57	1.30	0.98008 48	2.10	0.99999 25
0.62	0.65560 39	1.32	0.98245 07	2.14	0.99999 57
0.64	0.67304 52	1.34	0.98458 18	2.18	0.99999 77
0.66	0.69006 30	1.36	0.98649 52	2.22	0.99999 87
0.68	0.70664 18	1.38	0.98820 77	2.26	0.99999 93
0.70	0.72276 69	1.40	0.98973 54	2.30	0.99999 97

$$\left[\begin{matrix} (-5)6 \\ 4 \end{matrix} \right]$$

$$\left[\begin{matrix} (-5)7 \\ 5 \end{matrix} \right]$$

$$\left[\begin{matrix} (-5)1 \\ 5 \end{matrix} \right]$$

$$\frac{\Gamma\left(\frac{1}{3}\right)}{3} = 0.89297\ 95116$$

Compiled from M. Abramowitz, Table of the integral $\int_0^x e^{-u^3} du$, J. Math. Phys. **30**, 162-163, 1951 (with permission).

FRESNEL INTEGRALS

Table 7.7

$$C(x) = \int_0^x \cos\left(\frac{\pi}{2}t^2\right) dt$$

$$S(x) = \int_0^x \sin\left(\frac{\pi}{2}t^2\right) dt$$

$$C_2(u) = \frac{1}{\sqrt{2\pi}} \int_0^u \frac{\cos t}{\sqrt{t}} dt = C\left(\sqrt{\frac{2u}{\pi}}\right)$$

$$S_2(u) = \frac{1}{\sqrt{2\pi}} \int_0^u \frac{\sin t}{\sqrt{t}} dt = S\left(\sqrt{\frac{2u}{\pi}}\right)$$

x	$u = \frac{\pi}{2}x^2$	$C(x) = C_2(u)$	$S(x) = S_2(u)$	x	$u = \frac{\pi}{2}x^2$	$C(x) = C_2(u)$	$S(x) = S_2(u)$
0.00	0.00000 00	0.00000 00	0.00000 00	1.00	1.57079 63	0.77989 34	0.43825 91
0.02	0.00062 83	0.02000 00	0.00000 42	1.02	1.63425 65	0.77926 11	0.45824 58
0.04	0.00251 33	0.04000 00	0.00003 35	1.04	1.69897 33	0.77735 01	0.47815 08
0.06	0.00565 49	0.05999 98	0.00011 31	1.06	1.76494 68	0.77414 34	0.49788 84
0.08	0.01005 31	0.07999 92	0.00026 81	1.08	1.83217 68	0.76963 03	0.51736 86
0.10	0.01570 80	0.09999 75	0.00052 36	1.10	1.90066 36	0.76380 67	0.53649 79
0.12	0.02261 95	0.11999 39	0.00090 47	1.12	1.97040 69	0.75667 60	0.55517 92
0.14	0.03078 76	0.13998 67	0.00143 67	1.14	2.04140 69	0.74824 94	0.57331 28
0.16	0.04021 24	0.15997 41	0.00214 44	1.16	2.11366 35	0.73854 68	0.59079 66
0.18	0.05089 38	0.17995 34	0.00305 31	1.18	2.18717 68	0.72759 68	0.60752 74
0.20	0.06283 19	0.19992 11	0.00418 76	1.20	2.26194 67	0.71543 77	0.62340 09
0.22	0.07602 65	0.21987 29	0.00557 30	1.22	2.33797 33	0.70211 76	0.63831 34
0.24	0.09047 79	0.23980 36	0.00723 40	1.24	2.41525 64	0.68769 47	0.65216 19
0.26	0.10618 58	0.25970 70	0.00919 54	1.26	2.49379 62	0.67223 78	0.66484 56
0.28	0.12315 04	0.27957 56	0.01148 16	1.28	2.57359 27	0.65582 63	0.67626 72
0.30	0.14137 17	0.29940 10	0.01411 70	1.30	2.65464 58	0.63855 05	0.68633 33
0.32	0.16084 95	0.31917 31	0.01712 56	1.32	2.73695 55	0.62051 11	0.69495 62
0.34	0.18158 41	0.33888 06	0.02053 11	1.34	2.82052 19	0.60181 95	0.70205 50
0.36	0.20357 52	0.35851 09	0.02435 68	1.36	2.90534 49	0.58259 73	0.70755 67
0.38	0.22682 30	0.37804 96	0.02862 55	1.38	2.99142 45	0.56297 59	0.71139 77
0.40	0.25132 74	0.39748 08	0.03335 94	1.40	3.07876 08	0.54309 58	0.71352 51
0.42	0.27708 85	0.41678 68	0.03858 02	1.42	3.16735 37	0.52310 58	0.71389 77
0.44	0.30410 62	0.43594 82	0.04430 85	1.44	3.25720 33	0.50316 23	0.71248 78
0.46	0.33238 05	0.45494 40	0.05056 42	1.46	3.34830 95	0.48342 80	0.70928 16
0.48	0.36191 15	0.47375 10	0.05736 63	1.48	3.44067 23	0.46407 05	0.70428 12
0.50	0.39269 91	0.49234 42	0.06473 24	1.50	3.53429 17	0.44526 12	0.69750 50
0.52	0.42474 33	0.51069 69	0.07267 89	1.52	3.62916 78	0.42717 32	0.68898 88
0.54	0.45804 42	0.52878 01	0.08122 06	1.54	3.72530 06	0.40997 99	0.67878 67
0.56	0.49260 17	0.54656 30	0.09037 08	1.56	3.82268 99	0.39385 29	0.66697 13
0.58	0.52841 59	0.56401 31	0.10014 09	1.58	3.92133 60	0.37895 96	0.65363 46
0.60	0.56548 67	0.58109 54	0.11054 02	1.60	4.02123 86	0.36546 17	0.63888 77
0.62	0.60381 41	0.59777 37	0.12157 59	1.62	4.12239 79	0.35351 20	0.62286 07
0.64	0.64339 82	0.61400 94	0.13325 28	1.64	4.22481 38	0.34325 29	0.60570 26
0.66	0.68423 89	0.62976 25	0.14557 29	1.66	4.32848 64	0.33481 32	0.58758 04
0.68	0.72633 62	0.64499 12	0.15853 54	1.68	4.43341 56	0.32830 61	0.56867 83
0.70	0.76969 02	0.65965 24	0.17213 65	1.70	4.53960 14	0.32382 69	0.54919 60
0.72	0.81430 08	0.67370 12	0.18636 89	1.72	4.64704 39	0.32145 02	0.52934 73
0.74	0.86016 81	0.68709 20	0.20122 21	1.74	4.75574 30	0.32122 83	0.50935 84
0.76	0.90729 20	0.69977 79	0.21668 16	1.76	4.86569 87	0.32318 87	0.48946 49
0.78	0.95567 25	0.71171 13	0.23272 88	1.78	4.97691 11	0.32733 25	0.46990 94
0.80	1.00530 96	0.72284 42	0.24934 14	1.80	5.08938 01	0.33363 29	0.45093 88
0.82	1.05620 35	0.73312 83	0.26649 22	1.82	5.20310 58	0.34203 39	0.43280 06
0.84	1.10835 39	0.74251 54	0.28414 98	1.84	5.31808 80	0.35244 96	0.41573 97
0.86	1.16176 10	0.75095 79	0.30227 80	1.86	5.43432 70	0.36476 35	0.39999 44
0.88	1.21642 47	0.75840 90	0.32083 55	1.88	5.55182 25	0.37882 93	0.38579 25
0.90	1.27234 50	0.76482 30	0.33977 63	1.90	5.67057 47	0.39447 05	0.37334 73
0.92	1.32952 20	0.77015 63	0.35904 93	1.92	5.79058 36	0.41148 24	0.36285 37
0.94	1.38795 56	0.77436 72	0.37859 81	1.94	5.91184 91	0.42963 33	0.35448 37
0.96	1.44764 59	0.77741 68	0.39836 12	1.96	6.03437 12	0.44866 69	0.34838 30
0.98	1.50859 28	0.77926 95	0.41827 21	1.98	6.15814 99	0.46830 56	0.34466 65
1.00	1.57079 63	0.77989 34	0.43825 91	2.00	6.28318 53	0.48825 34	0.34341 57
	$\left[\begin{smallmatrix} (-4)2 \\ 3 \end{smallmatrix}\right]$	$\left[\begin{smallmatrix} (-4)2 \\ 5 \end{smallmatrix}\right]$	$\left[\begin{smallmatrix} (-5)8 \\ 5 \end{smallmatrix}\right]$		$\left[\begin{smallmatrix} (-4)2 \\ 3 \end{smallmatrix}\right]$	$\left[\begin{smallmatrix} (-4)3 \\ 5 \end{smallmatrix}\right]$	$\left[\begin{smallmatrix} (-4)3 \\ 6 \end{smallmatrix}\right]$

See Example 8.

For $x \rightarrow 0: C(x) \approx x - \frac{\pi^2}{40} x^5 \quad S(x) \approx \frac{\pi}{6} x^3 - \frac{\pi^3}{336} x^7$

Table 7.7

FRESNEL INTEGRALS

$$C(x) = \int_0^x \cos\left(\frac{\pi}{2}t^2\right) dt \quad S(x) = \int_0^x \sin\left(\frac{\pi}{2}t^2\right) dt$$

x	$C(x)$	$S(x)$	x	$C(x)$	$S(x)$	x	$C(x)$	$S(x)$
2.00	0.48825 34	0.34341 57	3.00	0.60572 08	0.49631 30	4.00	0.49842 60	0.42051 58
2.02	0.50820 04	0.34467 48	3.02	0.60383 73	0.51619 42	4.02	0.51821 54	0.42301 99
2.04	0.52782 73	0.34844 87	3.04	0.59823 78	0.53536 29	4.04	0.53675 05	0.43039 00
2.06	0.54681 06	0.35470 04	3.06	0.58910 11	0.55311 95	4.06	0.55284 04	0.44217 81
2.08	0.56482 79	0.36334 98	3.08	0.57674 01	0.56880 28	4.08	0.56543 47	0.45764 45
2.10	0.58156 41	0.37427 34	3.10	0.56159 39	0.58181 59	4.10	0.57369 56	0.47579 83
2.12	0.59671 75	0.38730 37	3.12	0.54421 58	0.59165 11	4.12	0.57705 88	0.49545 71
2.14	0.61000 60	0.40223 09	3.14	0.52525 53	0.59791 29	4.14	0.57527 76	0.51532 14
2.16	0.62117 32	0.41880 45	3.16	0.50543 56	0.60033 66	4.16	0.56844 74	0.53405 87
2.18	0.62999 53	0.43673 63	3.18	0.48552 76	0.59880 34	4.18	0.55700 75	0.55039 41
2.20	0.63628 60	0.45570 46	3.20	0.46632 03	0.59334 95	4.20	0.54171 92	0.56319 89
2.22	0.63990 31	0.47535 85	3.22	0.44858 96	0.58416 97	4.22	0.52362 06	0.57157 23
2.24	0.64075 25	0.49532 41	3.24	0.43306 55	0.57161 47	4.24	0.50396 08	0.57491 03
2.26	0.63879 28	0.51521 11	3.26	0.42040 05	0.55618 06	4.26	0.48411 63	0.57295 47
2.28	0.63403 83	0.53462 03	3.28	0.41113 97	0.53849 35	4.28	0.46549 61	0.56582 05
2.30	0.62656 17	0.55315 16	3.30	0.40569 44	0.51928 61	4.30	0.44944 12	0.55399 59
2.32	0.61649 45	0.57041 28	3.32	0.40431 99	0.49936 95	4.32	0.43712 50	0.53831 55
2.34	0.60402 69	0.58602 84	3.34	0.40709 96	0.47960 04	4.34	0.42946 40	0.51990 77
2.36	0.58940 65	0.59964 89	3.36	0.41393 66	0.46084 46	4.36	0.42704 39	0.50011 73
2.38	0.57293 44	0.61095 96	3.38	0.42455 18	0.44393 82	4.38	0.43006 79	0.48041 08
2.40	0.55496 14	0.61969 00	3.40	0.43849 17	0.42964 95	4.40	0.43833 29	0.46226 80
2.42	0.53588 11	0.62562 11	3.42	0.45514 37	0.41864 11	4.42	0.45123 59	0.44707 06
2.44	0.51612 29	0.62859 38	3.44	0.47375 96	0.41143 69	4.44	0.46781 05	0.43599 33
2.46	0.49614 28	0.62851 43	3.46	0.49348 70	0.40839 28	4.46	0.48679 41	0.42990 86
2.48	0.47641 35	0.62535 98	3.48	0.51340 62	0.40967 54	4.48	0.50671 95	0.42931 16
2.50	0.45741 30	0.61918 18	3.50	0.53257 24	0.41524 80	4.50	0.52602 59	0.43427 30
2.52	0.43961 32	0.61010 76	3.52	0.55006 11	0.42486 72	4.52	0.54318 11	0.44442 34
2.54	0.42346 72	0.59834 06	3.54	0.56501 32	0.43808 83	4.54	0.55680 46	0.45897 36
2.56	0.40939 65	0.58415 75	3.56	0.57668 02	0.45428 17	4.56	0.56578 27	0.47676 89
2.58	0.39777 91	0.56790 42	3.58	0.58446 43	0.47265 92	4.58	0.56936 57	0.49637 56
2.60	0.38893 75	0.54998 93	3.60	0.58795 33	0.49230 95	4.60	0.56723 67	0.51619 23
2.62	0.38312 73	0.53087 53	3.62	0.58694 64	0.51224 12	4.62	0.55954 81	0.53457 97
2.64	0.38052 80	0.51106 79	3.64	0.58147 10	0.53143 21	4.64	0.54691 86	0.54999 67
2.66	0.38123 50	0.49110 35	3.66	0.57178 75	0.54888 15	4.66	0.53039 13	0.56113 28
2.68	0.38525 32	0.47153 52	3.68	0.55838 18	0.56366 38	4.68	0.51135 38	0.56702 44
2.70	0.39249 40	0.45291 75	3.70	0.54194 57	0.57498 04	4.70	0.49142 65	0.56714 55
2.72	0.40277 39	0.43578 98	3.72	0.52334 49	0.58220 56	4.72	0.47232 71	0.56146 19
2.74	0.41581 68	0.42066 03	3.74	0.50357 70	0.58492 61	4.74	0.45572 30	0.55044 52
2.76	0.43125 85	0.40798 90	3.76	0.48371 94	0.58296 92	4.76	0.44308 30	0.53504 16
2.78	0.44865 46	0.39817 24	3.78	0.46487 19	0.57641 91	4.78	0.43554 28	0.51659 82
2.80	0.46749 17	0.39152 84	3.80	0.44809 49	0.56561 87	4.80	0.43379 66	0.49675 02
2.82	0.48720 04	0.38828 41	3.82	0.43434 86	0.55115 74	4.82	0.43802 47	0.47728 00
2.84	0.50717 21	0.38856 43	3.84	0.42443 43	0.53384 32	4.84	0.44786 69	0.45995 75
2.86	0.52677 66	0.39238 50	3.86	0.41894 43	0.51466 22	4.86	0.46244 40	0.44637 74
2.88	0.54538 21	0.39964 80	3.88	0.41822 16	0.49472 45	4.88	0.48042 90	0.43780 82
2.90	0.56237 64	0.41014 06	3.90	0.42233 27	0.47520 24	4.90	0.50016 10	0.43506 74
2.92	0.57718 78	0.42353 87	3.92	0.43105 68	0.45726 13	4.92	0.51979 51	0.43843 48
2.94	0.58930 60	0.43941 39	3.94	0.44389 17	0.44198 92	4.94	0.53747 34	0.44761 56
2.96	0.59830 19	0.45724 45	3.96	0.46007 70	0.43032 79	4.96	0.55150 25	0.46175 67
2.98	0.60384 56	0.47643 06	3.98	0.47863 51	0.42301 17	4.98	0.56051 94	0.47951 78
3.00	0.60572 08	0.49631 30	4.00	0.49842 60	0.42051 58	5.00	0.56363 12	0.49919 14

For $x > 5$ $\begin{matrix} C(x) \\ S(x) \end{matrix} = 0.5 \pm \left(0.3183099 - \frac{0.0968}{x^4} \right) \frac{\sin\left(\frac{\pi}{2}x^2\right)}{x} - \left(0.10132 - \frac{0.154}{x^4} \right) \frac{\cos\left(\frac{\pi}{2}x^2\right)}{x^3} + \epsilon(x) \quad |\epsilon(x)| < 3 \times 10^{-7}$

For $u > 39$ $\begin{matrix} C_2(u) \\ S_2(u) \end{matrix} = 0.5 \pm \left(0.3989423 - \frac{0.3}{u^2} \right) \frac{\sin(u)}{\sqrt{u}} - \left(0.19947 - \frac{0.748}{u^2} \right) \frac{\cos(u)}{u\sqrt{u}} + \epsilon(u) \quad |\epsilon(u)| < 3 \times 10^{-7}$

AUXILIARY FUNCTIONS

Table 7.8

x	$u = \frac{\pi}{2} x^2$			$f(x) = f_2(u)$			$g(x) = g_2(u)$		
0.00	0.00000	00000	00000	0.50000	00000	00000	0.50000	00000	00000
0.02	0.00062	83185	30718	0.49969	41196	39303	0.48031	40626	54163
0.04	0.00251	32741	22872	0.49880	88057	20520	0.46125	51239	79101
0.06	0.00565	48667	76462	0.49739	07811	66949	0.44281	99356	00196
0.08	0.01005	30964	91487	0.49548	44294	00553	0.42500	33536	38036
0.10	0.01570	79632	67949	0.49313	18256	06624	0.40779	85545	29930
0.12	0.02261	94671	05847	0.49037	27777	82254	0.39119	72364	96391
0.14	0.03078	76080	05180	0.48724	48761	11561	0.37518	98069	99885
0.16	0.04021	23859	65949	0.48378	35493	31728	0.35976	55566	09573
0.18	0.05089	38009	88155	0.48002	21268	70713	0.34491	28197	39391
0.20	0.06283	18530	71796	0.47599	19056	49140	0.33061	91227	69034
0.22	0.07602	65422	16873	0.47172	22205	45221	0.31687	13200	89318
0.24	0.09047	78684	23386	0.46724	05176	22164	0.30365	57186	36191
0.26	0.10618	58316	91335	0.46257	24293	12303	0.29095	81914	92531
0.28	0.12315	04320	20720	0.45774	18508	40978	0.27876	42811	44593
0.30	0.14137	16694	11541	0.45277	10172	56087	0.26705	92929	81728
0.32	0.16084	95438	63797	0.44768	05805	06203	0.25582	83796	24420
0.34	0.18158	40553	77490	0.44248	96860	81319	0.24505	66166	57772
0.36	0.20357	52039	52619	0.43721	60487	95888	0.23472	90703	35799
0.38	0.22682	29895	89183	0.43187	60273	53913	0.22483	08578	07150
0.40	0.25132	74122	87183	0.42648	46973	90789	0.21534	72003	95520
0.42	0.27708	84720	46620	0.42105	59227	36507	0.20626	34704	48744
0.44	0.30410	61688	67492	0.41560	24246	90070	0.19756	52322	49727
0.46	0.33238	05027	49800	0.41013	58491	35691	0.18923	82774	60398
0.48	0.36191	14736	93544	0.40466	68313	67950	0.18126	86555	47172
0.50	0.39269	90816	98724	0.39920	50585	25702	0.17364	26996	13238
0.52	0.42474	33267	65340	0.39375	93295	63563	0.16634	70480	39628
0.54	0.45804	42088	93392	0.38833	76127	15400	0.15936	86623	13733
0.56	0.49260	17280	82880	0.38294	71004	26771	0.15269	48414	00876
0.58	0.52841	58843	33803	0.37759	42617	52882	0.14631	32329	91905
0.60	0.56548	66776	46163	0.37228	48922	35620	0.14021	18419	37684
0.62	0.60381	41080	19958	0.36702	41612	87842	0.13437	90361	59907
0.64	0.64339	81754	55190	0.36181	66571	25476	0.12880	35503	06985
0.66	0.68423	88799	51857	0.35666	64292	98472	0.12347	44874	03863
0.68	0.72633	62215	09960	0.35157	70288	80259	0.11838	13187	25611
0.70	0.76969	02001	29499	0.34655	15463	82434	0.11351	38821	06517
0.72	0.81430	08158	10474	0.34159	26474	67053	0.10886	23788	79214
0.74	0.86016	80685	52885	0.33670	26065	33192	0.10441	73696	22082
0.76	0.90729	19583	56732	0.33188	33382	57734	0.10016	97688	77848
0.78	0.95567	24852	22015	0.32713	64271	72503	0.09611	08389	91866
0.80	1.00530	96491	48734	0.32246	31553	61284	0.09223	21832	05037
0.82	1.05620	34501	36888	0.31786	45283	60796	0.08852	57381	23702
0.84	1.10835	38881	86479	0.31334	12993	49704	0.08498	37656	77045
0.86	1.16176	09632	97506	0.30889	39917	09068	0.08159	88446	61614
0.88	1.21642	46754	69968	0.30452	29200	36579	0.07836	38619	62362
0.90	1.27234	50247	03866	0.30022	82096	95385	0.07527	20035	30280
0.92	1.32952	20109	99200	0.29600	98149	76518	0.07231	67451	87932
0.94	1.38795	56343	55971	0.29186	75359	51781	0.06949	18433	26312
0.96	1.44764	58947	74177	0.28780	10340	91658	0.06679	13255	49021
0.98	1.50859	27922	53819	0.28380	98467	20271	0.06420	94813	13093
1.00	1.57079	63267	94897	0.27989	34003	76823	0.06174	08526	09645
		$\left[\begin{smallmatrix} (-4)2 \\ 3 \end{smallmatrix} \right]$			$\left[\begin{smallmatrix} (-5)7 \\ 10 \end{smallmatrix} \right]$			$\left[\begin{smallmatrix} (-5)8 \\ 10 \end{smallmatrix} \right]$	

See Examples 6, 7, and 9.

$$C(x) = \frac{1}{2} + f(x) \sin\left(\frac{\pi}{2}x^2\right) - g(x) \cos\left(\frac{\pi}{2}x^2\right) \quad C_2(u) = \frac{1}{2} + f_2(u) \sin u - g_2(u) \cos u$$

$$S(x) = \frac{1}{2} - f(x) \cos\left(\frac{\pi}{2}x^2\right) - g(x) \sin\left(\frac{\pi}{2}x^2\right) \quad S_2(u) = \frac{1}{2} - f_2(u) \cos u - g_2(u) \sin u$$

Table 7.8

AUXILIARY FUNCTIONS

x^{-1}	$u^{-1} = \frac{2}{\pi x^2}$	$f(x) = f_2(u)$	$g(x) = g_2(u)$	$\langle x \rangle$	$\langle u \rangle$
1.00	0.63661 97723 67581	0.27989 34003 76823	0.06174 08526 09645	1	2
0.98	0.61140 96293 81825	0.27597 33733 36442	0.05933 31378 64174	1	2
0.96	0.58670 87822 13963	0.27197 11505 76851	0.05693 89827 01255	1	2
0.94	0.56251 72308 63995	0.26788 56989 47656	0.05456 06112 91100	1	2
0.92	0.53883 49753 31921	0.26371 60682 37287	0.05220 03510 52931	1	2
0.90	0.51566 20156 17741	0.25946 14023 65674	0.04986 06317 93636	1	2
0.88	0.49299 83517 21455	0.25512 09512 80091	0.04754 39838 94725	1	2
0.86	0.47084 39836 43063	0.25069 40835 25766	0.04525 30354 03048	1	2
0.84	0.44919 89113 82565	0.24618 02994 44393	0.04299 05078 69390	1	2
0.82	0.42806 31349 39962	0.24157 92449 31459	0.04075 92107 68723	1	2
0.80	0.40743 66543 15252	0.23689 07256 57089	0.03856 20343 27312	1	2
0.78	0.38731 94695 08436	0.23211 47216 24632	0.03640 19405 75704	1	3
0.76	0.36771 15805 19515	0.22725 14019 06110	0.03428 19524 44132	1	3
0.74	0.34861 29873 48488	0.22230 11393 53995	0.03220 51407 19129	1	3
0.72	0.33002 36899 95354	0.21726 45250 44609	0.03017 46086 88637	1	3
0.70	0.31194 36884 60115	0.21214 23821 60229	0.02819 34743 19381	1	3
0.68	0.29437 29827 42770	0.20693 57789 65521	0.02626 48498 36510	1	3
0.66	0.27731 15728 43318	0.20164 60404 80635	0.02439 18186 13588	2	4
0.64	0.26075 95487 61761	0.19627 47584 00004	0.02257 74093 32978	2	4
0.62	0.24471 66404 98098	0.19082 37987 55563	0.02082 45674 44482	2	4
0.60	0.22918 31180 52329	0.18529 53067 79209	0.01913 61240 35536	2	4
0.58	0.21415 88914 24454	0.17969 17083 86674	0.01751 47623 30357	2	5
0.56	0.19964 39606 14474	0.17401 57076 89207	0.01596 29821 58470	2	5
0.54	0.18563 83256 22387	0.16827 02799 47273	0.01448 30628 73722	2	5
0.52	0.17214 19864 48194	0.16245 86594 19322	0.01307 70253 60097	2	6
0.50	0.15915 49430 91895	0.15658 43216 36302	0.01174 65939 24659	2	6
0.48	0.14667 71955 53491	0.15065 09597 56320	0.01049 31590 42015	2	7
0.46	0.13470 87438 32980	0.14466 24548 29603	0.00931 77420 66589	2	7
0.44	0.12324 95879 30364	0.13862 28400 34552	0.00822 09631 52815	2	8
0.42	0.11229 97278 45641	0.13253 62592 29647	0.00720 30137 00215	2	9
0.40	0.10185 91635 78813	0.12640 69204 94864	0.00626 36346 49122	3	10
0.38	0.09192 78951 29879	0.12023 90456 93806	0.00540 21018 72942	3	11
0.36	0.08250 59224 98839	0.11403 68174 47880	0.00461 72197 27002	3	12
0.34	0.07359 32456 85692	0.10780 43252 41741	0.00390 73235 12822	3	14
0.32	0.06518 98646 90440	0.10154 55126 32988	0.00327 02912 03254	3	15
0.30	0.05729 57795 13082	0.09526 41276 74844	0.00270 35642 68526	3	17
0.28	0.04991 09901 53618	0.08896 36786 39974	0.00220 41768 84885	4	20
0.26	0.04303 54966 12048	0.08264 73969 33180	0.00176 87922 53708	4	23
0.24	0.03666 92988 88373	0.07631 82087 00913	0.00139 37442 77909	4	27
0.22	0.03081 23969 82591	0.06997 87161 16730	0.00107 50825 02743	5	32
0.20	0.02546 47908 94703	0.06363 11887 04012	0.00080 86180 82883	5	39
0.18	0.02062 64806 24710	0.05727 75644 30652	0.00058 99686 10701	6	48
0.16	0.01629 74661 72610	0.05091 94597 59575	0.00041 45999 18234	6	61
0.14	0.01247 77475 38405	0.04455 81874 32960	0.00027 78633 97799	7	80
0.12	0.00916 73247 22093	0.03819 47805 44642	0.00017 50279 00844	8	109
0.10	0.00636 61977 23676	0.03183 00214 15118	0.00010 13057 94484	10	157
0.08	0.00407 43665 43153	0.02546 44738 95252	0.00005 18732 17470	13	245
0.06	0.00229 18311 80523	0.01909 85179 38105	0.00002 18849 44630	17	436
0.04	0.00101 85916 35788	0.01273 23855 39770	0.00000 64845 30524	25	982
0.02	0.00025 46479 08947	0.00636 61974 14061	0.00000 08105 69272	50	3927
0.00	0.00000 00000 00000	0.00000 00000 00000	0.00000 00000 00000	∞	∞

$$C(x) = \frac{1}{2} + f(x) \sin\left(\frac{\pi}{2}x^2\right) - g(x) \cos\left(\frac{\pi}{2}x^2\right) \quad C_2(u) = \frac{1}{2} + f_2(u) \sin u - g_2(u) \cos u$$

$$S(x) = \frac{1}{2} - f(x) \cos\left(\frac{\pi}{2}x^2\right) - g(x) \sin\left(\frac{\pi}{2}x^2\right) \quad S_2(u) = \frac{1}{2} - f_2(u) \cos u - g_2(u) \sin u$$

$\langle x \rangle$ = nearest integer to x .

ERROR FUNCTION FOR COMPLEX ARGUMENTS Table 7.9

$$w(z) = e^{-z^2} \operatorname{erfc}(-iz) \quad z = x + iy$$

<i>y</i>	<i>℔</i> w(<i>z</i>)		<i>ℑ</i> w(<i>z</i>)		<i>℔</i> w(<i>z</i>)		<i>ℑ</i> w(<i>z</i>)		<i>℔</i> w(<i>z</i>)		<i>ℑ</i> w(<i>z</i>)	
	<i>x</i> =2.0	<i>x</i> =2.1	<i>x</i> =2.2	<i>x</i> =2.3	<i>x</i> =2.4	<i>x</i> =2.5	<i>x</i> =2.6	<i>x</i> =2.7	<i>x</i> =2.8	<i>x</i> =2.9	<i>x</i> =3.0	<i>x</i> =3.1
0.0	0.018316	0.340026	0.012155	0.318073	0.007907	0.298468	0.005042	0.281026	0.003151	0.265522	0.001930	0.251723
0.1	0.040201	0.331583	0.031936	0.311886	0.025678	0.293982	0.020958	0.277795	0.017397	0.263201	0.014698	0.250050
0.2	0.059531	0.321332	0.049726	0.303894	0.041927	0.287771	0.035728	0.272968	0.030792	0.259435	0.026841	0.247092
0.3	0.076396	0.309831	0.065521	0.294574	0.056586	0.280232	0.049248	0.266865	0.043211	0.254478	0.038226	0.243042
0.4	0.090944	0.297529	0.079385	0.284327	0.069655	0.271710	0.061473	0.259775	0.054585	0.248566	0.048873	0.238092
0.5	0.103359	0.284786	0.091422	0.273482	0.081182	0.262499	0.072408	0.251953	0.064890	0.241914	0.058831	0.205504
0.6	0.113836	0.271881	0.101765	0.262308	0.091245	0.252844	0.082092	0.243617	0.074132	0.234714	0.068685	0.198837
0.7	0.122574	0.259031	0.110558	0.251016	0.099943	0.242947	0.090585	0.234952	0.082345	0.227129	0.075088	0.191999
0.8	0.129768	0.246396	0.117948	0.239772	0.107383	0.232968	0.097963	0.226111	0.089576	0.219302	0.082112	0.212614
0.9	0.135600	0.234096	0.124081	0.228703	0.113679	0.223037	0.104309	0.217219	0.095884	0.211349	0.088317	0.205504
1.0	0.140240	0.222213	0.129097	0.217904	0.118941	0.213253	0.109709	0.208376	0.101336	0.203368	0.098466	0.198307
1.1	0.143840	0.210805	0.133125	0.207442	0.123277	0.203692	0.114251	0.199660	0.105999	0.195438	0.102518	0.183943
1.2	0.146541	0.199904	0.136286	0.197366	0.126788	0.194410	0.118019	0.191133	0.109942	0.187620	0.105960	0.178897
1.3	0.148466	0.189529	0.138689	0.187705	0.129570	0.185446	0.121092	0.182840	0.113232	0.179965	0.109988	0.174104
1.4	0.149725	0.179687	0.140432	0.178478	0.131709	0.176827	0.123548	0.174814	0.115935	0.172510	0.114903	0.169932
1.5	0.150415	0.170371	0.141604	0.169691	0.133284	0.168569	0.125454	0.167078	0.118109	0.165281	0.118022	0.163062
1.6	0.150622	0.161572	0.142283	0.161343	0.134367	0.160680	0.126877	0.159646	0.119812	0.158299	0.120023	0.158299
1.7	0.150418	0.153274	0.142540	0.153429	0.135021	0.153161	0.127873	0.152526	0.121096	0.151576	0.122945	0.152945
1.8	0.149870	0.145457	0.142434	0.145938	0.135305	0.146009	0.128495	0.145721	0.122010	0.145120	0.125577	0.147092
1.9	0.149032	0.138100	0.142021	0.138855	0.135269	0.139217	0.128792	0.139229	0.122597	0.138933	0.128226	0.138092
2.0	0.147953	0.131180	0.141347	0.132164	0.134959	0.132773	0.128805	0.133045	0.122897	0.133015	0.134619	0.128092
2.1	0.146675	0.124674	0.140453	0.125849	0.134414	0.126667	0.128574	0.127161	0.122945	0.127363	0.136286	0.123042
2.2	0.145234	0.118558	0.139375	0.119891	0.133669	0.120885	0.128130	0.121569	0.122773	0.121972	0.138689	0.118558
2.3	0.143660	0.112810	0.138145	0.114272	0.132755	0.115413	0.127506	0.116258	0.122411	0.116834	0.140432	0.112810
2.4	0.141982	0.107408	0.136789	0.108973	0.131699	0.110236	0.126726	0.111218	0.121884	0.111942	0.141604	0.107408
2.5	0.140220	0.102329	0.135331	0.103977	0.130524	0.105339	0.125814	0.106436	0.121215	0.107286	0.140220	0.102329
2.6	0.138395	0.097554	0.133791	0.099265	0.129252	0.100709	0.124792	0.101901	0.120424	0.102858	0.138395	0.097554
2.7	0.136523	0.093062	0.132187	0.094822	0.127900	0.096330	0.123676	0.097601	0.119530	0.098648	0.136523	0.093062
2.8	0.134619	0.088837	0.130533	0.090631	0.126483	0.092189	0.122484	0.093523	0.118548	0.094646	0.134619	0.088837
2.9	0.132693	0.084859	0.128842	0.086677	0.125016	0.088273	0.121229	0.089658	0.117492	0.090842	0.132693	0.084859
3.0	0.130757	0.081113	0.127125	0.082944	0.123510	0.084568	0.119922	0.085992	0.116375	0.087227	0.130757	0.081113
3.1	0.128811	0.078040	0.125448	0.079909	0.122029	0.081259	0.118787	0.084122	0.114962	0.086170	0.128811	0.078040
3.2	0.126875	0.075095	0.123818	0.077001	0.120576	0.078481	0.117689	0.082976	0.113304	0.084883	0.126875	0.075095
3.3	0.124953	0.072376	0.122245	0.074409	0.119170	0.076108	0.116627	0.081823	0.111833	0.083654	0.124953	0.072376
3.4	0.123046	0.070003	0.120726	0.072145	0.117814	0.074318	0.115747	0.081006	0.110577	0.082525	0.123046	0.070003
3.5	0.121155	0.068044	0.119259	0.070340	0.116512	0.073049	0.114968	0.080499	0.109494	0.081551	0.121155	0.068044
3.6	0.119283	0.066520	0.117846	0.069104	0.115252	0.072222	0.114270	0.080151	0.108577	0.080763	0.119283	0.066520
3.7	0.117433	0.065406	0.116486	0.068270	0.114044	0.071722	0.113651	0.080028	0.107791	0.080572	0.117433	0.065406
3.8	0.115607	0.064718	0.115194	0.067741	0.112901	0.071385	0.113087	0.080007	0.107092	0.080497	0.115607	0.064718
3.9	0.113807	0.064400	0.113976	0.067464	0.111827	0.071103	0.112537	0.080018	0.106484	0.080475	0.113807	0.064400
4.0	0.112033	0.064520	0.112821	0.067424	0.110814	0.071103	0.112095	0.080054	0.105947	0.080492	0.112033	0.064520

See Examples 12-19.

$$w(x) = e^{-x^2} + \frac{2i}{\sqrt{\pi}} e^{-x^2} \int_0^x e^{-t^2} dt$$

$$w(-x + iy) = \overline{w(x + iy)}$$

$$w(x - iy) = 2e^{y^2 - x^2} (\cos 2xy + i \sin 2xy) - \overline{w(x + iy)}$$

$$w(iy) = e^{y^2} \operatorname{erfc} y$$

$$w[(1+i)u] = e^{-2iu^2} \left\{ 1 + (i-1) \left[C\left(\frac{2u}{\sqrt{\pi}}\right) + iS\left(\frac{2u}{\sqrt{\pi}}\right) \right] \right\}$$

COMPLEX ZEROS OF THE ERROR FUNCTION

Table 7.10

n	erf z _n =0		z _n =x _n +iy _n		y _n				
	x _n	y _n	x _n	y _n					
1	1.45061	616	1.88094	300	6	4.15899	840	4.43557	144
2	2.24465	928	2.61657	514	7	4.51631	940	4.78044	764
3	2.83974	105	3.17562	810	8	4.84797	031	5.10158	804
4	3.33546	074	3.64617	438	9	5.15876	791	5.40333	264
5	3.76900	557	4.06069	723	10	5.45219	220	5.68883	744

erf z_n=erf (-z_n)=erf z̄_n=erf (-z̄_n)=0

$$x_n \approx \frac{1}{2} \sqrt{\pi(4n-1)} \mp \frac{\ln(\pi \sqrt{2n-\frac{1}{4}})}{2\sqrt{\pi(4n-\frac{1}{2})}} \quad (n > 0)$$

$$y_n \approx \frac{1}{2} \sqrt{\pi(4n-1)}$$

From H. E. Salzer, Complex zeros of the error function, J. Franklin Inst. 260, 209-211, 1955 (with permission).

COMPLEX ZEROS OF FRESNEL INTEGRALS

Table 7.11

n	C(z _n)=0		z _n =x _n +iy _n		y _n *
	x _n	y _n	x _n *	y _n *	
0	0.0000	0.0000	0.0000	0.0000	0.0000
1	1.7437	0.3057	2.0093	0.2886	0.2886
2	2.6515	0.2529	2.8335	0.2443	0.2443
3	3.3208	0.2239	3.4675	0.2185	0.2185
4	3.8759	0.2047	4.0026	0.2008	0.2008
5	4.3611	0.1909	4.4742	0.1877	0.1877

C(z_n)=C(-z_n)=C(z̄_n)=C(-z̄_n)=C(iz_n)=C(-iz_n)=C(-iz̄_n)=C(iz̄_n)=0

$$x_n \approx \sqrt{4n-1} - \frac{\ln(\pi \sqrt{4n-1})}{\pi^2(4n-1)^{3/2}} \quad y_n \approx \frac{\ln(\pi \sqrt{4n-1})}{\pi \sqrt{4n-1}} \quad (n > 0)$$

$$x_n^* \approx 2\sqrt{n} - \frac{\ln(2\pi \sqrt{n})}{8\pi^2 n^{3/2}} \quad y_n^* \approx \frac{\ln(2\pi \sqrt{n})}{2\pi \sqrt{n}}$$

MAXIMA AND MINIMA OF FRESNEL INTEGRALS

Table 7.12

n	M _n = C(√(4n+1))	m _n = C(√(4n+3))	M _n [*] = S(√(4n+2))	m _n [*] = S(√(4n+4))
	M _n	m _n	M _n [*]	m _n [*]
0	0.779893	0.321056	0.713972	0.343415
1	0.640807	0.380389	0.628940	0.387969
2	0.605721	0.404260	0.600361	0.408301
3	0.588128	0.417922	0.584942	0.420516
4	0.577121	0.427036	0.574957	0.428877
5	0.569413	0.433666	0.567822	0.435059

$$M_n \sim \frac{1}{2} + \frac{\pi^2(4n+1)^2-3}{\pi^3(4n+1)^{5/2}} \quad m_n \sim \frac{1}{2} - \frac{\pi^2(4n+3)^2-3}{\pi^3(4n+3)^{5/2}} \quad (n \rightarrow \infty)$$

$$M_n^* \sim \frac{1}{2} + \frac{\pi^2(4n+2)^2-3}{\pi^3(4n+2)^{5/2}} \quad m_n^* \sim \frac{1}{2} - \frac{16\pi^2(n+1)^2-3}{32\pi^3(n+1)^{5/2}}$$

From G. N. Watson, A treatise on the theory of Bessel functions, 2d ed. Cambridge Univ. Press, Cambridge, England, 1958 (with permission).

8. Legendre Functions

IRENE A. STEGUN¹

Contents

	Page
Mathematical Properties	332
Notation	332
8.1. Differential Equation	332
8.2. Relations Between Legendre Functions	333
8.3. Values on the Cut	333
8.4. Explicit Expressions	333
8.5. Recurrence Relations	333
8.6. Special Values	334
8.7. Trigonometric Expansions	335
8.8. Integral Representations	335
8.9. Summation Formulas	335
8.10. Asymptotic Expansions	335
8.11. Toroidal Functions	336
8.12. Conical Functions	337
8.13. Relation to Elliptic Integrals	337
8.14. Integrals	337
Numerical Methods	339
8.15. Use and Extension of the Tables	339
References	340
Table 8.1. Legendre Function-First Kind $P_n(x)$ ($x \leq 1$)	342
$x=0(.01)1, n=0(1)3, 9, 10, 5-8D$	
Table 8.2. Derivative of the Legendre Function-First Kind $P'_n(x)$ ($x \leq 1$)	344
$x=0(.01)1, n=1(1)4, 9, 10, 5-7D$	
Table 8.3. Legendre Function-Second Kind $Q_n(x)$ ($x \leq 1$)	346
$x=0(.01)1, n=0(1)3, 9, 10, 8D$	
Table 8.4. Derivative of the Legendre Function-Second Kind $Q'_n(x)$ ($x \leq 1$)	348
$x=0(.01)1, n=0(1)3, 9, 10, 6-8D$	
Table 8.5. Legendre Function-First Kind $P_n(x)$ ($x \geq 1$)	350
$x=1(.2)10, n=0(1)5, 9, 10, \text{ exact or } 6S$	
Table 8.6. Derivative of the Legendre Function-First Kind $P'_n(x)$ ($x \geq 1$)	351
$x=1(.2)10, n=1(1)5, 9, 10, 6S$	
Table 8.7. Legendre Function-Second Kind $Q_n(x)$ ($x \geq 1$)	352
$x=1(.2)10, n=0(1)3, 9, 10, 6S$	
Table 8.8. Derivative of the Legendre Function-Second Kind $Q'_n(x)$ ($x \geq 1$)	353
$x=1(.2)10, n=0(1)3, 9, 10, 6S$	

The author acknowledges the assistance of Ruth E. Capuano, Elizabeth F. Godefroy, David S. Liepman, and Bertha H. Walter in the preparation and checking of the tables and examples.

¹ National Bureau of Standards.

8. Legendre Functions

Mathematical Properties

Notation

The conventions used are $z=x+iy$, x, y real, and in particular, x always means a real number in the interval $-1 \leq x \leq +1$ with $\cos \theta = x$ where θ is likewise a real number; n and m are positive integers or zero; ν and μ are unrestricted except where otherwise indicated.

Other notations are:

$$P^n(x) \text{ for } \frac{n!P_n(x)}{(2n-1)!!}$$

$$P_{nm}(x) \text{ for } (-1)^m P_n^m(x)$$

$$T_n^m(x) \text{ for } (-1)^m P_n^m(x)$$

$$\overline{P}_n^m(x) \text{ for } (-1)^m \sqrt{\frac{(2n+1)(n-m)!}{2(n+m)!}} P_n^m(x)$$

$$\mathfrak{P}_\nu^\mu(z) \text{ for } P_\nu^\mu(z), \mathfrak{Q}_\nu^\mu(z) \text{ for } Q_\nu^\mu(z) \quad (\Re z > 1)$$

$$\mathfrak{Q}_\nu^\mu(z) \text{ for } e^{\mu\pi i} Q_\nu^\mu(z)$$

$$Q_\nu^\mu(z) \text{ for } \frac{\sin(\nu+\mu)\pi}{\sin \nu\pi} Q_\nu^\mu(z)$$

Various other definitions of the functions occur as well as mixing of definitions.

8.1. Differential Equation

8.1.1

$$(1-z^2) \frac{d^2 w}{dz^2} - 2z \frac{dw}{dz} + [\nu(\nu+1) - \frac{\mu^2}{1-z^2}] w = 0$$

Solutions

(Degree ν and order μ with singularities at $z = \pm 1, \infty$ as ordinary branch points— μ, ν arbitrary complex constants.)

$P_\nu^\mu(z), Q_\nu^\mu(z)$ —Associated Legendre Functions (Spherical Harmonics) of the First and Second Kinds²

$$|\arg(z \pm 1)| < \pi, \quad |\arg z| < \pi$$

$$(z^2 - 1)^{\frac{1}{2}\mu} = (z-1)^{\frac{1}{2}\mu} (z+1)^{\frac{1}{2}\mu}$$

(For $P_\nu^\mu(z)$, $\mu=0$, Legendre polynomials, see chapter 22.)

8.1.2

$$P_\nu^\mu(z) = \frac{1}{\Gamma(1-\mu)} \left[\frac{z+1}{z-1} \right]^{\frac{1}{2}\mu} F\left(-\nu, \nu+1; 1-\mu; \frac{1-z}{2}\right) \quad (|1-z| < 2)$$

(For $F(a, b; c; z)$ see chapter 15.)

$$8.1.3 \quad Q_\nu^\mu(z) = e^{i\mu\pi} 2^{-\nu-1} \pi^{-\frac{1}{2}} \frac{\Gamma(\nu+\mu+1)}{\Gamma(\nu+\frac{3}{2})} z^{-\nu-\mu-1} (z^2-1)^{\frac{1}{2}\mu} F\left(1+\frac{\nu}{2}+\frac{\mu}{2}, \frac{1}{2}+\frac{\nu}{2}+\frac{\mu}{2}; \nu+\frac{3}{2}; \frac{1}{z^2}\right) \quad (|z| > 1)$$

Alternate Forms

(Additional forms may be obtained by means of the transformation formulas of the hypergeometric function, see [8.1].)

$$8.1.4 \quad P_\nu^\mu(z) = 2^\mu \pi^{\frac{1}{2}} (z^2-1)^{-\frac{1}{2}\mu} \left\{ \frac{F\left(-\frac{\nu}{2}-\frac{\mu}{2}, \frac{1}{2}+\frac{\nu}{2}-\frac{\mu}{2}; \frac{1}{2}; z^2\right)}{\Gamma\left(\frac{1}{2}-\frac{\nu}{2}-\frac{\mu}{2}\right) \Gamma\left(1+\frac{\nu}{2}-\frac{\mu}{2}\right)} - 2z \frac{F\left(\frac{1}{2}-\frac{\nu}{2}-\frac{\mu}{2}, 1+\frac{\nu}{2}-\frac{\mu}{2}; \frac{3}{2}; z^2\right)}{\Gamma\left(\frac{1}{2}+\frac{\nu}{2}-\frac{\mu}{2}\right) \Gamma\left(-\frac{\nu}{2}-\frac{\mu}{2}\right)} \right\} \quad (|z^2| < 1)$$

$$8.1.5 \quad P_\nu^\mu(z) = \frac{2^{-\nu-1} \pi^{-\frac{1}{2}} \Gamma(-\frac{1}{2}-\nu) z^{-\nu+\mu-1}}{(z^2-1)^{\mu/2} \Gamma(-\nu-\mu)} F\left(\frac{1}{2}+\frac{\nu}{2}-\frac{\mu}{2}, 1+\frac{\nu}{2}-\frac{\mu}{2}; \nu+\frac{3}{2}; z^{-2}\right) + \frac{2^\nu \Gamma(\frac{1}{2}+\nu) z^{\nu+\mu}}{(z^2-1)^{\mu/2} \Gamma(1+\nu-\mu)} F\left(-\frac{\nu}{2}-\frac{\mu}{2}, \frac{1}{2}-\frac{\nu}{2}-\frac{\mu}{2}; \frac{1}{2}-\nu; z^{-2}\right) \quad (|z^{-2}| < 1)$$

$$8.1.6 \quad e^{-i\mu\pi} Q_\nu^\mu(z) = \frac{\Gamma(1+\nu+\mu) \Gamma(-\mu) (z-1)^{\frac{1}{2}\mu} (z+1)^{-\frac{1}{2}\mu}}{2\Gamma(1+\nu-\mu)} F\left(-\nu, 1+\nu; 1+\mu; \frac{1-z}{2}\right) + \frac{1}{2} \Gamma(\mu) (z+1)^{\frac{1}{2}\mu} (z-1)^{-\frac{1}{2}\mu} F\left(-\nu, 1+\nu; 1-\mu; \frac{1-z}{2}\right) \quad (|1-z| < 2) \quad *$$

² The functions $Y_n^m(\theta, \varphi) = \frac{\cos m\varphi}{\sin m\varphi} P_n^m(\cos \theta)$ called surface harmonics of the first kind, tesseral for $m < n$ and sectoral for $m = n$. With $0 \leq \theta \leq \pi$, $0 \leq \varphi \leq 2\pi$, they are everywhere one valued and continuous functions on the surface of the unit sphere $x^2 + y^2 + z^2 = 1$ where $x = \sin \theta \cos \varphi$, $y = \sin \theta \sin \varphi$ and $z = \cos \theta$.

*See page II.

$$8.1.7 \quad e^{-i\mu\pi} Q_\nu^\mu(z) = \pi^{1/2} 2^\mu (z^2-1)^{-1/2} \left\{ \frac{\Gamma\left(\frac{1}{2} + \frac{\nu}{2} + \frac{\mu}{2}\right)}{2\Gamma\left(1 + \frac{\nu}{2} - \frac{\mu}{2}\right)} e^{\pm i\pi(\mu-\nu-1)} F\left(-\frac{\nu}{2} - \frac{\mu}{2}, \frac{1}{2} + \frac{\nu}{2} - \frac{\mu}{2}; \frac{1}{2}; z^2\right) \right. \\ \left. + \frac{z\Gamma\left(1 + \frac{\nu}{2} + \frac{\mu}{2}\right) e^{\pm i\pi(\mu-\nu)}}{\Gamma\left(\frac{1}{2} + \frac{\nu}{2} - \frac{\mu}{2}\right)} F\left(\frac{1}{2} - \frac{\nu}{2} - \frac{\mu}{2}, 1 + \frac{\nu}{2} - \frac{\mu}{2}; \frac{3}{2}; z^2\right) \right\} \quad (|z^2| < 1)$$

Wronskian

8.1.8

$$W\{P_\nu^\mu(z), Q_\nu^\mu(z)\} = \frac{e^{i\mu\pi} 2^{2\mu} \Gamma\left(\frac{\nu+\mu+2}{2}\right) \Gamma\left(\frac{\nu+\mu+1}{2}\right)}{(1-z^2) \Gamma\left(\frac{\nu-\mu+2}{2}\right) \Gamma\left(\frac{\nu-\mu+1}{2}\right)}$$

8.1.9 $W\{P_n(z), Q_n(z)\} = -(z^2-1)^{-1}$

8.2. Relations Between Legendre Functions

Negative Degree

8.2.1 $P_{-\nu-1}^\mu(z) = P_\nu^\mu(z)$

8.2.2

$$Q_{-\nu-1}^\mu(z) = \{-\pi e^{i\mu\pi} \cos \nu\pi P_\nu^\mu(z) + Q_\nu^\mu(z) \sin[\pi(\nu+\mu)]\} / \sin[\pi(\nu-\mu)]$$

Negative Argument ($\mathcal{I}z \geq 0$)

8.2.3

$$P_\nu^\mu(-z) = e^{\mp i\nu\pi} P_\nu^\mu(z) - \frac{2}{\pi} e^{-i\mu\pi} \sin[\pi(\nu+\mu)] Q_\nu^\mu(z)$$

8.2.4

$$Q_\nu^\mu(-z) = -e^{\pm i\nu\pi} Q_\nu^\mu(z)$$

Negative Order

8.2.5

$$P_\nu^{-\mu}(z) = \frac{\Gamma(\nu-\mu+1)}{\Gamma(\nu+\mu+1)} \left[P_\nu^\mu(z) - \frac{2}{\pi} e^{-i\mu\pi} \sin(\mu\pi) Q_\nu^\mu(z) \right]$$

8.2.6

$$Q_\nu^{-\mu}(z) = e^{-2i\mu\pi} \frac{\Gamma(\nu-\mu+1)}{\Gamma(\nu+\mu+1)} Q_\nu^\mu(z)$$

Degree $\mu + \frac{1}{2}$ and Order $\nu + \frac{1}{2}$

$$\mathcal{R}z > 0$$

8.2.7 $P_{-\nu-\frac{1}{2}}^{-\mu-\frac{1}{2}}\left(\frac{z}{(z^2-1)^{1/2}}\right) = \frac{(z^2-1)^{1/4} e^{-i\mu\pi} Q_\nu^\mu(z)}{(\frac{1}{2}\pi)^{1/2} \Gamma(\nu+\mu+1)}$

8.2.8

$$Q_{-\nu-\frac{1}{2}}^{-\mu-\frac{1}{2}}\left(\frac{z}{(z^2-1)^{1/2}}\right) = -i(\frac{1}{2}\pi)^{1/2} \Gamma(-\nu-\mu) (z^2-1)^{1/4} e^{-i\nu\pi} P_\nu^\mu(z)$$

8.3. Values on the Cut

$$(-1 < x < 1)$$

8.3.1

$$P_\nu^\mu(x) = \frac{1}{2} [e^{i\mu\pi} P_\nu^\mu(x+i0) + e^{-i\mu\pi} P_\nu^\mu(x-i0)]$$

(Upper and lower signs according as $\mathcal{I}z \geq 0$.)

8.3.2

$$P_\nu^\mu(x) = e^{\pm i\mu\pi} P_\nu^\mu(x \pm i0) \quad *$$

8.3.3

$$= i\pi^{-1} e^{-i\mu\pi} [e^{-i\mu\pi} Q_\nu^\mu(x+i0) - e^{i\mu\pi} Q_\nu^\mu(x-i0)] \quad *$$

8.3.4

$$Q_\nu^\mu(x) = \frac{1}{2} e^{-i\mu\pi} [e^{-i\mu\pi} Q_\nu^\mu(x+i0) + e^{i\mu\pi} Q_\nu^\mu(x-i0)]$$

(Formulas for $P_\nu^\mu(x)$ and $Q_\nu^\mu(x)$ are obtained with the replacement of $z-1$ by $(1-x)e^{\pm i\pi}$, (z^2-1) by $(1-x^2)e^{\pm i\pi}$, $z+1$ by $x+1$ for $z=x \pm i0$.)

8.4. Explicit Expressions

$$(x = \cos \theta)$$

8.4.1

$$P_0(z) = 1 \quad P_0(x) = 1$$

8.4.2

$$Q_0(z) = \frac{1}{2} \ln\left(\frac{z+1}{z-1}\right) \quad Q_0(x) = \frac{1}{2} \ln\left(\frac{1+x}{1-x}\right) = xF\left(\frac{1}{2}, 1; \frac{3}{2}; x^2\right)$$

8.4.3

$$P_1(z) = z \quad P_1(x) = x = \cos \theta$$

8.4.4

$$Q_1(z) = \frac{z}{2} \ln\left(\frac{z+1}{z-1}\right) - 1 \quad Q_1(x) = \frac{x}{2} \ln\left(\frac{1+x}{1-x}\right) - 1$$

8.4.5

$$P_2(z) = \frac{1}{2}(3z^2-1) \quad P_2(x) = \frac{1}{2}(3x^2-1) = \frac{1}{4}(3 \cos 2\theta + 1)$$

8.4.6

$$Q_2(z) = \frac{1}{2} P_2(z) \ln\left(\frac{z+1}{z-1}\right) \quad Q_2(x) = -\frac{3z}{2} \left(\frac{3x^2-1}{4}\right) \ln\left(\frac{1+x}{1-x}\right) - \frac{3x}{2}$$

8.5. Recurrence Relations

(Both P_ν^μ and Q_ν^μ satisfy the same recurrence relations.)

Varying Order

8.5.1

$$P_\nu^{+\mu}(z) = (z^2-1)^{-1/2} \{(\nu-\mu)zP_\nu^\mu(z) - (\nu+\mu)P_{\nu-1}^\mu(z)\}$$

*See page II.

8.5.2

$$(z^2-1) \frac{dP_\nu^\mu(z)}{dz} = (\nu+\mu)(\nu-\mu+1)(z^2-1)^{\frac{1}{2}} P_{\nu-1}^\mu(z) - \mu z P_\nu^\mu(z)$$

Varying Degree

8.5.3

$$(\nu-\mu+1)P_{\nu+1}^\mu(z) = (2\nu+1)zP_\nu^\mu(z) - (\nu+\mu)P_{\nu-1}^\mu(z)$$

8.5.4 $(z^2-1) \frac{dP_\nu^\mu(z)}{dz} = \nu z P_\nu^\mu(z) - (\nu+\mu)P_{\nu-1}^\mu(z)$

Varying Order and Degree

8.5.5 $P_{\nu+1}^\mu(z) = P_{\nu-1}^\mu(z) + (2\nu+1)(z^2-1)^{\frac{1}{2}} P_\nu^{\mu-1}(z)$

8.6. Special Values

$x=0$

8.6.1

$P_\nu^\mu(0) = 2^\mu \pi^{-\frac{1}{2}} \cos[\frac{1}{2}\pi(\nu+\mu)] \Gamma(\frac{1}{2}\nu + \frac{1}{2}\mu + \frac{1}{2}) / \Gamma(\frac{1}{2}\nu - \frac{1}{2}\mu + 1)$

8.6.2

$Q_\nu^\mu(0) = -2^{\mu-1} \pi^{\frac{1}{2}} \sin[\frac{1}{2}\pi(\nu+\mu)] \Gamma(\frac{1}{2}\nu + \frac{1}{2}\mu + \frac{1}{2}) / \Gamma(\frac{1}{2}\nu - \frac{1}{2}\mu + 1)$

8.6.3

$\left[\frac{dP_\nu^\mu(x)}{dx} \right]_{x=0} = 2^{\mu+1} \pi^{-\frac{1}{2}} \sin[\frac{1}{2}\pi(\nu+\mu)] \Gamma(\frac{1}{2}\nu + \frac{1}{2}\mu + 1) / \Gamma(\frac{1}{2}\nu - \frac{1}{2}\mu + \frac{1}{2})$

8.6.4

$\left[\frac{dQ_\nu^\mu(x)}{dx} \right]_{x=0} = 2^\mu \pi^{\frac{1}{2}} \cos[\frac{1}{2}\pi(\nu+\mu)] \Gamma(\frac{1}{2}\nu + \frac{1}{2}\mu + 1) / \Gamma(\frac{1}{2}\nu - \frac{1}{2}\mu + \frac{1}{2})$

8.6.5

$W\{P_\nu^\mu(x), Q_\nu^\mu(x)\}_{x=0} = \frac{2^{2\mu} \Gamma(\frac{1}{2}\nu + \frac{1}{2}\mu + 1) \Gamma(\frac{1}{2}\nu + \frac{1}{2}\mu + \frac{1}{2})}{\Gamma(\frac{1}{2}\nu - \frac{1}{2}\mu + 1) \Gamma(\frac{1}{2}\nu - \frac{1}{2}\mu + \frac{1}{2})}$
 $\mu = m = 1, 2, 3, \dots$

8.6.6

$P_\nu^m(z) = (z^2-1)^{\frac{1}{2}m} \frac{d^m P_\nu(z)}{dz^m}$
 $P_\nu^m(x) = (-1)^m (1-x^2)^{\frac{1}{2}m} \frac{d^m P_\nu(x)}{dx^m}$

8.6.7

$Q_\nu^m(z) = (z^2-1)^{\frac{1}{2}m} \frac{d^m Q_\nu(z)}{dz^m}$
 $Q_\nu^m(x) = (-1)^m (1-x^2)^{\frac{1}{2}m} \frac{d^m Q_\nu(x)}{dx^m}$
 $\mu = \pm \frac{1}{2}$

8.6.8

$P_{\frac{1}{2}}^\mu(z) = (z^2-1)^{-1/4} (2\pi)^{-1/2} \{ [z + (z^2-1)^{1/2}]^{\nu+\frac{1}{2}} + [z + (z^2-1)^{1/2}]^{-\nu-\frac{1}{2}} \}$

8.6.9

$P_\nu^{-\frac{1}{2}}(z) = \left(\frac{2}{\pi}\right)^{1/2} \frac{(z^2-1)^{-1/4}}{2\nu+1} \{ [z + (z^2-1)^{1/2}]^{\nu+\frac{1}{2}} - [z + (z^2-1)^{1/2}]^{-\nu-\frac{1}{2}} \}$

8.6.10

$Q_{\frac{1}{2}}^\mu(z) = i(\frac{1}{2}\pi)^{1/2} (z^2-1)^{-1/4} [z + (z^2-1)^{1/2}]^{-\nu-\frac{1}{2}}$

8.6.11

$Q_\nu^{-\frac{1}{2}}(z) = -i(2\pi)^{1/2} \frac{(z^2-1)^{-1/4}}{2\nu+1} [z + (z^2-1)^{1/2}]^{-\nu-\frac{1}{2}}$ *

8.6.12

$P_{\frac{1}{2}}^\mu(\cos \theta) = (\frac{1}{2}\pi)^{-\frac{1}{2}} (\sin \theta)^{-\frac{1}{2}} \cos[(\nu + \frac{1}{2})\theta]$

8.6.13

$Q_{\frac{1}{2}}^\mu(\cos \theta) = -(\frac{1}{2}\pi)^{\frac{1}{2}} (\sin \theta)^{-\frac{1}{2}} \sin[(\nu + \frac{1}{2})\theta]$

8.6.14

$P_\nu^{-r}(\cos \theta) = (\frac{1}{2}\pi)^{-\frac{1}{2}} (\nu + \frac{1}{2})^{-1} (\sin \theta)^{-\frac{1}{2}} \sin[(\nu + \frac{1}{2})\theta]$

8.6.15

$Q_\nu^{-\frac{1}{2}}(\cos \theta) = (2\pi)^{-\frac{1}{2}} (2\nu+1)^{-1} (\sin \theta)^{-\frac{1}{2}} \cos[(\nu + \frac{1}{2})\theta]$ *
 $\mu = -\nu$

8.6.16

$P_\nu^{-r}(z) = \frac{2^{-r} (z^2-1)^{\frac{1}{2}r}}{\Gamma(\nu+1)}$

8.6.17

$P_\nu^{-r}(\cos \theta) = \frac{2^{-r} (\sin \theta)^r}{\Gamma(\nu+1)}$
 $\mu = 0, \nu = n$

(Rodrigues' Formula)

8.6.18

$P_n(z) = \frac{1}{2^n n!} \frac{d^n (z^2-1)^n}{dz^n}$

8.6.19

$Q_n(x) = \frac{1}{2} P_n(x) \ln \frac{1+x}{1-x} - W_{n-1}(x)$

where

$W_{n-1}(x) = \frac{2n-1}{1 \cdot n} P_{n-1}(x) + \frac{2n-5}{3(n-1)} P_{n-3}(x) + \frac{2n-9}{5(n-2)} P_{n-5}(x) + \dots$
 $= \sum_{m=1}^n \frac{1}{m} P_{m-1}(x) P_{n-m}(x)$

$W_{-1}(x) = 0$

*See page 11.

$$\nu=0, 1$$

$$8.6.20 \quad \left[\frac{\partial P_\nu(\cos \theta)}{\partial \nu} \right]_{\nu=0} = 2 \ln (\cos \frac{1}{2}\theta)$$

$$8.6.21 \quad \left[\frac{\partial P_\nu^{-1}(\cos \theta)}{\partial \nu} \right]_{\nu=0} = -\tan \frac{1}{2}\theta - 2 \cot \frac{1}{2}\theta \ln (\cos \frac{1}{2}\theta)$$

$$8.6.22 \quad \left[\frac{\partial P_\nu^{-1}(\cos \theta)}{\partial \nu} \right]_{\nu=1} = -\frac{1}{2} \tan \frac{1}{2}\theta \sin^2 \frac{1}{2}\theta + \sin \theta \ln (\cos \frac{1}{2}\theta)$$

8.7. Trigonometric Expansions ($0 < \theta < \pi$)

$$8.7.1 \quad P_\nu^\mu(\cos \theta) = \pi^{-1/2} 2^{\mu+1} (\sin \theta)^\mu \frac{\Gamma(\nu+\mu+1)}{\Gamma(\nu+\frac{3}{2})} \sum_{k=0}^{\infty} \frac{(\mu+\frac{1}{2})_k (\nu+\mu+1)_k}{k! (\nu+\frac{3}{2})_k} \sin [(\nu+\mu+2k+1)\theta]$$

$$8.7.2 \quad Q_\nu^\mu(\cos \theta) = \pi^{1/2} 2^\mu (\sin \theta)^\mu \frac{\Gamma(\nu+\mu+1)}{\Gamma(\nu+\frac{3}{2})} \sum_{k=0}^{\infty} \frac{(\mu+\frac{1}{2})_k (\nu+\mu+1)_k}{k! (\nu+\frac{3}{2})_k} \cos [(\nu+\mu+2k+1)\theta]$$

$$8.7.3 \quad P_n(\cos \theta) = \frac{2^{2n+2} (n!)^2}{\pi (2n+1)!} \left[\sin (n+1)\theta + \frac{n+1}{2n+3} \sin (n+3)\theta + \frac{1 \cdot 3}{2!} \frac{(n+1)(n+2)}{(2n+3)(2n+5)} \sin (n+5)\theta + \dots \right]$$

$$8.7.4 \quad Q_n(\cos \theta) = \frac{2^{2n+1} (n!)^2}{(2n+1)!} \left[\cos (n+1)\theta + \frac{n+1}{2n+3} \cos (n+3)\theta + \frac{1 \cdot 3}{2!} \frac{(n+1)(n+2)}{(2n+3)(2n+5)} \cos (n+5)\theta + \dots \right]$$

8.8. Integral Representations

(z not on the real axis between -1 and $-\infty$)

$$8.8.1 \quad P_\nu^\mu(z) = \frac{2^{-\nu} (z^2-1)^{-1/2\mu}}{\Gamma(-\nu-\mu)\Gamma(\nu+1)} \int_0^\infty (z+\cosh t)^{\mu-\nu-1} (\sinh t)^{2\nu+1} dt \quad (\Re(-\mu) > \Re \nu > -1)$$

$$8.8.2 \quad Q_\nu^\mu(z) = \frac{e^{i\mu\pi} \sqrt{\pi} 2^{-\mu}}{\Gamma(\mu+\frac{1}{2})} \frac{\Gamma(\nu+\mu+1)}{\Gamma(\nu-\mu+1)} (z^2-1)^{1/2\mu} \int_0^\infty [z+(z^2-1)^{1/2} \cosh t]^{-\nu-\mu-1} (\sinh t)^{2\mu} dt \quad (\Re(\nu \pm \mu + 1) > 0)$$

$$8.8.3 \quad Q_n(z) = \frac{1}{2} \int_{-1}^1 (z-t)^{-1} P_n(t) dt = (-1)^{n+1} Q_n(-z)$$

(For other integral representations see [8.2].)

8.9. Summation Formulas

$$8.9.1 \quad (\xi-z) \sum_{m=0}^n (2m+1) P_m(z) P_m(\xi) = (n+1) [P_{n+1}(\xi) P_n(z) - P_n(\xi) P_{n+1}(z)]$$

$$8.9.2 \quad (\xi-z) \sum_{m=0}^n (2m+1) P_m(z) Q_m(\xi) = 1 - (n+1) [P_{n+1}(z) Q_n(\xi) - P_n(z) Q_{n+1}(\xi)]$$

8.10. Asymptotic Expansions

For fixed z and ν and $\Re \mu \rightarrow \infty$, **8.10.1-8.10.3** are asymptotic expansions if z is not on the real axis between $-\infty$ and -1 and $+\infty$ and $+1$. (Upper or lower signs according as $\Im z \geq 0$.)

$$8.10.1 \quad P_\nu^\mu(z) = \frac{\Gamma(\nu+\mu+1)\Gamma(\mu-\nu)}{\pi\Gamma(\mu+1)} \left(\frac{z+1}{z-1}\right)^{1/2\mu} \sin \mu\pi \left[F(-\nu, \nu+1; 1+\mu; \frac{1}{2}+\frac{1}{2}z) - \frac{\sin \nu\pi}{\sin \mu\pi} e^{\mp i\mu\pi} \left(\frac{z-1}{z+1}\right)^\mu F(-\nu, \nu+1; 1+\mu; \frac{1}{2}-\frac{1}{2}z) \right]$$

$$8.10.2 \quad Q_\nu^\mu(z) = \frac{1}{2} e^{i\mu\pi} \frac{\Gamma(\nu+\mu+1)}{\Gamma(\mu+1)} \left(\frac{z+1}{z-1}\right)^{1/2\mu} \Gamma(\mu-\nu) \left[F(-\nu, \nu+1; 1+\mu; \frac{1}{2}+\frac{1}{2}z) - e^{\mp i\mu\pi} \left(\frac{z-1}{z+1}\right)^\mu F(-\nu, \nu+1; 1+\mu; \frac{1}{2}-\frac{1}{2}z) \right]$$

*See page II.

$$8.10.3 \quad Q_{\nu}^{-\mu}(z) = \frac{e^{-i\mu\pi} \csc[\pi(\nu-\mu)]}{2\pi\Gamma(1+\mu)} \left[e^{\mp i\nu\pi} \left(\frac{z+1}{z-1}\right)^{-\frac{1}{2}\mu} F(-\nu, \nu+1; 1+\mu; \frac{1}{2}-\frac{1}{2}z) \right. \\ \left. - \left(\frac{z-1}{z+1}\right)^{-\frac{1}{2}\mu} F(-\nu, \nu+1; 1+\mu; \frac{1}{2}+\frac{1}{2}z) \right]$$

With μ replaced by $-\mu$, 8.1.2 is an asymptotic expansion for $P_{\nu}^{-\mu}(z)$ for fixed z and ν and $\mathcal{R} \mu \rightarrow \infty$ if z is not on the real axis between $-\infty$ and -1 .

For fixed z and μ and $\mathcal{R} \nu \rightarrow \infty$, 8.10.4 and 8.10.6 are asymptotic expansions if z is not on the real axis between $-\infty$ and -1 and $+\infty$ and $+1$; 8.10.5 if z is not on the real axis between $-\infty$ and $+1$.

$$8.10.4 \quad P_{\nu}^{\mu}(z) = (2\pi)^{-\frac{1}{2}} (z^2-1)^{-1/4} \frac{\Gamma(\nu+\mu+1)}{\Gamma(\nu+\frac{3}{2})} \left\{ [z+(z^2-1)^{\frac{1}{2}}]^{\nu+\frac{1}{2}} F(\frac{1}{2}+\mu, \frac{1}{2}-\mu; \frac{3}{2}+\nu; \frac{z+(z^2-1)^{\frac{1}{2}}}{2(z^2-1)^{\frac{1}{2}}}) \right. \\ \left. + i e^{-i\mu\pi} [z-(z^2-1)^{\frac{1}{2}}]^{\nu+\frac{1}{2}} F(\frac{1}{2}+\mu, \frac{1}{2}-\mu; \frac{3}{2}+\nu; \frac{-z+(z^2-1)^{\frac{1}{2}}}{2(z^2-1)^{\frac{1}{2}}}) \right\}$$

$$8.10.5 \quad Q_{\nu}^{\mu}(z) = e^{i\mu\pi} (\frac{1}{2}\pi)^{\frac{1}{2}} (z^2-1)^{-1/4} \frac{\Gamma(\nu+\mu+1)}{\Gamma(\nu+\frac{3}{2})} [z-(z^2-1)^{\frac{1}{2}}]^{\nu+\frac{1}{2}} F(\frac{1}{2}+\mu, \frac{1}{2}-\mu; \frac{3}{2}+\nu; \frac{-z+(z^2-1)^{\frac{1}{2}}}{2(z^2-1)^{\frac{1}{2}}})$$

$$8.10.6 \quad Q_{\nu}^{\mu}(z) = \frac{e^{i\mu\pi} (\frac{1}{2}\pi)^{\frac{1}{2}} (z^2-1)^{-1/4} \Gamma(\mu+\nu)}{\sin[\pi(\mu-\nu)] \Gamma(\frac{1}{2}-\mu)} \left\{ \cos \nu\pi [z+(z^2-1)^{\frac{1}{2}}]^{\nu-\frac{1}{2}} F(\frac{1}{2}+\mu, \frac{1}{2}-\mu; \frac{1}{2}+\nu; \frac{z+(z^2-1)^{\frac{1}{2}}}{2(z^2-1)^{\frac{1}{2}}}) \right. \\ \left. + i e^{i\nu\pi} \cos \mu\pi [z-(z^2-1)^{\frac{1}{2}}]^{\nu-\frac{1}{2}} F(\frac{1}{2}+\mu, \frac{1}{2}-\mu; \frac{1}{2}+\nu; \frac{-z+(z^2-1)^{\frac{1}{2}}}{2(z^2-1)^{\frac{1}{2}}}) \right\}$$

The related asymptotic expansion for $P_{\nu}^{\mu}(z)$ may be derived from 8.10.4 together with 8.2.1.

$$8.10.7 \quad P_{\nu}^{\mu}(\cos \theta) = \frac{\Gamma(\nu+\mu+1)}{\Gamma(\nu+\frac{3}{2})} (\frac{1}{2}\pi \sin \theta)^{-\frac{1}{2}} \cos[(\nu+\frac{1}{2})\theta - \frac{\pi}{4} + \frac{\mu\pi}{2}] + O(\nu^{-1})$$

$$8.10.8 \quad Q_{\nu}^{\mu}(\cos \theta) = \frac{\Gamma(\nu+\mu+1)}{\Gamma(\nu+\frac{3}{2})} \left(\frac{\pi}{2 \sin \theta}\right)^{\frac{1}{2}} \cos[(\nu+\frac{1}{2})\theta + \frac{\pi}{4} + \frac{\mu\pi}{2}] + O(\nu^{-1}) \quad (\epsilon < \theta < \pi - \epsilon, \epsilon > 0)$$

For other asymptotic expansions, see [8.7] and [8.9].

8.11. Toroidal Functions (or Ring Functions)

(Only special properties are given; other properties and representations follow from the earlier sections.)

$$8.11.1 \quad P_{\nu-\frac{1}{2}}^{\mu}(\cosh \eta) = [\Gamma(1-\mu)]^{-1} 2^{2\mu} (1-e^{-2\eta})^{-\mu} e^{-(\nu+\frac{1}{2})\eta} F(\frac{1}{2}-\mu, \frac{1}{2}+\nu-\mu; 1-2\mu; 1-e^{-2\eta})$$

$$8.11.2 \quad P_{n-\frac{1}{2}}^m(\cosh \eta) = \frac{\Gamma(n+m+\frac{1}{2})(\sinh \eta)^m}{\Gamma(n-m+\frac{1}{2}) 2^m \sqrt{\pi} \Gamma(m+\frac{1}{2})} \int_0^{\pi} \frac{(\sin \varphi)^{2m} d\varphi}{(\cosh \eta + \cos \varphi \sinh \eta)^{n+m+\frac{1}{2}}}$$

$$8.11.3 \quad Q_{\nu-\frac{1}{2}}^{\mu}(\cosh \eta) = [\Gamma(1+\nu)]^{-1} \sqrt{\pi} e^{i\mu\pi} \Gamma(\frac{1}{2}+\nu+\mu) (1-e^{-2\eta})^{\mu} e^{-(\nu+\frac{1}{2})\eta} F(\frac{1}{2}+\mu, \frac{1}{2}+\nu+\mu; 1+\nu; e^{-2\eta}) \quad *$$

$$8.11.4 \quad Q_{n-\frac{1}{2}}^m(\cosh \eta) = \frac{(-1)^m \Gamma(n+\frac{1}{2})}{\Gamma(n-m+\frac{1}{2})} \int_0^{\infty} \frac{\cosh mt dt}{(\cosh \eta + \cosh t \sinh \eta)^{n+\frac{1}{2}}} \quad * \quad (n > m)$$

*See page II.

8.12. Conical Functions

$$(P_{-\frac{1}{2}+i\lambda}(\cos \theta), Q_{-\frac{1}{2}+i\lambda}(\cos \theta))$$

(Only special properties are given as other properties and representations follow from earlier sections with $\nu = -\frac{1}{2} + i\lambda$ (λ , a real parameter) and $z = \cos \theta$.)

8.12.1

$$P_{-\frac{1}{2}+i\lambda}(\cos \theta) = 1 + \frac{4\lambda^2 + 1^2}{2^2} \sin^2 \frac{\theta}{2} + \frac{(4\lambda^2 + 1^2)(4\lambda^2 + 3^2)}{2^2 4^2} \sin^4 \frac{\theta}{2} + \dots \quad (0 \leq \theta < \pi)$$

8.12.2 $P_{-\frac{1}{2}+i\lambda}(\cos \theta) = P_{-\frac{1}{2}-i\lambda}(\cos \theta)$

8.12.3 $P_{-\frac{1}{2}+i\lambda}(\cos \theta) = \frac{2}{\pi} \int_0^\theta \frac{\cosh \lambda t dt}{\sqrt{2(\cos t - \cos \theta)}}$

8.12.4

$$Q_{-\frac{1}{2}+i\lambda}(\cos \theta) = \pm i \sinh \lambda \pi \int_0^\infty \frac{\cos \lambda t dt}{\sqrt{2(\cosh t + \cos \theta)}} + \int_0^\infty \frac{\cosh \lambda t dt}{\sqrt{2(\cosh t - \cos \theta)}}$$

8.12.5

$$P_{-\frac{1}{2}+i\lambda}(-\cos \theta) = \frac{\cosh \lambda \pi}{\pi} [Q_{-\frac{1}{2}+i\lambda}(\cos \theta) + Q_{-\frac{1}{2}-i\lambda}(\cos \theta)]$$

* 8.13. Relation to Elliptic Integrals (see chapter 17) ($\mathcal{R}\eta > 0$)

8.13.1 $P_{-\frac{1}{2}}(z) = \frac{2}{\pi} \sqrt{\frac{2}{z+1}} K\left(\sqrt{\frac{z-1}{z+1}}\right)$

8.13.2 $P_{-\frac{1}{2}}(\cosh \eta) = \left[\frac{\pi}{2} \cosh \frac{\eta}{2}\right]^{-1} K\left(\tanh \frac{\eta}{2}\right)$

8.13.3 $Q_{-\frac{1}{2}}(z) = \sqrt{\frac{2}{z+1}} K\left(\sqrt{\frac{2}{z+1}}\right)$

8.13.4 $Q_{-\frac{1}{2}}(\cosh \eta) = 2e^{-\eta/2} K(e^{-\eta})$

8.13.5

$$P_{\frac{1}{2}}(z) = \frac{2}{\pi} (z + \sqrt{z^2 - 1})^{\frac{1}{2}} E\left(\sqrt{\frac{2(z^2 - 1)^{1/2}}{z + (z^2 - 1)^{1/2}}}\right)$$

8.13.6 $P_{\frac{1}{2}}(\cosh \eta) = \frac{2}{\pi} e^{\eta/2} E(\sqrt{1 - e^{-2\eta}})$

8.13.7

$$Q_{\frac{1}{2}}(z) = z \sqrt{\frac{2}{z+1}} K\left(\sqrt{\frac{2}{z+1}}\right) - [2(z+1)]^{\frac{1}{2}} E\left(\sqrt{\frac{2}{z+1}}\right) \quad (-1 < x < 1) *$$

8.13.8 $P_{-1}(x) = \frac{2}{\pi} K\left(\sqrt{\frac{1-x}{2}}\right)$

8.13.9 $P_{-1}(\cos \theta) = \frac{2}{\pi} K\left(\sin \frac{\theta}{2}\right)$

8.13.10 $Q_{-1}(x) = K\left(\sqrt{\frac{1+x}{2}}\right) *$

8.13.11 $P_{\frac{1}{2}}(x) = \frac{2}{\pi} \left[2E\left(\sqrt{\frac{1-x}{2}}\right) - K\left(\sqrt{\frac{1-x}{2}}\right)\right]$

8.13.12 $Q_{\frac{1}{2}}(x) = K\left(\sqrt{\frac{1+x}{2}}\right) - 2E\left(\sqrt{\frac{1+x}{2}}\right) *$

8.14. Integrals

8.14.1 $\int_1^\infty P_\nu(x) Q_\rho(x) dx = [(\rho - \nu)(\rho + \nu + 1)]^{-1} \quad (\mathcal{R}\rho > \mathcal{R}\nu > 0)$

8.14.2 $\int_1^\infty Q_\nu(x) Q_\rho(x) dx = [(\rho - \nu)(\rho + \nu + 1)]^{-1} [\psi(\rho + 1) - \psi(\nu + 1)] \quad (\mathcal{R}(\rho + \nu) > -1, \rho + \nu + 1 \neq 0; \nu, \rho \neq -1, -2, -3, \dots)$

8.14.3 $\int_1^\infty [Q_\nu(x)]^2 dx = (2\nu + 1)^{-1} \psi'(\nu + 1) \quad (\mathcal{R}\nu > -\frac{1}{2})$

8.14.4 $\int_{-1}^1 P_\nu(x) P_\rho(x) dx = \frac{2}{\pi^2} [(\rho - \nu)(\rho + \nu + 1)]^{-1} \{2 \sin \pi \nu \sin \pi \rho [\psi(\nu + 1) - \psi(\rho + 1)] + \pi \sin(\pi \rho - \pi \nu)\} \quad (\rho + \nu + 1 \neq 0)$

8.14.5 $\int_{-1}^1 [P_\nu(x)]^2 dx = \frac{\pi^2 - 2(\sin \pi \nu)^2 \psi'(\nu + 1)}{\pi^2(\nu + \frac{1}{2})} *$

8.14.6 $\int_{-1}^1 Q_\nu(x) Q_\rho(x) dx = [(\rho - \nu)(\rho + \nu + 1)]^{-1} \{[\psi(\nu + 1) - \psi(\rho + 1)][1 + \cos \rho \pi \cos \nu \pi] - \frac{1}{2} \pi \sin(\nu \pi - \rho \pi)\} \quad (\rho + \nu + 1 \neq 0; \nu, \rho \neq -1, -2, -3, \dots)$

8.14.7 $\int_{-1}^1 [Q_\nu(x)]^2 dx = (2\nu + 1)^{-1} \{ \frac{1}{2} \pi^2 - \psi'(\nu + 1) [1 + (\cos \nu \pi)^2] \} \quad (\nu \neq -1, -2, -3, \dots)$

*See page 11.

$$8.14.8 \int_{-1}^1 P_\nu(x) Q_\rho(x) dx = [(\nu - \rho)(\rho + \nu + 1)]^{-1} \left\{ 1 - \cos(\rho\pi - \nu\pi) - \frac{2}{\pi} \sin \pi\nu \cos \pi\nu [\psi(\nu + 1) - \psi(\rho + 1)] \right\}$$

($\Re \nu > 0, \Re \rho > 0, \rho \neq \nu$)

$$8.14.9 \int_{-1}^1 P_\nu(x) Q_\nu(x) dx = -\frac{1}{\pi} (2\nu + 1)^{-1} \sin 2\nu\pi \psi'(\nu + 1)$$

($\Re \nu > 0$)

(m, n, l positive integers)

8.14.10

$$\int_{-1}^1 Q_n^m(x) P_l^m(x) dx = (-1)^m \frac{1 - (-1)^{l+n} (n+m)!}{(l-n)(l+n+1)(n-m)!}$$

$$8.14.11 \int_{-1}^1 P_n^m(x) P_l^m(x) dx = 0 \quad (l \neq n)$$

$$8.14.12 \int_{-1}^1 P_n^m(x) P_n^l(x) (1-x^2)^{-1} dx = 0 \quad (l \neq m)$$

$$8.14.13 \int_{-1}^1 [P_n^m(x)]^2 dx = (n + \frac{1}{2})^{-1} (n+m)! / (n-m)!$$

8.14.14

$$\int_{-1}^1 (1-x^2)^{-1} [P_n^m(x)]^2 dx = (n+m)! / m(n-m)!$$

8.14.15

$$\int_0^1 P_\nu(x) x^\rho dx = \frac{\pi^{1/2} 2^{-\rho-1} \Gamma(1+\rho)}{\Gamma(1 + \frac{1}{2}\rho - \frac{1}{2}\nu) \Gamma(\frac{1}{2}\rho + \frac{1}{2}\nu + \frac{1}{2})}$$

($\Re \rho > -1$)

8.14.16

$$\int_0^\pi (\sin t)^{\alpha-1} P_\nu^{-\mu}(\cos t) dt = \frac{2^{-\nu} \pi \Gamma(\frac{1}{2}\alpha + \frac{1}{2}\mu) \Gamma(\frac{1}{2}\alpha - \frac{1}{2}\mu)}{\Gamma(\frac{1}{2} + \frac{1}{2}\alpha + \frac{1}{2}\nu) \Gamma(\frac{1}{2}\alpha - \frac{1}{2}\nu) \Gamma(\frac{1}{2}\mu + \frac{1}{2}\nu + 1) \Gamma(\frac{1}{2}\mu - \frac{1}{2}\nu + \frac{1}{2})}$$

($\Re(\alpha \pm \mu) > 0$)

8.14.17

$$P_\nu^{-m}(z) = (z^2 - 1)^{-\frac{1}{2}m} \int_1^z \dots \int_1^z P_\nu(z) (dz)^m$$

8.14.18

$$Q_\nu^{-m}(z) = (-1)^m (z^2 - 1)^{-\frac{1}{2}m} \int_z^\infty \dots \int_z^\infty Q_\nu(z) (dz)^m$$

For other integrals, see [8.2], [8.4] and chapter 22.

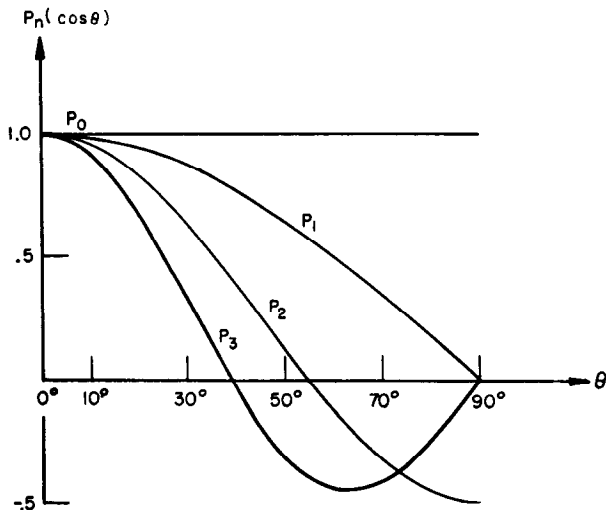

FIGURE 8.1. $P_n(\cos \theta)$. $n=0(1)3$.

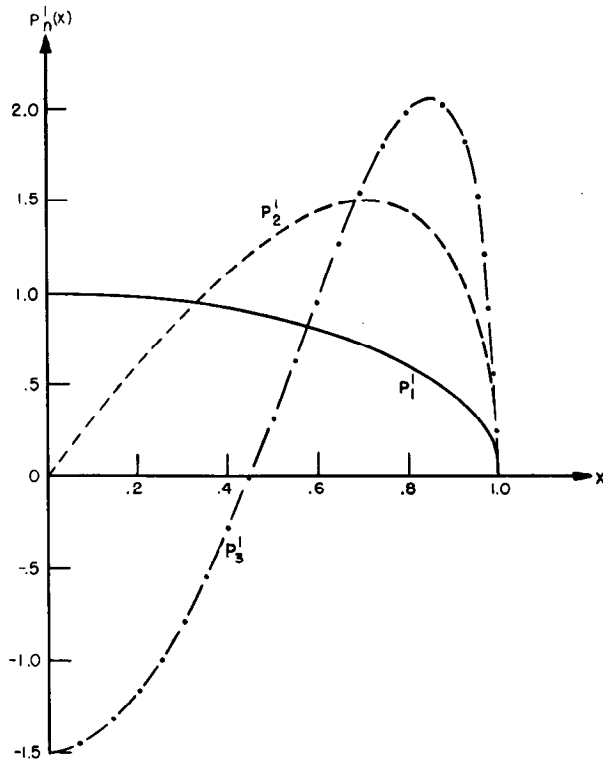

FIGURE 8.2. $P_n^l(x)$. $n=1(1)3, x \leq 1$.

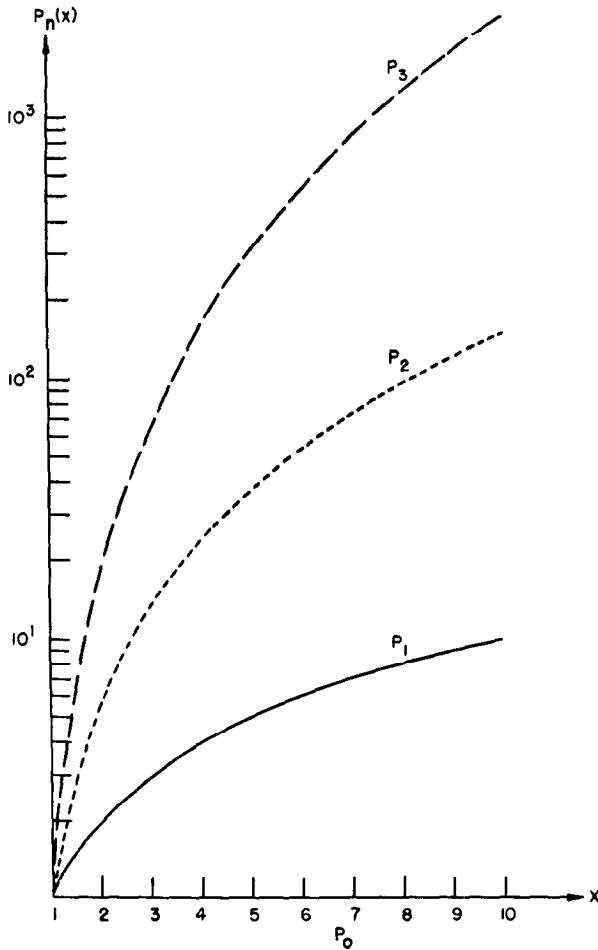

FIGURE 8.3. $P_n(x)$. $n=0(1)3, x \geq 1$.

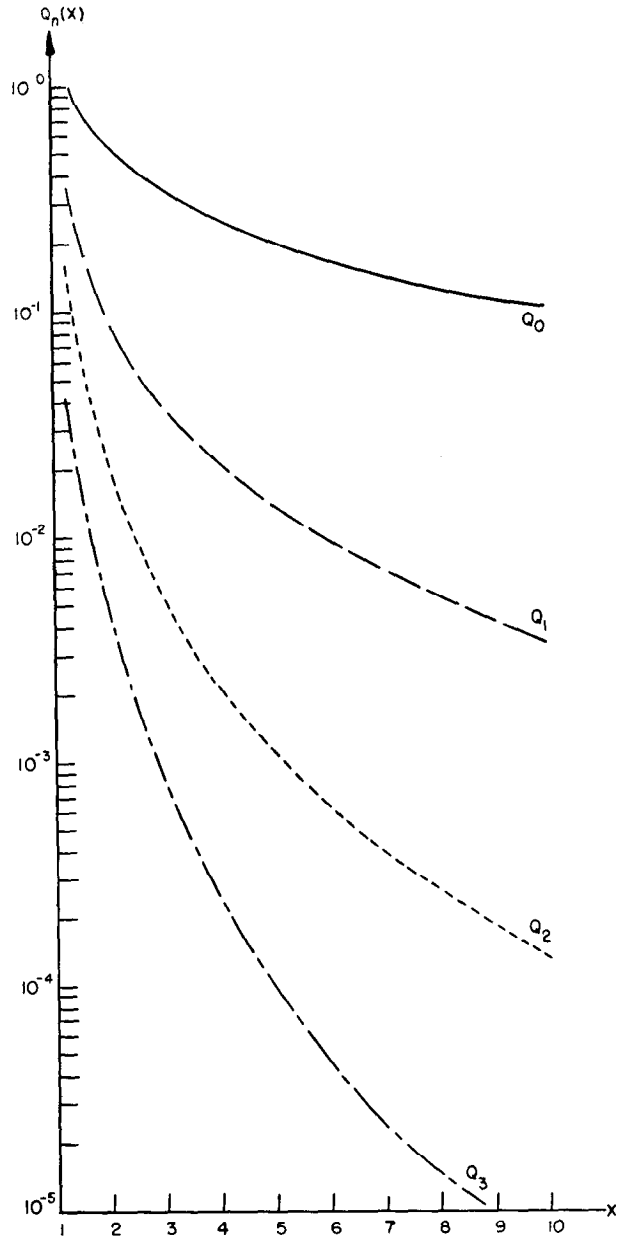

FIGURE 8.5. $Q_n(x)$. $n=0(1)3, x > 1$.

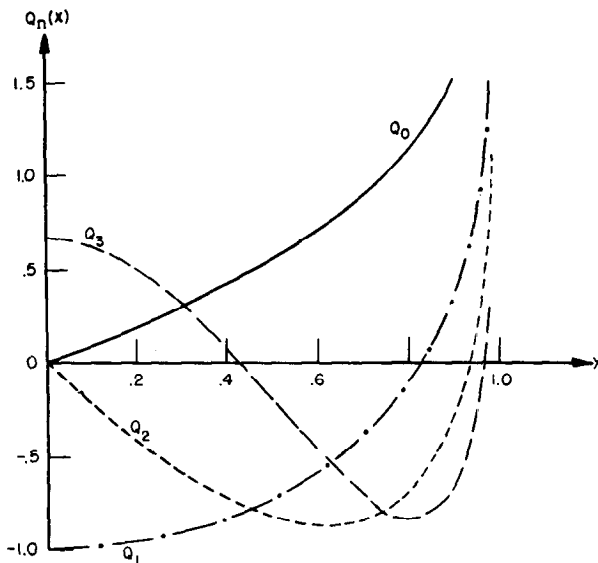

FIGURE 8.4. $Q_n(x)$. $n=0(1)3, x < 1$.

Numerical Methods

8.15. Use and Extension of the Tables

Computation of $P_n(x)$

For all values of x there is very little loss of significant figures (except at zeros) in using the recurrence relation 8.5.3 for increasing values of n .

Example 1. Compute $P_n(x)$ for $x=.31415\ 92654$ and $x=2.6$ for $n=2(1)8$.

n	$P_n(.31415\ 92654)$	$P_n(2.6)$
0	1	1
1	.31415 92654	2.6
2	-.35195 59340	9.64
3	-.39372 32064	40.04
4	.04750 63122	174.952
5	.34184 27517	786.74336
6	.15729 86975	3604.350016
7	-.20123 39354	16729.51005
8	-.25617 29328	78402.55522

Computing $P_8(x)$ using **Table 22.9** carrying ten significant figures, $P_8(.31415\ 92654) = -.25617\ 2933$ and $P_8(2.6) = 78402.55526$.

Computation of $Q_n(x)$

For $x < 1$, use of **8.5.3** for increasing values of n leads to very little loss of significant figures. However, for $x > 1$, the recurrence relation **8.5.3** should be used only for decreasing values of n , after having first obtained Q_n using the formulas in terms of hypergeometric functions.

Example 2. Compute $Q_n(x)$ for $x = .31415\ 92654$ and $n = 0(1)4$.

With the aid of **8.4.2** and **8.4.4** we obtain

n	$Q_n(.31415\ 92654)$
0	.32515 34813
1	-.89785 00212
2	-.58567 85953
3	.29190 60854
4	.59974 26989

Using the results of **Example 1** together with **8.6.19**, we find $Q_4(x) = \frac{1}{2}P_4(x)\ln\left(\frac{1+x}{1-x}\right) - W_3(x)$ where $W_3 = \frac{7}{4}P_3 + \frac{1}{3}P_1$, giving $Q_4(.31415\ 92654) = .59974\ 26989$.

Example 3. Compute $Q_5(x)$ for $x = 2.6$.

Ten terms in the series for $F\left(\frac{\nu+2}{2}, \frac{\nu+1}{2}; \nu+\frac{3}{2}; \frac{1}{z^2}\right)$ of **8.1.3** are necessary to obtain nine significant figures giving $Q_5(2.6) = 4.8182\ 4468 \times 10^{-5}$. Using **8.5.3** with increasing values of n carrying ten significant figures we obtain

n	$Q_n(2.6)$
0	.40546 51081
1	.05420 928
2	.00868 364
3	.00148 95
4	.00026 49
5	.00004 81

where Q_0 and Q_1 are obtained using **8.4.2** and **8.4.4**.

Computation of $P_{\pm\frac{1}{2}}(x)$, $Q_{\pm\frac{1}{2}}(x)$

For all values of x , $P_{\pm\frac{1}{2}}(x)$ and $Q_{\pm\frac{1}{2}}(x)$ are most easily computed by means of **8.13**.

Example 4. Compute $Q_{-\frac{1}{2}}(x)$ for $x = 2.6$.

Using **8.13.3** and interpolating in **Table 17.1** for $K(.5)$, we find

$$\begin{aligned} Q_{-\frac{1}{2}}(2.6) &= \sqrt{\frac{2}{x+1}} K\left(\sqrt{\frac{2}{x+1}}\right) \\ &= (.74535\ 59925)(1.90424\ 1417) \\ &= 1.41933\ 7751. \end{aligned}$$

On the other hand, at least nine terms in the expansion of $F\left(\frac{\nu+2}{2}, \frac{\nu+1}{2}; \nu+\frac{3}{2}; \frac{1}{z^2}\right)$ of **8.1.3** are necessary to obtain comparable accuracy.

References

Texts

[8.1] A. Erdélyi et al., Higher transcendental functions, vol. 1, ch. 3 (McGraw-Hill Book Co., Inc., New York, N.Y., 1953).
 [8.2] E. W. Hobson, The theory of spherical and ellipsoidal harmonics (Chelsea Publishing Co., New York, N.Y., 1955).
 [8.3] J. Lense, Kugelfunktionen (Akademische Verlagsgesellschaft, Leipzig, Germany, 1950).
 [8.4] T. M. MacRobert, Spherical harmonics, 2d rev. ed. (Dover Publications, Inc., New York, N.Y., 1948).
 [8.5] W. Magnus and F. Oberhettinger, Formulas and theorems for the special functions of mathematical physics (Chelsea Publishing Co., New York, N.Y., 1949).
 [8.6] G. Prasad, A treatise on spherical harmonics and the functions of Bessel and Lamé, Part II (Advanced) (Mahamandal Press, Benares City, India, 1932).

[8.7] L. Robin, Fonctions sphériques de Legendre e fonctions sphéroïdales. Tome I, II, III (Gauthier-Villars, Paris, France, 1957).
 [8.8] C. Snow, Hypergeometric and Legendre functions with applications to integral equations of potential theory, NBS Applied Math. Series 19 (U.S. Government Printing Office, Washington, D.C., 1952).
 [8.9] R. C. Thorne, The asymptotic expansion of Legendre functions of large degree and order, Philos. Trans. Roy. Soc. London **249**, 597-620 (1957).

Tables

[8.10] H. Bateman, Some problems in potential theory, Mess. of Math., **617**, 52, 73-75 (1922). $P_n(\cosh \sigma)$, $Q_n(\cosh \sigma)$, $P'_n(\cosh \sigma)$, $Q'_n(\cosh \sigma)$; $\cosh \sigma = 1.1$, $n = 0(1)20$, 10D; $\cosh \sigma = 1.2$, 2, 3; $n = 0(1)10$, exact or 10D.

- [8.11] Centre National d'Études des Télécommunications, Tables des fonctions de Legendre associées. Fonction associée de première espèce $P_n^m(\cos \theta)$ (Éditions de La Revue d'Optique, Paris, France, 1952). $n = -\frac{1}{2}(1)10$, $m = 0(1)5$, $\theta = 0^\circ(1^\circ)90^\circ$ (variable number of figures).
- [8.12] Centre National d'Études des Télécommunications, Tables numérique des fonctions associées de Legendre. Fonctions associées de première espèce $P_n^m(\cos \theta)$ (Éditions de La Revue d'Optique, Paris, France, 1959). $n = -\frac{1}{2}(1)10$, $m = 0(1)2$, $\theta = 0^\circ(1^\circ)180^\circ$ (variable number of figures).
- [8.13] G. C. Clark and S. W. Churchill, Table of Legendre polynomials $P_n(\cos \theta)$ for $n = 0(1)80$ and $\theta = 0^\circ(1^\circ)180^\circ$, Engineering Research Institute Publications (Univ. of Michigan Press, Ann Arbor, Mich., 1957).
- [8.14] R. O. Gumprecht and G. M. Sliepcevic, Tables of functions of the first and second partial derivatives of Legendre polynomials (Univ. of Michigan Press, Ann Arbor, Mich., 1951). Values of $[x\pi_n - (1-x^2)\pi_n'] \cdot 10^4$ and $\pi_n 10^4$ for $\gamma = 0^\circ(10^\circ)170^\circ(1^\circ)180^\circ$, $n = 1(1)420$, 5S.
- [8.15] M. E. Lynam, Table of Legendre functions for complex arguments TG-323, The Johns Hopkins Univ. Applied Physics Laboratory, Baltimore, Md. (1958).
- [8.16] National Bureau of Standards, Tables of associated Legendre functions (Columbia Univ. Press, New York, N.Y., 1945). $P_n^m(\cos \theta)$, $\frac{d}{d\theta} P_n^m(\cos \theta)$, $n = 1(1)10$, $m(\leq n) = 0(1)4$, $\theta = 0^\circ(1^\circ)90^\circ$, 6S;

- $$P_n^m(x), \frac{d}{dx} P_n^m(x), \quad n = 1(1)10, \quad (-1)^m Q_n^m(x),$$
- $$(-1)^{m+1} \frac{d}{dx} Q_n^m(x), \quad n = 0(1)10, \quad m(\leq n) = 0(1)4, \quad x = 1(1)10,$$
- 6S or exact; $i^{-n} P_n^m(ix)$, $i^{-n} \frac{d}{dx} P_n^m(ix)$, $n = 1(1)10$,
- $$i^{n+2m+1} Q_n^m(ix), \quad i^{n+2m-1} \frac{d}{dx} Q_n^m(ix), \quad n = 0(1)10, \quad m(\leq n)$$
- $$= 0(1)4, \quad x = 0(1)10, \quad 6S; \quad P_{n+\frac{1}{2}}^m(x), \quad \frac{d}{dx} P_{n-\frac{1}{2}}^m(x),$$
- $$(-1)^m Q_{n-\frac{1}{2}}^m(x), \quad (-1)^{m+1} \frac{d}{dx} Q_{n+\frac{1}{2}}^m(x), \quad n = -1(1)4,$$
- $$m = 0(1)4, \quad x = 1(1)10, \quad 4-6S.$$
- [8.17] G. Prevost, Tables des fonctions sphériques et de leurs intégrales (Gauthier-Villars, Bordeaux and Paris, France, 1933). $P_n(x)$, $\int_0^x P_n(t) dt$, $n = 1(1)10$;
- $$P_n^j(x), \quad \int_0^x P_n^j(t) dt, \quad n = 0(1)8, \quad j = 0(1)n, \quad x = 0(1)1,$$
- 5S.
- [8.18] H. Tallqvist, Sechsstellige Tafeln der 32 ersten Kugelfunktionen $P_n(\cos \theta)$, Acta Soc. Sci. Fenn., Nova Series A, II, 11 (1938). $P_n(\cos \theta)$, $n = 1(1)32$, $0^\circ(10^\circ)90^\circ$; 6D.
- [8.19] H. Tallqvist, Acta Soc. Sci. Fenn., Nova Series A, II, 4(1937). $P_n(x)$, $n = 1(1)16$, $x = 0(1)1$, 6D.
- [8.20] H. Tallqvist, Tafeln der Kugelfunktionen $P_{25}(\cos \theta)$ bis $P_{32}(\cos \theta)$, Soc. Sci. Fenn. Comment. Phys.-Math., VI, 10(1932). $P_n(\cos \theta)$, $n = 25(1)32$, $\theta = 0^\circ(1^\circ)90^\circ$, 5D.
- [8.21] H. Tallqvist, Tafeln der 24 ersten Kugelfunktionen $P_n(\cos \theta)$, Soc. Sci. Fenn. Comment. Phys.-Math., VI, 3(1932). $P_n(\cos \theta)$, $n = 1(1)24$, $\theta = 0^\circ(1^\circ)90^\circ$, 5D.

Table 8.1

LEGENDRE FUNCTION—FIRST KIND $P_n(x)$

x	$\arccos x$	$P_0(x)$	$P_1(x)$	$P_2(x)$	$P_3(x)$	$P_4(x)$	$P_{10}(x)$
0.00	90.00000 00	-0.50000	0.00000 00	0.00000 00	0.00000 000	-0.24609 37	
0.01	89.42703 26	-0.49985	-0.01499 75	-0.01499 75	0.02457 330	-0.24474 14	
0.02	88.85400 80	-0.49940	-0.02998 00	-0.02998 00	0.04893 045	-0.24069 84	
0.03	88.28086 87	-0.49865	-0.04493 25	-0.04493 25	0.07285 701	-0.23400 69	
0.04	87.70755 72	-0.49760	-0.05984 00	-0.05984 00	0.09614 188	-0.22473 64	
0.05	87.13401 60	-0.49625	-0.07468 75	-0.07468 75	0.11857 899	-0.21298 35	
0.06	86.56018 72	-0.49460	-0.08946 00	-0.08946 00	0.13996 890	-0.19887 11	
0.07	85.98601 28	-0.49265	-0.10414 25	-0.10414 25	0.16012 040	-0.18254 68	
0.08	85.41143 43	-0.49040	-0.11872 00	-0.11872 00	0.17885 206	-0.16418 20	
0.09	84.83639 29	-0.48785	-0.13317 75	-0.13317 75	0.19599 366	-0.14397 02	
0.10	84.26082 95	-0.48500	-0.14750 00	-0.14750 00	0.21138 764	-0.12212 50	
0.11	83.68468 44	-0.48185	-0.16167 25	-0.16167 25	0.22489 042	-0.09887 86	
0.12	83.10789 74	-0.47840	-0.17568 00	-0.17568 00	0.23637 363	-0.07447 93	
0.13	82.53040 77	-0.47465	-0.18950 75	-0.18950 75	0.24572 526	-0.04918 90	
0.14	81.95215 37	-0.47060	-0.20314 00	-0.20314 00	0.25285 070	-0.02328 12	
0.15	81.37307 34	-0.46625	-0.21656 25	-0.21656 25	0.25767 367	+0.00296 18	
0.16	80.79310 38	-0.46160	-0.22976 00	-0.22976 00	0.26013 706	0.02925 20	
0.17	80.21218 10	-0.45665	-0.24271 75	-0.24271 75	0.26020 358	0.05529 81	
0.18	79.63024 02	-0.45140	-0.25542 00	-0.25542 00	0.25785 632	0.08080 85	
0.19	79.04721 58	-0.44585	-0.26785 25	-0.26785 25	0.25309 918	0.10549 42	
0.20	78.46304 10	-0.44000	-0.28000 00	-0.28000 00	0.24595 712	0.12907 20	
0.21	77.87764 77	-0.43385	-0.29184 75	-0.29184 75	0.23647 631	0.15126 74	
0.22	77.29096 70	-0.42740	-0.30338 00	-0.30338 00	0.22472 407	0.17181 75	
0.23	76.70292 82	-0.42065	-0.31458 25	-0.31458 25	0.21078 870	0.19047 36	
0.24	76.11345 96	-0.41360	-0.32544 00	-0.32544 00	0.19477 914	0.20700 49	
0.25	75.52248 78	-0.40625	-0.33593 75	-0.33593 75	0.17682 442	0.22120 02	
0.26	74.92993 79	-0.39860	-0.34606 00	-0.34606 00	0.15707 305	0.23287 14	
0.27	74.33573 31	-0.39065	-0.35579 25	-0.35579 25	0.13569 215	0.24185 52	
0.28	73.73979 53	-0.38240	-0.36512 00	-0.36512 00	0.11286 642	0.24801 62	
0.29	73.14204 40	-0.37385	-0.37402 75	-0.37402 75	0.08879 707	0.25124 81	
0.30	72.54239 69	-0.36500	-0.38250 00	-0.38250 00	0.06370 038	0.25147 63	
0.31	71.94076 95	-0.35585	-0.39052 25	-0.39052 25	0.03780 634	0.24865 91	
0.32	71.33707 51	-0.34640	-0.39808 00	-0.39808 00	+0.01135 691	0.24278 89	
0.33	70.73122 45	-0.33665	-0.40515 75	-0.40515 75	-0.01539 566	0.23389 37	
0.34	70.12312 59	-0.32660	-0.41174 00	-0.41174 00	-0.04219 085	0.22203 73	
0.35	69.51268 49	-0.31625	-0.41781 25	-0.41781 25	-0.06876 185	0.20732 00	
0.36	68.89980 39	-0.30560	-0.42336 00	-0.42336 00	-0.09483 780	0.18987 83	
0.37	68.28438 27	-0.29465	-0.42836 75	-0.42836 75	-0.12014 608	0.16988 48	
0.38	67.66631 73	-0.28340	-0.43282 00	-0.43282 00	-0.14441 472	0.14754 72	
0.39	67.04550 06	-0.27185	-0.43670 25	-0.43670 25	-0.16737 489	0.12310 73	
0.40	66.42182 15	-0.26000	-0.44000 00	-0.44000 00	-0.18876 356	0.09683 91	
0.41	65.79516 52	-0.24785	-0.44269 75	-0.44269 75	-0.20832 609	0.06904 71	
0.42	65.16541 25	-0.23540	-0.44478 00	-0.44478 00	-0.22581 900	0.04006 39	
0.43	64.53243 99	-0.22265	-0.44623 25	-0.44623 25	-0.24101 269	+0.01024 69	
0.44	63.89611 88	-0.20960	-0.44704 00	-0.44704 00	-0.25369 426	-0.02002 45	
0.45	63.25631 61	-0.19625	-0.44718 75	-0.44718 75	-0.26367 022	-0.05035 30	
0.46	62.61289 25	-0.18260	-0.44666 00	-0.44666 00	-0.27076 932	-0.08032 72	
0.47	61.96570 35	-0.16865	-0.44544 25	-0.44544 25	-0.27484 521	-0.10952 64	
0.48	61.31459 80	-0.15440	-0.44352 00	-0.44352 00	-0.27577 908	-0.13752 51	
0.49	60.65941 84	-0.13985	-0.44087 75	-0.44087 75	-0.27348 225	-0.16389 87	
0.50	60.00000 00	-0.12500	-0.43750 00	-0.43750 00	-0.26789 856	-0.18822 86	

$$P_2(x) = \frac{1}{2}(-1 + 3x^2) \quad P_3(x) = \frac{x}{2}(-3 + 5x^2)$$

$$P_9(x) = \frac{x}{512}(1260 - 18480x^2 + 72072x^4 - 102960x^6 + 48620x^8)$$

$$P_{10}(x) = \frac{1}{1024}(-252 + 13860x^2 - 120120x^4 + 360360x^6 - 437580x^8 + 184756x^{10})$$

$$(n+1)P_{n+1}(x) = (2n+1)xP_n(x) - nP_{n-1}(x)$$

For coefficients of other polynomials, see chapter 22.

LEGENDRE FUNCTION—FIRST KIND $P_n(x)$

Table 8.1

		$P_0(x)=1$	$P_1(x)=x$		
x	arccos x	$P_2(x)$	$P_3(x)$	$P_9(x)$	$P_{10}(x)$
0.50	60.00000 00	-0.12500	-0.43750 00	-0.26789 856	-0.18822 86
0.51	59.33617 03	-0.10985	-0.43337 25	-0.25900 667	-0.21010 83
0.52	58.66774 85	-0.09440	-0.42848 00	-0.24682 215	-0.22914 92
0.53	57.99454 51	-0.07865	-0.42280 75	-0.23139 939	-0.24498 73
0.54	57.31636 11	-0.06260	-0.41634 00	-0.21283 321	-0.25728 92
0.55	56.63298 70	-0.04625	-0.40906 25	-0.19126 025	-0.26575 85
0.56	55.94420 22	-0.02960	-0.40096 00	-0.16686 000	-0.27014 28
0.57	55.24977 42	-0.01265	-0.39201 75	-0.13985 552	-0.27023 97
0.58	54.54945 74	+0.00460	-0.38222 00	-0.11051 366	-0.26590 30
0.59	53.84299 18	0.02215	-0.37155 25	-0.07914 497	-0.25704 92
0.60	53.13010 24	0.04000	-0.36000 00	-0.04610 304	-0.24366 27
0.61	52.41049 70	0.05815	-0.34754 75	-0.01178 332	-0.22580 16
0.62	51.68386 55	0.07660	-0.33418 00	+0.02337 862	-0.20360 19
0.63	50.94987 75	0.09535	-0.31988 25	0.05890 951	-0.17728 16
0.64	50.20818 05	0.11440	-0.30464 00	0.09430 141	-0.14714 41
0.65	49.45839 81	0.13375	-0.28843 75	0.12901 554	-0.11358 05
0.66	48.70012 72	0.15340	-0.27126 00	0.16248 693	-0.07707 01
0.67	47.93293 52	0.17335	-0.25309 25	0.19412 981	-0.03818 08
0.68	47.15635 69	0.19360	-0.23392 00	0.22334 410	+0.00243 30
0.69	46.36989 11	0.21415	-0.21372 75	0.24952 270	0.04403 37
0.70	45.57299 60	0.23500	-0.19250 00	0.27205 993	0.08580 58
0.71	44.76508 47	0.25615	-0.17022 25	0.29036 111	0.12686 31
0.72	43.94551 96	0.27760	-0.14688 00	0.30385 323	0.16625 89
0.73	43.11360 59	0.29935	-0.12245 75	0.31199 698	0.20299 76
0.74	42.26858 44	0.32140	-0.09694 00	0.31430 004	0.23605 08
0.75	41.40962 21	0.34375	-0.07031 25	0.31033 185	0.26437 45
0.76	40.53580 21	0.36640	-0.04256 00	0.29973 981	0.28693 19
0.77	39.64611 11	0.38935	-0.01366 75	0.28226 712	0.30271 79
0.78	38.73942 46	0.41260	+0.01638 00	0.25777 224	0.31078 93
0.79	37.81448 85	0.43615	0.04759 75	0.22625 012	0.31029 79
0.80	36.86989 76	0.46000	0.08000 00	0.18785 528	0.30052 98
0.81	35.90406 86	0.48415	0.11360 25	0.14292 678	0.28094 87
0.82	34.91520 62	0.50860	0.14842 00	0.09201 529	0.25124 52
0.83	33.90126 20	0.53335	0.18446 75	+0.03591 226	0.21139 19
0.84	32.85988 04	0.55840	0.22176 00	-0.02431 874	0.16170 50
0.85	31.78833 06	0.58375	0.26031 25	-0.08730 820	0.10291 23
0.86	30.68341 71	0.60940	0.30014 00	-0.15134 456	+0.03622 91
0.87	29.54136 05	0.63535	0.34125 75	-0.21433 544	-0.03655 86
0.88	28.35763 66	0.66160	0.38368 00	-0.27376 627	-0.11300 29
0.89	27.12675 31	0.68815	0.42742 25	-0.32665 610	-0.18989 29
0.90	25.84193 28	0.71500	0.47250 00	-0.36951 049	-0.26314 56
0.91	24.49464 85	0.74215	0.51892 75	-0.39827 146	-0.32768 58
0.92	23.07391 81	0.76960	0.56672 00	-0.40826 421	-0.37731 58
0.93	21.56518 50	0.79735	0.61589 25	-0.39414 060	-0.40457 43
0.94	19.94844 36	0.82540	0.66646 00	-0.34981 919	-0.40058 29
0.95	18.19487 23	0.85375	0.71843 75	-0.26842 182	-0.35488 03
0.96	16.26020 47	0.88240	0.77184 00	-0.14220 642	-0.25524 34
0.97	14.06986 77	0.91135	0.82668 25	+0.03750 397	-0.08749 40
0.98	11.47834 09	0.94060	0.88298 00	0.28039 609	+0.16470 81
0.99	8.10961 44	0.97015	0.94074 75	0.59724 553	0.52008 90

1.00 0.00000 00 1.00000 1.00000 00 1.00000 000 1.00000 00

$\left[\begin{matrix} (-5)4 \\ 3 \end{matrix} \right]$ $\left[\begin{matrix} (-4)2 \\ 4 \end{matrix} \right]$ $\left[\begin{matrix} (-2)1 \\ 7 \end{matrix} \right]$ $\left[\begin{matrix} (-2)2 \\ 7 \end{matrix} \right]$

$P_2(x) = \frac{1}{2}(-1+3x^2)$ $P_3(x) = \frac{x}{2}(-3+5x^2)$

$P_9(x) = \frac{x}{512}(1260 - 18480x^2 + 72072x^4 - 102960x^6 + 48620x^8)$

$P_{10}(x) = \frac{1}{1024}(-252 + 13860x^2 - 120120x^4 + 360360x^6 - 437580x^8 + 184756x^{10})$

$(n+1)P_{n+1}(x) = (2n+1)xP_n(x) - nP_{n-1}(x)$

For coefficients of other polynomials, see chapter 22.

Table 8.2 DERIVATIVE OF THE LEGENDRE FUNCTION—FIRST KIND $P'_n(x)$

x	$P'_3(x)$	$P'_4(x)$	$P'_9(x)$	$P'_{10}(x)$
0.00	-1.50000	0.00000 00	2.46093 75	0.00000 00
0.01	-1.49925	-0.07498 25	2.45011 64	0.27023 41
0.02	-1.49700	-0.14986 00	2.41773 75	0.53765 93
0.03	-1.49325	-0.22452 75	2.36405 34	0.79949 17
0.04	-1.48800	-0.29888 00	2.28948 35	1.05299 82
0.05	-1.48125	-0.37281 25	2.19461 13	1.29552 05
0.06	-1.47300	-0.44622 00	2.08018 11	1.52449 98
0.07	-1.46325	-0.51899 75	1.94709 32	1.73750 05
0.08	-1.45200	-0.59104 00	1.79639 87	1.93223 25
0.09	-1.43925	-0.66224 25	1.62929 31	2.10657 29
0.10	-1.42500	-0.73250 00	1.44710 87	2.25858 73
0.11	-1.40925	-0.80170 75	1.25130 64	2.38654 80
0.12	-1.39200	-0.86976 00	1.04346 68	2.48895 24
0.13	-1.37325	-0.93655 25	0.82528 00	2.56453 90
0.14	-1.35300	-1.00198 00	0.59853 47	2.61230 18
0.15	-1.33125	-1.06593 75	0.36510 73	2.63150 28
0.16	-1.30800	-1.12832 00	+0.12694 88	2.62168 25
0.17	-1.28325	-1.18902 25	-0.11392 76	2.58266 81
0.18	-1.25700	-1.24794 00	-0.35546 01	2.51458 04
0.19	-1.22925	-1.30496 75	-0.59555 27	2.41783 68
0.20	-1.20000	-1.36000 00	-0.83208 96	2.29315 33
0.21	-1.16925	-1.41293 25	-1.06295 03	2.14154 35
0.22	-1.13700	-1.46366 00	-1.28602 54	1.96431 51
0.23	-1.10325	-1.51207 75	-1.49923 18	1.76306 37
0.24	-1.06800	-1.55808 00	-1.70052 94	1.53966 43
0.25	-1.03125	-1.60156 25	-1.88793 72	1.29625 99
0.26	-0.99300	-1.64242 00	-2.05954 92	1.03524 77
0.27	-0.95325	-1.68054 75	-2.21355 15	0.75926 26
0.28	-0.91200	-1.71584 00	-2.34823 78	0.47115 77
0.29	-0.86925	-1.74819 25	-2.46202 63	+0.17398 30
0.30	-0.82500	-1.77750 00	-2.55347 51	-0.12903 87
0.31	-0.77925	-1.80365 75	-2.62129 80	-0.43453 90
0.32	-0.73200	-1.82656 00	-2.66437 95	-0.73903 23
0.33	-0.68325	-1.84610 25	-2.68178 96	-1.03894 72
0.34	-0.63300	-1.86218 00	-2.67279 74	-1.33065 96
0.35	-0.58125	-1.87468 75	-2.63688 47	-1.61052 81
0.36	-0.52800	-1.88352 00	-2.57375 82	-1.87493 10
0.37	-0.47325	-1.88857 25	-2.48336 07	-2.12030 43
0.38	-0.41700	-1.88974 00	-2.36588 14	-2.34318 21
0.39	-0.35925	-1.88691 75	-2.22176 52	-2.54023 74
0.40	-0.30000	-1.88000 00	-2.05172 01	-2.70832 36
0.41	-0.23925	-1.86888 25	-1.85672 35	-2.84451 75
0.42	-0.17700	-1.85346 00	-1.63802 69	-2.94616 13
0.43	-0.11325	-1.83362 75	-1.39715 86	-3.01090 51
0.44	-0.04800	-1.80928 00	-1.13592 50	-3.03674 96
0.45	+0.01875	-1.78031 25	-0.85640 91	-3.02208 63
0.46	0.08700	-1.74662 00	-0.56096 76	-2.96573 83
0.47	0.15675	-1.70809 75	-0.25222 53	-2.86699 80
0.48	0.22800	-1.66464 00	+0.06693 30	-2.72566 30
0.49	0.30075	-1.61614 25	0.39337 29	-2.54206 98
0.50	0.37500	-1.56250 00	0.72372 44	-2.31712 34

$$\left[\begin{matrix} (-4) \\ 3 \end{matrix} \right]$$

$$\left[\begin{matrix} (-4) \\ 4 \end{matrix} \right]$$

$$\left[\begin{matrix} (-3) \\ 6 \end{matrix} \right]$$

$$\left[\begin{matrix} (-3) \\ 6 \end{matrix} \right]$$

$$P'_3(x) = \frac{1}{2}(-3 + 15x^2) \quad P'_4(x) = \frac{x}{8}(-60 + 140x^2)$$

$$P'_9(x) = \frac{1}{512}(1260 - 55440x^2 + 360360x^4 - 720720x^6 + 437580x^8)$$

$$P'_{10}(x) = \frac{x}{1024}(27720 - 480480x^2 + 2162160x^4 - 3500640x^6 + 1847560x^8)$$

$$P'_n(x) = \frac{n+1}{1-x^2}[xP_n(x) - P_{n+1}(x)]$$

DERIVATIVE OF THE LEGENDRE FUNCTION—FIRST KIND $P'_n(x)$

Table 8.2

x	$P'_3(x)$	$P'_4(x)$	$P'_9(x)$	$P'_{10}(x)$
		$P'_1(x)=1$	$P'_2(x)=3x$	
0.50	0.37500	- 1.56250 00	0.72372 44	- 2.31712 34
0.51	0.45075	- 1.50360 75	1.05439 75	- 2.05232 40
0.52	0.52800	- 1.43936 00	1.38160 24	- 1.74978 82
0.53	0.60675	- 1.36965 25	1.70137 21	- 1.41226 67
0.54	0.68700	- 1.29438 00	2.00958 86	- 1.04315 43
0.55	0.76875	- 1.21343 75	2.30201 29	- 0.64649 54
0.56	0.85200	- 1.12672 00	2.57431 87	- 0.22698 16
0.57	0.93675	- 1.03412 25	2.82213 05	+ 0.21005 92
0.58	1.02300	- 0.93554 00	3.04106 49	0.65868 10
0.59	1.11075	- 0.83086 75	3.22677 77	1.11234 92
0.60	1.20000	- 0.72000 00	3.37501 44	1.56397 82
0.61	1.29075	- 0.60283 25	3.48166 60	2.00598 31
0.62	1.38300	- 0.47926 00	3.54283 00	2.43034 08
0.63	1.47675	- 0.34917 75	3.55487 57	2.82866 68
0.64	1.57200	- 0.21248 00	3.51451 63	3.19230 45
0.65	1.66875	- 0.06906 25	3.41888 50	3.51243 07
0.66	1.76700	+ 0.08118 00	3.26561 84	3.78017 74
0.67	1.86675	0.23835 25	3.05294 51	3.98677 13
0.68	1.96800	0.40256 00	2.77978 03	4.12369 16
0.69	2.07075	0.57390 75	2.44582 82	4.18284 84
0.70	2.17500	0.75250 00	2.05168 93	4.15678 18
0.71	2.28075	0.93844 25	1.59897 66	4.03888 45
0.72	2.38800	1.13184 00	1.09043 73	3.82364 72
0.73	2.49675	1.33279 75	+ 0.53008 28	3.50693 03
0.74	2.60700	1.54142 00	- 0.07667 36	3.08626 20
0.75	2.71875	1.75781 25	- 0.72287 14	2.56116 49
0.76	2.83200	1.98208 00	- 1.39984 93	1.93351 26
0.77	2.94675	2.21432 75	- 2.09708 32	1.20791 71
0.78	3.06300	2.45466 00	- 2.80201 52	+ 0.39215 05
0.79	3.18075	2.70318 25	- 3.49987 45	- 0.50239 96
0.80	3.30000	2.96000 00	- 4.17348 81	- 1.46023 77
0.81	3.42075	3.22521 75	- 4.80308 26	- 2.46122 91
0.82	3.54300	3.49894 00	- 5.36607 64	- 3.48002 97
0.83	3.66675	3.78127 25	- 5.83686 10	- 4.48547 21
0.84	3.79200	4.07232 00	- 6.18657 35	- 5.43990 91
0.85	3.91875	4.37218 75	- 6.38285 68	- 6.29851 03
0.86	4.04700	4.68098 00	- 6.38961 06	- 7.00851 07
0.87	4.17675	4.99880 25	- 6.16672 97	- 7.50840 93
0.88	4.30800	5.32576 00	- 5.66983 23	- 7.72711 51
0.89	4.44075	5.66195 75	- 4.84997 54	- 7.58303 90
0.90	4.57500	6.00750 00	- 3.65335 89	- 6.98312 79
0.91	4.71075	6.36249 25	- 2.02101 73	- 5.82184 03
0.92	4.84800	6.72704 00	+ 0.11150 20	- 3.98006 04
0.93	4.98675	7.10124 75	2.81447 18	- 1.32394 73
0.94	5.12700	7.48522 00	6.16433 35	+ 2.29628 14
0.95	5.26875	7.87906 25	10.24405 70	7.04763 58
0.96	5.41200	8.28288 00	15.14351 59	13.11571 11
0.97	5.55675	8.69677 75	20.95987 66	20.70612 01
0.98	5.70300	9.12086 00	27.79800 16	30.04600 25
0.99	5.85075	9.55523 25	35.77086 77	41.38561 43
1.00	6.00000	10.00000 00	45.00000 00	55.00000 00
	$\left[\begin{smallmatrix} (-4)2 \\ 3 \end{smallmatrix} \right]$	$\left[\begin{smallmatrix} (-3)1 \\ 4 \end{smallmatrix} \right]$	$\left[\begin{smallmatrix} (-1)2 \\ 7 \end{smallmatrix} \right]$	$\left[\begin{smallmatrix} (-1)3 \\ 7 \end{smallmatrix} \right]$

$$P'_3(x) = \frac{1}{2}(-3 + 15x^2) \quad P'_4(x) = \frac{x}{8}(-60 + 140x^2)$$

$$P'_9(x) = \frac{1}{512}(1260 - 55440x^2 + 360360x^4 - 720720x^6 + 437580x^8)$$

$$P'_{10}(x) = \frac{x}{1024}(27720 - 480480x^2 + 2162160x^4 - 3500640x^6 + 1847560x^8)$$

$$P'_n(x) = \frac{n+1}{1-x^2} [xP_n(x) - P_{n+1}(x)]$$

Table 8.3 LEGENDRE FUNCTION—SECOND KIND $Q_n(x)$

x	$Q_0(x)$	$Q_1(x)$	$Q_2(x)$	$Q_3(x)$	$Q_4(x)$	$Q_{10}(x)$
0.00	0.00000 000	-1.00000 000	0.00000 000	0.66666 667	-0.40634 921	0.00000 000
0.01	0.01000 033	-0.99990 000	-0.01999 867	0.66626 669	-0.40452 191	-0.04056 181
0.02	0.02000 267	-0.99959 995	-0.03998 933	0.66506 699	-0.39905 538	-0.08068 584
0.03	0.03000 900	-0.99909 973	-0.05996 399	0.66306 829	-0.38999 553	-0.11993 860
0.04	0.04002 135	-0.99839 915	-0.07991 463	0.66027 179	-0.37741 852	-0.15789 513
0.05	0.05004 173	-0.99749 791	-0.09983 321	0.65667 917	-0.36143 026	-0.19414 321
0.06	0.06007 216	-0.99639 567	-0.11971 169	0.65229 261	-0.34216 562	-0.22828 745
0.07	0.07011 467	-0.99509 197	-0.13954 199	0.64711 475	-0.31978 750	-0.25995 321
0.08	0.08017 133	-0.99358 629	-0.15931 602	0.64114 873	-0.29448 565	-0.28879 038
0.09	0.09024 419	-0.99187 802	-0.17902 563	0.63439 817	-0.26647 538	-0.31447 701
0.10	0.10033 535	-0.98996 647	-0.19866 264	0.62686 720	-0.23599 595	-0.33672 259
0.11	0.11044 692	-0.98785 084	-0.21821 885	0.61856 044	-0.20330 891	-0.35527 122
0.12	0.12058 103	-0.98553 028	-0.23768 596	0.60948 299	-0.16869 616	-0.36990 435
0.13	0.13073 985	-0.98300 382	-0.25705 567	0.59964 048	-0.13245 792	-0.38044 330
0.14	0.14092 558	-0.98027 042	-0.27631 958	0.58903 905	-0.09491 050	-0.38675 142
0.15	0.15114 044	-0.97732 893	-0.29546 923	0.57768 532	-0.05638 395	-0.38873 587
0.16	0.16138 670	-0.97417 813	-0.31449 610	0.56558 646	-0.01721 959	-0.38634 905
0.17	0.17166 666	-0.97081 667	-0.33339 158	0.55275 016	+0.02223 260	-0.37958 962
0.18	0.18198 269	-0.96724 312	-0.35214 699	0.53918 465	0.06161 670	-0.36850 308
0.19	0.19233 717	-0.96345 594	-0.37075 353	0.52489 868	0.10057 361	-0.35318 198
0.20	0.20273 255	-0.95945 349	-0.38920 232	0.50990 155	0.13874 395	-0.33376 565
0.21	0.21317 135	-0.95523 402	-0.40748 439	0.49420 314	0.17577 093	-0.31043 947
0.22	0.22365 611	-0.95079 566	-0.42559 062	0.47781 388	0.21130 336	-0.28343 378
0.23	0.23418 947	-0.94613 642	-0.44351 180	0.46074 476	0.24499 861	-0.25302 221
0.24	0.24477 411	-0.94125 421	-0.46123 857	0.44300 738	0.27652 557	-0.21951 969
0.25	0.25541 281	-0.93614 680	-0.47876 145	0.42461 393	0.30556 765	-0.18327 994
0.26	0.26610 841	-0.93081 181	-0.49607 081	0.40557 719	0.33182 571	-0.14469 251
0.27	0.27686 382	-0.92524 677	-0.51315 685	0.38591 059	0.35502 089	-0.10417 949
0.28	0.28768 207	-0.91944 902	-0.53000 962	0.36562 819	0.37489 746	-0.06219 173
0.29	0.29856 626	-0.91341 578	-0.54661 900	0.34474 467	0.39122 551	-0.01920 468
0.30	0.30951 960	-0.90714 412	-0.56297 466	0.32327 542	0.40380 351	+0.02428 610
0.31	0.32054 541	-0.90063 092	-0.57906 608	0.30123 647	0.41246 080	0.06776 975
0.32	0.33164 711	-0.89387 293	-0.59488 256	0.27864 459	0.41705 981	0.11072 534
0.33	0.34282 825	-0.88686 668	-0.61041 313	0.25551 723	0.41749 822	0.15262 723
0.34	0.35409 253	-0.87960 854	-0.62564 662	0.23187 261	0.41371 084	0.19295 076
0.35	0.36544 375	-0.87209 469	-0.64057 159	0.20772 970	0.40567 128	0.23117 811
0.36	0.37688 590	-0.86432 108	-0.65517 633	0.18310 825	0.39339 336	0.26680 432
0.37	0.38842 310	-0.85628 345	-0.66944 887	0.15802 883	0.37693 227	0.29934 337
0.38	0.40005 965	-0.84797 733	-0.68337 690	0.13251 285	0.35638 546	0.32833 437
0.39	0.41180 003	-0.83939 799	-0.69694 784	0.10658 256	0.33189 317	0.35334 774
0.40	0.42364 893	-0.83054 043	-0.71014 872	0.08026 114	0.30363 867	0.37399 123
0.41	0.43561 122	-0.82139 940	-0.72296 624	0.05357 267	0.27184 811	0.38991 596
0.42	0.44769 202	-0.81196 935	-0.73538 670	+0.02654 221	0.23679 006	0.40082 218
0.43	0.45989 668	-0.80224 443	-0.74739 600	-0.00080 418	0.19877 461	0.40646 477
0.44	0.47223 080	-0.79221 845	-0.75897 958	-0.02843 939	0.15815 208	0.40665 845
0.45	0.48470 028	-0.78188 487	-0.77012 243	-0.05633 524	0.11531 136	0.40128 259
0.46	0.49731 129	-0.77123 681	-0.78080 904	-0.08446 239	0.07067 773	0.39028 551
0.47	0.51007 034	-0.76026 694	-0.79102 336	-0.11279 034	+0.02471 030	0.37368 827
0.48	0.52298 428	-0.74896 755	-0.80074 877	-0.14128 732	-0.02210 100	0.35158 779
0.49	0.53606 034	-0.73733 044	-0.80996 804	-0.16992 027	-0.06923 897	0.32415 933
0.50	0.54930 614	-0.72534 693	-0.81866 327	-0.19865 477	-0.11616 303	0.29165 814

$$\begin{aligned}
 Q_0(x) &= \frac{1}{2} \ln \left(\frac{1+x}{1-x} \right) & Q_1(x) &= \frac{x}{2} \ln \left(\frac{1+x}{1-x} \right) - 1 \\
 Q_2(x) &= \frac{3x^2-1}{4} \ln \left(\frac{1+x}{1-x} \right) - \frac{3x}{2} & Q_3(x) &= \frac{x}{4} (5x^2-3) \ln \left(\frac{1+x}{1-x} \right) - \frac{5x^2}{2} + \frac{2}{3}
 \end{aligned}$$

$$(n+1)Q_{n+1}(x) = (2n+1)xQ_n(x) - nQ_{n-1}(x)$$

$Q_0(x) = \operatorname{arctanh} x$ (Table 4.17) is included here for completeness.

LEGENDRE FUNCTION—SECOND KIND $Q_n(x)$

Table 8.3

x	$Q_0(x)$	$Q_1(x)$	$Q_2(x)$	$Q_3(x)$	$Q_9(x)$	$Q_{10}(x)$
0.50	0.54930 614	-0.72534 693	-0.81866 327	-0.19865 477	-0.11616 303	+0.29165 814
0.51	0.56272 977	-0.71300 782	-0.82681 587	-0.22745 494	-0.16231 372	0.25442 027
0.52	0.57633 975	-0.70030 333	-0.83440 647	-0.25628 339	-0.20711 759	0.21286 243
0.53	0.59014 516	-0.68722 307	-0.84141 492	-0.28510 113	-0.24999 263	0.16748 087
0.54	0.60415 560	-0.67375 597	-0.84782 014	-0.31386 748	-0.29035 406	0.11884 913
0.55	0.61838 131	-0.65989 028	-0.85360 014	-0.34253 994	-0.32762 069	0.06761 470
0.56	0.63283 319	-0.64561 342	-0.85873 186	-0.37107 413	-0.36122 172	+0.01449 441
0.57	0.64752 284	-0.63091 198	-0.86319 116	-0.39942 362	-0.39060 386	-0.03973 144
0.58	0.66246 271	-0.61577 163	-0.86695 267	-0.42753 983	-0.41523 901	-0.09422 630
0.59	0.67766 607	-0.60017 702	-0.86998 970	-0.45537 186	-0.43463 218	-0.14810 594
0.60	0.69314 718	-0.58411 169	-0.87227 411	-0.48286 632	-0.44832 986	-0.20044 847
0.61	0.70892 136	-0.56755 797	-0.87377 622	-0.50996 718	-0.45592 864	-0.25030 577
0.62	0.72500 509	-0.55049 685	-0.87446 461	-0.53661 553	-0.45708 410	-0.29671 648
0.63	0.74141 614	-0.53290 783	-0.87430 597	-0.56274 938	-0.45151 989	-0.33872 031
0.64	0.75817 374	-0.51476 880	-0.87326 492	-0.58830 338	-0.43903 693	-0.37537 391
0.65	0.77529 871	-0.49605 584	-0.87130 380	-0.61320 855	-0.41952 271	-0.40576 815
0.66	0.79281 363	-0.47674 300	-0.86838 239	-0.63739 196	-0.39296 048	-0.42904 673
0.67	0.81074 313	-0.45680 211	-0.86445 768	-0.66077 634	-0.35943 834	-0.44442 606
0.68	0.82911 404	-0.43620 245	-0.85948 352	-0.68327 969	-0.31915 810	-0.45121 636
0.69	0.84795 576	-0.41491 053	-0.85341 027	-0.70481 480	-0.27244 363	-0.44884 377
0.70	0.86730 053	-0.39288 963	-0.84618 438	-0.72528 868	-0.21974 878	-0.43687 329
0.71	0.88718 386	-0.37009 946	-0.83774 785	-0.74460 199	-0.16166 443	-0.41503 236
0.72	0.90764 498	-0.34649 561	-0.82803 775	-0.76264 823	-0.09892 467	-0.38323 471
0.73	0.92872 736	-0.32202 902	-0.81698 546	-0.77931 296	-0.03241 178	-0.34160 431
0.74	0.95047 938	-0.29664 526	-0.80451 593	-0.79447 280	+0.03684 038	-0.29049 884
0.75	0.97295 507	-0.27028 369	-0.79054 669	-0.80799 424	0.10764 474	-0.23053 218
0.76	0.99621 508	-0.24287 654	-0.77498 679	-0.81973 225	0.17866 149	-0.16259 543
0.77	1.02032 776	-0.21434 763	-0.75773 539	-0.82952 866	0.24840 151	-0.08787 565
0.78	1.04537 055	-0.18461 097	-0.73868 011	-0.83721 016	0.31523 275	-0.00787 146
0.79	1.07143 168	-0.15356 897	-0.71769 507	-0.84258 586	0.37739 063	+0.07559 560
0.80	1.09861 229	-0.12111 017	-0.69463 835	-0.84544 435	0.43299 312	0.16037 522
0.81	1.12702 903	-0.08710 649	-0.66934 890	-0.84555 002	0.48006 146	0.24398 961
0.82	1.15681 746	-0.05140 968	-0.64164 264	-0.84263 849	0.51654 781	0.32364 357
0.83	1.18813 640	-0.01384 678	-0.61130 745	-0.83641 078	0.54037 123	0.39624 661
0.84	1.22117 352	+0.02578 575	-0.57809 671	-0.82652 589	0.54946 418	0.45844 913
0.85	1.25615 281	0.06772 989	-0.54172 080	-0.81259 105	0.54183 191	0.50669 726
0.86	1.29334 467	0.11227 642	-0.50183 576	-0.79414 886	0.51562 828	0.53731 190
0.87	1.33307 963	0.15977 928	-0.45802 786	-0.77065 991	0.46925 273	0.54659 757
0.88	1.37576 766	0.21067 554	-0.40979 212	-0.74147 880	0.40147 508	0.53099 253
0.89	1.42192 587	0.26551 403	-0.35650 171	-0.70582 022	0.31159 776	0.48727 156
0.90	1.47221 949	0.32499 754	-0.29736 306	-0.66270 962	0.19967 037	0.41282 291
0.91	1.52752 443	0.39004 723	-0.23134 775	-0.61090 890	+0.06677 934	0.30602 901
0.92	1.58902 692	0.46190 476	-0.15708 489	-0.54880 000	-0.08454 828	+0.16680 029
0.93	1.65839 002	0.54230 272	-0.07268 272	-0.47419 336	-0.24975 925	-0.00265 428
0.94	1.73804 934	0.63376 638	+0.02458 593	-0.38399 297	-0.42137 701	-0.19666 273
0.95	1.83178 082	0.74019 178	0.13888 288	-0.27356 330	-0.58752 240	-0.40421 502
0.96	1.94591 015	0.86807 374	0.27707 112	-0.13540 204	-0.72921 201	-0.60564 435
0.97	2.09229 572	1.02952 685	0.45181 370	+0.04408 092	-0.81464 729	-0.76587 179
0.98	2.29755 993	1.25160 873	0.69108 487	0.29436 613	-0.78406 452	-0.81720 735
0.99	2.64665 241	1.62018 589	1.08264 984	0.70624 831	-0.48875 677	-0.59305 105

1.00 ∞ ∞ ∞ ∞ ∞

$$Q_0(x) = \frac{1}{2} \ln \left(\frac{1+x}{1-x} \right) \qquad Q_1(x) = \frac{x}{2} \ln \left(\frac{1+x}{1-x} \right) - 1$$

$$Q_2(x) = \frac{3x^2-1}{4} \ln \left(\frac{1+x}{1-x} \right) - \frac{3x}{2} \qquad Q_3(x) = \frac{x}{4} (5x^2-3) \ln \left(\frac{1+x}{1-x} \right) - \frac{5x^2}{2} + \frac{2}{3}$$

$$(n+1)Q_{n+1}(x) = (2n+1)xQ_n(x) - nQ_{n-1}(x)$$

Table 8.4 DERIVATIVE OF THE LEGENDRE FUNCTION—SECOND KIND $Q'_n(x)$

x	$Q'_0(x)$	$Q'_1(x)$	$Q'_2(x)$	$Q'_3(x)$	$Q'_4(x)$	$Q'_5(x)$	$Q'_{10}(x)$
0.00	1.00000 000	0.00000 000	-2.00000 000	0.00000 000	0.00000 000	0.00000 00	-4.06349 21
0.01	1.00010 001	0.02000 133	-1.99959 998	-0.07999 200	0.36520 25	0.36520 25	-4.04156 71
0.02	1.00040 016	0.04001 067	-1.99839 968	-0.15993 599	0.72733 83	0.72733 83	-3.97600 70
0.03	1.00090 081	0.06003 603	-1.99639 838	-0.23978 392	1.08336 24	1.08336 24	-3.86745 44
0.04	1.00160 256	0.08008 546	-1.99359 487	-0.31948 767	1.43027 23	1.43027 23	-3.71697 43
0.05	1.00250 627	0.10016 704	-1.98998 747	-0.39899 900	1.76512 98	1.76512 98	-3.52604 61
0.06	1.00361 301	0.12028 894	-1.98557 401	-0.47826 951	2.08508 14	2.08508 14	-3.29655 13
0.07	1.00492 413	0.14045 936	-1.98035 179	-0.55725 060	2.38737 90	2.38737 90	-3.03075 84
0.08	1.00644 122	0.16068 662	-1.97431 766	-0.63589 347	2.66939 94	2.66939 94	-2.73130 45
0.09	1.00816 615	0.18097 914	-1.96746 792	-0.71414 899	2.92866 44	2.92866 44	-2.40117 40
0.10	1.01010 101	0.20134 545	-1.95979 839	-0.79196 777	3.16285 86	3.16285 86	-2.04367 37
0.11	1.01224 820	0.22179 422	-1.95130 431	-0.86930 001	3.36984 76	3.36984 76	-1.66240 59
0.12	1.01461 039	0.24233 428	-1.94198 044	-0.94609 554	3.54769 49	3.54769 49	-1.26123 82
0.13	1.01719 052	0.26297 462	-1.93182 094	-1.02230 373	3.69467 78	3.69467 78	-0.84427 11
0.14	1.01999 184	0.28372 443	-1.92081 942	-1.09787 345	3.80930 18	3.80930 18	-0.41580 27
0.15	1.02301 790	0.30459 312	-1.90896 890	-1.17275 302	3.89031 48	3.89031 48	+0.01970 77
0.16	1.02627 258	0.32559 031	-1.89626 181	-1.24689 019	3.93671 92	3.93671 92	0.45767 92
0.17	1.02976 007	0.34672 587	-1.88268 994	-1.32023 203	3.94778 25	3.94778 25	0.89344 90
0.18	1.03348 491	0.36800 997	-1.86824 444	-1.39272 496	3.92304 76	3.92304 76	1.32231 56
0.19	1.03745 202	0.38945 305	-1.85291 580	-1.46431 458	3.86234 02	3.86234 02	1.73958 08
0.20	1.04166 667	0.41106 589	-1.83669 380	-1.53494 573	3.76577 54	3.76577 54	2.14059 95
0.21	1.04613 453	0.43285 960	-1.81956 752	-1.60456 234	3.63376 26	3.63376 26	2.52079 44
0.22	1.05086 171	0.45484 568	-1.80152 526	-1.67310 742	3.46700 84	3.46700 84	2.87577 54
0.23	1.05585 471	0.47703 605	-1.78255 455	-1.74052 294	3.26651 77	3.26651 77	3.20128 51
0.24	1.06112 054	0.49944 304	-1.76264 210	-1.80674 982	3.03359 33	3.03359 33	3.49331 81
0.25	1.06666 667	0.52207 948	-1.74177 372	-1.87172 780	2.76983 31	2.76983 31	3.74813 48
0.26	1.07250 107	0.54495 869	-1.71993 437	-1.93539 537	2.47712 56	2.47712 56	3.96230 97
0.27	1.07863 229	0.56809 454	-1.69710 801	-1.99768 972	2.15764 35	2.15764 35	4.13277 26
0.28	1.08506 944	0.59150 152	-1.67327 761	-2.05854 661	1.81383 48	1.81383 48	4.25684 84
0.29	1.09182 225	0.61519 472	-1.64842 510	-2.11790 027	1.44841 22	1.44841 22	4.33229 46
0.30	1.09890 110	0.63918 993	-1.62253 126	-2.17568 334	1.06434 02	1.06434 02	4.35733 72
0.31	1.10631 707	0.66350 370	-1.59557 570	-2.23182 672	0.66482 02	0.66482 02	4.33070 22
0.32	1.11408 200	0.68815 335	-1.56753 678	-2.28625 944	+0.25327 32	+0.25327 32	4.25164 55
0.33	1.12220 851	0.71315 706	-1.53839 152	-2.33890 860	-0.16667 95	-0.16667 95	4.11997 79
0.34	1.13071 009	0.73853 396	-1.50811 553	-2.38969 914	-0.59123 78	-0.59123 78	3.93608 76
0.35	1.13960 114	0.76430 415	-1.47668 292	-2.43855 378	-1.01644 63	-1.01644 63	3.70095 66
0.36	1.14889 706	0.79048 884	-1.44406 617	-2.48539 281	-1.43822 04	-1.43822 04	3.41617 42
0.37	1.15861 430	0.81711 039	-1.41023 606	-2.53013 394	-1.85237 43	-1.85237 43	3.08394 42
0.38	1.16877 045	0.84419 242	-1.37516 155	-2.57269 210	-2.25465 05	-2.25465 05	2.70708 74
0.39	1.17938 436	0.87175 994	-1.33880 960	-2.61297 926	-2.64075 25	-2.64075 25	2.28903 82
0.40	1.19047 619	0.89983 941	-1.30114 509	-2.65090 420	-3.00637 81	-3.00637 81	1.83383 54
0.41	1.20206 756	0.92845 892	-1.26213 064	-2.68637 229	-3.34725 61	-3.34725 61	1.34610 61
0.42	1.21418 164	0.95764 831	-1.22172 641	-2.71928 520	-3.65918 35	-3.65918 35	0.83104 35
0.43	1.22684 333	0.98743 931	-1.17988 995	-2.74954 067	-3.93806 51	-3.93806 51	+0.29437 81
0.44	1.24007 937	1.01786 572	-1.13657 597	-2.77703 216	-4.17995 45	-4.17995 45	-0.25765 92
0.45	1.25391 850	1.04896 360	-1.09173 613	-2.80164 855	-4.38109 69	-4.38109 69	-0.81838 00
0.46	1.26839 168	1.08077 146	-1.04531 874	-2.82327 375	-4.53797 26	-4.53797 26	-1.38069 01
0.47	1.28353 228	1.11333 051	-0.99726 854	-2.84178 630	-4.64734 21	-4.64734 21	-1.93714 78
0.48	1.29937 630	1.14668 490	-0.94752 634	-2.85705 896	-4.70629 25	-4.70629 25	-2.48003 04
0.49	1.31596 263	1.18088 202	-0.89602 868	-2.86895 817	-4.71228 35	-4.71228 35	-3.00140 86
0.50	1.33333 333	1.21597 281	-0.84270 745	-2.87734 353	-4.66319 54	-4.66319 54	-3.49322 79
	$\left[\begin{smallmatrix} (-4) \\ 5 \end{smallmatrix} \right]$	$\left[\begin{smallmatrix} (-4) \\ 5 \end{smallmatrix} \right]$	$\left[\begin{smallmatrix} (-4) \\ 5 \end{smallmatrix} \right]$	$\left[\begin{smallmatrix} (-4) \\ 5 \end{smallmatrix} \right]$	$\left[\begin{smallmatrix} (-3) \\ 6 \end{smallmatrix} \right]$	$\left[\begin{smallmatrix} (-3) \\ 6 \end{smallmatrix} \right]$	$\left[\begin{smallmatrix} (-3) \\ 6 \end{smallmatrix} \right]$

Table 8.5

LEGENDRE FUNCTION—FIRST KIND $P_n(x)$

x	$P_2(x)$	$P_3(x)$	$P_4(x)$	$P_5(x)$	$P_6(x)$	$P_{10}(x)$
			$P_0(x)=1$	$P_1(x)=x$		
1.0	1.00	1.00	1.00000	1.00000	1.00000	1.00000
1.2	1.66	2.52	4.04700	6.72552	(1)6.02754	(2)1.06544
1.4	2.44	4.76	9.83200	(1)2.09686	(2)5.03668	(3)1.13789
1.6	3.34	7.84	(1)1.94470	(1)4.97354	(3)2.45973	(3)6.65436
1.8	4.36	11.88	(1)3.41520	(2)1.01148	(3)8.97882	(4)2.81110
2.0	5.50	17.00	(1)5.53750	(2)1.85750	(4)2.71007	(4)9.60605
2.2	6.76	23.32	(1)8.47120	(2)3.16804	(4)7.13591	(5)2.81929
2.4	8.14	30.96	(2)1.23927	(2)5.10597	(5)1.69353	(5)7.37020
2.6	9.64	40.04	(2)1.74952	(2)7.86743	(5)3.70173	(6)1.75809
2.8	11.26	50.68	(2)2.39887	(3)1.16849	(5)7.56647	(6)3.89219
3.0	13.00	63.00	(2)3.21000	(3)1.68300	(6)1.46256	(6)8.09745
3.2	14.86	77.12	(2)4.20727	(3)2.36169	(6)2.69625	(7)1.59814
3.4	16.84	93.16	(2)5.41672	(3)3.24050	(6)4.77208	(7)3.01437
3.6	18.94	111.24	(2)6.86607	(3)4.36022	(6)8.15181	(7)5.46578
3.8	21.16	131.48	(2)8.58472	(3)5.76676	(7)1.34978	(7)9.57313
4.0	23.50	154.00	(3)1.06038	(3)7.51150	(7)2.17406	(8)1.62597
4.2	25.96	178.92	(3)1.29559	(3)9.65154	(7)3.41632	(8)2.68690
4.4	28.54	206.36	(3)1.56757	(4)1.22500	(7)5.25060	(8)4.33189
4.6	31.24	236.44	(3)1.87991	(4)1.53765	(7)7.90944	(8)6.82993
4.8	34.06	269.28	(3)2.23641	(4)1.91071	(8)1.16994	(9)1.05524
5.0	37.00	305.00	(3)2.64100	(4)2.35250	(8)1.70196	(9)1.60047
5.2	40.06	343.72	(3)3.09781	(4)2.87205	(8)2.43839	(9)2.38657
5.4	43.24	385.56	(3)3.61111	(4)3.47916	(8)3.44472	(9)3.50362
5.6	46.54	430.64	(3)4.18537	(4)4.18440	(8)4.80363	(9)5.06985
5.8	49.96	479.08	(3)4.82519	(4)4.99917	(8)6.61853	(9)7.23884
6.0	53.50	531.00	(3)5.53538	(4)5.93572	(8)9.01781	(10)1.02082
6.2	57.16	586.52	(3)6.32087	(4)7.00717	(9)1.21596	(10)1.42299
6.4	60.94	645.76	(3)7.18681	(4)8.22754	(9)1.62372	(10)1.96229
6.6	64.84	708.84	(3)8.13847	(4)9.61180	(9)2.14858	(10)2.67872
6.8	68.86	775.88	(3)9.18133	(5)1.11759	(9)2.81890	(10)3.62216
7.0	73.00	847.00	(4)1.03210	(5)1.29367	(9)3.66876	(10)4.85435
7.2	77.26	922.32	(4)1.15633	(5)1.49122	(9)4.73885	(10)6.45123
7.4	81.64	1001.96	(4)1.29142	(5)1.71215	(9)6.07749	(10)8.50564
7.6	86.14	1086.04	(4)1.43797	(5)1.95846	(9)7.74185	(11)1.11305
7.8	90.76	1174.68	(4)1.59663	(5)2.23227	(9)9.79919	(11)1.44623
8.0	95.50	1268.00	(4)1.76804	(5)2.53583	(10)1.23283	(11)1.86653
8.2	100.36	1366.12	(4)1.95286	(5)2.87149	(10)1.54212	(11)2.39363
8.4	105.34	1469.16	(4)2.15176	(5)3.24171	(10)1.91848	(11)3.05098
8.6	110.44	1577.24	(4)2.36546	(5)3.64912	(10)2.37430	(11)3.86641
8.8	115.66	1690.48	(4)2.59466	(5)4.09643	(10)2.92387	(11)4.87282
9.0	121.00	1809.00	(4)2.84010	(5)4.58649	(10)3.58363	(11)6.10897
9.2	126.46	1932.92	(4)3.10252	(5)5.12230	(10)4.37243	(11)7.62030
9.4	132.04	2062.36	(4)3.38268	(5)5.70699	(10)5.31184	(11)9.45994
9.6	137.74	2197.44	(4)3.68137	(5)6.34383	(10)6.42640	(12)1.16898
9.8	143.56	2338.28	(4)3.99938	(5)7.03621	(10)7.74404	(12)1.43817
10.0	149.50	2485.00	(4)4.33754	(5)7.78769	(10)9.29640	(12)1.76188

From National Bureau of Standards, Tables of associated Legendre functions. Columbia Univ. Press, New York, N.Y., 1945 (with permission).

DERIVATIVE OF THE LEGENDRE FUNCTION—FIRST KIND $P'_n(x)$

Table 8.6

x	$P'_3(x)$	$P'_4(x)$	$P'_5(x)$	$P'_9(x)$	$P'_{10}(x)$
			$P'_1(x) = 1$	$P'_2(x) = 3x$	
1.0	6.000	(1)1.00000	(1)1.50000	(1)4.50000	(1)5.50000
1.2	9.300	(1)2.12400	(1)4.57230	(2)7.77587	(3)1.53586
1.4	(1)1.320	(1)3.75200	(2)1.01688	(3)4.50787	(4)1.13477
1.6	(1)1.770	(1)5.96800	(2)1.92723	(4)1.74282	(4)5.24824
1.8	(1)2.280	(1)8.85600	(2)3.30168	(4)5.33445	(5)1.85808
2.0	(1)2.850	(2)1.25000	(2)5.26875	(5)1.39531	(5)5.50068
2.2	(1)3.480	(2)1.69840	(2)7.97208	(5)3.25362	(6)1.42939
2.4	(1)4.170	(2)2.23920	(3)1.15704	(5)6.94480	(6)3.36028
2.6	(1)4.920	(2)2.88080	(3)1.62377	(6)1.38132	(6)7.29317
2.8	(1)5.730	(2)3.63160	(3)2.21628	(6)2.59296	(7)1.48267
3.0	(1)6.600	(2)4.50000	(3)2.95500	(6)4.63721	(7)2.85372
3.2	(1)7.530	(2)5.49440	(3)3.86184	(6)7.95819	(7)5.24287
3.4	(1)8.520	(2)6.62320	(3)4.96025	(7)1.31805	(7)9.25345
3.6	(1)9.570	(2)7.89480	(3)6.27516	(7)2.11632	(8)1.57706
3.8	(2)1.068	(2)9.31760	(3)7.83305	(7)3.30652	(8)2.60626
4.0	(2)1.185	(3)1.09000	(3)9.66187	(7)5.04229	(8)4.19097
4.2	(2)1.308	(3)1.26504	(4)1.17911	(7)7.52431	(8)6.57653
4.4	(2)1.437	(3)1.45772	(4)1.42518	(8)1.10110	(9)1.00955
4.6	(2)1.572	(3)1.66888	(4)1.70764	(8)1.58313	(9)1.51918
4.8	(2)1.713	(3)1.89936	(4)2.02990	(8)2.23988	(9)2.24508
5.0	(2)1.860	(3)2.15000	(4)2.39550	(8)3.12290	(9)3.26340
5.2	(2)2.013	(3)2.42164	(4)2.80816	(8)4.29574	(9)4.67217
5.4	(2)2.172	(3)2.71512	(4)3.27172	(8)5.83620	(9)6.59627
5.6	(2)2.337	(3)3.03128	(4)3.79020	(8)7.83868	(9)9.19329
5.8	(2)2.508	(3)3.37096	(4)4.36775	(9)1.04169	(10)1.26604
6.0	(2)2.685	(3)3.73500	(4)5.00869	(9)1.37071	(10)1.72421
6.2	(2)2.868	(3)4.12424	(4)5.71746	(9)1.78712	(10)2.32397
6.4	(2)3.057	(3)4.53952	(4)6.49870	(9)2.31006	(10)3.10217
6.6	(2)3.252	(3)4.98168	(4)7.35714	(9)2.96206	(10)4.10354
6.8	(2)3.453	(3)5.45156	(4)8.29772	(9)3.76947	(10)5.38214
7.0	(2)3.660	(3)5.95000	(4)9.32550	(9)4.76295	(10)7.00283
7.2	(2)3.873	(3)6.47784	(5)1.04457	(9)5.97809	(10)9.04307
7.4	(2)4.092	(3)7.03592	(5)1.16637	(9)7.45591	(11)1.15949
7.6	(2)4.317	(3)7.62508	(5)1.29849	(9)9.24362	(11)1.47670
7.8	(2)4.548	(3)8.24616	(5)1.44152	(10)1.13953	(11)1.86875
8.0	(2)4.785	(3)8.90000	(5)1.59602	(10)1.39725	(11)2.35063
8.2	(2)5.028	(3)9.58744	(5)1.76260	(10)1.70455	(11)2.93985
8.4	(2)5.277	(4)1.03093	(5)1.94187	(10)2.06937	(11)3.65675
8.6	(2)5.532	(4)1.10665	(5)2.13445	(10)2.50070	(11)4.52490
8.8	(2)5.793	(4)1.18598	(5)2.34099	(10)3.00866	(11)5.57149
9.0	(2)6.060	(4)1.26900	(5)2.56215	(10)3.60463	(11)6.82780
9.2	(2)6.333	(4)1.35580	(5)2.79860	(10)4.30137	(11)8.32969
9.4	(2)6.612	(4)1.44647	(5)3.05102	(10)5.11311	(12)1.01182
9.6	(2)6.897	(4)1.54109	(5)3.32013	(10)6.05576	(12)1.22399
9.8	(2)7.188	(4)1.63974	(5)3.60663	(10)7.14698	(12)1.47481
10.0	(2)7.485	(4)1.74250	(5)3.91127	(10)8.40642	(12)1.77028

From National Bureau of Standards, Tables of associated Legendre functions. Columbia Univ. Press, New York, N.Y., 1945 (with permission).

Table 8.7

LEGENDRE FUNCTION—SECOND KIND $Q_n(x)$

x	$Q_0(x)$	$Q_1(x)$	$Q_2(x)$	$Q_3(x)$	$Q_9(x)$	$Q_{10}(x)$
1.0	∞	∞	∞	∞	∞	∞
1.2	1.19895	(-1)4.38737	(-1)1.90253	(-2)8.80147	(-3)1.32079	(-4)6.75615
1.4	(-1)8.95880	(-1)2.54232	(-2)8.59466	(-2)3.10542	(-4)1.06810	(-5)4.27633
1.6	(-1)7.33169	(-1)1.73070	(-2)4.87829	(-2)1.47080	(-5)1.71471	(-6)5.73368
1.8	(-1)6.26381	(-1)1.27487	(-2)3.10233	(-3)8.07870	(-6)3.91902	(-6)1.13241
2.0	(-1)5.49306	(-2)9.86123	(-2)2.11838	(-3)4.87112	(-6)1.12179	(-7)2.86313
2.2	(-1)4.90415	(-2)7.89122	(-2)1.52029	(-3)3.13576	(-7)3.76522	(-8)8.62195
2.4	(-1)4.43652	(-2)6.47638	(-2)1.13240	(-3)2.12013	(-7)1.42488	(-8)2.96212
2.6	(-1)4.05465	(-2)5.42093	(-3)8.68364	(-3)1.48960	(-8)5.92566	(-8)1.12879
2.8	(-1)3.73607	(-2)4.61002	(-3)6.81708	(-3)1.07961	(-8)2.66020	(-9)4.67876
3.0	(-1)3.46574	(-2)3.97208	(-3)5.45667	(-4)8.02854	(-8)1.27252	(-9)2.07945
3.2	(-1)3.23314	(-2)3.46035	(-3)4.43984	(-4)6.10146	(-9)6.42269	(-10)9.80358
3.4	(-1)3.03068	(-2)3.04309	(-3)3.66347	(-4)4.72397	(-9)3.39441	(-10)4.86183
3.6	(-1)2.85272	(-2)2.69807	(-3)3.05981	(-4)3.71695	(-9)1.86714	(-10)2.51945
3.8	(-1)2.69498	(-2)2.40934	(-3)2.58298	(-4)2.96625	(-9)1.06372	(-10)1.35695
4.0	(-1)2.55413	(-2)2.16512	(-3)2.20108	(-4)2.39697	(-10)6.25130	(-11)7.56235
4.2	(-1)2.42754	(-2)1.95664	(-3)1.89145	(-4)1.95866	(-10)3.77701	(-11)4.34493
4.4	(-1)2.31312	(-2)1.77717	(-3)1.63766	(-4)1.61661	(-10)2.33956	(-11)2.56563
4.6	(-1)2.20916	(-2)1.62153	(-3)1.42759	(-4)1.34641	(-10)1.48213	(-11)1.55290
4.8	(-1)2.11428	(-2)1.48564	(-3)1.25217	(-4)1.13061	(-11)9.58309	(-12)9.61271
5.0	(-1)2.02733	(-2)1.36628	(-3)1.10450	(-5)9.56532	(-11)6.31274	(-12)6.07362
5.2	(-1)1.94732	(-2)1.26084	(-4)9.79278	(-5)8.14823	(-11)4.23006	(-12)3.91025
5.4	(-1)1.87347	(-2)1.16723	(-4)8.72377	(-5)6.98500	(-11)2.87937	(-12)2.56132
5.6	(-1)1.80507	(-2)1.08374	(-4)7.80551	(-5)6.02278	(-11)1.98859	(-12)1.70471
5.8	(-1)1.74153	(-2)1.00894	(-4)7.01223	(-5)5.22117	(-11)1.39197	(-12)1.15147
6.0	(-1)1.68236	(-3)9.41671	(-4)6.32330	(-5)4.54896	(-12)9.86572	(-13)7.88519
6.2	(-1)1.62711	(-3)8.80944	(-4)5.72204	(-5)3.98181	(-12)7.07418	(-13)5.46920
6.4	(-1)1.57541	(-3)8.25935	(-4)5.19491	(-5)3.50058	(-12)5.12787	(-13)3.83900
6.6	(-1)1.52691	(-3)7.75944	(-4)4.73078	(-5)3.09006	(-12)3.75499	(-13)2.72499
6.8	(-1)1.48133	(-3)7.30377	(-4)4.32050	(-5)2.73812	(-12)2.77600	(-13)1.95462
7.0	(-1)1.43841	(-3)6.88725	(-4)3.95644	(-5)2.43500	(-12)2.07071	(-13)1.41592
7.2	(-1)1.39792	(-3)6.50550	(-4)3.63228	(-5)2.17277	(-12)1.55770	(-13)1.03525
7.4	(-1)1.35967	(-3)6.15475	(-4)3.34266	(-5)1.94497	(-12)1.18115	(-14)7.63577
7.6	(-1)1.32346	(-3)5.83171	(-4)3.08311	(-5)1.74631	(-13)9.02383	(-14)5.67877
7.8	(-1)1.28915	(-3)5.53353	(-4)2.84980	(-5)1.57242	(-13)6.94338	(-14)4.25654
8.0	(-1)1.25657	(-3)5.25771	(-4)2.63950	(-5)1.41968	(-13)5.37876	(-14)3.21427
8.2	(-1)1.22561	(-3)5.00208	(-4)2.44944	(-5)1.28507	(-13)4.19350	(-14)2.44439
8.4	(-1)1.19615	(-3)4.76469	(-4)2.27723	(-5)1.16606	(-13)3.28941	(-14)1.87141
8.6	(-1)1.16807	(-3)4.54386	(-4)2.12082	(-5)1.06054	(-13)2.59524	(-14)1.44191
8.8	(-1)1.14129	(-3)4.33807	(-4)1.97844	(-6)9.66707	(-13)2.05891	(-14)1.11775
9.0	(-1)1.11572	(-3)4.14598	(-4)1.84855	(-6)8.83037	(-13)1.64205	(-15)8.71513
9.2	(-1)1.09127	(-3)3.96640	(-4)1.72979	(-6)8.08237	(-13)1.31620	(-15)6.83294
9.4	(-1)1.06787	(-3)3.79827	(-4)1.62102	(-6)7.41202	(-13)1.06011	(-15)5.38569
9.6	(-1)1.04546	(-3)3.64063	(-4)1.52119	(-6)6.80982	(-14)8.57794	(-15)4.26656
9.8	(-1)1.02397	(-3)3.49262	(-4)1.42940	(-6)6.26763	(-14)6.97159	(-15)3.39644
10.0	(-1)1.00335	(-3)3.35348	(-4)1.34486	(-6)5.77839	(-14)5.69010	(-15)2.71639

From National Bureau of Standards, Tables of associated Legendre functions. Columbia Univ. Press, New York, N.Y., 1945 (with permission).

DERIVATIVE OF THE LEGENDRE FUNCTION—SECOND KIND $Q'_n(x)$

Table 8.8

x	$-Q'_0(x)$	$-Q'_1(x)$	$-Q'_2(x)$	$-Q'_3(x)$	$-Q'_4(x)$	$-Q'_{10}(x)$
1.0	∞	∞	∞	∞	∞	∞
1.2	2.27273	1.52833	(-1)9.56516	(-1)5.77060	(-2)2.06667	(-2)1.15922
1.4	1.04167	(-1)5.62454	(-1)2.78972	(-1)1.32721	(-3)1.11220	(-4)4.88977
1.6	(-1)6.41026	(-1)2.92472	(-1)1.21817	(-2)4.85580	(-4)1.39114	(-5)5.11106
1.8	(-1)4.46429	(-1)1.77190	(-2)6.39686	(-2)2.20736	(-5)2.64367	(-6)8.39591
2.0	(-1)3.33333	(-1)1.17361	(-2)3.74965	(-2)1.14416	(-6)6.52419	(-6)1.83053
2.2	(-1)2.60417	(-2)8.25020	(-2)2.36801	(-3)6.48766	(-6)1.93263	(-7)4.86561
2.4	(-1)2.10084	(-2)6.05501	(-2)1.57925	(-3)3.93006	(-7)6.56197	(-7)1.49994
2.6	(-1)1.73611	(-2)4.59238	(-2)1.09833	(-3)2.50557	(-7)2.47880	(-8)5.19235
2.8	(-1)1.46199	(-2)3.57495	(-3)7.89834	(-3)1.66411	(-7)1.02057	(-8)1.97390
3.0	(-1)1.25000	(-2)2.84264	(-3)5.83769	(-3)1.14304	(-8)4.51200	(-9)8.10849
3.2	(-1)1.08225	(-2)2.30068	(-3)4.41472	(-4)8.07587	(-8)2.11821	(-9)3.55578
3.4	(-2)9.46970	(-2)1.89018	(-3)3.40437	(-4)5.84465	(-8)1.04686	(-9)1.64904
3.6	(-2)8.36120	(-2)1.57309	(-3)2.66980	(-4)4.31867	(-9)5.40951	(-10)8.02794
3.8	(-2)7.44048	(-2)1.32398	(-3)2.12471	(-4)3.24956	(-9)2.90659	(-10)4.07799
4.0	(-2)6.66667	(-2)1.12539	(-3)1.71292	(-4)2.48459	(-9)1.61660	(-10)2.15091
4.2	(-2)6.00962	(-3)9.64994	(-3)1.39691	(-4)1.92694	(-10)9.27220	(-10)1.17316
4.4	(-2)5.44662	(-3)8.33966	(-3)1.15099	(-4)1.51364	(-10)5.46705	(-11)6.59413
4.6	(-2)4.96032	(-3)7.25823	(-4)9.57184	(-4)1.20274	(-10)3.30481	(-11)3.80849
4.8	(-2)4.53721	(-3)6.35742	(-4)8.02725	(-5)9.65712	(-10)2.04345	(-11)2.25453
5.0	(-2)4.16667	(-3)5.60078	(-4)6.78356	(-5)7.82792	(-10)1.28985	(-11)1.36497
5.2	(-2)3.84025	(-3)4.96040	(-4)5.77277	(-5)6.40058	(-11)8.29696	(-12)8.43598
5.4	(-2)3.55114	(-3)4.41464	(-4)4.94423	(-5)5.27543	(-11)5.43056	(-12)5.31340
5.6	(-2)3.29381	(-3)3.94656	(-4)4.25974	(-5)4.38019	(-11)3.61188	(-12)3.40566
5.8	(-2)3.06373	(-3)3.54273	(-4)3.69015	(-5)3.66172	(-11)2.43819	(-12)2.21848
6.0	(-2)2.85714	(-3)3.19245	(-4)3.21299	(-5)3.08050	(-11)1.66874	(-12)1.46703
6.2	(-2)2.67094	(-3)2.88709	(-4)2.81078	(-5)2.60683	(-11)1.15686	(-13)9.83782
6.4	(-2)2.50250	(-3)2.61964	(-4)2.46977	(-5)2.21813	(-12)8.11673	(-13)6.68395
6.6	(-2)2.34962	(-3)2.38436	(-4)2.17910	(-5)1.89709	(-12)5.75903	(-13)4.59703
6.8	(-2)2.21043	(-3)2.17655	(-4)1.93008	(-5)1.63035	(-12)4.12938	(-13)3.19817
7.0	(-2)2.08333	(-3)1.99230	(-4)1.71573	(-5)1.40747	(-12)2.99029	(-13)2.24909
7.2	(-2)1.96696	(-3)1.82834	(-4)1.53040	(-5)1.22023	(-12)2.18566	(-13)1.59779
7.4	(-2)1.86012	(-3)1.68195	(-4)1.36949	(-5)1.06216	(-12)1.61163	(-13)1.14602
7.6	(-2)1.76180	(-3)1.55083	(-4)1.22923	(-6)9.28073	(-12)1.19826	(-14)8.29452
7.8	(-2)1.67112	(-3)1.43304	(-4)1.10651	(-6)8.13829	(-13)8.97939	(-14)6.05494
8.0	(-2)1.58730	(-3)1.32691	(-5)9.98765	(-6)7.16078	(-13)6.77915	(-14)4.45610
8.2	(-2)1.50966	(-3)1.23104	(-5)9.03846	(-6)6.32104	(-13)5.15433	(-14)3.30480
8.4	(-2)1.43761	(-3)1.14421	(-5)8.19960	(-6)5.59691	(-13)3.94535	(-14)2.46898
8.6	(-2)1.37061	(-3)1.06538	(-5)7.45601	(-6)4.97021	(-13)3.03931	(-14)1.85745
8.8	(-2)1.30822	(-4)9.93646	(-5)6.79498	(-6)4.42597	(-13)2.35565	(-14)1.40670
9.0	(-2)1.25000	(-4)9.28224	(-5)6.20573	(-6)3.95179	(-13)1.83641	(-14)1.07211
9.2	(-2)1.19560	(-4)8.68435	(-5)5.67908	(-6)3.53736	(-13)1.43959	(-15)8.22064
9.4	(-2)1.14469	(-4)8.13682	(-5)5.20722	(-6)3.17406	(-13)1.13452	(-15)6.33995
9.6	(-2)1.09697	(-4)7.63447	(-5)4.78344	(-6)2.85468	(-14)8.98657	(-15)4.91668
9.8	(-2)1.05219	(-4)7.17272	(-5)4.40196	(-6)2.57314	(-14)7.15298	(-15)3.83321
10.0	(-2)1.01010	(-4)6.74753	(-5)4.05782	(-6)2.32430	(-14)5.72014	(-15)3.00374

From National Bureau of Standards, Tables of associated Legendre functions. Columbia Univ. Press, New York, N.Y., 1945 (with permission).

9. Bessel Functions of Integer Order

F. W. J. OLVER¹

Contents

	Page
Mathematical Properties	358
Notation.	358
Bessel Functions J and Y.	358
9.1. Definitions and Elementary Properties	358
9.2. Asymptotic Expansions for Large Arguments	364
9.3. Asymptotic Expansions for Large Orders	365
9.4. Polynomial Approximations.	369
9.5. Zeros.	370
Modified Bessel Functions I and K.	374
9.6. Definitions and Properties	374
9.7. Asymptotic Expansions.	377
9.8. Polynomial Approximations.	378
Kelvin Functions.	379
9.9. Definitions and Properties	379
9.10. Asymptotic Expansions	381
9.11. Polynomial Approximations	384
Numerical Methods	385
9.12. Use and Extension of the Tables.	385
References.	388
Table 9.1. Bessel Functions—Orders 0, 1, and 2 ($0 \leq x \leq 17.5$)	390
$J_0(x)$, 15D, $J_1(x)$, $J_2(x)$, $Y_0(x)$, $Y_1(x)$, 10D	
$Y_2(x)$, 8D	
$x=0(.1)17.5$	
Bessel Functions—Modulus and Phase of Orders 0, 1, 2	
($10 \leq x \leq \infty$)	396
$x^{\frac{1}{2}}M_n(x)$, $\theta_n(x)-x$, 8D	
$n=0(1)2$, $x^{-1}=.1(-.01)0$	
Bessel Functions—Auxiliary Table for Small Arguments	
($0 \leq x \leq 2$)	397
$Y_0(x) - \frac{2}{\pi} J_0(x) \ln x$, $x[Y_1(x) - \frac{2}{\pi} J_1(x) \ln x]$	
$x=0(.1)2$, 8D	
Table 9.2. Bessel Functions—Orders 3–9 ($0 \leq x \leq 20$)	398
$J_n(x)$, $Y_n(x)$, $n=3(1)9$	
$x=0(.2)20$, 5D or 5S	

¹ National Bureau of Standards, on leave from the National Physical Laboratory.

	Page
Table 9.3. Bessel Functions—Orders 10, 11, 20, and 21 ($0 \leq x \leq 20$) . . .	402
$x^{-10}J_{10}(x), x^{-11}J_{11}(x), x^{10}Y_{10}(x)$	
$x=0(.1)10, 8S$ or $9S$	
$J_{10}(x), J_{11}(x), Y_{10}(x)$	
$x=10(.1)20, 8D$	
$x^{-20}J_{20}(x), x^{-21}J_{21}(x), x^{20}Y_{20}(x)$	
$x=0(.1)20, 6S$ or $7S$	
Bessel Functions—Modulus and Phase of Orders 10,11,20, and 21 ($20 \leq x \leq \infty$).	406
$x^{\frac{1}{2}}M_n(x), \theta_n(x) - x$	
$n=10, 11, 8D$	
$n=20, 21, 6D$	
$x^{-1}=.05(-.002)0$	
Table 9.4. Bessel Functions—Various Orders ($0 \leq n \leq 100$).	407
$J_n(x), Y_n(x), n=0(1)20(10)50, 100$	
$x=1, 2, 5, 10, 50, 100, 10S$	
Table 9.5. Zeros and Associated Values of Bessel Functions and Their Derivatives ($0 \leq n \leq 8, 1 \leq s \leq 20$).	409
$j_{n,s}, J'_n(j_{n,s}); j'_{n,s}, J_n(j'_{n,s}), 5D$ (10D for $n=0$)	
$y_{n,s}, Y'_n(y_{n,s}); y'_{n,s}, Y_n(y'_{n,s}), 5D$ (8D for $n=0$)	
$s=1(1)20, n=0(1)8$	
Table 9.6. Bessel Functions $J_0(j_{0,s}x), s=1(1)5$	413
$x=0(.02)1, 5D$	
Table 9.7. Bessel Functions—Miscellaneous Zeros ($s=1(1)5$).	414
<i>sth</i> zero of $x J_1(x) - \lambda J_0(x)$	
$\lambda, \lambda^{-1}=0(.02) .1, .2(.2)1, 4D$	
<i>sth</i> zero of $J_1(x) - \lambda x J_0(x)$	
$\lambda=.5(.1)1, \lambda^{-1}=1(-.2).2, .1(-.02)0, 4D$	
<i>sth</i> zero of $J_0(x)Y_0(\lambda x) - Y_0(x)J_0(\lambda x)$	
$\lambda^{-1}=.8(-.2) .2, .1(-.02)0, 5D$ (8D for $s=1$)	
<i>sth</i> zero of $J_1(x)Y_1(\lambda x) - Y_1(x)J_1(\lambda x)$	
$\lambda^{-1}=.8(-.2) .2, .1(-.02)0, 5D$ (8D for $s=1$)	
<i>sth</i> zero of $J_1(x)Y_0(\lambda x) - Y_1(x)J_0(\lambda x)$	
$\lambda^{-1}=.8(-.2) .2, .1(-.02)0, 5D$ (8D for $s=1$)	
Table 9.8. Modified Bessel Functions of Orders 0, 1, and 2 ($0 \leq x \leq 20$) .	416
$e^{-x}I_0(x), e^xK_0(x), e^{-x}I_1(x), e^xK_1(x)$	
$x=0(.1)10 (.2)20, 10D$ or $10S$	
$x^{-2}I_2(x), x^2K_2(x)$	
$x=0(.1)5, 10D, 9D$	
$e^{-x}I_2(x), e^xK_2(x)$	
$x=5(.1)10 (.2)20, 9D, 8D$	
Modified Bessel Functions—Auxiliary Table for Large Arguments ($20 \leq x \leq \infty$).	422
$x^{\frac{1}{2}}e^{-x}I_n(x), \pi^{-1}x^{\frac{1}{2}}e^xK_n(x), n=0, 1, 2$	
$x^{-1}=.05(-.002)0, 8-9D$	
Modified Bessel Functions—Auxiliary Table for Small Arguments ($0 \leq x \leq 2$).	422
$K_0(x) + I_0(x) \ln x, x\{K_1(x) - I_1(x) \ln x\}$	
$x=0(.1)2, 8D$	

	Page
Table 9.9. Modified Bessel Functions—Orders 3–9 ($0 \leq x \leq 20$) . . .	423
$e^{-x}I_n(x), e^xK_n(x), n=3(1)9$	
$x=0(.2)10(.5)20, 5S$	
Table 9.10. Modified Bessel Functions—Orders 10, 11, 20 and 21	
$(0 \leq x \leq 20)$ 425	
$x^{-10}I_{10}(x), x^{-11}I_{11}(x), x^{10}K_{10}(x)$	
$x=0(.2)10, 8S$ or 9S	
$e^{-x}I_{10}(x), e^{-x}I_{11}(x), e^xK_{10}(x)$	
$x=10(.2)20, 10D, 10D, 7D$	
$x^{-20}I_{20}(x), x^{-21}I_{21}(x), x^{20}K_{20}(x)$	
$x=0(.2)20, 5S$ to 7S	
Modified Bessel Functions—Auxiliary Table for Large	
Arguments ($20 \leq x \leq \infty$) 427	
$\ln\{x^3e^{-x}I_{10}(x)\}, \ln\{x^3e^{-x}I_{11}(x)\}, \ln\{\pi^{-1}x^3e^xK_{10}(x)\}$	
$\ln\{x^3e^{-x}I_{20}(x)\}, \ln\{x^3e^{-x}I_{21}(x)\}, \ln\{\pi^{-1}x^3e^xK_{20}(x)\}$	
$x^{-1}=.05(-.001)0, 8D, 6D$	
Table 9.11. Modified Bessel Functions—Various Orders ($0 \leq n \leq 100$) .	428
$I_n(x), K_n(x), n=0(1)20(10)50, 100$	
$x=1, 2, 5, 10, 50, 100, 9S$ or 10S	
Table 9.12. Kelvin Functions—Orders 0 and 1 ($0 \leq x \leq 5$)	430
ber x , bei x , ber ₁ x , bei ₁ x	
ker x , kei x , ker ₁ x , kei ₁ x	
$x=0(.1)5, i0D, 9D$	
Kelvin Functions—Auxiliary Table for Small Arguments	
$(0 \leq x \leq 1)$ 430	
ker $x + \text{ber } x \ln x$, kei $x + \text{bei } x \ln x$	
$x(\text{ker}_1x + \text{ber}_1x \ln x), x(\text{kei}_1x + \text{bei}_1x \ln x)$	
$x=0(.1)1, 9D$	
Kelvin Functions—Modulus and Phase ($0 \leq x \leq 7$) 432	
$M_0(x), \theta_0(x), M_1(x), \theta_1(x)$	
$N_0(x), \phi_0(x), N_1(x), \phi_1(x)$	
$x=0(.2)7, 6D$	
Kelvin Functions—Modulus and Phase for Large Argu-	
ments ($6.6 \leq x \leq \infty$) 432	
$x^3e^{-x/\sqrt{2}}M_0(x), \theta_0(x) - (x/\sqrt{2}), x^3e^{-x/\sqrt{2}}M_1(x), \theta_1(x) - (x/\sqrt{2})$	
$x^3e^{x/\sqrt{2}}N_0(x), \phi_0(x) + (x/\sqrt{2}), x^3e^{x/\sqrt{2}}N_1(x), \phi_1(x) + (x/\sqrt{2})$	
$x^{-1}=.15(-.01)0, 5D$	

The author acknowledges the assistance of Alfred E. Beam, Ruth E. Capuano, Lois K. Cherwinski, Elizabeth F. Godefroy, David S. Liepman, Mary Orr, Bertha H. Walter, and Ruth Zucker of the National Bureau of Standards, and N. F. Bird, C. W. Clenshaw, and Joan M. Felton of the National Physical Laboratory in the preparation and checking of the tables and graphs.

9. Bessel Functions of Integer Order

Mathematical Properties

Notation

The tables in this chapter are for Bessel functions of integer order; the text treats general orders. The conventions used are:

$z = x + iy$; x, y real.

n is a positive integer or zero.

ν, μ are unrestricted except where otherwise indicated; ν is supposed real in the sections devoted to Kelvin functions 9.9, 9.10, and 9.11.

The notation used for the Bessel functions is that of Watson [9.15] and the British Association and Royal Society Mathematical Tables. The function $Y_\nu(z)$ is often denoted $N_\nu(z)$ by physicists and European workers.

Other notations are those of:

Aldis, Airey:

$$G_n(z) \text{ for } -\frac{1}{2}\pi Y_n(z), K_n(z) \text{ for } (-)^n K_n(z).$$

Clifford:

$$C_n(x) \text{ for } x^{-1/2} J_n(2\sqrt{x}).$$

Gray, Mathews and MacRobert [9.9]:

$$Y_n(z) \text{ for } \frac{1}{2}\pi Y_n(z) + (\ln 2 - \gamma) J_n(z),$$

$$\bar{Y}_\nu(z) \text{ for } \pi e^{\nu\pi i} \sec(\nu\pi) Y_\nu(z),$$

$$G_\nu(z) \text{ for } \frac{1}{2}\pi i H_\nu^{(1)}(z).$$

Jahnke, Emde and Lösch [9.32]:

$$\Lambda_\nu(z) \text{ for } \Gamma(\nu+1) (\frac{1}{2}z)^{-\nu} J_\nu(z).$$

Jeffreys:

$$H_{s,\nu}(z) \text{ for } H_\nu^{(1)}(z), H_{i,\nu}(z) \text{ for } H_\nu^{(2)}(z),$$

$$Kh_\nu(z) \text{ for } (2/\pi) K_\nu(z).$$

Heine:

$$K_n(z) \text{ for } -\frac{1}{2}\pi Y_n(z).$$

Neumann:

$$Y^n(z) \text{ for } \frac{1}{2}\pi Y_n(z) + (\ln 2 - \gamma) J_n(z).$$

Whittaker and Watson [9.18]:

$$K_\nu(z) \text{ for } \cos(\nu\pi) K_\nu(z).$$

Bessel Functions J and Y

9.1. Definitions and Elementary Properties

Differential Equation

$$9.1.1 \quad z^2 \frac{d^2 w}{dz^2} + z \frac{dw}{dz} + (z^2 - \nu^2) w = 0$$

Solutions are the Bessel functions of the first kind $J_{\pm\nu}(z)$, of the second kind $Y_\nu(z)$ (also called Weber's function) and of the third kind $H_\nu^{(1)}(z), H_\nu^{(2)}(z)$ (also called the Hankel functions). Each is a regular (holomorphic) function of z throughout the z -plane cut along the negative real axis, and for fixed $z (\neq 0)$ each is an entire (integral) function of ν . When $\nu = \pm n$, $J_\nu(z)$ has no branch point and is an entire (integral) function of z .

Important features of the various solutions are as follows: $J_\nu(z) (\Re \nu \geq 0)$ is bounded as $z \rightarrow 0$ in any bounded range of $\arg z$. $J_\nu(z)$ and $J_{-\nu}(z)$ are linearly independent except when ν is an integer. $J_\nu(z)$ and $Y_\nu(z)$ are linearly independent for all values of ν .

$H_\nu^{(1)}(z)$ tends to zero as $|z| \rightarrow \infty$ in the sector $0 < \arg z < \pi$; $H_\nu^{(2)}(z)$ tends to zero as $|z| \rightarrow \infty$ in the sector $-\pi < \arg z < 0$. For all values of ν , $H_\nu^{(1)}(z)$ and $H_\nu^{(2)}(z)$ are linearly independent.

Relations Between Solutions

$$9.1.2 \quad Y_\nu(z) = \frac{J_\nu(z) \cos(\nu\pi) - J_{-\nu}(z)}{\sin(\nu\pi)}$$

The right of this equation is replaced by its limiting value if ν is an integer or zero.

9.1.3

$$H_\nu^{(1)}(z) = J_\nu(z) + iY_\nu(z) \\ = i \csc(\nu\pi) \{ e^{-\nu\pi i} J_\nu(z) - J_{-\nu}(z) \}$$

9.1.4

$$H_\nu^{(2)}(z) = J_\nu(z) - iY_\nu(z) \\ = i \csc(\nu\pi) \{ J_{-\nu}(z) - e^{\nu\pi i} J_\nu(z) \}$$

$$9.1.5 \quad J_{-n}(z) = (-)^n J_n(z) \quad Y_{-n}(z) = (-)^n Y_n(z)$$

$$9.1.6 \quad H_{\pm\nu}^{(1)}(z) = e^{\nu\pi i} H_\nu^{(1)}(z) \quad H_{\pm\nu}^{(2)}(z) = e^{-\nu\pi i} H_\nu^{(2)}(z)$$

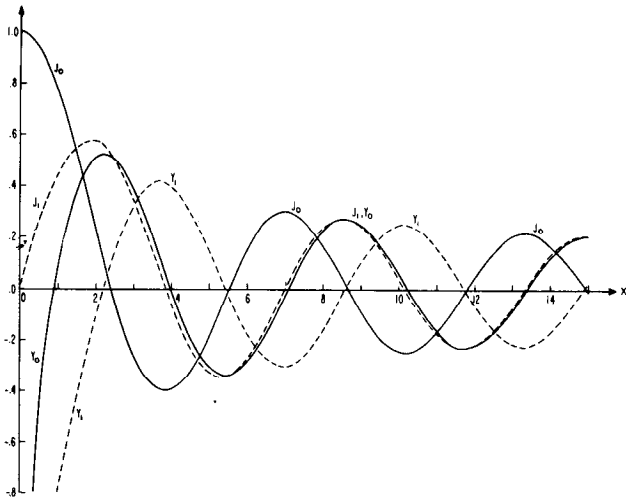

FIGURE 9.1. $J_0(x)$, $Y_0(x)$, $J_1(x)$, $Y_1(x)$.

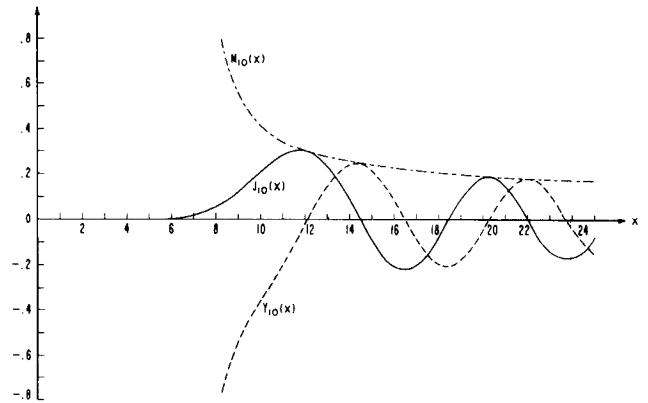

FIGURE 9.2. $J_{10}(x)$, $Y_{10}(x)$, and $M_{10}(x) = \sqrt{J_{10}^2(x) + Y_{10}^2(x)}$.

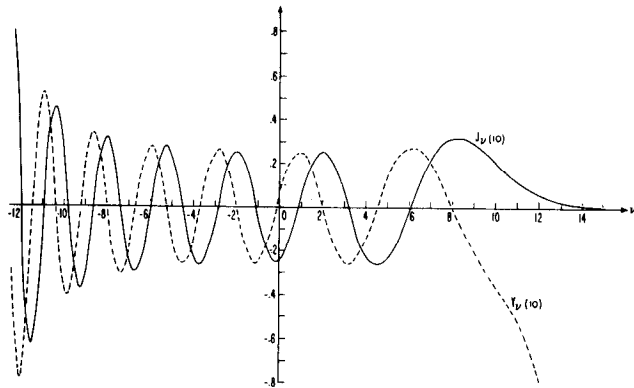

FIGURE 9.3. $J_{\nu}(10)$ and $Y_{\nu}(10)$.

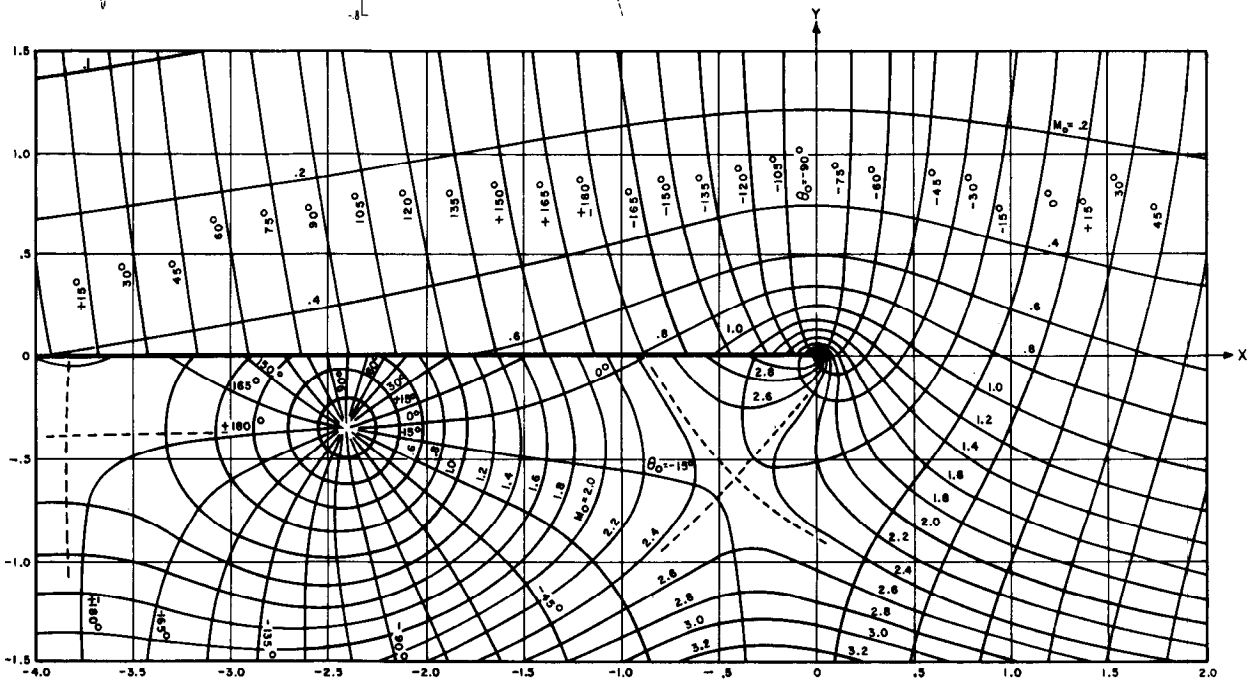

FIGURE 9.4. Contour lines of the modulus and phase of the Hankel Function $H_0^{(1)}(x+iy) = M_0 e^{i\theta_0}$. From E. Jahnke, F. Emde, and F. Lösche, Tables of higher functions, McGraw-Hill Book Co., Inc., New York, N. Y., 1960 (with permission).

Limiting Forms for Small Arguments

When ν is fixed and $z \rightarrow 0$

9.1.7

$$J_\nu(z) \sim (\frac{1}{2}z)^\nu / \Gamma(\nu+1) \quad (\nu \neq -1, -2, -3, \dots)$$

9.1.8 $Y_0(z) \sim -iH_0^{(1)}(z) \sim iH_0^{(2)}(z) \sim (2/\pi) \ln z$

9.1.9

$$Y_\nu(z) \sim -iH_\nu^{(1)}(z) \sim iH_\nu^{(2)}(z) \sim -(1/\pi)\Gamma(\nu)(\frac{1}{2}z)^{-\nu} \quad (\Re \nu > 0)$$

Ascending Series

9.1.10 $J_\nu(z) = (\frac{1}{2}z)^\nu \sum_{k=0}^{\infty} \frac{(-\frac{1}{4}z^2)^k}{k! \Gamma(\nu+k+1)}$

9.1.11

$$Y_n(z) = -\frac{(\frac{1}{2}z)^{-n}}{\pi} \sum_{k=0}^{n-1} \frac{(n-k-1)!}{k!} (\frac{1}{4}z^2)^k + \frac{2}{\pi} \ln(\frac{1}{2}z) J_n(z) - \frac{(\frac{1}{2}z)^n}{\pi} \sum_{k=0}^{\infty} \{\psi(k+1) + \psi(n+k+1)\} \frac{(-\frac{1}{4}z^2)^k}{k!(n+k)!}$$

where $\psi(n)$ is given by 6.3.2.

9.1.12 $J_0(z) = 1 - \frac{1}{4}z^2 + \frac{(\frac{1}{4}z^2)^2}{(2!)^2} - \frac{(\frac{1}{4}z^2)^3}{(3!)^2} + \dots$

9.1.13

$$Y_0(z) = \frac{2}{\pi} \{ \ln(\frac{1}{2}z) + \gamma \} J_0(z) + \frac{2}{\pi} \{ \frac{1}{4}z^2 - (1+\frac{1}{2}) \frac{(\frac{1}{4}z^2)^2}{(2!)^2} + (1+\frac{1}{2}+\frac{1}{3}) \frac{(\frac{1}{4}z^2)^3}{(3!)^2} - \dots \}$$

9.1.14

$$J_\nu(z) J_\mu(z) = (\frac{1}{2}z)^{\nu+\mu} \sum_{k=0}^{\infty} \frac{(-)^k \Gamma(\nu+\mu+2k+1) (\frac{1}{4}z^2)^k}{\Gamma(\nu+k+1) \Gamma(\mu+k+1) \Gamma(\nu+\mu+k+1) k!}$$

Wronskians

9.1.15

$$W\{J_\nu(z), J_{-\nu}(z)\} = J_{\nu+1}(z) J_{-\nu}(z) + J_\nu(z) J_{-(\nu+1)}(z) = -2 \sin(\nu\pi) / (\pi z)$$

9.1.16

$$W\{J_\nu(z), Y_\nu(z)\} = J_{\nu+1}(z) Y_\nu(z) - J_\nu(z) Y_{\nu+1}(z) = 2 / (\pi z)$$

9.1.17

$$W\{H_\nu^{(1)}(z), H_\nu^{(2)}(z)\} = H_{\nu+1}^{(1)}(z) H_\nu^{(2)}(z) - H_\nu^{(1)}(z) H_{\nu+1}^{(2)}(z) = -4i / (\pi z)$$

Integral Representations

9.1.18

$$J_0(z) = \frac{1}{\pi} \int_0^\pi \cos(z \sin \theta) d\theta = \frac{1}{\pi} \int_0^\pi \cos(z \cos \theta) d\theta$$

9.1.19

$$Y_0(z) = \frac{4}{\pi^2} \int_0^{i\pi} \cos(z \cos \theta) \{ \gamma + \ln(2z \sin^2 \theta) \} d\theta$$

9.1.20

$$J_\nu(z) = \frac{(\frac{1}{2}z)^\nu}{\pi^{\frac{1}{2}} \Gamma(\nu + \frac{1}{2})} \int_0^\pi \cos(z \cos \theta) \sin^{2\nu} \theta d\theta = \frac{2(\frac{1}{2}z)^\nu}{\pi^{\frac{1}{2}} \Gamma(\nu + \frac{1}{2})} \int_0^1 (1-t^2)^{\nu-\frac{1}{2}} \cos(zt) dt \quad (\Re \nu > -\frac{1}{2})$$

9.1.21

$$J_n(z) = \frac{1}{\pi} \int_0^\pi \cos(z \sin \theta - n\theta) d\theta = \frac{i^{-n}}{\pi} \int_0^\pi e^{iz \cos \theta} \cos(n\theta) d\theta$$

9.1.22

$$J_\nu(z) = \frac{1}{\pi} \int_0^\pi \cos(z \sin \theta - \nu\theta) d\theta - \frac{\sin(\nu\pi)}{\pi} \int_0^\infty e^{-z \sinh t - \nu t} dt \quad (|\arg z| < \frac{1}{2}\pi)$$

$$Y_\nu(z) = \frac{1}{\pi} \int_0^\pi \sin(z \sin \theta - \nu\theta) d\theta$$

$$- \frac{1}{\pi} \int_0^\infty \{ e^{\nu t} + e^{-\nu t} \cos(\nu\pi) \} e^{-z \sinh t} dt \quad (|\arg z| < \frac{1}{2}\pi)$$

9.1.23

$$J_0(x) = \frac{2}{\pi} \int_0^\infty \sin(x \cosh t) dt \quad (x > 0)$$

$$Y_0(x) = -\frac{2}{\pi} \int_0^\infty \cos(x \cosh t) dt \quad (x > 0)$$

9.1.24

$$J_\nu(x) = \frac{2(\frac{1}{2}x)^{-\nu}}{\pi^{\frac{1}{2}} \Gamma(\frac{1}{2}-\nu)} \int_1^\infty \frac{\sin(xt) dt}{(t^2-1)^{\nu+\frac{1}{2}}} \quad (|\Re \nu| < \frac{1}{2}, x > 0)$$

$$Y_\nu(x) = -\frac{2(\frac{1}{2}x)^{-\nu}}{\pi^{\frac{1}{2}} \Gamma(\frac{1}{2}-\nu)} \int_1^\infty \frac{\cos(xt) dt}{(t^2-1)^{\nu+\frac{1}{2}}} \quad (|\Re \nu| < \frac{1}{2}, x > 0)$$

9.1.25

$$H_\nu^{(1)}(z) = \frac{1}{\pi i} \int_{-\infty}^{\infty + \pi i} e^{z \sinh t - \nu t} dt \quad (|\arg z| < \frac{1}{2}\pi)$$

$$H_\nu^{(2)}(z) = -\frac{1}{\pi i} \int_{-\infty}^{\infty - \pi i} e^{z \sinh t - \nu t} dt \quad (|\arg z| < \frac{1}{2}\pi)$$

9.1.26

$$J_\nu(x) = \frac{1}{2\pi i} \int_{-i\infty}^{i\infty} \frac{\Gamma(-t) (\frac{1}{2}x)^{\nu+2t}}{\Gamma(\nu+t+1)} dt \quad (\Re \nu > 0, x > 0)$$

In the last integral the path of integration must lie to the left of the points $t=0, 1, 2, \dots$

Recurrence Relations

9.1.27

$$\begin{aligned} \mathcal{C}_{\nu-1}(z) + \mathcal{C}_{\nu+1}(z) &= \frac{2\nu}{z} \mathcal{C}_{\nu}(z) \\ \mathcal{C}_{\nu-1}(z) - \mathcal{C}_{\nu+1}(z) &= 2\mathcal{C}'_{\nu}(z) \\ \mathcal{C}'_{\nu}(z) &= \mathcal{C}_{\nu-1}(z) - \frac{\nu}{z} \mathcal{C}_{\nu}(z) \\ \mathcal{C}'_{\nu}(z) &= -\mathcal{C}_{\nu+1}(z) + \frac{\nu}{z} \mathcal{C}_{\nu}(z) \end{aligned}$$

\mathcal{C} denotes $J, Y, H^{(1)}, H^{(2)}$ or any linear combination of these functions, the coefficients in which are independent of z and ν .

9.1.28 $J'_0(z) = -J_1(z) \quad Y'_0(z) = -Y_1(z)$

If $f_{\nu}(z) = z^p \mathcal{C}_{\nu}(\lambda z^q)$ where p, q, λ are independent of ν , then

9.1.29

$$\begin{aligned} f_{\nu-1}(z) + f_{\nu+1}(z) &= (2\nu/\lambda) z^{-q} f_{\nu}(z) \\ (p + \nu q) f_{\nu-1}(z) + (p - \nu q) f_{\nu+1}(z) &= (2\nu/\lambda) z^{1-q} f'_{\nu}(z) \\ z f'_{\nu}(z) &= \lambda q z^q f_{\nu-1}(z) + (p - \nu q) f_{\nu}(z) \\ z f'_{\nu}(z) &= -\lambda q z^q f_{\nu+1}(z) + (p + \nu q) f_{\nu}(z) \end{aligned}$$

Formulas for Derivatives

9.1.30

$$\begin{aligned} \left(\frac{1}{z} \frac{d}{dz}\right)^k \{z^{\nu} \mathcal{C}_{\nu}(z)\} &= z^{\nu-k} \mathcal{C}_{\nu-k}(z) \\ \left(\frac{1}{z} \frac{d}{dz}\right)^k \{z^{-\nu} \mathcal{C}_{\nu}(z)\} &= (-1)^k z^{-\nu-k} \mathcal{C}_{\nu+k}(z) \end{aligned} \quad (k=0, 1, 2, \dots)$$

9.1.31

$$\begin{aligned} \mathcal{C}_{\nu}^{(k)}(z) &= \frac{1}{2^k} \left\{ \mathcal{C}_{\nu-k}(z) - \binom{k}{1} \mathcal{C}_{\nu-k+2}(z) \right. \\ &\quad \left. + \binom{k}{2} \mathcal{C}_{\nu-k+4}(z) - \dots + (-1)^k \mathcal{C}_{\nu+k}(z) \right\} \end{aligned} \quad (k=0, 1, 2, \dots)$$

Recurrence Relations for Cross-Products

If

9.1.32

$$\begin{aligned} p_{\nu} &= J_{\nu}(a) Y_{\nu}(b) - J_{\nu}(b) Y_{\nu}(a) \\ q_{\nu} &= J_{\nu}(a) Y'_{\nu}(b) - J'_{\nu}(b) Y_{\nu}(a) \\ r_{\nu} &= J'_{\nu}(a) Y_{\nu}(b) - J_{\nu}(b) Y'_{\nu}(a) \\ s_{\nu} &= J'_{\nu}(a) Y'_{\nu}(b) - J'_{\nu}(b) Y'_{\nu}(a) \end{aligned}$$

then

9.1.33

$$\begin{aligned} p_{\nu+1} - p_{\nu-1} &= -\frac{2\nu}{a} q_{\nu} - \frac{2\nu}{b} r_{\nu} \\ q_{\nu+1} + r_{\nu} &= \frac{\nu}{a} p_{\nu} - \frac{\nu+1}{b} p_{\nu+1} \\ r_{\nu+1} + q_{\nu} &= \frac{\nu}{b} p_{\nu} - \frac{\nu+1}{a} p_{\nu+1} \\ s_{\nu} &= \frac{1}{2} p_{\nu+1} + \frac{1}{2} p_{\nu-1} - \frac{\nu^2}{ab} p_{\nu} \end{aligned}$$

and

9.1.34 $p_{\nu} s_{\nu} - q_{\nu} r_{\nu} = \frac{4}{\pi^2 ab}$

Analytic Continuation

In 9.1.35 to 9.1.38, m is an integer.

9.1.35 $J_{\nu}(ze^{m\pi i}) = e^{m\nu\pi i} J_{\nu}(z)$

9.1.36

$$Y_{\nu}(ze^{m\pi i}) = e^{-m\nu\pi i} Y_{\nu}(z) + 2i \sin(m\nu\pi) \cot(\nu\pi) J_{\nu}(z)$$

9.1.37

$$\begin{aligned} \sin(\nu\pi) H_{\nu}^{(1)}(ze^{m\pi i}) &= -\sin\{(m-1)\nu\pi\} H_{\nu}^{(1)}(z) \\ &\quad - e^{-\nu\pi i} \sin(m\nu\pi) H_{\nu}^{(2)}(z) \end{aligned}$$

9.1.38

$$\begin{aligned} \sin(\nu\pi) H_{\nu}^{(2)}(ze^{m\pi i}) &= \sin\{(m+1)\nu\pi\} H_{\nu}^{(2)}(z) \\ &\quad + e^{\nu\pi i} \sin(m\nu\pi) H_{\nu}^{(1)}(z) \end{aligned}$$

9.1.39

$$\begin{aligned} H_{\nu}^{(1)}(ze^{\pi i}) &= -e^{-\nu\pi i} H_{\nu}^{(2)}(z) \\ H_{\nu}^{(2)}(ze^{-\pi i}) &= -e^{\nu\pi i} H_{\nu}^{(1)}(z) \end{aligned}$$

9.1.40

$$\begin{aligned} J_{\nu}(\bar{z}) &= \overline{J_{\nu}(z)} \quad Y_{\nu}(\bar{z}) = \overline{Y_{\nu}(z)} \\ H_{\nu}^{(1)}(\bar{z}) &= \overline{H_{\nu}^{(2)}(z)} \quad H_{\nu}^{(2)}(\bar{z}) = \overline{H_{\nu}^{(1)}(z)} \quad (\nu \text{ real}) \end{aligned}$$

Generating Function and Associated Series

9.1.41 $e^{tz(t-1/l)} = \sum_{k=-\infty}^{\infty} t^k J_k(z) \quad (t \neq 0)$

9.1.42 $\cos(z \sin \theta) = J_0(z) + 2 \sum_{k=1}^{\infty} J_{2k}(z) \cos(2k\theta)$

9.1.43 $\sin(z \sin \theta) = 2 \sum_{k=0}^{\infty} J_{2k+1}(z) \sin\{(2k+1)\theta\}$

9.1.44

$$\cos(z \cos \theta) = J_0(z) + 2 \sum_{k=1}^{\infty} (-1)^k J_{2k}(z) \cos(2k\theta)$$

9.1.45

$$\sin(z \cos \theta) = 2 \sum_{k=0}^{\infty} (-1)^k J_{2k+1}(z) \cos\{(2k+1)\theta\}$$

9.1.46 $1 = J_0(z) + 2J_2(z) + 2J_4(z) + 2J_6(z) + \dots$

9.1.47

$$\cos z = J_0(z) - 2J_2(z) + 2J_4(z) - 2J_6(z) + \dots$$

9.1.48 $\sin z = 2J_1(z) - 2J_3(z) + 2J_5(z) - \dots$

Other Differential Equations

9.1.49 $w'' + \left(\lambda^2 - \frac{\nu^2 - \frac{1}{4}}{z^2}\right)w = 0, \quad w = z^{\frac{1}{2}}\mathcal{C}_\nu(\lambda z)$

9.1.50 $w'' + \left(\frac{\lambda^2}{4z} - \frac{\nu^2 - 1}{4z^2}\right)w = 0, \quad w = z^{\frac{1}{2}}\mathcal{C}_\nu(\lambda z^{\frac{1}{2}})$

9.1.51 $w'' + \lambda^2 z^{\nu-2}w = 0, \quad w = z^{\frac{1}{2}}\mathcal{C}_{1/\nu}(2\lambda z^{\frac{1}{2}}/p)$

9.1.52

$w'' - \frac{2\nu-1}{z}w' + \lambda^2 w = 0, \quad w = z^\nu \mathcal{C}_\nu(\lambda z)$

9.1.53

$z^2 w'' + (1-2p)zw' + (\lambda^2 q^2 z^{2a} + p^2 - \nu^2 q^2)w = 0, \quad w = z^p \mathcal{C}_\nu(\lambda z^q)$

9.1.54

$w'' + (\lambda^2 e^{2z} - \nu^2)w = 0, \quad w = \mathcal{C}_\nu(\lambda e^z)$

9.1.55

$z^2(z^2 - \nu^2)w'' + z(z^2 - 3\nu^2)w' + \{(z^2 - \nu^2)^2 - (z^2 + \nu^2)\}w = 0, \quad w = \mathcal{C}'_\nu(z)$

9.1.56

$w^{(2n)} = (-1)^n \lambda^{2n} z^{-n} w, \quad w = z^{\frac{1}{2}} \mathcal{C}_n(2\lambda \alpha z^{\frac{1}{2}})$

where α is any of the $2n$ roots of unity.

Differential Equations for Products

In the following $\vartheta \equiv z \frac{d}{dz}$ and $\mathcal{C}_\nu(z), \mathcal{D}_\mu(z)$ are any cylinder functions of orders ν, μ respectively.

9.1.57

$\{\vartheta^4 - 2(\nu^2 + \mu^2)\vartheta^2 + (\nu^2 - \mu^2)^2\}w + 4z^2(\vartheta + 1)(\vartheta + 2)w = 0, \quad w = \mathcal{C}_\nu(z)\mathcal{D}_\mu(z)$

9.1.58

$\vartheta(\vartheta^2 - 4\nu^2)w + 4z^2(\vartheta + 1)w = 0, \quad w = \mathcal{C}_\nu(z)\mathcal{D}_\nu(z)$

9.1.59

$z^3 w''' + z(4z^2 + 1 - 4\nu^2)w' + (4\nu^2 - 1)w = 0, \quad w = z \mathcal{C}_\nu(z)\mathcal{D}_\nu(z)$

Upper Bounds

9.1.60 $|J_\nu(x)| \leq 1 \quad (\nu \geq 0), \quad |J_\nu(x)| \leq 1/\sqrt{2} \quad (\nu \geq 1)$

9.1.61 $0 < J_\nu(\nu) < \frac{2^{\frac{1}{2}}}{3^{\frac{1}{2}}\Gamma(\frac{3}{2})\nu^{\frac{1}{2}}} \quad (\nu > 0)$

9.1.62 $|J_\nu(z)| \leq \frac{|\frac{1}{2}z|^{\nu} |e^{\frac{1}{2}z}|}{\Gamma(\nu+1)} \quad (\nu \geq -\frac{1}{2}) \quad *$

9.1.63 $|J_\nu(nz)| \leq \left| \frac{z^n \exp\{n\sqrt{1-z^2}\}}{\{1+\sqrt{1-z^2}\}^n} \right|$

Derivatives With Respect to Order

9.1.64

$\frac{\partial}{\partial \nu} J_\nu(z) = J_\nu(z) \ln(\frac{1}{2}z)$

$-(\frac{1}{2}z)^\nu \sum_{k=0}^{\infty} (-1)^k \frac{\psi(\nu+k+1)}{\Gamma(\nu+k+1)} \frac{(\frac{1}{2}z^2)^k}{k!}$

9.1.65

$\frac{\partial}{\partial \nu} Y_\nu(z) = \cot(\nu\pi) \left\{ \frac{\partial}{\partial \nu} J_\nu(z) - \pi Y_\nu(z) \right\}$

$-\csc(\nu\pi) \left\{ \frac{\partial}{\partial \nu} J_{-\nu}(z) - \pi J_{-\nu}(z) \right\} \quad (\nu \neq 0, \pm 1, \pm 2, \dots)$

9.1.66

$\left[\frac{\partial}{\partial \nu} J_\nu(z) \right]_{\nu=-n} = \frac{\pi}{2} Y_n(z) + \frac{n!(\frac{1}{2}z)^{-n}}{2} \sum_{k=0}^{n-1} \frac{(\frac{1}{2}z)^k J_k(z)}{(n-k)k!}$

9.1.67

$\left[\frac{\partial}{\partial \nu} Y_\nu(z) \right]_{\nu=-n} = -\frac{\pi}{2} J_n(z) + \frac{n!(\frac{1}{2}z)^{-n}}{2} \sum_{k=0}^{n-1} \frac{(\frac{1}{2}z)^k Y_k(z)}{(n-k)k!}$

9.1.68

$\left[\frac{\partial}{\partial \nu} J_\nu(z) \right]_{\nu=0} = \frac{\pi}{2} Y_0(z), \quad \left[\frac{\partial}{\partial \nu} Y_\nu(z) \right]_{\nu=0} = -\frac{\pi}{2} J_0(z)$

Expressions in Terms of Hypergeometric Functions

9.1.69

$J_\nu(z) = \frac{(\frac{1}{2}z)^\nu}{\Gamma(\nu+1)} {}_0F_1(\nu+1; -\frac{1}{4}z^2) = \frac{(\frac{1}{2}z)^\nu e^{-iz}}{\Gamma(\nu+1)} M(\nu+\frac{1}{2}, 2\nu+1, 2iz)$

9.1.70

$J_\nu(z) = \frac{(\frac{1}{2}z)^\nu}{\Gamma(\nu+1)} \lim_{\lambda, \mu \rightarrow \infty} F\left(\lambda, \mu; \nu+1; -\frac{z^2}{4\lambda\mu}\right)$

as $\lambda, \mu \rightarrow \infty$ through real or complex values; z, ν being fixed.

(${}_0F_1$ is the generalized hypergeometric function. For $M(a, b, z)$ and $F(a, b; c; z)$ see chapters 13 and 15.)

Connection With Legendre Functions

If μ and x are fixed and $\nu \rightarrow \infty$ through real positive values

9.1.71

$\lim \{ \nu^\mu P_{-\nu}^{-\mu}(\cos \frac{x}{\nu}) \} = J_\mu(x) \quad (x > 0)$

*See page 11.

9.1.72

$$\lim \{ \nu^\mu Q_\nu^{-\mu} \left(\cos \frac{x}{\nu} \right) \} = -\frac{1}{2}\pi Y_\mu(x) \quad (x > 0)$$

For $P_\nu^{-\mu}$ and $Q_\nu^{-\mu}$, see chapter 8.

Continued Fractions

9.1.73

$$\begin{aligned} \frac{J_\nu(z)}{J_{\nu-1}(z)} &= \frac{1}{2\nu z^{-1} - \frac{1}{2(\nu+1)z^{-1} - \frac{1}{2(\nu+2)z^{-1} - \dots}}} \\ &= \frac{\frac{1}{2}z/\nu}{1 - \frac{\frac{1}{2}z^2/\{\nu(\nu+1)\}}{1 - \frac{\frac{1}{2}z^2/\{(\nu+1)(\nu+2)\}}{1 - \dots}}} \end{aligned}$$

Multiplication Theorem

9.1.74

$$\mathcal{C}_\nu(\lambda z) = \lambda^{\pm\nu} \sum_{k=0}^{\infty} \frac{(\mp)^k (\lambda^2 - 1)^k (\frac{1}{2}z)^k}{k!} \mathcal{C}_{\nu \pm k}(z) \quad (|\lambda^2 - 1| < 1)$$

If $\mathcal{C} = J$ and the upper signs are taken, the restriction on λ is unnecessary.

This theorem will furnish expansions of $\mathcal{C}_\nu(re^{i\theta})$ in terms of $\mathcal{C}_{\nu \pm k}(r)$.

Addition Theorems

Neumann's

9.1.75 $\mathcal{C}_\nu(u \pm v) = \sum_{k=-\infty}^{\infty} \mathcal{C}_{\nu \mp k}(u) J_k(v) \quad (|v| < |u|)$

The restriction $|v| < |u|$ is unnecessary when $\mathcal{C} = J$ and ν is an integer or zero. Special cases are

9.1.76 $1 = J_0^2(z) + 2 \sum_{k=1}^{\infty} J_k^2(z)$

9.1.77

$$0 = \sum_{k=0}^{2n} (-)^k J_k(z) J_{2n-k}(z) + 2 \sum_{k=1}^{\infty} J_k(z) J_{2n+k}(z) \quad (n \geq 1)$$

9.1.78

$$J_n(2z) = \sum_{k=0}^n J_k(z) J_{n-k}(z) + 2 \sum_{k=1}^{\infty} (-)^k J_k(z) J_{n+k}(z)$$

Graf's

9.1.79

$$\mathcal{C}_\nu(w) \frac{\cos \nu\chi}{\sin \nu\chi} = \sum_{k=-\infty}^{\infty} \mathcal{C}_{\nu+k}(u) J_k(v) \frac{\cos k\alpha}{\sin k\alpha} \quad (|ve^{\pm i\alpha}| < |u|)$$

Gegenbauer's

9.1.80

$$\frac{\mathcal{C}_\nu(w)}{w^\nu} = 2^\nu \Gamma(\nu) \sum_{k=0}^{\infty} (\nu+k) \frac{\mathcal{C}_{\nu+k}(u)}{u^\nu} \frac{J_{\nu+k}(v)}{v^\nu} C_k^{(\nu)}(\cos \alpha) \quad (\nu \neq 0, -1, \dots, |ve^{\pm i\alpha}| < |u|)$$

In 9.1.79 and 9.1.80,

$$w = \sqrt{(u^2 + v^2 - 2uv \cos \alpha)},$$

$$u - v \cos \alpha = w \cos \chi, \quad v \sin \alpha = w \sin \chi$$

the branches being chosen so that $w \rightarrow u$ and $\chi \rightarrow 0$ as $v \rightarrow 0$. $C_k^{(\nu)}(\cos \alpha)$ is Gegenbauer's polynomial (see chapter 22).

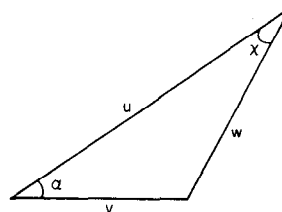

Gegenbauer's addition theorem.

If u, v are real and positive and $0 \leq \alpha \leq \pi$, then w, χ are real and non-negative, and the geometrical relationship of the variables is shown in the diagram.

The restrictions $|ve^{\pm i\alpha}| < |u|$ are unnecessary in 9.1.79 when $\mathcal{C} = J$ and ν is an integer or zero, and in 9.1.80 when $\mathcal{C} = J$.

Degenerate Form ($u = \infty$):

9.1.81

$$e^{i\nu \cos \alpha} = \Gamma(\nu) \left(\frac{1}{2}v\right)^{-\nu} \sum_{k=0}^{\infty} (\nu+k) i^k J_{\nu+k}(v) C_k^{(\nu)}(\cos \alpha) \quad (\nu \neq 0, -1, \dots)$$

Neumann's Expansion of an Arbitrary Function in a Series of Bessel Functions

9.1.82 $f(z) = a_0 J_0(z) + 2 \sum_{k=1}^{\infty} a_k J_k(z) \quad (|z| < c)$

where c is the distance of the nearest singularity of $f(z)$ from $z=0$,

9.1.83 $a_k = \frac{1}{2\pi i} \int_{|z|=c'} f(t) O_k(t) dt \quad (0 < c' < c)$

and $O_k(t)$ is Neumann's polynomial. The latter is defined by the generating function

9.1.84

$$\frac{1}{t-z} = J_0(z) O_0(t) + 2 \sum_{k=1}^{\infty} J_k(z) O_k(t) \quad (|z| < |t|)$$

$O_n(t)$ is a polynomial of degree $n+1$ in $1/t$; $O_0(t) = 1/t$,

9.1.85

$$O_n(t) = \frac{1}{4} \sum_{k=0}^{2n} \frac{n(n-k-1)!}{k!} \left(\frac{2}{t}\right)^{n-2k+1} \quad (n=1, 2, \dots)$$

The more general form of expansion

9.1.86 $f(z) = a_0 J_\nu(z) + 2 \sum_{k=1}^{\infty} a_k J_{\nu+k}(z)$

also called a Neumann expansion, is investigated in [9.7] and [9.15] together with further generalizations. Examples of Neumann expansions are 9.1.41 to 9.1.48 and the Addition Theorems. Other examples are

9.1.87

$$\left(\frac{1}{2}z\right)^\nu = \sum_{k=0}^{\infty} \frac{(\nu+2k)\Gamma(\nu+k)}{k!} J_{\nu+2k}(z) \quad (\nu \neq 0, -1, -2, \dots)$$

9.1.88

$$Y_n(z) = -\frac{n!(\frac{1}{2}z)^{-n}}{\pi} \sum_{k=0}^{n-1} \frac{(\frac{1}{2}z)^k J_k(z)}{(n-k)k!} + \frac{2}{\pi} \left\{ \ln\left(\frac{1}{2}z\right) - \psi(n+1) \right\} J_n(z) - \frac{2}{\pi} \sum_{k=1}^{\infty} (-)^k \frac{(n+2k)J_{n+2k}(z)}{k(n+k)}$$

where $\psi(n)$ is given by 6.3.2.

9.1.89

$$Y_0(z) = \frac{2}{\pi} \left\{ \ln\left(\frac{1}{2}z\right) + \gamma \right\} J_0(z) - \frac{4}{\pi} \sum_{k=1}^{\infty} (-)^k \frac{J_{2k}(z)}{k}$$

9.2. Asymptotic Expansions for Large Arguments

Principal Asymptotic Forms

When ν is fixed and $|z| \rightarrow \infty$

9.2.1

$$J_\nu(z) = \sqrt{2/(\pi z)} \left\{ \cos\left(z - \frac{1}{2}\nu\pi - \frac{1}{4}\pi\right) + e^{i\mathcal{O}z} O(|z|^{-1}) \right\} \quad (|\arg z| < \pi)$$

9.2.2

$$Y_\nu(z) = \sqrt{2/(\pi z)} \left\{ \sin\left(z - \frac{1}{2}\nu\pi - \frac{1}{4}\pi\right) + e^{i\mathcal{O}z} O(|z|^{-1}) \right\} \quad (|\arg z| < \pi)$$

9.2.3

$$H_\nu^{(1)}(z) \sim \sqrt{2/(\pi z)} e^{i(z - \frac{1}{2}\nu\pi - \frac{1}{4}\pi)} \quad (-\pi < \arg z < 2\pi)$$

9.2.4

$$H_\nu^{(2)}(z) \sim \sqrt{2/(\pi z)} e^{-i(z - \frac{1}{2}\nu\pi - \frac{1}{4}\pi)} \quad (-2\pi < \arg z < \pi)$$

Hankel's Asymptotic Expansions

When ν is fixed and $|z| \rightarrow \infty$

9.2.5

$$J_\nu(z) = \sqrt{2/(\pi z)} \{P(\nu, z) \cos \chi - Q(\nu, z) \sin \chi\} \quad (|\arg z| < \pi)$$

9.2.6

$$Y_\nu(z) = \sqrt{2/(\pi z)} \{P(\nu, z) \sin \chi + Q(\nu, z) \cos \chi\} \quad (|\arg z| < \pi)$$

9.2.7

$$H_\nu^{(1)}(z) = \sqrt{2/(\pi z)} \{P(\nu, z) + iQ(\nu, z)\} e^{i\chi} \quad (-\pi < \arg z < 2\pi)$$

9.2.8

$$H_\nu^{(2)}(z) = \sqrt{2/(\pi z)} \{P(\nu, z) - iQ(\nu, z)\} e^{-i\chi} \quad (-2\pi < \arg z < \pi)$$

where $\chi = z - (\frac{1}{2}\nu + \frac{1}{4})\pi$ and, with $4\nu^2$ denoted by μ ,

9.2.9

$$P(\nu, z) \sim \sum_{k=0}^{\infty} (-)^k \frac{(\nu, 2k)}{(2z)^{2k}} = 1 - \frac{(\mu-1)(\mu-9)}{2!(8z)^2} + \frac{(\mu-1)(\mu-9)(\mu-25)(\mu-49)}{4!(8z)^4} - \dots$$

9.2.10

$$Q(\nu, z) \sim \sum_{k=0}^{\infty} (-)^k \frac{(\nu, 2k+1)}{(2z)^{2k+1}} = \frac{\mu-1}{8z} - \frac{(\mu-1)(\mu-9)(\mu-25)}{3!(8z)^3} + \dots$$

If ν is real and non-negative and z is positive, the remainder after k terms in the expansion of $P(\nu, z)$ does not exceed the $(k+1)$ th term in absolute value and is of the same sign, provided that $k > \frac{1}{2}\nu - \frac{1}{4}$. The same is true of $Q(\nu, z)$ provided that $k > \frac{1}{2}\nu - \frac{3}{4}$.

Asymptotic Expansions of Derivatives

With the conditions and notation of the preceding subsection

9.2.11

$$J'_\nu(z) = \sqrt{2/(\pi z)} \{-R(\nu, z) \sin \chi - S(\nu, z) \cos \chi\} \quad (|\arg z| < \pi)$$

9.2.12

$$Y'_\nu(z) = \sqrt{2/(\pi z)} \{R(\nu, z) \cos \chi - S(\nu, z) \sin \chi\} \quad (|\arg z| < \pi)$$

9.2.13

$$H_\nu^{(1)'}(z) = \sqrt{2/(\pi z)} \{iR(\nu, z) - S(\nu, z)\} e^{i\chi} \quad (-\pi < \arg z < 2\pi)$$

9.2.14

$$H_\nu^{(2)'}(z) = \sqrt{2/(\pi z)} \{-iR(\nu, z) - S(\nu, z)\} e^{-i\chi} \quad (-2\pi < \arg z < \pi)$$

9.2.15

$$R(\nu, z) \sim \sum_{k=0}^{\infty} (-)^k \frac{4\nu^2 + 16k^2 - 1}{4\nu^2 - (4k-1)^2} \frac{(\nu, 2k)}{(2z)^{2k}}$$

$$= 1 - \frac{(\mu-1)(\mu+15)}{2!(8z)^2} + \dots$$

9.2.16

$$S(\nu, z) \sim \sum_{k=0}^{\infty} (-)^k \frac{4\nu^2 + 4(2k+1)^2 - 1}{4\nu^2 - (4k+1)^2} \frac{(\nu, 2k+1)}{(2z)^{2k+1}}$$

$$= \frac{\mu+3}{8z} - \frac{(\mu-1)(\mu-9)(\mu+35)}{3!(8z)^3} + \dots$$

Modulus and Phase

For real ν and positive x

9.2.17

$$M_\nu = |H_\nu^{(1)}(x)| = \sqrt{\{J_\nu^2(x) + Y_\nu^2(x)\}}$$

$$\theta_\nu = \arg H_\nu^{(1)}(x) = \arctan \{Y_\nu(x)/J_\nu(x)\}$$

9.2.18

$$N_\nu = |H_\nu^{(1)'}(x)| = \sqrt{\{J_\nu'^2(x) + Y_\nu'^2(x)\}}$$

$$\varphi_\nu = \arg H_\nu^{(1)'}(x) = \arctan \{Y_\nu'(x)/J_\nu'(x)\}$$

9.2.19 $J_\nu(x) = M_\nu \cos \theta_\nu, \quad Y_\nu(x) = M_\nu \sin \theta_\nu,$

9.2.20 $J_\nu'(x) = N_\nu \cos \varphi_\nu, \quad Y_\nu'(x) = N_\nu \sin \varphi_\nu.$

In the following relations, primes denote differentiations with respect to x .

9.2.21 $M_\nu^2 \theta_\nu' = 2/(\pi x) \quad N_\nu^2 \varphi_\nu' = 2(x^2 - \nu^2)/(\pi x^3)$

9.2.22 $N_\nu^2 = M_\nu'^2 + M_\nu^2 \theta_\nu'^2 = M_\nu'^2 + 4/(\pi x M_\nu)^2$

9.2.23 $(x^2 - \nu^2)M_\nu M_\nu' + x^2 N_\nu N_\nu' + x N_\nu^2 = 0$

9.2.24

$$\tan(\varphi_\nu - \theta_\nu) = M_\nu \theta_\nu' / M_\nu' = 2/(\pi x M_\nu M_\nu')$$

$$M_\nu N_\nu \sin(\varphi_\nu - \theta_\nu) = 2/(\pi x)$$

9.2.25 $x^2 M_\nu'' + x M_\nu' + (x^2 - \nu^2)M_\nu - 4/(\pi^2 M_\nu^3) = 0$

9.2.26

$$x^3 w'''' + x(4x^2 + 1 - 4\nu^2)w' + (4\nu^2 - 1)w = 0, \quad w = x M_\nu^2$$

9.2.27 $\theta_\nu'^2 + \frac{1}{2} \frac{\theta_\nu'''}{\theta_\nu'} - \frac{3}{4} \left(\frac{\theta_\nu''}{\theta_\nu'}\right)^2 = 1 - \frac{\nu^2 - \frac{1}{4}}{x^2}$

Asymptotic Expansions of Modulus and Phase

When ν is fixed, x is large and positive, and $\mu = 4\nu^2$

9.2.28

$$M_\nu^2 \sim \frac{2}{\pi x} \left\{ 1 + \frac{1}{2} \frac{\mu-1}{(2x)^2} + \frac{1 \cdot 3}{2 \cdot 4} \frac{(\mu-1)(\mu-9)}{(2x)^4} \right.$$

$$\left. + \frac{1 \cdot 3 \cdot 5}{2 \cdot 4 \cdot 6} \frac{(\mu-1)(\mu-9)(\mu-25)}{(2x)^6} + \dots \right\}$$

9.2.29

$$\theta_\nu \sim x - \left(\frac{1}{2}\nu + \frac{1}{4}\right)\pi + \frac{\mu-1}{2(4x)}$$

$$+ \frac{(\mu-1)(\mu-25)}{6(4x)^3} + \frac{(\mu-1)(\mu^2-114\mu+1073)}{5(4x)^5}$$

$$+ \frac{(\mu-1)(5\mu^3-1535\mu^2+54703\mu-375733)}{14(4x)^7} + \dots$$

9.2.30

$$N_\nu^2 \sim \frac{2}{\pi x} \left\{ 1 - \frac{1}{2} \frac{\mu-3}{(2x)^2} - \frac{1 \cdot 1}{2 \cdot 4} \frac{(\mu-1)(\mu-45)}{(2x)^4} - \dots \right\}$$

The general term in the last expansion is given by

$$-\frac{1 \cdot 1 \cdot 3 \dots (2k-3)}{2 \cdot 4 \cdot 6 \dots (2k)}$$

$$\times \frac{(\mu-1)(\mu-9) \dots \{\mu - (2k-3)^2\} \{\mu - (2k+1)(2k-1)^2\}}{(2x)^{2k}} *$$

9.2.31

$$\phi_\nu \sim x - \left(\frac{1}{2}\nu - \frac{1}{4}\right)\pi + \frac{\mu+3}{2(4x)} + \frac{\mu^2+46\mu-63}{6(4x)^3}$$

$$+ \frac{\mu^3+185\mu^2-2053\mu+1899}{5(4x)^5} + \dots$$

If $\nu \geq 0$, the remainder after k terms in 9.2.28 does not exceed the $(k+1)$ th term in absolute value and is of the same sign, provided that $k > \nu - \frac{1}{2}$.

9.3. Asymptotic Expansions for Large Orders

Principal Asymptotic Forms

In the following equations it is supposed that $\nu \rightarrow \infty$ through real positive values, the other variables being fixed.

9.3.1

$$J_\nu(z) \sim \frac{1}{\sqrt{2\pi\nu}} \left(\frac{ez}{2\nu}\right)^\nu$$

$$Y_\nu(z) \sim -\sqrt{\frac{2}{\pi\nu}} \left(\frac{ez}{2\nu}\right)^{-\nu}$$

9.3.2

$$J_\nu(\nu \operatorname{sech} \alpha) \sim \frac{e^{\nu(\tanh \alpha - \alpha)}}{\sqrt{2\pi\nu \tanh \alpha}} \quad (\alpha > 0)$$

$$Y_\nu(\nu \operatorname{sech} \alpha) \sim -\frac{e^{\nu(\alpha - \tanh \alpha)}}{\sqrt{\frac{1}{2}\pi\nu \tanh \alpha}} \quad (\alpha > 0)$$

*See page II.

9.3.3

$$J_\nu(\nu \sec \beta) = \sqrt{2/(\pi\nu \tan \beta)} \{ \cos(\nu \tan \beta - \nu\beta - \frac{1}{4}\pi) + O(\nu^{-1}) \}$$

$$(0 < \beta < \frac{1}{2}\pi)$$

$$Y_\nu(\nu \sec \beta) = \sqrt{2/(\pi\nu \tan \beta)} \{ \sin(\nu \tan \beta - \nu\beta - \frac{1}{4}\pi) + O(\nu^{-1}) \}$$

$$(0 < \beta < \frac{1}{2}\pi)$$

9.3.4

$$J_\nu(\nu + z\nu^{1/2}) = 2^{1/2}\nu^{-1/2} \text{Ai}(-2^{1/2}z) + O(\nu^{-1})$$

$$Y_\nu(\nu + z\nu^{1/2}) = -2^{1/2}\nu^{-1/2} \text{Bi}(-2^{1/2}z) + O(\nu^{-1})$$

9.3.5

$$J_\nu(\nu) \sim \frac{2^{1/2}}{3^{3/2}\Gamma(\frac{2}{3})} \frac{1}{\nu^{1/2}}$$

$$Y_\nu(\nu) \sim -\frac{2^{1/2}}{3^{1/2}\Gamma(\frac{2}{3})} \frac{1}{\nu^{1/2}}$$

9.3.6

$$J_\nu(\nu z) = \left(\frac{4\zeta}{1-z^2}\right)^{1/4} \left\{ \frac{\text{Ai}(\nu^{2/3}\zeta)}{\nu^{1/4}} + \frac{\exp(-\frac{2}{3}\nu\zeta^{3/2})}{1+\nu^{1/6}|\zeta|^{1/4}} O\left(\frac{1}{\nu^{1/4}}\right) \right\} \quad (|\arg z| < \pi)$$

$$Y_\nu(\nu z) = -\left(\frac{4\zeta}{1-z^2}\right)^{1/4} \left\{ \frac{\text{Bi}(\nu^{2/3}\zeta)}{\nu^{1/4}} + \frac{\exp|\Re(\frac{2}{3}\nu\zeta^{3/2})|}{1+\nu^{1/6}|\zeta|^{1/4}} O\left(\frac{1}{\nu^{1/4}}\right) \right\} \quad (|\arg z| < \pi)$$

In the last two equations ζ is given by 9.3.38 and 9.3.39 below.

Debye's Asymptotic Expansions

(i) If α is fixed and positive and ν is large and positive

9.3.7

$$J_\nu(\nu \text{sech } \alpha) \sim \frac{e^{\nu(\tanh \alpha - \alpha)}}{\sqrt{2\pi\nu \tanh \alpha}} \left\{ 1 + \sum_{k=1}^{\infty} \frac{u_k(\coth \alpha)}{\nu^k} \right\}$$

9.3.8

$$Y_\nu(\nu \text{sech } \alpha) \sim \frac{e^{\nu(\alpha - \tanh \alpha)}}{\sqrt{\frac{1}{2}\pi\nu \tanh \alpha}} \left\{ 1 + \sum_{k=1}^{\infty} (-)^k \frac{u_k(\coth \alpha)}{\nu^k} \right\}$$

where

9.3.9

$$u_0(t) = 1$$

$$u_1(t) = (3t - 5t^3)/24$$

$$u_2(t) = (81t^2 - 462t^4 + 385t^6)/1152$$

$$u_3(t) = (30375t^3 - 3\ 69603t^5 + 7\ 65765t^7 - 4\ 25425t^9)/4\ 14720$$

$$u_4(t) = (44\ 65125t^4 - 941\ 21676t^6 + 3499\ 22430t^8 - 4461\ 85740t^{10} + 1859\ 10725t^{12})/398\ 13120$$

For $u_5(t)$ and $u_6(t)$ see [9.4] or [9.21].

9.3.10

$$u_{k+1}(t) = \frac{1}{2}t^2(1-t^2)u'_k(t) + \frac{1}{8} \int_0^t (1-5t^2)u_k(t) dt$$

$$(k=0, 1, \dots)$$

Also

9.3.11

$$J'_\nu(\nu \text{sech } \alpha) \sim \sqrt{\frac{\sinh 2\alpha}{4\pi\nu}} e^{\nu(\tanh \alpha - \alpha)} \left\{ 1 + \sum_{k=1}^{\infty} \frac{v_k(\coth \alpha)}{\nu^k} \right\}$$

9.3.12

$$Y'_\nu(\nu \text{sech } \alpha) \sim \sqrt{\frac{\sinh 2\alpha}{\pi\nu}} e^{\nu(\alpha - \tanh \alpha)} \left\{ 1 + \sum_{k=1}^{\infty} (-)^k \frac{v_k(\coth \alpha)}{\nu^k} \right\}$$

where

9.3.13

$$v_0(t) = 1$$

$$v_1(t) = (-9t + 7t^3)/24$$

$$v_2(t) = (-135t^2 + 594t^4 - 455t^6)/1152$$

$$v_3(t) = (-42525t^3 + 4\ 51737t^5 - 8\ 83575t^7 + 4\ 75475t^9)/4\ 14720$$

9.3.14

$$v_k(t) = u_k(t) + t(t^2 - 1) \left\{ \frac{1}{2}u_{k-1}(t) + tu'_{k-1}(t) \right\}$$

$$(k=1, 2, \dots)$$

(ii) If β is fixed, $0 < \beta < \frac{1}{2}\pi$ and ν is large and positive

9.3.15

$$J_\nu(\nu \sec \beta) = \sqrt{2/(\pi\nu \tan \beta)} \{ L(\nu, \beta) \cos \Psi + M(\nu, \beta) \sin \Psi \}$$

9.3.16

$$Y_\nu(\nu \sec \beta) = \sqrt{2/(\pi\nu \tan \beta)} \{ L(\nu, \beta) \sin \Psi - M(\nu, \beta) \cos \Psi \}$$

where $\Psi = \nu(\tan \beta - \beta) - \frac{1}{4}\pi$

9.3.17

$$L(\nu, \beta) \sim \sum_{k=0}^{\infty} \frac{u_{2k}(i \cot \beta)}{\nu^{2k}}$$

$$= 1 - \frac{81 \cot^2 \beta + 462 \cot^4 \beta + 385 \cot^6 \beta}{1152\nu^2} + \dots$$

9.3.18

$$M(\nu, \beta) \sim -i \sum_{k=0}^{\infty} \frac{u_{2k+1}(i \cot \beta)}{\nu^{2k+1}} \\ = \frac{3 \cot \beta + 5 \cot^3 \beta}{24\nu} \dots$$

Also

9.3.19

$$J'_{\nu}(\nu \sec \beta) = \sqrt{(\sin 2\beta)/(\pi\nu)} \{ -N(\nu, \beta) \sin \Psi \\ - O(\nu, \beta) \cos \Psi \}$$

9.3.20

$$Y'_{\nu}(\nu \sec \beta) = \sqrt{(\sin 2\beta)/(\pi\nu)} \{ N(\nu, \beta) \cos \Psi \\ - O(\nu, \beta) \sin \Psi \}$$

where

9.3.21

$$N(\nu, \beta) \sim \sum_{k=0}^{\infty} \frac{v_{2k}(i \cot \beta)}{\nu^{2k}} \\ = 1 + \frac{135 \cot^2 \beta + 594 \cot^4 \beta + 455 \cot^6 \beta}{1152\nu^2} \dots$$

9.3.22

$$O(\nu, \beta) \sim i \sum_{k=0}^{\infty} \frac{v_{2k+1}(i \cot \beta)}{\nu^{2k+1}} = \frac{9 \cot \beta + 7 \cot^3 \beta}{24\nu} \dots$$

Asymptotic Expansions in the Transition Regions

When z is fixed, $|\nu|$ is large and $|\arg \nu| < \frac{1}{2}\pi$

9.3.23

$$J_{\nu}(\nu + z\nu^{1/3}) \sim \frac{2^{1/3}}{\nu^{1/3}} \text{Ai}(-2^{1/3}z) \left\{ 1 + \sum_{k=1}^{\infty} \frac{f_k(z)}{\nu^{2k/3}} \right\} \\ + \frac{2^{2/3}}{\nu} \text{Ai}'(-2^{1/3}z) \sum_{k=0}^{\infty} \frac{g_k(z)}{\nu^{2k/3}}$$

9.3.24

$$Y_{\nu}(\nu + z\nu^{1/3}) \sim -\frac{2^{1/3}}{\nu^{1/3}} \text{Bi}(-2^{1/3}z) \left\{ 1 + \sum_{k=1}^{\infty} \frac{f_k(z)}{\nu^{2k/3}} \right\} \\ - \frac{2^{2/3}}{\nu} \text{Bi}'(-2^{1/3}z) \sum_{k=0}^{\infty} \frac{g_k(z)}{\nu^{2k/3}}$$

where

9.3.25

$$f_1(z) = -\frac{1}{5}z \\ f_2(z) = -\frac{9}{100}z^5 + \frac{3}{35}z^2 \\ f_3(z) = \frac{957}{7000}z^6 - \frac{173}{3150}z^3 - \frac{1}{225} \\ f_4(z) = \frac{27}{20000}z^{10} - \frac{23573}{147000}z^7 + \frac{5903}{138600}z^4 + \frac{947}{346500}z$$

9.3.26

$$g_0(z) = \frac{3}{10}z^2 \\ g_1(z) = -\frac{17}{70}z^3 + \frac{1}{70} \\ g_2(z) = -\frac{9}{1000}z^7 + \frac{611}{3150}z^4 - \frac{37}{3150}z \\ g_3(z) = \frac{549}{28000}z^8 - \frac{110767}{693000}z^5 + \frac{79}{12375}z^2$$

The corresponding expansions for $H_{\nu}^{(1)}(\nu + z\nu^{1/3})$ and $H_{\nu}^{(2)}(\nu + z\nu^{1/3})$ are obtained by use of 9.1.3 and 9.1.4; they are valid for $-\frac{1}{2}\pi < \arg \nu < \frac{3}{2}\pi$ and $-\frac{3}{2}\pi < \arg \nu < \frac{1}{2}\pi$, respectively.

9.3.27

$$J'_{\nu}(\nu + z\nu^{1/3}) \sim -\frac{2^{2/3}}{\nu^{2/3}} \text{Ai}'(-2^{1/3}z) \left\{ 1 + \sum_{k=1}^{\infty} \frac{h_k(z)}{\nu^{2k/3}} \right\} \\ + \frac{2^{1/3}}{\nu^{4/3}} \text{Ai}(-2^{1/3}z) \sum_{k=0}^{\infty} \frac{l_k(z)}{\nu^{2k/3}}$$

9.3.28

$$Y'_{\nu}(\nu + z\nu^{1/3}) \sim \frac{2^{2/3}}{\nu^{2/3}} \text{Bi}'(-2^{1/3}z) \left\{ 1 + \sum_{k=1}^{\infty} \frac{h_k(z)}{\nu^{2k/3}} \right\} \\ - \frac{2^{1/3}}{\nu^{4/3}} \text{Bi}(-2^{1/3}z) \sum_{k=0}^{\infty} \frac{l_k(z)}{\nu^{2k/3}}$$

where

9.3.29

$$h_1(z) = -\frac{4}{5}z \\ h_2(z) = -\frac{9}{100}z^5 + \frac{57}{70}z^2 \\ h_3(z) = \frac{699}{3500}z^6 - \frac{2617}{3150}z^3 + \frac{23}{3150} \\ h_4(z) = \frac{27}{20000}z^{10} - \frac{46631}{147000}z^7 + \frac{3889}{4620}z^4 - \frac{1159}{115500}z$$

9.3.30

$$l_0(z) = \frac{3}{5}z^3 - \frac{1}{5} \\ l_1(z) = -\frac{131}{140}z^4 + \frac{1}{5}z \\ l_2(z) = -\frac{9}{500}z^8 + \frac{5437}{4500}z^5 - \frac{593}{3150}z^2 \\ l_3(z) = \frac{369}{7000}z^9 - \frac{999443}{693000}z^6 + \frac{31727}{173250}z^3 + \frac{947}{346500}$$

$$9.3.31 \quad J_\nu(\nu) \sim \frac{a}{\nu^{1/3}} \left\{ 1 + \sum_{k=1}^{\infty} \frac{\alpha_k}{\nu^{2k}} \right\} - \frac{b}{\nu^{5/3}} \sum_{k=0}^{\infty} \frac{\beta_k}{\nu^{2k}}$$

$$9.3.32 \quad Y_\nu(\nu) \sim -\frac{3^{1/2}a}{\nu^{1/3}} \left\{ 1 + \sum_{k=1}^{\infty} \frac{\alpha_k}{\nu^{2k}} \right\} - \frac{3^{1/2}b}{\nu^{5/3}} \sum_{k=0}^{\infty} \frac{\beta_k}{\nu^{2k}}$$

$$9.3.33 \quad J'_\nu(\nu) \sim \frac{b}{\nu^{2/3}} \left\{ 1 + \sum_{k=1}^{\infty} \frac{\gamma_k}{\nu^{2k}} \right\} - \frac{a}{\nu^{4/3}} \sum_{k=0}^{\infty} \frac{\delta_k}{\nu^{2k}}$$

$$9.3.34 \quad Y'_\nu(\nu) \sim \frac{3^{1/2}b}{\nu^{2/3}} \left\{ 1 + \sum_{k=1}^{\infty} \frac{\gamma_k}{\nu^{2k}} \right\} + \frac{3^{1/2}a}{\nu^{4/3}} \sum_{k=0}^{\infty} \frac{\delta_k}{\nu^{2k}}$$

where

$$a = \frac{2^{1/3}}{3^{2/3}\Gamma(\frac{2}{3})} = .44730 \ 73184, \quad 3^{\frac{1}{2}}a = .77475 \ 90021$$

$$b = \frac{2^{2/3}}{3^{1/3}\Gamma(\frac{1}{3})} = .41085 \ 01939, \quad 3^{\frac{1}{2}}b = .71161 \ 34101$$

$$\alpha_0 = 1, \quad \alpha_1 = -\frac{1}{225} = -.004\dot{4},$$

$$\alpha_2 = .00069 \ 3735 \dots, \quad \alpha_3 = -.00035 \ 38 \dots$$

$$\beta_0 = \frac{1}{70} = .01428 \ 57143 \dots,$$

$$\beta_1 = -\frac{1213}{10 \ 23750} = -.00118 \ 48596 \dots,$$

$$\beta_2 = .00043 \ 78 \dots, \quad \beta_3 = -.00038 \dots$$

$$\gamma_0 = 1, \quad \gamma_1 = \frac{23}{3150} = .00730 \ 15873 \dots,$$

$$\gamma_2 = -.00093 \ 7300 \dots, \quad \gamma_3 = .00044 \ 40 \dots$$

$$\delta_0 = \frac{1}{5}, \quad \delta_1 = -\frac{947}{3 \ 46500} = -.00273 \ 30447 \dots,$$

$$\delta_2 = .00060 \ 47 \dots, \quad \delta_3 = -.00038 \dots$$

Uniform Asymptotic Expansions

These are more powerful than the previous expansions of this section, save for 9.3.31 and 9.3.32, but their coefficients are more complicated. They reduce to 9.3.31 and 9.3.32 when the argument equals the order.

9.3.35

$$J_\nu(\nu z) \sim \left(\frac{4\zeta}{1-z^2} \right)^{1/4} \left\{ \frac{\text{Ai}(\nu^{2/3}\zeta)}{\nu^{1/3}} \sum_{k=0}^{\infty} \frac{a_k(\zeta)}{\nu^{2k}} + \frac{\text{Ai}'(\nu^{2/3}\zeta)}{\nu^{5/3}} \sum_{k=0}^{\infty} \frac{b_k(\zeta)}{\nu^{2k}} \right\}$$

9.3.36

$$Y_\nu(\nu z) \sim -\left(\frac{4\zeta}{1-z^2} \right)^{1/4} \left\{ \frac{\text{Bi}(\nu^{2/3}\zeta)}{\nu^{1/3}} \sum_{k=0}^{\infty} \frac{a_k(\zeta)}{\nu^{2k}} + \frac{\text{Bi}'(\nu^{2/3}\zeta)}{\nu^{5/3}} \sum_{k=0}^{\infty} \frac{b_k(\zeta)}{\nu^{2k}} \right\}$$

9.3.37

$$H_\nu^{(1)}(\nu z) \sim 2e^{-\pi i/3} \left(\frac{4\zeta}{1-z^2} \right)^{1/4} \left\{ \frac{\text{Ai}(e^{2\pi i/3}\nu^{2/3}\zeta)}{\nu^{1/3}} \sum_{k=0}^{\infty} \frac{a_k(\zeta)}{\nu^{2k}} + \frac{e^{2\pi i/3}\text{Ai}'(e^{2\pi i/3}\nu^{2/3}\zeta)}{\nu^{5/3}} \sum_{k=0}^{\infty} \frac{b_k(\zeta)}{\nu^{2k}} \right\}$$

When $\nu \rightarrow +\infty$, these expansions hold uniformly with respect to z in the sector $|\arg z| \leq \pi - \epsilon$, where ϵ is an arbitrary positive number. The corresponding expansion for $H_\nu^{(2)}(\nu z)$ is obtained by changing the sign of i in 9.3.37.

Here

9.3.38

$$\frac{2}{3} \zeta^{3/2} = \int_z^1 \frac{\sqrt{1-t^2}}{t} dt = \ln \frac{1+\sqrt{1-z^2}}{z} - \sqrt{1-z^2}$$

equivalently,

9.3.39

$$\frac{2}{3} (-\zeta)^{3/2} = \int_1^z \frac{\sqrt{t^2-1}}{t} dt = \sqrt{z^2-1} - \arccos \left(\frac{1}{z} \right)$$

the branches being chosen so that ζ is real when z is positive. The coefficients are given by

9.3.40

$$a_k(\zeta) = \sum_{s=0}^{2k} \mu_s \zeta^{-3s/2} u_{2k-s} \{ (1-z^2)^{-\frac{1}{2}} \}$$

$$b_k(\zeta) = -\zeta^{-\frac{1}{2}} \sum_{s=0}^{2k+1} \lambda_s \zeta^{-3s/2} u_{2k-s+1} \{ (1-z^2)^{-\frac{1}{2}} \}$$

where u_k is given by 9.3.9 and 9.3.10, $\lambda_0 = \mu_0 = 1$ and

9.3.41

$$\lambda_s = \frac{(2s+1)(2s+3)\dots(6s-1)}{s!(144)^s}, \quad \mu_s = -\frac{6s+1}{6s-1} \lambda_s$$

Thus $a_0(\zeta) = 1$,

9.3.42

$$b_0(\zeta) = -\frac{5}{48\zeta^2} + \frac{1}{\zeta^{\frac{1}{2}}} \left\{ \frac{5}{24(1-z^2)^{3/2}} - \frac{1}{8(1-z^2)^{\frac{1}{2}}} \right\} \\ = -\frac{5}{48\zeta^2} + \frac{1}{(-\zeta)^{\frac{1}{2}}} \left\{ \frac{5}{24(z^2-1)^{3/2}} + \frac{1}{8(z^2-1)^{\frac{1}{2}}} \right\}$$

Tables of the early coefficients are given below. For more extensive tables of the coefficients and for bounds on the remainder terms in 9.3.35 and 9.3.36 see [9.38].

Uniform Expansions of the Derivatives

With the conditions of the preceding subsection

9.3.43

$$J'_\nu(\nu z) \sim -\frac{2}{z} \left(\frac{1-z^2}{4\zeta}\right)^{\frac{1}{2}} \left\{ \frac{\text{Ai}(\nu^{2/3}\zeta)}{\nu^{4/3}} \sum_{k=0}^{\infty} \frac{c_k(\zeta)}{\nu^{2k}} + \frac{\text{Ai}'(\nu^{2/3}\zeta)}{\nu^{2/3}} \sum_{k=0}^{\infty} \frac{d_k(\zeta)}{\nu^{2k}} \right\}$$

9.3.44

$$Y'_\nu(\nu z) \sim \frac{2}{z} \left(\frac{1-z^2}{4\zeta}\right)^{\frac{1}{2}} \left\{ \frac{\text{Bi}(\nu^{2/3}\zeta)}{\nu^{4/3}} \sum_{k=0}^{\infty} \frac{c_k(\zeta)}{\nu^{2k}} + \frac{\text{Bi}'(\nu^{2/3}\zeta)}{\nu^{2/3}} \sum_{k=0}^{\infty} \frac{d_k(\zeta)}{\nu^{2k}} \right\}$$

9.3.45

$$H_\nu^{(1)'}(\nu z) \sim \frac{4e^{2\pi i/3}}{z} \left(\frac{1-z^2}{4\zeta}\right)^{\frac{1}{2}} \left\{ \frac{\text{Ai}(e^{2\pi i/3}\nu^{2/3}\zeta)}{\nu^{4/3}} \sum_{k=0}^{\infty} \frac{c_k(\zeta)}{\nu^{2k}} + \frac{e^{2\pi i/3} \text{Ai}'(e^{2\pi i/3}\nu^{2/3}\zeta)}{\nu^{2/3}} \sum_{k=0}^{\infty} \frac{d_k(\zeta)}{\nu^{2k}} \right\}$$

where

9.3.46

$$c_k(\zeta) = -\zeta^{\frac{1}{2}} \sum_{s=0}^{2k+1} \mu_s \zeta^{-3s/2} \nu_{2k-s+1} \{ (1-z^2)^{-\frac{1}{2}} \}$$

$$d_k(\zeta) = \sum_{s=0}^{2k} \lambda_s \zeta^{-3s/2} \nu_{2k-s} \{ (1-z^2)^{-\frac{1}{2}} \}$$

and ν_k is given by 9.3.13 and 9.3.14. For bounds on the remainder terms in 9.3.43 and 9.3.44 see [9.38].

ζ	$b_0(\zeta)$	$a_1(\zeta)$	$c_0(\zeta)$	$d_1(\zeta)$
0	0.0180	-0.004	0.1587	0.007
1	.0278	-.004	.1785	.009
2	.0351	-.001	.1862	.007
3	.0366	+.002	.1927	.005
4	.0352	.003	.2031	.004
5	.0331	.004	.2155	.003
6	.0311	.004	.2284	.003
7	.0294	.004	.2413	.003
8	.0278	.004	.2539	.003
9	.0265	.004	.2662	.003
10	.0253	.004	.2781	.003

$-\zeta$	$b_0(\zeta)$	$a_1(\zeta)$	$c_0(\zeta)$	$d_1(\zeta)$
0	0.0180	-0.004	0.1587	0.007
1	.0109	-.003	.1323	.004
2	.0067	-.002	.1087	.002
3	.0044	-.001	.0903	.001
4	.0031	-.001	.0764	.001
5	.0022	-.000	.0658	.000
6	.0017	-.000	.0576	.000
7	.0013	-.000	.0511	.000
8	.0011	-.000	.0459	.000
9	.0009	-.000	.0415	.000
10	.0007	-.000	.0379	.000

For $\zeta > 10$ use

$$b_0(\zeta) \sim \frac{1}{12} \zeta^{-\frac{1}{2}} - .104\zeta^{-2}, \quad a_1(\zeta) = .003,$$

$$c_0(\zeta) \sim \frac{1}{12} \zeta^{\frac{1}{2}} + .146\zeta^{-1}, \quad d_1(\zeta) = .003.$$

For $\zeta < -10$ use

$$b_0(\zeta) \sim \frac{1}{12} \zeta^{-2}, \quad a_1(\zeta) = .000,$$

$$c_0(\zeta) \sim -\frac{5}{12} \zeta^{-1} - 1.33(-\zeta)^{-5/2}, \quad d_1(\zeta) = .000.$$

Maximum values of higher coefficients:

$$|b_1(\zeta)| = .003, \quad |a_2(\zeta)| = .0008, \quad |d_2(\zeta)| = .001$$

$$|c_1(\zeta)| = .008 (\zeta < 10), \quad c_1(\zeta) \sim -.003\zeta^{\frac{1}{2}} \text{ as } \zeta \rightarrow +\infty.$$

9.4. Polynomial Approximations ²

9.4.1

$$-3 \leq x \leq 3$$

$$J_0(x) = 1 - 2.24999 97(x/3)^2 + 1.26562 08(x/3)^4 - .31638 66(x/3)^6 + .04444 79(x/3)^8 - .00394 44(x/3)^{10} + .00021 00(x/3)^{12} + \epsilon$$

$$|\epsilon| < 5 \times 10^{-8}$$

9.4.2

$$0 < x \leq 3$$

$$Y_0(x) = (2/\pi) \ln(\frac{1}{2}x) J_0(x) + .36746 691 + .60559 366(x/3)^2 - .74350 384(x/3)^4 + .25300 117(x/3)^6 - .04261 214(x/3)^8 + .00427 916(x/3)^{10} - .00024 846(x/3)^{12} + \epsilon$$

$$|\epsilon| < 1.4 \times 10^{-8}$$

9.4.3

$$3 \leq x < \infty$$

$$J_0(x) = x^{-\frac{1}{2}} f_0 \cos \theta_0 \quad Y_0(x) = x^{-\frac{1}{2}} f_0 \sin \theta_0$$

$$f_0 = .79788 456 - .00000 077(3/x) - .00552 740(3/x)^2 - .00009 512(3/x)^3 + .00137 237(3/x)^4 - .00072 805(3/x)^5 + .00014 476(3/x)^6 + \epsilon$$

$$|\epsilon| < 1.6 \times 10^{-8}$$

² Equations 9.4.1 to 9.4.6 and 9.8.1 to 9.8.8 are taken from E. E. Allen, Analytical approximations, Math. Tables Aids Comp. 8, 240-241 (1954), and Polynomial approximations to some modified Bessel functions, Math. Tables Aids Comp. 10, 162-164 (1956) (with permission). They were checked at the National Physical Laboratory by systematic tabulation; new bounds for the errors, ϵ , given here were obtained as a result.

$$\begin{aligned} \theta_0 = & x - .78539\ 816 - .04166\ 397(3/x) \\ & - .00003\ 954(3/x)^2 + .00262\ 573(3/x)^3 \\ & - .00054\ 125(3/x)^4 - .00029\ 333(3/x)^5 \\ & + .00013\ 558(3/x)^6 + \epsilon \end{aligned}$$

$$|\epsilon| < 7 \times 10^{-8}$$

9.4.4 $-3 \leq x \leq 3$

$$\begin{aligned} x^{-1} J_1(x) = & \frac{1}{2} - .56249\ 985(3/x)^2 + .21093\ 573(3/x)^4 \\ & - .03954\ 289(3/x)^6 + .00443\ 319(3/x)^8 \\ & - .00031\ 761(3/x)^{10} + .00001\ 109(3/x)^{12} + \epsilon \end{aligned}$$

$$|\epsilon| < 1.3 \times 10^{-8}$$

9.4.5 $0 < x \leq 3$

$$\begin{aligned} x Y_1(x) = & (2/\pi)x \ln(\frac{1}{2}x) J_1(x) - .63661\ 98 \\ & + .22120\ 91(3/x)^2 + .216827\ 09(3/x)^4 \\ & - .131648\ 27(3/x)^6 + .31239\ 51(3/x)^8 \\ & - .04009\ 76(3/x)^{10} + .00278\ 73(3/x)^{12} + \epsilon \end{aligned}$$

$$|\epsilon| < 1.1 \times 10^{-7}$$

9.4.6 $3 \leq x < \infty$

$$J_1(x) = x^{-\frac{1}{2}} f_1 \cos \theta_1, \quad Y_1(x) = x^{-\frac{1}{2}} f_1 \sin \theta_1$$

$$\begin{aligned} f_1 = & .79788\ 456 + .00000\ 156(3/x) + .01659\ 667(3/x)^2 \\ & + .00017\ 105(3/x)^3 - .00249\ 511(3/x)^4 \\ & + .00113\ 653(3/x)^5 - .00020\ 033(3/x)^6 + \epsilon \end{aligned}$$

$$|\epsilon| < 4 \times 10^{-8}$$

$$\begin{aligned} \theta_1 = & x - 2.35619\ 449 + .12499\ 612(3/x) \\ & + .00005\ 650(3/x)^2 - .00637\ 879(3/x)^3 \\ & + .00074\ 348(3/x)^4 + .00079\ 824(3/x)^5 \\ & - .00029\ 166(3/x)^6 + \epsilon \end{aligned}$$

$$|\epsilon| < 9 \times 10^{-8}$$

For expansions of $J_0(x)$, $Y_0(x)$, $J_1(x)$, and $Y_1(x)$ in series of Chebyshev polynomials for the ranges $0 \leq x \leq 8$ and $0 \leq 8/x \leq 1$, see [9.37].

9.5. Zeros

Real Zeros

When ν is real, the functions $J_\nu(z)$, $J'_\nu(z)$, $Y_\nu(z)$ and $Y'_\nu(z)$ each have an infinite number of real zeros, all of which are simple with the possible exception of $z=0$. For non-negative ν the s th positive zeros of these functions are denoted by

$j_{\nu,s}$, $j'_{\nu,s}$, $y_{\nu,s}$ and $y'_{\nu,s}$ respectively, except that $z=0$ is counted as the first zero of $J'_0(z)$. Since $J'_0(z) = -J_1(z)$, it follows that

9.5.1 $j'_{0,1} = 0, \quad j'_{0,s} = j_{1,s-1} \quad (s=2, 3, \dots)$

The zeros interlace according to the inequalities

9.5.2

$$\begin{aligned} j_{\nu,1} < j_{\nu+1,1} < j'_{\nu,2} < j_{\nu+1,2} < j'_{\nu,3} < \dots \\ y_{\nu,1} < y_{\nu+1,1} < y'_{\nu,2} < y_{\nu+1,2} < y'_{\nu,3} < \dots \\ \nu \leq j'_{\nu,1} < y_{\nu,1} < y'_{\nu,1} < j_{\nu,1} < j'_{\nu,2} \\ < y_{\nu,2} < y'_{\nu,2} < j_{\nu,2} < j'_{\nu,3} < \dots \end{aligned}$$

The positive zeros of any two real distinct cylinder functions of the same order are interlaced, as are the positive zeros of any real cylinder function $\mathcal{C}_\nu(z)$, defined as in 9.1.27, and the contiguous function $\mathcal{C}_{\nu+1}(z)$.

If ρ_ν is a zero of the cylinder function

9.5.3 $\mathcal{C}_\nu(z) = J_\nu(z) \cos(\pi t) + Y_\nu(z) \sin(\pi t)$

where t is a parameter, then

9.5.4 $\mathcal{C}'_\nu(\rho_\nu) = \mathcal{C}_{\nu-1}(\rho_\nu) = -\mathcal{C}_{\nu+1}(\rho_\nu)$

If σ_ν is a zero of $\mathcal{C}'_\nu(z)$ then

9.5.5 $\mathcal{C}_\nu(\sigma_\nu) = \frac{\sigma_\nu}{\nu} \mathcal{C}_{\nu-1}(\sigma_\nu) = \frac{\sigma_\nu}{\nu} \mathcal{C}_{\nu+1}(\sigma_\nu)$

The parameter t may be regarded as a continuous variable and ρ_ν, σ_ν as functions $\rho_\nu(t), \sigma_\nu(t)$ of t . If these functions are fixed by

9.5.6 $\rho_\nu(0) = 0, \quad \sigma_\nu(0) = j'_{\nu,1}$

then

9.5.7

$$j_{\nu,s} = \rho_\nu(s), \quad y_{\nu,s} = \rho_\nu(s - \frac{1}{2}) \quad (s=1, 2, \dots)$$

9.5.8

$$j'_{\nu,s} = \sigma_\nu(s-1), \quad y'_{\nu,s} = \sigma_\nu(s - \frac{1}{2}) \quad (s=1, 2, \dots)$$

9.5.9 $\mathcal{C}'_\nu(\rho_\nu) = \left(\frac{\rho_\nu}{2} \frac{d\rho_\nu}{dt}\right)^{-\frac{1}{2}}, \quad \mathcal{C}_\nu(\sigma_\nu) = \left(\frac{\sigma_\nu^2 - \nu^2}{2\sigma_\nu} \frac{d\sigma_\nu}{dt}\right)^{-\frac{1}{2}}$

Infinite Products

9.5.10 $J_\nu(z) = \frac{(\frac{1}{2}z)^\nu}{\Gamma(\nu+1)} \prod_{s=1}^{\infty} \left(1 - \frac{z^2}{j_{\nu,s}^2}\right)$

9.5.11 $J'_\nu(z) = \frac{(\frac{1}{2}z)^{\nu-1}}{2\Gamma(\nu)} \prod_{s=1}^{\infty} \left(1 - \frac{z^2}{j'_{\nu,s}^2}\right) \quad (\nu > 0)$

McMahon's Expansions for Large Zeros

When ν is fixed, $s \gg \nu$ and $\mu = 4\nu^2$

9.5.12

$$j_{\nu, s}, y_{\nu, s} \sim \beta \frac{\mu-1}{8\beta} - \frac{4(\mu-1)(7\mu-31)}{3(8\beta)^3} - \frac{32(\mu-1)(83\mu^2-982\mu+3779)}{15(8\beta)^5} - \frac{64(\mu-1)(6949\mu^3-153855\mu^2+1585743\mu-6277237)}{105(8\beta)^7} \dots$$

where $\beta = (s + \frac{1}{2}\nu - \frac{1}{4})\pi$ for $j_{\nu, s}$, $\beta = (s + \frac{1}{2}\nu - \frac{3}{4})\pi$ for $y_{\nu, s}$. With $\beta = (t + \frac{1}{2}\nu - \frac{1}{4})\pi$, the right of 9.5.12 is the asymptotic expansion of $\rho_\nu(t)$ for large t .

9.5.13

$$j'_{\nu, s}, y'_{\nu, s} \sim \beta' \frac{\mu+3}{8\beta'} - \frac{4(7\mu^2+82\mu-9)}{3(8\beta')^3} - \frac{32(83\mu^3+2075\mu^2-3039\mu+3537)}{15(8\beta')^5} - \frac{64(6949\mu^4+296492\mu^3-1248002\mu^2+7414380\mu-5853627)}{105(8\beta')^7} \dots$$

where $\beta' = (s + \frac{1}{2}\nu - \frac{3}{4})\pi$ for $j'_{\nu, s}$, $\beta' = (s + \frac{1}{2}\nu - \frac{1}{4})\pi$ for $y'_{\nu, s}$, $\beta' = (t + \frac{1}{2}\nu + \frac{1}{4})\pi$ for $\sigma_\nu(t)$. For higher terms in 9.5.12 and 9.5.13 see [9.4] or [9.40].

Asymptotic Expansions of Zeros and Associated Values for Large Orders

9.5.14

$$j_{\nu, 1} \sim \nu + 1.85575 71\nu^{1/3} + 1.03315 0\nu^{-1/3} - .00397\nu^{-1} - .0908\nu^{-5/3} + .043\nu^{-7/3} + \dots$$

9.5.15

$$y_{\nu, 1} \sim \nu + .93157 68\nu^{1/3} + .26035 1\nu^{-1/3} + .01198\nu^{-1} - .0060\nu^{-5/3} - .001\nu^{-7/3} + \dots$$

9.5.16

$$j'_{\nu, 1} \sim \nu + .80861 65\nu^{1/3} + .07249 0\nu^{-1/3} - .05097\nu^{-1} + .0094\nu^{-5/3} + \dots$$

9.5.17

$$y'_{\nu, 1} \sim \nu + 1.82109 80\nu^{1/3} + .94000 7\nu^{-1/3} - .05808\nu^{-1} - .0540\nu^{-5/3} + \dots$$

9.5.18

$$J'_\nu(j_{\nu, 1}) \sim -1.11310 28\nu^{-2/3}/(1 + 1.48460 6\nu^{-2/3} + .43294\nu^{-4/3} - .1943\nu^{-2} + .019\nu^{-8/3} + \dots)$$

9.5.19

$$Y'_\nu(y_{\nu, 1}) \sim .95554 86\nu^{-2/3}/(1 + .74526 1\nu^{-2/3} + .10910\nu^{-4/3} - .0185\nu^{-2} - .003\nu^{-8/3} + \dots)$$

9.5.20

$$J_\nu(j'_{\nu, 1}) \sim .67488 51\nu^{-1/3}(1 - .16172 3\nu^{-2/3} + .02918\nu^{-4/3} - .0068\nu^{-2} + \dots)$$

9.5.21

$$Y_\nu(y'_{\nu, 1}) \sim .57319 40\nu^{-1/3}(1 - .36422 0\nu^{-2/3} + .09077\nu^{-4/3} + .0237\nu^{-2} + \dots)$$

Corresponding expansions for $s=2, 3$ are given in [9.40]. These expansions become progressively weaker as s increases; those which follow do not suffer from this defect.

Uniform Asymptotic Expansions of Zeros and Associated Values for Large Orders

9.5.22 $j_{\nu, s} \sim \nu z(\zeta) + \sum_{k=1}^{\infty} \frac{f_k(\zeta)}{\nu^{2k-1}}$ with $\zeta = \nu^{-2/3} a_s$

9.5.23

$$J_\nu(j_{\nu, s}) \sim -\frac{2}{\nu^{2/3}} \frac{\text{Ai}'(a_s)}{z(\zeta)h(\zeta)} \left\{ 1 + \sum_{k=1}^{\infty} \frac{F_k(\zeta)}{\nu^{2k}} \right\}$$

with $\zeta = \nu^{-2/3} a_s$

9.5.24 $j'_{\nu, s} \sim \nu z(\zeta) + \sum_{k=1}^{\infty} \frac{g_k(\zeta)}{\nu^{2k-1}}$ with $\zeta = \nu^{-2/3} a'_s$

9.5.25

$$J_\nu(j'_{\nu, s}) \sim \text{Ai}(a'_s) \frac{h(\zeta)}{\nu^{1/3}} \left\{ 1 + \sum_{k=1}^{\infty} \frac{G_k(\zeta)}{\nu^{2k}} \right\}$$
 with $\zeta = \nu^{-2/3} a'_s$

where a_s, a'_s are the s th negative zeros of $\text{Ai}(z)$, $\text{Ai}'(z)$ (see 10.4), $z = z(\zeta)$ is the inverse function defined implicitly by 9.3.39, and

9.5.26

$$h(\zeta) = \{4\zeta/(1-z^2)\}^{\frac{1}{2}}$$

$$f_1(\zeta) = \frac{1}{2}z(\zeta)\{h(\zeta)\}^2 b_0(\zeta)$$

$$g_1(\zeta) = \frac{1}{2}\zeta^{-1}z(\zeta)\{h(\zeta)\}^2 c_0(\zeta)$$

where $b_0(\zeta), c_0(\zeta)$ appear in 9.3.42 and 9.3.46. Tables of the leading coefficients follow. More extensive tables are given in [9.40].

The expansions of $y_{\nu, s}, Y'_\nu(y_{\nu, s}), y'_{\nu, s}$ and $Y_\nu(y'_{\nu, s})$ corresponding to 9.5.22 to 9.5.25 are obtained by changing the symbols $j, J, \text{Ai}, \text{Ai}', a_s$ and a'_s to $y, Y, -\text{Bi}, -\text{Bi}', b_s$ and b'_s respectively.

$-\zeta$	$z(\zeta)$	$h(\zeta)$	$f_1(\zeta)$	$F_1(\zeta)$	$(-\zeta)g_1(\zeta)$	$(-\zeta)^2g_2(\zeta)$	$(-\zeta)^2G_1(\zeta)$
0.0	1.000000	1.25992	0.0143	-0.007	-0.1260	-0.010	0.000
0.2	1.166284	1.22076	.0142	-.005	-.1335	-.010	.002
0.4	1.347557	1.18337	.0139	-.004	-.1399	-.009	.004
0.6	1.543615	1.14780	.0135	-.003	-.1453	-.009	.005
0.8	1.754187	1.11409	.0131	-.003	-.1498	-.008	.006
1.0	1.978963	1.08220	0.0126	-0.002	-0.1533	-0.008	0.006

$-\zeta$	$z(\zeta)$	$h(\zeta)$	$f_1(\zeta)$	$F_1(\zeta)$	$g_1(\zeta)$	$g_2(\zeta)$	$G_1(\zeta)$
1.0	1.978963	1.08220	0.0126	-0.002	-0.1533	-0.008	0.006
1.2	2.217607	1.05208	.0121	-.002	-.1301	-.004	.004
1.4	2.469770	1.02367	.0115	-.001	-.1130	-.002	.003
1.6	2.735103	0.99687	.0110	-.001	-.0998	-.001	.002
1.8	3.013256	.97159	.0105	-.001	-.0893	-.001	.002
2.0	3.303889	0.94775	0.0100	-0.001	-0.0807	-0.001	0.001
2.2	3.606673	.92524	.0095	-0.001	-.0734		.001
2.4	3.921292	.90397	.0091		-.0673		.001
2.6	4.247441	.88387	.0086		-.0619		.001
2.8	4.584833	.86484	.0082		-.0573		0.001
3.0	4.933192	0.84681	0.0078		-0.0533		
3.2	5.292257	.82972	.0075		-.0497		
3.4	5.661780	.81348	.0071		-.0464		
3.6	6.041525	.79806	.0068		-.0436		
3.8	6.431269	.78338	.0065		-.0410		
4.0	6.830800	0.76939	0.0062		-0.0386		
4.2	7.239917	.75605	.0060		-.0365		
4.4	7.658427	.74332	.0057		-.0345		
4.6	8.086150	.73115	.0055		-.0328		
4.8	8.522912	.71951	.0052		-.0311		
5.0	8.968548	0.70836	0.0050		-0.0296		
5.2	9.422900	.69768	.0048		-.0282		
5.4	9.885820	.68742	.0047		-.0270		
5.6	10.357162	.67758	.0045		-.0258		
5.8	10.836791	.66811	.0043		-.0246		
6.0	11.324575	0.65901	0.0042		-0.0236		
6.2	11.820388	.65024	.0040		-.0227		
6.4	12.324111	.64180	.0039		-.0218		
6.6	12.835627	.63366	.0037		-.0209		
6.8	13.354826	.62580	.0036		-.0201		
7.0	13.881601	0.61821	0.0035		-0.0194		

$(-\zeta)^{-\frac{1}{2}}$	$z(\zeta) - \frac{1}{2}(-\zeta)^{\frac{3}{2}}$	$(-\zeta)^{\frac{1}{2}}h(\zeta)$	$f_1(\zeta)$	$g_1(\zeta)$
0.40	1.528915	1.62026	0.0040	-0.0224
.35	1.541532	1.65351	.0029	-.0158
.30	1.551741	1.68067	.0020	-.0104
.25	1.559490	1.70146	.0012	-.0062
.20	1.564907	1.71607	.0006	-.0033
0.15	1.568285	1.72523	0.0003	-0.0014
.10	1.570048	1.73002	.0001	-.0004
.05	1.570703	1.73180	.0000	-.0001
.00	1.570796	1.73205	.0000	-.0000

Maximum Values of Higher Coefficients

$|f_2(\zeta)| = .001, |F_2(\zeta)| = .0004 \quad (0 \leq -\zeta < \infty)$
 $|g_3(\zeta)| = .001, |G_2(\zeta)| = .0007 \quad (1 \leq -\zeta < \infty)$
 $|(-\zeta)^5g_3(\zeta)| = .002, |(-\zeta)^4G_2(\zeta)| = .0007$
 $(0 \leq -\zeta \leq 1)$

Complex Zeros of $J_\nu(z)$

When $\nu \geq -1$ the zeros of $J_\nu(z)$ are all real. If $\nu < -1$ and ν is not an integer the number of complex zeros of $J_\nu(z)$ is twice the integer part of $(-\nu)$; if the integer part of $(-\nu)$ is odd two of these zeros lie on the imaginary axis.

If $\nu \geq 0$, all zeros of $J'_\nu(z)$ are real.

Complex Zeros of $Y_\nu(z)$

When ν is real the pattern of the complex zeros of $Y_\nu(z)$ and $Y'_\nu(z)$ depends on the non-integer part of ν . Attention is confined here to the case $\nu = n$, a positive integer or zero.

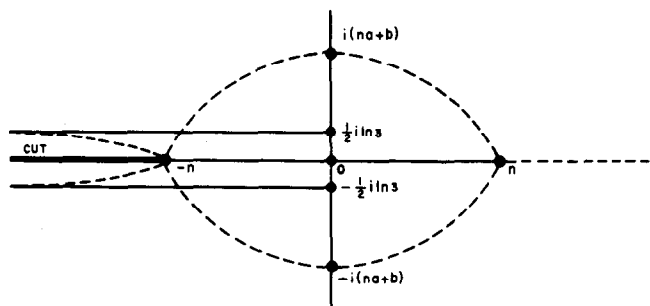

FIGURE 9.5. Zeros of $Y_n(z)$ and $Y'_n(z)$. . .

$$|\arg z| \leq \pi.$$

Figure 9.5 shows the approximate distribution of the complex zeros of $Y_n(z)$ in the region $|\arg z| \leq \pi$. The figure is symmetrical about the real axis. The two curves on the left extend to infinity, having the asymptotes

$$\mathcal{J}z = \pm \frac{1}{2} \ln 3 = \pm .54931 \dots$$

There are an infinite number of zeros near each of these curves.

The two curves extending from $z = -n$ to $z = n$ and bounding an eye-shaped domain intersect the imaginary axis at the points $\pm i(na + b)$, where

$$a = \sqrt{t_0^2 - 1} = .66274 \dots$$

$$b = \frac{1}{2} \sqrt{1 - t_0^{-2}} \ln 2 = .19146 \dots$$

and $t_0 = 1.19968 \dots$ is the positive root of $\coth t = t$. There are n zeros near each of these curves. Asymptotic expansions of these zeros for large n

are given by the right of 9.5.22 with $\nu = n$ and $\zeta = n^{-2/3}\beta_s$ or $n^{-2/3}\bar{\beta}_s$, where $\beta_s, \bar{\beta}_s$ are the complex zeros of $\text{Bi}(z)$ (see 10.4).

Figure 9.5 is also applicable to the zeros of $Y'_n(z)$. There are again an infinite number near the infinite curves, and n near each of the finite curves. Asymptotic expansions of the latter for large n are given by the right of 9.5.24 with $\nu = n$ and $\zeta = n^{-2/3}\beta'_s$ or $n^{-2/3}\bar{\beta}'_s$; where β'_s and $\bar{\beta}'_s$ are the complex zeros of $\text{Bi}'(z)$.

Numerical values of the three smallest complex zeros of $Y_0(z)$, $Y_1(z)$ and $Y'_1(z)$ in the region $0 < \arg z < \pi$ are given below.

For further details see [9.36] and [9.13]. The latter reference includes tables to facilitate computation.

Complex Zeros of the Hankel Functions

The approximate distribution of the zeros of $H_n^{(1)}(z)$ and its derivative in the region $|\arg z| \leq \pi$ is indicated in a similar manner on Figure 9.6.

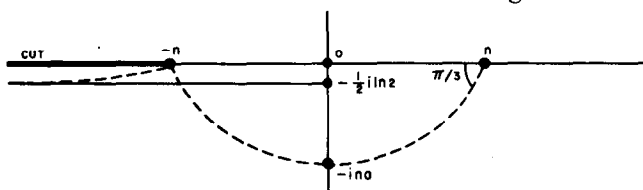

FIGURE 9.6. Zeros of $H_n^{(1)}(z)$ and $H_n^{(1)'}(z)$. . .

$$|\arg z| \leq \pi.$$

The asymptote of the solitary infinite curve is given by

$$\mathcal{J}z = -\frac{1}{2} \ln 2 = -.34657 \dots$$

Zeros of $Y_0(z)$ and Values of $Y_1(z)$ at the Zeros³

Zero		Y_1	
Real	Imag.	Real	Imag.
-2.40301	6632	+.53988	2313
+.10074	7689	-.88196	7710
-5.51987	6702	+.54718	0011
-.02924	6418	+.58716	9503
-8.65367	2403	+.54841	2067
+.01490	8063	-.46945	8752

Zeros of $Y_1(z)$ and Values of $Y_0(z)$ at the Zeros

Zero		Y_0	
Real	Imag.	Real	Imag.
-0.50274	3273	+.78624	3714
-.45952	7684	+1.31710	1937
-3.83353	5193	+.56235	6538
+.04830	1909	-0.69251	2884
-7.01590	3683	+.55339	3046
-.02012	6949	+0.51864	2833

Zeros of $Y'_1(z)$ and Values of $Y_1(z)$ at the Zeros

Zero		Y_1	
Real	Imag.	Real	Imag.
+0.57678	5129	+.90398	4792
-.76349	7088	+.58924	4865
-1.94047	7342	+.72118	5919
+.16206	4006	-.95202	7886
-5.33347	8617	+.56721	9637
-.03179	4008	+.59685	3673

³ From National Bureau of Standards, Tables of the Bessel functions $Y_0(z)$ and $Y_1(z)$ for complex arguments, Columbia Univ. Press, New York, N.Y., 1950 (with permission).

There are n zeros of each function near the finite curve extending from $z=-n$ to $z=n$; the asymptotic expansions of these zeros for large n are given by the right side of 9.5.22 or 9.5.24 with $\nu=n$ and $\zeta=e^{-2\pi i/3}n^{-2/3}a_s$, or $\zeta=e^{-2\pi i/3}n^{-2/3}a'_s$.

Zeros of Cross-Products

If ν is real and λ is positive, the zeros of the function

9.5.27 $J_\nu(z)Y_\nu(\lambda z) - J_\nu(\lambda z)Y_\nu(z)$

are real and simple. If $\lambda > 1$, the asymptotic expansion of the s th zero is

9.5.28 $\beta + \frac{p}{\beta} + \frac{q-p^2}{\beta^3} + \frac{r-4pq+2p^3}{\beta^5} + \dots$

where with $4\nu^2$ denoted by μ ,

9.5.29
$$\begin{aligned} \beta &= s\pi/(\lambda-1) \\ p &= \frac{\mu-1}{8\lambda}, \quad q = \frac{(\mu-1)(\mu-25)(\lambda^3-1)}{6(4\lambda)^3(\lambda-1)} \\ r &= \frac{(\mu-1)(\mu^2-114\mu+1073)(\lambda^5-1)}{5(4\lambda)^5(\lambda-1)} \end{aligned}$$

The asymptotic expansion of the large positive zeros (not necessarily the s th) of the function

9.5.30 $J'_\nu(z)Y'_\nu(\lambda z) - J'_\nu(\lambda z)Y'_\nu(z)$ ($\lambda > 1$)

is given by 9.5.28 with the same value of β , but instead of 9.5.29 we have

9.5.31
$$\begin{aligned} p &= \frac{\mu+3}{8\lambda}, \quad q = \frac{(\mu^2+46\mu-63)(\lambda^3-1)}{6(4\lambda)^3(\lambda-1)} \\ r &= \frac{(\mu^3+185\mu^2-2053\mu+1899)(\lambda^5-1)}{5(4\lambda)^5(\lambda-1)} \end{aligned}$$

The asymptotic expansion of the large positive zeros of the function

9.5.32 $J'_\nu(z)Y_\nu(\lambda z) - Y'_\nu(z)J_\nu(\lambda z)$

is given by 9.5.28 with

9.5.33
$$\begin{aligned} \beta &= (s-\frac{1}{2})\pi/(\lambda-1) \\ p &= \frac{(\mu+3)\lambda - (\mu-1)}{8\lambda(\lambda-1)} \\ q &= \frac{(\mu^2+46\mu-63)\lambda^3 - (\mu-1)(\mu-25)}{6(4\lambda)^3(\lambda-1)} \\ 5(4\lambda)^5(\lambda-1)r &= (\mu^3+185\mu^2-2053\mu+1899)\lambda^5 \\ &\quad - (\mu-1)(\mu^2-114\mu+1073) \end{aligned}$$

Modified Bessel Functions I and K

9.6. Definitions and Properties

Differential Equation

9.6.1 $z^2 \frac{d^2 w}{dz^2} + z \frac{dw}{dz} - (z^2 + \nu^2)w = 0$

Solutions are $I_{\pm\nu}(z)$ and $K_\nu(z)$. Each is a regular function of z throughout the z -plane cut along the negative real axis, and for fixed z ($\neq 0$) each is an entire function of ν . When $\nu = \pm n$, $I_\nu(z)$ is an entire function of z .

$I_\nu(z)$ ($\Re \nu \geq 0$) is bounded as $z \rightarrow 0$ in any bounded range of $\arg z$. $I_\nu(z)$ and $I_{-\nu}(z)$ are linearly independent except when ν is an integer. $K_\nu(z)$ tends to zero as $|z| \rightarrow \infty$ in the sector $|\arg z| < \frac{1}{2}\pi$, and for all values of ν , $I_\nu(z)$ and $K_\nu(z)$ are linearly independent. $I_\nu(z)$, $K_\nu(z)$ are real and positive when $\nu > -1$ and $z > 0$.

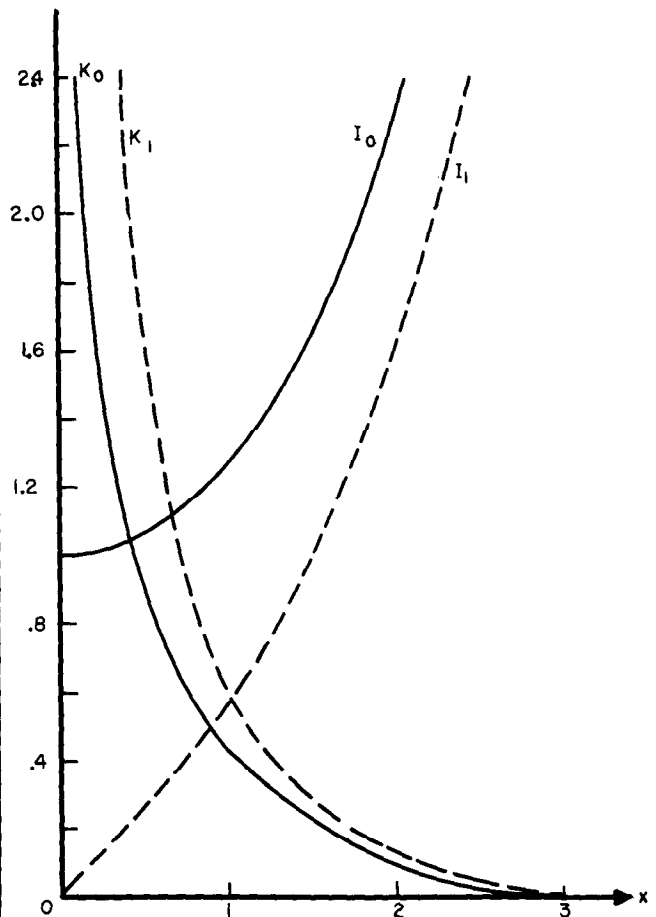

FIGURE 9.7. $I_0(x)$, $K_0(x)$, $I_1(x)$ and $K_1(x)$.

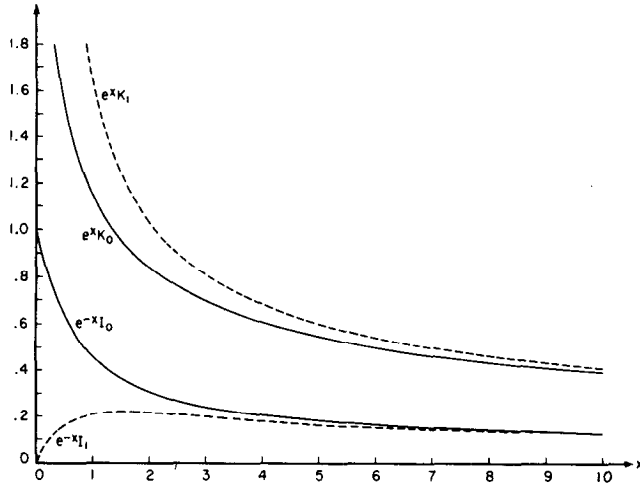

FIGURE 9.8. $e^{-x}I_0(x)$, $e^{-x}I_1(x)$, $e^xK_0(x)$ and $e^xK_1(x)$.

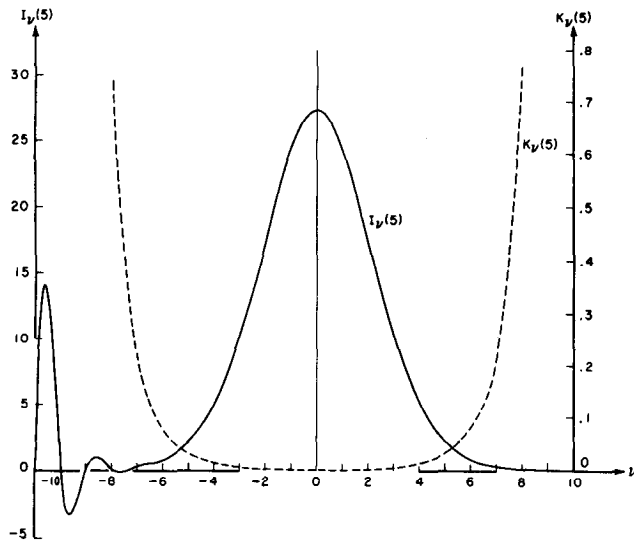

FIGURE 9.9. $I_\nu(5)$ and $K_\nu(5)$.

Relations Between Solutions

9.6.2
$$K_\nu(z) = \frac{1}{2}\pi \frac{I_{-\nu}(z) - I_\nu(z)}{\sin(\nu\pi)}$$

The right of this equation is replaced by its limiting value if ν is an integer or zero.

9.6.3

$$I_\nu(z) = e^{-\frac{1}{2}\nu\pi i} J_\nu(ze^{\frac{1}{2}\pi i}) \quad (-\pi < \arg z \leq \frac{1}{2}\pi)$$

$$I_\nu(z) = e^{\frac{3}{2}\nu\pi i/2} J_\nu(ze^{-\frac{3}{2}\pi i/2}) \quad (\frac{1}{2}\pi < \arg z \leq \pi)$$

9.6.4

$$K_\nu(z) = \frac{1}{2}\pi i e^{\frac{1}{2}\nu\pi i} H_\nu^{(1)}(ze^{\frac{1}{2}\pi i}) \quad (-\pi < \arg z \leq \frac{1}{2}\pi)$$

$$K_\nu(z) = -\frac{1}{2}\pi i e^{-\frac{1}{2}\nu\pi i} H_\nu^{(2)}(ze^{-\frac{1}{2}\pi i}) \quad (-\frac{1}{2}\pi < \arg z \leq \pi)$$

9.6.5

$$Y_\nu(ze^{\frac{1}{2}\pi i}) = e^{\frac{1}{2}(\nu+1)\pi i} I_\nu(z) - (2/\pi) e^{-\frac{1}{2}\nu\pi i} K_\nu(z)$$

$(-\pi < \arg z \leq \frac{1}{2}\pi)$

9.6.6

$$I_{-\nu}(z) = I_\nu(z), K_{-\nu}(z) = K_\nu(z)$$

Most of the properties of modified Bessel functions can be deduced immediately from those of ordinary Bessel functions by application of these relations.

Limiting Forms for Small Arguments

When ν is fixed and $z \rightarrow 0$

9.6.7

$$I_\nu(z) \sim (\frac{1}{2}z)^\nu / \Gamma(\nu+1) \quad (\nu \neq -1, -2, \dots)$$

9.6.8

$$K_0(z) \sim -\ln z$$

9.6.9

$$K_\nu(z) \sim \frac{1}{2}\Gamma(\nu) (\frac{1}{2}z)^{-\nu} \quad (\Re \nu > 0)$$

Ascending Series

9.6.10
$$I_\nu(z) = (\frac{1}{2}z)^\nu \sum_{k=0}^{\infty} \frac{(\frac{1}{4}z^2)^k}{k! \Gamma(\nu+k+1)}$$

9.6.11

$$K_\nu(z) = \frac{1}{2} (\frac{1}{2}z)^{-\nu} \sum_{k=0}^{n-1} \frac{(n-k-1)!}{k!} (-\frac{1}{4}z^2)^k$$

$$+ (-)^{n+1} \ln(\frac{1}{2}z) I_n(z)$$

$$+ (-)^n \frac{1}{2} (\frac{1}{2}z)^n \sum_{k=0}^{\infty} \{ \psi(k+1) + \psi(n+k+1) \} \frac{(\frac{1}{4}z^2)^k}{k!(n+k)!}$$

where $\psi(n)$ is given by 6.3.2.

9.6.12
$$I_0(z) = 1 + \frac{\frac{1}{4}z^2}{(1!)^2} + \frac{(\frac{1}{4}z^2)^2}{(2!)^2} + \frac{(\frac{1}{4}z^2)^3}{(3!)^2} + \dots$$

9.6.13

$$K_0(z) = -\{ \ln(\frac{1}{2}z) + \gamma \} I_0(z) + \frac{\frac{1}{4}z^2}{(1!)^2}$$

$$+ (1 + \frac{1}{2}) \frac{(\frac{1}{4}z^2)^2}{(2!)^2} + (1 + \frac{1}{2} + \frac{1}{3}) \frac{(\frac{1}{4}z^2)^3}{(3!)^2} + \dots$$

Wronskians

9.6.14

$$W\{I_\nu(z), I_{-\nu}(z)\} = I_\nu(z) I_{-\nu+1}(z) - I_{\nu+1}(z) I_{-\nu}(z)$$

$$= -2 \sin(\nu\pi) / (\pi z)$$

9.6.15

$$W\{K_\nu(z), I_\nu(z)\} = I_\nu(z) K_{\nu+1}(z) + I_{\nu+1}(z) K_\nu(z) = 1/z$$

Integral Representations

9.6.16

$$I_0(z) = \frac{1}{\pi} \int_0^\pi e^{\pm z \cos \theta} d\theta = \frac{1}{\pi} \int_0^\pi \cosh(z \cos \theta) d\theta$$

$$9.6.17 \quad K_0(z) = -\frac{1}{\pi} \int_0^\pi e^{\pm z \cos \theta} \{\gamma + \ln(2z \sin^2 \theta)\} d\theta$$

9.6.18

$$I_\nu(z) = \frac{(\frac{1}{2}z)^\nu}{\pi^{\frac{1}{2}} \Gamma(\nu + \frac{1}{2})} \int_0^\pi e^{\pm z \cos \theta} \sin^{2\nu} \theta d\theta$$

$$= \frac{(\frac{1}{2}z)^\nu}{\pi^{\frac{1}{2}} \Gamma(\nu + \frac{1}{2})} \int_{-1}^1 (1-t^2)^{\nu-\frac{1}{2}} e^{\pm zt} dt \quad (\Re \nu > -\frac{1}{2})$$

$$9.6.19 \quad I_n(z) = \frac{1}{\pi} \int_0^\pi e^{z \cos \theta} \cos(n\theta) d\theta$$

9.6.20

$$I_\nu(z) = \frac{1}{\pi} \int_0^\pi e^{z \cos \theta} \cos(\nu\theta) d\theta$$

$$= \frac{\sin(\nu\pi)}{\pi} \int_0^\infty e^{-z \cosh t - \nu t} dt \quad (|\arg z| < \frac{1}{2}\pi)$$

9.6.21

$$K_0(x) = \int_0^\infty \cos(x \sinh t) dt = \int_0^\infty \frac{\cos(xt)}{\sqrt{t^2+1}} dt$$

($x > 0$)

9.6.22

$$K_\nu(x) = \sec(\frac{1}{2}\nu\pi) \int_0^\infty \cos(x \sinh t) \cosh(\nu t) dt$$

$$= \csc(\frac{1}{2}\nu\pi) \int_0^\infty \sin(x \sinh t) \sinh(\nu t) dt$$

($|\Re \nu| < 1, x > 0$)

9.6.23

$$K_\nu(z) = \frac{\pi^{\frac{1}{2}} (\frac{1}{2}z)^\nu}{\Gamma(\nu + \frac{1}{2})} \int_0^\infty e^{-z \cosh t} \sinh^{2\nu} t dt$$

$$= \frac{\pi^{\frac{1}{2}} (\frac{1}{2}z)^\nu}{\Gamma(\nu + \frac{1}{2})} \int_1^\infty e^{-zt} (t^2-1)^{\nu-\frac{1}{2}} dt$$

($\Re \nu > -\frac{1}{2}, |\arg z| < \frac{1}{2}\pi$)

$$9.6.24 \quad K_\nu(z) = \int_0^\infty e^{-z \cosh t} \cosh(\nu t) dt \quad (|\arg z| < \frac{1}{2}\pi)$$

9.6.25

$$K_\nu(xz) = \frac{\Gamma(\nu + \frac{1}{2})(2z)^\nu}{\pi^{\frac{1}{2}} x^\nu} \int_0^\infty \frac{\cos(xt) dt}{(t^2+z^2)^{\nu+\frac{1}{2}}}$$

($\Re \nu > -\frac{1}{2}, x > 0, |\arg z| < \frac{1}{2}\pi$)*

Recurrence Relations

9.6.26

$$\mathcal{L}_{\nu-1}(z) - \mathcal{L}_{\nu+1}(z) = \frac{2\nu}{z} \mathcal{L}_\nu(z)$$

$$\mathcal{L}'_\nu(z) = \mathcal{L}_{\nu-1}(z) - \frac{\nu}{z} \mathcal{L}_\nu(z)$$

$$\mathcal{L}_{\nu-1}(z) + \mathcal{L}_{\nu+1}(z) = 2\mathcal{L}'_\nu(z)$$

$$\mathcal{L}'_\nu(z) = \mathcal{L}_{\nu+1}(z) + \frac{\nu}{z} \mathcal{L}_\nu(z)$$

\mathcal{L}_ν denotes $I_\nu, e^{\nu\pi i} K_\nu$, or any linear combination of these functions, the coefficients in which are independent of z and ν .

$$9.6.27 \quad I'_0(z) = I_1(z), \quad K'_0(z) = -K_1(z)$$

Formulas for Derivatives

9.6.28

$$\left(\frac{1}{z} \frac{d}{dz}\right)^k \{z^\nu \mathcal{L}_\nu(z)\} = z^{\nu-k} \mathcal{L}_{\nu-k}(z)$$

$$\left(\frac{1}{z} \frac{d}{dz}\right)^k \{z^{-\nu} \mathcal{L}_\nu(z)\} = z^{-\nu-k} \mathcal{L}_{\nu+k}(z) \quad (k=0,1,2,\dots)$$

9.6.29

$$\mathcal{L}_{\nu}^{(k)}(z) = \frac{1}{2^k} \{ \mathcal{L}_{\nu-k}(z) + \binom{k}{1} \mathcal{L}_{\nu-k+2}(z) + \binom{k}{2} \mathcal{L}_{\nu-k+4}(z) + \dots + \mathcal{L}_{\nu+k}(z) \}$$

($k=0,1,2,\dots$)

Analytic Continuation

$$9.6.30 \quad I_\nu(ze^{m\pi i}) = e^{m\nu\pi i} I_\nu(z) \quad (m \text{ an integer})$$

9.6.31

$$K_\nu(ze^{m\pi i}) = e^{-m\nu\pi i} K_\nu(z) - \pi i \sin(m\nu\pi) \csc(\nu\pi) I_\nu(z)$$

(m an integer)

$$9.6.32 \quad I_\nu(\bar{z}) = \overline{I_\nu(z)}, \quad K_\nu(\bar{z}) = \overline{K_\nu(z)} \quad (\nu \text{ real})$$

Generating Function and Associated Series

$$9.6.33 \quad e^{\frac{1}{2}z(t+1/t)} = \sum_{k=-\infty}^{\infty} t^k I_k(z) \quad (t \neq 0)$$

$$9.6.34 \quad e^{z \cos \theta} = I_0(z) + 2 \sum_{k=1}^{\infty} I_k(z) \cos(k\theta)$$

9.6.35

$$e^{z \sin \theta} = I_0(z) + 2 \sum_{k=0}^{\infty} (-)^k I_{2k+1}(z) \sin\{(2k+1)\theta\}$$

$$+ 2 \sum_{k=1}^{\infty} (-)^k I_{2k}(z) \cos(2k\theta)$$

$$9.6.36 \quad 1 = I_0(z) - 2I_2(z) + 2I_4(z) - 2I_6(z) + \dots$$

$$9.6.37 \quad e^z = I_0(z) + 2I_1(z) + 2I_2(z) + 2I_3(z) + \dots$$

$$9.6.38 \quad e^{-z} = I_0(z) - 2I_1(z) + 2I_2(z) - 2I_3(z) + \dots$$

9.6.39

$$\cosh z = I_0(z) + 2I_2(z) + 2I_4(z) + 2I_6(z) + \dots$$

$$9.6.40 \quad \sinh z = 2I_1(z) + 2I_3(z) + 2I_5(z) + \dots$$

*See page 11.

Other Differential Equations

The quantity λ^2 in equations 9.1.49 to 9.1.54 and 9.1.56 can be replaced by $-\lambda^2$ if at the same time the symbol \mathcal{L} in the given solutions is replaced by \mathcal{L}' .

9.6.41

$$z^2 w'' + z(1 \pm 2z)w' + (\pm z - \nu^2)w = 0, \quad w = e^{\mp z} \mathcal{L}'_\nu(z)$$

Differential equations for products may be obtained from 9.1.57 to 9.1.59 by replacing z by iz .

Derivatives With Respect to Order

9.6.42

$$\frac{\partial}{\partial \nu} I_\nu(z) = I_\nu(z) \ln\left(\frac{1}{2}z\right) - \left(\frac{1}{2}z\right)^\nu \sum_{k=0}^{\infty} \frac{\psi(\nu+k+1)}{\Gamma(\nu+k+1)} \frac{\left(\frac{1}{4}z^2\right)^k}{k!}$$

9.6.43

$$\begin{aligned} \frac{\partial}{\partial \nu} K_\nu(z) &= \frac{1}{2}\pi \csc(\nu\pi) \left\{ \frac{\partial}{\partial \nu} I_{-\nu}(z) - \frac{\partial}{\partial \nu} I_\nu(z) \right\} \\ &\quad - \pi \cot(\nu\pi) K_\nu(z) \quad (\nu \neq 0, \pm 1, \pm 2, \dots) \end{aligned}$$

9.6.44

$$\begin{aligned} (-)^n \left[\frac{\partial}{\partial \nu} I_\nu(z) \right]_{\nu=-n} &= \\ &= -K_n(z) + \frac{n! \left(\frac{1}{2}z\right)^{-n}}{2} \sum_{k=0}^{n-1} (-)^k \frac{\left(\frac{1}{2}z\right)^k I_k(z)}{(n-k)k!} \end{aligned}$$

9.6.45

$$\left[\frac{\partial}{\partial \nu} K_\nu(z) \right]_{\nu=-n} = \frac{n! \left(\frac{1}{2}z\right)^{-n}}{2} \sum_{k=0}^{n-1} \frac{\left(\frac{1}{2}z\right)^k K_k(z)}{(n-k)k!}$$

9.6.46

$$\left[\frac{\partial}{\partial \nu} I_\nu(z) \right]_{\nu=0} = -K_0(z), \quad \left[\frac{\partial}{\partial \nu} K_\nu(z) \right]_{\nu=0} = 0$$

Expressions in Terms of Hypergeometric Functions

9.6.47

$$\begin{aligned} I_\nu(z) &= \frac{\left(\frac{1}{2}z\right)^\nu}{\Gamma(\nu+1)} {}_0F_1\left(\nu+1; \frac{1}{4}z^2\right) \\ &= \frac{\left(\frac{1}{2}z\right)^\nu e^{-z}}{\Gamma(\nu+1)} M\left(\nu+\frac{1}{2}, 2\nu+1, 2z\right) = \frac{z^{-\frac{1}{2}} M_{0,\nu}(2z)}{2^{2\nu+1} \Gamma(\nu+1)} \end{aligned}$$

9.6.48

$$K_\nu(z) = \left(\frac{\pi}{2z}\right)^{\frac{1}{2}} W_{0,\nu}(2z)$$

(${}_0F_1$ is the generalized hypergeometric function. For $M(a, b, z)$, $M_{0,\nu}(z)$ and $W_{0,\nu}(z)$ see chapter 13.)

Connection With Legendre Functions

If μ and z are fixed, $\Re z > 0$, and $\nu \rightarrow \infty$ through real positive values

9.6.49 $\lim \{ \nu^\mu P_\nu^{-\mu} \left(\cosh \frac{z}{\nu} \right) \} = I_\mu(z)$

9.6.50 $\lim \{ \nu^{-\mu} e^{-\mu\pi i} Q_\nu^\mu \left(\cosh \frac{z}{\nu} \right) \} = K_\mu(z)$

For the definition of $P_\nu^{-\mu}$ and Q_ν^μ , see chapter 8.

Multiplication Theorems

9.6.51

$$\mathcal{L}'_\nu(\lambda z) = \lambda^{\pm \nu} \sum_{k=0}^{\infty} \frac{(\lambda^2 - 1)^k \left(\frac{1}{2}z\right)^k}{k!} \mathcal{L}'_{\nu \pm k}(z) \quad (|\lambda^2 - 1| < 1)$$

If $\mathcal{L}' = I$ and the upper signs are taken, the restriction on λ is unnecessary.

9.6.52

$$I_\nu(z) = \sum_{k=0}^{\infty} \frac{z^k}{k!} J_{\nu+k}(z), \quad J_\nu(z) = \sum_{k=0}^{\infty} (-)^k \frac{z^k}{k!} I_{\nu+k}(z)$$

Neumann Series for $K_n(z)$

9.6.53

$$\begin{aligned} K_n(z) &= (-)^{n-1} \{ \ln\left(\frac{1}{2}z\right) - \psi(n+1) \} I_n(z) \\ &\quad + \frac{n! \left(\frac{1}{2}z\right)^{-n}}{2} \sum_{k=0}^{n-1} (-)^k \frac{\left(\frac{1}{2}z\right)^k I_k(z)}{(n-k)k!} \\ &\quad + (-)^n \sum_{k=1}^{\infty} \frac{(n+2k) I_{n+2k}(z)}{k(n+k)} \end{aligned}$$

9.6.54 $K_0(z) = -\{ \ln\left(\frac{1}{2}z\right) + \gamma \} I_0(z) + 2 \sum_{k=1}^{\infty} \frac{I_{2k}(z)}{k}$

Zeros

Properties of the zeros of $I_\nu(z)$ and $K_\nu(z)$ may be deduced from those of $J_\nu(z)$ and $H_\nu^{(1)}(z)$ respectively, by application of the transformations 9.6.3 and 9.6.4.

For example, if ν is real the zeros of $I_\nu(z)$ are all complex unless $-2k < \nu < -(2k-1)$ for some positive integer k , in which event $I_\nu(z)$ has two real zeros.

The approximate distribution of the zeros of $K_n(z)$ in the region $-\frac{3}{2}\pi \leq \arg z \leq \frac{1}{2}\pi$ is obtained on rotating Figure 9.6 through an angle $-\frac{1}{2}\pi$ so that the cut lies along the positive imaginary axis. The zeros in the region $-\frac{1}{2}\pi \leq \arg z \leq \frac{3}{2}\pi$ are their conjugates. $K_n(z)$ has no zeros in the region $|\arg z| \leq \frac{1}{2}\pi$; this result remains true when n is replaced by any real number ν .

9.7. Asymptotic Expansions

Asymptotic Expansions for Large Arguments

When ν is fixed, $|z|$ is large and $\mu = 4\nu^2$

9.7.1

$$\begin{aligned} I_\nu(z) \sim \frac{e^z}{\sqrt{2\pi z}} \left\{ 1 - \frac{\mu-1}{8z} + \frac{(\mu-1)(\mu-9)}{2!(8z)^2} \right. \\ \left. - \frac{(\mu-1)(\mu-9)(\mu-25)}{3!(8z)^3} + \dots \right\} \quad (|\arg z| < \frac{1}{2}\pi) \end{aligned}$$

9.7.2

$$K_\nu(z) \sim \sqrt{\frac{\pi}{2z}} e^{-z} \left\{ 1 + \frac{\mu-1}{8z} + \frac{(\mu-1)(\mu-9)}{2!(8z)^2} + \frac{(\mu-1)(\mu-9)(\mu-25)}{3!(8z)^3} + \dots \right\} \quad (|\arg z| < \frac{3}{2}\pi)$$

9.7.3

$$I'_\nu(z) \sim \frac{e^z}{\sqrt{2\pi z}} \left\{ 1 - \frac{\mu+3}{8z} + \frac{(\mu-1)(\mu+15)}{2!(8z)^2} - \frac{(\mu-1)(\mu-9)(\mu+35)}{3!(8z)^3} + \dots \right\} \quad (|\arg z| < \frac{1}{2}\pi)$$

9.7.4

$$K'_\nu(z) \sim -\sqrt{\frac{\pi}{2z}} e^{-z} \left\{ 1 + \frac{\mu+3}{8z} + \frac{(\mu-1)(\mu+15)}{2!(8z)^2} + \frac{(\mu-1)(\mu-9)(\mu+35)}{3!(8z)^3} + \dots \right\} \quad (|\arg z| < \frac{3}{2}\pi)$$

The general terms in the last two expansions can be written down by inspection of 9.2.15 and 9.2.16.

If ν is real and non-negative and z is positive the remainder after k terms in the expansion 9.7.2 does not exceed the $(k+1)$ th term in absolute value and is of the same sign, provided that $k \geq \nu - \frac{1}{2}$.

9.7.5

$$I_\nu(z)K_\nu(z) \sim \frac{1}{2z} \left\{ 1 - \frac{1}{2} \frac{\mu-1}{(2z)^2} + \frac{1 \cdot 3}{2 \cdot 4} \frac{(\mu-1)(\mu-9)}{(2z)^4} - \dots \right\} \quad (|\arg z| < \frac{1}{2}\pi)$$

9.7.6

$$I'_\nu(z)K'_\nu(z) \sim -\frac{1}{2z} \left\{ 1 + \frac{1}{2} \frac{\mu-3}{(2z)^2} - \frac{1 \cdot 1}{2 \cdot 4} \frac{(\mu-1)(\mu-45)}{(2z)^4} + \dots \right\} \quad (|\arg z| < \frac{1}{2}\pi)$$

The general terms can be written down by inspection of 9.2.28 and 9.2.30.

Uniform Asymptotic Expansions for Large Orders

$$9.7.7 \quad I_\nu(\nu z) \sim \frac{1}{\sqrt{2\pi\nu}} \frac{e^{\nu\eta}}{(1+z^2)^{1/4}} \left\{ 1 + \sum_{k=1}^{\infty} \frac{u_k(t)}{\nu^k} \right\}$$

9.7.8

$$K_\nu(\nu z) \sim \sqrt{\frac{\pi}{2\nu}} \frac{e^{-\nu\eta}}{(1+z^2)^{1/4}} \left\{ 1 + \sum_{k=1}^{\infty} (-)^k \frac{u_k(t)}{\nu^k} \right\}$$

$$9.7.9 \quad I'_\nu(\nu z) \sim \frac{1}{\sqrt{2\pi\nu}} \frac{(1+z^2)^{1/4}}{z} e^{\nu\eta} \left\{ 1 + \sum_{k=1}^{\infty} \frac{v_k(t)}{\nu^k} \right\}$$

9.7.10

$$K'_\nu(\nu z) \sim -\sqrt{\frac{\pi}{2\nu}} \frac{(1+z^2)^{1/4}}{z} e^{-\nu\eta} \left\{ 1 + \sum_{k=1}^{\infty} (-)^k \frac{v_k(t)}{\nu^k} \right\}$$

When $\nu \rightarrow +\infty$, these expansions hold uniformly with respect to z in the sector $|\arg z| \leq \frac{1}{2}\pi - \epsilon$, where ϵ is an arbitrary positive number. Here

$$9.7.11 \quad t = 1/\sqrt{1+z^2}, \quad \eta = \sqrt{1+z^2} + \ln \frac{z}{1+\sqrt{1+z^2}}$$

and $u_k(t)$, $v_k(t)$ are given by 9.3.9, 9.3.10, 9.3.13 and 9.3.14. See [9.38] for tables of η , $u_k(t)$, $v_k(t)$, and also for bounds on the remainder terms in 9.7.7 to 9.7.10.

9.8. Polynomial Approximations⁴

In equations 9.8.1 to 9.8.4, $t = x/3.75$.

$$9.8.1 \quad -3.75 \leq x \leq 3.75$$

$$I_0(x) = 1 + 3.51562 29t^2 + 3.08994 24t^4 + 1.20674 92t^6 + .26597 32t^8 + .03607 68t^{10} + .00458 13t^{12} + \epsilon$$

$$|\epsilon| < 1.6 \times 10^{-7}$$

$$9.8.2 \quad 3.75 \leq x < \infty$$

$$x^3 e^{-x} I_0(x) = .39894 228 + .01328 592t^{-1} + .00225 319t^{-2} - .00157 565t^{-3} + .00916 281t^{-4} - .02057 706t^{-5} + .02635 537t^{-6} - .01647 633t^{-7} + .00392 377t^{-8} + \epsilon$$

$$|\epsilon| < 1.9 \times 10^{-7}$$

$$9.8.3 \quad -3.75 \leq x \leq 3.75$$

$$x^{-1} I_1(x) = \frac{1}{2} + .87890 594t^2 + .51498 869t^4 + .15084 934t^6 + .02658 733t^8 + .00301 532t^{10} + .00032 411t^{12} + \epsilon$$

$$|\epsilon| < 8 \times 10^{-9}$$

$$9.8.4 \quad 3.75 \leq x < \infty$$

$$x^3 e^{-x} I_1(x) = .39894 228 - .03988 024t^{-1} - .00362 018t^{-2} + .00163 801t^{-3} - .01031 555t^{-4} + .02282 967t^{-5} - .02895 312t^{-6} + .01787 654t^{-7} - .00420 059t^{-8} + \epsilon$$

$$|\epsilon| < 2.2 \times 10^{-7}$$

⁴ See footnote 2, section 9.4.

9.8.5 $0 < x \leq 2$

$$K_0(x) = -\ln(x/2)I_0(x) - .57721\ 566 \\ + .42278\ 420(x/2)^2 + .23069\ 756(x/2)^4 \\ + .03488\ 590(x/2)^6 + .00262\ 698(x/2)^8 \\ + .00010\ 750(x/2)^{10} + .00000\ 740(x/2)^{12} + \epsilon \\ |\epsilon| < 1 \times 10^{-8}$$

9.8.6 $2 \leq x < \infty$

$$x^{\frac{1}{2}}e^x K_0(x) = 1.25331\ 414 - .07832\ 358(2/x) \\ + .02189\ 568(2/x)^2 - .01062\ 446(2/x)^3 \\ + .00587\ 872(2/x)^4 - .00251\ 540(2/x)^5 \\ + .00053\ 208(2/x)^6 + \epsilon \\ |\epsilon| < 1.9 \times 10^{-7}$$

9.8.7 $0 < x \leq 2$

$$xK_1(x) = x \ln(x/2)I_1(x) + 1 + .15443\ 144(x/2)^2 \\ - .67278\ 579(x/2)^4 - .18156\ 897(x/2)^6 \\ - .01919\ 402(x/2)^8 - .00110\ 404(x/2)^{10} \\ - .00004\ 686(x/2)^{12} + \epsilon \\ |\epsilon| < 8 \times 10^{-9}$$

9.8.8 $2 \leq x < \infty$

$$x^{\frac{1}{2}}e^x K_1(x) = 1.25331\ 414 + .23498\ 619(2/x) \\ - .03655\ 620(2/x)^2 + .01504\ 268(2/x)^3 \\ - .00780\ 353(2/x)^4 + .00325\ 614(2/x)^5 \\ - .00068\ 245(2/x)^6 + \epsilon \\ |\epsilon| < 2.2 \times 10^{-7}$$

For expansions of $I_0(x)$, $K_0(x)$, $I_1(x)$, and $K_1(x)$ in series of Chebyshev polynomials for the ranges $0 \leq x \leq 8$ and $0 \leq 8/x \leq 1$, see [9.37].

Kelvin Functions

9.9. Definitions and Properties

In this and the following section ν is real, x is real and non-negative, and n is again a positive integer or zero.

Definitions

9.9.1

$$\text{ber}_\nu x + i \text{bei}_\nu x = J_\nu(xe^{3\pi i/4}) = e^{\nu\pi i} J_\nu(xe^{-\pi i/4}) \\ = e^{\frac{1}{2}\nu\pi i} I_\nu(xe^{\pi i/4}) = e^{\frac{3}{2}\nu\pi i/2} I_\nu(xe^{-3\pi i/4})$$

9.9.2

$$\text{ker}_\nu x + i \text{kei}_\nu x = e^{-\frac{1}{2}\nu\pi i} K_\nu(xe^{\pi i/4}) \\ = \frac{1}{2}\pi i H_\nu^{(1)}(xe^{3\pi i/4}) = -\frac{1}{2}\pi i e^{-\nu\pi i} H_\nu^{(2)}(xe^{-\pi i/4})$$

When $\nu=0$, suffices are usually suppressed.

Differential Equations

9.9.3

$$x^2 w'' + x w' - (ix^2 + \nu^2)w = 0, \\ w = \text{ber}_\nu x + i \text{bei}_\nu x, \quad \text{ber}_-\nu x + i \text{bei}_-\nu x, \\ \text{ker}_\nu x + i \text{kei}_\nu x, \quad \text{ker}_-\nu x + i \text{kei}_-\nu x$$

9.9.4

$$x^4 w^{(4)} + 2x^3 w''' - (1 + 2\nu^2)(x^2 w'' - x w') \\ + (\nu^4 - 4\nu^2 + x^4)w = 0, \\ w = \text{ber}_{\pm\nu} x, \text{bei}_{\pm\nu} x, \text{ker}_{\pm\nu} x, \text{kei}_{\pm\nu} x$$

Relations Between Solutions

9.9.5

$$\text{ber}_-\nu x = \cos(\nu\pi) \text{ber}_\nu x + \sin(\nu\pi) \text{bei}_\nu x \\ + (2/\pi) \sin(\nu\pi) \text{ker}_\nu x \\ \text{bei}_-\nu x = -\sin(\nu\pi) \text{ber}_\nu x + \cos(\nu\pi) \text{bei}_\nu x \\ + (2/\pi) \sin(\nu\pi) \text{kei}_\nu x$$

9.9.6

$$\text{ker}_-\nu x = \cos(\nu\pi) \text{ker}_\nu x - \sin(\nu\pi) \text{kei}_\nu x \\ \text{kei}_-\nu x = \sin(\nu\pi) \text{ker}_\nu x + \cos(\nu\pi) \text{kei}_\nu x$$

9.9.7 $\text{ber}_-n x = (-1)^n \text{ber}_n x, \text{bei}_-n x = (-1)^n \text{bei}_n x$

9.9.8 $\text{ker}_-n x = (-1)^n \text{ker}_n x, \text{kei}_-n x = (-1)^n \text{kei}_n x$

Ascending Series

9.9.9

$$\text{ber}_\nu x = \left(\frac{1}{2}x\right)^\nu \sum_{k=0}^{\infty} \frac{\cos\left\{\left(\frac{3}{4}\nu + \frac{1}{2}k\right)\pi\right\}}{k! \Gamma(\nu + k + 1)} \left(\frac{1}{4}x^2\right)^k \\ \text{bei}_\nu x = \left(\frac{1}{2}x\right)^\nu \sum_{k=0}^{\infty} \frac{\sin\left\{\left(\frac{3}{4}\nu + \frac{1}{2}k\right)\pi\right\}}{k! \Gamma(\nu + k + 1)} \left(\frac{1}{4}x^2\right)^k$$

9.9.10

$$\text{ber } x = 1 - \frac{(\frac{1}{4}x^2)^2}{(2!)^2} + \frac{(\frac{1}{4}x^2)^4}{(4!)^2} - \dots \\ \text{bei } x = \frac{1}{2}x^2 - \frac{(\frac{1}{4}x^2)^3}{(3!)^2} + \frac{(\frac{1}{4}x^2)^5}{(5!)^2} - \dots$$

9.9.11

$$\text{ker}_n x = \frac{1}{2} \left(\frac{1}{2}x\right)^{-n} \sum_{k=0}^{n-1} \cos\left\{\left(\frac{3}{4}n + \frac{1}{2}k\right)\pi\right\} \\ \times \frac{(n-k-1)!}{k!} \left(\frac{1}{4}x^2\right)^k - \ln\left(\frac{1}{2}x\right) \text{ber}_n x + \frac{1}{4}\pi \text{bei}_n x \\ + \frac{1}{2} \left(\frac{1}{2}x\right)^n \sum_{k=0}^{\infty} \cos\left\{\left(\frac{3}{4}n + \frac{1}{2}k\right)\pi\right\} \\ \times \frac{\{\psi(k+1) + \psi(n+k+1)\}}{k!(n+k)!} \left(\frac{1}{4}x^2\right)^k$$

$$\begin{aligned} \text{kei}_n x &= -\frac{1}{2}(\frac{1}{2}x)^{-n} \sum_{k=0}^{n-1} \sin \{(\frac{3}{2}n + \frac{1}{2}k)\pi\} \\ &\times \frac{(n-k-1)!}{k!} (\frac{1}{4}x^2)^k - \ln(\frac{1}{2}x) \text{bei}_n x - \frac{1}{4}\pi \text{ber}_n x \\ &+ \frac{1}{2}(\frac{1}{2}x)^n \sum_{k=0}^{\infty} \sin \{(\frac{3}{2}n + \frac{1}{2}k)\pi\} \\ &\times \frac{\{\psi(k+1) + \psi(n+k+1)\}}{k!(n+k)!} (\frac{1}{4}x^2)^k \end{aligned}$$

where $\psi(n)$ is given by 6.3.2.

9.9.12

$$\begin{aligned} \text{ker } x &= -\ln(\frac{1}{2}x) \text{ber } x + \frac{1}{4}\pi \text{bei } x \\ &+ \sum_{k=0}^{\infty} (-)^k \frac{\psi(2k+1)}{\{(2k)!\}^2} (\frac{1}{4}x^2)^{2k} \\ \text{kei } x &= -\ln(\frac{1}{2}x) \text{bei } x - \frac{1}{4}\pi \text{ber } x \\ &+ \sum_{k=0}^{\infty} (-)^k \frac{\psi(2k+2)}{\{(2k+1)!\}^2} (\frac{1}{4}x^2)^{2k+1} \end{aligned}$$

Functions of Negative Argument

In general Kelvin functions have a branch point at $x=0$ and individual functions with arguments $xe^{\pm\pi i}$ are complex. The branch point is absent however in the case of ber_ν and bei_ν , when ν is an integer, and

9.9.13

$$\text{ber}_n(-x) = (-)^n \text{ber}_n x, \quad \text{bei}_n(-x) = (-)^n \text{bei}_n x$$

Recurrence Relations

9.9.14

$$\begin{aligned} f_{\nu+1} + f_{\nu-1} &= -\frac{\nu\sqrt{2}}{x} (f_\nu - g_\nu) \\ f'_\nu &= \frac{1}{2\sqrt{2}} (f_{\nu+1} + g_{\nu+1} - f_{\nu-1} - g_{\nu-1}) \\ f'_\nu - \frac{\nu}{x} f_\nu &= \frac{1}{\sqrt{2}} (f_{\nu+1} + g_{\nu+1}) \\ f'_\nu + \frac{\nu}{x} f_\nu &= -\frac{1}{\sqrt{2}} (f_{\nu-1} + g_{\nu-1}) \end{aligned}$$

where

9.9.15

$$\left. \begin{aligned} f_\nu &= \text{ber}_\nu x \\ g_\nu &= \text{bei}_\nu x \end{aligned} \right\} \left. \begin{aligned} f_\nu &= \text{bei}_\nu x \\ g_\nu &= -\text{ber}_\nu x \end{aligned} \right\}$$

$$\left. \begin{aligned} f_\nu &= \text{ker}_\nu x \\ g_\nu &= \text{kei}_\nu x \end{aligned} \right\} \left. \begin{aligned} f_\nu &= \text{kei}_\nu x \\ g_\nu &= -\text{ker}_\nu x \end{aligned} \right\}$$

9.9.16

$$\sqrt{2} \text{ber}' x = \text{ber}_1 x + \text{bei}_1 x$$

9.9.17

$$\begin{aligned} \sqrt{2} \text{bei}' x &= -\text{ber}_1 x + \text{bei}_1 x \\ \sqrt{2} \text{ker}' x &= \text{ker}_1 x + \text{kei}_1 x \\ \sqrt{2} \text{kei}' x &= -\text{ker}_1 x + \text{kei}_1 x \end{aligned}$$

Recurrence Relations for Cross-Products

If

9.9.18

$$\begin{aligned} p_\nu &= \text{ber}_\nu^2 x + \text{bei}_\nu^2 x \\ q_\nu &= \text{ber}_\nu x \text{bei}'_\nu x - \text{ber}'_\nu x \text{bei}_\nu x \\ r_\nu &= \text{ber}_\nu x \text{ber}'_\nu x + \text{bei}_\nu x \text{bei}'_\nu x \\ s_\nu &= \text{ber}_\nu'^2 x + \text{bei}_\nu'^2 x \end{aligned}$$

then

9.9.19

$$\begin{aligned} p_{\nu+1} &= p_{\nu-1} - \frac{4\nu}{x} r_\nu \\ q_{\nu+1} &= -\frac{\nu}{x} p_\nu + r_\nu = -q_{\nu-1} + 2r_\nu \\ r_{\nu+1} &= -\frac{(\nu+1)}{x} p_{\nu+1} + q_\nu \\ s_\nu &= \frac{1}{2} p_{\nu+1} + \frac{1}{2} p_{\nu-1} - \frac{\nu^2}{x^2} p_\nu \end{aligned}$$

and

9.9.20

$$p_\nu s_\nu = r_\nu^2 + q_\nu^2$$

The same relations hold with ber_ν , bei_ν replaced throughout by ker_ν , kei_ν , respectively.

Indefinite Integrals

In the following f_ν , g_ν are any one of the pairs given by equations 9.9.15 and f_ν^* , g_ν^* are either the same pair or any other pair.

9.9.21

$$\int x^{1+\nu} f_\nu dx = -\frac{x^{1+\nu}}{\sqrt{2}} (f_{\nu+1} - g_{\nu+1}) = -x^{1+\nu} \left(\frac{\nu}{x} g_\nu - g'_\nu\right)$$

9.9.22

$$\int x^{1-\nu} f_\nu dx = \frac{x^{1-\nu}}{\sqrt{2}} (f_{\nu-1} - g_{\nu-1}) = x^{1-\nu} \left(\frac{\nu}{x} g_\nu + g'_\nu\right)$$

9.9.23

$$\begin{aligned} \int x(f_\nu g_\nu^* - g_\nu f_\nu^*) dx &= \frac{x}{2\sqrt{2}} \{f_\nu^* (f_{\nu+1} + g_{\nu+1}) \\ &- g_\nu^* (f_{\nu+1} - g_{\nu+1}) - f_\nu (f_{\nu+1}^* + g_{\nu+1}^*) + g_\nu (f_{\nu+1}^* - g_{\nu+1}^*)\} \\ &= \frac{1}{2} x (f'_\nu f_\nu^* - f_\nu f_\nu^{*'} + g'_\nu g_\nu^* - g_\nu g_\nu^{*'}) \end{aligned}$$

9.9.24

$$\int x(f, g_v^* + g_v f_v^*) dx = \frac{1}{4} x^2 (2f, g_v^* - f_{v-1} g_{v+1}^* - f_{v+1} g_{v-1}^* + 2g, f_v^* - g_{v-1} f_{v+1}^* - g_{v+1} f_{v-1}^*)$$

9.9.25

$$\int x(f_v^2 + g_v^2) dx = x(f, g'_v - f'_v g_v) = -(x/\sqrt{2})(f, f_{v+1} + g, g_{v+1} - f, g_{v+1} + f_{v+1} g_v)$$

9.9.26

$$\int x f, g dx = \frac{1}{4} x^2 (2f, g_v - f_{v-1} g_{v+1} - f_{v+1} g_{v-1})$$

9.9.27

$$\int x(f_v^2 - g_v^2) dx = \frac{1}{2} x^2 (f_v^2 - f_{v-1} f_{v+1} - g_v^2 + g_{v-1} g_{v+1})$$

Ascending Series for Cross-Products

9.9.28

$$\text{ber}_\nu^2 x + \text{bei}_\nu^2 x = \left(\frac{1}{2}x\right)^{2\nu} \sum_{k=0}^{\infty} \frac{1}{\Gamma(\nu+k+1)\Gamma(\nu+2k+1)} \frac{(\frac{1}{4}x^2)^{2k}}{k!}$$

9.9.29

$$\text{ber}_\nu x \text{bei}'_\nu x - \text{ber}'_\nu x \text{bei}_\nu x = \left(\frac{1}{2}x\right)^{2\nu+1} \sum_{k=0}^{\infty} \frac{1}{\Gamma(\nu+k+1)\Gamma(\nu+2k+2)} \frac{(\frac{1}{4}x^2)^{2k}}{k!}$$

9.9.30

$$\text{ber}_\nu x \text{ber}'_\nu x + \text{bei}_\nu x \text{bei}'_\nu x = \frac{1}{2} \left(\frac{1}{2}x\right)^{2\nu-1} \sum_{k=0}^{\infty} \frac{1}{\Gamma(\nu+k+1)\Gamma(\nu+2k)} \frac{(\frac{1}{4}x^2)^{2k}}{k!}$$

9.9.31

$$\text{ber}'_{\nu^2} x + \text{bei}'_{\nu^2} x = \left(\frac{1}{2}x\right)^{2\nu-2} \sum_{k=0}^{\infty} \frac{(2k^2 + 2\nu k + \frac{1}{2}\nu^2)}{\Gamma(\nu+k+1)\Gamma(\nu+2k+1)} \frac{(\frac{1}{4}x^2)^{2k}}{k!}$$

Expansions in Series of Bessel Functions

9.9.32

$$\text{ber}_\nu x + i \text{bei}_\nu x = \sum_{k=0}^{\infty} \frac{e^{(3\nu+k)\pi i/4} x^k J_{\nu+k}(x)}{2^{3k} k!} = \sum_{k=0}^{\infty} \frac{e^{(3\nu+3k)\pi i/4} x^k I_{\nu+k}(x)}{2^{3k} k!}$$

9.9.33

$$\text{ber}_\nu(x\sqrt{2}) = \sum_{k=-\infty}^{\infty} (-)^{n+k} J_{n+2k}(x) I_{2k}(x)$$

$$\text{bei}_\nu(x\sqrt{2}) = \sum_{k=-\infty}^{\infty} (-)^{n+k} J_{n+2k+1}(x) I_{2k+1}(x)$$

Zeros of Functions of Order Zero ⁵

	ber x	bei x	ker x	kei x
1st zero	2. 84892	5. 02622	1. 71854	3. 91467
2nd zero	7. 23883	9. 45541	6. 12728	8. 34422
3rd zero	11. 67396	13. 89349	10. 56294	12. 78256
4th zero	16. 11356	18. 33398	15. 00269	17. 22314
5th zero	20. 55463	22. 77544	19. 44381	21. 66464

	ber' x	bei' x	ker' x	kei' x
1st zero	6. 03871	3. 77320	2. 66584	4. 93181
2nd zero	10. 51364	8. 28099	7. 17212	9. 40405
3rd zero	14. 96844	12. 74215	11. 63218	13. 85827
4th zero	19. 41758	17. 19343	16. 08312	18. 30717
5th zero	23. 86430	21. 64114	20. 53068	22. 75379

9.10. Asymptotic Expansions

Asymptotic Expansions for Large Arguments

When ν is fixed and x is large

9.10.1

$$\text{ber}_\nu x = \frac{e^{x/\sqrt{2}}}{\sqrt{2\pi x}} \{f_\nu(x) \cos \alpha + g_\nu(x) \sin \alpha\} - \frac{1}{\pi} \{ \sin(2\nu\pi) \text{ker}_\nu x + \cos(2\nu\pi) \text{kei}_\nu x \}$$

9.10.2

$$\text{bei}_\nu x = \frac{e^{x/\sqrt{2}}}{\sqrt{2\pi x}} \{f_\nu(x) \sin \alpha - g_\nu(x) \cos \alpha\} + \frac{1}{\pi} \{ \cos(2\nu\pi) \text{ker}_\nu x - \sin(2\nu\pi) \text{kei}_\nu x \}$$

9.10.3

$$\text{ker}_\nu x = \sqrt{\pi/(2x)} e^{-x/\sqrt{2}} \{f_\nu(-x) \cos \beta - g_\nu(-x) \sin \beta\}$$

9.10.4

$$\text{kei}_\nu x = \sqrt{\pi/(2x)} e^{-x/\sqrt{2}} \{-f_\nu(-x) \sin \beta - g_\nu(-x) \cos \beta\}$$

where

9.10.5

$$\alpha = (x/\sqrt{2}) + (\frac{1}{2}\nu - \frac{1}{8})\pi, \quad \beta = (x/\sqrt{2}) + (\frac{1}{2}\nu + \frac{1}{8})\pi = \alpha + \frac{1}{4}\pi$$

and, with $4\nu^2$ denoted by μ ,

9.10.6

$$f_\nu(\pm x) \sim 1 + \sum_{k=1}^{\infty} (\mp)^k \frac{(\mu-1)(\mu-9)\dots\{\mu-(2k-1)^2\}}{k!(8x)^k} \cos\left(\frac{k\pi}{4}\right)$$

⁵ From British Association for the Advancement of Science, Annual Report (J. R. Airey), 254 (1927) with permission. This reference also gives 5-decimal values of the next five zeros of each function.

9.10.7

$g_r(\pm x)$

$$\sim \sum_{k=1}^{\infty} (\mp)^k \frac{(\mu-1)(\mu-3)\dots\{\mu-(2k-1)\}}{k!(8x)^k} \sin\left(\frac{k\pi}{4}\right)$$

The terms⁶ in \ker, x and kei, x in equations 9.10.1 and 9.10.2 are asymptotically negligible compared with the other terms, but their inclusion in numerical calculations yields improved accuracy.

The corresponding series for ber', x , bei', x , ker', x and kei', x can be derived from 9.2.11 and 9.2.13 with $z = xe^{3\pi i/4}$; the extra terms in the expansions of ber', x and bei', x are respectively

$$-(1/\pi)\{\sin(2\nu\pi)\text{ker}', x + \cos(2\nu\pi)\text{kei}', x\}$$

and

$$(1/\pi)\{\cos(2\nu\pi)\text{ker}', x - \sin(2\nu\pi)\text{kei}', x\}.$$

Modulus and Phase

9.10.8

$$M_r = \sqrt{(\text{ber}_r^2 x + \text{bei}_r^2 x)}, \quad \theta_r = \arctan(\text{bei}_r x / \text{ber}_r x)$$

9.10.9 $\text{ber}_r x = M_r \cos \theta_r, \quad \text{bei}_r x = M_r \sin \theta_r$

9.10.10 $M_{-n} = M_n, \quad \theta_{-n} = \theta_n - n\pi$

9.10.11

$$\begin{aligned} \text{ber}'_r x &= \frac{1}{2} M_{r+1} \cos(\theta_{r+1} - \frac{1}{4}\pi) - \frac{1}{2} M_{r-1} \cos(\theta_{r-1} - \frac{1}{4}\pi) \\ &= (\nu/x) M_r \cos \theta_r + M_{r+1} \cos(\theta_{r+1} - \frac{1}{4}\pi) \\ &= -(\nu/x) M_r \cos \theta_r - M_{r-1} \cos(\theta_{r-1} - \frac{1}{4}\pi) \end{aligned}$$

9.10.12

$$\begin{aligned} \text{bei}'_r x &= \frac{1}{2} M_{r+1} \sin(\theta_{r+1} - \frac{1}{4}\pi) - \frac{1}{2} M_{r-1} \sin(\theta_{r-1} - \frac{1}{4}\pi) \\ &= (\nu/x) M_r \sin \theta_r + M_{r+1} \sin(\theta_{r+1} - \frac{1}{4}\pi) \\ &= -(\nu/x) M_r \sin \theta_r - M_{r-1} \sin(\theta_{r-1} - \frac{1}{4}\pi) \end{aligned}$$

9.10.13

$$\text{ber}'_r x = M_1 \cos(\theta_1 - \frac{1}{4}\pi), \quad \text{bei}'_r x = M_1 \sin(\theta_1 - \frac{1}{4}\pi)$$

9.10.14

$$\begin{aligned} M'_r &= (\nu/x) M_r + M_{r+1} \cos(\theta_{r+1} - \theta_r - \frac{1}{4}\pi) \\ &= -(\nu/x) M_r - M_{r-1} \cos(\theta_{r-1} - \theta_r - \frac{1}{4}\pi) \end{aligned}$$

9.10.15

$$\begin{aligned} \theta'_r &= (M_{r+1}/M_r) \sin(\theta_{r+1} - \theta_r - \frac{1}{4}\pi) \\ &= -(M_{r-1}/M_r) \sin(\theta_{r-1} - \theta_r - \frac{1}{4}\pi) \end{aligned}$$

9.10.16

$$\begin{aligned} M'_0 &= M_1 \cos(\theta_1 - \theta_0 - \frac{1}{4}\pi) \\ \theta'_0 &= (M_1/M_0) \sin(\theta_1 - \theta_0 - \frac{1}{4}\pi) \end{aligned}$$

9.10.17

$$d(xM'_r \theta'_r)/dx = \alpha M_r^2, \quad x^2 M_r'' + x M_r' - \nu^2 M_r = x^2 M_r \theta_r'^2$$

9.10.18

$$N_r = \sqrt{(\text{ker}_r^2 x + \text{kei}_r^2 x)}, \quad \phi_r = \arctan(\text{kei}_r x / \text{ker}_r x)$$

9.10.19 $\text{ker}_r x = N_r \cos \phi_r, \quad \text{kei}_r x = N_r \sin \phi_r$

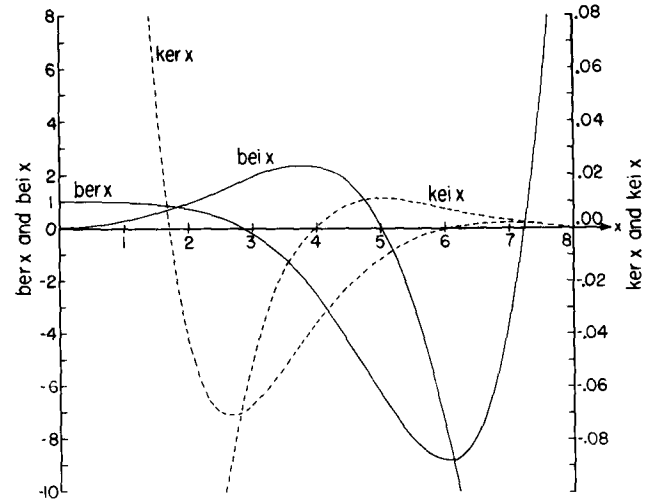

FIGURE 9.10. $\text{ber } x, \text{bei } x, \text{ker } x$ and $\text{kei } x$.

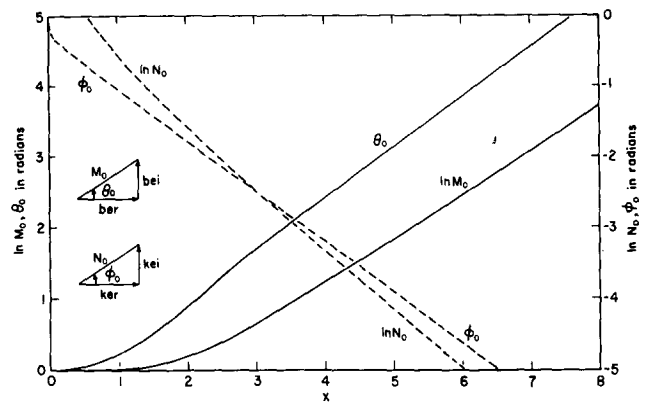

FIGURE 9.11. $\ln M_0(x), \theta_0(x), \ln N_0(x)$ and $\phi_0(x)$.

Equations 9.10.11 to 9.10.17 hold with the symbols b, M, θ replaced throughout by k, N, ϕ , respectively. In place of 9.10.10

9.10.20 $N_{-\nu} = N_\nu, \quad \phi_{-\nu} = \phi_\nu + \nu\pi$

⁶ The coefficients of these terms given in [9.17] are incorrect. The present results are due to Mr. G. F. Miller.

Asymptotic Expansions of Modulus and Phase

 When ν is fixed, x is large and $\mu = 4\nu^2$
9.10.21

$$M_\nu = \frac{e^{z/\nu^2}}{\sqrt{2\pi x}} \left\{ 1 - \frac{\mu-1}{8\sqrt{2}} \frac{1}{x} + \frac{(\mu-1)^2}{256} \frac{1}{x^2} - \frac{(\mu-1)(\mu^2+14\mu-399)}{6144\sqrt{2}} \frac{1}{x^3} + O\left(\frac{1}{x^4}\right) \right\}$$

9.10.22

$$\ln M_\nu = \frac{x}{\sqrt{2}} - \frac{1}{2} \ln(2\pi x) - \frac{\mu-1}{8\sqrt{2}} \frac{1}{x} - \frac{(\mu-1)(\mu-25)}{384\sqrt{2}} \frac{1}{x^3} - \frac{(\mu-1)(\mu-13)}{128} \frac{1}{x^4} + O\left(\frac{1}{x^5}\right)$$

9.10.23

$$\theta_\nu = \frac{x}{\sqrt{2}} + \left(\frac{1}{2}\nu - \frac{1}{8}\right)\pi + \frac{\mu-1}{8\sqrt{2}} \frac{1}{x} + \frac{\mu-1}{16} \frac{1}{x^2} - \frac{(\mu-1)(\mu-25)}{384\sqrt{2}} \frac{1}{x^3} + O\left(\frac{1}{x^4}\right)$$

9.10.24

$$N_\nu = \sqrt{\frac{\pi}{2x}} e^{-z/\nu^2} \left\{ 1 + \frac{\mu-1}{8\sqrt{2}} \frac{1}{x} + \frac{(\mu-1)^2}{256} \frac{1}{x^2} + \frac{(\mu-1)(\mu^2+14\mu-399)}{6144\sqrt{2}} \frac{1}{x^3} + O\left(\frac{1}{x^4}\right) \right\}$$

9.10.25

$$\ln N_\nu = -\frac{x}{\sqrt{2}} + \frac{1}{2} \ln\left(\frac{\pi}{2x}\right) + \frac{\mu-1}{8\sqrt{2}} \frac{1}{x} + \frac{(\mu-1)(\mu-25)}{384\sqrt{2}} \frac{1}{x^3} - \frac{(\mu-1)(\mu-13)}{128} \frac{1}{x^4} + O\left(\frac{1}{x^5}\right)$$

9.10.26

$$\phi_\nu = -\frac{x}{\sqrt{2}} - \left(\frac{1}{2}\nu + \frac{1}{8}\right)\pi - \frac{\mu-1}{8\sqrt{2}} \frac{1}{x} + \frac{\mu-1}{16} \frac{1}{x^2} + \frac{(\mu-1)(\mu-25)}{384\sqrt{2}} \frac{1}{x^3} + O\left(\frac{1}{x^4}\right)$$

Asymptotic Expansions of Cross-Products

 If x is large

9.10.27

$$\text{ber}^2 x + \text{bei}^2 x \sim \frac{e^{2x\nu^2}}{2\pi x} \left(1 + \frac{1}{4\sqrt{2}} \frac{1}{x} + \frac{1}{64} \frac{1}{x^2} - \frac{33}{256\sqrt{2}} \frac{1}{x^3} - \frac{1797}{8192} \frac{1}{x^4} + \dots \right)$$

9.10.28

$$\text{ber } x \text{ bei}' x - \text{ber}' x \text{ bei } x \sim \frac{e^{2x\nu^2}}{2\pi x} \left(\frac{1}{\sqrt{2}} + \frac{1}{8} \frac{1}{x} + \frac{9}{64\sqrt{2}} \frac{1}{x^2} + \frac{39}{512} \frac{1}{x^3} + \frac{75}{8192\sqrt{2}} \frac{1}{x^4} + \dots \right)$$

9.10.29

$$\text{ber } x \text{ ber}' x + \text{bei } x \text{ bei}' x \sim \frac{e^{2x\nu^2}}{2\pi x} \left(\frac{1}{\sqrt{2}} - \frac{3}{8} \frac{1}{x} - \frac{15}{64\sqrt{2}} \frac{1}{x^2} - \frac{45}{512} \frac{1}{x^3} + \frac{315}{8192\sqrt{2}} \frac{1}{x^4} + \dots \right)$$

9.10.30

$$\text{ber}'^2 x + \text{bei}'^2 x \sim \frac{e^{2x\nu^2}}{2\pi x} \left(1 - \frac{3}{4\sqrt{2}} \frac{1}{x} + \frac{9}{64} \frac{1}{x^2} + \frac{75}{256\sqrt{2}} \frac{1}{x^3} + \frac{2475}{8192} \frac{1}{x^4} + \dots \right)$$

9.10.31

$$\text{ker}^2 x + \text{kei}^2 x \sim \frac{\pi}{2x} e^{-2x\nu^2} \left(1 - \frac{1}{4\sqrt{2}} \frac{1}{x} + \frac{1}{64} \frac{1}{x^2} + \frac{33}{256\sqrt{2}} \frac{1}{x^3} - \frac{1797}{8192} \frac{1}{x^4} + \dots \right)$$

9.10.32

$$\text{ker } x \text{ kei}' x - \text{ker}' x \text{ kei } x \sim -\frac{\pi}{2x} e^{-2x\nu^2} \left(\frac{1}{\sqrt{2}} - \frac{1}{8} \frac{1}{x} + \frac{9}{64\sqrt{2}} \frac{1}{x^2} - \frac{39}{512} \frac{1}{x^3} + \frac{75}{8192\sqrt{2}} \frac{1}{x^4} + \dots \right)$$

9.10.33

$$\text{ker } x \text{ ker}' x + \text{kei } x \text{ kei}' x \sim -\frac{\pi}{2x} e^{-2x\nu^2} \left(\frac{1}{\sqrt{2}} + \frac{3}{8} \frac{1}{x} - \frac{15}{64\sqrt{2}} \frac{1}{x^2} + \frac{45}{512} \frac{1}{x^3} - \frac{315}{8192\sqrt{2}} \frac{1}{x^4} + \dots \right)$$

9.10.34

$$\text{ker}'^2 x + \text{kei}'^2 x \sim \frac{\pi}{2x} e^{-2x\nu^2} \left(1 + \frac{3}{4\sqrt{2}} \frac{1}{x} + \frac{9}{64} \frac{1}{x^2} - \frac{75}{256\sqrt{2}} \frac{1}{x^3} + \frac{2475}{8192} \frac{1}{x^4} + \dots \right)$$

Asymptotic Expansions of Large Zeros

Let

9.10.35

$$f(\delta) = \frac{\mu-1}{16\delta} + \frac{\mu-1}{32\delta^2} + \frac{(\mu-1)(5\mu+19)}{1536\delta^3} + \frac{3(\mu-1)^2}{512\delta^4} + \dots$$

 where $\mu = 4\nu^2$. Then if s is a large positive integer

9.10.36

$$\text{Zeros of ber } x \sim \sqrt{2} \{ \delta - f(\delta) \}, \quad \delta = (s - \frac{1}{2}\nu - \frac{3}{8})\pi$$

$$\text{Zeros of bei } x \sim \sqrt{2} \{ \delta - f(\delta) \}, \quad \delta = (s - \frac{1}{2}\nu + \frac{1}{8})\pi$$

$$\text{Zeros of ker } x \sim \sqrt{2} \{ \delta + f(-\delta) \}, \quad \delta = (s - \frac{1}{2}\nu - \frac{5}{8})\pi$$

$$\text{Zeros of kei } x \sim \sqrt{2} \{ \delta + f(-\delta) \}, \quad \delta = (s - \frac{1}{2}\nu - \frac{1}{8})\pi$$

For $\nu=0$ these expressions give the s th zero of each function; for other values of ν the zeros represented may not be the s th.

Uniform Asymptotic Expansions for Large Orders

When ν is large and positive

9.10.37

$\text{ber}, (\nu x) + i \text{bei}, (\nu x) \sim$

$$\frac{e^{\nu\xi}}{\sqrt{2\pi\nu\xi}} \left(\frac{x e^{3\pi i/4}}{1+\xi} \right)^\nu \left\{ 1 + \sum_{k=1}^{\infty} \frac{u_k(\xi^{-1})}{\nu^k} \right\}$$

9.10.38

$\text{ker}, (\nu x) + i \text{kei}, (\nu x)$

$$\sim \sqrt{\frac{\pi}{2\nu\xi}} e^{-\nu\xi} \left(\frac{x e^{3\pi i/4}}{1+\xi} \right)^{-\nu} \left\{ 1 + \sum_{k=1}^{\infty} (-)^k \frac{u_k(\xi^{-1})}{\nu^k} \right\}$$

9.10.39

$\text{ber}', (\nu x) + i \text{bei}', (\nu x)$

$$\sim \sqrt{\frac{\xi}{2\pi\nu}} \frac{e^{\nu\xi}}{x} \left(\frac{x e^{3\pi i/4}}{1+\xi} \right)^\nu \left\{ 1 + \sum_{k=1}^{\infty} \frac{v_k(\xi^{-1})}{\nu^k} \right\}$$

9.10.40

$\text{ker}', (\nu x) + i \text{kei}', (\nu x)$

$$\sim -\sqrt{\frac{\pi\xi}{2\nu}} \frac{e^{-\nu\xi}}{x} \left(\frac{x e^{3\pi i/4}}{1+\xi} \right)^{-\nu} \left\{ 1 + \sum_{k=1}^{\infty} (-)^k \frac{v_k(\xi^{-1})}{\nu^k} \right\}$$

where

$$9.10.41 \quad \xi = \sqrt{1+ix^2}$$

and $u_k(t), v_k(t)$ are given by 9.3.9 and 9.3.13. All fractional powers take their principal values.

9.11. Polynomial Approximations

9.11.1 $-8 \leq x \leq 8$

$$\begin{aligned} \text{ber } x = & 1 - 64(x/8)^4 + 113.77777 \ 774(x/8)^8 \\ & - 32.36345 \ 652(x/8)^{12} + 2.64191 \ 397(x/8)^{16} \\ & - .08349 \ 609(x/8)^{20} + .00122 \ 552(x/8)^{24} \\ & - .00000 \ 901(x/8)^{28} + \epsilon \\ & |\epsilon| < 1 \times 10^{-9} \end{aligned}$$

9.11.2 $-8 \leq x \leq 8$

$$\begin{aligned} \text{bei } x = & 16(x/8)^2 - 113.77777 \ 774(x/8)^6 \\ & + 72.81777 \ 742(x/8)^{10} - 10.56765 \ 779(x/8)^{14} \\ & + .52185 \ 615(x/8)^{18} - .01103 \ 667(x/8)^{22} \\ & + .00011 \ 346(x/8)^{26} + \epsilon \\ & |\epsilon| < 6 \times 10^{-9} \end{aligned}$$

9.11.3 $0 < x \leq 8$

$$\begin{aligned} \text{ker } x = & -\ln(\tfrac{1}{2}x) \text{ber } x + \tfrac{1}{2}\pi \text{bei } x - .57721 \ 566 \\ & - 59.05819 \ 744(x/8)^4 + 171.36272 \ 133(x/8)^8 \\ & - 60.60977 \ 451(x/8)^{12} + 5.65539 \ 121(x/8)^{16} \\ & - .19636 \ 347(x/8)^{20} + .00309 \ 699(x/8)^{24} \\ & - .00002 \ 458(x/8)^{28} + \epsilon \\ & |\epsilon| < 1 \times 10^{-8} \end{aligned}$$

9.11.4 $0 < x \leq 8$

$$\begin{aligned} \text{kei } x = & -\ln(\tfrac{1}{2}x) \text{bei } x - \tfrac{1}{2}\pi \text{ber } x + 6.76454 \ 936(x/8)^2 \\ & - 142.91827 \ 687(x/8)^6 + 124.23569 \ 650(x/8)^{10} \\ & - 21.30060 \ 904(x/8)^{14} + 1.17509 \ 064(x/8)^{18} \\ & - .02695 \ 875(x/8)^{22} + .00029 \ 532(x/8)^{26} + \epsilon \\ & |\epsilon| < 3 \times 10^{-9} \end{aligned}$$

9.11.5 $-8 \leq x \leq 8$

$$\begin{aligned} \text{ber}' x = & x[-4(x/8)^2 + 14.22222 \ 222(x/8)^6 \\ & - 6.06814 \ 810(x/8)^{10} + .66047 \ 849(x/8)^{14} \\ & - .02609 \ 253(x/8)^{18} + .00045 \ 957(x/8)^{22} \\ & - .00000 \ 394(x/8)^{26}] + \epsilon \\ & |\epsilon| < 2.1 \times 10^{-8} \end{aligned}$$

9.11.6 $-8 \leq x \leq 8$

$$\begin{aligned} \text{bei}' x = & x[\tfrac{1}{2} - 10.66666 \ 666(x/8)^4 \\ & + 11.37777 \ 772(x/8)^8 - 2.31167 \ 514(x/8)^{12} \\ & + .14677 \ 204(x/8)^{16} - .00379 \ 386(x/8)^{20} \\ & + .00004 \ 609(x/8)^{24}] + \epsilon \\ & |\epsilon| < 7 \times 10^{-8} \end{aligned}$$

9.11.7 $0 < x \leq 8$

$$\begin{aligned} \text{ker}' x = & -\ln(\tfrac{1}{2}x) \text{ber}' x - x^{-1} \text{ber } x + \tfrac{1}{2}\pi \text{bei}' x \\ & + x[-3.69113 \ 734(x/8)^2 + 21.42034 \ 017(x/8)^6 \\ & - 11.36433 \ 272(x/8)^{10} + 1.41384 \ 780(x/8)^{14} \\ & - .06136 \ 358(x/8)^{18} + .00116 \ 137(x/8)^{22} \\ & - .00001 \ 075(x/8)^{26}] + \epsilon \\ & |\epsilon| < 8 \times 10^{-8} \end{aligned}$$

9.11.8 $0 < x \leq 8$
 $\text{kei}' x = -\ln(\frac{1}{2}x) \text{bei}' x - x^{-1} \text{bei} x - \frac{1}{4}\pi \text{ber}' x$
 $+ x[.21139\ 217 - 13.39858\ 846(x/8)^4$
 $+ 19.41182\ 758(x/8)^8 - 4.65950\ 823(x/8)^{12}$
 $+ .33049\ 424(x/8)^{16} - .00926\ 707(x/8)^{20}$
 $+ .00011\ 997(x/8)^{24}] + \epsilon$
 $|\epsilon| < 7 \times 10^{-8}$

9.11.9 $8 \leq x < \infty$
 $\text{ker} x + i \text{kei} x = f(x)(1 + \epsilon_1)$
 $f(x) = \sqrt{\frac{\pi}{2x}} \exp\left[-\frac{1+i}{\sqrt{2}} x + \theta(-x)\right]$
 $|\epsilon_1| < 1 \times 10^{-7}$

9.11.10 $8 \leq x < \infty$
 $\text{ber} x + i \text{bei} x - \frac{i}{\pi} (\text{ker} x + i \text{kei} x) = g(x)(1 + \epsilon_2)$
 $g(x) = \frac{1}{\sqrt{2\pi x}} \exp\left[\frac{1+i}{\sqrt{2}} x + \theta(x)\right]$
 $|\epsilon_2| < 3 \times 10^{-7}$

where

9.11.11
 $\theta(x) = (.00000\ 00 - .39269\ 91i)$
 $+ (.01104\ 86 - .01104\ 85i)(8/x)$
 $+ (.00000\ 00 - .00097\ 65i)(8/x)^2$
 $+ (-.00009\ 06 - .00009\ 01i)(8/x)^3$
 $+ (-.00002\ 52 + .00000\ 00i)(8/x)^4$
 $+ (-.00000\ 34 + .00000\ 51i)(8/x)^5$
 $+ (.00000\ 06 + .00000\ 19i)(8/x)^6$

9.11.12 $8 \leq x < \infty$
 $\text{ker}' x + i \text{kei}' x = -f(x)\phi(-x)(1 + \epsilon_3)$
 $|\epsilon_3| < 2 \times 10^{-7}$

9.11.13 $8 \leq x < \infty$
 $\text{ber}' x + i \text{bei}' x - \frac{i}{\pi} (\text{ker}' x + i \text{kei}' x) = g(x)\phi(x)(1 + \epsilon_4)$
 $|\epsilon_4| < 3 \times 10^{-7}$

where

9.11.14
 $\phi(x) = (.70710\ 68 + .70710\ 68i)$
 $+ (-.06250\ 01 - .00000\ 01i)(8/x)$
 $+ (-.00138\ 13 + .00138\ 11i)(8/x)^2$
 $+ (.00000\ 05 + .00024\ 52i)(8/x)^3$
 $+ (.00003\ 46 + .00003\ 38i)(8/x)^4$
 $+ (.00001\ 17 - .00000\ 24i)(8/x)^5$
 $+ (.00000\ 16 - .00000\ 32i)(8/x)^6$

Numerical Methods

9.12. Use and Extension of the Tables

Example 1. To evaluate $J_n(1.55)$, $n=0, 1, 2, \dots$, each to 5 decimals.
 The recurrence relation

$$J_{n-1}(x) + J_{n+1}(x) = (2n/x)J_n(x)$$

can be used to compute $J_0(x), J_1(x), J_2(x), \dots$, successively provided that $n < x$, otherwise severe accumulation of rounding errors will occur. Since, however, $J_n(x)$ is a decreasing function of n when $n > x$, recurrence can always be carried out in the direction of decreasing n .

Inspection of **Table 9.2** shows that $J_n(1.55)$ vanishes to 5 decimals when $n > 7$. Taking arbitrary values zero for J_0 and unity for J_8 , we compute by recurrence the entries in the second column of the following table, rounding off to the nearest integer at each step.

n	<i>Trial values</i>	$J_n(1.55)$
9	0	.00000
8	1	.00000
7	10	.00003
6	89	.00028
5	679	.00211
4	4292	.01331
3	21473	.06661
2	78829	.24453
1	181957	.56442
0	155954	.48376

We normalize the results by use of the equation **9.1.46**, namely

$$J_0(x) + 2J_2(x) + 2J_4(x) + \dots = 1$$

This yields the normalization factor

$$1/322376 = .00000\ 31019\ 7$$

and multiplying the trial values by this factor we obtain the required results, given in the third column. As a check we may verify the value of $J_0(1.55)$ by interpolation in **Table 9.1**.

Remarks. (i) In this example it was possible to estimate immediately the value of $n=N$, say, at which to begin the recurrence. This may not always be the case and an arbitrary value of N may have to be taken. The number of correct significant figures in the final values is the same as the number of digits in the respective trial values. If the chosen N is too small the trial values will have too few digits and insufficient accuracy is obtained in the results. The calculation must then be repeated taking a higher value. On the other hand if N were too large unnecessary effort would be expended. This could be offset to some extent by discarding significant figures in the trial values which are in excess of the number of decimals required in J_n .

(ii) If we had required, say, $J_0(1.55)$, $J_1(1.55)$, . . . , $J_{10}(1.55)$, each to 5 significant figures, we would have found the values of $J_{10}(1.55)$ and $J_{11}(1.55)$ to 5 significant figures by interpolation in **Table 9.3** and then computed by recurrence J_9, J_8, \dots, J_0 , no normalization being required.

Alternatively, we could begin the recurrence at a higher value of N and retain only 5 significant figures in the trial values for $n \leq 10$.

(iii) Exactly similar methods can be used to compute the modified Bessel function $I_n(x)$ by means of the relations **9.6.26** and **9.6.36**. If x is large, however, considerable cancellation will take place in using the latter equation, and it is preferable to normalize by means of **9.6.37**.

Example 2. To evaluate $Y_n(1.55)$, $n=0, 1, 2, \dots, 10$, each to 5 significant figures.

The recurrence relation

$$Y_{n-1}(x) + Y_{n+1}(x) = (2n/x)Y_n(x)$$

can be used to compute $Y_n(x)$ in the direction of increasing n both for $n < x$ and $n > x$, because in the latter event $Y_n(x)$ is a numerically increasing function of n .

We therefore compute $Y_0(1.55)$ and $Y_1(1.55)$ by interpolation in **Table 9.1**, generate $Y_2(1.55)$, $Y_3(1.55)$, . . . , $Y_{10}(1.55)$ by recurrence and check $Y_{10}(1.55)$ by interpolation in **Table 9.3**.

n	$Y_n(1.55)$	n	$Y_n(1.55)$
0	+0.40225	6	-1.9917 × 10 ²
1	-0.37970	7	-1.5100 × 10 ³
2	-0.89218	8	-1.3440 × 10 ⁴
3	-1.9227	9	-1.3722 × 10 ⁵
4	-6.5505	10	-1.5801 × 10 ⁶
5	-31.886		

Remarks. (i) An alternative way of computing $Y_0(x)$, should $J_0(x)$, $J_2(x)$, $J_4(x)$, . . . , be available (see **Example 1**), is to use formula **9.1.89**. The other starting value for the recurrence, $Y_1(x)$, can then be found from the Wronskian relation $J_1(x)Y_0(x) - J_0(x)Y_1(x) = 2/(\pi x)$. This is a convenient procedure for use with an automatic computer.

(ii) Similar methods can be used to compute the modified Bessel function $K_n(x)$ by means of the recurrence relation **9.6.26** and the relation **9.6.54**, except that if x is large severe cancellation will occur in the use of **9.6.54** and other methods for evaluating $K_0(x)$ may be preferable, for example, use of the asymptotic expansion **9.7.2** or the polynomial approximation **9.8.6**.

Example 3. To evaluate $J_0(.36)$ and $Y_0(.36)$ each to 5 decimals, using the multiplication theorem.

From **9.1.74** we have

$$\mathcal{C}_0(\lambda z) = \sum_{k=0}^{\infty} a_k \mathcal{C}_k(z), \text{ where } a_k = \frac{(-)^k (\lambda^2 - 1)^k (\frac{1}{2}z)^k}{k!}.$$

We take $z=.4$. Then $\lambda=.9$, $(\lambda^2 - 1)(\frac{1}{2}z) = -.038$, and extracting the necessary values of $J_k(.4)$ and $Y_k(.4)$ from **Tables 9.1** and **9.2**, we compute the required results as follows:

k	a_k	$a_k J_k(.4)$	$a_k Y_k(.4)$
0	+1.0	+ .96040	- .60602
1	+0.038	+ .00745	- .06767
2	+0.7220 × 10 ⁻³	+ .00001	- .00599
3	+0.914 × 10 ⁻⁵		- .00074
4	+0.87 × 10 ⁻⁷		- .00011
5	+0.7 × 10 ⁻⁹		- .00002
		<hr/>	<hr/>
		$J_0(.36) = +.96786$	$Y_0(.36) = -.68055$

Remark. This procedure is equivalent to interpolating by means of the Taylor series

$$\mathcal{C}_0(z+h) = \sum_{k=0}^{\infty} \frac{h^k}{k!} \mathcal{C}_0^{(k)}(z)$$

at $z=.4$, and expressing the derivatives $\mathcal{C}_0^{(k)}(z)$ in terms of $\mathcal{C}_k(z)$ by means of the recurrence relations and differential equation for the Bessel functions.

Example 4. To evaluate $J_\nu(x)$, $J'_\nu(x)$, $Y_\nu(x)$ and $Y'_\nu(x)$ for $\nu=50$, $x=75$, each to 6 decimals.

We use the asymptotic expansions **9.3.35**, **9.3.36**, **9.3.43**, and **9.3.44**. Here $z=x/\nu=3/2$. From **9.3.39** we find

$$\frac{2}{3} (-\frac{1}{2})^{3/2} = \frac{1}{2} \sqrt{5} - \arccos \frac{2}{3} = +.2769653.$$

Hence

$$\zeta = -.5567724 \text{ and } \left(\frac{4\zeta}{1-z^2}\right)^{1/4} = +1.155332.$$

Next,

$$\nu^{1/3} = 3.684031, \quad \nu^{2/3}\zeta = -7.556562.$$

Interpolating in **Table 10.11**, we find that

$$\begin{aligned} \text{Ai}(\nu^{2/3}\zeta) &= +.299953, & \text{Ai}'(\nu^{2/3}\zeta) &= +.451441, \\ \text{Bi}(\nu^{2/3}\zeta) &= -.160565, & \text{Bi}'(\nu^{2/3}\zeta) &= +.819542. \end{aligned}$$

As a check on the interpolation, we may verify that $\text{Ai Bi}' - \text{Ai}' \text{Bi} = 1/\pi$.

Interpolating in the table following **9.3.46** we obtain

$$b_0(\zeta) = +.0136, \quad c_0(\zeta) = +.1442.$$

The contributions of the terms involving $a_1(\zeta)$ and $d_1(\zeta)$ are negligible, and substituting in the asymptotic expansions we find that

$$\begin{aligned} J_{50}(75) &= +1.155332(50^{-1/3} \times .299953 \\ &\quad + 50^{-5/3} \times .451441 \times .0136) = +.094077, \end{aligned}$$

$$\begin{aligned} J'_{50}(75) &= -(4/3)(1.155332)^{-1}(50^{-4/3} \times .299953 \\ &\quad \times .1442 + 50^{-2/3} \times .451441) = -.038658, \end{aligned}$$

$$\begin{aligned} Y_{50}(75) &= -1.155332(-50^{-1/3} \times .160565 \\ &\quad + 50^{-5/3} \times .819542 \times .0136) = +.050335, \end{aligned}$$

$$\begin{aligned} Y'_{50}(75) &= +(4/3)(1.155332)^{-1}(-50^{-4/3} \times .160565 \\ &\quad \times .1442 + 50^{-2/3} \times .819542) = +.069543. \end{aligned}$$

As a check we may verify that

$$JY' - J'Y = 2/(75\pi).$$

Remarks. This example may also be computed using the Debye expansions **9.3.15**, **9.3.16**, **9.3.19**, and **9.3.20**. Four terms of each of these series are required, compared with two in the computations above. The closer the argument-order ratio is to unity, the less effective the Debye expansions become. In the neighborhood of unity the expansions **9.3.23**, **9.3.24**, **9.3.27**, and **9.3.28** will furnish results of moderate accuracy; for high-accuracy work the uniform expansions should again be used.

Example 5. To evaluate the 5th positive zero of $J_{10}(x)$ and the corresponding value of $J'_{10}(x)$, each to 5 decimals.

We use the asymptotic expansions **9.5.22** and **9.5.23** setting $\nu=10$, $s=5$. From **Table 10.11**

we find

$$a_5 = -7.944134, \quad \text{Ai}'(a_5) = +.947336.$$

Hence

$$\zeta = 10^{-2/3}a_5 = .21544347a_5 = -1.7115118.$$

Interpolating in the table following **9.5.26** we obtain

$$\begin{aligned} z(\zeta) &= +2.888631, & h(\zeta) &= +.98259, \\ f_1(\zeta) &= +.0107, & F_1(\zeta) &= -.001. \end{aligned}$$

The bounds given at the foot of the table show that the contributions of higher terms to the asymptotic series are negligible. Hence

$$j_{10,5} = 28.88631 + .00107 + \dots = 28.88738,$$

$$\begin{aligned} J'_{10}(j_{10,5}) &= -\frac{2}{10^{2/3}} \frac{.947336}{2.888631 \times .98259} \\ &\quad \times (1 - .00001 + \dots) = -.14381. \end{aligned}$$

Example 6. To evaluate the first root of $J_0(x)Y_0(\lambda x) - Y_0(x)J_0(\lambda x) = 0$ for $\lambda = \frac{3}{2}$ to 4 significant figures.

Let $\alpha_\lambda^{(1)}$ denote the root. Direct interpolation in **Table 9.7** is impracticable owing to the divergence of the differences. Inspection of **9.5.28** suggests that a smoother function is $(\lambda-1)\alpha_\lambda^{(1)}$. Using **Table 9.7** we compute the following values

$1/\lambda$	$(\lambda-1)\alpha_\lambda^{(1)}$	δ	δ^2
0.4	3.110		
		+21	
0.6	3.131	+9	-12
		+2	
0.8	3.140		-7
1.0	3.142(π)		

Interpolating for $1/\lambda = .667$, we obtain $(\lambda-1)\alpha_\lambda^{(1)} = 3.134$ and thence the required root $\alpha_{1.5}^{(1)} = 6.268$.

Example 7. To evaluate $\text{ber}_n 1.55$, $\text{bei}_n 1.55$, $n=0, 1, 2, \dots$, each to 5 decimals.

We use the recurrence relation

$$\begin{aligned} J_{n-1}(xe^{3\pi i/4}) + J_{n+1}(xe^{3\pi i/4}) \\ = -\frac{n\sqrt{2}}{x} (1+i)J_n(xe^{3\pi i/4}), \end{aligned}$$

taking arbitrary values zero for $J_0(xe^{3\pi i/4})$ and $1+0i$ for $J_8(xe^{3\pi i/4})$ (see **Example 1**).

n	Real trial values	Imag. trial values	$\text{ber}_n x$	$\text{bei}_n x$
9	0	0	.00000	.00000
8	+1	0	.00000	.00000
7	-7	-7	-.00002	-.00003
6	-1	+89	-.00003	+.00030
5	+500	-475	+.00181	-.00148
4	-4447	-203	-.01494	-.00180
3	+14989	+17446	+.04614	+.06258
2	+11172	-88578	+.05994	-.29580
1	-197012	+123804	-.69531	+.36781
0	+281539	+155373	+.91004	+.59461
Σ	+106734	+207449	+.30763	+.72619

The values of $\text{ber}_n x$ and $\text{bei}_n x$ are computed by multiplication of the trial values by the normalizing factor

$$1/(294989 - 22011i) = (.337119 + .025155i) \times 10^{-5},$$

obtained from the relation

$$J_0(xe^{3\pi i/4}) + 2J_2(xe^{3\pi i/4}) + 2J_4(xe^{3\pi i/4}) + \dots = 1.$$

Adequate checks are furnished by interpolating in **Table 9.12** for ber 1.55 and bei 1.55, and the use of a simple sum check on the normalization.

Should $\ker_n x$ and $\text{kei}_n x$ be required they can be computed by forward recurrence using formulas **9.9.14**, taking the required starting values for $n=0$ and 1 from **Table 9.12** (see **Example 2**). If an independent check on the recurrence is required the asymptotic expansion **9.10.38** can be used.

References

Texts

[9.1] E. E. Allen, Analytical approximations, *Math. Tables Aids Comp.* **8**, 240-241 (1954).
 [9.2] E. E. Allen, Polynomial approximations to some modified Bessel functions, *Math. Tables Aids Comp.* **10**, 162-164 (1956).
 [9.3] H. Bateman and R. C. Archibald, A guide to tables of Bessel functions, *Math. Tables Aids Comp.* **1**, 205-308 (1944).
 [9.4] W. G. Bickley, Bessel functions and formulae (Cambridge Univ. Press, Cambridge, England, 1953). This is a straight reprint of part of the preliminaries to [9.21].
 [9.5] H. S. Carslaw and J. C. Jaeger, Conduction of heat in solids (Oxford Univ. Press, London, England, 1947).
 [9.6] E. T. Copson, An introduction to the theory of functions of a complex variable (Oxford Univ. Press, London, England, 1935).
 [9.7] A. Erdélyi et al., Higher transcendental functions, vol 2, ch. 7 (McGraw-Hill Book Co., Inc., New York, N.Y., 1953).
 [9.8] E. T. Goodwin, Recurrence relations for cross-products of Bessel functions, *Quart. J. Mech. Appl. Math.* **2**, 72-74 (1949).
 [9.9] A. Gray, G. B. Mathews and T. M. MacRobert, A treatise on the theory of Bessel functions, 2d ed. (Macmillan and Co., Ltd., London, England, 1931).
 [9.10] W. Magnus and F. Oberhettinger, Formeln und Sätze für die speziellen Funktionen der mathematischen Physik, 2d ed. (Springer-Verlag, Berlin, Germany, 1948).
 [9.11] N. W. McLachlan, Bessel functions for engineers, 2d ed. (Clarendon Press, Oxford, England, 1955).
 [9.12] F. W. J. Olver, Some new asymptotic expansions for Bessel functions of large orders. *Proc. Cambridge Philos. Soc.* **48**, 414-427 (1952).

[9.13] F. W. J. Olver, The asymptotic expansion of Bessel functions of large order. *Philos. Trans. Roy. Soc. London* **A247**, 328-368 (1954).
 [9.14] G. Petiau, La théorie des fonctions de Bessel (Centre National de la Recherche Scientifique, Paris, France, 1955).
 [9.15] G. N. Watson, A treatise on the theory of Bessel functions, 2d ed. (Cambridge Univ. Press, Cambridge, England, 1958).
 [9.16] R. Weyrich, Die Zylinderfunktionen und ihre Anwendungen (B. G. Teubner, Leipzig, Germany, 1937).
 [9.17] C. S. Whitehead, On a generalization of the functions $\text{ber } x$, $\text{bei } x$, $\text{ker } x$, $\text{kei } x$. *Quart. J. Pure Appl. Math.* **42**, 316-342 (1911).
 [9.18] E. T. Whittaker and G. N. Watson, A course of modern analysis, 4th ed. (Cambridge Univ. Press, Cambridge, England, 1952).

Tables

[9.19] J. F. Bridge and S. W. Angrist, An extended table of roots of $J'_n(x)Y'_n(\beta x) - J'_n(\beta x)Y'_n(x) = 0$, *Math. Comp.* **16**, 198-204 (1962).
 [9.20] British Association for the Advancement of Science, Bessel functions, Part I. Functions of orders zero and unity, *Mathematical Tables*, vol. VI (Cambridge Univ. Press, Cambridge, England, 1950).
 [9.21] British Association for the Advancement of Science, Bessel functions, Part II. Functions of positive integer order, *Mathematical Tables*, vol. X (Cambridge Univ. Press, Cambridge, England, 1952).
 [9.22] British Association for the Advancement of Science, Annual Report (J. R. Airey), 254 (1927).
 [9.23] E. Cambi, Eleven- and fifteen-place tables of Bessel functions of the first kind, to all significant orders (Dover Publications, Inc., New York, N.Y., 1948).

- [9.24] E. A. Chistova, *Tablitsy funktsii Besselya ot deistvitel'nogo argumenta i integralov ot nikh* (Izdat. Akad. Nauk SSSR, Moscow, U.S.S.R., 1958). (Table of Bessel functions with real argument and their integrals).
- [9.25] H. B. Dwight, *Tables of integrals and other mathematical data* (The Macmillan Co., New York, N.Y., 1957).
This includes formulas for, and tables of Kelvin functions.
- [9.26] H. B. Dwight, Table of roots for natural frequencies in coaxial type cavities, *J. Math. Phys.* **27**, 84-89 (1948).
This gives zeros of the functions 9.5.27 and 9.5.30 for $n=0,1,2,3$.
- [9.27] V. N. Faddeeva and M. K. Gavurin, *Tablitsy funktsii Besselia $J_n(x)$ tselykh nomerov ot 0 do 120* (Izdat. Akad. Nauk SSSR, Moscow, U.S.S.R., 1950). (Table of $J_n(x)$ for orders 0 to 120).
- [9.28] L. Fox, A short table for Bessel functions of integer orders and large arguments. Royal Society Shorter Mathematical Tables No. 3 (Cambridge Univ. Press, Cambridge, England, 1954).
- [9.29] E. T. Goodwin and J. Staton, Table of $J_0(j_{0,n}r)$, *Quart. J. Mech. Appl. Math.* **1**, 220-224 (1948).
- [9.30] Harvard Computation Laboratory, *Tables of the Bessel functions of the first kind of orders 0 through 135*, vols. 3-14 (Harvard Univ. Press, Cambridge, Mass., 1947-1951).
- [9.31] K. Hayashi, *Tafeln der Besselschen, Theta, Kugel- und anderer Funktionen* (Springer, Berlin, Germany, 1930).
- [9.32] E. Jahnke, F. Emde, and F. Lösch, *Tables of higher functions*, ch. IX, 6th ed. (McGraw-Hill Book Co., Inc., New York, N.Y., 1960).
- [9.33] L. N. Karmazina and E. A. Chistova, *Tablitsy funktsii Besselya ot mnimogo argumenta i integralov ot nikh* (Izdat. Akad. Nauk SSSR, Moscow, U.S.S.R., 1958). (Tables of Bessel functions with imaginary argument and their integrals).
- [9.34] Mathematical Tables Project, Table of $f_n(x) = n!(\frac{1}{2}x)^{-n}J_n(x)$. *J. Math. Phys.* **23**, 45-60 (1944).
- [9.35] National Bureau of Standards, *Table of the Bessel functions $J_0(z)$ and $J_1(z)$ for complex arguments*, 2d ed. (Columbia Univ. Press, New York, N.Y., 1947).
- [9.36] National Bureau of Standards, *Tables of the Bessel functions $Y_0(z)$ and $Y_1(z)$ for complex arguments* (Columbia Univ. Press, New York, N.Y., 1950).
- [9.37] National Physical Laboratory Mathematical Tables, vol. 5, Chebyshev series for mathematical functions, by C. W. Clenshaw (Her Majesty's Stationery Office, London, England, 1962).
- [9.38] National Physical Laboratory Mathematical Tables, vol. 6, Tables for Bessel functions of moderate or large orders, by F. W. J. Olver (Her Majesty's Stationery Office, London, England, 1962).
- [9.39] L. N. Nosova, *Tables of Thomson (Kelvin) functions and their first derivatives*, translated from the Russian by P. Basu (Pergamon Press, New York, N.Y., 1961).
- [9.40] Royal Society Mathematical Tables, vol. 7, Bessel functions, Part III. Zeros and associated values, edited by F. W. J. Olver (Cambridge Univ. Press, Cambridge, England, 1960).
The introduction includes many formulas connected with zeros.
- [9.41] Royal Society Mathematical Tables, vol. 10, Bessel functions, Part IV. Kelvin functions, by A. Young and A. Kirk (Cambridge Univ. Press, Cambridge, England, 1963).
The introduction includes many formulas for Kelvin functions.
- [9.42] W. Sibagaki, 0.01 % tables of modified Bessel functions, with the account of the methods used in the calculation (Baifukan, Tokyo, Japan, 1955).

BESSEL FUNCTIONS OF INTEGER ORDER

Table 9.1 BESSEL FUNCTIONS—ORDERS 0, 1 AND 2

x	$J_0(x)$	$J_1(x)$	$J_2(x)$
0.0	1.00000 00000 00000	0.00000 00000	0.00000 00000
0.1	0.99750 15620 66040	0.04993 75260	0.00124 89587
0.2	0.99002 49722 39576	0.09950 08326	0.00498 33542
0.3	0.97762 62465 38296	0.14831 88163	0.01116 58619
0.4	0.96039 82266 59563	0.19602 65780	0.01973 46631
0.5	0.93846 98072 40813	0.24226 84577	0.03060 40235
0.6	0.91200 48634 97211	0.28670 09881	0.04366 50967
0.7	0.88120 08886 07405	0.32899 57415	0.05878 69444
0.8	0.84628 73527 50480	0.36884 20461	0.07581 77625
0.9	0.80752 37981 22545	0.40594 95461	0.09458 63043
1.0	0.76519 76865 57967	0.44005 05857	0.11490 34849
1.1	0.71962 20185 27511	0.47090 23949	0.13656 41540
1.2	0.67113 27442 64363	0.49828 90576	0.15934 90183
1.3	0.62008 59895 61509	0.52202 32474	0.18302 66988
1.4	0.56685 51203 74289	0.54194 77139	0.20735 58995
1.5	0.51182 76717 35918	0.55793 65079	0.23208 76721
1.6	0.45540 21676 39381	0.56989 59353	0.25696 77514
1.7	0.39798 48594 46109	0.57776 52315	0.28173 89424
1.8	0.33998 64110 42558	0.58151 69517	0.30614 35353
1.9	0.28181 85593 74385	0.58115 70727	0.32992 57277
2.0	0.22389 07791 41236	0.57672 48078	0.35283 40286
2.1	0.16660 69803 31990	0.56829 21358	0.37462 36252
2.2	0.11036 22669 22174	0.55596 30498	0.39505 86875
2.3	0.05553 97844 45602	0.53987 25326	0.41391 45917
2.4	+0.00250 76832 97244	0.52018 52682	0.43098 00402
2.5	-0.04838 37764 68198	0.49709 41025	0.44605 90584
2.6	-0.09680 49543 97038	0.47081 82665	0.45897 28517
2.7	-0.14244 93700 46012	0.44160 13791	0.46956 15027
2.8	-0.18503 60333 64387	0.40970 92469	0.47768 54954
2.9	-0.22431 15457 91968	0.37542 74818	0.48322 70505
3.0	-0.26005 19549 01933	0.33905 89585	0.48609 12606
3.1	-0.29206 43476 50698	0.30092 11331	0.48620 70142
3.2	-0.32018 81696 57123	0.26134 32488	0.48352 77001
3.3	-0.34429 62603 98885	0.22066 34530	0.47803 16865
3.4	-0.36429 55967 62000	0.17922 58517	0.46972 25683
3.5	-0.38012 77399 87263	0.13737 75274	0.45862 91842
3.6	-0.39176 89837 00798	0.09546 55472	0.44480 53988
3.7	-0.39923 02033 71191	0.05383 39877	0.42832 96562
3.8	-0.40255 64101 78564	+0.01282 10029	0.40930 43065
3.9	-0.40182 60148 87640	-0.02724 40396	0.38785 47125
4.0	-0.39714 98098 63847	-0.06604 33280	0.36412 81459
4.1	-0.38866 96798 35854	-0.10327 32577	0.33829 24809
4.2	-0.37655 70543 67568	-0.13864 69421	0.31053 47010
4.3	-0.36101 11172 36535	-0.17189 65602	0.28105 92288
4.4	-0.34225 67900 03886	-0.20277 55219	0.25008 60982
4.5	-0.32054 25089 85121	-0.23106 04319	0.21784 89837
4.6	-0.29613 78165 74141	-0.25655 28361	0.18459 31052
4.7	-0.26933 07894 19753	-0.27908 07358	0.15057 30295
4.8	-0.24042 53272 91183	-0.29849 98581	0.11605 03864
4.9	-0.20973 83275 85326	-0.31469 46710	0.08129 15231
5.0	-0.17759 67713 14338	-0.32757 91376	0.04656 51163
	$\begin{bmatrix} (-4)6 \\ 11 \end{bmatrix}$	$\begin{bmatrix} (-4)5 \\ 8 \end{bmatrix}$	$\begin{bmatrix} (-4)3 \\ 7 \end{bmatrix}$

$$J_{n+1}(x) = \frac{2n}{x} J_n(x) - J_{n-1}(x)$$

Compiled from British Association for the Advancement of Science, Bessel functions, Part II. Functions of positive integer order, Mathematical Tables, vol. X (Cambridge Univ. Press, Cambridge, England, 1952) and Harvard Computation Laboratory, Tables of the Bessel functions of the first kind of orders 0 through 135, vols. 3-14 (Harvard Univ. Press, Cambridge, Mass., 1947-1951) (with permission).

BESSEL FUNCTIONS—ORDERS 0, 1 AND 2

Table 9.1

x	$Y_0(x)$	$Y_1(x)$	$Y_2(x)$
0.0	- ∞	- ∞	- ∞
0.1	-1.53423 86514	-6.45895 10947	-127.64478 324
0.2	-1.08110 53224	-3.32382 49881	-32.15714 456
0.3	-0.80727 35778	-2.29310 51384	-14.48009 401
0.4	-0.60602 45684	-1.78087 20443	-8.29833 565
0.5	-0.44451 87335	-1.47147 23927	-5.44137 084
0.6	-0.30850 98701	-1.26039 13472	-3.89279 462
0.7	-0.19066 49293	-1.10324 98719	-2.96147 756
0.8	-0.08680 22797	-0.97814 41767	-2.35855 816
0.9	+0.00562 83066	-0.87312 65825	-1.94590 960
1.0	0.08825 69642	-0.78121 28213	-1.65068 261
1.1	0.16216 32029	-0.69811 95601	-1.43147 149
1.2	0.22808 35032	-0.62113 63797	-1.26331 080
1.3	0.28653 53572	-0.54851 97300	-1.13041 186
1.4	0.33789 51297	-0.47914 69742	-1.02239 081
1.5	0.38244 89238	-0.41230 86270	-0.93219 376
1.6	0.42042 68964	-0.34757 80083	-0.85489 941
1.7	0.45202 70002	-0.28472 62451	-0.78699 905
1.8	0.47743 17149	-0.22366 48682	-0.72594 824
1.9	0.49681 99713	-0.16440 57723	-0.66987 868
2.0	0.51037 56726	-0.10703 24315	-0.61740 810
2.1	0.51829 37375	-0.05167 86121	-0.56751 146
2.2	0.52078 42854	+0.00148 77893	-0.51943 175
2.3	0.51807 53962	0.05227 73158	-0.47261 686
2.4	0.51041 47487	0.10048 89383	-0.42667 397
2.5	0.49807 03596	0.14591 81380	-0.38133 585
2.6	0.48133 05906	0.18836 35444	-0.33643 556
2.7	0.46050 35491	0.22763 24459	-0.29188 692
2.8	0.43591 59856	0.26354 53936	-0.24766 928
2.9	0.40791 17692	0.29594 00546	-0.20381 518
3.0	0.37685 00100	0.32467 44248	-0.16040 039
3.1	0.34310 28894	0.34962 94823	-0.11753 548
3.2	0.30705 32501	0.37071 13384	-0.07535 866
3.3	0.26909 19951	0.38785 29310	-0.03402 961
3.4	0.22961 53372	0.40101 52921	+0.00627 601
3.5	0.18902 19439	0.41018 84179	0.04537 144
3.6	0.14771 00126	0.41539 17621	0.08306 319
3.7	0.10607 43153	0.41667 43727	0.11915 508
3.8	0.06450 32467	0.41411 46893	0.15345 185
3.9	+0.02337 59082	0.40782 00193	0.18576 256
4.0	-0.01694 07393	0.39792 57106	0.21590 359
4.1	-0.05609 46266	0.38459 40348	0.24370 147
4.2	-0.09375 12013	0.36801 28079	0.26899 540
4.3	-0.12959 59029	0.34839 37583	0.29163 951
4.4	-0.16333 64628	0.32597 06708	0.31150 495
4.5	-0.19470 50086	0.30099 73231	0.32848 160
4.6	-0.22345 99526	0.27374 52415	0.34247 962
4.7	-0.24938 76472	0.24450 12968	0.35343 075
4.8	-0.27230 37945	0.21356 51673	0.36128 928
4.9	-0.29205 45942	0.18124 66920	0.36603 284
5.0	-0.30851 76252	0.14786 31434	0.36766 288

$$Y_{n+1}(x) = \frac{2n}{x} Y_n(x) - Y_{n-1}(x)$$

Table 9.1 BESSEL FUNCTIONS—ORDERS 0, 1 AND 2

x	$J_0(x)$	$J_1(x)$	$J_2(x)$
5.0	-0.17759 67713 14338	-0.32757 91376	0.04656 51163
5.1	-0.14433 47470 60501	-0.33709 72020	+0.01213 97659
5.2	-0.11029 04397 90987	-0.34322 30059	-0.02171 84086
5.3	-0.07580 31115 85584	-0.34596 08338	-0.05474 81465
5.4	-0.04121 01012 44991	-0.34534 47908	-0.08669 53768
5.5	-0.00684 38694 17819	-0.34143 82154	-0.11731 54816
5.6	+0.02697 08846 85114	-0.33433 28363	-0.14637 54691
5.7	0.05992 00097 24037	-0.32414 76802	-0.17365 60379
5.8	0.09170 25675 74816	-0.31102 77443	-0.19895 35139
5.9	0.12203 33545 92823	-0.29514 24447	-0.22208 16409
6.0	0.15064 52572 50997	-0.27668 38581	-0.24287 32100
6.1	0.17729 14222 42744	-0.25586 47726	-0.26118 15116
6.2	0.20174 72229 48904	-0.23291 65671	-0.27688 15994
6.3	0.22381 20061 32191	-0.20808 69402	-0.28987 13522
6.4	0.24331 06048 23407	-0.18163 75090	-0.30007 23264
6.5	0.26009 46055 81606	-0.15384 13014	-0.30743 03906
6.6	0.27404 33606 24146	-0.12498 01652	-0.31191 61379
6.7	0.28506 47377 10576	-0.09534 21180	-0.31352 50715
6.8	0.29309 56031 04273	-0.06521 86634	-0.31227 75629
6.9	0.29810 20354 04820	-0.03490 20961	-0.30821 85850
7.0	0.30007 92705 19556	-0.00468 28235	-0.30141 72201
7.1	0.29905 13805 01550	+0.02515 32743	-0.29196 59511
7.2	0.29507 06914 00958	0.05432 74202	-0.27997 97413
7.3	0.28821 69476 35014	0.08257 04305	-0.26559 49119
7.4	0.27859 62326 57478	0.10962 50949	-0.24896 78286
7.5	0.26633 96578 80378	0.13524 84276	-0.23027 34105
7.6	0.25160 18338 49976	0.15921 37684	-0.20970 34737
7.7	0.23455 91395 86464	0.18131 27153	-0.18746 49278
7.8	0.21540 78077 46263	0.20135 68728	-0.16377 78404
7.9	0.19436 18448 41278	0.21917 93999	-0.13887 33892
8.0	0.17165 08071 37554	0.23463 63469	-0.11299 17204
8.1	0.14751 74540 44378	0.24760 77670	-0.08637 97338
8.2	0.12221 53017 84138	0.25799 85976	-0.05928 88146
8.3	0.09600 61008 95010	0.26573 93020	-0.03197 25341
8.4	0.06915 72616 56985	0.27078 62683	-0.00468 43406
8.5	0.04193 92518 42935	0.27312 19637	+0.02232 47396
8.6	+0.01462 29912 78741	0.27275 48445	0.04880 83679
8.7	-0.01252 27324 49665	0.26971 90241	0.07452 71058
8.8	-0.03923 38031 76542	0.26407 37032	0.09925 05539
8.9	-0.06525 32468 51244	0.25590 23714	0.12275 93977
9.0	-0.09033 36111 82876	0.24531 17866	0.14484 73415
9.1	-0.11423 92326 83199	0.23243 07450	0.16532 29129
9.2	-0.13674 83707 64864	0.21740 86550	0.18401 11218
9.3	-0.15765 51899 43403	0.20041 39278	0.20075 49594
9.4	-0.17677 15727 51508	0.18163 22040	0.21541 67225
9.5	-0.19392 87476 87422	0.16126 44308	0.22787 91542
9.6	-0.20897 87183 68872	0.13952 48117	0.23804 63875
9.7	-0.22179 54820 31723	0.11663 86479	0.24584 46878
9.8	-0.23227 60275 79367	0.09284 00911	0.25122 29849
9.9	-0.24034 11055 34760	0.06836 98323	0.25415 31929
10.0	-0.24593 57644 51348	0.04347 27462	0.25463 03137

$$J_{n+1}(x) = \frac{2n}{x} J_n(x) - J_{n-1}(x)$$

BESSEL FUNCTIONS—ORDERS 0, 1 AND 2

Table 9.1

x	$Y_0(x)$	$Y_1(x)$	$Y_2(x)$
5.0	-0.30851 76252	0.14786 31434	0.36766 288
5.1	-0.32160 24491	0.11373 64420	0.36620 498
5.2	-0.33125 09348	0.07919 03430	0.36170 876
5.3	-0.33743 73011	0.04454 76191	0.35424 772
5.4	-0.34016 78783	+0.01012 72667	0.34391 872
5.5	-0.33948 05929	-0.02375 82390	0.33084 123
5.6	-0.33544 41812	-0.05680 56144	0.31515 646
5.7	-0.32815 71408	-0.08872 33405	0.29702 614
5.8	-0.31774 64300	-0.11923 41135	0.27663 122
5.9	-0.30436 59300	-0.14807 71525	0.25417 029
6.0	-0.28819 46840	-0.17501 03443	0.22985 790
6.1	-0.26943 49304	-0.19981 22045	0.20392 273
6.2	-0.24830 99505	-0.22228 36406	0.17660 555
6.3	-0.22506 17496	-0.24224 95005	0.14815 715
6.4	-0.19994 85953	-0.25955 98934	0.11883 613
6.5	-0.17324 24349	-0.27409 12740	0.08890 666
6.6	-0.14522 62172	-0.28574 72791	0.05863 613
6.7	-0.11619 11427	-0.29445 93130	+0.02829 284
6.8	-0.08643 38683	-0.30018 68758	-0.00185 639
6.9	-0.05625 36922	-0.30291 76343	-0.03154 852
7.0	-0.02594 97440	-0.30266 72370	-0.06052 661
7.1	+0.00418 17932	-0.29947 88746	-0.08854 204
7.2	0.03385 04048	-0.29342 25939	-0.11535 668
7.3	0.06277 38864	-0.28459 43719	-0.14074 495
7.4	0.09068 08802	-0.27311 49598	-0.16449 573
7.5	0.11731 32861	-0.25912 85105	-0.18641 422
7.6	0.14242 85247	-0.24280 10021	-0.20632 353
7.7	0.16580 16324	-0.22431 84743	-0.22406 617
7.8	0.18722 71733	-0.20388 50954	-0.23950 540
7.9	0.20652 09481	-0.18172 10773	-0.25252 628
8.0	0.22352 14894	-0.15806 04617	-0.26303 660
8.1	0.23809 13287	-0.13314 87960	-0.27096 757
8.2	0.25011 80276	-0.10724 07223	-0.27627 430
8.3	0.25951 49638	-0.08059 75035	-0.27893 605
8.4	0.26622 18674	-0.05348 45084	-0.27895 627
8.5	0.27020 51054	-0.02616 86794	-0.27636 244
8.6	0.27145 77123	+0.00108 39918	-0.27120 562
8.7	0.26999 91703	0.02801 09592	-0.26355 987
8.8	0.26587 49418	0.05435 55633	-0.25352 140
8.9	0.25915 57617	0.07986 93974	-0.24120 758
9.0	0.24903 66983	0.10431 45752	-0.22675 568
9.1	0.23833 59921	0.12746 58820	-0.21032 151
9.2	0.22449 36870	0.14911 27879	-0.19207 786
9.3	0.20857 00676	0.16906 13071	-0.17221 280
9.4	0.19074 39189	0.18713 56847	-0.15092 782
9.5	0.17121 06262	0.20317 98994	-0.12843 591
9.6	0.15018 01353	0.21705 89660	-0.10495 952
9.7	0.12787 47920	0.22866 00298	-0.08072 839
9.8	0.10452 70840	0.23789 32421	-0.05597 744
9.9	0.08037 73052	0.24469 24113	-0.03094 449
10.0	0.05567 11673	0.24901 54242	-0.00586 808

$$\left[\begin{matrix} (-4)4 \\ 8 \end{matrix} \right]$$

$$\left[\begin{matrix} (-4)4 \\ 8 \end{matrix} \right]$$

$$\left[\begin{matrix} (-4)4 \\ 6 \end{matrix} \right]$$

$$Y_{n+1}(x) = \frac{2n}{x} Y_n(x) - Y_{n-1}(x)$$

Table 9.1 BESSEL FUNCTIONS—ORDERS 0, 1 AND 2

x	$J_0(x)$		$J_1(x)$		$J_2(x)$	
10.0	-0.24593	57644 51348	0.04347	27462	0.25463	03137
10.1	-0.24902	96505 80910	+0.01839	55155	0.25267	23269
10.2	-0.24961	70698 54127	-0.00661	57433	0.24831	98653
10.3	-0.24771	68134 82244	-0.03131	78295	0.24163	56815
10.4	-0.24337	17507 14207	-0.05547	27618	0.23270	39119
10.5	-0.23664	81944 62347	-0.07885	00142	0.22162	91441
10.6	-0.22763	50476 20693	-0.10122	86626	0.20853	53000
10.7	-0.21644	27399 23818	-0.12239	94239	0.19356	43429
10.8	-0.20320	19671 12039	-0.14216	65683	0.17687	48248
10.9	-0.18806	22459 63342	-0.16034	96867	0.15864	02851
11.0	-0.17119	03004 07196	-0.17678	52990	0.13904	75188
11.1	-0.15276	82954 35677	-0.19132	82878	0.11829	47301
11.2	-0.13299	19368 59575	-0.20385	31459	0.09658	95894
11.3	-0.11206	84561 09807	-0.21425	50262	0.07414	72125
11.4	-0.09021	45002 47520	-0.22245	05864	0.05118	80816
11.5	-0.06765	39481 11665	-0.22837	86207	0.02793	59271
11.6	-0.04461	56740 94438	-0.23200	04746	+0.00461	55923
11.7	-0.02133	12813 88500	-0.23330	02408	-0.01854	91017
11.8	+0.00196	71733 06740	-0.23228	47343	-0.04133	74673
11.9	0.02504	94416 99590	-0.22898	32497	-0.06353	40215
12.0	0.04768	93107 96834	-0.22344	71045	-0.08493	04949
12.1	0.06966	67736 06807	-0.21574	89734	-0.10532	77609
12.2	0.09077	01231 70505	-0.20598	20217	-0.12453	76677
12.3	0.11079	79503 07585	-0.19425	88480	-0.14238	47549
12.4	0.12956	10265 17502	-0.18071	02469	-0.15870	78405
12.5	0.14688	40547 00421	-0.16548	38046	-0.17336	14634
12.6	0.16260	72717 45511	-0.14874	23434	-0.18621	71675
12.7	0.17658	78885 61499	-0.13066	22290	-0.19716	46175
12.8	0.18870	13547 80683	-0.11143	15593	-0.20611	25359
12.9	0.19884	24371 36331	-0.09124	82522	-0.21298	94530
13.0	0.20692	61023 77068	-0.07031	80521	-0.21774	42642
13.1	0.21288	81975 22060	-0.04885	24733	-0.22034	65904
13.2	0.21668	59222 58564	-0.02706	67028	-0.22078	69378
13.3	0.21829	80903 19277	-0.00517	74806	-0.21907	66588
13.4	0.21772	51787 31184	+0.01659	90199	-0.21524	77131
13.5	0.21498	91658 80401	0.03804	92921	-0.20935	22337
13.6	0.21013	31613 69248	0.05896	45572	-0.20146	19030
13.7	0.20322	08326 33007	0.07914	27651	-0.19166	71443
13.8	0.19433	56352 15629	0.09839	05167	-0.18007	61400
13.9	0.18357	98554 57870	0.11652	48904	-0.16681	36842
14.0	0.17107	34761 10459	0.13337	51547	-0.15201	98826
14.1	0.15695	28770 32601	0.14878	43513	-0.13584	87137
14.2	0.14136	93846 57129	0.16261	07342	-0.11846	64643
14.3	0.12448	76852 83919	0.17472	90520	-0.10005	00556
14.4	0.10648	41184 90342	0.18503	16616	-0.08078	52766
14.5	0.08754	48680 10376	0.19342	94636	-0.06086	49420
14.6	0.06786	40683 23379	0.19985	26514	-0.04048	69928
14.7	0.04764	18459 01522	0.20425	12683	-0.01985	25577
14.8	0.02708	23145 85872	0.20659	55672	+0.00083	60053
14.9	+0.00639	15448 90853	0.20687	61718	0.02137	70688
15.0	-0.01422	44728 26781	0.20510	40386	0.04157	16780

$$J_{n+1}(x) = \frac{2n}{x} J_n(x) - J_{n-1}(x)$$

BESSEL FUNCTIONS—ORDERS 0, 1 AND 2

Table 9.1

x	$Y_0(x)$	$Y_1(x)$	$Y_2(x)$
10.0	0.05567 11673	0.24901 54242	-0.00586 808
10.1	0.03065 73806	0.25084 44363	+0.01901 478
10.2	+0.00558 52273	0.25018 58292	0.04347 082
10.3	-0.01929 78497	0.24706 99395	0.06727 260
10.4	-0.04374 86190	0.24155 05610	0.09020 065
10.5	-0.06753 03725	0.23370 42284	0.11204 546
10.6	-0.09041 51548	0.22362 92892	0.13260 936
10.7	-0.11218 58897	0.21144 47763	0.15170 828
10.8	-0.13263 83844	0.19728 90905	0.16917 340
10.9	-0.15158 31932	0.18131 85097	0.18485 264
11.0	-0.16884 73239	0.16370 55374	0.19861 197
11.1	-0.18427 57716	0.14463 71102	0.21033 651
11.2	-0.19773 28675	0.12431 26795	0.21993 156
11.3	-0.20910 34295	0.10294 21889	0.22732 329
11.4	-0.21829 37073	0.08074 39654	0.23245 932
11.5	-0.22523 21117	0.05794 25471	0.23530 908
11.6	-0.22986 97260	0.03476 64663	0.23586 394
11.7	-0.23218 05930	+0.01144 60113	0.23413 718
11.8	-0.23216 17790	-0.01178 90120	0.23016 364
11.9	-0.22983 32139	-0.03471 14983	0.22399 935
12.0	-0.22523 73126	-0.05709 92183	0.21572 078
12.1	-0.21843 83806	-0.07873 69315	0.20542 401
12.2	-0.20952 18128	-0.09941 84171	0.19322 371
12.3	-0.19859 30946	-0.11894 84033	0.17925 189
12.4	-0.18577 66153	-0.13714 43766	0.16365 655
12.5	-0.17121 43068	-0.15383 82565	0.14660 019
12.6	-0.15506 41238	-0.16887 79186	0.12825 810
12.7	-0.13749 83780	-0.18212 85528	0.10881 672
12.8	-0.11870 19463	-0.19347 38454	0.08847 166
12.9	-0.09887 03702	-0.20281 69743	0.06742 588
13.0	-0.07820 78645	-0.21008 14084	0.04588 765
13.1	-0.05692 52568	-0.21521 15060	0.02406 854
13.2	-0.03523 78771	-0.21817 29066	+0.00218 138
13.3	-0.01336 34191	-0.21895 27145	-0.01956 180
13.4	+0.00848 02072	-0.21755 94728	-0.04095 177
13.5	0.03007 70090	-0.21402 29303	-0.06178 411
13.6	0.05121 50115	-0.20839 36044	-0.08186 113
13.7	0.07168 83040	-0.20074 21453	-0.10099 373
13.8	0.09129 90143	-0.19115 85095	-0.11900 315
13.9	0.10985 91895	-0.17975 09511	-0.13572 264
14.0	0.12719 25686	-0.16664 48419	-0.15099 897
14.1	0.14313 62286	-0.15198 13335	-0.16469 386
14.2	0.15754 20895	-0.13591 58742	-0.17668 517
14.3	0.17027 82640	-0.11861 65967	-0.18686 800
14.4	0.18123 02411	-0.10026 25924	-0.19515 560
14.5	0.19030 18912	-0.08104 20909	-0.20148 011
14.6	0.19741 62858	-0.06115 05609	-0.20579 307
14.7	0.20251 63238	-0.04078 87536	-0.20806 581
14.8	0.20556 51604	-0.02016 07059	-0.20828 958
14.9	0.20654 64347	+0.00052 82751	-0.20647 553
15.0	0.20546 42960	0.02107 36280	-0.20265 448
	$\left[\begin{smallmatrix} (-4)3 \\ 8 \end{smallmatrix} \right]$	$\left[\begin{smallmatrix} (-4)3 \\ 8 \end{smallmatrix} \right]$	$\left[\begin{smallmatrix} (-4)3 \\ 6 \end{smallmatrix} \right]$

$$Y_{n+1}(x) = \frac{2n}{x} Y_n(x) - Y_{n-1}(x)$$

Table 9.1 BESSEL FUNCTIONS—ORDERS 0, 1 AND 2

x	$J_0(x)$			$J_1(x)$		$J_2(x)$	
15.0	-0.01422	44728	26781	0.20510	40386	0.04157	16780
15.1	-0.03456	18514	55565	0.20131	02204	0.06122	54568
15.2	-0.05442	07968	44039	0.19554	54359	0.08015	04595
15.3	-0.07360	75449	51123	0.18787	94498	0.09816	69502
15.4	-0.09193	62278	62321	0.17840	02717	0.11510	50943
15.5	-0.10923	06509	00050	0.16721	31804	0.13080	65451
15.6	-0.12532	59640	22481	0.15443	95871	0.14512	59111
15.7	-0.14007	02118	29049	0.14021	57469	0.15793	20904
15.8	-0.15332	57477	60686	0.12469	13334	0.16910	94608
15.9	-0.16497	04994	85671	0.10802	78901	0.17855	89133
16.0	-0.17489	90739	83629	0.09039	71757	0.18619	87209
16.1	-0.18302	36924	65310	0.07197	94186	0.19196	52352
16.2	-0.18927	49469	77945	0.05296	14991	0.19581	34037
16.3	-0.19360	23723	28377	0.03353	50765	0.19771	71056
16.4	-0.19597	48287	91007	+0.01389	46807	0.19766	93020
16.5	-0.19638	06929	36861	-0.00576	42137	0.19568	20004
16.6	-0.19482	78558	05566	-0.02524	71116	0.19178	60351
16.7	-0.19134	35295	25189	-0.04436	24008	0.18603	06671
16.8	-0.18597	38653	47601	-0.06292	32177	0.17848	30061
16.9	-0.17878	33878	91219	-0.08074	92543	0.16922	72631
17.0	-0.16985	42521	51184	-0.09766	84928	0.15836	38412
17.1	-0.15928	53315	32265	-0.11351	88483	0.14600	82733
17.2	-0.14719	11467	66030	-0.12814	97057	0.13229	00182
17.3	-0.13370	06470	75764	-0.14142	33355	0.11735	11285
17.4	-0.11895	58563	36348	-0.15321	61760	0.10134	48016
17.5	-0.10311	03982	28686	-0.16341	99694	0.08443	38303
	$\begin{bmatrix} (-4)2 \\ 11 \end{bmatrix}$			$\begin{bmatrix} (-4)2 \\ 7 \end{bmatrix}$		$\begin{bmatrix} (-4)2 \\ 7 \end{bmatrix}$	

$$J_{n+1}(x) = \frac{2n}{x} J_n(x) - J_{n-1}(x)$$

Table 9.1 BESSEL FUNCTIONS—MODULUS AND PHASE OF ORDERS 0, 1 AND 2

x^{-1}	$x^{\frac{1}{2}}M_0(x)$	$\theta_0(x)-x$	$x^{\frac{1}{2}}M_1(x)$	$\theta_1(x)-x$	$x^{\frac{1}{2}}M_2(x)$	$\theta_2(x)-x$	$\langle x \rangle$
0.10	0.79739 375	-0.79783 499	0.79936 575	-2.31885 508	0.80542 555	-3.73985 605	10
0.09	0.79748 584	-0.79660 186	0.79908 654	-2.32256 201	0.80398 367	-3.75850 527	11
0.08	0.79756 868	-0.79536 548	0.79883 586	-2.32627 732	0.80269 711	-3.77717 539	13
0.07	0.79764 214	-0.79412 617	0.79861 398	-2.33000 016	0.80156 472	-3.79586 377	14
0.06	0.79770 609	-0.79288 426	0.79842 116	-2.33372 965	0.80058 549	-3.81456 786	17
0.05	0.79776 040	-0.79164 009	0.79825 761	-2.33746 488	0.79975 851	-3.83328 521	20
0.04	0.79780 498	-0.79039 402	0.79812 353	-2.34120 495	0.79908 299	-3.85201 346	25
0.03	0.79783 975	-0.78914 641	0.79801 908	-2.34494 891	0.79855 829	-3.87075 034	33
0.02	0.79786 463	-0.78789 764	0.79794 438	-2.34869 580	0.79818 387	-3.88949 363	50
0.01	0.79787 957	-0.78664 810	0.79789 952	-2.35244 465	0.79795 937	-3.90824 117	100
0.00	0.79788 456	-0.78539 816	0.79788 456	-2.35619 449	0.79788 456	-3.92699 082	∞
	$\begin{bmatrix} (-6)1 \\ 4 \end{bmatrix}$	$\begin{bmatrix} (-7)4 \\ 4 \end{bmatrix}$	$\begin{bmatrix} (-6)4 \\ 4 \end{bmatrix}$	$\begin{bmatrix} (-6)1 \\ 4 \end{bmatrix}$	$\begin{bmatrix} (-5)2 \\ 4 \end{bmatrix}$	$\begin{bmatrix} (-6)3 \\ 4 \end{bmatrix}$	

$\langle x \rangle$ = nearest integer to x .

BESSEL FUNCTIONS—ORDERS 0, 1 AND 2

Table 9.1

x	$Y_0(x)$	$Y_1(x)$	$Y_2(x)$
15.0	0.20546 42960	0.02107 36280	-0.20265 448
15.1	0.20234 32292	0.04127 35340	-0.19687 654
15.2	0.19722 76821	0.06093 08736	-0.18921 046
15.3	0.19018 15001	0.07985 51269	-0.17974 292
15.4	0.18128 71741	0.09786 41973	-0.16857 754
15.5	0.17064 49112	0.11478 61425	-0.15583 380
15.6	0.15837 15368	0.13046 07959	-0.14164 579
15.7	0.14459 92412	0.14474 12638	-0.12616 086
15.8	0.12947 41833	0.15749 52835	-0.10953 807
15.9	0.11315 49657	0.16860 64314	-0.09194 661
16.0	0.09581 09971	0.17797 51689	-0.07356 410
16.1	0.07762 07587	0.18551 97173	-0.05457 483
16.2	0.05876 99918	0.19117 67538	-0.03516 792
16.3	0.03944 98249	0.19490 19240	-0.01553 548
16.4	0.01985 48596	0.19667 01648	+0.00412 931
16.5	+0.00018 12325	0.19647 58378	0.02363 402
16.6	-0.01937 53254	0.19433 26715	0.04278 890
16.7	-0.03862 14147	0.19027 35142	0.06140 866
16.8	-0.05736 78596	0.18434 99015	0.07931 428
16.9	-0.07543 15476	0.17663 14431	0.09633 468
17.0	-0.09263 71984	0.16720 50361	0.11230 838
17.1	-0.10881 90473	0.15617 39131	0.12708 500
17.2	-0.12382 24237	0.14365 65362	0.14052 667
17.3	-0.13750 52134	0.12978 53467	0.15250 930
17.4	-0.14973 91883	0.11470 53859	0.16292 372
17.5	-0.16041 11925 $\left[\begin{smallmatrix} (-4)2 \\ 7 \end{smallmatrix} \right]$	0.09857 27987 $\left[\begin{smallmatrix} (-4)2 \\ 7 \end{smallmatrix} \right]$	0.17167 666 $\left[\begin{smallmatrix} (-4)2 \\ 6 \end{smallmatrix} \right]$

$$Y_{n+1}(x) = \frac{2n}{x} Y_n(x) - Y_{n-1}(x)$$

Table 9.1

BESSEL FUNCTIONS—AUXILIARY TABLE FOR SMALL ARGUMENTS

x	$f_1(x)$	$f_2(x)$	x	$f_1(x)$	$f_2(x)$
0.0	-0.07380 430	-0.63661 977	1.0	0.08825 696	-0.78121 282
0.1	-0.07202 984	-0.63857 491	1.1	0.11849 917	-0.79936 142
0.2	-0.06672 574	-0.64437 529	1.2	0.15018 546	-0.81476 705
0.3	-0.05794 956	-0.65382 684	1.3	0.18296 470	-0.82642 473
0.4	-0.04579 663	-0.66660 964	1.4	0.21647 200	-0.83332 875
0.5	-0.03039 904	-0.68228 315	1.5	0.25033 233	-0.83449 074
0.6	-0.01192 435	-0.70029 342	1.6	0.28416 437	-0.82895 780
0.7	+0.00942 612	-0.71998 221	1.7	0.31758 436	-0.81583 036
0.8	0.03341 927	-0.74059 789	1.8	0.35020 995	-0.79427 978
0.9	0.05979 263	-0.76130 792	1.9	0.38166 415	-0.76356 508
1.0	0.08825 696 $\left[\begin{smallmatrix} (-4)4 \\ 6 \end{smallmatrix} \right]$	-0.78121 282 $\left[\begin{smallmatrix} (-4)5 \\ 7 \end{smallmatrix} \right]$	2.0	0.41157 912 $\left[\begin{smallmatrix} (-4)2 \\ 6 \end{smallmatrix} \right]$	-0.72304 896 $\left[\begin{smallmatrix} (-3)1 \\ 6 \end{smallmatrix} \right]$

$$Y_0(x) = f_1(x) + \frac{2}{\pi} J_0(x) \ln x$$

$$Y_1(x) = \frac{1}{x} f_2(x) + \frac{2}{\pi} J_1(x) \ln x$$

Table 9.2

BESSEL FUNCTIONS—ORDERS 3-9

x	$J_3(x)$	$J_4(x)$	$J_5(x)$	$J_6(x)$	$J_7(x)$	$J_8(x)$	$J_9(x)$
0.0	0.0000	0.0000	0.0000	0.0000	0.0000	0.0000	0.0000
0.2	(-4)1.6625	(-6)4.1583	(-8)8.3195	(-9)1.3869	(-11)1.9816	(-13)2.4774	(-15)2.7530
0.4	(-3)1.3201	(-5)6.6135	(-6)2.6489	(-8)8.8382	(-9)2.5270	(-11)6.3210	(-12)1.4053
0.6	(-3)4.3997	(-4)3.3147	(-5)1.9948	(-7)9.9956	(-8)4.2907	(-9)1.6110	(-11)5.3755
0.8	(-2)1.0247	(-3)1.0330	(-5)8.3084	(-6)5.5601	(-7)3.1864	(-8)1.5967	(-10)7.1092
1.0	(-2)1.9563	(-3)2.4766	(-4)2.4976	(-5)2.0938	(-6)1.5023	(-8)9.4223	(-9)5.2493
1.2	(-2)3.2874	(-3)5.0227	(-4)6.1010	(-5)6.1541	(-6)5.3093	(-7)4.0021	(-8)2.6788
1.4	(-2)5.0498	(-3)9.0629	(-3)1.2901	(-4)1.5231	(-5)1.5366	(-6)1.3538	(-7)1.0587
1.6	(-2)7.2523	(-2)1.4995	(-3)2.4524	(-4)3.3210	(-5)3.8397	(-6)3.8744	(-7)3.4687
1.8	(-2)9.8802	(-2)2.3197	(-3)4.2936	(-4)6.5690	(-5)8.5712	(-6)9.7534	(-7)9.8426
2.0	0.12894	(-2)3.3996	(-3)7.0396	(-3)1.2024	(-4)1.7494	(-5)2.2180	(-6)2.4923
2.2	0.16233	(-2)4.7647	(-2)1.0937	(-3)2.0660	(-4)3.3195	(-5)4.6434	(-6)5.7535
2.4	0.19811	(-2)6.4307	(-2)1.6242	(-3)3.3669	(-4)5.9274	(-5)9.0756	(-5)1.2300
2.6	0.23529	(-2)8.4013	(-2)2.3207	(-3)5.2461	(-3)1.0054	(-4)1.6738	(-5)2.4647
2.8	0.27270	(-1)1.0667	(-2)3.2069	(-3)7.8634	(-3)1.6314	(-4)2.9367	(-5)4.6719
3.0	0.30906	0.13203	(-2)4.3028	(-2)1.1394	(-3)2.5473	(-4)4.9344	(-5)8.4395
3.2	0.34307	0.15972	(-2)5.6238	(-2)1.6022	(-3)3.8446	(-4)7.9815	(-4)1.4615
3.4	0.37339	0.18920	(-2)7.1785	(-2)2.1934	(-3)5.6301	(-3)1.2482	(-4)2.4382
3.6	0.39876	0.21980	(-2)8.9680	(-2)2.9311	(-3)8.0242	(-3)1.8940	(-4)3.9339
3.8	0.41803	0.25074	(-1)1.0984	(-2)3.8316	(-2)1.1159	(-3)2.7966	(-4)6.1597
4.0	0.43017	0.28113	0.13209	(-2)4.9088	(-2)1.5176	(-3)4.0287	(-4)9.3860
4.2	0.43439	0.31003	0.15614	(-2)6.1725	(-2)2.0220	(-3)5.6739	(-3)1.3952
4.4	0.43013	0.33645	0.18160	(-2)7.6279	(-2)2.6433	(-3)7.8267	(-3)2.0275
4.6	0.41707	0.35941	0.20799	(-2)9.2745	(-2)3.3953	(-2)1.0591	(-3)2.8852
4.8	0.39521	0.37796	0.23473	(-1)1.1105	(-2)4.2901	(-2)1.4079	(-3)4.0270
5.0	0.36483	0.39123	0.26114	0.13105	(-2)5.3376	(-2)1.8405	(-3)5.5203
5.2	0.32652	0.39847	0.28651	0.15252	(-2)6.5447	(-2)2.3689	(-3)7.4411
5.4	0.28113	0.39906	0.31007	0.17515	(-2)7.9145	(-2)3.0044	(-3)9.8734
5.6	0.22978	0.39257	0.33103	0.19856	(-2)9.4455	(-2)3.7577	(-2)1.2907
5.8	0.17382	0.37877	0.34862	0.22230	(-1)1.1131	(-2)4.6381	(-2)1.6639
6.0	0.11477	0.35764	0.36209	0.24584	0.12959	(-2)5.6532	(-2)2.1165
6.2	+0.05428	0.32941	0.37077	0.26860	0.14910	(-2)6.8077	(-2)2.6585
6.4	-0.00591	0.29453	0.37408	0.28996	0.16960	(-2)8.1035	(-2)3.2990
6.6	-0.06406	0.25368	0.37155	0.30928	0.19077	(-2)9.5385	(-2)4.0468
6.8	-0.11847	0.20774	0.36288	0.32590	0.21224	(-1)1.1107	(-2)4.9093
7.0	-0.16756	0.15780	0.34790	0.33920	0.23358	0.12797	(-2)5.8921
7.2	-0.20987	0.10509	0.32663	0.34857	0.25432	0.14594	(-2)6.9987
7.4	-0.24420	+0.05097	0.29930	0.35349	0.27393	0.16476	(-2)8.2300
7.6	-0.26958	-0.00313	0.26629	0.35351	0.29188	0.18417	(-2)9.5839
7.8	-0.28535	-0.05572	0.22820	0.34828	0.30762	0.20385	(-1)1.1054
8.0	-0.29113	-0.10536	0.18577	0.33758	0.32059	0.22345	0.12632
8.2	-0.28692	-0.15065	0.13994	0.32131	0.33027	0.24257	0.14303
8.4	-0.27302	-0.19033	0.09175	0.29956	0.33619	0.26075	0.16049
8.6	-0.25005	-0.22326	+0.04237	0.27253	0.33790	0.27755	0.17847
8.8	-0.21896	-0.24854	-0.00699	0.24060	0.33508	0.29248	0.19670
9.0	-0.18094	-0.26547	-0.05504	0.20432	0.32746	0.30507	0.21488
9.2	-0.13740	-0.27362	-0.10053	0.16435	0.31490	0.31484	0.23266
9.4	-0.08997	-0.27284	-0.14224	0.12152	0.29737	0.32138	0.24965
9.6	-0.04034	-0.26326	-0.17904	0.07676	0.27499	0.32427	0.26546
9.8	+0.00970	-0.24528	-0.20993	+0.03107	0.24797	0.32318	0.27967
10.0	0.05838	-0.21960	-0.23406	-0.01446	0.21671	0.31785	0.29186

Compiled from British Association for the Advancement of Science, Bessel functions, Part II. Functions of positive integer order, Mathematical Tables, vol. X (Cambridge Univ. Press, Cambridge, England, 1952) and Mathematical Tables Project, Table of $f_n(x) = n!(\frac{1}{2}x)^{-n}J_n(x)$. J. Math. Phys. **23**, 45-60 (1944) (with permission).

BESSEL FUNCTIONS—ORDERS 3-9

Table 9.2

x	$Y_3(x)$	$Y_4(x)$	$Y_5(x)$	$Y_6(x)$	$Y_7(x)$	$Y_8(x)$	$Y_9(x)$
0.0	$-\infty$	$-\infty$	$-\infty$	$-\infty$	$-\infty$	$-\infty$	$-\infty$
0.2	(2) -6.3982	(4) -1.9162	(5) -7.6586	(7) -3.8274	(9) -2.2957	(11) -1.6066	(13) -1.2850
0.4	(1) -8.1202	(3) -1.2097	(4) -2.4114	(5) -6.0163	(7) -1.8025	(8) -6.3027	(10) -2.5193
0.6	(1) -2.4692	(2) -2.4302	(3) -3.2156	(4) -5.3351	(6) -1.0638	(7) -2.4769	(8) -6.5943
0.8	(1) -1.0815	(1) -7.8751	(2) -7.7670	(3) -9.6300	(5) -1.4367	(6) -2.5046	(7) -4.9949
1.0	-5.8215	(1) -3.3278	(2) -2.6041	(3) -2.5708	(4) -3.0589	(5) -4.2567	(6) -6.7802
1.2	-3.5899	(1) -1.6686	(2) -1.0765	(2) -8.8041	(3) -8.6964	(5) -1.0058	(6) -1.3323
1.4	-2.4420	-9.4432	(1) -5.1519	(2) -3.5855	(3) -3.0218	(4) -2.9859	(5) -3.3823
1.6	-1.7897	-5.8564	(1) -2.7492	(2) -1.6597	(3) -1.2173	(4) -1.0485	(5) -1.0364
1.8	-1.3896	-3.9059	(1) -1.5970	(1) -8.4816	(2) -5.4947	(3) -4.1889	(4) -3.6685
2.0	-1.1278	-2.7659	-9.9360	(1) -4.6914	(2) -2.7155	(3) -1.8539	(4) -1.4560
2.2	-0.94591	-2.0603	-6.5462	(1) -2.7695	(2) -1.4452	(2) -8.9196	(3) -6.3425
2.4	-0.81161	-1.6024	-4.5296	(1) -1.7271	(1) -8.1825	(2) -4.6004	(3) -2.9851
2.6	-0.70596	-1.2927	-3.2716	(1) -1.1290	(1) -4.8837	(2) -2.5168	(3) -1.5000
2.8	-0.61736	-1.0752	-2.4548	-7.6918	(1) -3.0510	(2) -1.4486	(2) -7.9725
3.0	-0.53854	-0.91668	-1.9059	-5.4365	(1) -1.9840	(1) -8.7150	(2) -4.4496
3.2	-0.46491	-0.79635	-1.5260	-3.9723	(1) -1.3370	(1) -5.4522	(2) -2.5924
3.4	-0.39363	-0.70092	-1.2556	-2.9920	-9.3044	(1) -3.5320	(2) -1.5691
3.6	-0.32310	-0.62156	-1.0581	-2.3177	-6.6677	(1) -2.3612	(1) -9.8275
3.8	-0.25259	-0.55227	-0.91009	-1.8427	-4.9090	(1) -1.6243	(1) -6.3483
4.0	-0.18202	-0.48894	-0.79585	-1.5007	-3.7062	(1) -1.1471	(1) -4.2178
4.2	-0.11183	-0.42875	-0.70484	-1.2494	-2.8650	-8.3005	(1) -2.8756
4.4	-0.04278	-0.36985	-0.62967	-1.0612	-2.2645	-6.1442	(1) -2.0078
4.6	+0.02406	-0.31109	-0.56509	-0.91737	-1.8281	-4.6463	(1) -1.4333
4.8	0.08751	-0.25190	-0.50735	-0.80507	-1.5053	-3.5855	(1) -1.0446
5.0	0.14627	-0.19214	-0.45369	-0.71525	-1.2629	-2.8209	-7.7639
5.2	0.19905	-0.13204	-0.40218	-0.64139	-1.0780	-2.2608	-5.8783
5.4	0.24463	-0.07211	-0.35146	-0.57874	-0.93462	-1.8444	-4.5302
5.6	0.28192	-0.01310	-0.30063	-0.52375	-0.82168	-1.5304	-3.5510
5.8	0.31001	+0.04407	-0.24922	-0.47377	-0.73099	-1.2907	-2.8295
6.0	0.32825	0.09839	-0.19706	-0.42683	-0.65659	-1.1052	-2.2907
6.2	0.33622	0.14877	-0.14426	-0.38145	-0.59403	-0.95990	-1.8831
6.4	0.33383	0.19413	-0.09117	-0.33658	-0.53992	-0.84450	-1.5713
6.6	0.32128	0.23344	-0.03833	-0.29151	-0.49169	-0.75147	-1.3301
6.8	0.29909	0.26576	+0.01357	-0.24581	-0.44735	-0.67521	-1.1414
7.0	0.26808	0.29031	0.06370	-0.19931	-0.40537	-0.61144	-0.99220
7.2	0.22934	0.30647	0.11119	-0.15204	-0.36459	-0.55689	-0.87293
7.4	0.18420	0.31385	0.15509	-0.10426	-0.32416	-0.50902	-0.77643
7.6	0.13421	0.31228	0.19450	-0.05635	-0.28348	-0.46585	-0.69726
7.8	0.08106	0.30186	0.22854	-0.00886	-0.24217	-0.42581	-0.63128
8.0	+0.02654	0.28294	0.25640	+0.03756	-0.20006	-0.38767	-0.57528
8.2	-0.02753	0.25613	0.27741	0.08218	-0.15716	-0.35049	-0.52673
8.4	-0.07935	0.22228	0.29104	0.12420	-0.11361	-0.31355	-0.48363
8.6	-0.12723	0.18244	0.29694	0.16284	-0.06973	-0.27635	-0.44440
8.8	-0.16959	0.13789	0.29495	0.19728	-0.02593	-0.23853	-0.40777
9.0	-0.20509	0.09003	0.28512	0.22677	+0.01724	-0.19995	-0.37271
9.2	-0.23262	+0.04037	0.26773	0.25064	0.05920	-0.16056	-0.33843
9.4	-0.25136	-0.00951	0.24326	0.26830	0.09925	-0.12048	-0.30433
9.6	-0.26079	-0.05804	0.21243	0.27932	0.13672	-0.07994	-0.26995
9.8	-0.26074	-0.10366	0.17612	0.28338	0.17087	-0.03928	-0.23499
10.0	-0.25136	-0.14495	0.13540	0.28035	0.20102	+0.00108	-0.19930

Table 9.2

BESSEL FUNCTIONS—ORDERS 3-9

x	$J_3(x)$	$J_4(x)$	$J_5(x)$	$J_6(x)$	$J_7(x)$	$J_8(x)$	$J_9(x)$
10.0	0.05838	-0.21960	-0.23406	-0.01446	0.21671	0.31785	0.29186
10.2	0.10400	-0.18715	-0.25078	-0.05871	0.18170	0.30811	0.30161
10.4	0.14497	-0.14906	-0.25964	-0.10059	0.14358	0.29386	0.30852
10.6	0.17992	-0.10669	-0.26044	-0.13901	0.10308	0.27515	0.31224
10.8	0.20768	-0.06150	-0.25323	-0.17297	0.06104	0.25210	0.31244
11.0	0.22735	-0.01504	-0.23829	-0.20158	+0.01838	0.22497	0.30886
11.2	0.23835	+0.03110	-0.21614	-0.22408	-0.02395	0.19414	0.30130
11.4	0.24041	0.07534	-0.18754	-0.23985	-0.06494	0.16010	0.28964
11.6	0.23359	0.11621	-0.15345	-0.24849	-0.10361	0.12344	0.27388
11.8	0.21827	0.15232	-0.11500	-0.24978	-0.13901	0.08485	0.25407
12.0	0.19514	0.18250	-0.07347	-0.24372	-0.17025	0.04510	0.23038
12.2	0.16515	0.20576	-0.03023	-0.23053	-0.19653	+0.00501	0.20310
12.4	0.12951	0.22138	+0.01331	-0.21064	-0.21716	-0.03453	0.17260
12.6	0.08963	0.22890	0.05571	-0.18469	-0.23160	-0.07264	0.13935
12.8	0.04702	0.22815	0.09557	-0.15349	-0.23947	-0.10843	0.10393
13.0	+0.00332	0.21928	0.13162	-0.11803	-0.24057	-0.14105	0.06698
13.2	-0.03984	0.20268	0.16267	-0.07944	-0.23489	-0.16969	+0.02921
13.4	-0.08085	0.17905	0.18774	-0.03894	-0.22261	-0.19364	-0.00860
13.6	-0.11822	0.14931	0.20605	+0.00220	-0.20411	-0.21231	-0.04567
13.8	-0.15059	0.11460	0.21702	0.04266	-0.17993	-0.22520	-0.08117
14.0	-0.17681	0.07624	0.22038	0.08117	-0.15080	-0.23197	-0.11431
14.2	-0.19598	+0.03566	0.21607	0.11650	-0.11762	-0.23246	-0.14432
14.4	-0.20747	-0.00566	0.20433	0.14756	-0.08136	-0.22666	-0.17048
14.6	-0.21094	-0.04620	0.18563	0.17335	-0.04315	-0.21472	-0.19216
14.8	-0.20637	-0.08450	0.16069	0.19308	-0.00415	-0.19700	-0.20883
15.0	-0.19402	-0.11918	0.13046	0.20615	+0.03446	-0.17398	-0.22005
15.2	-0.17445	-0.14901	0.09603	0.21219	0.07149	-0.14634	-0.22553
15.4	-0.14850	-0.17296	0.05865	0.21105	0.10580	-0.11487	-0.22514
15.6	-0.11723	-0.19021	+0.01968	0.20283	0.13634	-0.08047	-0.21888
15.8	-0.08188	-0.20020	-0.01949	0.18787	0.16217	-0.04417	-0.20690
16.0	-0.04385	-0.20264	-0.05747	0.16672	0.18251	-0.00702	-0.18953
16.2	-0.00461	-0.19752	-0.09293	0.14016	0.19675	+0.02987	-0.16725
16.4	+0.03432	-0.18511	-0.12462	0.10913	0.20447	0.06542	-0.14065
16.6	0.07146	-0.16596	-0.15144	0.07473	0.20546	0.09855	-0.11047
16.8	0.10542	-0.14083	-0.17248	0.03817	0.19974	0.12829	-0.07756
17.0	0.13493	-0.11074	-0.18704	+0.00072	0.18755	0.15374	-0.04286
17.2	0.15891	-0.07685	-0.19466	-0.03632	0.16932	0.17414	-0.00733
17.4	0.17651	-0.04048	-0.19512	-0.07166	0.14570	0.18889	+0.02799
17.6	0.18712	-0.00300	-0.18848	-0.10410	0.11751	0.19757	0.06210
17.8	0.19041	+0.03417	-0.17505	-0.13251	0.08571	0.19993	0.09400
18.0	0.18632	0.06964	-0.15537	-0.15596	0.05140	0.19593	0.12276
18.2	0.17510	0.10209	-0.13022	-0.17364	+0.01573	0.18574	0.14756
18.4	0.15724	0.13033	-0.10058	-0.18499	-0.02007	0.16972	0.16766
18.6	0.13351	0.15334	-0.06756	-0.18966	-0.05481	0.14841	0.18247
18.8	0.10487	0.17031	-0.03240	-0.18755	-0.08731	0.12253	0.19159
19.0	0.07249	0.18065	+0.00357	-0.17877	-0.11648	0.09294	0.19474
19.2	0.03764	0.18403	0.03904	-0.16370	-0.14135	0.06063	0.19187
19.4	+0.00170	0.18039	0.07269	-0.14292	-0.16110	+0.02667	0.18309
19.6	-0.03395	0.16994	0.10331	-0.11723	-0.17508	-0.00783	0.16869
19.8	-0.06791	0.15313	0.12978	-0.08759	-0.18287	-0.04171	0.14916
20.0	-0.09890	0.13067	0.15117	-0.05509	-0.18422	-0.07387	0.12513
	$\begin{bmatrix} (-3)1 \\ 5 \end{bmatrix}$	$\begin{bmatrix} (-3)1 \\ 5 \end{bmatrix}$	$\begin{bmatrix} (-3)1 \\ 5 \end{bmatrix}$	$\begin{bmatrix} (-4)9 \\ 5 \end{bmatrix}$	$\begin{bmatrix} (-4)8 \\ 5 \end{bmatrix}$	$\begin{bmatrix} (-4)8 \\ 5 \end{bmatrix}$	$\begin{bmatrix} (-4)8 \\ 5 \end{bmatrix}$

BESSEL FUNCTIONS—ORDERS 3-9

Table 9.2

x	$Y_3(x)$	$Y_4(x)$	$Y_5(x)$	$Y_6(x)$	$Y_7(x)$	$Y_8(x)$	$Y_9(x)$
10.0	-0.25136	-0.14495	0.13540	0.28035	0.20102	0.00108	-0.19930
10.2	-0.23314	-0.18061	0.09148	0.27030	0.22652	0.04061	-0.16282
10.4	-0.20686	-0.20954	+0.04567	0.25346	0.24678	0.07874	-0.12563
10.6	-0.17359	-0.23087	-0.00065	0.23025	0.26131	0.11488	-0.08791
10.8	-0.13463	-0.24397	-0.04609	0.20130	0.26975	0.14838	-0.04793
11.0	-0.09148	-0.24851	-0.08925	0.16737	0.27184	0.17861	-0.01205
11.2	-0.04577	-0.24445	-0.12884	0.12941	0.26750	0.20496	+0.02530
11.4	+0.00082	-0.23203	-0.16365	0.08848	0.25678	0.22687	0.06163
11.6	0.04657	-0.21178	-0.19262	0.04573	0.23992	0.24384	0.09640
11.8	0.08981	-0.18450	-0.21489	+0.00238	0.21732	0.25545	0.12906
12.0	0.12901	-0.15122	-0.22982	-0.04030	0.18952	0.26140	0.15902
12.2	0.16277	-0.11317	-0.23698	-0.08107	0.15724	0.26151	0.18573
12.4	0.18994	-0.07175	-0.23623	-0.11875	0.12130	0.25571	0.20865
12.6	0.20959	-0.02845	-0.22766	-0.15223	0.08268	0.24409	0.22728
12.8	0.22112	+0.01518	-0.21163	-0.18052	0.04240	0.22689	0.24122
13.0	0.22420	0.05759	-0.18876	-0.20279	+0.00157	0.20448	0.25010
13.2	0.21883	0.09729	-0.15987	-0.21840	-0.03868	0.17738	0.25369
13.4	0.20534	0.13289	-0.12600	-0.22692	-0.07722	0.14625	0.25184
13.6	0.18432	0.16318	-0.08833	-0.22813	-0.11296	0.11185	0.24454
13.8	0.15666	0.18712	-0.04819	-0.22204	-0.14489	0.07505	0.23190
14.0	0.12350	0.20393	-0.00697	-0.20891	-0.17209	+0.03682	0.21417
14.2	0.08615	0.21308	+0.03390	-0.18921	-0.19380	-0.00186	0.19170
14.4	0.04605	0.21434	0.07303	-0.16363	-0.20939	-0.03994	0.16501
14.6	+0.00477	0.20775	0.10907	-0.13305	-0.21842	-0.07640	0.13470
14.8	-0.03613	0.19364	0.14080	-0.09850	-0.22067	-0.11024	0.10149
15.0	-0.07511	0.17261	0.16717	-0.06116	-0.21610	-0.14053	0.06620
15.2	-0.11072	0.14550	0.18730	-0.02228	-0.20489	-0.16644	+0.02969
15.4	-0.14165	0.11339	0.20055	+0.01684	-0.18743	-0.18723	-0.00710
15.6	-0.16678	0.07750	0.20652	0.05489	-0.16430	-0.20234	-0.04322
15.8	-0.18523	+0.03920	0.20507	0.09059	-0.13627	-0.21134	-0.07775
16.0	-0.19637	-0.00007	0.19633	0.12278	-0.10425	-0.21399	-0.10975
16.2	-0.19986	-0.03885	0.18067	0.15038	-0.06928	-0.21025	-0.13838
16.4	-0.19566	-0.07571	0.15873	0.17250	-0.03251	-0.20025	-0.16286
16.6	-0.18402	-0.10930	0.13135	0.18843	+0.00487	-0.18432	-0.18253
16.8	-0.16547	-0.13841	0.09956	0.19767	0.04164	-0.16297	-0.19685
17.0	-0.14078	-0.16200	0.06455	0.19996	0.07660	-0.13688	-0.20543
17.2	-0.11098	-0.17924	+0.02761	0.19529	0.10864	-0.10686	-0.20805
17.4	-0.07725	-0.18956	-0.00990	0.18387	0.13671	-0.07387	-0.20464
17.6	-0.04094	-0.19265	-0.04663	0.16616	0.15991	-0.03895	-0.19533
17.8	-0.00347	-0.18846	-0.08123	0.14282	0.17752	-0.00320	-0.18039
18.0	+0.03372	-0.17722	-0.11249	0.11472	0.18897	+0.03225	-0.16030
18.2	0.06920	-0.15942	-0.13928	0.08289	0.19393	0.06629	-0.13566
18.4	0.10163	-0.13580	-0.16067	0.04848	0.19229	0.09782	-0.10722
18.6	0.12977	-0.10731	-0.17593	+0.01272	0.18414	0.12587	-0.07586
18.8	0.15261	-0.07506	-0.18455	-0.02310	0.16980	0.14955	-0.04252
19.0	0.16930	-0.04031	-0.18628	-0.05773	0.14982	0.16812	-0.00824
19.2	0.17927	-0.00440	-0.18111	-0.08993	0.12490	0.18100	+0.02593
19.4	0.18221	+0.03131	-0.16930	-0.11857	0.09595	0.18782	0.05895
19.6	0.17805	0.06546	-0.15134	-0.14267	0.06399	0.18838	0.08979
19.8	0.16705	0.09678	-0.12794	-0.16139	+0.03013	0.18270	0.11750
20.0	0.14967	0.12409	-0.10004	-0.17411	-0.00443	0.17101	0.14124
	$\left[\begin{smallmatrix} (-3)1 \\ 5 \end{smallmatrix} \right]$	$\left[\begin{smallmatrix} (-3)1 \\ 5 \end{smallmatrix} \right]$	$\left[\begin{smallmatrix} (-3)1 \\ 5 \end{smallmatrix} \right]$	$\left[\begin{smallmatrix} (-4)9 \\ 5 \end{smallmatrix} \right]$	$\left[\begin{smallmatrix} (-4)9 \\ 5 \end{smallmatrix} \right]$	$\left[\begin{smallmatrix} (-4)8 \\ 5 \end{smallmatrix} \right]$	$\left[\begin{smallmatrix} (-4)8 \\ 5 \end{smallmatrix} \right]$

Table 9.3

BESSEL FUNCTIONS—ORDERS 10, 11, 20 AND 21

x	$10^{10}x^{-10}J_{10}(x)$	$10^{11}x^{-11}J_{11}(x)$	$10^{-9}x^{10}Y_{10}(x)$	$10^{25}x^{-20}J_{20}(x)$	$10^{27}x^{-21}J_{21}(x)$	$10^{-23}x^{20}Y_{20}(x)$
0.0	2.69114 446	1.22324 748	-0.11828 049	3.91990	9.33311	-0.406017
0.1	2.69053 290	1.22299 266	-0.11831 335	3.91944	9.33205	-0.406071
0.2	2.68869 898	1.22222 850	-0.11841 200	3.91804	9.32886	-0.406231
0.3	2.68564 500	1.22095 588	-0.11857 661	3.91571	9.32357	-0.406499
0.4	2.68137 477	1.21917 626	-0.11880 750	3.91244	9.31615	-0.406873
0.5	2.67589 362	1.21689 169	-0.11910 510	3.90825	9.30663	-0.407355
0.6	2.66920 838	1.21410 481	-0.11946 998	3.90314	9.29500	-0.407945
0.7	2.66132 738	1.21081 883	-0.11990 282	3.89710	9.28128	-0.408644
0.8	2.65226 043	1.20703 750	-0.12040 444	3.89015	9.26546	-0.409452
0.9	2.64201 878	1.20276 518	-0.12097 581	3.88228	9.24758	-0.410369
1.0	2.63061 512	1.19800 675	-0.12161 801	3.87350	9.22762	-0.411397
1.1	2.61806 358	1.19276 764	-0.12233 229	3.86383	9.20562	-0.412536
1.2	2.60437 963	1.18705 385	-0.12312 002	3.85325	9.18157	-0.413788
1.3	2.58958 012	1.18087 185	-0.12398 273	3.84179	9.15550	-0.415153
1.4	2.57368 323	1.17422 867	-0.12492 212	3.82945	9.12743	-0.416632
1.5	2.55670 842	1.16713 182	-0.12594 004	3.81624	9.09737	-0.418228
1.6	2.53867 639	1.15958 931	-0.12703 852	3.80216	9.06534	-0.419940
1.7	2.51960 907	1.15160 961	-0.12821 977	3.78723	9.03137	-0.421771
1.8	2.49952 955	1.14320 168	-0.12948 616	3.77146	8.99546	-0.423722
1.9	2.47846 207	1.13437 488	-0.13084 030	3.75485	8.95766	-0.425795
2.0	2.45643 192	1.12513 904	-0.13228 497	3.73742	8.91797	-0.427992
2.1	2.43346 545	1.11550 438	-0.13382 319	3.71918	8.87643	-0.430315
2.2	2.40959 000	1.10548 152	-0.13545 821	3.70015	8.83306	-0.432764
2.3	2.38483 384	1.09508 144	-0.13719 351	3.68032	8.78790	-0.435344
2.4	2.35922 612	1.08431 551	-0.13903 284	3.65973	8.74096	-0.438056
2.5	2.33279 682	1.07319 540	-0.14098 022	3.63837	8.69228	-0.440902
2.6	2.30557 673	1.06173 312	-0.14303 997	3.61627	8.64189	-0.443885
2.7	2.27759 732	1.04994 098	-0.14521 672	3.59344	8.58981	-0.447007
2.8	2.24889 074	1.03783 155	-0.14751 543	3.56989	8.53609	-0.450272
2.9	2.21948 976	1.02541 767	-0.14994 141	3.54564	8.48076	-0.453682
3.0	2.18942 770	1.01271 242	-0.15250 037	3.52071	8.42385	-0.457241
3.1	2.15873 836	0.99972 906	-0.15519 840	3.49510	8.36539	-0.460951
3.2	2.12745 598	0.98648 108	-0.15804 206	3.46885	8.30542	-0.464816
3.3	2.09561 517	0.97298 213	-0.16103 836	3.44195	8.24397	-0.468840
3.4	2.06325 085	0.95924 599	-0.16419 482	3.41444	8.18110	-0.473027
3.5	2.03039 820	0.94528 659	-0.16751 951	3.38633	8.11682	-0.477379
3.6	1.99709 260	0.93111 794	-0.17102 110	3.35763	8.05119	-0.481902
3.7	1.96336 956	0.91675 415	-0.17470 889	3.32837	7.98424	-0.486600
3.8	1.92926 467	0.90220 939	-0.17859 286	3.29855	7.91600	-0.491476
3.9	1.89481 352	0.88749 785	-0.18268 376	3.26821	7.84653	-0.496537
4.0	1.86005 168	0.87263 375	-0.18699 314	3.23736	7.77586	-0.501786
4.1	1.82501 462	0.85763 130	-0.19153 346	3.20601	7.70403	-0.507229
4.2	1.78973 765	0.84250 469	-0.19631 812	3.17419	7.63108	-0.512872
4.3	1.75425 588	0.82726 806	-0.20136 159	3.14192	7.55707	-0.518719
4.4	1.71860 416	0.81193 548	-0.20667 950	3.10921	7.48202	-0.524777
4.5	1.68281 701	0.79652 093	-0.21228 873	3.07608	7.40598	-0.531051
4.6	1.64692 860	0.78103 829	-0.21820 757	3.04256	7.32900	-0.537549
4.7	1.61097 267	0.76550 130	-0.22445 582	3.00866	7.25112	-0.544276
4.8	1.57498 249	0.74992 357	-0.23105 498	2.97440	7.17238	-0.551240
4.9	1.53899 084	0.73431 852	-0.23802 840	2.93981	7.09282	-0.558448
5.0	1.50302 991	0.71869 942	-0.24540 147	2.90490	7.01250	-0.565907
	$\begin{bmatrix} (-4)2 \\ 5 \end{bmatrix}$	$\begin{bmatrix} (-5)6 \\ 5 \end{bmatrix}$	$\begin{bmatrix} (-5)5 \\ 5 \end{bmatrix}$	$\begin{bmatrix} (-4)1 \\ 3 \end{bmatrix}$	$\begin{bmatrix} (-4)3 \\ 3 \end{bmatrix}$	$\begin{bmatrix} (-5)3 \\ 3 \end{bmatrix}$

$$J_{n+1}(x) = \frac{2n}{x} J_n(x) - J_{n-1}(x)$$

$$Y_{n+1}(x) = \frac{2n}{x} Y_n(x) - Y_{n-1}(x)$$

Compiled from British Association for the Advancement of Science, Bessel functions, Part II. Functions of positive integer order, Mathematical Tables, vol. X (Cambridge Univ. Press, Cambridge, England, 1952), L. Fox, A short table for Bessel functions of integer orders and large arguments. Royal Society Shorter Mathematical Tables No. 3 (Cambridge Univ. Press, Cambridge, England, 1954), and Mathematical Tables Project, Table of $f_n(x) = n!(\frac{1}{2}x)^{-n} J_n(x)$. J. Math. Phys. 23, 45-60 (1944) (with permission).

BESSEL FUNCTIONS—ORDERS 10, 11, 20 AND 21

Table 9.3

x	$10^{10}x^{-10}J_{10}(x)$	$10^{11}x^{-11}J_{11}(x)$	$10^{-9}x^{10}Y_{10}(x)$	$10^{25}x^{-20}J_{20}(x)$	$10^{27}x^{-21}J_{21}(x)$	$10^{-23}x^{20}Y_{20}(x)$
5.0	1.50302 991	0.71869 942	-0.24540 147	2.90490	7.01250	-0.565907
5.1	1.46713 132	0.70307 931	-0.25320 186	2.86969	6.93145	-0.573626
5.2	1.43132 603	0.68747 104	-0.26145 975	2.83421	6.84971	-0.581612
5.3	1.39564 431	0.67188 722	-0.27020 813	2.79846	6.76734	-0.589875
5.4	1.36011 571	0.65634 019	-0.27948 304	2.76248	6.68437	-0.598423
5.5	1.32476 904	0.64084 205	-0.28932 400	2.72628	6.60085	-0.607266
5.6	1.28963 229	0.62540 463	-0.29977 431	2.68988	6.51682	-0.616414
5.7	1.25473 264	0.61003 945	-0.31088 154	2.65330	6.43233	-0.625876
5.8	1.22009 642	0.59475 774	-0.32269 795	2.61656	6.34742	-0.635663
5.9	1.18574 907	0.57957 041	-0.33528 105	2.57967	6.26213	-0.645788
6.0	1.15171 513	0.56448 805	-0.34869 413	2.54267	6.17651	-0.656261
6.1	1.11801 822	0.54952 091	-0.36300 693	2.50556	6.09059	-0.667094
6.2	1.08468 098	0.53467 890	-0.37829 631	2.46837	6.00443	-0.678301
6.3	1.05172 510	0.51997 158	-0.39464 698	2.43111	5.91806	-0.689895
6.4	1.01917 129	0.50540 814	-0.41215 232	2.39381	5.83152	-0.701890
6.5	0.98703 926	0.49099 740	-0.43091 524	2.35647	5.74485	-0.714300
6.6	0.95534 769	0.47674 781	-0.45104 907	2.31913	5.65810	-0.727140
6.7	0.92411 427	0.46266 745	-0.47267 855	2.28179	5.57131	-0.740427
6.8	0.89335 563	0.44876 400	-0.49594 084	2.24448	5.48451	-0.754178
6.9	0.86308 740	0.43504 477	-0.52098 648	2.20721	5.39775	-0.768410
7.0	0.83332 414	0.42151 665	-0.54798 051	2.17000	5.31106	-0.783140
7.1	0.80407 941	0.40818 616	-0.57710 346	2.13286	5.22448	-0.798389
7.2	0.77536 570	0.39505 943	-0.60855 234	2.09582	5.13805	-0.814177
7.3	0.74719 450	0.38214 216	-0.64254 159	2.05888	5.05181	-0.830524
7.4	0.71957 626	0.36943 970	-0.67930 390	2.02206	4.96579	-0.847452
7.5	0.69252 040	0.35695 696	-0.71909 088	1.98539	4.88002	-0.864985
7.6	0.66603 536	0.34469 850	-0.76217 356	1.94887	4.79455	-0.883147
7.7	0.64012 854	0.33266 845	-0.80884 258	1.91252	4.70940	-0.901963
7.8	0.61480 640	0.32087 058	-0.85940 807	1.87635	4.62461	-0.921460
7.9	0.59007 439	0.30930 826	-0.91419 914	1.84038	4.54021	-0.941665
8.0	0.56593 704	0.29798 448	-0.97356 279	1.80462	4.45624	-0.962608
8.1	0.54239 791	0.28690 187	-1.03786 231	1.76908	4.37272	-0.984319
8.2	0.51945 967	0.27606 265	-1.10747 485	1.73378	4.28968	-1.006831
8.3	0.49712 408	0.26546 873	-1.18278 826	1.69874	4.20716	-1.030178
8.4	0.47539 201	0.25512 162	-1.26419 685	1.66395	4.12518	-1.054394
8.5	0.45426 352	0.24502 250	-1.35209 608	1.62944	4.04377	-1.079518
8.6	0.43373 779	0.23517 220	-1.44687 598	1.59521	3.96296	-1.105589
8.7	0.41381 323	0.22557 121	-1.54891 312	1.56128	3.88277	-1.132647
8.8	0.39448 748	0.21621 969	-1.65856 097	1.52765	3.80323	-1.160736
8.9	0.37575 740	0.20711 750	-1.77613 854	1.49434	3.72436	-1.189902
9.0	0.35761 917	0.19826 418	-1.90191 706	1.46136	3.64619	-1.220192
9.1	0.34006 823	0.18965 897	-2.03610 452	1.42872	3.56873	-1.251657
9.2	0.32309 939	0.18130 082	-2.17882 801	1.39641	3.49201	-1.284351
9.3	0.30670 683	0.17318 839	-2.33011 366	1.36447	3.41606	-1.318328
9.4	0.29088 411	0.16532 010	-2.48986 396	1.33288	3.34088	-1.353647
9.5	0.27562 422	0.15769 409	-2.65783 251	1.30166	3.26651	-1.390372
9.6	0.26091 963	0.15030 825	-2.83359 602	1.27082	3.19294	-1.428567
9.7	0.24676 227	0.14316 025	-3.01652 353	1.24036	3.12022	-1.468301
9.8	0.23314 362	0.13624 751	-3.20574 283	1.21029	3.04834	-1.509646
9.9	0.22005 470	0.12956 726	-3.40010 421	1.18061	2.97733	-1.552680
10.0	0.20748 611	0.12311 653	-3.59814 152	1.15134	2.90720	-1.597484
	$\begin{bmatrix} (-5)8 \\ 5 \end{bmatrix}$	$\begin{bmatrix} (-5)3 \\ 5 \end{bmatrix}$	$\begin{bmatrix} (-3)1 \\ 7 \end{bmatrix}$	$\begin{bmatrix} (-5)5 \\ 3 \end{bmatrix}$	$\begin{bmatrix} (-4)1 \\ 3 \end{bmatrix}$	$\begin{bmatrix} (-4)2 \\ 4 \end{bmatrix}$

Table 9.3

BESSEL FUNCTIONS—ORDERS 10, 11, 20 AND 21

x	$J_{10}(x)$	$J_{11}(x)$	$Y_{10}(x)$	$10^{25}x^{-20}J_{20}(x)$	$10^{27}x^{-21}J_{21}(x)$	$10^{-23}x^{20}Y_{20}(x)$
10.0	0.20748 611	0.12311 653	-0.35981 415	1.151337	2.907199	- 1.59748
10.1	0.21587 417	0.13041 285	-0.34383 078	1.122469	2.837961	- 1.64414
10.2	0.22413 707	0.13787 866	-0.32793 809	1.094012	2.769629	- 1.69275
10.3	0.23223 256	0.14549 509	-0.31207 433	1.065970	2.702215	- 1.74339
10.4	0.24011 699	0.15324 123	-0.29618 615	1.038347	2.635729	- 1.79618
10.5	0.24774 554	0.16109 407	-0.28022 819	1.011148	2.570182	- 1.85121
10.6	0.25507 240	0.16902 861	-0.26416 276	0.984374	2.505582	- 1.90861
10.7	0.26205 109	0.17701 780	-0.24795 949	0.958030	2.441939	- 1.96848
10.8	0.26863 466	0.18503 266	-0.23159 513	0.932118	2.379259	- 2.03097
10.9	0.27477 603	0.19304 230	-0.21505 324	0.906639	2.317550	- 2.09619
11.0	0.28042 823	0.20101 401	-0.19832 403	0.881596	2.256817	- 2.16430
11.1	0.28554 479	0.20891 340	-0.18140 409	0.856989	2.197065	- 2.23544
11.2	0.29007 999	0.21670 446	-0.16429 620	0.832821	2.138299	- 2.30977
11.3	0.29398 925	0.22434 974	-0.14700 917	0.809092	2.080523	- 2.38746
11.4	0.29722 944	0.23181 048	-0.12955 753	0.785801	2.023738	- 2.46870
11.5	0.29975 923	0.23904 680	-0.11196 142	0.762950	1.967947	- 2.55367
11.6	0.30153 946	0.24601 789	-0.09424 628	0.740539	1.913152	- 2.64257
11.7	0.30253 345	0.25268 218	-0.07644 263	0.718565	1.859352	- 2.73563
11.8	0.30270 737	0.25899 761	-0.05858 580	0.697029	1.806548	- 2.83307
11.9	0.30203 061	0.26492 183	-0.04071 566	0.675930	1.754740	- 2.93513
12.0	0.30047 604	0.27041 248	-0.02287 631	0.655266	1.703925	- 3.04208
12.1	0.29802 036	0.27542 744	-0.00511 577	0.635035	1.654102	- 3.15419
12.2	0.29464 445	0.27992 508	+0.01251 441	0.615236	1.605267	- 3.27175
12.3	0.29033 357	0.28386 459	0.02995 946	0.595866	1.557418	- 3.39509
12.4	0.28507 771	0.28720 623	0.04716 182	0.576923	1.510551	- 3.52453
12.5	0.27887 175	0.28991 166	0.06406 154	0.558403	1.464660	- 3.66044
12.6	0.27171 575	0.29194 422	0.08059 668	0.540305	1.419743	- 3.80321
12.7	0.26361 509	0.29326 923	0.09670 381	0.522625	1.375791	- 3.95323
12.8	0.25458 064	0.29385 431	0.11231 845	0.505359	1.332800	- 4.11095
12.9	0.24462 889	0.29366 968	0.12737 554	0.488504	1.290762	- 4.27684
13.0	0.23378 201	0.29268 843	0.14180 995	0.472056	1.249671	- 4.45140
13.1	0.22206 793	0.29088 684	0.15555 698	0.456011	1.209520	- 4.63518
13.2	0.20952 032	0.28824 464	0.16855 286	0.440365	1.170299	- 4.82874
13.3	0.19617 859	0.28474 526	0.18073 529	0.425114	1.132001	- 5.03272
13.4	0.18208 776	0.28037 612	0.19204 392	0.410252	1.094617	- 5.24778
13.5	0.16729 840	0.27512 884	0.20242 090	0.395776	1.058137	- 5.47464
13.6	0.15186 646	0.26899 942	0.21181 137	0.381681	1.022552	- 5.71407
13.7	0.13585 302	0.26198 851	0.22016 393	0.367961	0.987853	- 5.96691
13.8	0.11932 411	0.25410 149	0.22743 118	0.354612	0.954028	- 6.23405
13.9	0.10235 036	0.24534 866	0.23357 014	0.341628	0.921067	- 6.51646
14.0	0.08500 671	0.23574 535	0.23854 273	0.329005	0.888960	- 6.81520
14.1	0.06737 200	0.22531 197	0.24231 614	0.316736	0.857694	- 7.13138
14.2	0.04952 862	0.21407 407	0.24486 329	0.304816	0.827260	- 7.46624
14.3	0.03156 199	0.20206 238	0.24616 313	0.293240	0.797644	- 7.82110
14.4	+0.01356 013	0.18931 275	0.24620 100	0.282001	0.768835	- 8.19739
14.5	-0.00438 689	0.17586 611	0.24496 888	0.271095	0.740821	- 8.59667
14.6	-0.02218 745	0.16176 836	0.24246 568	0.260516	0.713590	- 9.02062
14.7	-0.03974 898	0.14707 028	0.23869 741	0.250257	0.687129	- 9.47109
14.8	-0.05697 854	0.13182 729	0.23367 730	0.240312	0.661426	- 9.95006
14.9	-0.07378 344	0.11609 931	0.22742 597	0.230676	0.636467	-10.45971
15.0	-0.09007 181 $\left[\begin{smallmatrix} (-4)1 \\ 6 \end{smallmatrix} \right]$	0.09995 048 $\left[\begin{smallmatrix} (-4)1 \\ 5 \end{smallmatrix} \right]$	0.21997 141 $\left[\begin{smallmatrix} (-4)2 \\ 6 \end{smallmatrix} \right]$	0.221343 $\left[\begin{smallmatrix} (-5)6 \\ 3 \end{smallmatrix} \right]$	0.612240 $\left[\begin{smallmatrix} (-4)1 \\ 4 \end{smallmatrix} \right]$	-11.00239 $\left[\begin{smallmatrix} (-3)4 \\ 4 \end{smallmatrix} \right]$

BESSEL FUNCTIONS—ORDERS 10, 11, 20 AND 21

Table 9.3

x	$J_{10}(x)$	$J_{11}(x)$	$Y_{10}(x)$	$10^{25}x^{-20}J_{20}(x)$	$10^{27}x^{-21}J_{21}(x)$	$10^{-23}x^{20}Y_{20}(x)$
15.0	-0.09007 181	0.09995 048	0.21997 141	0.22134 33	0.61224 04	- 11.0024
15.1	-0.10575 330	0.08344 886	0.21134 904	0.21230 71	0.58873 25	- 11.5807
15.2	-0.12073 964	0.06666 618	0.20160 159	0.20356 16	0.56593 06	- 12.1974
15.3	-0.13494 535	0.04967 738	0.19077 902	0.19510 08	0.54382 12	- 12.8555
15.4	-0.14828 828	0.03256 035	0.17893 834	0.18691 87	0.52239 14	- 13.5585
15.5	-0.16069 032	+0.01539 539	0.16614 338	0.17900 91	0.50162 76	- 14.3098
15.6	-0.17207 791	-0.00173 513	0.15246 453	0.17136 62	0.48151 66	- 15.1136
15.7	-0.18238 269	-0.01874 731	0.13797 838	0.16398 38	0.46204 52	- 15.9742
15.8	-0.19154 204	-0.03555 621	0.12276 733	0.15685 60	0.44319 99	- 16.8962
15.9	-0.19949 958	-0.05207 632	0.10691 918	0.14997 67	0.42496 74	- 17.8849
16.0	-0.20620 569	-0.06822 215	0.09052 660	0.14334 00	0.40733 43	- 18.9460
16.1	-0.21161 797	-0.08390 874	0.07368 666	0.13694 00	0.39028 75	- 20.0855
16.2	-0.21570 160	-0.09905 224	0.05650 016	0.13077 08	0.37381 35	- 21.3104
16.3	-0.21842 977	-0.11357 046	0.03907 110	0.12482 65	0.35789 93	- 22.6279
16.4	-0.21978 394	-0.12738 344	0.02150 600	0.11910 14	0.34253 16	- 24.0462
16.5	-0.21975 411	-0.14041 403	+0.00391 319	0.11358 96	0.32769 75	- 25.5740
16.6	-0.21833 905	-0.15258 841	-0.01359 786	0.10828 55	0.31338 39	- 27.2209
16.7	-0.21554 637	-0.16383 668	-0.03091 729	0.10318 34	0.29957 78	- 28.9975
16.8	-0.21139 267	-0.17409 338	-0.04793 557	0.09827 77	0.28626 66	- 30.9150
16.9	-0.20590 350	-0.18329 797	-0.06454 431	0.09356 30	0.27343 76	- 32.9859
17.0	-0.19911 332	-0.19139 539	-0.08063 696	0.08903 37	0.26107 81	- 35.2237
17.1	-0.19106 538	-0.19833 646	-0.09610 960	0.08468 45	0.24917 57	- 37.6429
17.2	-0.18181 155	-0.20407 831	-0.11086 170	0.08051 02	0.23771 82	- 40.2594
17.3	-0.17141 203	-0.20858 485	-0.12479 683	0.07650 53	0.22669 32	- 43.0904
17.4	-0.15993 505	-0.21182 701	-0.13782 343	0.07266 49	0.21608 89	- 46.1543
17.5	-0.14745 649	-0.21378 318	-0.14985 544	0.06898 37	0.20589 33	- 49.4711
17.6	-0.13405 943	-0.21443 935	-0.16081 304	0.06545 69	0.19609 48	- 53.0622
17.7	-0.11983 363	-0.21378 944	-0.17062 321	0.06207 96	0.18668 17	- 56.9506
17.8	-0.10487 499	-0.21183 538	-0.17922 038	0.05884 68	0.17764 27	- 61.1611
17.9	-0.08928 492	-0.20858 727	-0.18654 691	0.05575 39	0.16896 66	- 65.7197
18.0	-0.07316 966	-0.20406 341	-0.19255 365	0.05279 63	0.16064 24	- 70.6543
18.1	-0.05663 961	-0.19829 032	-0.19720 030	0.04996 93	0.15265 91	- 75.9946
18.2	-0.03980 852	-0.19130 265	-0.20045 582	0.04726 85	0.14500 62	- 81.7717
18.3	-0.02279 278	-0.18314 307	-0.20229 875	0.04468 96	0.13767 32	- 88.0182
18.4	-0.00571 052	-0.17386 213	-0.20271 742	0.04222 83	0.13064 97	- 94.7683
18.5	+0.01131 917	-0.16351 793	-0.20171 011	0.03988 04	0.12392 57	-102.0574
18.6	0.02817 711	-0.15217 591	-0.19928 520	0.03764 17	0.11749 14	-109.9219
18.7	0.04474 490	-0.13990 845	-0.19546 113	0.03550 84	0.11133 69	-118.3992
18.8	0.06090 579	-0.12679 446	-0.19026 637	0.03347 64	0.10545 28	-127.5270
18.9	0.07654 556	-0.11291 893	-0.18373 930	0.03154 21	0.09982 98	-137.3432
19.0	0.09155 333	-0.09837 240	-0.17592 797	0.02970 16	0.09445 89	-147.8850
19.1	0.10582 247	-0.08325 039	-0.16688 985	0.02795 15	0.08933 10	-159.1885
19.2	0.11925 134	-0.06765 283	-0.15669 143	0.02628 80	0.08443 76	-171.2882
19.3	0.13174 416	-0.05168 334	-0.14540 785	0.02470 79	0.07977 01	-184.2155
19.4	0.14321 168	-0.03544 863	-0.13312 231	0.02320 78	0.07532 03	-197.9980
19.5	0.15357 193	-0.01905 771	-0.11992 560	0.02178 44	0.07108 01	-212.6582
19.6	0.16275 089	-0.00262 120	-0.10591 538	0.02043 46	0.06704 16	-228.2122
19.7	0.17068 305	+0.01374 948	-0.09119 555	0.01915 54	0.06319 71	-244.6678
19.8	0.17731 198	0.02994 285	-0.07587 548	0.01794 37	0.05953 92	-262.0226
19.9	0.18259 079	0.04584 818	-0.06006 922	0.01679 67	0.05606 06	-280.2622
20.0	0.18648 256 $\left[\begin{smallmatrix} (-4)2 \\ 6 \end{smallmatrix} \right]$	0.06135 630 $\left[\begin{smallmatrix} (-4)2 \\ 6 \end{smallmatrix} \right]$	-0.04389 465 $\left[\begin{smallmatrix} (-4)2 \\ 6 \end{smallmatrix} \right]$	0.01571 16 $\left[\begin{smallmatrix} (-5)4 \\ 4 \end{smallmatrix} \right]$	0.05275 42 $\left[\begin{smallmatrix} (-5)9 \\ 4 \end{smallmatrix} \right]$	-299.3574 $\left[\begin{smallmatrix} (-1)1 \\ 5 \end{smallmatrix} \right]$

Table 9.3
BESSEL FUNCTIONS—MODULUS AND PHASE OF ORDERS 10, 11, 20 AND 21

$J_n(x) = M_n(x) \cos \theta_n(x)$			$Y_n(x) = M_n(x) \sin \theta_n(x)$		
x^{-1}	$x^{\frac{1}{2}}M_{10}(x)$	$\theta_{10}(x)-x$	$x^{\frac{1}{2}}M_{11}(x)$	$\theta_{11}(x)-x$	$\langle x \rangle$
0.050	0.85676 701	-13.94798 864	0.87222 790	-14.96758 686	20
0.048	0.85136 682	-14.05389 581	0.86513 271	-15.09771 672	21
0.046	0.84633 336	-14.15926 984	0.85857 314	-15.22701 466	22
0.044	0.84164 245	-14.26413 968	0.85250 587	-15.35552 901	23
0.042	0.83727 251	-14.36853 333	0.84689 281	-15.48330 635	24
0.040	0.83320 419	-14.47247 807	0.84170 044	-15.61039 144	25
0.038	0.82942 012	-14.57600 035	0.83689 917	-15.73682 771	26
0.036	0.82590 472	-14.67912 589	0.83246 283	-15.86265 679	28
0.034	0.82264 403	-14.78187 967	0.82836 826	-15.98791 896	29
0.032	0.81962 546	-14.88428 611	0.82459 496	-16.11265 291	31
0.030	0.81683 775	-14.98636 880	0.82112 469	-16.23689 620	33
0.028	0.81427 076	-15.08815 085	0.81794 133	-16.36068 504	36
0.026	0.81191 546	-15.18965 477	0.81503 056	-16.48405 469	38
0.024	0.80976 370	-15.29090 253	0.81237 970	-16.60703 912	42
0.022	0.80780 825	-15.39191 569	0.80997 751	-16.72967 149	45
0.020	0.80604 267	-15.49271 527	0.80781 410	-16.85198 406	50
0.018	0.80446 127	-15.59332 192	0.80588 079	-16.97400 835	56
0.016	0.80305 902	-15.69375 598	0.80416 997	-17.09577 505	63
0.014	0.80183 156	-15.79403 741	0.80267 505	-17.21731 438	71
0.012	0.80077 512	-15.89418 589	0.80139 036	-17.33865 590	83
0.010	0.79988 647	-15.99422 093	0.80031 114	-17.45982 880	100
0.008	0.79916 297	-16.09416 168	0.79943 341	-17.58086 166	125
0.006	0.79860 244	-16.19402 726	0.79875 398	-17.70178 301	167
0.004	0.79820 323	-16.29383 652	0.79827 039	-17.82262 084	250
0.002	0.79796 417	-16.39360 832	0.79798 093	-17.94340 316	500
0.000	0.79788 456 $\left[\begin{smallmatrix} (-5)5 \\ 5 \end{smallmatrix} \right]$	-16.49336 143 $\left[\begin{smallmatrix} (-5)7 \\ 5 \end{smallmatrix} \right]$	0.79788 456 $\left[\begin{smallmatrix} (-5)7 \\ 6 \end{smallmatrix} \right]$	-18.06415 776 $\left[\begin{smallmatrix} (-4)1 \\ 6 \end{smallmatrix} \right]$	∞
x^{-1}	$x^{\frac{1}{2}}M_{20}(x)$	$\theta_{20}(x)-x$	$x^{\frac{1}{2}}M_{21}(x)$	$\theta_{21}(x)-x$	$\langle x \rangle$
0.050	1.474083	-21.047407	1.791133	-21.290925	20
0.048	1.320938	-21.606130	1.525581	-21.927545	21
0.046	1.211667	-22.149524	1.347435	-22.550082	22
0.044	1.131459	-22.676802	1.224460	-23.154248	23
0.042	1.070845	-23.188535	1.136653	-23.738936	24
0.040	1.023762	-23.685951	1.071741	-24.304948	25
0.038	0.986284	-24.170500	1.022171	-24.853951	26
0.036	0.955823	-24.643620	0.983229	-25.387848	28
0.034	0.930635	-25.106640	0.951902	-25.908478	29
0.032	0.909513	-25.560748	0.926211	-26.417500	31
0.030	0.891605	-26.006988	0.904821	-26.916369	33
0.028	0.876293	-26.446280	0.886799	-27.406346	36
0.026	0.863121	-26.879433	0.871483	-27.888527	38
0.024	0.851743	-27.307159	0.858385	-28.363869	42
0.022	0.841895	-27.730098	0.847145	-28.833211	45
0.020	0.833375	-28.148822	0.837487	-29.297299	50
0.018	0.826019	-28.563847	0.829198	-29.756800	56
0.016	0.819702	-28.975650	0.822114	-30.212318	63
0.014	0.814321	-29.384666	0.816105	-30.664405	71
0.012	0.809796	-29.791303	0.811069	-31.113569	83
0.010	0.806062	-30.195941	0.806925	-31.560285	100
0.008	0.803071	-30.598942	0.803612	-32.005000	125
0.006	0.800781	-31.000652	0.801081	-32.448139	167
0.004	0.799165	-31.401404	0.799297	-32.890109	250
0.002	0.798204	-31.801522	0.798237	-33.331307	500
0.000	0.797885 $\left[\begin{smallmatrix} (-3)5 \\ 7 \end{smallmatrix} \right]$	-32.201325 $\left[\begin{smallmatrix} (-3)2 \\ 7 \end{smallmatrix} \right]$	0.797885 $\left[\begin{smallmatrix} (-2)1 \\ 8 \end{smallmatrix} \right]$	-33.772121 $\left[\begin{smallmatrix} (-3)2 \\ 7 \end{smallmatrix} \right]$	∞

$\langle x \rangle$ = nearest integer to x .

Compiled from L. Fox, A short table for Bessel functions of integer orders and large arguments. Royal Society Shorter Mathematical Tables No. 3 (Cambridge Univ. Press, Cambridge, England, 1954) (with permission).

BESSEL FUNCTIONS—VARIOUS ORDERS

Table 9.4

n	$J_n(1)$	$J_n(2)$	$J_n(5)$
0	(- 1) 7.65197 6866	(- 1) 2.23890 7791	(- 1) -1.77596 7713
1	(- 1) 4.40050 5857	(- 1) 5.76724 8078	(- 1) -3.27579 1376
2	(- 1) 1.14903 4849	(- 1) 3.52834 0286	(- 2) +4.65651 1628
3	(- 2) 1.95633 5398	(- 1) 1.28943 2495	(- 1) 3.64831 2306
4	(- 3) 2.47663 8964	(- 2) 3.39957 1981	(- 1) 3.91232 3605
5	(- 4) 2.49757 7302	(- 3) 7.03962 9756	(- 1) 2.61140 5461
6	(- 5) 2.09383 3800	(- 3) 1.20242 8972	(- 1) 1.31048 7318
7	(- 6) 1.50232 5817	(- 4) 1.74944 0749	(- 2) 5.33764 1016
8	(- 8) 9.42234 4173	(- 5) 2.21795 5229	(- 2) 1.84052 1665
9	(- 9) 5.24925 0180	(- 6) 2.49234 3435	(- 3) 5.52028 3139
10	(- 10) 2.63061 5124	(- 7) 2.51538 6283	(- 3) 1.46780 2647
11	(- 11) 1.19800 6746	(- 8) 2.30428 4758	(- 4) 3.50927 4498
12	(- 13) 4.99971 8179	(- 9) 1.93269 5149	(- 5) 7.62781 3166
13	(- 14) 1.92561 6764	(- 10) 1.49494 2010	(- 5) 1.52075 8221
14	(- 16) 6.88540 8200	(- 11) 1.07294 6448	(- 6) 2.80129 5810
15	(- 17) 2.29753 1532	(- 13) 7.18301 6356	(- 7) 4.79674 3278
16	(- 19) 7.18639 6587	(- 14) 4.50600 5896	(- 8) 7.67501 5694
17	(- 20) 2.11537 5568	(- 15) 2.65930 7805	(- 8) 1.15266 7666
18	(- 22) 5.88034 4574	(- 16) 1.48173 7249	(- 9) 1.63124 4339
19	(- 23) 1.54847 8441	(- 18) 7.81924 3273	(- 10) 2.18282 5842
20	(- 25) 3.87350 3009	(- 19) 3.91897 2805	(- 11) 2.77033 0052
30	(- 42) 3.48286 9794	(- 33) 3.65025 6266	(- 21) 2.67117 7278
40	(- 60) 1.10791 5851	(- 48) 1.19607 7458	(- 33) 8.70224 1617
50	(- 80) 2.90600 4948	(- 65) 3.22409 5839	(- 45) 2.29424 7616
100	(-189) 8.43182 8790	(-158) 1.06095 3112	(-119) 6.26778 9396

n	$J_n(10)$	$J_n(50)$	$J_n(100)$
0	(- 1) -2.45935 7645	(- 2) +5.58123 2767	(-2) +1.99858 5030
1	(- 2) +4.34727 4617	(- 2) -9.75118 2813	(-2) -7.71453 5201
2	(- 1) +2.54630 3137	(- 2) -5.97128 0079	(-2) -2.15287 5734
3	(- 2) +5.83793 7931	(- 2) +9.27348 0406	(-2) +7.62842 0172
4	(- 1) -2.19602 6861	(- 2) +7.08409 7728	(-2) +2.61058 0945
5	(- 1) -2.34061 5282	(- 2) -8.14002 4770	(-2) -7.41957 3696
6	(- 2) -1.44588 4208	(- 2) -8.71210 2682	(-2) -3.35253 8314
7	(- 1) +2.16710 9177	(- 2) +6.04912 0126	(-2) +7.01726 9099
8	(- 1) 3.17854 1268	(- 1) +1.04058 5632	(-2) +4.33495 5988
9	(- 1) 2.91855 6853	(- 2) -2.71924 6104	(-2) -6.32367 6141
10	(- 1) 2.07486 1066	(- 1) -1.13847 8491	(-2) -5.47321 7694
11	(- 1) 1.23116 5280	(- 2) -1.83466 7862	(-2) +5.22903 2602
12	(- 2) 6.33702 5497	(- 1) +1.05775 3106	(-2) +6.62360 4866
13	(- 2) 2.89720 8393	(- 2) +6.91188 2768	(-2) -3.63936 7434
14	(- 2) 1.19571 6324	(- 2) -6.98335 2016	(-2) -7.56984 0399
15	(- 3) 4.50797 3144	(- 1) -1.08225 5990	(-2) +1.51981 2122
16	(- 3) 1.56675 6192	(- 3) +4.89816 0778	(-2) +8.02578 4036
17	(- 4) 5.05646 6697	(- 1) +1.11360 4219	(-2) +1.04843 8769
18	(- 4) 1.52442 4853	(- 2) +7.08269 2610	(-2) -7.66931 4854
19	(- 5) 4.31462 7752	(- 2) -6.03650 3508	(-2) -3.80939 2116
20	(- 5) 1.15133 6925	(- 1) -1.16704 3528	(-2) +6.22174 5850
30	(-12) 1.55109 6078	(- 2) +4.84342 5725	(-2) +8.14601 2958
40	(-21) 6.03089 5312	(- 1) -1.38176 2812	(-2) +7.27017 5482
50	(-30) 1.78451 3608	(- 1) +1.21409 0219	(-2) -3.86983 3973
100	(-89) 6.59731 6064	(-21) +1.11592 7368	(-2) +9.63666 7330

Table 9.4

BESSEL FUNCTIONS—VARIOUS ORDERS

n	$Y_n(1)$	$Y_n(2)$	$Y_n(5)$
0	(- 2)+8. 82569 6420	(- 1)+5. 10375 6726	(- 1)-3. 08517 6252
1	(- 1)-7. 81212 8213	(- 1)-1. 07032 4315	(- 1)+1. 47863 1434
2	(0)-1. 65068 2607	(- 1)-6. 17408 1042	(- 1)+3. 67662 8826
3	(0)-5. 82151 7606	(0)-1. 12778 3777	(- 1)+1. 46267 1627
4	(1)-3. 32784 2303	(0)-2. 76594 3226	(- 1)-1. 92142 2874
5	(2)-2. 60405 8666	(0)-9. 93598 9128	(- 1)-4. 53694 8225
6	(3)-2. 57078 0243	(1)-4. 69140 0242	(- 1)-7. 15247 3576
7	(4)-3. 05889 5705	(2)-2. 71548 0254	(0)-1. 26289 8836
8	(5)-4. 25674 6185	(3)-1. 85392 2175	(0)-2. 82086 9383
9	(6)-6. 78020 4939	(4)-1. 45598 2938	(0)-7. 76388 3188
10	(8)-1. 21618 0143	(5)-1. 29184 5422	(1)-2. 51291 1010
11	(9)-2. 42558 0081	(6)-1. 27728 5593	(1)-9. 27525 5719
12	(10)-5. 32411 4376	(7)-1. 39209 5698	(2)-3. 82982 1416
13	(12)-1. 27536 1870	(8)-1. 65774 1981	(3)-1. 74556 1722
14	(13)-3. 31061 6748	(9)-2. 14114 3619	(3)-8. 69393 8814
15	(14)-9. 25697 3276	(10)-2. 98102 3646	(4)-4. 69404 9564
16	(16)-2. 77378 1366	(11)-4. 45012 4034	(5)-2. 72949 0350
17	(17)-8. 86684 3398	(12)-7. 09038 8217	(6)-1. 69993 3328
18	(19)-3. 01195 2974	(14)-1. 20091 5873	(7)-1. 12865 9760
19	(21)-1. 08341 6386	(15)-2. 15455 8183	(7)-7. 95635 6938
20	(22)-4. 11397 0315	(16)-4. 08165 1389	(8)-5. 93396 5297
30	(39)-3. 04812 8783	(30)-2. 91322 3848	(18)-4. 02856 8418
40	(57)-7. 18487 4797	(45)-6. 66154 1235	(29)-9. 21681 6571
50	(77)-2. 19114 2813	(62)-1. 97615 0576	(42)-2. 78883 7017
100	(185)-3. 77528 7810	(155)-3. 00082 6049	(115)-5. 08486 3915
n	$Y_n(10)$	$Y_n(50)$	$Y_n(100)$
0	(-2)+5. 56711 6730	(- 2)-9. 80649 9547	(-2)-7. 72443 1337
1	(-1)+2. 49015 4242	(- 2)-5. 67956 6856	(-2)-2. 03723 1200
2	(-3)-5. 86808 2460	(- 2)+9. 57931 6873	(-2)+7. 68368 6713
3	(-1)-2. 51362 6572	(- 2)+6. 44591 2206	(-2)+2. 34457 8669
4	(-1)-1. 44949 5119	(- 2)-8. 80580 7408	(-2)-7. 54301 1992
5	(-1)+1. 35403 0477	(- 2)-7. 85484 1391	(-2)-2. 94801 9628
6	(-1)+2. 80352 5596	(- 2)+7. 23483 9130	(-2)+7. 24821 0030
7	(-1)+2. 01020 0238	(- 2)+9. 59120 2782	(-2)+3. 81780 4832
8	(-3)+1. 07547 3712	(- 2)-4. 54930 2351	(-2)-6. 71371 7353
9	(-1)-1. 99299 2658	(- 1)-1. 10469 7953	(-2)-4. 89199 9608
10	(-1)-3. 59814 1522	(- 3)+5. 72389 7182	(-2)+5. 83315 7424
11	(-1)-5. 20329 0386	(- 1)+1. 12759 3542	(-2)+6. 05863 1093
12	(-1)-7. 84909 7327	(- 2)+4. 38902 1867	(-2)-4. 50025 8583
13	(0)-1. 36345 4320	(- 2)-9. 16920 4926	(-2)-7. 13869 3153
14	(0)-2. 76007 1499	(- 2)-9. 15700 8429	(-2)+2. 64419 8363
15	(0)-6. 36474 5877	(- 2)+4. 04128 0205	(-2)+7. 87906 8695
16	(1)-1. 63341 6613	(- 1)+1. 15817 7655	(-3)-2. 80477 7550
17	(1)-4. 59045 8575	(- 2)+3. 37105 6788	(-2)-7. 96882 1576
18	(2)-1. 39741 4254	(- 2)-9. 28945 7936	(-2)-2. 42892 1581
19	(2)-4. 57164 5457	(- 1)-1. 00594 6650	(-2)+7. 09440 9807
20	(3)-1. 59748 3848	(- 2)+1. 64426 3395	(-2)+5. 12479 7308
30	(9)-7. 25614 2316	(- 1)-1. 16457 2349	(-3)+6. 13883 9212
40	(18)-1. 36280 3297	(- 2)-4. 53080 1120	(-2)+4. 07468 5217
50	(27)-3. 64106 6502	(- 1)-2. 10316 5546	(-2)+7. 65052 6394
100	(85)-4. 84914 8271	(+18)-3. 29380 0188	(-1)-1. 66921 4114

Table 9.5
ZEROS AND ASSOCIATED VALUES OF BESSEL FUNCTIONS AND THEIR DERIVATIVES

s	$j_{0,s}$	$J'_0(j_{0,s})$	$j_{1,s}$	$J'_1(j_{1,s})$	$j_{2,s}$	$J'_2(j_{2,s})$
1	2.40482 55577	-0.51914 74973	3.83171	-0.40276	5.13562	-0.33967
2	5.52007 81103	+0.34026 48065	7.01559	+0.30012	8.41724	+0.27138
3	8.65372 79129	-0.27145 22999	10.17347	-0.24970	11.61984	-0.23244
4	11.79153 44391	+0.23245 98314	13.32369	+0.21836	14.79595	+0.20654
5	14.93091 77086	-0.20654 64331	16.47063	-0.19647	17.95982	-0.18773
6	18.07106 39679	+0.18772 88030	19.61586	+0.18006	21.11700	+0.17326
7	21.21163 66299	-0.17326 58942	22.76008	-0.16718	24.27011	-0.16170
8	24.35247 15308	+0.16170 15507	25.90367	+0.15672	27.42057	+0.15218
9	27.49347 91320	-0.15218 12138	29.04683	-0.14801	30.56920	-0.14417
10	30.63460 64684	+0.14416 59777	32.18968	+0.14061	33.71652	+0.13730
11	33.77582 02136	-0.13729 69434	35.33231	-0.13421	36.86286	-0.13132
12	36.91709 83537	+0.13132 46267	38.47477	+0.12862	40.00845	+0.12607
13	40.05842 57646	-0.12606 94971	41.61709	-0.12367	43.15345	-0.12140
14	43.19979 17132	+0.12139 86248	44.75932	+0.11925	46.29800	+0.11721
15	46.34118 83717	-0.11721 11989	47.90146	-0.11527	49.44216	-0.11343
16	49.48260 98974	+0.11342 91926	51.04354	+0.11167	52.58602	+0.10999
17	52.62405 18411	-0.10999 11430	54.18555	-0.10839	55.72963	-0.10685
18	55.76551 07550	+0.10684 78883	57.32753	+0.10537	58.87302	+0.10396
19	58.90698 39261	-0.10395 95729	60.46946	-0.10260	62.01622	-0.10129
20	62.04846 91902	+0.10129 34989	63.61136	+0.10004	65.15927	+0.09882
s	$j_{3,s}$	$J'_3(j_{3,s})$	$j_{4,s}$	$J'_4(j_{4,s})$	$j_{5,s}$	$J'_5(j_{5,s})$
1	6.38016	-0.29827	7.58834	-0.26336	8.77148	-0.24543
2	9.76102	+0.24942	11.06471	+0.23188	12.33860	+0.21743
3	13.01520	-0.21828	14.37254	-0.20636	15.70017	-0.19615
4	16.22347	+0.19644	17.61597	+0.18766	18.98013	+0.17993
5	19.40942	-0.18005	20.82693	-0.17323	22.21780	-0.16712
6	22.58273	+0.16718	24.01902	+0.16168	25.43034	+0.15669
7	25.74817	-0.15672	27.19909	-0.15217	28.62662	-0.14799
8	28.90835	+0.14801	30.37101	+0.14416	31.81172	+0.14059
9	32.06485	-0.14060	33.53714	-0.13729	34.98878	-0.13420
10	35.21867	+0.13421	36.69900	+0.13132	38.15987	+0.12861
11	38.37047	-0.12862	39.85763	-0.12607	41.32638	-0.12366
12	41.52072	+0.12367	43.01374	+0.12140	44.48932	+0.11925
13	44.66974	-0.11925	46.16785	-0.11721	47.64940	-0.11527
14	47.81779	+0.11527	49.32036	+0.11343	50.80717	+0.11167
15	50.96503	-0.11167	52.47155	-0.10999	53.96303	-0.10838
16	54.11162	+0.10839	55.62165	+0.10685	57.11730	+0.10537
17	57.25765	-0.10537	58.77084	-0.10396	60.27025	-0.10260
18	60.40322	+0.10260	61.91925	+0.10129	63.42205	+0.10003
19	63.54840	-0.10004	65.06700	-0.09882	66.57289	-0.09765
20	66.69324	+0.09765	68.21417	+0.09652	69.72289	+0.09543
s	$j_{6,s}$	$J'_6(j_{6,s})$	$j_{7,s}$	$J'_7(j_{7,s})$	$j_{8,s}$	$J'_8(j_{8,s})$
1	9.93611	-0.22713	11.08637	-0.21209	12.22509	-0.19944
2	13.58929	+0.20525	14.82127	+0.19479	16.03777	+0.18569
3	17.00382	-0.18726	18.28758	-0.17942	19.55454	-0.17244
4	20.32079	+0.17305	21.64154	+0.16688	22.94517	+0.16130
5	23.58608	-0.16159	24.93493	-0.15657	26.26681	-0.15196
6	26.82015	+0.15212	28.19119	+0.14792	29.54566	+0.14404
7	30.03372	-0.14413	31.42279	-0.14055	32.79580	-0.13722
8	33.23304	+0.13727	34.63709	+0.13418	36.02562	+0.13127
9	36.42202	-0.13131	37.83872	-0.12859	39.24045	-0.12603
10	39.60324	+0.12606	41.03077	+0.12365	42.44389	+0.12137
11	42.77848	-0.12139	44.21541	-0.11924	45.63844	-0.11719
12	45.94902	+0.11721	47.39417	+0.11526	48.82593	+0.11342
13	49.11577	-0.11343	50.56818	-0.11166	52.00769	-0.10998
14	52.27945	+0.10999	53.73833	+0.10838	55.18475	+0.10684
15	55.44059	-0.10685	56.90525	-0.10537	58.35789	-0.10395
16	58.59961	+0.10396	60.06948	+0.10260	61.52774	+0.10129
17	61.75682	-0.10129	63.23142	-0.10003	64.69478	-0.09882
18	64.91251	+0.09882	66.39141	+0.09765	67.85943	+0.09652
19	68.06689	-0.09652	69.54971	-0.09543	71.02200	-0.09438
20	71.22013	+0.09438	72.70655	+0.09336	74.18277	+0.09237

Table 9.5
ZEROS AND ASSOCIATED VALUES OF BESSEL FUNCTIONS AND THEIR DERIVATIVES

s	$y_{0,s}$	$Y'_{0}(y_{0,s})$	$y_{1,s}$	$Y'_{1}(y_{1,s})$	$y_{2,s}$	$Y'_{2}(y_{2,s})$
1	0.89357 697	+0.87942 080	2.19714	+0.52079	3.38424	+0.39921
2	3.95767 842	-0.40254 267	5.42968	-0.34032	6.79381	-0.29992
3	7.08605 106	+0.30009 761	8.59601	+0.27146	10.02348	+0.24967
4	10.22234 504	-0.24970 124	11.74915	-0.23246	13.20999	-0.21835
5	13.36109 747	+0.21835 830	14.89744	+0.20655	16.37897	+0.19646
6	16.50092 244	-0.19646 494	18.04340	-0.18773	19.53904	-0.18006
7	19.64130 970	+0.18006 318	21.18807	+0.17327	22.69396	+0.16718
8	22.78202 805	-0.16718 450	24.33194	-0.16170	25.84561	-0.15672
9	25.92295 765	+0.15672 493	27.47529	+0.15218	28.99508	+0.14801
10	29.06403 025	-0.14801 108	30.61829	-0.14417	32.14300	-0.14061
11	32.20520 412	+0.14060 578	33.76102	+0.13730	35.28979	+0.13421
12	35.34645 231	-0.13421 123	36.90356	-0.13132	38.43573	-0.12862
13	38.48775 665	+0.12861 661	40.04594	+0.12607	41.58101	+0.12367
14	41.62910 447	-0.12366 795	43.18822	-0.12140	44.72578	-0.11925
15	44.77048 661	+0.11924 981	46.33040	+0.11721	47.87012	+0.11527
16	47.91189 633	-0.11527 369	49.47251	-0.11343	51.01413	-0.11167
17	51.05332 855	+0.11167 049	52.61455	+0.10999	54.15785	+0.10839
18	54.19477 936	-0.10838 535	55.75654	-0.10685	57.30135	-0.10537
19	57.33624 570	+0.10537 405	58.89850	+0.10396	60.44464	+0.10260
20	60.47772 516	-0.10260 057	62.04041	-0.10129	63.58777	-0.10004
11	32.20520 412	+0.14060 578	33.76102	+0.13730	35.28979	+0.13421
12	35.34645 231	-0.13421 123	36.90356	-0.13132	38.43573	-0.12862
13	38.48775 665	+0.12861 661	40.04594	+0.12607	41.58101	+0.12367
14	41.62910 447	-0.12366 795	43.18822	-0.12140	44.72578	-0.11925
15	44.77048 661	+0.11924 981	46.33040	+0.11721	47.87012	+0.11527
16	47.91189 633	-0.11527 369	49.47251	-0.11343	51.01413	-0.11167
17	51.05332 855	+0.11167 049	52.61455	+0.10999	54.15785	+0.10839
18	54.19477 936	-0.10838 535	55.75654	-0.10685	57.30135	-0.10537
19	57.33624 570	+0.10537 405	58.89850	+0.10396	60.44464	+0.10260
20	60.47772 516	-0.10260 057	62.04041	-0.10129	63.58777	-0.10004
11	36.79479	+0.13132	38.27867	+0.12861	39.74363	+0.12606
12	39.94577	-0.12607	41.43596	-0.12367	42.90825	-0.12140
13	43.09537	+0.12140	44.59102	+0.11925	46.06968	+0.11721
14	46.24387	-0.11721	47.74429	-0.11527	49.22854	-0.11343
15	49.39150	+0.11343	50.89611	+0.11167	52.38531	+0.10999
16	52.53840	-0.10999	54.04673	-0.10838	55.54035	-0.10685
17	55.68470	+0.10685	57.19635	+0.10537	58.69393	+0.10396
18	58.83049	-0.10396	60.34513	-0.10260	61.84628	-0.10129
19	61.97586	+0.10129	63.49320	+0.10003	64.99759	+0.09882
20	65.12086	-0.09882	66.64065	-0.09765	68.14799	-0.09652
11	41.19152	+0.12366	42.62391	+0.12138	44.04215	+0.11923
12	44.36427	-0.11924	45.80544	-0.11720	47.23298	-0.11526
13	47.53282	+0.11527	48.98171	+0.11342	50.41746	+0.11166
14	50.69796	-0.11167	52.15369	-0.10999	53.59675	-0.10838
15	53.86031	+0.10838	55.32215	+0.10684	56.77177	+0.10537
16	57.02034	-0.10537	58.48767	-0.10396	59.94319	-0.10260
17	60.17842	+0.10260	61.65071	+0.10129	63.11158	+0.10003
18	63.33485	-0.10003	64.81164	-0.09882	66.27738	-0.09765
19	66.48986	+0.09765	67.97075	+0.09652	69.44095	+0.09543
20	69.64364	-0.09543	71.12830	-0.09438	72.60259	-0.09336
11	7.83774	+0.23429	8.91961	+0.21556	9.99463	+0.20027
2	11.81104	-0.21591	13.00771	-0.20352	14.19036	-0.19289
3	15.31362	+0.19571	16.57392	+0.18672	17.81789	+0.17880
4	18.67070	-0.17975	19.97434	-0.17283	21.26093	-0.16662
5	21.95829	+0.16703	23.29397	+0.16148	24.61258	+0.15643
6	25.20621	-0.15664	26.56676	-0.15206	27.91052	-0.14785
7	28.42904	+0.14796	29.80953	+0.14409	31.17370	+0.14051
8	31.63488	-0.14058	33.03177	-0.13725	34.41286	-0.13415
9	34.82864	+0.13419	36.23927	+0.13130	37.63465	+0.12857
10	38.01347	-0.12860	39.43579	-0.12605	40.84342	-0.12364
11	41.19152	+0.12366	42.62391	+0.12138	44.04215	+0.11923
12	44.36427	-0.11924	45.80544	-0.11720	47.23298	-0.11526
13	47.53282	+0.11527	48.98171	+0.11342	50.41746	+0.11166
14	50.69796	-0.11167	52.15369	-0.10999	53.59675	-0.10838
15	53.86031	+0.10838	55.32215	+0.10684	56.77177	+0.10537
16	57.02034	-0.10537	58.48767	-0.10396	59.94319	-0.10260
17	60.17842	+0.10260	61.65071	+0.10129	63.11158	+0.10003
18	63.33485	-0.10003	64.81164	-0.09882	66.27738	-0.09765
19	66.48986	+0.09765	67.97075	+0.09652	69.44095	+0.09543
20	69.64364	-0.09543	71.12830	-0.09438	72.60259	-0.09336
11	41.19152	+0.12366	42.62391	+0.12138	44.04215	+0.11923
12	44.36427	-0.11924	45.80544	-0.11720	47.23298	-0.11526
13	47.53282	+0.11527	48.98171	+0.11342	50.41746	+0.11166
14	50.69796	-0.11167	52.15369	-0.10999	53.59675	-0.10838
15	53.86031	+0.10838	55.32215	+0.10684	56.77177	+0.10537
16	57.02034	-0.10537	58.48767	-0.10396	59.94319	-0.10260
17	60.17842	+0.10260	61.65071	+0.10129	63.11158	+0.10003
18	63.33485	-0.10003	64.81164	-0.09882	66.27738	-0.09765
19	66.48986	+0.09765	67.97075	+0.09652	69.44095	+0.09543
20	69.64364	-0.09543	71.12830	-0.09438	72.60259	-0.09336
11	41.19152	+0.12366	42.62391	+0.12138	44.04215	+0.11923
12	44.36427	-0.11924	45.80544	-0.11720	47.23298	-0.11526
13	47.53282	+0.11527	48.98171	+0.11342	50.41746	+0.11166
14	50.69796	-0.11167	52.15369	-0.10999	53.59675	-0.10838
15	53.86031	+0.10838	55.32215	+0.10684	56.77177	+0.10537
16	57.02034	-0.10537	58.48767	-0.10396	59.94319	-0.10260
17	60.17842	+0.10260	61.65071	+0.10129	63.11158	+0.10003
18	63.33485	-0.10003	64.81164	-0.09882	66.27738	-0.09765
19	66.48986	+0.09765	67.97075	+0.09652	69.44095	+0.09543
20	69.64364	-0.09543	71.12830	-0.09438	72.60259	-0.09336

Table 9.5
ZEROS AND ASSOCIATED VALUES OF BESSEL FUNCTIONS AND THEIR DERIVATIVES

s	$j'_{0,s}$	$J_0(j'_{0,s})$	$j'_{1,s}$	$J_1(j'_{1,s})$	$j'_{2,s}$	$J_2(j'_{2,s})$
1	0.00000 00000	+1.00000 00000	1.84118	+0.58187	3.05424	+0.48650
2	3.83170 59702	-0.40275 93957	5.33144	-0.34613	6.70613	-0.31353
3	7.01558 66698	+0.30011 57525	8.53632	+0.27330	9.96947	+0.25474
4	10.17346 81351	-0.24970 48771	11.70600	-0.23330	13.17037	-0.22088
5	13.32369 19363	+0.21835 94072	14.86359	+0.20701	16.34752	+0.19794
6	16.47063 00509	-0.19646 53715	18.01553	-0.18802	19.51291	-0.18101
7	19.61585 85105	+0.18006 33753	21.16437	+0.17346	22.67158	+0.16784
8	22.76008 43806	-0.16718 46005	24.31133	-0.16184	25.82604	-0.15720
9	25.90367 20876	+0.15672 49863	27.45705	+0.15228	28.97767	+0.14836
10	29.04682 85349	-0.14801 11100	30.60192	-0.14424	32.12733	-0.14088
11	32.18967 99110	+0.14060 57982	33.74618	+0.13736	35.27554	+0.13443
12	35.33230 75501	-0.13421 12403	36.88999	-0.13137	38.42265	-0.12879
13	38.47476 62348	+0.12861 66221	40.03344	+0.12611	41.56893	+0.12381
14	41.61709 42128	-0.12366 79608	43.17663	-0.12143	44.71455	-0.11937
15	44.75931 89977	+0.11924 98120	46.31960	+0.11724	47.85964	+0.11537
16	47.90146 08872	-0.11527 36941	49.46239	-0.11345	51.00430	-0.11176
17	51.04353 51836	+0.11167 04969	52.60504	+0.11001	54.14860	+0.10846
18	54.18555 36411	-0.10838 53489	55.74757	-0.10687	57.29260	-0.10544
19	57.32752 54379	+0.10537 40554	58.89000	+0.10397	60.43635	+0.10266
20	60.46945 78453	-0.10260 05671	62.03235	-0.10131	63.57989	-0.10008

s	$j'_{3,s}$	$J_3(j'_{3,s})$	$j'_{4,s}$	$J_4(j'_{4,s})$	$j'_{5,s}$	$J_5(j'_{5,s})$
1	4.20119	+0.43439	5.31755	+0.39965	6.41562	+0.37409
2	8.01524	-0.29116	9.28240	-0.27438	10.51986	-0.26109
3	11.34592	+0.24074	12.68191	+0.22959	13.98719	+0.22039
4	14.58585	-0.21097	15.96411	-0.20276	17.31284	-0.19580
5	17.78875	+0.19042	19.19603	+0.18403	20.57551	+0.17849
6	20.97248	-0.17505	22.40103	-0.16988	23.80358	-0.16533
7	24.14490	+0.16295	25.58976	+0.15866	27.01031	+0.15482
8	27.31006	-0.15310	28.76784	-0.14945	30.20285	-0.14616
9	30.47027	+0.14487	31.93854	+0.14171	33.38544	+0.13885
10	33.62695	-0.13784	35.10392	-0.13509	36.56078	-0.13256
11	36.78102	+0.13176	38.26532	+0.12932	39.73064	+0.12707
12	39.93311	-0.12643	41.42367	-0.12425	42.89627	-0.12223
13	43.08365	+0.12169	44.57962	+0.11973	46.05857	+0.11790
14	46.23297	-0.11746	47.73367	-0.11568	49.21817	-0.11402
15	49.38130	+0.11364	50.88616	+0.11202	52.37559	+0.11049
16	52.52882	-0.11017	54.03737	-0.10868	55.53120	-0.10728
17	55.67567	+0.10700	57.18752	+0.10563	58.68528	+0.10434
18	58.82195	-0.10409	60.33677	-0.10283	61.83809	-0.10163
19	61.96775	+0.10141	63.48526	+0.10023	64.98980	+0.09912
20	65.11315	-0.09893	66.63309	-0.09783	68.14057	-0.09678

s	$j'_{6,s}$	$J_6(j'_{6,s})$	$j'_{7,s}$	$J_7(j'_{7,s})$	$j'_{8,s}$	$J_8(j'_{8,s})$
1	7.50127	+0.35414	8.57784	+0.33793	9.64742	+0.32438
2	11.73494	-0.25017	12.93239	-0.24096	14.11552	-0.23303
3	15.26818	+0.21261	16.52937	+0.20588	17.77401	+0.19998
4	18.63744	-0.18978	19.94185	-0.18449	21.22906	-0.17979
5	21.93172	+0.17363	23.26805	+0.16929	24.58720	+0.16539
6	25.18393	-0.16127	26.54503	-0.15762	27.88927	-0.15431
7	28.40978	+0.15137	29.79075	+0.14823	31.15533	+0.14537
8	31.61788	-0.14317	33.01518	-0.14044	34.39663	-0.13792
9	34.81339	+0.13623	36.22438	+0.13381	37.62008	+0.13158
10	37.99964	-0.13024	39.42227	-0.12808	40.83018	-0.12608
11	41.17885	+0.12499	42.61152	+0.12305	44.03001	+0.12124
12	44.35258	-0.12035	45.79400	-0.11859	47.22176	-0.11695
13	47.52196	+0.11620	48.97107	+0.11460	50.40702	+0.11309
14	50.68782	-0.11246	52.14375	-0.11099	53.58700	-0.10960
15	53.85079	+0.10906	55.31282	+0.10771	56.76260	+0.10643
16	57.01138	-0.10596	58.47887	-0.10471	59.93454	-0.10352
17	60.16995	+0.10311	61.64239	+0.10195	63.10340	+0.10084
18	63.32681	-0.10049	64.80374	-0.09940	66.26961	-0.09837
19	66.48221	+0.09805	67.96324	+0.09704	69.43356	+0.09607
20	69.63635	-0.09579	71.12113	-0.09484	72.59554	-0.09393

Table 9.5
ZEROS AND ASSOCIATED VALUES OF BESSEL FUNCTIONS AND THEIR DERIVATIVES

s	$y'_{0,s}$	$Y_0(y'_{0,s})$	$y'_{1,s}$	$Y_1(y'_{1,s})$	$y'_{2,s}$	$Y_2(y'_{2,s})$
1	2.19714 133	+0.52078 641	3.68302	+0.41673	5.00258	+0.36766
2	5.42968 104	-0.34031 805	6.94150	-0.30317	8.35072	-0.27928
3	8.59600 587	+0.27145 988	10.12340	+0.25091	11.57420	+0.23594
4	11.74915 483	-0.23246 177	13.28576	-0.21897	14.76091	-0.20845
5	14.89744 213	+0.20654 711	16.44006	+0.19683	17.93129	+0.18890
6	18.04340 228	-0.18772 909	19.59024	-0.18030	21.09289	-0.17405
7	21.18806 893	+0.17326 604	22.73803	+0.16735	24.24923	+0.16225
8	24.33194 257	-0.16170 163	25.88431	-0.15684	27.40215	-0.15259
9	27.47529 498	+0.15218 126	29.02958	+0.14810	30.55271	+0.14448
10	30.61828 649	-0.14416 600	32.17412	-0.14067	33.70159	-0.13754
11	33.76101 780	+0.13729 696	35.31813	+0.13427	36.84921	+0.13152
12	36.90355 532	-0.13132 464	38.46175	-0.12866	39.99589	-0.12623
13	40.04594 464	+0.12606 951	41.60507	+0.12370	43.14182	+0.12153
14	43.18821 810	-0.12139 863	44.74814	-0.11928	46.28716	-0.11732
15	46.33039 925	+0.11721 120	47.89101	+0.11530	49.43202	+0.11352
16	49.47250 568	-0.11342 920	51.03373	-0.11169	52.57649	-0.11007
17	52.61455 077	+0.10999 115	54.17632	+0.10840	55.72063	+0.10692
18	55.75654 488	-0.10684 789	57.31880	-0.10539	58.86450	-0.10402
19	58.89849 617	+0.10395 957	60.46118	+0.10261	62.00814	+0.10135
20	62.04041 115	-0.10129 350	63.60349	-0.10005	65.15159	-0.09887
s	$y'_{3,s}$	$Y_3(y'_{3,s})$	$y'_{4,s}$	$Y_4(y'_{4,s})$	$y'_{5,s}$	$Y_5(y'_{5,s})$
1	6.25363	+0.33660	7.46492	+0.31432	8.64956	+0.29718
2	9.69879	-0.26195	11.00517	-0.24851	12.28087	-0.23763
3	12.97241	+0.22428	14.33172	+0.21481	15.66080	+0.20687
4	16.19045	-0.19987	17.58444	-0.19267	18.94974	-0.18650
5	19.38239	+0.18223	20.80106	+0.17651	22.19284	+0.17151
6	22.55979	-0.16867	23.99700	-0.16397	25.40907	-0.15980
7	25.72821	+0.15779	27.17989	+0.15384	28.60804	+0.15030
8	28.89068	-0.14881	30.35396	-0.14543	31.79520	-0.14236
9	32.04898	+0.14122	33.52180	+0.13828	34.97389	+0.13559
10	35.20427	-0.13470	36.68505	-0.13211	38.14631	-0.12973
11	38.35728	+0.12901	39.84483	+0.12671	41.31392	+0.12458
12	41.50855	-0.12399	43.00191	-0.12193	44.47779	-0.12001
13	44.65845	+0.11952	46.15686	+0.11765	47.63867	+0.11591
14	47.80725	-0.11550	49.31009	-0.11380	50.79713	-0.11221
15	50.95515	+0.11186	52.46191	+0.11031	53.95360	+0.10885
16	54.10232	-0.10855	55.61257	-0.10712	57.10841	-0.10578
17	57.24887	+0.10552	58.76225	+0.10420	60.26183	+0.10295
18	60.39491	-0.10273	61.91110	-0.10151	63.41407	-0.10035
19	63.54050	+0.10015	65.05925	+0.09901	66.56530	+0.09793
20	66.68571	-0.09775	68.20679	-0.09669	69.71565	-0.09568
s	$y'_{6,s}$	$Y_6(y'_{6,s})$	$y'_{7,s}$	$Y_7(y'_{7,s})$	$y'_{8,s}$	$Y_8(y'_{8,s})$
1	9.81480	+0.28339	10.96515	+0.27194	12.10364	+0.26220
2	13.53281	-0.22854	14.76569	-0.22077	15.98284	-0.21402
3	16.96553	+0.20007	18.25012	+0.19414	19.51773	+0.18891
4	20.29129	-0.18111	21.61275	-0.17634	22.91696	-0.17207
5	23.56186	+0.16708	24.91131	+0.16311	26.24370	+0.15953
6	26.79950	-0.15607	28.17105	-0.15269	29.52596	-0.14962
7	30.01567	+0.14709	31.40518	+0.14417	32.77857	+0.14149
8	33.21697	-0.13957	34.62140	-0.13700	36.01026	-0.13463
9	36.40752	+0.13313	37.82455	+0.13085	39.22658	+0.12874
10	39.59002	-0.12753	41.01785	-0.12549	42.43122	-0.12359
11	42.76632	+0.12260	44.20351	+0.12076	45.62678	+0.11904
12	45.93775	-0.11822	47.38314	-0.11654	48.81512	-0.11497
13	49.10528	+0.11428	50.55791	+0.11275	51.99761	+0.11131
14	52.26963	-0.11072	53.72870	-0.10931	55.17529	-0.10798
15	55.43136	+0.10748	56.89619	+0.10618	58.34899	+0.10494
16	58.59089	-0.10451	60.06092	-0.10330	61.51933	-0.10216
17	61.74857	+0.10177	63.22331	+0.10065	64.68681	+0.09958
18	64.90468	-0.09925	66.38370	-0.09820	67.85185	-0.09720
19	68.05943	+0.09690	69.54237	+0.09592	71.01478	+0.09498
20	71.21301	-0.09471	72.69955	-0.09379	74.17587	-0.09291

BESSEL FUNCTIONS— $J_0(j_{0,s}x)$

Table 9.6

x	$J_0(j_{0,1}x)$	$J_0(j_{0,2}x)$	$J_0(j_{0,3}x)$	$J_0(j_{0,4}x)$	$J_0(j_{0,5}x)$
0.00	1.00000	1.00000	1.00000	1.00000	1.00000
0.02	0.99942	0.99696	0.99253	0.98614	0.97783
0.04	0.99769	0.98785	0.97027	0.94515	0.91280
0.06	0.99480	0.97276	0.93373	0.87872	0.80920
0.08	0.99077	0.95184	0.88372	0.78961	0.67388
0.10	0.98559	0.92526	0.82136	0.68146	0.51568
0.12	0.97929	0.89328	0.74804	0.55871	0.34481
0.14	0.97186	0.85617	0.66537	0.42632	0.17211
0.16	0.96333	0.81429	0.57518	0.28958	+0.00827
0.18	0.95370	0.76800	0.47943	0.15386	-0.13693
0.20	0.94300	0.71773	0.38020	+0.02438	-0.25533
0.22	0.93124	0.66392	0.27960	-0.09404	-0.34090
0.24	0.91844	0.60706	0.17976	-0.19716	-0.39013
0.26	0.90463	0.54766	+0.08277	-0.28155	-0.40225
0.28	0.88982	0.48623	-0.00942	-0.34466	-0.37917
0.30	0.87405	0.42333	-0.09498	-0.38498	-0.32527
0.32	0.85734	0.35950	-0.17226	-0.40207	-0.24698
0.34	0.83972	0.29529	-0.23986	-0.39653	-0.15223
0.36	0.82122	0.23126	-0.29664	-0.36998	-0.04980
0.38	0.80187	0.16795	-0.34171	-0.32493	+0.05137
0.40	0.78171	0.10590	-0.37453	-0.26467	0.14293
0.42	0.76077	+0.04562	-0.39482	-0.19304	0.21767
0.44	0.73908	-0.01240	-0.40264	-0.11431	0.27011
0.46	0.71669	-0.06769	-0.39835	-0.03289	0.29684
0.48	0.69362	-0.11983	-0.38259	+0.04684	0.29671
0.50	0.66993	-0.16840	-0.35628	0.12078	0.27086
0.52	0.64565	-0.21306	-0.32056	0.18527	0.22252
0.54	0.62081	-0.25349	-0.27678	0.23725	0.15667
0.56	0.59547	-0.28941	-0.22648	0.27445	+0.07960
0.58	0.56967	-0.32062	-0.17130	0.29541	-0.00168
0.60	0.54345	-0.34692	-0.11295	0.29959	-0.08007
0.62	0.51685	-0.36821	-0.05320	0.28731	-0.14891
0.64	0.48992	-0.38441	+0.00622	0.25977	-0.20259
0.66	0.46270	-0.39551	0.06363	0.21892	-0.23697
0.68	0.43524	-0.40152	0.11745	0.16735	-0.24965
0.70	0.40758	-0.40255	0.16625	0.10814	-0.24019
0.72	0.37977	-0.39871	0.20878	+0.04470	-0.21003
0.74	0.35186	-0.39019	0.24399	-0.01945	-0.16237
0.76	0.32389	-0.37721	0.27107	-0.08082	-0.10179
0.78	0.29591	-0.36003	0.28945	-0.13618	-0.03389
0.80	0.26796	-0.33896	0.29882	-0.18270	+0.03525
0.82	0.24009	-0.31433	0.29915	-0.21808	0.09960
0.84	0.21234	-0.28652	0.29063	-0.24067	0.15369
0.86	0.18476	-0.25591	0.27374	-0.24957	0.19306
0.88	0.15739	-0.22293	0.24914	-0.24461	0.21464
0.90	0.13027	-0.18800	0.21774	-0.22637	0.21694
0.92	0.10346	-0.15157	0.18059	-0.19613	0.20021
0.94	0.07698	-0.11411	0.13891	-0.15580	0.16630
0.96	0.05089	-0.07605	0.09399	-0.10779	0.11854
0.98	0.02521	-0.03787	0.04722	-0.05486	0.06138
1.00	0.00000	0.00000	0.00000	0.00000	0.00000
	$\begin{bmatrix} (-4)1 \\ 3 \end{bmatrix}$	$\begin{bmatrix} (-4)8 \\ 4 \end{bmatrix}$	$\begin{bmatrix} (-3)2 \\ 5 \end{bmatrix}$	$\begin{bmatrix} (-3)3 \\ 5 \end{bmatrix}$	$\begin{bmatrix} (-3)5 \\ 6 \end{bmatrix}$

From E. T. Goodwin and J. Staton, Table of $J_0(j_{0,nr})$, Quart. J. Mech. Appl. Math. 1, 220-224 (1948) (with permission).

BESSEL FUNCTIONS OF INTEGER ORDER

Table 9.7 BESSEL FUNCTIONS—MISCELLANEOUS ZEROS

s^{th} Zero of $xJ_1(x) - \lambda J_0(x)$					
$\lambda \backslash s$	1	2	3	4	5
0.00	0.0000	3.8317	7.0156	10.1735	13.3237
0.02	0.1995	3.8369	7.0184	10.1754	13.3252
0.04	0.2814	3.8421	7.0213	10.1774	13.3267
0.06	0.3438	3.8473	7.0241	10.1794	13.3282
0.08	0.3960	3.8525	7.0270	10.1813	13.3297
0.10	0.4417	3.8577	7.0298	10.1833	13.3312
0.20	0.6170	3.8835	7.0440	10.1931	13.3387
0.40	0.8516	3.9344	7.0723	10.2127	13.3537
0.60	1.0184	3.9841	7.1004	10.2322	13.3686
0.80	1.1490	4.0325	7.1282	10.2516	13.3835
1.00	1.2558	4.0795	7.1558	10.2710	13.3984

$\lambda^{-1} \backslash s$	1	2	3	4	5	$\langle \lambda \rangle$
1.00	1.2558	4.0795	7.1558	10.2710	13.3984	1
0.80	1.3659	4.1361	7.1898	10.2950	13.4169	1
0.60	1.5095	4.2249	7.2453	10.3346	13.4476	2
0.40	1.7060	4.3818	7.3508	10.4118	13.5079	3
0.20	1.9898	4.7131	7.6177	10.6223	13.6786	5
0.10	2.1795	5.0332	7.9569	10.9363	13.9580	10
0.08	2.2218	5.1172	8.0624	11.0477	14.0666	13
0.06	2.2656	5.2085	8.1852	11.1864	14.2100	17
0.04	2.3108	5.3068	8.3262	11.3575	14.3996	25
0.02	2.3572	5.4112	8.4840	11.5621	14.6433	50
0.00	2.4048	5.5201	8.6537	11.7915	14.9309	∞

 s^{th} Zero of $J_1(x) - \lambda x J_0(x)$

$\lambda \backslash s$	1	2	3	4	5
0.5	0.0000	5.1356	8.4172	11.6198	14.7960
0.6	1.1231	5.2008	8.4569	11.6486	14.8185
0.7	1.4417	5.2476	8.4853	11.6691	14.8346
0.8	1.6275	5.2826	8.5066	11.6845	14.8467
0.9	1.7517	5.3098	8.5231	11.6964	14.8561
1.0	1.8412	5.3314	8.5363	11.7060	14.8636

$\lambda^{-1} \backslash s$	1	2	3	4	5	$\langle \lambda \rangle$
1.00	1.8412	5.3314	8.5363	11.7060	14.8636	1
0.80	1.9844	5.3702	8.5600	11.7232	14.8771	1
0.60	2.1092	5.4085	8.5836	11.7404	14.8906	2
0.40	2.2192	5.4463	8.6072	11.7575	14.9041	3
0.20	2.3171	5.4835	8.6305	11.7745	14.9175	5
0.10	2.3621	5.5019	8.6421	11.7830	14.9242	10
0.08	2.3709	5.5055	8.6445	11.7847	14.9256	13
0.06	2.3795	5.5092	8.6468	11.7864	14.9269	17
0.04	2.3880	5.5128	8.6491	11.7881	14.9282	25
0.02	2.3965	5.5165	8.6514	11.7898	14.9296	50
0.00	2.4048	5.5201	8.6537	11.7915	14.9309	∞

 $\langle \lambda \rangle$ = nearest integer to λ .

Compiled from H. S. Carslaw and J. C. Jaeger, Conduction of heat in solids (Oxford Univ. Press, London, England, 1947) and British Association for the Advancement of Science, Bessel functions, Part I. Functions of orders zero and unity, Mathematical Tables, vol. VI (Cambridge Univ. Press, Cambridge, England, 1950)(with permission).

BESSEL FUNCTIONS—MISCELLANEOUS ZEROS Table 9.7

s^{th} Zero of $J_0(x)Y_0(\lambda x) - Y_0(x)J_0(\lambda x)$

$\lambda^{-1} \setminus s$	1	2	3	4	5	$\langle \lambda \rangle$
* 0.80	12.55847 031	25.12877	37.69646	50.26349	62.83026	1
0.60	4.69706 410	9.41690	14.13189	18.84558	23.55876	2
0.40	2.07322 886	4.17730	6.27537	8.37167	10.46723	3
0.20	0.76319 127	1.55710	2.34641	3.13403	3.92084	5
0.10	0.33139 387	0.68576	1.03774	1.38864	1.73896	10
0.08	0.25732 649	0.53485	0.81055	1.08536	1.35969	13
0.06	0.18699 458	0.39079	0.59334	0.79522	0.99673	17
0.04	0.12038 637	0.25340	0.38570	0.51759	0.64923	25
0.02	0.05768 450	0.12272	0.18751	0.25214	0.31666	50
0.00	0.00000 000	0.00000	0.00000	0.00000	0.00000	∞

s^{th} Zero of $J_1(x)Y_1(\lambda x) - Y_1(x)J_1(\lambda x)$

$\lambda^{-1} \setminus s$	1	2	3	4	5	$\langle \lambda \rangle$
* 0.80	12.59004 151	25.14465	37.70706	50.27145	62.83662	1
0.60	4.75805 426	9.44837	14.15300	18.86146	23.57148	2
0.40	2.15647 249	4.22309	6.30658	8.39528	10.48619	3
0.20	0.84714 961	1.61108	2.38532	3.16421	3.94541	5
0.10	0.39409 416	0.73306	1.07483	1.41886	1.76433	10
0.08	0.31223 576	0.57816	0.84552	1.11441	1.38440	13
0.06	0.23235 256	0.42843	0.62483	0.82207	1.02001	17
0.04	0.15400 729	0.28296	0.41157	0.54044	0.66961	25
0.02	0.07672 788	0.14062	0.20409	0.26752	0.33097	50
0.00	0.00000 000	0.00000	0.00000	0.00000	0.00000	∞

s^{th} Zero of $J_1(x)Y_0(\lambda x) - Y_1(x)J_0(\lambda x)$

$\lambda^{-1} \setminus s$	1	2	3	4	5	$\langle \lambda \rangle$
* 0.80	6.56973 310	18.94971	31.47626	44.02544	56.58224	1
* 0.60	2.60328 138	7.16213	11.83783	16.53413	21.23751	2
0.40	1.24266 626	3.22655	5.28885	7.36856	9.45462	3
0.20	0.51472 663	1.24657	2.00959	2.78326	3.56157	5
0.10	0.24481 004	0.57258	0.90956	1.25099	1.59489	10
0.08	0.19461 772	0.45251	0.71635	0.98327	1.25203	13
0.06	0.14523 798	0.33597	0.53005	0.72594	0.92301	17
0.04	0.09647 602	0.22226	0.34957	0.47768	0.60634	25
0.02	0.04813 209	0.11059	0.17353	0.23666	0.29991	50
0.00	0.00000 000	0.00000	0.00000	0.00000	0.00000	∞

$\langle \lambda \rangle$ = nearest integer to λ .

Compiled from British Association for the Advancement of Science, Bessel functions, Part I. Functions of orders zero and unity, Mathematical Tables, vol. VI (Cambridge Univ. Press, Cambridge, England, 1950) (with permission).

*See page II.

BESSEL FUNCTIONS OF INTEGER ORDER

Table 9.8 MODIFIED BESSEL FUNCTIONS—ORDERS 0, 1 AND 2

x	$e^{-x}I_0(x)$	$e^{-x}I_1(x)$	$x^{-2}I_2(x)$
0.0	1.00000 00000	0.00000 00000	0.12500 00000
0.1	0.90710 09258	0.04529 84468	0.12510 41992
0.2	0.82693 85516	0.08228 31235	0.12541 71878
0.3	0.75758 06252	0.11237 75606	0.12594 01407
0.4	0.69740 21705	0.13676 32243	0.12667 50222
0.5	0.64503 52706	0.15642 08032	0.12762 45967
0.6	0.59932 72031	0.17216 44195	0.12879 24416
0.7	0.55930 55265	0.18466 99828	0.13018 29658
0.8	0.52414 89420	0.19449 86933	0.13180 14318
0.9	0.49316 29662	0.20211 65309	0.13365 39819
1.0	0.46575 96077	0.20791 04154	0.13574 76698
1.1	0.44144 03776	0.21220 16132	0.13809 04952
1.2	0.41978 20789	0.21525 68594	0.14069 14455
1.3	0.40042 49127	0.21729 75878	0.14356 05405
1.4	0.38306 25154	0.21850 75923	0.14670 88837
1.5	0.36743 36090	0.21903 93874	0.15014 87192
1.6	0.35331 49978	0.21901 94899	0.15389 34944
1.7	0.34051 56880	0.21855 28066	0.15795 79288
1.8	0.32887 19497	0.21772 62788	0.16235 80900
1.9	0.31824 31629	0.21661 19112	0.16711 14772
2.0	0.30850 83225	0.21526 92892	0.17223 71119
2.1	0.29956 30945	0.21374 76721	0.17775 56370
2.2	0.29131 73331	0.21208 77328	0.18368 94251
2.3	0.28369 29857	0.21032 30051	0.19006 26964
2.4	0.27662 23231	0.20848 10887	0.19690 16460
2.5	0.27004 64416	0.20658 46495	0.20423 45837
2.6	0.26391 39957	0.20465 22544	0.21209 20841
2.7	0.25818 01238	0.20269 90640	0.22050 71509
2.8	0.25280 55337	0.20073 74113	0.22951 53938
2.9	0.24775 57304	0.19877 72816	0.23915 52213
3.0	0.24300 03542	0.19682 67133	0.24946 80490
3.1	0.23851 26187	0.19489 21309	0.26049 85252
3.2	0.23426 88316	0.19297 86229	0.27229 47757
3.3	0.23024 79845	0.19109 01727	0.28490 86686
3.4	0.22643 14011	0.18922 98511	0.29839 61010
3.5	0.22280 24380	0.18739 99766	0.31281 73100
3.6	0.21934 62245	0.18560 22484	0.32823 72078
3.7	0.21604 94417	0.18383 78580	0.34472 57467
3.8	0.21290 01308	0.18210 75810	0.36235 83128
3.9	0.20988 75279	0.18041 18543	0.38121 61528
4.0	0.20700 19211	0.17875 08394	0.40138 68359
4.1	0.20423 45274	0.17712 44763	0.42296 47539
4.2	0.20157 73840	0.17553 25260	0.44605 16629
4.3	0.19902 32571	0.17397 46091	0.47075 72701
4.4	0.19656 55589	0.17245 02337	0.49719 98689
4.5	0.19419 82777	0.17095 88223	0.52550 70272
4.6	0.19191 59151	0.16949 97311	0.55581 63319
4.7	0.18971 34330	0.16807 22681	0.58827 61978
4.8	0.18758 62042	0.16667 57058	0.62304 67409
4.9	0.18552 99721	0.16530 92936	0.66030 07270
5.0	0.18354 08126 $\left[\begin{smallmatrix} (-3)2 \\ 9 \end{smallmatrix} \right]$	0.16397 22669 $\left[\begin{smallmatrix} (-3)1 \\ 9 \end{smallmatrix} \right]$	0.70022 45988 $\left[\begin{smallmatrix} (-4)3 \\ 7 \end{smallmatrix} \right]$

$$I_{n+1}(x) = -\frac{2n}{x} I_n(x) + I_{n-1}(x)$$

Compiled from British Association for the Advancement of Science, Bessel functions, Part I. Functions of orders zero and unity, Mathematical Tables, vol. VI, Part II. Functions of positive integer order, Mathematical Tables, vol. X (Cambridge Univ. Press, Cambridge, England, 1950, 1952) and L. Fox, A short table for Bessel functions of integer orders and large arguments. Royal Society Shorter Mathematical Tables No. 3 (Cambridge Univ. Press, Cambridge, England, 1954) (with permission).

MODIFIED BESSEL FUNCTIONS—ORDERS 0, 1 AND 2 Table 9.8

x	$e^x K_0(x)$	$e^x K_1(x)$	$x^2 K_2(x)$
0.0	∞	∞	2.00000 0000
0.1	2.68232 61023	10.89018 2683	1.99503 9646
0.2	2.14075 73233	5.83338 6037	1.98049 7172
0.3	1.85262 73007	4.12515 7762	1.95711 6625
0.4	1.66268 20891	3.25867 3880	1.92580 8202
0.5	1.52410 93857	2.73100 97082	1.88754 5888
0.6	1.41673 76214	2.37392 00376	1.84330 9881
0.7	1.33012 36562	2.11501 13128	1.79405 1681
0.8	1.25820 31216	1.91793 02990	1.74067 2762
0.9	1.19716 33803	1.76238 82197	1.68401 1992
1.0	1.14446 30797	1.63615 34863	1.62483 8899
1.1	1.09833 02828	1.53140 37541	1.56385 0953
1.2	1.05748 45322	1.44289 75522	1.50167 3576
1.3	1.02097 31613	1.36698 72841	1.43886 2011
1.4	0.98806 99961	1.30105 37400	1.37590 4446
1.5	0.95821 00533	1.24316 58736	1.31322 5917
1.6	0.93094 59808	1.19186 75654	1.25119 2681
1.7	0.90591 81386	1.14603 92462	1.19011 6819
1.8	0.88283 35270	1.10480 53726	1.13026 0897
1.9	0.86145 06168	1.06747 09298	1.07184 2567
2.0	0.84156 82151	1.03347 68471	1.01503 9018
2.1	0.82301 71525	1.00236 80527	0.95999 1226
2.2	0.80565 39812	0.97377 01679	0.90680 7952
2.3	0.78935 61312	0.94737 22250	0.85556 9487
2.4	0.77401 81407	0.92291 36650	0.80633 1113
2.5	0.75954 86903	0.90017 44239	0.75912 6289
2.6	0.74586 82430	0.87896 72806	0.71396 9565
2.7	0.73290 71515	0.85913 18867	0.67085 9227
2.8	0.72060 41251	0.84053 00604	0.62977 9698
2.9	0.70890 49774	0.82304 20403	0.59070 3688
3.0	0.69776 15980	0.80656 34800	0.55359 4126
3.1	0.68713 11010	0.79100 30157	0.51840 5885
3.2	0.67697 51139	0.77628 02824	0.48508 7306
3.3	0.66725 91831	0.76232 42864	0.45358 1550
3.4	0.65795 22725	0.74907 20613	0.42382 7789
3.5	0.64902 63377	0.73646 75480	0.39576 2241
3.6	0.64045 59647	0.72446 06608	0.36931 9074
3.7	0.63221 80591	0.71300 65010	0.34443 1194
3.8	0.62429 15812	0.70206 46931	0.32103 0914
3.9	0.61665 73147	0.69159 88206	0.29905 0529
4.0	0.60929 76693	0.68157 59452	0.27842 2808
4.1	0.60219 65064	0.67196 61952	0.25908 1398
4.2	0.59533 89889	0.66274 24110	0.24096 1165
4.3	0.58871 14486	0.65387 98395	0.22399 8474
4.4	0.58230 12704	0.64535 58689	0.20813 1411
4.5	0.57609 67897	0.63714 97988	0.19329 9963
4.6	0.57008 72022	0.62924 26383	0.17944 6150
4.7	0.56426 24840	0.62161 69312	0.16651 4127
4.8	0.55861 33194	0.61425 66003	0.15445 0249
4.9	0.55313 10397	0.60714 68131	0.14320 3117
5.0	0.54780 75643	0.60027 38587	0.13272 3593

$$K_{n+1}(x) = \frac{2n}{x} K_n(x) + K_{n-1}(x) \quad \left[\begin{matrix} (-3)1 \\ 11 \end{matrix} \right]$$

Table 9.8 MODIFIED BESSEL FUNCTIONS—ORDERS 0, 1 AND 2

x	$e^{-x}I_0(x)$	$e^{-x}I_1(x)$	$e^{-x}I_2(x)$
5.0	0.18354 08126	0.16397 22669	0.11795 1906
5.1	0.18161 51021	0.16266 38546	0.11782 5355
5.2	0.17974 94883	0.16138 32850	0.11767 8994
5.3	0.17794 08646	0.16012 97913	0.11751 4528
5.4	0.17618 63475	0.15890 26150	0.11733 3527
5.5	0.17448 32564	0.15770 10090	0.11713 7435
5.6	0.17282 90951	0.15652 42405	0.11692 7581
5.7	0.17122 15362	0.15537 15922	0.11670 5188
5.8	0.16965 84061	0.15424 23641	0.11647 1384
5.9	0.16813 76726	0.15313 58742	0.11622 7207
6.0	0.16665 74327	0.15205 14593	0.11597 3613
6.1	0.16521 59021	0.15098 84754	0.11571 1484
6.2	0.16381 14064	0.14994 62978	0.11544 1633
6.3	0.16244 23718	0.14892 43212	0.11516 4809
6.4	0.16110 73175	0.14792 19595	0.11488 1705
6.5	0.15980 48490	0.14693 86457	0.11459 2958
6.6	0.15853 36513	0.14597 38314	0.11429 9157
6.7	0.15729 24831	0.14502 69866	0.11400 0845
6.8	0.15608 01720	0.14409 75991	0.11369 8525
6.9	0.15489 56090	0.14318 51745	0.11339 2660
7.0	0.15373 77447	0.14228 92347	0.11308 3678
7.1	0.15260 55844	0.14140 93186	0.11277 1974
7.2	0.15149 81855	0.14054 49809	0.11245 7913
7.3	0.15041 46530	0.13969 57915	0.11214 1833
7.4	0.14935 41371	0.13886 13353	0.11182 4046
7.5	0.14831 58301	0.13804 12115	0.11150 4840
7.6	0.14729 89636	0.13723 50333	0.11118 4481
7.7	0.14630 28062	0.13644 24270	0.11086 3215
7.8	0.14532 66611	0.13566 30318	0.11054 1268
7.9	0.14436 98642	0.13489 64995	0.11021 8852
8.0	0.14343 17818	0.13414 24933	0.10989 6158
8.1	0.14251 18095	0.13340 06883	0.10957 3368
8.2	0.14160 93695	0.13267 07705	0.10925 0645
8.3	0.14072 39098	0.13195 24362	0.10892 8142
8.4	0.13985 49027	0.13124 53923	0.10860 6000
8.5	0.13900 18430	0.13054 93551	0.10828 4348
8.6	0.13816 42474	0.12986 40505	0.10796 3305
8.7	0.13734 16526	0.12918 92134	0.10764 2983
8.8	0.13653 36147	0.12852 45873	0.10732 3481
8.9	0.13573 97082	0.12786 99242	0.10700 4894
9.0	0.13495 95247	0.12722 49839	0.10668 7306
9.1	0.13419 26720	0.12658 95342	0.10637 0796
9.2	0.13343 87740	0.12596 33501	0.10605 5437
9.3	0.13269 74691	0.12534 62139	0.10574 1294
9.4	0.13196 84094	0.12473 79145	0.10542 8428
9.5	0.13125 12609	0.12413 82477	0.10511 6893
9.6	0.13054 57016	0.12354 70154	0.10480 6740
9.7	0.12985 14223	0.12296 40258	0.10449 8015
9.8	0.12916 81248	0.12238 90929	0.10419 0759
9.9	0.12849 55220	0.12182 20364	0.10388 5010
10.0	0.12783 33371 $\left[\begin{smallmatrix} (-6)8 \\ 6 \end{smallmatrix} \right]$	0.12126 26814 $\left[\begin{smallmatrix} (-6)3 \\ 5 \end{smallmatrix} \right]$	0.10358 0801 $\left[\begin{smallmatrix} (-6)2 \\ 5 \end{smallmatrix} \right]$

MODIFIED BESSEL FUNCTIONS—ORDERS 0, 1 AND 2 Table 9.8

x	$e^x K_0(x)$	$e^x K_1(x)$	$e^x K_2(x)$
5.0	0.54780 75643	0.60027 38587	0.78791 711
5.1	0.54263 53519	0.59362 50463	0.77542 949
5.2	0.53760 73540	0.58718 86062	0.76344 913
5.3	0.53271 69744	0.58095 36085	0.75194 475
5.4	0.52795 80329	0.57490 98871	0.74088 762
5.5	0.52332 47316	0.56904 79741	0.73025 127
5.6	0.51881 16252	0.56335 90393	0.72001 128
5.7	0.51441 35938	0.55783 48348	0.71014 511
5.8	0.51012 58183	0.55246 76495	0.70063 190
5.9	0.50594 37583	0.54725 02639	0.69145 232
6.0	0.50186 31309	0.54217 59104	0.68258 843
6.1	0.49787 98929	0.53723 82386	0.67402 358
6.2	0.49399 02237	0.53243 12833	0.66574 225
6.3	0.49019 05093	0.52774 94344	0.65773 001
6.4	0.48647 73291	0.52318 74101	0.64997 339
6.5	0.48284 74413	0.51874 02336	0.64245 982
6.6	0.47929 77729	0.51440 32108	0.63517 753
6.7	0.47582 54066	0.51017 19097	0.62811 553
6.8	0.47242 75723	0.50604 21421	0.62126 350
6.9	0.46910 16370	0.50200 99471	0.61461 177
7.0	0.46584 50959	0.49807 15749	0.60815 126
7.1	0.46265 55657	0.49422 34737	0.60187 345
7.2	0.45953 07756	0.49046 22755	0.59577 030
7.3	0.45646 85618	0.48678 47842	0.58983 426
7.4	0.45346 68594	0.48318 79648	0.58405 820
7.5	0.45052 36991	0.47966 89336	0.57843 541
7.6	0.44763 71996	0.47622 49486	0.57295 955
7.7	0.44480 55636	0.47285 33995	0.56762 463
7.8	0.44202 70724	0.46955 18010	0.56242 497
7.9	0.43930 00819	0.46631 77847	0.55735 522
8.0	0.43662 30185	0.46314 90928	0.55241 029
8.1	0.43399 43754	0.46004 35709	0.54758 538
8.2	0.43141 27084	0.45699 91615	0.54287 592
8.3	0.42887 66329	0.45401 39001	0.53827 757
8.4	0.42638 48214	0.45108 59089	0.53378 623
8.5	0.42393 59993	0.44821 33915	0.52939 797
8.6	0.42152 89433	0.44539 46295	0.52510 909
8.7	0.41916 24781	0.44262 79775	0.52091 604
8.8	0.41683 54743	0.43991 18594	0.51681 544
8.9	0.41454 68462	0.43724 47648	0.51280 410
9.0	0.41229 55493	0.43462 52454	0.50887 894
9.1	0.41008 05783	0.43205 19116	0.50503 704
9.2	0.40790 09662	0.42952 34301	0.50127 562
9.3	0.40575 57809	0.42703 85204	0.49759 202
9.4	0.40364 41245	0.42459 59520	0.49398 369
9.5	0.40156 51322	0.42219 45430	0.49044 819
9.6	0.39951 79693	0.41983 31565	0.48698 321
9.7	0.39750 18313	0.41751 06989	0.48358 651
9.8	0.39551 59416	0.41522 61179	0.48025 597
9.9	0.39355 95506	0.41297 84003	0.47698 953
10.0	0.39163 19344 $\left[\begin{smallmatrix} (-5)2 \\ 6 \end{smallmatrix} \right]$	0.41076 65704 $\left[\begin{smallmatrix} (-5)3 \\ 6 \end{smallmatrix} \right]$	0.47378 525 $\left[\begin{smallmatrix} (-5)6 \\ 5 \end{smallmatrix} \right]$

Table 9.8 MODIFIED BESSEL FUNCTIONS—ORDERS 0, 1 AND 2

x	$e^{-x}I_0(x)$	$e^{-x}I_1(x)$	$e^{-x}I_2(x)$
10.0	0.12783 33371	0.12126 26814	0.10358 0801
10.2	0.12653 91639	0.12016 64024	0.10297 7124
10.4	0.12528 35822	0.11909 89584	0.10237 9936
10.6	0.12406 47082	0.11805 91273	0.10178 9401
10.8	0.12288 07840	0.11704 57564	0.10120 5644
11.0	0.12173 01682	0.11605 77582	0.10062 8758
11.2	0.12061 13250	0.11509 41055	0.10005 8806
11.4	0.11952 28165	0.11415 38276	0.09949 5829
11.6	0.11846 32942	0.11323 60059	0.09893 9845
11.8	0.11743 14923	0.11233 97710	0.09839 0853
12.0	0.11642 62212	0.11146 42993	0.09784 8838
12.2	0.11544 63616	0.11060 88096	0.09731 3770
12.4	0.11449 08594	0.10977 25611	0.09678 5608
12.6	0.11355 87206	0.10895 48501	0.09626 4300
12.8	0.11264 90074	0.10815 50080	0.09574 9787
13.0	0.11176 08338	0.10737 23993	0.09524 2003
13.2	0.11089 33621	0.10660 64190	0.09474 0874
13.4	0.11004 57995	0.10585 64916	0.09424 6323
13.6	0.10921 73954	0.10512 20685	0.09375 8268
13.8	0.10840 74378	0.10440 26267	0.09327 6622
14.0	0.10761 52517	0.10369 76675	0.09280 1299
14.2	0.10684 01959	0.10300 67148	0.09233 2208
14.4	0.10608 16613	0.10232 93142	0.09186 9257
14.6	0.10533 90688	0.10166 50311	0.09141 2352
14.8	0.10461 18671	0.10101 34506	0.09096 1401
15.0	0.10389 95314	0.10037 41751	0.09051 6308
15.2	0.10320 15618	0.09974 68245	0.09007 6980
15.4	0.10251 74813	0.09913 10348	0.08964 3321
15.6	0.10184 68351	0.09852 64572	0.08921 5238
15.8	0.10118 91887	0.09793 27574	0.08879 2637
16.0	0.10054 41273	0.09734 96147	0.08837 5426
16.2	0.09991 12544	0.09677 67216	0.08796 3511
16.4	0.09929 01906	0.09621 37828	0.08755 6802
16.6	0.09868 05729	0.09566 05145	0.08715 5210
16.8	0.09808 20539	0.09511 66444	0.08675 8644
17.0	0.09749 43005	0.09458 19107	0.08636 7017
17.2	0.09691 69938	0.09405 60614	0.08598 0242
17.4	0.09634 98277	0.09353 88542	0.08559 8235
17.6	0.09579 25085	0.09303 00560	0.08522 0911
17.8	0.09524 47546	0.09252 94423	0.08484 8188
18.0	0.09470 62952	0.09203 67968	0.08447 9984
18.2	0.09417 68703	0.09155 19113	0.08411 6221
18.4	0.09365 62299	0.09107 45848	0.08375 6819
18.6	0.09314 41336	0.09060 46237	0.08340 1701
18.8	0.09264 03503	0.09014 18411	0.08305 0793
19.0	0.09214 46572	0.08968 60569	0.08270 4020
19.2	0.09165 68400	0.08923 70968	0.08236 1309
19.4	0.09117 66923	0.08879 47929	0.08202 2590
19.6	0.09070 40151	0.08835 89829	0.08168 7792
19.8	0.09023 86167	0.08792 95099	0.08135 6848
20.0	0.08978 03119 $\left[\begin{smallmatrix} (-6)5 \\ 6 \end{smallmatrix} \right]$	0.08750 62222 $\left[\begin{smallmatrix} (-6)4 \\ 6 \end{smallmatrix} \right]$	0.08102 9690 $\left[\begin{smallmatrix} (-7)9 \\ 5 \end{smallmatrix} \right]$

MODIFIED BESSEL FUNCTIONS—ORDERS 0, 1 AND 2 Table 9.8

x	$e^x K_0(x)$	$e^x K_1(x)$	$e^x K_2(x)$
10.0	0.39163 19344	0.41076 65704	0.47378 525
10.2	0.38786 02539	0.40644 68479	0.46755 571
10.4	0.38419 55846	0.40225 98277	0.46155 324
10.6	0.38063 29549	0.39819 88825	0.45576 482
10.8	0.37716 77125	0.39425 78391	0.45017 842
11.0	0.37379 54971	0.39043 09362	0.44478 294
11.2	0.37051 22156	0.38671 27920	0.43956 807
11.4	0.36731 40243	0.38309 83725	0.43452 427
11.6	0.36419 73076	0.37958 29618	0.42964 265
11.8	0.36115 86616	0.37616 21391	0.42491 496
12.0	0.35819 48784	0.37283 17534	0.42033 350
12.2	0.35530 29318	0.36958 79032	0.41589 111
12.4	0.35247 99643	0.36642 69191	0.41158 108
12.6	0.34972 32746	0.36334 53438	0.40739 714
12.8	0.34703 03081	0.36033 99192	0.40333 342
13.0	0.34439 86455	0.35740 75702	0.39938 443
13.2	0.34182 59943	0.35454 53922	0.39554 499
13.4	0.33931 01806	0.35175 06397	0.39181 028
13.6	0.33684 91405	0.34902 07143	0.38817 572
13.8	0.33444 09142	0.34635 31558	0.38463 702
14.0	0.33208 36383	0.34374 56322	0.38119 016
14.2	0.32977 55402	0.34119 59314	0.37783 131
14.4	0.32751 49332	0.33870 19539	0.37455 687
14.6	0.32530 02091	0.33626 17039	0.37136 346
14.8	0.32312 98364	0.33387 32858	0.36824 785
15.0	0.32100 23534	0.33153 48949	0.36520 701
15.2	0.31891 63655	0.32924 48132	0.36223 805
15.4	0.31687 05405	0.32700 14043	0.35933 826
15.6	0.31486 36051	0.32480 31080	0.35650 503
15.8	0.31289 43424	0.32264 84361	0.35373 592
16.0	0.31096 15880	0.32053 59682	0.35102 858
16.2	0.30906 42269	0.31846 43471	0.34838 081
16.4	0.30720 11919	0.31643 22766	0.34579 049
16.6	0.30537 14592	0.31443 85164	0.34325 562
16.8	0.30357 40487	0.31248 18807	0.34077 427
17.0	0.30180 80193	0.31056 12340	0.33834 464
17.2	0.30007 24678	0.30867 54888	0.33596 497
17.4	0.29836 65276	0.30682 36027	0.33363 361
17.6	0.29668 93657	0.30500 45765	0.33134 898
17.8	0.29504 01817	0.30321 74518	0.32910 956
18.0	0.29341 82062	0.30146 13089	0.32691 391
18.2	0.29182 26987	0.29973 52642	0.32476 064
18.4	0.29025 29472	0.29803 84697	0.32264 843
18.6	0.28870 82654	0.29637 01096	0.32057 602
18.8	0.28718 79933	0.29472 94003	0.31854 218
19.0	0.28569 14944	0.29311 55877	0.31654 577
19.2	0.28421 81554	0.29152 79458	0.31458 565
19.4	0.28276 73848	0.28996 57766	0.31266 076
19.6	0.28133 86117	0.28842 84068	0.31077 008
19.8	0.27993 12862	0.28691 51886	0.30891 262
20.0	0.27854 48766 $\left[\begin{smallmatrix} (-5)1 \\ 6 \end{smallmatrix} \right]$	0.28542 54970 $\left[\begin{smallmatrix} (-5)2 \\ 6 \end{smallmatrix} \right]$	0.30708 743 $\left[\begin{smallmatrix} (-5)3 \\ 5 \end{smallmatrix} \right]$

Table 9.8 MODIFIED BESSEL FUNCTIONS—AUXILIARY TABLE FOR LARGE ARGUMENTS

x^{-1}	$x^{\frac{1}{2}}e^{-x}I_0(x)$	$x^{\frac{3}{2}}e^{-x}I_1(x)$	$x^{\frac{5}{2}}e^{-x}I_2(x)$	$\pi^{-1}x^{\frac{1}{2}}e^xK_0(x)$	$\pi^{-1}x^{\frac{3}{2}}e^xK_1(x)$	$\pi^{-1}x^{\frac{5}{2}}e^xK_2(x)$	$\langle x \rangle$
0.050	0.40150 9761	0.39133 9722	0.36237 579	0.39651 5620	0.40631 0355	0.43714 666	20
0.048	0.40140 4058	0.39164 8743	0.36380 578	0.39661 0241	0.40601 9771	0.43558 814	21
0.046	0.40129 8619	0.39195 7336	0.36523 854	0.39670 5057	0.40572 8854	0.43403 211	22
0.044	0.40119 3443	0.39226 5502	0.36667 408	0.39680 0069	0.40543 7604	0.43247 858	23
0.042	0.40108 8526	0.39257 3245	0.36811 237	0.39689 5278	0.40514 6017	0.43092 754	24
0.040	0.40098 3868	0.39288 0567	0.36955 342	0.39699 0686	0.40485 4094	0.42937 901	25
0.038	0.40087 9466	0.39318 7470	0.37099 722	0.39708 6293	0.40456 1832	0.42783 299	26
0.036	0.40077 5319	0.39349 3958	0.37244 375	0.39718 2101	0.40426 9230	0.42628 949	28
0.034	0.40067 1424	0.39380 0032	0.37389 302	0.39727 8110	0.40397 6286	0.42474 850	29
0.032	0.40056 7781	0.39410 5695	0.37534 502	0.39737 4322	0.40368 2998	0.42321 003	31
0.030	0.40046 4387	0.39441 0950	0.37679 973	0.39747 0738	0.40338 9365	0.42167 410	33
0.028	0.40036 1241	0.39471 5798	0.37825 716	0.39756 7359	0.40309 5386	0.42014 070	36
0.026	0.40025 8340	0.39502 0243	0.37971 729	0.39766 4186	0.40280 1058	0.41860 984	38
0.024	0.40015 5684	0.39532 4286	0.38118 012	0.39776 1221	0.40250 6380	0.41708 153	42
0.022	0.40005 3270	0.39562 7929	0.38264 564	0.39785 8465	0.40221 1349	0.41555 576	45
0.020	0.39995 1098	0.39593 1176	0.38411 385	0.39795 5918	0.40191 5965	0.41403 256	50
0.018	0.39984 9164	0.39623 4028	0.38558 474	0.39805 3583	0.40162 0226	0.41251 191	56
0.016	0.39974 7469	0.39653 6487	0.38705 830	0.39815 1460	0.40132 4130	0.41099 383	63
0.014	0.39964 6009	0.39683 8556	0.38853 453	0.39824 9551	0.40102 7674	0.40947 833	71
0.012	0.39954 4785	0.39714 0236	0.39001 342	0.39834 7857	0.40073 0858	0.40796 540	83
0.010	0.39944 3793	0.39744 1530	0.39149 496	0.39844 6379	0.40043 3679	0.40645 505	100
0.008	0.39934 3033	0.39774 2440	0.39297 915	0.39854 5119	0.40013 6136	0.40494 730	125
0.006	0.39924 2503	0.39804 2968	0.39446 599	0.39864 4077	0.39983 8226	0.40344 214	167
0.004	0.39914 2202	0.39834 3116	0.39595 546	0.39874 3256	0.39953 9949	0.40193 958	250
0.002	0.39904 2128	0.39864 2886	0.39744 756	0.39884 2657	0.39924 1300	0.40043 962	500
0.000	0.39894 2280 $\left[\begin{smallmatrix} (-8)3 \\ 3 \end{smallmatrix} \right]$	0.39894 2280 $\left[\begin{smallmatrix} (-8)5 \\ 3 \end{smallmatrix} \right]$	0.39894 228 $\left[\begin{smallmatrix} (-7)3 \\ 3 \end{smallmatrix} \right]$	0.39894 2280 $\left[\begin{smallmatrix} (-8)3 \\ 3 \end{smallmatrix} \right]$	0.39894 2280 $\left[\begin{smallmatrix} (-8)5 \\ 3 \end{smallmatrix} \right]$	0.39894 228 $\left[\begin{smallmatrix} (-7)3 \\ 3 \end{smallmatrix} \right]$	∞

For interpolating near $x^{-1}=0$ note that if $f_n(x^{-1})=x^{\frac{1}{2}}e^{-x}I_n(x)$ then $f_n(-x^{-1})=\pi^{-1}x^{\frac{1}{2}}e^xK_n(x)$.

$\langle x \rangle$ = nearest integer to x .

Compiled from L. Fox, A short table for Bessel functions of integer orders and large arguments. Royal Society Shorter Mathematical Tables No. 3 (Cambridge Univ. Press, Cambridge, England, 1954) (with permission).

MODIFIED BESSEL FUNCTIONS—AUXILIARY TABLE FOR SMALL ARGUMENTS

x	$K_0(x)+I_0(x) \ln x$	$x[K_1(x)-I_1(x) \ln x]$	x	$K_0(x)+I_0(x) \ln x$	$x[K_1(x)-I_1(x) \ln x]$
0.0	0.11593 152	1.00000 000	1.0	0.42102 444	0.60190 723
0.1	0.11872 387	0.99691 180	1.1	0.49199 896	0.49390 093
0.2	0.12713 128	0.98754 448	1.2	0.57261 444	0.36514 944
0.3	0.14124 511	0.97158 819	1.3	0.66373 364	0.21236 381
0.4	0.16121 862	0.94852 090	1.4	0.76632 938	+0.03176 677
0.5	0.18726 857	0.91759 992	1.5	0.88149 436	-0.18096 553
0.6	0.21967 734	0.87784 980	1.6	1.01045 200	-0.43076 964
0.7	0.25879 579	0.82804 659	1.7	1.15456 879	-0.72326 976
0.8	0.30504 682	0.76669 810	1.8	1.31536 786	-1.06486 242
0.9	0.35892 957	0.69201 997	1.9	1.49454 429	-1.46281 214
1.0	0.42102 444 $\left[\begin{smallmatrix} (-3)1 \\ 6 \end{smallmatrix} \right]$	0.60190 723 $\left[\begin{smallmatrix} (-3)2 \\ 7 \end{smallmatrix} \right]$	2.0	1.69398 200 $\left[\begin{smallmatrix} (-3)3 \\ 7 \end{smallmatrix} \right]$	-1.92535 914 $\left[\begin{smallmatrix} (-3)8 \\ 7 \end{smallmatrix} \right]$

MODIFIED BESSEL FUNCTIONS—ORDERS 3-9 Table 9.9

x	$e^{-x}I_3(x)$	$e^{-x}I_4(x)$	$e^{-x}I_5(x)$	$e^{-x}I_6(x)$	$e^{-x}I_7(x)$	$e^{-x}I_8(x)$	$e^{-x}I_9(x)$
0.0	0.0000	0.0000	0.0000	0.0000	0.0000	0.0000	0.0000
0.2	(-4) 1.3680	(-6) 3.4182	(-8) 6.8341	* (-9) 1.1388	(-11) 1.6265	(-13) 2.0328	(-15) 2.2585
0.4	(-4) 9.0273	(-5) 4.5047	(-6) 1.7995	(-8) 5.9925	(-9) 1.7109	(-11) 4.2750	(-13) 9.4957
0.6	(-3) 2.5257	(-4) 1.8858	(-5) 1.1281	(-7) 5.6286	(-8) 2.4084	(-10) 9.0201	(-11) 3.0037
0.8	(-3) 4.9877	(-4) 4.9483	(-5) 3.9377	(-6) 2.6152	(-7) 1.4902	(-10) 7.4343	(-10) 3.2983
1.0	(-3) 8.1553	(-3) 1.0069	(-5) 9.9866	(-6) 8.2731	(-7) 5.8832	(-8) 3.6643	(-9) 2.0301
1.2	(-2) 1.1855	(-3) 1.7471	(-4) 2.0719	(-5) 2.0544	(-6) 1.7497	(-7) 1.3058	(-8) 8.6707
1.4	(-2) 1.5911	(-3) 2.7189	(-4) 3.7459	(-5) 4.3203	(-6) 4.2831	(-7) 3.7225	(-8) 2.8797
1.6	(-2) 2.0168	(-3) 3.9110	(-4) 6.1288	(-5) 8.0504	(-6) 9.0974	(-7) 9.0178	(-8) 7.9596
1.8	(-2) 2.4495	(-3) 5.3023	(-4) 9.2978	(-4) 1.3686	(-5) 1.7349	(-6) 1.9302	(-7) 1.9131
2.0	(-2) 2.8791	(-3) 6.8654	(-3) 1.3298	(-4) 2.1656	(-5) 3.0402	(-6) 3.7487	(-7) 4.1199
2.2	(-2) 3.2978	(-3) 8.5701	(-3) 1.8142	(-4) 3.2349	(-5) 4.9776	(-6) 6.7325	(-7) 8.1206
2.4	(-2) 3.7001	(-2) 1.0386	(-3) 2.3819	(-4) 4.6097	(-5) 7.7080	(-6) 1.1339	(-7) 1.4883
2.6	(-2) 4.0823	(-2) 1.2283	(-3) 3.0293	(-4) 6.3166	(-5) 1.1395	(-6) 1.8099	(-7) 2.5669
2.8	(-2) 4.4421	(-2) 1.4234	(-3) 3.7511	(-4) 8.3747	(-5) 1.6197	(-6) 2.7609	(-7) 4.2048
3.0	(-2) 4.7783	(-2) 1.6216	(-3) 4.5409	(-3) 1.0796	(-4) 2.2265	(-5) 4.0512	(-6) 6.5905
3.2	(-2) 5.0907	(-2) 1.8206	(-3) 5.3913	(-3) 1.3584	(-4) 2.9735	(-5) 5.7482	(-6) 9.9425
3.4	(-2) 5.3795	(-2) 2.0188	(-3) 6.2947	(-3) 1.6738	(-4) 3.8725	(-5) 7.9208	(-6) 1.4507
3.6	(-2) 5.6454	(-2) 2.2145	(-3) 7.2431	(-3) 2.0249	(-4) 4.9334	(-5) 1.0638	(-6) 2.0556
3.8	(-2) 5.8893	(-2) 2.4065	(-3) 8.2288	(-3) 2.4106	(-4) 6.1640	(-5) 1.3965	(-6) 2.8380
4.0	(-2) 6.1124	(-2) 2.5940	(-3) 9.2443	(-3) 2.8291	(-4) 7.5698	(-5) 1.7968	(-6) 3.8284
4.2	(-2) 6.3161	(-2) 2.7761	(-3) 1.0283	(-3) 3.2785	(-4) 9.1545	(-5) 2.2703	(-6) 5.0587
4.4	(-2) 6.5015	(-2) 2.9523	(-2) 1.1337	(-3) 3.7566	(-4) 1.0919	(-5) 2.8224	(-6) 6.5607
4.6	(-2) 6.6699	(-2) 3.1221	(-2) 1.2402	(-3) 4.2609	(-4) 1.2864	(-5) 3.4578	(-6) 8.3667
4.8	(-2) 6.8227	(-2) 3.2854	(-2) 1.3471	(-3) 4.7890	(-4) 1.4986	(-5) 4.1806	(-6) 1.0508
5.0	(-2) 6.9611	(-2) 3.4419	(-2) 1.4540	(-3) 5.3384	(-4) 1.7282	(-5) 4.9939	(-6) 1.3015
5.2	(-2) 7.0861	(-2) 3.5916	(-2) 1.5605	(-3) 5.9065	(-4) 1.9747	(-5) 5.9005	(-6) 1.5916
5.4	(-2) 7.1989	(-2) 3.7346	(-2) 1.6662	(-3) 6.4909	(-4) 2.2374	(-5) 6.9020	(-6) 1.9240
5.6	(-2) 7.3005	(-2) 3.8708	(-2) 1.7707	(-3) 7.0892	(-4) 2.5157	(-5) 7.9996	(-6) 2.3010
5.8	(-2) 7.3917	(-2) 4.0005	(-2) 1.8738	(-3) 7.6990	(-4) 2.8087	(-5) 9.1937	(-6) 2.7249
6.0	(-2) 7.4736	(-2) 4.1238	(-2) 1.9752	(-3) 8.3181	(-4) 3.1156	(-5) 1.0484	(-6) 3.1978
6.2	(-2) 7.5468	(-2) 4.2408	(-2) 2.0747	(-3) 8.9445	(-4) 3.4355	(-5) 1.1870	(-6) 3.7214
6.4	(-2) 7.6121	(-2) 4.3518	(-2) 2.1723	(-3) 9.5763	(-4) 3.7674	(-5) 1.3351	(-6) 4.2971
6.6	(-2) 7.6702	(-2) 4.4570	(-2) 2.2677	(-3) 1.0212	(-4) 4.1105	(-5) 1.4924	(-6) 4.9261
6.8	(-2) 7.7216	(-2) 4.5567	(-2) 2.3608	(-2) 1.0849	(-3) 4.4637	(-4) 1.6587	(-5) 5.6094
7.0	(-2) 7.7670	(-2) 4.6509	(-2) 2.4516	(-2) 1.1486	(-3) 4.8261	(-4) 1.8337	(-5) 6.3475
7.2	(-2) 7.8068	(-2) 4.7401	(-2) 2.5401	(-2) 1.2122	(-3) 5.1969	(-4) 2.0172	(-5) 7.1409
7.4	(-2) 7.8416	(-2) 4.8244	(-2) 2.6261	(-2) 1.2756	(-3) 5.5750	(-4) 2.2089	(-5) 7.9897
7.6	(-2) 7.8717	(-2) 4.9040	(-2) 2.7096	(-2) 1.3387	(-3) 5.9596	(-4) 2.4084	(-5) 8.8937
7.8	(-2) 7.8975	(-2) 4.9791	(-2) 2.7907	(-2) 1.4012	(-3) 6.3499	(-4) 2.6152	(-5) 9.8527
8.0	(-2) 7.9194	(-2) 5.0500	(-2) 2.8694	(-2) 1.4633	(-3) 6.7449	(-4) 2.8292	(-5) 1.0866
8.2	(-2) 7.9378	(-2) 5.1169	(-2) 2.9456	(-2) 1.5247	(-3) 7.1440	(-4) 3.0497	(-5) 1.1933
8.4	(-2) 7.9528	(-2) 5.1800	(-2) 3.0195	(-2) 1.5854	(-3) 7.5464	(-4) 3.2766	(-5) 1.3053
8.6	(-2) 7.9649	(-2) 5.2395	(-2) 3.0909	(-2) 1.6453	(-3) 7.9513	(-4) 3.5093	(-5) 1.4224
8.8	(-2) 7.9741	(-2) 5.2954	(-2) 3.1601	(-2) 1.7045	(-3) 8.3582	(-4) 3.7475	(-5) 1.5446
9.0	(-2) 7.9808	(-2) 5.3482	(-2) 3.2269	(-2) 1.7627	(-3) 8.7663	(-4) 3.9907	(-5) 1.6716
9.2	(-2) 7.9852	(-2) 5.3978	(-2) 3.2915	(-2) 1.8201	(-3) 9.1750	(-4) 4.2386	(-5) 1.8035
9.4	(-2) 7.9875	(-2) 5.4445	(-2) 3.3539	(-2) 1.8765	(-3) 9.5839	(-4) 4.4908	(-5) 1.9399
9.6	(-2) 7.9878	(-2) 5.4883	(-2) 3.4141	(-2) 1.9319	(-3) 9.9924	(-4) 4.7470	(-5) 2.0808
9.8	(-2) 7.9862	(-2) 5.5296	(-2) 3.4723	(-2) 1.9864	(-3) 1.0400	(-4) 5.0066	(-5) 2.2260
10.0	(-2) 7.9830	(-2) 5.5683	(-2) 3.5284	(-2) 2.0398	(-3) 1.0806	(-4) 5.2694	(-5) 2.3753
10.5	(-2) 7.9687	(-2) 5.6549	(-2) 3.6602	(-2) 2.1690	(-3) 1.1814	(-4) 5.9380	(-5) 2.7653
11.0	(-2) 7.9465	(-2) 5.7284	(-2) 3.7804	(-2) 2.2916	(-3) 1.2805	(-4) 6.6192	(-5) 3.1769
11.5	(-2) 7.9182	(-2) 5.7905	(-2) 3.8900	(-2) 2.4078	(-3) 1.3775	(-4) 7.3082	(-5) 3.6073
12.0	(-2) 7.8848	(-2) 5.8425	(-2) 3.9898	(-2) 2.5176	(-3) 1.4722	(-4) 8.0010	(-5) 4.0537
12.5	(-2) 7.8474	(-2) 5.8857	(-2) 4.0805	(-2) 2.6212	(-3) 1.5642	(-4) 8.6939	(-5) 4.5134
13.0	(-2) 7.8067	(-2) 5.9211	(-2) 4.1630	(-2) 2.7188	(-3) 1.6533	(-4) 9.3836	(-5) 4.9837
13.5	(-2) 7.7635	(-2) 5.9497	(-2) 4.2378	(-2) 2.8106	(-3) 1.7394	(-4) 1.0068	(-5) 5.4622
14.0	(-2) 7.7183	(-2) 5.9723	(-2) 4.3056	(-2) 2.8969	(-3) 1.8225	(-4) 1.0744	(-5) 5.9469
14.5	(-2) 7.6716	(-2) 5.9896	(-2) 4.3670	(-2) 2.9779	(-3) 1.9025	(-4) 1.1410	(-5) 6.4354
15.0	(-2) 7.6236	(-2) 6.0022	(-2) 4.4225	(-2) 3.0538	(-3) 1.9794	(-4) 1.2064	(-5) 6.9260
15.5	(-2) 7.5749	(-2) 6.0106	(-2) 4.4726	(-2) 3.1251	(-3) 2.0532	(-4) 1.2705	(-5) 7.4171
16.0	(-2) 7.5256	(-2) 6.0155	(-2) 4.5179	(-2) 3.1918	(-3) 2.1240	(-4) 1.3333	(-5) 7.9071
16.5	(-2) 7.4759	(-2) 6.0170	(-2) 4.5585	(-2) 3.2543	(-3) 2.1918	(-4) 1.3946	(-5) 8.3947
17.0	(-2) 7.4260	(-2) 6.0158	(-2) 4.5951	(-2) 3.3128	(-3) 2.2567	(-4) 1.4543	(-5) 8.8788
17.5	(-2) 7.3761	(-2) 6.0119	(-2) 4.6278	(-2) 3.3675	(-3) 2.3187	(-4) 1.5125	(-5) 9.3584
18.0	(-2) 7.3263	(-2) 6.0059	(-2) 4.6571	(-2) 3.4186	(-3) 2.3780	(-4) 1.5691	(-5) 9.8324
18.5	(-2) 7.2768	(-2) 5.9978	(-2) 4.6831	(-2) 3.4664	(-3) 2.4346	(-4) 1.6240	(-5) 1.0300
19.0	(-2) 7.2275	(-2) 5.9880	(-2) 4.7062	(-2) 3.5111	(-3) 2.4886	(-4) 1.6774	(-5) 1.0761
19.5	(-2) 7.1785	(-2) 5.9767	(-2) 4.7266	(-2) 3.5528	(-3) 2.5402	(-4) 1.7291	(-5) 1.1215
20.0	(-2) 7.1300	(-2) 5.9640	(-2) 4.7444	(-2) 3.5917	(-3) 2.5894	(-4) 1.7792	(-5) 1.1661

Compiled from British Association for the Advancement of Science, Bessel functions, Part II. Functions of positive integer order, Mathematical Tables, vol. X (Cambridge Univ. Press, Cambridge, England, 1952) (with permission).

*See page II.

Table 9.9 MODIFIED BESSEL FUNCTIONS—ORDERS 3-9

x	$e^x K_3(x)$	$e^x K_4(x)$	$e^x K_5(x)$	$e^x K_6(x)$	$e^x K_7(x)$	$e^x K_8(x)$	$e^x K_9(x)$
0.0	∞	∞	∞	∞	∞	∞	∞
0.2	(3)1.2153	(4)3.6520	(6)1.4620	(7)7.3138	(9)4.3897	(11)3.0735	(13)2.4593
0.4	(2)1.8282	(3)2.7602	(4)5.5388	(6)1.3875	(7)4.1679	(9)1.4602	(10)5.8448
0.6	(1)6.4573	(2)6.5506	(3)8.7987	(5)1.4730	(6)2.9548	(7)6.9092	(9)1.8454
0.8	(1)3.2183	(2)2.4743	(3)2.5064	(4)3.1578	(5)4.7618	(6)8.3647	(8)1.6777
1.0	(1)1.9303	(2)1.2024	(2)9.8119	(3)9.9322	(5)1.2017	(6)1.6923	(7)2.7197
1.2	(1)1.2984	(1)6.8382	(2)4.6886	(3)3.9756	(4)4.0225	(5)4.7326	(6)6.3504
1.4	(0)9.4345	(1)4.3280	(2)2.5675	(3)1.8772	(4)1.6347	(5)1.6535	(6)1.9061
1.6	(0)7.2438	(1)2.9585	(2)1.5517	(2)9.9939	(3)7.6506	(4)6.7942	(5)6.8707
1.8	(0)5.7946	(1)2.1426	(2)1.0102	(2)5.8265	(3)3.9853	(4)3.1580	(5)2.8469
2.0	(0)4.7836	(1)1.6226	(1)6.9687	(2)3.6466	(3)2.2576	(4)1.6168	(5)1.3160
2.2	(0)4.0481	(1)1.2731	(1)5.0344	(2)2.4157	(3)1.3680	(3)8.9469	(4)6.6436
2.4	(0)3.4948	(1)1.0280	(1)3.7762	(2)1.6762	(2)8.7586	(3)5.2768	(4)3.6055
2.6	(0)3.0667	(0)8.4989	(1)2.9217	(2)1.2087	(2)5.8709	(3)3.2821	(4)2.0785
2.8	(0)2.7276	(0)7.1659	(1)2.3202	(1)9.0029	(2)4.0904	(3)2.1352	(4)1.2610
3.0	(0)2.4539	(0)6.1432	(1)1.8836	(1)6.8929	(2)2.9455	(3)1.4435	(3)7.9932
3.2	(0)2.2290	(0)5.3415	(1)1.5583	(1)5.4037	(2)2.1822	(3)1.0088	(3)5.2620
3.4	(0)2.0415	(0)4.7013	(1)1.3103	(1)4.3240	(2)1.6572	(2)7.2560	(3)3.5803
3.6	(0)1.8833	(0)4.1817	(1)1.1176	(1)3.5226	(2)1.2860	(2)5.3532	(3)2.5078
3.8	(0)1.7482	(0)3.7541	(0)9.6515	(1)2.9153	(2)1.0171	(2)4.0388	(3)1.8023
4.0	(0)1.6317	(0)3.3976	(0)8.4268	(1)2.4465	(1)8.1821	(2)3.1084	(3)1.3252
4.2	(0)1.5303	(0)3.0971	(0)7.4295	(1)2.0786	(1)6.6819	(2)2.4352	(2)9.9450
4.4	(0)1.4414	(0)2.8412	(0)6.6072	(1)1.7858	(1)5.5310	(2)1.9384	(2)7.6019
4.6	(0)1.3629	(0)2.6213	(0)5.9217	(1)1.5495	(1)4.6342	(2)1.5654	(2)5.9082
4.8	(0)1.2931	(0)2.4309	(0)5.3445	(1)1.3565	(1)3.9258	(2)1.2807	(2)4.6615
5.0	(0)1.2306	(0)2.2646	(0)4.8540	(1)1.1973	(1)3.3589	(2)1.0602	(2)3.7285
5.2	(0)1.1745	(0)2.1186	(0)4.4338	(1)1.0645	(1)2.9000	(1)8.8721	(2)3.0199
5.4	(0)1.1237	(0)1.9895	(0)4.0711	(0)9.5285	(1)2.5245	(1)7.4980	(2)2.4741
5.6	(0)1.0777	(0)1.8746	(0)3.7557	(0)8.5813	(1)2.2144	(1)6.3942	(2)2.0483
5.8	(0)1.0357	(0)1.7720	(0)3.4798	(0)7.7717	(1)1.9559	(1)5.4983	(2)1.7124
6.0	(-1)9.9723	(0)1.6798	(0)3.2370	(0)7.0748	(1)1.7387	(1)4.7644	(2)1.4444
6.2	(-1)9.6194	(0)1.5967	(0)3.0221	(0)6.4711	(1)1.5547	(1)4.1577	(2)1.2284
6.4	(-1)9.2942	(0)1.5213	(0)2.8311	(0)5.9448	(1)1.3978	(1)3.6521	(2)1.0528
6.6	(-1)8.9936	(0)1.4528	(0)2.6603	(0)5.4835	(1)1.2630	(1)3.2275	(1)9.0873
6.8	(-1)8.7149	(0)1.3902	(0)2.5071	(0)5.0771	(1)1.1467	(1)2.8685	(1)7.8960
7.0	(-1)8.4559	(0)1.3329	(0)2.3689	(0)4.7171	(1)1.0455	(1)2.5628	(1)6.9034
7.2	(-1)8.2145	(0)1.2803	(0)2.2440	(0)4.3970	(0)9.5723	(1)2.3010	(1)6.0705
7.4	(-1)7.9890	(0)1.2318	(0)2.1306	(0)4.1110	(0)8.7970	(1)2.0754	(1)5.3671
7.6	(-1)7.7778	(0)1.1870	(0)2.0273	(0)3.8544	(0)8.1132	(1)1.8800	(1)4.7692
7.8	(-1)7.5797	(0)1.1455	(0)1.9328	(0)3.6235	(0)7.5074	(1)1.7098	(1)4.2581
8.0	(-1)7.3935	(0)1.1069	(0)1.8463	(0)3.4148	(0)6.9684	(1)1.5610	(1)3.8188
8.2	(-1)7.2182	(0)1.0710	(0)1.7667	(0)3.2256	(0)6.4871	(1)1.4301	(1)3.4392
8.4	(-1)7.0527	(0)1.0376	(0)1.6934	(0)3.0535	(0)6.0556	(1)1.3146	(1)3.1096
8.6	(-1)6.8963	(0)1.0062	(0)1.6257	(0)2.8966	(0)5.6674	(1)1.2123	(1)2.8221
8.8	(-1)6.7483	(-1)9.7693	(0)1.5629	(0)2.7530	(0)5.3170	(1)1.1212	(1)2.5702
9.0	(-1)6.6079	(-1)9.4941	(0)1.5047	(0)2.6213	(0)4.9998	(1)1.0399	(1)2.3486
9.2	(-1)6.4746	(-1)9.2354	(0)1.4505	(0)2.5002	(0)4.7117	(0)9.6702	(1)2.1529
9.4	(-1)6.3480	(-1)8.9918	(0)1.4001	(0)2.3886	(0)4.4493	(0)9.0153	(1)1.9794
9.6	(-1)6.2274	(-1)8.7620	(0)1.3529	(0)2.2855	(0)4.2098	(0)8.4247	(1)1.8251
9.8	(-1)6.1125	(-1)8.5449	(0)1.3088	(0)2.1900	(0)3.9904	(0)7.8906	(1)1.6873
10.0	(-1)6.0028	(-1)8.3395	(0)1.2674	(0)2.1014	(0)3.7891	(0)7.4062	(1)1.5639
10.5	(-1)5.7493	(-1)7.8717	(0)1.1747	(0)1.9059	(0)3.3529	(0)6.3764	(1)1.3069
11.0	(-1)5.5217	(-1)7.4597	(0)1.0947	(0)1.7411	(0)2.9941	(0)5.5518	(1)1.1070
11.5	(-1)5.3161	(-1)7.0942	(0)1.0251	(0)1.6008	(0)2.6956	(0)4.8824	(0)9.4885
12.0	(-1)5.1294	(-1)6.7680	(-1)9.6415	(0)1.4803	(0)2.4444	(0)4.3321	(0)8.2205
12.5	(-1)4.9591	(-1)6.4751	(-1)9.1031	(0)1.3758	(0)2.2310	(0)3.8745	(0)7.1904
13.0	(-1)4.8030	(-1)6.2106	(-1)8.6249	(0)1.2845	(0)2.0482	(0)3.4902	(0)6.3439
13.5	(-1)4.6593	(-1)5.9706	(-1)8.1974	(0)1.2043	(0)1.8902	(0)3.1645	(0)5.6407
14.0	(-1)4.5266	(-1)5.7519	(-1)7.8133	(0)1.1333	(0)1.7527	(0)2.8860	(0)5.0510
14.5	(-1)4.4036	(-1)5.5517	(-1)7.4666	(0)1.0701	(0)1.6323	(0)2.6461	(0)4.5521
15.0	(-1)4.2892	(-1)5.3678	(-1)7.1520	(0)1.0136	(0)1.5261	(0)2.4379	(0)4.1265
15.5	(-1)4.1826	(-1)5.1982	(-1)6.8656	(-1)9.6276	(0)1.4319	(0)2.2561	(0)3.7608
16.0	(-1)4.0829	(-1)5.0414	(-1)6.6036	(-1)9.1686	(0)1.3480	(0)2.0964	(0)3.4444
16.5	(-1)3.9895	(-1)4.8959	(-1)6.3633	(-1)8.7524	(0)1.2729	(0)1.9552	(0)3.1689
17.0	(-1)3.9017	(-1)4.7605	(-1)6.1420	(-1)8.3734	(0)1.2053	(0)1.8299	(0)2.9275
17.5	(-1)3.8191	(-1)4.6343	(-1)5.9376	(-1)8.0272	(0)1.1442	(0)1.7181	(0)2.7150
18.0	(-1)3.7411	(-1)4.5162	(-1)5.7483	(-1)7.7097	(0)1.0888	(0)1.6178	(0)2.5269
18.5	(-1)3.6674	(-1)4.4055	(-1)5.5725	(-1)7.4176	(0)1.0384	(0)1.5276	(0)2.3595
19.0	(-1)3.5976	(-1)4.3015	(-1)5.4087	(-1)7.1482	(-1)9.9234	(0)1.4460	(0)2.2100
19.5	(-1)3.5313	(-1)4.2037	(-1)5.2559	(-1)6.8990	(-1)9.5015	(0)1.3721	(0)2.0759
20.0	(-1)3.4684	(-1)4.1114	(-1)5.1130	(-1)6.6679	(-1)9.1137	(0)1.3048	(0)1.9552

MODIFIED BESSEL FUNCTIONS—ORDERS 10, 11, 20 AND 21 Table 9.10

x	$10^9 x^{-10} I_{10}(x)$	$10^{11} x^{-11} I_{11}(x)$	$10^{-8} x^{10} K_{10}(x)$	$10^{24} x^{-20} I_{20}(x)$	$10^{26} x^{-21} I_{21}(x)$	$10^{-22} x^{20} K_{20}(x)$
0.0	0.26911 445	1.22324 748	1.85794 560	0.391990	0.933311	6.37771
0.2	0.26935 920	1.22426 724	1.85588 251	0.392177	0.933736	6.37435
0.4	0.27009 468	1.22733 125	1.84970 867	0.392738	0.935008	6.36429
0.6	0.27132 457	1.23245 366	1.83947 021	0.393674	0.937136	6.34757
0.8	0.27305 504	1.23965 820	1.82524 326	0.394988	0.940123	6.32424
1.0	0.27529 480	1.24897 831	1.80713 290	0.396684	0.943974	6.29437
1.2	0.27805 517	1.26045 740	1.78527 169	0.398766	0.948703	6.25807
1.4	0.28135 012	1.27414 918	1.75981 781	0.401239	0.954321	6.21545
1.6	0.28519 648	1.29011 798	1.73095 297	0.404112	0.960843	6.16665
1.8	0.28961 396	1.30843 932	1.69887 992	0.407392	0.968285	6.11184
2.0	0.29462 538	1.32920 036	1.66381 982	0.411087	0.976669	6.05118
2.2	0.30025 682	1.35250 061	1.62600 944	0.415209	0.986016	5.98488
2.4	0.30653 784	1.37845 262	1.58569 822	0.419768	0.996351	5.91314
2.6	0.31350 170	1.40718 285	1.54314 529	0.424778	1.007703	5.83620
2.8	0.32118 565	1.43883 260	1.49861 645	0.430253	1.020101	5.75428
3.0	0.32963 121	1.47355 907	1.45238 126	0.436209	1.033581	5.66764
3.2	0.33888 455	1.51153 657	1.40471 020	0.442662	1.048178	5.57655
3.4	0.34899 681	1.55295 782	1.35587 192	0.449632	1.063935	5.48128
3.6	0.36002 459	1.59803 551	1.30613 075	0.457139	1.080893	5.38210
3.8	0.37203 039	1.64700 388	1.25574 432	0.465205	1.099102	5.27932
4.0	0.38508 316	1.70012 064	1.20496 150	0.473853	1.118613	5.17321
4.2	0.39925 889	1.75766 896	1.15402 052	0.483111	1.139481	5.06408
4.4	0.41464 125	1.81995 978	1.10314 736	0.493006	1.161768	4.95224
4.6	0.43132 237	1.88733 435	1.05255 442	0.503569	1.185538	4.83797
4.8	0.44940 362	1.96016 700	1.00243 944	0.514832	1.210861	4.72159
5.0	0.46899 655	2.03886 82	0.95298 465	0.526830	1.237813	4.60339
5.2	0.49022 387	2.12388 83	0.90435 626	0.539601	1.266475	4.48367
5.4	0.51322 061	2.21572 08	0.85670 405	0.553186	1.296933	4.36272
5.6	0.53813 536	2.31490 71	0.81016 129	0.567630	1.329281	4.24084
5.8	0.56513 169	2.42204 09	0.76484 483	0.582979	1.363622	4.11830
6.0	0.59438 965	2.53777 36	0.72085 532	0.599284	1.400061	3.99537
6.2	0.62610 759	2.66282 00	0.67827 767	0.616599	1.438715	3.87234
6.4	0.66050 400	2.79796 48	0.63718 161	0.634984	1.479709	3.74945
6.6	0.69781 972	2.94406 93	0.59762 235	0.654501	1.523176	3.62695
6.8	0.73832 033	3.10208 00	0.55964 137	0.675219	1.569259	3.50507
7.0	0.78229 881	3.27303 69	0.52326 729	0.697210	1.618113	3.38405
7.2	0.83007 854	3.45808 34	0.48851 672	0.720554	1.669904	3.26411
7.4	0.88201 663	3.65847 74	0.45539 529	0.745333	1.724808	3.14543
7.6	0.93850 764	3.87560 29	0.42389 854	0.771639	1.783016	3.02821
7.8	0.99998 773	4.11098 38	0.39401 295	0.799570	1.844734	2.91264
8.0	1.06693 936	4.36629 90	0.36571 690	0.829231	1.910180	2.79887
8.2	1.13989 641	4.64339 88	0.33898 159	0.860735	1.979593	2.68705
8.4	1.21945 007	4.94432 35	0.31377 202	0.894204	2.053225	2.57733
8.6	1.30625 534	5.27132 42	0.29004 783	0.929769	2.131351	2.46983
8.8	1.40103 829	5.62688 64	0.26776 418	0.967571	2.214264	2.36466
9.0	1.50460 429	6.01375 48	0.24687 251	1.007764	2.302281	2.26193
9.2	1.61784 713	6.43496 31	0.22732 134	1.050510	2.395741	2.16172
9.4	1.74175 933	6.89386 57	0.20905 690	1.095988	2.495011	2.06411
9.6	1.87744 369	7.39417 36	0.19202 382	1.144389	2.600488	1.96916
9.8	2.02612 620	7.93999 51	0.17616 568	1.195919	2.712593	1.87692
10.0	2.18917 062 $\left[\begin{smallmatrix} (-3)2 \\ 7 \end{smallmatrix} \right]$	8.53588 02 $\left[\begin{smallmatrix} (-3)6 \\ 6 \end{smallmatrix} \right]$	0.16142 553 $\left[\begin{smallmatrix} (-4)5 \\ 6 \end{smallmatrix} \right]$	1.250800 $\left[\begin{smallmatrix} (-4)4 \\ 4 \end{smallmatrix} \right]$	2.831786 $\left[\begin{smallmatrix} (-4)9 \\ 5 \end{smallmatrix} \right]$	1.78744 $\left[\begin{smallmatrix} (-4)8 \\ 4 \end{smallmatrix} \right]$

$$I_{n+1}(x) = -\frac{2n}{x} I_n(x) + I_{n-1}(x)$$

$$K_{n+1}(x) = \frac{2n}{x} K_n(x) + K_{n-1}(x)$$

Compiled from British Association for the Advancement of Science, Bessel functions, Part II. Functions of positive integer order, Mathematical Tables, vol. X (Cambridge Univ. Press, Cambridge, England, 1952) and L. Fox, A short table for Bessel functions of integer orders and large arguments. Royal Society Shorter Mathematical Tables No. 3 (Cambridge Univ. Press, Cambridge, England, 1954) (with permission).

Table 9.10

MODIFIED BESSEL FUNCTIONS—ORDERS 10, 11, 20 AND 21

x	$e^{-x}I_{10}(x)$	$e^{-x}I_{11}(x)$	$e^xK_{10}(x)$	$10^{24}x^{-20}I_{20}(x)$	$10^{26}x^{-21}I_{21}(x)$	$10^{-22}x^{20}K_{20}(x)$
10.0	0.00099 38819	0.00038 75284	35.55633 91	1.25080	2.83179	1.787443
10.2	0.00107 29935	0.00042 45861	32.60759 68	1.30927	2.95856	1.700753
10.4	0.00115 52835	0.00046 37417	29.98423 91	1.37160	3.09345	1.616873
10.6	0.00124 06973	0.00050 50080	27.64297 29	1.43806	3.23703	1.535814
10.8	0.00132 91744	0.00054 83934	25.54714 23	1.50895	3.38992	1.457578
11.0	0.00142 06490	0.00059 39013	23.66558 79	1.58462	3.55278	1.382160
11.2	0.00151 50508	0.00064 15309	21.97172 20	1.66540	3.72634	1.309546
11.4	0.00161 23051	0.00069 12768	20.44277 46	1.75169	3.91139	1.239714
11.6	0.00171 23339	0.00074 31298	19.05917 72	1.84390	4.10876	1.172637
11.8	0.00181 50559	0.00079 70766	17.80405 56	1.94249	4.31937	1.108279
12.0	0.00192 03870	0.00085 31003	16.66281 24	2.04795	4.54421	1.046601
12.2	0.00202 82412	0.00091 11805	15.62277 97	2.16080	4.78434	0.987556
12.4	0.00213 85303	0.00097 12937	14.67293 16	2.28162	5.04093	0.931095
12.6	0.00225 11650	0.00103 34132	13.80364 34	2.41105	5.31521	0.877164
12.8	0.00236 60548	0.00109 75097	13.00649 01	2.54975	5.60856	0.825703
13.0	0.00248 31086	0.00116 35512	12.27407 71	2.69846	5.92244	0.776652
13.2	0.00260 22347	0.00123 15035	11.59989 74	2.85799	6.25845	0.729947
13.4	0.00272 33415	0.00130 13301	10.97821 07	3.02921	6.61832	0.685520
13.6	0.00284 63375	0.00137 29926	10.40394 07	3.21306	7.00393	0.643305
13.8	0.00297 11314	0.00144 64509	9.87258 79	3.41058	7.41731	0.603230
14.0	0.00309 76327	0.00152 16634	9.38015 52	3.62289	7.86068	0.565225
14.2	0.00322 57518	0.00159 85870	8.92308 36	3.85121	8.33644	0.529218
14.4	0.00335 53999	0.00167 71776	8.49819 79	4.09686	8.84722	0.495137
14.6	0.00348 64894	0.00175 73898	8.10265 95	4.36131	9.39585	0.462910
14.8	0.00361 89341	0.00183 91776	7.73392 53	4.64613	9.98543	0.432464
15.0	0.00375 26491	0.00192 24942	7.38971 31	4.95305	10.61932	0.403728
15.2	0.00388 75510	0.00200 72921	7.06797 04	5.28394	11.30119	0.376630
15.4	0.00402 35583	0.00209 35235	6.76684 87	5.64087	12.03503	0.351101
15.6	0.00416 05908	0.00218 11403	6.48467 94	6.02608	12.82520	0.327070
15.8	0.00429 85705	0.00227 00942	6.21995 46	6.44202	13.67643	0.304470
16.0	0.00443 74209	0.00236 03366	5.97130 87	6.89137	14.59389	0.283235
16.2	0.00457 70675	0.00245 18192	5.73750 35	7.37705	15.58322	0.263299
16.4	0.00471 74378	0.00254 44936	5.51741 43	7.90228	16.65059	0.244598
16.6	0.00485 84612	0.00263 83118	5.31001 78	8.47055	17.80271	0.227071
16.8	0.00500 00690	0.00273 32259	5.11438 19	9.08571	19.04691	0.210658
17.0	0.00514 21947	0.00282 91884	4.92965 63	9.75197	20.39124	0.195301
17.2	0.00528 47735	0.00292 61523	4.75506 40	10.47392	21.84444	0.180944
17.4	0.00542 77427	0.00302 40709	4.58989 42	11.25663	23.41611	0.167532
17.6	0.00557 10418	0.00312 28982	4.43349 60	12.10562	25.11674	0.155012
17.8	0.00571 46119	0.00322 25887	4.28527 20	13.02697	26.95781	0.143336
18.0	0.00585 83964	0.00332 30977	4.14467 40	14.02734	28.95188	0.132454
18.2	0.00600 23403	0.00342 43808	4.01119 75	15.11406	31.11272	0.122321
18.4	0.00614 63909	0.00352 63948	3.88437 85	16.29515	33.45541	0.112891
18.6	0.00629 04971	0.00362 90969	3.76378 89	17.57946	35.99648	0.104124
18.8	0.00643 46098	0.00373 24450	3.64903 41	18.97668	38.75407	0.095978
19.0	0.00657 86817	0.00383 63982	3.53974 93	20.49749	41.74804	0.088414
19.2	0.00672 26672	0.00394 09161	3.43559 74	22.15363	45.00024	0.081397
19.4	0.00686 65226	0.00404 59590	3.33626 62	23.95803	48.53460	0.074892
19.6	0.00701 02059	0.00415 14885	3.24146 65	25.92489	52.37745	0.068865
19.8	0.00715 36768	0.00425 74667	3.15093 00	28.06989	56.55768	0.063285
20.0	0.00729 68965 $\left[\begin{smallmatrix} (-7)4 \\ 5 \end{smallmatrix} \right]$	0.00436 38567 $\left[\begin{smallmatrix} (-7)3 \\ 5 \end{smallmatrix} \right]$	3.06440 75 $\left[\begin{smallmatrix} (-2)4 \\ 8 \end{smallmatrix} \right]$	30.41029 $\left[\begin{smallmatrix} (-2)2 \\ 5 \end{smallmatrix} \right]$	61.10706 $\left[\begin{smallmatrix} (-2)5 \\ 5 \end{smallmatrix} \right]$	0.058124 $\left[\begin{smallmatrix} (-4)4 \\ 4 \end{smallmatrix} \right]$

MODIFIED BESSEL FUNCTIONS—AUXILIARY TABLE FOR LARGE ARGUMENTS

Table 9.10

x^{-1}	$\ln [x^{\frac{1}{2}}e^{-x}I_{10}(x)]$	$\ln [x^{\frac{1}{2}}e^{-x}I_{11}(x)]$	$\ln [\pi^{-1}x^{\frac{1}{2}}e^{-x}K_{10}(x)]$	$\ln [x^{\frac{1}{2}}e^{-x}I_{20}(x)]$	$\ln [x^{\frac{1}{2}}e^{-x}I_{21}(x)]$	$\ln [\pi^{-1}x^{\frac{1}{2}}e^{-x}K_{20}(x)]$	$\langle x \rangle$
0.050	-3.42244 002	-3.93653 292	1.47299 048	-10.434749	-11.346341	8.250182	20
0.049	-3.37318 689	-3.87762 888	1.42771 939	-10.263511	-11.160467	8.088946	20
0.048	-3.32386 306	-3.81861 524	1.38232 785	-10.091302	-10.973471	7.926737	21
0.047	-3.27447 055	-3.75949 454	1.33681 644	-9.918126	-10.785351	7.763551	21
0.046	-3.22501 139	-3.70026 938	1.29118 575	-9.743983	-10.596108	7.599386	22
0.045	-3.17548 766	-3.64094 242	1.24543 642	-9.568876	-10.405744	7.434240	22
0.044	-3.12590 147	-3.58151 639	1.19956 910	-9.392809	-10.214259	7.268110	23
0.043	-3.07625 496	-3.52199 408	1.15358 449	-9.215785	-10.021658	7.100994	23
0.042	-3.02655 033	-3.46237 835	1.10748 332	-9.037810	-9.827944	6.932893	24
0.041	-2.97678 979	-3.40267 211	1.06126 635	-8.858889	-9.633121	6.763806	24
0.040	-2.92697 559	-3.34287 833	1.01493 437	-8.679029	-9.437195	6.593733	25
0.039	-2.87711 002	-3.28300 006	0.96848 822	-8.498236	-9.240173	6.422673	26
0.038	-2.82719 539	-3.22304 039	0.92192 874	-8.316519	-9.042063	6.250630	26
0.037	-2.77723 405	-3.16300 246	0.87525 686	-8.133888	-8.842873	6.077603	27
0.036	-2.72722 837	-3.10288 949	0.82847 349	-7.950352	-8.642612	5.903597	28
0.035	-2.67718 076	-3.04270 472	0.78157 961	-7.765923	-8.441293	5.728614	29
0.034	-2.62709 365	-2.98245 146	0.73457 624	-7.580613	-8.238927	5.552659	29
0.033	-2.57696 948	-2.92213 308	0.68746 441	-7.394434	-8.035529	5.375732	30
0.032	-2.52681 074	-2.86175 298	0.64024 520	-7.207403	-7.831113	5.197843	31
0.031	-2.47661 992	-2.80131 461	0.59291 975	-7.019533	-7.625695	5.018998	32
0.030	-2.42639 955	-2.74082 147	0.54548 920	-6.830842	-7.419294	4.839203	33
0.029	-2.37615 216	-2.68027 709	0.49795 475	-6.641348	-7.211929	4.658466	34
0.028	-2.32588 032	-2.61968 504	0.45031 764	-6.451070	-7.003620	4.476796	36
0.027	-2.27558 659	-2.55904 894	0.40257 915	-6.260027	-6.794389	4.294202	37
0.026	-2.22527 356	-2.49837 243	0.35474 059	-6.068243	-6.584261	4.110696	38
0.025	-2.17494 384	-2.43765 918	0.30680 331	-5.875738	-6.373261	3.926290	40
0.024	-2.12460 002	-2.37691 291	0.25876 871	-5.682539	-6.161416	3.740995	42
0.023	-2.07424 475	-2.31613 733	0.21063 822	-5.488669	-5.948754	3.554826	43
0.022	-2.02388 063	-2.25533 620	0.16241 332	-5.294155	-5.735305	3.367799	45
0.021	-1.97351 031	-2.19451 329	0.11409 551	-5.099025	-5.521102	3.179929	48
0.020	-1.92313 643	-2.13367 239	0.06568 636	-4.903309	-5.306177	2.991233	50
0.019	-1.87276 162	-2.07281 731	+0.01718 745	-4.707035	-5.090565	2.801730	53
0.018	-1.82238 853	-2.01195 186	-0.03139 959	-4.510235	-4.874302	2.611440	56
0.017	-1.77201 979	-1.95107 986	-0.08007 306	-4.312943	-4.657427	2.420383	59
0.016	-1.72165 806	-1.89020 514	-0.12883 128	-4.115190	-4.439978	2.228582	63
0.015	-1.67130 595	-1.82933 153	-0.17767 247	-3.917011	-4.221995	2.036059	67
0.014	-1.62096 610	-1.76846 286	-0.22659 485	-3.718443	-4.003521	1.842840	71
0.013	-1.57064 113	-1.70760 295	-0.27559 659	-3.519520	-3.784599	1.648949	77
0.012	-1.52033 365	-1.64675 564	-0.32467 581	-3.320281	-3.565272	1.454415	83
0.011	-1.47004 626	-1.58592 472	-0.37383 061	-3.120763	-3.345586	1.259264	91
0.010	-1.41978 154	-1.52511 400	-0.42305 904	-2.921004	-3.125587	1.063526	100
0.009	-1.36954 207	-1.46432 725	-0.47235 911	-2.721043	-2.905322	0.867231	111
0.008	-1.31933 040	-1.40356 824	-0.52172 881	-2.520921	-2.684838	0.670412	125
0.007	-1.26914 908	-1.34284 072	-0.57116 608	-2.320676	-2.464184	0.473099	143
0.006	-1.21900 063	-1.28214 841	-0.62066 881	-2.120350	-2.243408	0.275328	167
0.005	-1.16888 754	-1.22149 499	-0.67023 489	-1.919982	-2.022558	+0.077133	200
0.004	-1.11881 229	-1.16088 414	-0.71986 215	-1.719613	-1.801685	-0.121451	250
0.003	-1.06877 735	-1.10031 949	-0.76954 839	-1.519284	-1.580838	-0.320388	333
0.002	-1.01878 514	-1.03980 463	-0.81929 138	-1.319036	-1.360065	-0.519640	500
0.001	-0.96883 808	-0.97934 314	-0.86908 886	-1.118907	-1.139416	-0.719170	1000
0.000	-0.91893 853	-0.91893 853	-0.91893 853	-0.918939	-0.918939	-0.918939	∞
	$\begin{bmatrix} (-6)9 \\ 4 \end{bmatrix}$	$\begin{bmatrix} (-5)1 \\ 4 \end{bmatrix}$	$\begin{bmatrix} (-5)2 \\ 4 \end{bmatrix}$	$\begin{bmatrix} (-4)1 \\ 4 \end{bmatrix}$	$\begin{bmatrix} (-4)1 \\ 4 \end{bmatrix}$	$\begin{bmatrix} (-4)1 \\ 4 \end{bmatrix}$	

$\langle x \rangle$ = nearest integer to x .

Compiled from L. Fox, A short table for Bessel functions of integer orders and large arguments. Royal Society Shorter Mathematical Tables No. 3 (Cambridge Univ. Press, Cambridge, England, 1954) (with permission).

Table 9.11 MODIFIED BESSEL FUNCTIONS—VARIOUS ORDERS

n	$I_n(1)$	$I_n(2)$	$I_n(5)$
0	(0) 1.26606 5878	(0) 2.27958 5302	(1) 2.72398 7182
1	(- 1) 5.65159 1040	(0) 1.59063 6855	(1) 2.43356 4214
2	(- 1) 1.35747 6698	(- 1) 6.88948 4477	(1) 1.75056 1497
3	(- 2) 2.21684 2492	(- 1) 2.12739 9592	(1) 1.03311 5017
4	(- 3) 2.73712 0221	(- 2) 5.07285 6998	(0) 5.10823 4764
5	(- 4) 2.71463 1560	(- 3) 9.82567 9323	(0) 2.15797 4547
6	(- 5) 2.24886 6148	(- 3) 1.60017 3364	(- 1) 7.92285 6690
7	(- 6) 1.59921 8231	(- 4) 2.24639 1420	(- 1) 2.56488 9417
8	(- 8) 9.96062 4033	(- 5) 2.76993 6951	(- 2) 7.41166 3216
9	(- 9) 5.51838 5863	(- 6) 3.04418 5903	(- 2) 1.93157 1882
10	(- 10) 2.75294 8040	(- 7) 3.01696 3879	(- 3) 4.58004 4419
11	(- 11) 1.24897 8308	(- 8) 2.72220 2336	(- 4) 9.95541 1401
12	(- 13) 5.19576 1153	(- 9) 2.25413 0978	(- 4) 1.99663 4027
13	(- 14) 1.99563 1678	(- 10) 1.72451 6264	(- 5) 3.71568 0720
14	(- 16) 7.11879 0054	(- 11) 1.22598 3451	(- 6) 6.44800 5272
15	(- 17) 2.37046 3051	(- 13) 8.13943 2531	(- 6) 1.04797 7675
16	(- 19) 7.40090 0286	(- 14) 5.06857 1401	(- 7) 1.60139 2190
17	(- 20) 2.17495 9747	(- 15) 2.97182 8970	(- 8) 2.30866 7371
18	(- 22) 6.03714 4636	(- 16) 1.64621 5204	(- 9) 3.14983 7806
19	(- 23) 1.58767 8369	(- 18) 8.64160 3385	(- 10) 4.07841 5017
20	(- 25) 3.96683 5986	(- 19) 4.31056 0576	(- 11) 5.02423 9358
30	(- 42) 3.53950 0588	(- 33) 3.89351 9664	(- 21) 3.99784 4971
40	(- 60) 1.12150 9741	(- 48) 1.25586 9192	(- 32) 1.18042 6980
50	(- 80) 2.93463 5309	(- 65) 3.35304 2830	(- 45) 2.93146 9647
100	(-189) 8.47367 4008	(-158) 1.08217 1475	(-119) 7.09355 1489

n	$I_n(10)$	$I_n(50)$	$I_n(100)$
0	(3) 2.81571 6628	(20) 2.93255 378	(42) 1.07375 171
1	(3) 2.67098 8304	(20) 2.90307 859	(42) 1.06836 939
2	(3) 2.28151 8968	(20) 2.81643 064	(42) 1.05238 432
3	(3) 1.75838 0717	(20) 2.67776 414	(42) 1.02627 402
4	(3) 1.22649 0538	(20) 2.49509 894	(41) 9.90807 878
5	(2) 7.77188 2864	(20) 2.27854 831	(41) 9.47009 387
6	(2) 4.49302 2514	(20) 2.03938 928	(41) 8.96106 940
7	(2) 2.38025 5848	(20) 1.78909 488	(41) 8.39476 555
8	(2) 1.16066 4327	(20) 1.53844 272	(41) 7.78580 222
9	(1) 5.23192 9250	(20) 1.29679 321	(41) 7.14903 719
10	(1) 2.18917 0616	(20) 1.07159 716	(41) 6.49897 552
11	(0) 8.53588 0176	(19) 8.68154 347	(41) 5.84924 209
12	(0) 3.11276 9776	(19) 6.89609 247	(41) 5.21214 227
13	(0) 1.06523 2713	(19) 5.37141 909	(41) 4.59832 794
14	(- 1) 3.43164 7223	(19) 4.10295 454	(41) 4.01657 700
15	(- 1) 1.04371 4907	(19) 3.07376 455	(41) 3.47368 638
16	(- 2) 3.00502 5016	(19) 2.25869 581	(41) 2.97447 109
17	(- 3) 8.21069 0206	(19) 1.62819 923	(41) 2.52185 563
18	(- 3) 2.13390 3457	(19) 1.15152 033	(41) 2.11704 017
19	(- 4) 5.28637 7589	(18) 7.99104 593	(41) 1.75972 117
20	(- 4) 1.25079 9736	(18) 5.44200 840	(41) 1.44834 613
30	(-12) 7.78756 9783	(16) 4.27499 365	(40) 1.20615 487
40	(-20) 2.04212 3274	(13) 6.00717 897	(38) 3.84170 550
50	(-30) 4.75689 4561	(+10) 1.76508 024	(36) 4.82195 809
100	(-88) 1.08234 4202	(-16) 2.72788 795	(21) 4.64153 494

MODIFIED BESSEL FUNCTIONS—VARIOUS ORDERS

Table 9.11

n	$K_n(1)$	$K_n(2)$	$K_n(5)$
0	(- 1) 4. 21024 4382	(- 1) 1. 13893 8728	(- 3) 3. 69109 8334
1	(- 1) 6. 01907 2302	(- 1) 1. 39865 8818	(- 3) 4. 04461 3445
2	0) 1. 62483 8899	(- 1) 2. 53759 7546	(- 3) 5. 30894 3712
3	0) 7. 10126 2825	(- 1) 6. 47385 3909	(- 3) 8. 29176 8415
4	1) 4. 42324 1585	0) 2. 19591 5927	(- 2) 1. 52590 6581
5	2) 3. 60960 5896	0) 9. 43104 9101	(- 2) 3. 27062 7371
6	3) 3. 65383 8312	1) 4. 93511 6143	(- 2) 8. 06716 1323
7	4) 4. 42070 2033	2) 3. 05538 0177	(- 1) 2. 26318 1455
8	5) 6. 22552 1230	3) 2. 18811 7285	(- 1) 7. 14362 4206
9	7) 1. 00050 4099	4) 1. 78104 7630	0) 2. 51227 7891
10	8) 1. 80713 2899	5) 1. 62482 4040	0) 9. 75856 2829
11	9) 3. 62427 0839	6) 1. 64263 4516	1) 4. 15465 2921
12	10) 7. 99146 7175	7) 1. 82314 6208	2) 1. 92563 2913
13	12) 1. 92157 6393	8) 2. 20420 1795	2) 9. 65850 3277
14	13) 5. 00409 0088	9) 2. 88369 3795	3) 5. 21498 4995
15	15) 1. 40306 6801	10) 4. 05921 3332	4) 3. 01697 6630
16	16) 4. 21420 4494	11) 6. 11765 6935	5) 1. 86233 5828
17	18) 1. 34994 8505	12) 9. 82884 3230	6) 1. 22206 4696
18	19) 4. 59403 9121	14) 1. 67702 1006	6) 8. 49627 3517
19	21) 1. 65520 4032	15) 3. 02846 6654	7) 6. 23952 3402
20	22) 6. 29436 9360	16) 5. 77085 6853	8) 4. 82700 0521
30	39) 4. 70614 5527	30) 4. 27112 5755	18) 4. 11213 2063
40	58) 1. 11422 0651	45) 9. 94083 9886	30) 1. 05075 6722
50	77) 3. 40689 6854	62) 2. 97998 1740	42) 3. 39432 2243
100	(185) 5. 90033 3184	(155) 4. 61941 5978	(115) 7. 03986 0193

n	$K_n(10)$	$K_n(50)$	$K_n(100)$
0	(-5) 1. 77800 6232	(-23) 3. 41016 774	(-45) 4. 65662 823
1	(-5) 1. 86487 7345	(-23) 3. 44410 222	(-45) 4. 67985 373
2	(-5) 2. 15098 1701	(-23) 3. 54793 183	(-45) 4. 75022 530
3	(-5) 2. 72527 0026	(-23) 3. 72793 677	(-45) 4. 86986 274
4	(-5) 3. 78614 3716	(-23) 3. 99528 424	(-45) 5. 04241 707
5	(-5) 5. 75418 4999	(-23) 4. 36718 224	(-45) 5. 27325 611
6	(-5) 9. 54032 8715	(-23) 4. 86872 069	(-45) 5. 56974 268
7	(-4) 1. 72025 7946	(-23) 5. 53567 521	(-45) 5. 94162 523
8	(-4) 3. 36239 3995	(-23) 6. 41870 975	(-45) 6. 40157 021
9	(-4) 7. 10008 8338	(-23) 7. 58966 233	(-45) 6. 96587 646
10	(-3) 1. 61425 5300	(-23) 9. 15098 819	(-45) 7. 65542 797
11	(-3) 3. 93851 9435	(-22) 1. 12500 576	(-45) 8. 49696 206
12	(-2) 1. 02789 9806	(-22) 1. 41010 135	(-45) 9. 52475 963
13	(-2) 2. 86081 1477	(-22) 1. 80185 441	(-44) 1. 07829 044
14	(-2) 8. 46600 9646	(-22) 2. 34706 565	(-44) 1. 23283 148
15	(-1) 2. 65656 3849	(-22) 3. 11621 117	(-44) 1. 42348 325
16	(-1) 8. 81629 2510	(-22) 4. 21679 235	(-44) 1. 65987 645
17	0) 3. 08686 9988	(-22) 5. 81495 828	(-44) 1. 95464 371
18	1) 1. 13769 8721	(-22) 8. 17096 398	(-44) 2. 32445 531
19	1) 4. 40440 2395	(-21) 1. 16980 523	(-44) 2. 79144 763
20	2) 1. 78744 2782	(-21) 1. 70614 838	(-44) 3. 38520 541
30	9) 2. 03024 7813	(-19) 2. 00581 681	(-43) 3. 97060 205
40	17) 5. 93822 4681	(-16) 1. 29986 971	(-41) 1. 20842 080
50	(27) 2. 06137 3775	(-13) 4. 00601 347	(-40) 9. 27452 265
100	(85) 4. 59667 4084	(+13) 1. 63940 352	(-25) 7. 61712 963

Table 9.12 KELVIN FUNCTIONS—ORDERS 0 AND 1

x	$\text{ber } x$	$\text{bei } x$	$\text{ber}_1 x$	$\text{bei}_1 x$
0.0	1.00000 00000	0.00000 00000	0.00000 00000	0.00000 00000
0.1	0.99999 84375	0.00249 99996	-0.03539 95148	0.03531 11265
0.2	0.99997 50000	0.00999 99722	-0.07106 36418	0.07035 65360
0.3	0.99987 34379	0.02249 96836	-0.10725 47768	0.10486 83082
0.4	0.99960 00044	0.03999 82222	-0.14423 08645	0.13857 41359
0.5	0.99902 34640	0.06249 32184	-0.18224 31238	0.17119 51797
0.6	0.99797 51139	0.08997 97504	-0.22153 37177	0.20244 39824
0.7	0.99624 88284	0.12244 89390	-0.26233 33470	0.23202 24623
0.8	0.99360 11377	0.15988 62295	-0.30485 87511	0.25962 00070
0.9	0.98975 13567	0.20226 93635	-0.34931 01000	0.28491 16898
1.0	0.98438 17812	0.24956 60400	-0.39586 82610	0.30755 66314
1.1	0.97713 79732	0.30173 12692	-0.44469 19268	0.32719 65305
1.2	0.96762 91558	0.35870 44199	-0.49591 45913	0.34345 43903
1.3	0.95542 87468	0.42040 59656	-0.54964 13636	0.35593 34649
1.4	0.94007 50567	0.48673 39336	-0.60594 56099	0.36421 64560
1.5	0.92107 21835	0.55756 00623	-0.66486 54180	0.36786 49890
1.6	0.89789 11386	0.63272 56770	-0.72639 98786	0.36641 93986
1.7	0.86997 12370	0.71203 72924	-0.79050 51846	0.35939 88584
1.8	0.83672 17942	0.79526 19548	-0.85709 05470	0.34630 18876
1.9	0.79752 41670	0.88212 23406	-0.92601 39357	0.32660 72722
2.0	0.75173 41827	0.97229 16273	-0.99707 76519	0.29977 54370
2.1	0.69868 50014	1.06538 81608	-1.07002 37462	0.26525 03092
2.2	0.63769 04571	1.16096 99438	-1.14452 92997	0.22246 17120
2.3	0.56804 89261	1.25852 89751	-1.22020 15903	0.17082 83322
2.4	0.48904 77721	1.35748 54765	-1.29657 31717	0.10976 13027
2.5	0.39996 84171	1.45718 20442	-1.37309 68976	+0.03866 84440
2.6	0.30009 20903	1.55687 77737	-1.44914 09315	-0.04304 07916
2.7	0.18870 63040	1.65574 24073	-1.52398 37854	-0.13594 96285
2.8	+0.06511 21084	1.75285 05638	-1.59680 94413	-0.24062 74875
2.9	-0.07136 78258	1.84717 61157	-1.66670 26139	-0.35762 26713
3.0	-0.22138 02496	1.93758 67853	-1.73264 42211	-0.48745 41770
3.1	-0.38553 14550	2.02283 90420	-1.79350 71373	-0.63060 25952
3.2	-0.56437 64305	2.10157 33881	-1.84805 23125	-0.78750 00586
3.3	-0.75840 70121	2.17231 01315	-1.89492 53482	-0.95851 92089
3.4	-0.96803 89953	2.23344 57503	-1.93265 36306	-1.14396 11510
3.5	-1.19359 81796	2.28324 99669	-1.95964 41313	-1.34404 23731
3.6	-1.43530 53217	2.31986 36548	-1.97418 19924	-1.55888 06139
3.7	-1.69325 99843	2.34129 77145	-1.97443 00262	-1.78847 96677
3.8	-1.96742 32727	2.34543 30614	-1.95842 92665	-2.03271 31257
3.9	-2.25759 94661	2.33002 18823	-1.92410 07174	-2.29130 70630
4.0	-2.56341 65573	2.29269 03227	-1.86924 84590	-2.56382 16886
4.1	-2.88430 57320	2.23094 27803	-1.79156 42730	-2.84963 19932
4.2	-3.21947 98323	2.14216 79867	-1.68863 39648	-3.14790 74393
4.3	-3.56791 08628	2.02364 70694	-1.55794 55649	-3.45759 07560
4.4	-3.92830 66215	1.87256 37958	-1.39689 95997	-3.77737 59182
4.5	-4.29908 65516	1.68601 72036	-1.20282 16315	-4.10568 54084
4.6	-4.67835 69372	1.46103 68359	-0.97297 72697	-4.44064 68813
4.7	-5.06388 55867	1.19460 07968	-0.70458 98649	-4.78006 93721
4.8	-5.45307 61749	0.88365 68537	-0.39486 10961	-5.12141 92170
4.9	-5.84294 24419	0.52514 68109	-0.04099 46681	-5.46179 58790
5.0	-6.23008 24787	0.11603 43816	+0.35977 66668	-5.79790 79018
	$\left[\begin{smallmatrix} (-3)2 \\ 8 \end{smallmatrix} \right]$	$\left[\begin{smallmatrix} (-3)6 \\ 8 \end{smallmatrix} \right]$	$\left[\begin{smallmatrix} (-3)6 \\ 8 \end{smallmatrix} \right]$	$\left[\begin{smallmatrix} (-3)2 \\ 8 \end{smallmatrix} \right]$

KELVIN FUNCTIONS—AUXILIARY TABLE FOR SMALL ARGUMENTS

x	$\text{ker } x + \text{ber } x \ln x$	$\text{kei } x + \text{bei } x \ln x$	$x(\text{ker}_1 x + \text{ber}_1 x \ln x)$	$x(\text{kei}_1 x + \text{bei}_1 x \ln x)$
0.0	0.11593 1516	-0.78539 8163	-0.70710 6781	-0.70710 6781
0.1	0.11789 2485	-0.78260 7108	-0.70651 7131	-0.70215 4903
0.2	0.12374 5076	-0.77421 9267	-0.70486 2164	-0.68733 0339
0.3	0.13339 8210	-0.76019 0919	-0.70248 3157	-0.66272 8003
0.4	0.14669 9682	-0.74045 0212	-0.69994 6658	-0.62851 1738
0.5	0.16343 5574	-0.71489 8693	-0.69804 1049	-0.58492 2770
	$\left[\begin{smallmatrix} (-4)5 \\ 7 \end{smallmatrix} \right]$	$\left[\begin{smallmatrix} (-4)8 \\ 7 \end{smallmatrix} \right]$	$\left[\begin{smallmatrix} (-4)1 \\ 7 \end{smallmatrix} \right]$	$\left[\begin{smallmatrix} (-3)1 \\ 7 \end{smallmatrix} \right]$

Compiled from National Bureau of Standards, Tables of the Bessel functions $J_0(z)$ and $J_1(z)$ for complex arguments, 2d ed. (Columbia Univ. Press, New York, N.Y., 1947) and National Bureau of Standards, Tables of the Bessel functions $Y_0(z)$ and $Y_1(z)$ for complex arguments (Columbia Univ. Press, New York, N.Y., 1950) (with permission).

KELVIN FUNCTIONS—ORDERS 0 AND 1

Table 9.12

x	$\ker x$	$\text{kei } x$	$\ker_1 x$	$\text{kei}_1 x$
0.0	∞	-0.78539 8163	-	-
0.1	2.42047 3980	-0.77685 0646	-7.14668 1711	-6.94024 2153
0.2	1.73314 2752	-0.75812 4933	-3.63868 3342	-3.32341 7218
0.3	1.33721 8637	-0.73310 1912	-2.47074 2357	-2.08283 4751
0.4	1.06262 3902	-0.70380 0212	-1.88202 4050	-1.44430 5150
0.5	0.85590 5872	-0.67158 1695	-1.52240 3406	-1.05118 2085
0.6	0.69312 0695	-0.63744 9494	-1.27611 7712	-0.78373 8860
0.7	0.56137 8274	-0.60217 5451	-1.09407 2943	-0.59017 5251
0.8	0.45288 2093	-0.56636 7650	-0.95203 2751	-0.44426 9985
0.9	0.36251 4812	-0.53051 1122	-0.83672 7829	-0.33122 6820
1.0	0.28670 6208	-0.49499 4636	-0.74032 2276	-0.24199 5966
1.1	0.22284 4513	-0.46012 9528	-0.65791 0729	-0.17068 4462
1.2	0.16894 5592	-0.42616 3604	-0.58627 4386	-0.11325 6800
1.3	0.12345 5395	-0.39329 1826	-0.52321 5989	-0.06683 2622
1.4	0.08512 6048	-0.36166 4781	-0.46718 3076	-0.02928 3749
1.5	0.05293 4915	-0.33139 5562	-0.41704 4285	+0.00100 8681
1.6	0.02602 9861	-0.30256 5474	-0.37195 1238	0.02530 6776
1.7	+0.00369 1104	-0.27522 8834	-0.33125 0485	0.04461 5190
1.8	-0.01469 6087	-0.24941 7069	-0.29442 5803	0.05974 7779
1.9	-0.02966 1407	-0.22514 2235	-0.26105 9495	0.07137 3592
2.0	-0.04166 4514	-0.20240 0068	-0.23080 5929	0.08004 9398
2.1	-0.05110 6500	-0.18117 2644	-0.20337 3135	0.08624 3202
2.2	-0.05833 8834	-0.16143 0701	-0.17850 9812	0.09035 1619
2.3	-0.06367 0454	-0.14313 5677	-0.15599 6054	0.09271 2940
2.4	-0.06737 3493	-0.12624 1488	-0.13563 6638	0.09361 7161
2.5	-0.06968 7972	-0.11069 6099	-0.11725 6136	0.09331 3788
2.6	-0.07082 5700	-0.09644 2891	-0.10069 5314	0.09201 8037
2.7	-0.07097 3560	-0.08342 1858	-0.08580 8451	0.08991 5810
2.8	-0.07029 6321	-0.07157 0648	-0.07246 1339	0.08716 7762
2.9	-0.06893 9052	-0.06082 5473	-0.06052 9755	0.08391 2666
3.0	-0.06702 9233	-0.05112 1884	-0.04989 8308	0.08027 0223
3.1	-0.06467 8610	-0.04239 5446	-0.04045 9533	0.07634 3451
3.2	-0.06198 4833	-0.03458 2313	-0.03211 3183	0.07222 0724
3.3	-0.05903 2916	-0.02761 9697	-0.02476 5662	0.06797 7529
3.4	-0.05589 6550	-0.02144 6287	-0.01832 9556	0.06367 7999
3.5	-0.05263 9277	-0.01600 2568	-0.01272 3249	0.05937 6256
3.6	-0.04931 5556	-0.01123 1096	-0.00787 0585	0.05511 7592
3.7	-0.04597 1723	-0.00707 6704	-0.00370 0576	0.05093 9514
3.8	-0.04264 6864	-0.00348 6665	-0.00014 7138	0.04687 2681
3.9	-0.03937 3608	-0.00041 0809	+0.00285 1155	0.04294 1728
4.0	-0.03617 8848	+0.00219 8399	0.00535 1296	0.03916 6011
4.1	-0.03308 4395	0.00438 5818	0.00740 6063	0.03556 0272
4.2	-0.03010 7574	0.00619 3613	0.00906 4226	0.03213 5235
4.3	-0.02726 1764	0.00766 1269	0.01037 0752	0.02889 8142
4.4	-0.02455 6892	0.00882 5624	0.01136 6998	0.02585 3229
4.5	-0.02199 9875	0.00972 0918	0.01209 0904	0.02300 2160
4.6	-0.01959 5024	0.01037 8865	0.01257 7182	0.02034 4409
4.7	-0.01734 4409	0.01082 8725	0.01285 7498	0.01787 7607
4.8	-0.01524 8188	0.01109 7399	0.01296 0651	0.01559 7847
4.9	-0.01330 4899	0.01120 9526	0.01291 2753	0.01349 9960
5.0	-0.01151 1727	0.01118 7587	0.01273 7390	0.01157 7754

KELVIN FUNCTIONS—AUXILIARY TABLE FOR SMALL ARGUMENTS

x	$\ker x + \text{ber } x \ln x$	$\text{kei } x + \text{bei } x \ln x$	$x(\ker_1 x + \text{ber}_1 x \ln x)$	$x(\text{kei}_1 x + \text{bei}_1 x \ln x)$
0.5	0.16343 5574	-0.71489 8693	-0.69804 1049	-0.58492 2770
0.6	0.18332 9435	-0.68341 3456	-0.69777 1567	-0.53229 1460
0.7	0.20604 1279	-0.64584 9920	-0.70035 3648	-0.47105 2294
0.8	0.23116 6407	-0.60204 5231	-0.70720 4389	-0.40176 2012
0.9	0.25823 4099	-0.55182 2327	-0.71993 1903	-0.32512 0736
1.0	0.28670 6208 $\left[\begin{smallmatrix} (-4)4 \\ 7 \end{smallmatrix} \right]$	-0.49499 4636 $\left[\begin{smallmatrix} (-4)8 \\ 7 \end{smallmatrix} \right]$	-0.74032 2276 $\left[\begin{smallmatrix} (-3)1 \\ 7 \end{smallmatrix} \right]$	-0.24199 5966 $\left[\begin{smallmatrix} (-3)1 \\ 7 \end{smallmatrix} \right]$

BESSEL FUNCTIONS OF INTEGER ORDER

Table 9.12 KELVIN FUNCTIONS—MODULUS AND PHASE

$\text{ber } x = M_0(x) \cos \theta_0(x)$		$\text{ber}_1 x = M_1(x) \cos \theta_1(x)$		
$\text{bei } x = M_0(x) \sin \theta_0(x)$		$\text{bei}_1 x = M_1(x) \sin \theta_1(x)$		
x	$M_0(x)$	$\theta_0(x)$	$M_1(x)$	$\theta_1(x)$
0.0	1.000000	0.000000	0.000000	2.356194
0.2	1.000025	0.010000	0.100000	2.361194
0.4	1.000400	0.039993	0.200013	2.376194
0.6	1.002023	0.089919	0.300101	2.401189
0.8	1.006383	0.159548	0.400427	2.436166
1.0	1.015525	0.248294	0.501301	2.481086
1.2	1.031976	0.354999	0.603235	2.535872
1.4	1.058608	0.477755	0.706982	2.600386
1.6	1.098431	0.613860	0.813585	2.674406
1.8	1.154359	0.759999	0.924407	2.757605
2.0	1.229006	0.912639	1.041167	2.849536
2.2	1.324576	1.068511	1.165949	2.949617
2.4	1.442891	1.225011	1.301211	3.057139
2.6	1.585536	1.380379	1.449780	3.171285
2.8	1.754059	1.533667	1.614838	3.291160
3.0	1.950193	1.684559	1.799908	3.415839
3.2	2.176036	1.833156	2.008844	3.544415
3.4	2.434210	1.979784	2.245840	3.676044
3.6	2.727979	2.124854	2.515453	3.809981
3.8	3.061341	2.268771	2.822653	3.945601
4.0	3.439118	2.411887	3.172896	4.082407
4.2	3.867032	2.554483	3.572227	4.220023
4.4	4.351791	2.696771	4.027393	4.358179
4.6	4.901189	2.838893	4.545990	4.496691
4.8	5.524209	2.980942	5.136619	4.635441
5.0	6.231163	3.122970	5.809060	4.774362
5.2	7.033841	3.265002	6.574474	4.913417
5.4	7.945700	3.407044	7.445618	5.052589
5.6	8.982083	3.549094	8.437083	5.191872
5.8	10.160473	3.691142	9.565568	5.331267
6.0	11.500794	3.833179	10.850182	5.470772
6.2	13.025757	3.975197	12.312791	5.610390
6.4	14.761257	4.117190	13.978402	5.750117
6.6	16.736836	4.259152	15.875614	5.889950
6.8	18.986208	4.401083	18.037122	6.029884
7.0	21.547863	4.542982	20.500302	6.169913
	$\left[\begin{smallmatrix} (-2)4 \\ 7 \end{smallmatrix} \right]$	$\left[\begin{smallmatrix} (-3)2 \\ 8 \end{smallmatrix} \right]$	$\left[\begin{smallmatrix} (-2)4 \\ 6 \end{smallmatrix} \right]$	$\left[\begin{smallmatrix} (-3)1 \\ 6 \end{smallmatrix} \right]$

KELVIN FUNCTIONS—MODULUS AND PHASE FOR LARGE ARGUMENTS

x^{-1}	$x^{\frac{1}{2}} e^{-x/\sqrt{2}} M_0(x)$	$\theta_0(x) - (x/\sqrt{2})$	$x^{\frac{1}{2}} e^{-x/\sqrt{2}} M_1(x)$	$\theta_1(x) - (x/\sqrt{2})$	$\langle x \rangle$
0.15	0.40418	-0.40758	0.38359	1.22254	7
0.14	0.40383	-0.40644	0.38457	1.21922	7
0.13	0.40349	-0.40534	0.38556	1.21598	8
0.12	0.40315	-0.40427	0.38655	1.21280	8
0.11	0.40281	-0.40323	0.38755	1.20968	9
0.10	0.40246	-0.40221	0.38856	1.20660	10
0.09	0.40211	-0.40119	0.38957	1.20356	11
0.08	0.40176	-0.40019	0.39060	1.20057	13
0.07	0.40141	-0.39921	0.39162	1.19762	14
0.06	0.40106	-0.39824	0.39266	1.19471	17
0.05	0.40071	-0.39728	0.39369	1.19184	20
0.04	0.40035	-0.39634	0.39474	1.18901	25
0.03	0.40000	-0.39541	0.39578	1.18622	33
0.02	0.39965	-0.39449	0.39683	1.18348	50
0.01	0.39930	-0.39359	0.39789	1.18077	100
0.00	0.39894	-0.39270	0.39894	1.17810	∞
	$\left[\begin{smallmatrix} (-5)1 \\ 2 \end{smallmatrix} \right]$	$\left[\begin{smallmatrix} (-5)1 \\ 2 \end{smallmatrix} \right]$	$\left[\begin{smallmatrix} (-6)3 \\ 2 \end{smallmatrix} \right]$	$\left[\begin{smallmatrix} (-5)1 \\ 2 \end{smallmatrix} \right]$	

$\langle x \rangle$ = nearest integer to x .

KELVIN FUNCTIONS—MODULUS AND PHASE Table 9.12

ker $x=N_0(x) \cos \phi_0(x)$		ker ₁ $x=N_1(x) \cos \phi_1(x)$		
kei $x=N_0(x) \sin \phi_0(x)$		kei ₁ $x=N_1(x) \sin \phi_1(x)$		
x	$N_0(x)$	$\phi_0(x)$	$N_1(x)$	$\phi_1(x)$
0.0	∞	0.000000	∞	-2.356194
0.2	1.891702	-0.412350	4.927993	-2.401447
0.4	1.274560	-0.584989	2.372347	-2.487035
0.6	0.941678	-0.743582	1.497572	-2.590827
0.8	0.725172	-0.896284	1.050591	-2.704976
1.0	0.572032	-1.045803	0.778870	-2.825662
1.2	0.458430	-1.193368	0.597114	-2.950763
1.4	0.371548	-1.339631	0.468100	-3.078993
1.6	0.303683	-1.484977	0.372811	-3.209526
1.8	0.249850	-1.629650	0.300427	-3.341804
2.0	0.206644	-1.773813	0.244293	-3.475437
2.2	0.171649	-1.917579	0.200073	-3.610143
2.4	0.143095	-2.061029	0.164807	-3.745715
2.6	0.119656	-2.204225	0.136407	-3.881994
2.8	0.100319	-2.347212	0.113353	-4.018860
3.0	0.084299	-2.490025	0.094515	-4.156217
3.2	0.070979	-2.632692	0.079039	-4.293990
3.4	0.059870	-2.775236	0.066264	-4.432118
3.6	0.050578	-2.917672	0.055677	-4.570551
3.8	0.042789	-3.060017	0.046873	-4.709250
4.0	0.036246	-3.202283	0.039530	-4.848179
4.2	0.030738	-3.344478	0.033389	-4.987312
4.4	0.026095	-3.486612	0.028242	-5.126623
4.6	0.022174	-3.628692	0.023918	-5.266093
4.8	0.018859	-3.770724	0.020280	-5.405705
5.0	0.016052	-3.912712	0.017213	-5.545443
5.2	0.013674	-4.054662	0.014624	-5.685295
5.4	0.011656	-4.196576	0.012435	-5.825250
5.6	0.009942	-4.338460	0.010583	-5.965298
5.8	0.008485	-4.480314	0.009013	-6.105430
6.0	0.007246	-4.622142	0.007682	-6.245638
6.2	0.006191	-4.763947	0.006551	-6.385917
6.4	0.005292	-4.905730	0.005590	-6.526260
6.6	0.004526	-5.047493	0.004773	-6.666662
6.8	0.003872	-5.189238	0.004077	-6.807119
7.0	0.003315	-5.330966	0.003485	-6.947625

KELVIN FUNCTIONS—MODULUS AND PHASE FOR LARGE ARGUMENTS

x^{-1}	$x^{\frac{1}{2}}e^{x/\sqrt{2}}N_0(x)$	$\phi_0(x)+(x/\sqrt{2})$	$x^{\frac{1}{2}}e^{x/\sqrt{2}}N_1(x)$	$\phi_1(x)+(x/\sqrt{2})$	$\langle x \rangle$
0.15	1.23695	-0.38070	1.30377	-1.99943	7
0.14	1.23802	-0.38142	1.30039	-1.99725	7
0.13	1.23909	-0.38217	1.29701	-1.99505	8
0.12	1.24017	-0.38291	1.29363	-1.99281	8
0.11	1.24125	-0.38367	1.29024	-1.99055	9
0.10	1.24233	-0.38444	1.28687	-1.98825	10
0.09	1.24342	-0.38522	1.28349	-1.98592	11
0.08	1.24451	-0.38600	1.28012	-1.98357	13
0.07	1.24560	-0.38680	1.27675	-1.98118	14
0.06	1.24670	-0.38761	1.27339	-1.97876	17
0.05	1.24779	-0.38843	1.27002	-1.97630	20
0.04	1.24889	-0.38926	1.26667	-1.97381	25
0.03	1.25000	-0.39010	1.26332	-1.97128	33
0.02	1.25110	-0.39096	1.25998	-1.96872	50
0.01	1.25221	-0.39182	1.25664	-1.96613	100
0.00	1.25331	-0.39270	1.25331	-1.96350	∞
	$\begin{bmatrix} (-6)1 \\ 2 \end{bmatrix}$	$\begin{bmatrix} (-6)3 \\ 2 \end{bmatrix}$	$\begin{bmatrix} (-6)3 \\ 2 \end{bmatrix}$	$\begin{bmatrix} (-6)5 \\ 2 \end{bmatrix}$	

$\langle x \rangle$ = nearest integer to x .

10. Bessel Functions of Fractional Order

H. A. ANTOSIEWICZ¹

Contents

	Page
Mathematical Properties	437
10.1. Spherical Bessel Functions	437
10.2. Modified Spherical Bessel Functions	443
10.3. Riccati-Bessel Functions	445
10.4. Airy Functions	446
Numerical Methods	452
10.5. Use and Extension of the Tables	452
References	455
Table 10.1. Spherical Bessel Functions—Orders 0, 1, and 2 ($0 \leq x \leq 10$) .	457
$j_n(x), y_n(x)$ $n=0, 1, 2; x=0(.1)5, 6-8S, x=5(.1)10, 5S$	
Table 10.2. Spherical Bessel Functions—Orders 3-10 ($0 \leq x \leq 10$) . . .	459
$j_n(x), y_n(x)$ $n=3(1)8; x=0(.1)10, 5S$ $x^{-n}j_n(x), x^{n+1}y_n(x)$ $n=9, 10; x=0(.1)10, 7-8S$	
Table 10.3. Spherical Bessel Functions—Orders 20 and 21 ($0 \leq x \leq 25$)	463
$x^{-n} \exp(x^2/(4n+2))j_n(x)$ $x^{n+1} \exp(-x^2/(4n+2))y_n(x)$ $n=20, 21; x=0(.5)25, 6-8S$	
Table 10.4. Spherical Bessel Functions—Modulus and Phase—Orders 9, 10, 20 and 21	464
$\sqrt{\frac{1}{2}\pi x}M_{n+\frac{1}{2}}(x), \theta_{n+\frac{1}{2}}(x) - x$ where $j_n(x) = \sqrt{\frac{1}{2}\pi/x}M_{n+\frac{1}{2}}(x) \cos \theta_{n+\frac{1}{2}}(x)$ $y_n(x) = \sqrt{\frac{1}{2}\pi/x}M_{n+\frac{1}{2}}(x) \sin \theta_{n+\frac{1}{2}}(x)$ $n=9, 10; x^{-1}=.1(-.005)0, 8D$ $n=20, 21; x^{-1}=.04(-.002)0, 8D$	
Table 10.5. Spherical Bessel Functions—Various Orders ($0 \leq n \leq 100$) .	465
$j_n(x), y_n(x)$ $n=0(1)20, 30, 40, 50, 100$ $x=1, 2, 5, 10, 50, 100, 10S$	
Table 10.6. Zeros of Bessel Functions of Half-Integer Order ($0 \leq n \leq 19$) .	467
Zeros $j_{\nu, s}, y_{\nu, s}$ of $J_\nu(x), Y_\nu(x)$ and Values of $J'_\nu(j_{\nu, s}), Y'_\nu(y_{\nu, s})$ $\nu=n+\frac{1}{2}, n=0(1)19, 6-7D$	
Table 10.7. Zeros of the Derivative of Bessel Functions of Half-Integer Order ($0 \leq n \leq 19$)	468
Zeros $j'_{\nu, s}, y'_{\nu, s}$ of $J'_\nu(x), Y'_\nu(x)$ and Values of $J_\nu(j'_{\nu, s}), Y_\nu(y'_{\nu, s})$ $\nu=n+\frac{1}{2}, n=0(1)19, 6D$	

¹ National Bureau of Standards. (Presently, University of Southern California.)

	Page
Table 10.8. Modified Spherical Bessel Functions—Orders 0, 1 and 2 ($0 \leq x \leq 5$)	469
$\sqrt{\frac{1}{2}\pi/x}I_{n+\frac{1}{2}}(x), \sqrt{\frac{1}{2}\pi/x}K_{n+\frac{1}{2}}(x)$ $n=0, 1, 2; x=0(.1)5, 4-9D$	
Table 10.9. Modified Spherical Bessel Functions—Orders 9 and 10 ($0 \leq x \leq \infty$)	470
$x^{-n}\sqrt{\frac{1}{2}\pi/x}I_{n+\frac{1}{2}}(x), x^{n+1}\sqrt{\frac{1}{2}\pi/x}K_{n+\frac{1}{2}}(x)$ $n=9, 10; x=0(.1)5, 7-8S$ $e^{-x}I_{n+\frac{1}{2}}(x), (2/\pi)e^xK_{n+\frac{1}{2}}(x)$ $n=9, 10; x=5(.1)10, 6S$ $\sqrt{2\pi x} \exp[-x+n(n+1)/(2x)]I_{n+\frac{1}{2}}(x)$ $\sqrt{2x/\pi} \exp[x-n(n+1)/(2x)]K_{n+\frac{1}{2}}(x)$ $n=9, 10; x^{-1}=.1(-.005)0, 7-8S$	
Table 10.10. Modified Spherical Bessel Functions—Various Orders ($0 \leq n \leq 100$)	473
$\sqrt{\frac{1}{2}\pi/x}I_{n+\frac{1}{2}}(x), \sqrt{\frac{1}{2}\pi/x}K_{n+\frac{1}{2}}(x)$ $n=0(1)20, 30, 40, 50, 100$ $x=1, 2, 5, 10, 50, 100, 10S$	
Table 10.11. Airy Functions ($0 \leq x \leq \infty$)	475
$Ai(x), Ai'(x), Bi(x), Bi'(x)$ $x=0(.01)1, 8D$ $Ai(-x), Ai'(-x), Bi(-x), Bi'(-x)$ $x=0(.01)1(.1)10, 8D$ Auxiliary Functions for Large Positive Arguments $Ai(x) = \frac{1}{2}x^{-1/4}e^{-\xi}f(-\xi); Bi(x) = x^{-1/4}e^{\xi}f(\xi)$ $Ai'(x) = -\frac{1}{2}x^{1/4}e^{-\xi}g(-\xi); Bi'(x) = x^{1/4}e^{\xi}g(\xi)$ $f(\pm \xi), g(\pm \xi); \xi = \frac{2}{3}x^{3/2}, \xi^{-1} = 1.5(-.1).5(-.05)0, 6D$ Auxiliary Functions for Large Negative Arguments $Ai(-x) = x^{-1/4}[f_1(\xi) \cos \xi + f_2(\xi) \sin \xi]$ $Bi(-x) = x^{-1/4}[f_2(\xi) \cos \xi - f_1(\xi) \sin \xi]$ $Ai'(-x) = x^{1/4}[g_1(\xi) \sin \xi - g_2(\xi) \cos \xi]$ $Bi'(-x) = x^{1/4}[g_2(\xi) \sin \xi + g_1(\xi) \cos \xi]$ $f_1(\xi), f_2(\xi), g_1(\xi), g_2(\xi); \xi = \frac{2}{3}x^{3/2}$ $\xi^{-1} = .05(-.01)0, 6-7D$	
Table 10.12. Integrals of Airy Functions ($0 \leq x \leq 10$)	478
$\int_0^x Ai(t)dt, x=0(.1)7.5; \int_0^x Ai(-t)dt, x=0(.1)10, 7D$ $\int_0^x Bi(t)dt, x=0(.1)2; \int_0^x Bi(-t)dt, x=0(.1)10, 7D$	
Table 10.13. Zeros and Associated Values of Airy Functions and Their Derivatives ($1 \leq s \leq 10$)	478
Zeros a_s, a'_s, b_s, b'_s of $Ai(x), Ai'(x), Bi(x), Bi'(x)$ and values of $Ai'(a_s),$ $Ai(a'_s), Bi'(b_s), Bi(b'_s)$ $s=1(1)10, 8D$ Complex Zeros and Associated Values of $Bi(z)$ and $Bi'(z)$ ($1 \leq s \leq 5$) Modulus and Phase of $e^{-\pi t/3}\beta_s, e^{-\pi t/3}\beta'_s, Bi'(\beta_s), Bi(\beta'_s)$ $s=1(1)5, 3D$	

The author acknowledges the assistance of Bertha H. Walter and Ruth Zucker in the preparation and checking of the tables and graphs.

10. Bessel Functions of Fractional Order

Mathematical Properties

10.1. Spherical Bessel Functions

Definitions

Differential Equation

10.1.1

$$z^2 w'' + 2zw' + [z^2 - n(n+1)]w = 0$$

($n=0, \pm 1, \pm 2, \dots$)

Particular solutions are the *Spherical Bessel functions of the first kind*

$$j_n(z) = \sqrt{\frac{1}{2}\pi/z} J_{n+\frac{1}{2}}(z),$$

the *Spherical Bessel functions of the second kind*

$$y_n(z) = \sqrt{\frac{1}{2}\pi/z} Y_{n+\frac{1}{2}}(z),$$

and the *Spherical Bessel functions of the third kind*

$$h_n^{(1)}(z) = j_n(z) + iy_n(z) = \sqrt{\frac{1}{2}\pi/z} H_{n+\frac{1}{2}}^{(1)}(z),$$

$$h_n^{(2)}(z) = j_n(z) - iy_n(z) = \sqrt{\frac{1}{2}\pi/z} H_{n+\frac{1}{2}}^{(2)}(z).$$

The pairs $j_n(z)$, $y_n(z)$ and $h_n^{(1)}(z)$, $h_n^{(2)}(z)$ are linearly independent solutions for every n . For general properties see the remarks after 9.1.1.

Ascending Series (See 9.1.2, 9.1.10)

10.1.2

$$j_n(z) = \frac{z^n}{1 \cdot 3 \cdot 5 \dots (2n+1)} \left\{ 1 - \frac{\frac{1}{2}z^2}{1!(2n+3)} + \frac{(\frac{1}{2}z^2)^2}{2!(2n+3)(2n+5)} - \dots \right\}$$

10.1.3

$$y_n(z) = -\frac{1 \cdot 3 \cdot 5 \dots (2n-1)}{z^{n+1}} \left\{ 1 - \frac{\frac{1}{2}z^2}{1!(1-2n)} + \frac{(\frac{1}{2}z^2)^2}{2!(1-2n)(3-2n)} - \dots \right\}$$

($n=0, 1, 2, \dots$)

Limiting Values as $z \rightarrow 0$

10.1.4

$$z^{-n} j_n(z) \rightarrow \frac{1}{1 \cdot 3 \cdot 5 \dots (2n+1)}$$

10.1.5

$$z^{n+1} y_n(z) \rightarrow -1 \cdot 3 \cdot 5 \dots (2n-1) \quad (n=0, 1, 2, \dots)$$

Wronskians

10.1.6

$$W\{j_n(z), y_n(z)\} = z^{-2}$$

10.1.7

$$W\{h_n^{(1)}(z), h_n^{(2)}(z)\} = -2iz^{-2} \quad (n=0, 1, 2, \dots)$$

Representations by Elementary Functions

10.1.8

$$j_n(z) = z^{-1} [P(n+\frac{1}{2}, z) \sin(z - \frac{1}{2}n\pi) + Q(n+\frac{1}{2}, z) \cos(z - \frac{1}{2}n\pi)]$$

10.1.9

$$y_n(z) = (-1)^{n+1} z^{-1} [P(n+\frac{1}{2}, z) \cos(z + \frac{1}{2}n\pi) - Q(n+\frac{1}{2}, z) \sin(z + \frac{1}{2}n\pi)]$$

$$P(n+\frac{1}{2}, z) = 1 - \frac{(n+2)!}{2! \Gamma(n-1)} (2z)^{-2} + \frac{(n+4)!}{4! \Gamma(n-3)} (2z)^{-4} - \dots$$

$$= \sum_0^{\lfloor \frac{1}{2}n \rfloor} (-1)^k (n+\frac{1}{2}, 2k) (2z)^{-2k}$$

$$Q(n+\frac{1}{2}, z) = \frac{(n+1)!}{1! \Gamma(n)} (2z)^{-1} - \frac{(n+3)!}{3! \Gamma(n-2)} (2z)^{-3} + \frac{(n+5)!}{5! \Gamma(n-4)} (2z)^{-5} - \dots$$

$$= \sum_0^{\lfloor \frac{1}{2}(n-1) \rfloor} (-1)^k (n+\frac{1}{2}, 2k+1) (2z)^{-2k-1}$$

($n=0, 1, 2, \dots$)

$$(n+\frac{1}{2}, k) = \frac{(n+k)!}{k! \Gamma(n-k+1)}$$

$n \backslash k$	1	2	3	4	5
1	2				
2	6	12			
3	12	60	120		
4	20	180	840	1680	
5	30	420	3360	15120	30240

10.1.10

$$j_n(z) = f_n(z) \sin z + (-1)^{n+1} f_{-n-1}(z) \cos z$$

$$f_0(z) = z^{-1}, \quad f_1(z) = z^{-2}$$

$$f_{n-1}(z) + f_{n+1}(z) = (2n+1)z^{-1}f_n(z)$$

($n=0, \pm 1, \pm 2, \dots$)

The Functions $j_n(z), y_n(z)$ for $n=0, 1, 2$

10.1.11

$$j_0(z) = \frac{\sin z}{z}$$

$$j_1(z) = \frac{\sin z}{z^2} - \frac{\cos z}{z}$$

$$j_2(z) = \left(\frac{3}{z^3} - \frac{1}{z}\right) \sin z - \frac{3}{z^2} \cos z$$

10.1.12

$$y_0(z) = -j_{-1}(z) = -\frac{\cos z}{z}$$

$$y_1(z) = j_{-2}(z) = -\frac{\cos z}{z^2} - \frac{\sin z}{z}$$

$$y_2(z) = -j_{-3}(z) = \left(-\frac{3}{z^3} + \frac{1}{z}\right) \cos z - \frac{3}{z^2} \sin z$$

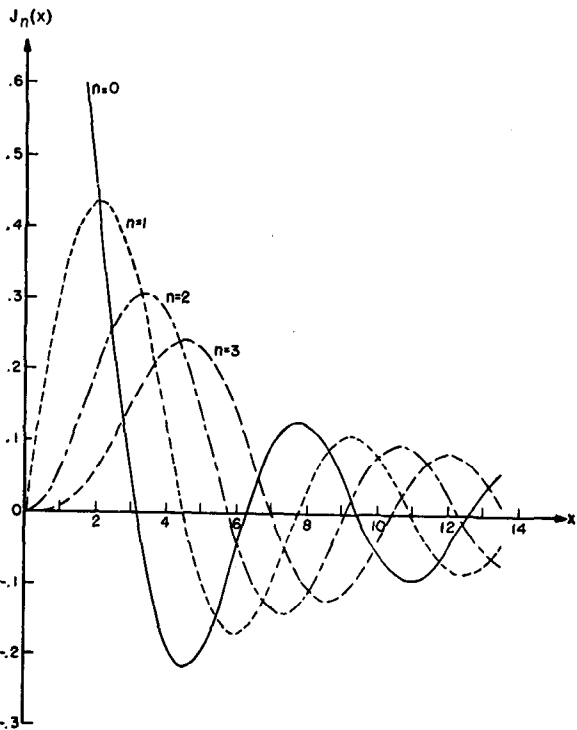

FIGURE 10.1. $j_n(x)$. $n=0(1)3$.

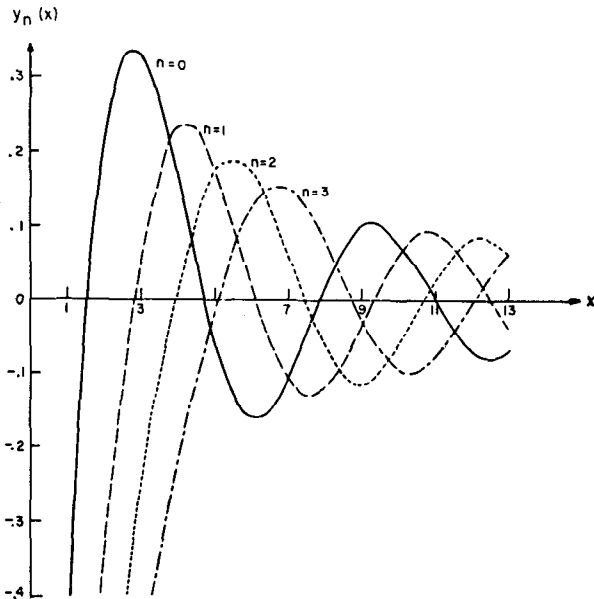

FIGURE 10.2. $y_n(x)$. $n=0(1)3$.

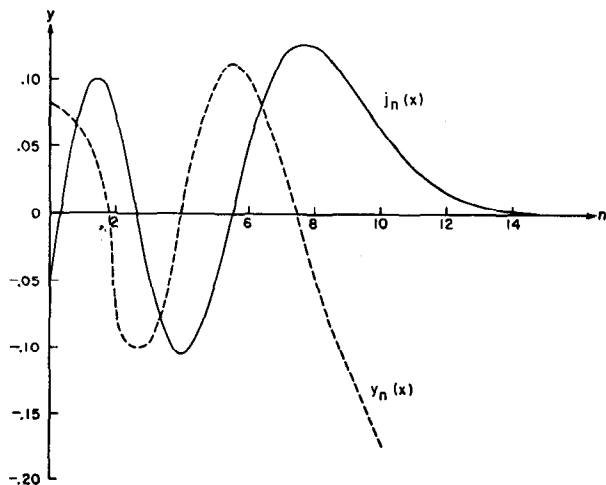

FIGURE 10.3. $j_n(x), y_n(x)$. $x=10$.

Poisson's Integral and Gegenbauer's Generalization

10.1.13
$$j_n(z) = \frac{z^n}{2^{n+1}n!} \int_0^\pi \cos(z \cos \theta) \sin^{2n+1} \theta \, d\theta$$

(See 9.1.20.)

10.1.14

$$= \frac{1}{2} (-i)^n \int_0^\pi e^{iz \cos \theta} P_n(\cos \theta) \sin \theta \, d\theta$$

($n=0, 1, 2, \dots$)

*See page II.

Spherical Bessel Functions of the Second and Third Kind

10.1.15

$$y_n(z) = (-1)^{n+1} j_{-n-1}(z) \quad (n=0, \pm 1, \pm 2, \dots)$$

10.1.16

$$h_n^{(1)}(z) = i^{-n-1} z^{-1} e^{iz} \sum_0^n (n + \frac{1}{2}, k) (-2iz)^{-k}$$

10.1.17

$$h_n^{(2)}(z) = i^{n+1} z^{-1} e^{-iz} \sum_0^n (n + \frac{1}{2}, k) (2iz)^{-k} \quad *$$

10.1.18

$$h_{-n-1}^{(1)}(z) = i(-1)^n h_n^{(1)}(z)$$

$$h_{-n-1}^{(2)}(z) = -i(-1)^n h_n^{(2)}(z) \quad (n=0, 1, 2, \dots)$$

**Elementary Properties
Recurrence Relations**

$$f_n(z) : j_n(z), y_n(z), h_n^{(1)}(z), h_n^{(2)}(z) \quad (n=0, \pm 1, \pm 2, \dots)$$

10.1.19 $f_{n-1}(z) + f_{n+1}(z) = (2n+1)z^{-1}f_n(z)$

10.1.20 $nf_{n-1}(z) - (n+1)f_{n+1}(z) = (2n+1) \frac{d}{dz} f_n(z)$

10.1.21 $\frac{n+1}{z} f_n(z) + \frac{d}{dz} f_n(z) = f_{n-1}(z)$

(See 10.1.23.)

10.1.22 $\frac{n}{z} f_n(z) - \frac{d}{dz} f_n(z) = f_{n+1}(z)$

(See 10.1.24.)

Differentiation Formulas

$$f_n(z) : j_n(z), y_n(z), h_n^{(1)}(z), h_n^{(2)}(z) \quad (n=0, \pm 1, \pm 2, \dots)$$

10.1.23 $\left(\frac{1}{z} \frac{d}{dz}\right)^m [z^{n+1} f_n(z)] = z^{n-m+1} f_{n-m}(z)$

10.1.24 $\left(\frac{1}{z} \frac{d}{dz}\right)^m [z^{-n} f_n(z)] = (-1)^m z^{-n-m} f_{n+m}(z) \quad (m=1, 2, 3, \dots)$

Rayleigh's Formulas

10.1.25

$$j_n(z) = z^n \left(-\frac{1}{z} \frac{d}{dz}\right)^n \frac{\sin z}{z}$$

10.1.26

$$y_n(z) = -z^n \left(-\frac{1}{z} \frac{d}{dz}\right)^n \frac{\cos z}{z} \quad (n=0, 1, 2, \dots)$$

Modulus and Phase

$$j_n(z) = \sqrt{\frac{1}{2}\pi/z} M_{n+\frac{1}{2}}(z) \cos \theta_{n+\frac{1}{2}}(z),$$

$$y_n(z) = \sqrt{\frac{1}{2}\pi/z} M_{n+\frac{1}{2}}(z) \sin \theta_{n+\frac{1}{2}}(z)$$

(See 9.2.17.)

10.1.27

$$\left(\frac{1}{2}\pi/z\right) M_{n+\frac{1}{2}}^2(z) = \frac{1}{z^2} \sum_0^n \frac{(2n-k)!(2n-2k)!}{k![(n-k)!]^2} (2z)^{2k-2n}$$

(See 9.2.28.)

10.1.28 $\left(\frac{1}{2}\pi/z\right) M_{1/2}^2(z) = j_0^2(z) + y_0^2(z) = z^{-2}$

10.1.29

$$\left(\frac{1}{2}\pi/z\right) M_{3/2}^2(z) = j_1^2(z) + y_1^2(z) = z^{-2} + z^{-4}$$

10.1.30

$$\left(\frac{1}{2}\pi/z\right) M_{5/2}^2(z) = j_2^2(z) + y_2^2(z) = z^{-2} + 3z^{-4} + 9z^{-6}$$

Cross Products

10.1.31 $j_n(z)y_{n-1}(z) - j_{n-1}(z)y_n(z) = z^{-2}$

10.1.32

$$j_{n+1}(z)y_{n-1}(z) - j_{n-1}(z)y_{n+1}(z) = (2n+1)z^{-3}$$

10.1.33

$$j_0(z)j_n(z) + y_0(z)y_n(z) = z^{-2} \sum_0^{[n]} (-1)^k 2^{n-2k} \binom{k+\frac{1}{2}}{n-2k} \binom{n-k}{k} z^{2k-n} \quad (n=0, 1, 2, \dots)$$

Analytic Continuation

10.1.34 $j_n(ze^{m\pi i}) = e^{m\pi i} j_n(z)$

10.1.35 $y_n(ze^{m\pi i}) = (-1)^m e^{m\pi i} y_n(z)$

10.1.36 $h_n^{(1)}(ze^{(2m+1)\pi i}) = (-1)^n h_n^{(2)}(z)$

10.1.37 $h_n^{(2)}(ze^{(2m+1)\pi i}) = (-1)^n h_n^{(1)}(z)$

10.1.38 $h_n^{(l)}(ze^{2m\pi i}) = h_n^{(l)}(z) \quad (l=1, 2; m, n=0, 1, 2, \dots)$

Generating Functions

10.1.39

$$\frac{1}{z} \sin \sqrt{z^2 + 2zt} = \sum_0^\infty \frac{(-t)^n}{n!} y_{n-1}(z) \quad (2|t| < |z|)$$

10.1.40 $\frac{1}{z} \cos \sqrt{z^2 - 2zt} = \sum_0^\infty \frac{t^n}{n!} j_{n-1}(z)$

*See page II.

Derivatives With Respect to Order

10.1.41

$$\left[\frac{\partial}{\partial \nu} j_\nu(x) \right]_{\nu=0} = (\frac{1}{2}\pi/x) \{ \text{Ci}(2x) \sin x - \text{Si}(2x) \cos x \}$$

10.1.42

$$\left[\frac{\partial}{\partial \nu} j_\nu(x) \right]_{\nu=-1} = (\frac{1}{2}\pi/x) \{ \text{Ci}(2x) \cos x + \text{Si}(2x) \sin x \}$$

10.1.43

$$\left[\frac{\partial}{\partial \nu} y_\nu(x) \right]_{\nu=0} = (\frac{1}{2}\pi/x) \{ \text{Ci}(2x) \cos x + [\text{Si}(2x) - \pi] \sin x \}$$

10.1.44

$$\left[\frac{\partial}{\partial \nu} y_\nu(x) \right]_{\nu=-1} = (\frac{1}{2}\pi/x) \{ \text{Ci}(2x) \sin x - [\text{Si}(2x) - \pi] \cos x \}$$

Addition Theorems and Degenerate Forms

r, ρ, θ, λ arbitrary complex; $R = \sqrt{(r^2 + \rho^2 - 2r\rho \cos \theta)}$

10.1.45 $\frac{\sin \lambda R}{\lambda R} = \sum_0^\infty (2n+1) j_n(\lambda r) j_n(\lambda \rho) P_n(\cos \theta)$

*10.1.46 $-\frac{\cos \lambda R}{\lambda R} = \sum_0^\infty (2n+1) j_n(\lambda r) y_n(\lambda \rho) P_n(\cos \theta)$
 $|re^{\pm i\theta}| < |\rho|$

10.1.47 $e^{iz \cos \theta} = \sum_0^\infty (2n+1) e^{i\pi n t} j_n(z) P_n(\cos \theta)$

10.1.48

$$J_0(z \sin \theta) = \sum_0^\infty (4n+1) \frac{(2n)!}{2^{2n}(n!)^2} j_{2n}(z) P_{2n}(\cos \theta)$$

Duplication Formula

10.1.49

$$j_n(2z) =$$

* $-n! z^{n+1} \sum_0^n \frac{2n-2k+1}{k!(2n-k+1)!} j_{n-k}(z) y_{n-k}(z)$

Some Infinite Series Involving $j_n^2(z)$

10.1.50 $\sum_0^\infty (2n+1) j_n^2(z) = 1$

10.1.51 $\sum_0^\infty (-1)^n (2n+1) j_n^2(z) = \frac{\sin 2z}{2z}$

10.1.52 $\sum_0^\infty j_n^2(z) = \frac{\text{Si}(2z)}{2z}$

*See page II.

Fresnel Integrals

10.1.53

$$C(\sqrt{2x/\pi}) = \frac{1}{2} \int_0^x J_{-1/2}(t) dt$$

$$= \sqrt{2} [\cos \frac{1}{2}x \sum_0^\infty (-1)^n J_{2n+1/2}(\frac{1}{2}x) + \sin \frac{1}{2}x \sum_0^\infty (-1)^n J_{2n+3/2}(\frac{1}{2}x)]$$

10.1.54

$$S(\sqrt{2x/\pi}) = \frac{1}{2} \int_0^x J_{1/2}(t) dt$$

$$= \sqrt{2} [\sin \frac{1}{2}x \sum_0^\infty (-1)^n J_{2n+1/2}(\frac{1}{2}x) - \cos \frac{1}{2}x \sum_0^\infty (-1)^n J_{2n+3/2}(\frac{1}{2}x)].$$

(See also 11.1.1, 11.1.2.)

Zeros and Their Asymptotic Expansions

The zeros of $j_n(x)$ and $y_n(x)$ are the same as the zeros of $J_{n+1/2}(x)$ and $Y_{n+1/2}(x)$ and the formulas for $j_{r,s}$ and $y_{r,s}$ given in 9.5 are applicable with $\nu = n + \frac{1}{2}$. There are, however, no simple relations connecting the zeros of the derivatives. Accordingly, we now give formulas for $a'_{n,s}$, $b'_{n,s}$, the s -th positive zero of $j'_n(z)$, $y'_n(z)$, respectively; $z=0$ is counted as the first zero of $j'_0(z)$.

(Tables of $a'_{n,s}$, $b'_{n,s}$, $j_n(a'_{n,s})$, $y_n(b'_{n,s})$ are given in [10.31].)

Elementary Relations

$$f_n(z) = j_n(z) \cos \pi t + y_n(z) \sin \pi t$$

(t a real parameter, $0 \leq t \leq 1$)

If τ_n is a zero of $f'_n(z)$ then

10.1.55 $f_n(\tau_n) = [\tau_n/(n+1)] f_{n-1}(\tau_n)$
 (See 10.1.21.)

10.1.56 $= (\tau_n/n) f_{n+1}(\tau_n)$
 (See 10.1.22.)

10.1.57 $= \left\{ \frac{1}{\pi} [\tau_n^2 - n(n+1)] \frac{d\tau_n}{d\tau} \right\}^{-1}$

McMahon's Expansions for n Fixed and s Large

10.1.58

$$a'_{n,s}, b'_{n,s} \sim \beta - (\mu + 7)(8\beta)^{-1} - \frac{4}{3}(7\mu^2 + 154\mu + 95)(8\beta)^{-3} - \frac{32}{15}(85\mu^3 + 3535\mu^2 + 3561\mu + 6133)(8\beta)^{-5} - \frac{64}{105}(6949\mu^4 + 474908\mu^3 + 330638\mu^2 + 9046780\mu - 5075147)(8\beta)^{-7} - \dots$$

$$\beta = \pi(s + \frac{1}{2}n - \frac{1}{2}) \text{ for } a'_{n,s}, \beta = \pi(s + \frac{1}{2}n) \text{ for } b'_{n,s}; \mu = (2n + 1)^2$$

Asymptotic Expansions of Zeros and Associated Values for n Large

10.1.59

$$a'_{n,1} \sim (n + \frac{1}{2}) + .8086165(n + \frac{1}{2})^{1/3} - .236680(n + \frac{1}{2})^{-1/3} - .20736(n + \frac{1}{2})^{-1} + .0233(n + \frac{1}{2})^{-5/3} + \dots$$

10.1.60

$$b'_{n,1} \sim (n + \frac{1}{2}) + 1.8210980(n + \frac{1}{2})^{1/3} + .802728(n + \frac{1}{2})^{-1/3} - .11740(n + \frac{1}{2})^{-1} + .0249(n + \frac{1}{2})^{-5/3} + \dots$$

10.1.61

$$j_n(a'_{n,1}) \sim .8458430(n + \frac{1}{2})^{-5/6} \{ 1 - .566032(n + \frac{1}{2})^{-2/3} + .38081(n + \frac{1}{2})^{-4/3} - .2203(n + \frac{1}{2})^{-2} + \dots \}$$

10.1.62

$$y_n(b'_{n,1}) \sim .7183921(n + \frac{1}{2})^{-5/6} \{ 1 - 1.274769(n + \frac{1}{2})^{-2/3} + 1.23038(n + \frac{1}{2})^{-4/3} - 1.0070(n + \frac{1}{2})^{-2} + \dots \}$$

See [10.31] for corresponding expansions for $s=2, 3$.

Uniform Asymptotic Expansions of Zeros and Associated Values for n Large

10.1.63

$$a'_{n,s} \sim (n + \frac{1}{2}) \{ z[(n + \frac{1}{2})^{-2/3} a'_s] + \sum_{k=1}^{\infty} h_k[(n + \frac{1}{2})^{-2/3} a'_s](n + \frac{1}{2})^{-2k} \}$$

10.1.64

$$b'_{n,s} \sim (n + \frac{1}{2}) \{ z[(n + \frac{1}{2})^{-2/3} b'_s] + \sum_{k=1}^{\infty} h_k[(n + \frac{1}{2})^{-2/3} b'_s](n + \frac{1}{2})^{-2k} \}$$

10.1.65

$$j_n(a'_{n,s}) \sim \sqrt{\frac{1}{2}\pi} \text{Ai}(a'_s)(n + \frac{1}{2})^{-5/6} h[(n + \frac{1}{2})^{-2/3} a'_s] \{ z[(n + \frac{1}{2})^{-2/3} a'_s] \}^{-1/2} \{ 1 + \sum_{k=1}^{\infty} H_k[(n + \frac{1}{2})^{-2/3} a'_s](n + \frac{1}{2})^{-2k} \}$$

10.1.66

$$y_n(b'_{n,s}) \sim -\sqrt{\frac{1}{2}\pi} \text{Bi}(b'_s)(n + \frac{1}{2})^{-5/6} h[(n + \frac{1}{2})^{-2/3} b'_s] \{ z[(n + \frac{1}{2})^{-2/3} b'_s] \}^{-1/2} \{ 1 + \sum_{k=1}^{\infty} H_k[(n + \frac{1}{2})^{-2/3} b'_s](n + \frac{1}{2})^{-2k} \}$$

$h(\xi), z(\xi)$ are defined as in 9.5.26, 9.3.38, 9.3.39. a'_s, b'_s s -th (negative) real zero of $\text{Ai}'(z), \text{Bi}'(z)$ (see 10.4.95, 10.4.99.)

Complex Zeros of $h_n^{(1)}(z), h_n^{(1)'}(z)$

$h_n^{(1)}(z)$ and $h_n^{(1)}(ze^{2m\pi i})$, m any integer, have the same zeros.

$h_n^{(1)}(z)$ has n zeros, symmetrically distributed with respect to the imaginary axis and lying approximately on the finite arc joining $z=-n$ and $z=n$ shown in Figure 9.6. If n is odd, one zero lies on the imaginary axis.

$h_n^{(1)'}(z)$ has $n+1$ zeros lying approximately on the same curve. If n is even, one zero lies on the imaginary axis.

$-\zeta$	$(-\zeta)h_1(\zeta)$	$(-\zeta)h_2(\zeta)$	$(-\zeta)h_3(\zeta)$	$(-\zeta)^2H_1(\zeta)$	$(-\zeta)^4H_2(\zeta)$	$(-\zeta)^6H_3(\zeta)$
0.0	-.4409724	-.122500	-.06806	.000000	.00000	.0000
0.2	-.4572444	-.114201	-.05986	.027518	.00575	.0023
0.4	-.4702250	-.107243	-.05279	.049069	.01118	.0043
0.6	-.4802184	-.101318	-.04674	.065677	.01592	.0061
0.8	-.4875705	-.096159	-.04160	.078255	.01983	.0075
1.0	-.4926355	-.091561	-.03725	.087587	.02290	.0085
$-\zeta$	$h_1(\zeta)$	$h_2(\zeta)$	$h_3(\zeta)$	$H_1(\zeta)$	$H_2(\zeta)$	
1.0	-.4926355	-.09156	-.037	.087587	.0229	
1.2	-.4131280	-.05056	-.014	.065507	.0121	
1.4	-.3551700	-.03043	-.006	.050524	.0070	
1.6	-.3108548	-.01950	-.003	.039890	.0042	
1.8	-.2757704	-.01310	-.001	.032085	.0027	
2.0	-.2472521	-.00914		.026206	.0018	
2.2	-.2235898	-.00658		.021682	.0012	
2.4	-.2036314	-.00485		.018141	.0008	
2.6	-.1865701	-.00366		.015326	.0006	
2.8	-.1718217	-.00280		.013061	.0004	
3.0	-.1589519	-.00219		.011217	.0003	
3.2	-.1476304	-.00173		.009701	.0002	
3.4	-.1376005	-.00138		.008443	.0002	
3.6	-.1286601	-.00112		.007391	.0001	
3.8	-.1206469	-.00091		.006505	.0001	
4.0	-.1134296	-.00075		.005753		
4.2	-.1069004	-.00062		.005111		
4.4	-.1009699	-.00052		.004560		
4.6	-.0955634	-.00044		.004085		
4.8	-.0906180	-.00037		.003672		
5.0	-.0860804	-.00032		.003313		
5.2	-.0819049	-.00027		.002998		
5.4	-.0780523	-.00023		.002722		
5.6	-.0744888	-.00020		.002478		
5.8	-.0711850	-.00018		.002262		
6.0	-.0681152	-.00015		.002070		
6.2	-.0652570	-.00013		.001899		
6.4	-.0625905	-.00012		.001746		
6.6	-.0600985	-.00010		.001609		
6.8	-.0577653	-.00009		.001486		
7.0	-.0555773	-.00008		.001375		

$(-\zeta) \rightarrow$	$h_1(\zeta)$	$h_2(\zeta)$	$H_1(\zeta)$
0.40	-.0645731	-.00013	.001859
.36	-.0487592	-.00005	.001056
.32	-.0352949	-.00002	.000551
.28	-.0242415	-.00001	.000259
.24	-.0155683		.000106
.20	-.0091416		.000037
.16	-.0047276		.000010
.12	-.0020068		.000002
.08	-.0005965		
.04	-.0000747		
.00	-.0000000		

10.2. Modified Spherical Bessel Functions

Definitions

Differential Equation

10.2.1

$$z^2 w'' + 2zw' - [z^2 + n(n+1)]w = 0$$

($n=0, \pm 1, \pm 2, \dots$)

Particular solutions are the *Modified Spherical Bessel functions of the first kind*,

10.2.2

$$\begin{aligned} \sqrt{\frac{1}{2}\pi/z} I_{n+\frac{1}{2}}(z) &= e^{-n\pi i/2} j_n(ze^{\pi i/2}) & (-\pi < \arg z \leq \frac{1}{2}\pi) \\ &= e^{3n\pi i/2} j_n(ze^{-3\pi i/2}) & (\frac{1}{2}\pi < \arg z \leq \pi) \end{aligned}$$

of the second kind,

10.2.3

$$\begin{aligned} \sqrt{\frac{1}{2}\pi/z} I_{-n-\frac{1}{2}}(z) &= e^{3(n+1)\pi i/2} y_n(ze^{\pi i/2}) & (-\pi < \arg z \leq \frac{1}{2}\pi) \\ &= e^{-(n+1)\pi i/2} y_n(ze^{-3\pi i/2}) & (\frac{1}{2}\pi < \arg z \leq \pi) \end{aligned}$$

of the third kind,

10.2.4

$$\sqrt{\frac{1}{2}\pi/z} K_{n+\frac{1}{2}}(z) = \frac{1}{2}\pi (-1)^{n+1} \sqrt{\frac{1}{2}\pi/z} [I_{n+\frac{1}{2}}(z) - I_{-n-\frac{1}{2}}(z)]$$

The pairs

$$\sqrt{\frac{1}{2}\pi/z} I_{n+\frac{1}{2}}(z), \sqrt{\frac{1}{2}\pi/z} I_{-n-\frac{1}{2}}(z)$$

and

$$\sqrt{\frac{1}{2}\pi/z} I_{n+\frac{1}{2}}(z), \sqrt{\frac{1}{2}\pi/z} K_{n+\frac{1}{2}}(z)$$

are linearly independent solutions for every n .

Most properties of the Modified Spherical Bessel functions can be derived from those of the Spherical Bessel functions by use of the above relations.

Ascending Series

10.2.5

$$\begin{aligned} \sqrt{\frac{1}{2}\pi/z} I_{n+\frac{1}{2}}(z) &= \frac{z^n}{1 \cdot 3 \cdot 5 \dots (2n+1)} \\ &\left\{ 1 + \frac{\frac{1}{2}z^2}{1!(2n+3)} + \frac{(\frac{1}{2}z^2)^2}{2!(2n+3)(2n+5)} + \dots \right\} \end{aligned}$$

10.2.6

$$\begin{aligned} \sqrt{\frac{1}{2}\pi/z} I_{-n-\frac{1}{2}}(z) &= \frac{1 \cdot 3 \cdot 5 \dots (2n-1)}{(-1)^n z^{n+1}} \\ &\left\{ 1 + \frac{\frac{1}{2}z^2}{1!(1-2n)} + \frac{(\frac{1}{2}z^2)^2}{2!(1-2n)(3-2n)} + \dots \right\} \end{aligned}$$

($n=0, 1, 2, \dots$)

Wronskians

10.2.7

$$W\{\sqrt{\frac{1}{2}\pi/z} I_{n+\frac{1}{2}}(z), \sqrt{\frac{1}{2}\pi/z} I_{-n-\frac{1}{2}}(z)\} = (-1)^{n+1} z^{-2}$$

10.2.8

$$W\{\sqrt{\frac{1}{2}\pi/z} I_{n+\frac{1}{2}}(z), \sqrt{\frac{1}{2}\pi/z} K_{n+\frac{1}{2}}(z)\} = -\frac{1}{2}\pi z^{-2}$$

Representations by Elementary Functions

10.2.9

$$\begin{aligned} \sqrt{\frac{1}{2}\pi/z} I_{n+\frac{1}{2}}(z) &= (2z)^{-1} [R(n+\frac{1}{2}, -z) e^z \\ &\quad - (-1)^n R(n+\frac{1}{2}, z) e^{-z}] \end{aligned}$$

10.2.10

$$\begin{aligned} \sqrt{\frac{1}{2}\pi/z} I_{-n-\frac{1}{2}}(z) &= (2z)^{-1} [R(n+\frac{1}{2}, -z) e^z \\ &\quad + (-1)^n R(n+\frac{1}{2}, z) e^{-z}] \end{aligned}$$

10.2.11

$$\begin{aligned} R(n+\frac{1}{2}, z) &= 1 + \frac{(n+1)!}{1!\Gamma(n)} (2z)^{-1} \\ &\quad + \frac{(n+2)!}{2!\Gamma(n-1)} (2z)^{-2} + \dots \\ &= \sum_0^n (n+\frac{1}{2}, k) (2z)^{-k} \end{aligned}$$

($n=0, 1, 2, \dots$)

(See 10.1.9.)

10.2.12

$$\begin{aligned} \sqrt{\frac{1}{2}\pi/z} I_{n+\frac{1}{2}}(z) &= g_n(z) \sinh z + g_{-n-1}(z) \cosh z \\ g_0(z) &= z^{-1}, g_1(z) = -z^{-2} \\ g_{n-1}(z) - g_{n+1}(z) &= (2n+1) z^{-1} g_n(z) \end{aligned}$$

($n=0, \pm 1, \pm 2, \dots$)

The Functions $\sqrt{\frac{1}{2}\pi/z} I_{\pm(n+\frac{1}{2})}(z), n=0, 1, 2$

10.2.13

$$\begin{aligned} \sqrt{\frac{1}{2}\pi/z} I_{1/2}(z) &= \frac{\sinh z}{z} \\ \sqrt{\frac{1}{2}\pi/z} I_{3/2}(z) &= -\frac{\sinh z}{z^2} + \frac{\cosh z}{z} \\ \sqrt{\frac{1}{2}\pi/z} I_{5/2}(z) &= \left(\frac{3}{z^3} + \frac{1}{z}\right) \sinh z - \frac{3}{z^2} \cosh z \end{aligned} \quad *$$

10.2.14

$$\begin{aligned} \sqrt{\frac{1}{2}\pi/z} I_{-1/2}(z) &= \frac{\cosh z}{z} \\ \sqrt{\frac{1}{2}\pi/z} I_{-3/2}(z) &= \frac{\sinh z}{z} - \frac{\cosh z}{z^2} \\ \sqrt{\frac{1}{2}\pi/z} I_{-5/2}(z) &= -\frac{3}{z^2} \sinh z + \left(\frac{3}{z^3} + \frac{1}{z}\right) \cosh z \end{aligned} \quad *$$

*See page II.

Modified Spherical Bessel Functions of the Third Kind

10.2.15

$$\begin{aligned} \sqrt{\frac{1}{2}\pi/z}K_{n+\frac{1}{2}}(z) &= \frac{1}{2}\pi i e^{(n+1)\pi i/2} h_n^{(1)}(ze^{\frac{1}{2}\pi i}) \\ &\quad (-\pi < \arg z \leq \frac{1}{2}\pi) \\ &= -\frac{1}{2}\pi i e^{-(n+1)\pi i/2} h_n^{(2)}(ze^{-\frac{1}{2}\pi i}) \\ &\quad (\frac{1}{2}\pi < \arg z \leq \pi) \\ &= (\frac{1}{2}\pi/z)e^{-z} \sum_0^n (n+\frac{1}{2}, k)(2z)^{-k} \end{aligned}$$

10.2.16

$$K_{n+\frac{1}{2}}(z) = K_{-n-\frac{1}{2}}(z) \quad (n=0, 1, 2, \dots)$$

The Functions $\sqrt{\frac{1}{2}\pi/z}K_{n+\frac{1}{2}}(z), n=0, 1, 2$

10.2.17 $\sqrt{\frac{1}{2}\pi/z}K_{1/2}(z) = (\frac{1}{2}\pi/z)e^{-z}$

$$\sqrt{\frac{1}{2}\pi/z}K_{3/2}(z) = (\frac{1}{2}\pi/z)e^{-z}(1+z^{-1})$$

$$\sqrt{\frac{1}{2}\pi/z}K_{5/2}(z) = (\frac{1}{2}\pi/z)e^{-z}(1+3z^{-1}+3z^{-2})$$

Elementary Properties

Recurrence Relations

$$f_n(z) : \sqrt{\frac{1}{2}\pi/z}I_{n+\frac{1}{2}}(z), (-1)^{n+1}\sqrt{\frac{1}{2}\pi/z}K_{n+\frac{1}{2}}(z) \quad (n=0, \pm 1, \pm 2, \dots)$$

10.2.18 $f_{n-1}(z) - f_{n+1}(z) = (2n+1)z^{-1}f_n(z)$

10.2.19 $nf_{n-1}(z) + (n+1)f_{n+1}(z) = (2n+1)\frac{d}{dz}f_n(z)$

10.2.20 $\frac{n+1}{z}f_n(z) + \frac{d}{dz}f_n(z) = f_{n-1}(z)$
(See 10.2.22.)

10.2.21 $-\frac{n}{z}f_n(z) + \frac{d}{dz}f_n(z) = f_{n+1}(z)$
(See 10.2.23.)

Differentiation Formulas

$$f_n(z) : \sqrt{\frac{1}{2}\pi/z}I_{n+\frac{1}{2}}(z), (-1)^{n+1}\sqrt{\frac{1}{2}\pi/z}K_{n+\frac{1}{2}}(z) \quad (n=0, \pm 1, \pm 2, \dots)$$

10.2.22 $(\frac{1}{z}\frac{d}{dz})^m [z^{n+1}f_n(z)] = z^{n-m+1}f_{n-m}(z)$

10.2.23 $(\frac{1}{z}\frac{d}{dz})^m [z^{-n}f_n(z)] = z^{-n-m}f_{n+m}(z) \quad (m=1, 2, 3, \dots)$

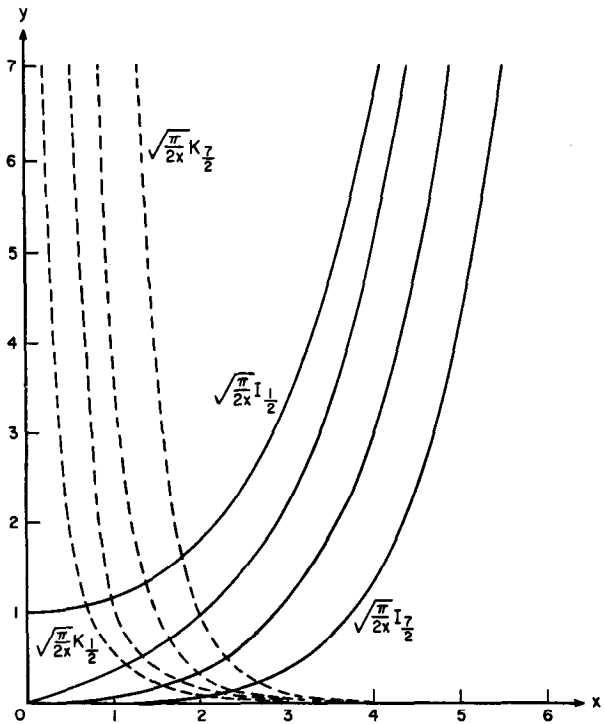

FIGURE 10.4. $\sqrt{\frac{\pi}{2x}}I_{n+\frac{1}{2}}(x), \sqrt{\frac{\pi}{2x}}K_{n+\frac{1}{2}}(x). n=0(1)3.$

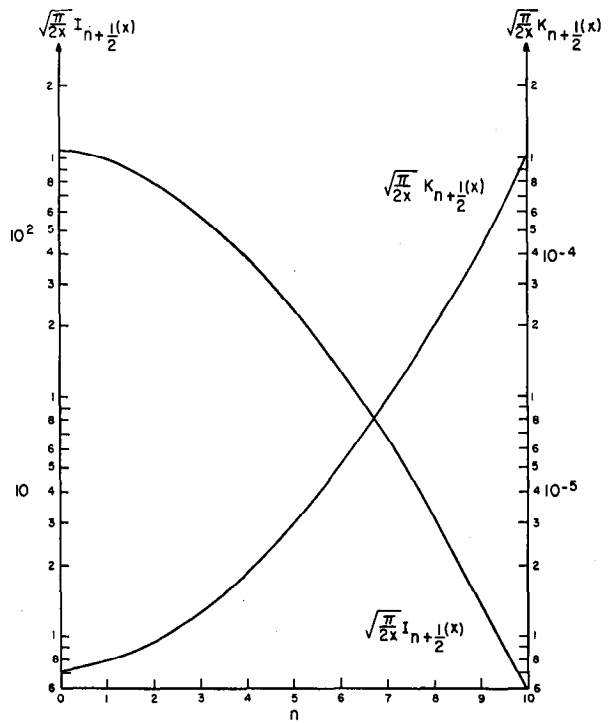

FIGURE 10.5. $\sqrt{\frac{\pi}{2x}}I_{n+\frac{1}{2}}(x), \sqrt{\frac{\pi}{2x}}K_{n+\frac{1}{2}}(x). x=10.$

Formulas of Rayleigh's Type

10.2.24 $\sqrt{\frac{1}{2}\pi/z} I_{n+\frac{1}{2}}(z) = z^n \left(\frac{1}{z} \frac{d}{dz}\right)^n \frac{\sinh z}{z}$

10.2.25

$\sqrt{\frac{1}{2}\pi/z} I_{-n-\frac{1}{2}}(z) = z^n \left(\frac{1}{z} \frac{d}{dz}\right)^n \frac{\cosh z}{z}$
 ($n=0, 1, 2, \dots$)

Formulas for $I_{n+\frac{1}{2}}^2(z) - I_{-n-\frac{1}{2}}^2(z)$

10.2.26

$(\frac{1}{2}\pi/z)[I_{n+\frac{1}{2}}^2(z) - I_{-n-\frac{1}{2}}^2(z)]$
 $= \frac{1}{z^2} \sum_0^n (-1)^{k+1} \frac{(2n-k)!(2n-2k)!}{k![(n-k)!]^2} (2z)^{2k-2n}$
 ($n=0, 1, 2, \dots$)

10.2.27 $(\frac{1}{2}\pi/z)[I_{1/2}^2(z) - I_{-1/2}^2(z)] = -z^{-2}$

10.2.28 $(\frac{1}{2}\pi/z)[I_{3/2}^2(z) - I_{-3/2}^2(z)] = z^{-2} - z^{-4}$

10.2.29

$(\frac{1}{2}\pi/z)[I_{5/2}^2(z) - I_{-5/2}^2(z)] = -z^{-2} + 3z^{-4} - 9z^{-6}$

Generating Functions

10.2.30

$\frac{1}{z} \sinh \sqrt{z^2 - 2izt} = \sum_0^\infty \frac{(-it)^n}{n!} [\sqrt{\frac{1}{2}\pi/z} I_{-n-\frac{1}{2}}(z)]$
 ($2|t| < |z|$)

10.2.31

$\frac{1}{z} \cosh \sqrt{z^2 + 2izt} = \sum_0^\infty \frac{(it)^n}{n!} [\sqrt{\frac{1}{2}\pi/z} I_{n-\frac{1}{2}}(z)]$

Derivatives With Respect to Order

10.2.32

$\left[\frac{\partial}{\partial \nu} I_\nu(x)\right]_{\nu=-\frac{1}{2}} = -\frac{1}{2\pi x} [\text{Ei}(2x)e^{-x} - E_1(-2x)e^x]$

10.2.33

$\left[\frac{\partial}{\partial \nu} I_\nu(x)\right]_{\nu=-\frac{1}{2}} = \frac{1}{2\pi x} [\text{Ei}(2x)e^{-x} + E_1(-2x)e^x]$

10.2.34 $\left[\frac{\partial}{\partial \nu} K_\nu(x)\right]_{\nu=\pm\frac{1}{2}} = \mp \sqrt{\pi/2x} \text{Ei}(-2x)e^x$

For $E_1(x)$ and $\text{Ei}(x)$, see 5.1.1, 5.1.2.

Addition Theorems and Degenerate Forms

r, ρ, θ, λ arbitrary complex; $R = \sqrt{r^2 + \rho^2 - 2r\rho \cos \theta}$

10.2.35

$\frac{e^{-\lambda R}}{\lambda R} = \frac{2}{\pi} \sum_0^\infty (2n+1) [\sqrt{\frac{1}{2}\pi/\lambda r} I_{n+\frac{1}{2}}(\lambda r)]$
 $[\sqrt{\frac{1}{2}\pi/\lambda \rho} K_{n+\frac{1}{2}}(\lambda \rho)] P_n(\cos \theta)$

10.2.36

$e^{z \cos \theta} = \sum_0^\infty (2n+1) [\sqrt{\frac{1}{2}\pi/z} I_{n+\frac{1}{2}}(z)] P_n(\cos \theta)$

10.2.37

$e^{-z \cos \theta} = \sum_0^\infty (-1)^n (2n+1) [\sqrt{\frac{1}{2}\pi/z} I_{n+\frac{1}{2}}(z)] P_n(\cos \theta)$

Duplication Formula

10.2.38

$K_{n+\frac{1}{2}}(2z) = n! \pi^{-\frac{1}{2}} z^{n+\frac{1}{2}} \sum_0^n \frac{(-1)^k (2n-2k+1)}{k!(2n-k+1)!} K_{n-k+\frac{1}{2}}^2(z)$

10.3. Riccati-Bessel Functions

Differential Equation

10.3.1

$z^2 w'' + [z^2 - n(n+1)]w = 0$
 ($n=0, \pm 1, \pm 2, \dots$)

Pairs of linearly independent solutions are

$zj_n(z), zy_n(z)$
 $zh_n^{(1)}(z), zh_n^{(2)}(z)$

All properties of these functions follow directly from those of the Spherical Bessel functions.

The Functions $zj_n(z), zy_n(z), n=0, 1, 2$

10.3.2

$zj_0(z) = \sin z, \quad zj_1(z) = z^{-1} \sin z - \cos z$
 $zy_0(z) = (3z^{-2} - 1) \sin z - 3z^{-1} \cos z$ *

10.3.3

$zy_0(z) = -\cos z, \quad zy_1(z) = -\sin z - z^{-1} \cos z$
 $zy_2(z) = -3z^{-1} \sin z - (3z^{-2} - 1) \cos z$ *

Wronskians

10.3.4 $W\{zj_n(z), zy_n(z)\} = 1$

10.3.5 $W\{zh_n^{(1)}(z), zh_n^{(2)}(z)\} = -2i$
 ($n=0, 1, 2, \dots$)

*See page II.

10.4. Airy Functions

Definitions and Elementary Properties

Differential Equation

10.4.1 $w'' - zw = 0$

Pairs of linearly independent solutions are

- $Ai(z), Bi(z),$
- $Ai(z), Ai(ze^{2\pi i/3}),$
- $Ai(z), Ai(ze^{-2\pi i/3}).$

Ascending Series

10.4.2 $Ai(z) = c_1 f(z) - c_2 g(z)$

10.4.3 $Bi(z) = \sqrt{3} [c_1 f(z) + c_2 g(z)]$

$$f(z) = 1 + \frac{1}{3!} z^3 + \frac{1 \cdot 4}{6!} z^6 + \frac{1 \cdot 4 \cdot 7}{9!} z^9 + \dots$$

$$= \sum_0^{\infty} 3^k \left(\frac{1}{3}\right)_k \frac{z^{3k}}{(3k)!}$$

$$g(z) = z + \frac{2}{4!} z^4 + \frac{2 \cdot 5}{7!} z^7 + \frac{2 \cdot 5 \cdot 8}{10!} z^{10} + \dots$$

$$= \sum_0^{\infty} 3^k \left(\frac{2}{3}\right)_k \frac{z^{3k+1}}{(3k+1)!}$$

$$\left(\alpha + \frac{1}{3}\right)_0 = 1$$

$$3^k \left(\alpha + \frac{1}{3}\right)_k = (3\alpha + 1)(3\alpha + 4) \dots (3\alpha + 3k - 2)$$

(α arbitrary; $k = 1, 2, 3, \dots$)

(See 6.1.22.)

10.4.4

$$c_1 = Ai(0) = Bi(0) / \sqrt{3} = 3^{-2/3} / \Gamma(2/3)$$

$$= .35502 \ 80538 \ 87817$$

10.4.5

$$c_2 = -Ai'(0) = Bi'(0) / \sqrt{3} = 3^{-1/3} / \Gamma(1/3)$$

$$= .25881 \ 94037 \ 92807$$

Relations Between Solutions

10.4.6 $Bi(z) = e^{\pi i/6} Ai(ze^{2\pi i/3}) + e^{-\pi i/6} Ai(ze^{-2\pi i/3})$

10.4.7

$$Ai(z) + e^{2\pi i/3} Ai(ze^{2\pi i/3}) + e^{-2\pi i/3} Ai(ze^{-2\pi i/3}) = 0$$

10.4.8

$$Bi(z) + e^{2\pi i/3} Bi(ze^{2\pi i/3}) + e^{-2\pi i/3} Bi(ze^{-2\pi i/3}) = 0$$

10.4.9 $Ai(ze^{\pm 2\pi i/3}) = \frac{1}{2} e^{\pm \pi i/3} [Ai(z) \mp i Bi(z)]$

Wronskians

10.4.10 $W\{Ai(z), Bi(z)\} = \pi^{-1}$

10.4.11 $W\{Ai(z), Ai(ze^{2\pi i/3})\} = \frac{1}{2} \pi^{-1} e^{-\pi i/6}$

10.4.12 $W\{Ai(z), Ai(ze^{-2\pi i/3})\} = \frac{1}{2} \pi^{-1} e^{\pi i/6}$

10.4.13 $W\{Ai(ze^{2\pi i/3}), Ai(ze^{-2\pi i/3})\} = \frac{1}{2} i \pi^{-1}$

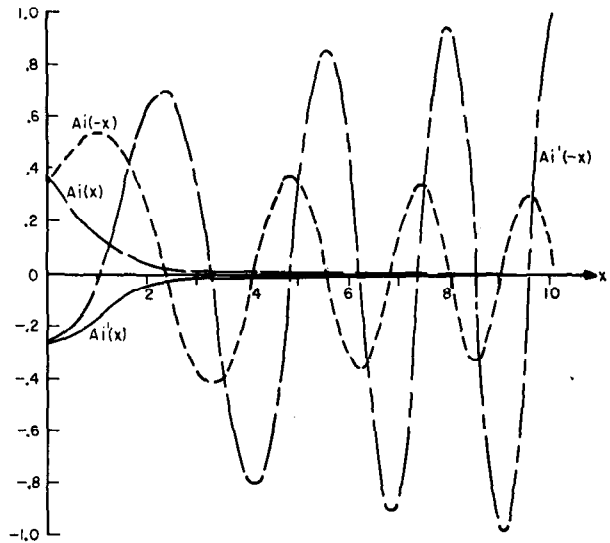

FIGURE 10.6. $Ai(\pm x), Ai'(\pm x)$.

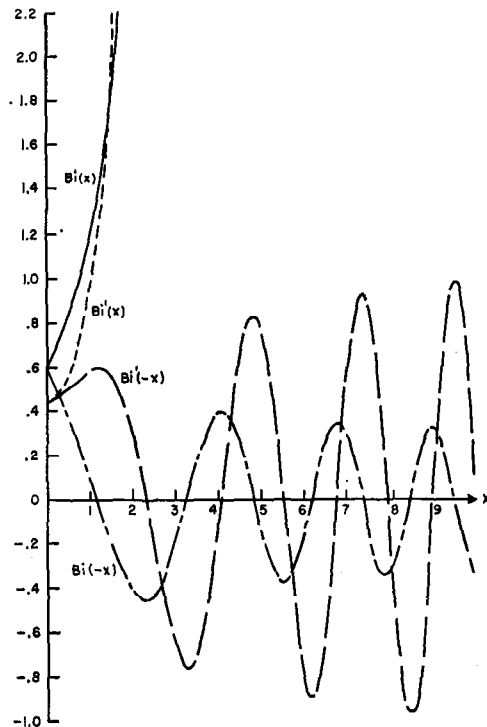

FIGURE 10.7. $Bi(\pm x), Bi'(\pm x)$.

Representations in Terms of Bessel Functions

$$\zeta = \frac{2}{3}z^{3/2}$$

10.4.14

$$\text{Ai}(z) = \frac{1}{3}\sqrt{z}[I_{-1/3}(\zeta) - I_{1/3}(\zeta)] = \pi^{-1}\sqrt{z/3}K_{1/3}(\zeta)$$

10.4.15

$$\begin{aligned} \text{Ai}(-z) &= \frac{1}{3}\sqrt{z}[J_{1/3}(\zeta) + J_{-1/3}(\zeta)] \\ &= \frac{1}{3}\sqrt{z/3}[e^{\pi i/6}H_{1/3}^{(1)}(\zeta) + e^{-\pi i/6}H_{1/3}^{(2)}(\zeta)] \end{aligned}$$

10.4.16

$$*\text{Ai}'(z) = \frac{1}{3}z[I_{-2/3}(\zeta) - I_{2/3}(\zeta)] = \pi^{-1}(z/\sqrt{3})K_{2/3}(\zeta)$$

10.4.17

$$\begin{aligned} \text{Ai}'(-z) &= -\frac{1}{3}z[J_{-2/3}(\zeta) - J_{2/3}(\zeta)] \\ &= \frac{1}{3}z(\sqrt{3})[e^{-\pi i/6}H_{2/3}^{(1)}(\zeta) + e^{\pi i/6}H_{2/3}^{(2)}(\zeta)] \end{aligned}$$

10.4.18

$$\text{Bi}(z) = \sqrt{z/3}[I_{-1/3}(\zeta) + I_{1/3}(\zeta)]$$

10.4.19

$$\begin{aligned} \text{Bi}(-z) &= \sqrt{z/3}[J_{-1/3}(\zeta) - J_{1/3}(\zeta)] \\ &= \frac{1}{3}i\sqrt{z/3}[e^{\pi i/6}H_{1/3}^{(1)}(\zeta) - e^{-\pi i/6}H_{1/3}^{(2)}(\zeta)] \end{aligned}$$

10.4.20

$$\text{Bi}'(z) = (z/\sqrt{3})[I_{-2/3}(\zeta) + I_{2/3}(\zeta)]$$

10.4.21

$$\begin{aligned} \text{Bi}'(-z) &= (z/\sqrt{3})[J_{-2/3}(\zeta) + J_{2/3}(\zeta)] \\ &= \frac{1}{3}i(z/\sqrt{3})[e^{-\pi i/6}H_{2/3}^{(1)}(\zeta) - e^{\pi i/6}H_{2/3}^{(2)}(\zeta)] \end{aligned}$$

Representations of Bessel Functions in Terms of Airy Functions

$$z = \left(\frac{3}{2}\zeta\right)^{2/3}$$

10.4.22

$$J_{\pm 1/3}(\zeta) = \frac{1}{3}\sqrt{3/z}[\sqrt{3}\text{Ai}(-z) \mp \text{Bi}(-z)]$$

*10.4.23

$$H_{\pm 1/3}^{(1)}(\zeta) = e^{\mp \pi i/6}\sqrt{3/z}[\text{Ai}(-z) - i\text{Bi}(-z)]$$

10.4.24

$$H_{\pm 1/3}^{(2)}(\zeta) = e^{\pm \pi i/6}\sqrt{3/z}[\text{Ai}(-z) + i\text{Bi}(-z)]$$

10.4.25

$$I_{\pm 1/3}(\zeta) = \frac{1}{3}\sqrt{3/z}[\mp \sqrt{3}\text{Ai}(z) + \text{Bi}(z)]$$

10.4.26

$$K_{\pm 1/3}(\zeta) = \pi\sqrt{z/3}\text{Ai}(z)$$

10.4.27

$$J_{\pm 2/3}(\zeta) = (\sqrt{3}/2z)[\pm \sqrt{3}\text{Ai}'(-z) + \text{Bi}'(-z)]$$

10.4.28

$$\begin{aligned} H_{2/3}^{(1)}(\zeta) &= e^{-2\pi i/3}H_{-2/3}^{(1)}(\zeta) \\ &= e^{\pi i/6}(\sqrt{3}/z)[\text{Ai}'(-z) - i\text{Bi}'(-z)] \end{aligned}$$

10.4.29

$$\begin{aligned} H_{2/3}^{(2)}(\zeta) &= e^{2\pi i/3}H_{-2/3}^{(2)}(\zeta) \\ &= e^{-\pi i/6}(\sqrt{3}/z)[\text{Ai}'(-z) + i\text{Bi}'(-z)] \end{aligned}$$

10.4.30 $I_{\pm 2/3}(\zeta) = (\sqrt{3}/2z)[\pm \sqrt{3}\text{Ai}'(z) + \text{Bi}'(z)]$

10.4.31 $K_{\pm 2/3}(\zeta) = -\pi(\sqrt{3}/z)\text{Ai}'(z)$

Integral Representations

10.4.32

$$(3a)^{-1/3}\pi\text{Ai}[\pm(3a)^{-1/3}x] = \int_0^\infty \cos(at^3 \pm xt)dt$$

10.4.33

$$\begin{aligned} (3a)^{-1/3}\pi\text{Bi}[\pm(3a)^{-1/3}x] \\ = \int_0^\infty [\exp(-at^3 \pm xt) + \sin(at^3 \pm xt)]dt \end{aligned}$$

The Integrals $\int_0^z \text{Ai}(\pm t)dt, \int_0^z \text{Bi}(\pm t)dt$

$$\zeta = \frac{2}{3}z^{3/2}$$

10.4.34 $\int_0^z \text{Ai}(t)dt = \frac{1}{3}\int_0^\zeta [I_{-1/3}(t) - I_{1/3}(t)]dt$

10.4.35 $\int_0^z \text{Ai}(-t)dt = \frac{1}{3}\int_0^\zeta [J_{-1/3}(t) + J_{1/3}(t)]dt$

10.4.36 $\int_0^z \text{Bi}(t)dt = \frac{1}{\sqrt{3}}\int_0^\zeta [I_{-1/3}(t) + I_{1/3}(t)]dt$

10.4.37 $\int_0^z \text{Bi}(-t)dt = \frac{1}{\sqrt{3}}\int_0^\zeta [J_{-1/3}(t) - J_{1/3}(t)]dt$

Ascending Series for $\int_0^z \text{Ai}(\pm t)dt, \int_0^z \text{Bi}(\pm t)dt$

10.4.38 $\int_0^z \text{Ai}(t)dt = c_1F(z) - c_2G(z)$

(See 10.4.2.)

10.4.39 $\int_0^z \text{Ai}(-t)dt = -c_1F(-z) + c_2G(-z)$

10.4.40 $\int_0^z \text{Bi}(t)dt = \sqrt{3}[c_1F(z) + c_2G(z)]$

(See 10.4.3.)

10.4.41

$$\int_0^z \text{Bi}(-t)dt = -\sqrt{3}[c_1F(-z) + c_2G(-z)]$$

$$F(z) = z + \frac{1}{4!}z^4 + \frac{1 \cdot 4}{7!}z^7 + \frac{1 \cdot 4 \cdot 7}{10!}z^{10} + \dots$$

$$= \sum_0^\infty 3^k \binom{1}{3}_k \frac{z^{3k+1}}{(3k+1)!}$$

$$G(z) = \frac{1}{2!}z^2 + \frac{2}{5!}z^5 + \frac{2 \cdot 5}{8!}z^8 + \frac{2 \cdot 5 \cdot 8}{11!}z^{11} + \dots$$

$$= \sum_0^\infty 3^k \binom{2}{3}_k \frac{z^{3k+2}}{(3k+2)!}$$

The constants c_1, c_2 are given in 10.4.4, 10.4.5.

*See page II.

The Functions $Gi(z)$, $Hi(z)$

10.4.42

$$Gi(z) = \pi^{-1} \int_0^{\infty} \sin\left(\frac{1}{3}t^3 + zt\right) dt$$

$$= \frac{1}{3} Bi(z) + \int_0^z [Ai(z) Bi(t) - Ai(t) Bi(z)] dt$$

10.4.43

$$Gi'(z) = \frac{1}{3} Bi'(z) + \int_0^z [Ai'(z) Bi(t) - Ai(t) Bi'(z)] dt$$

10.4.44

$$Hi(z) = \pi^{-1} \int_0^{\infty} \exp\left(-\frac{1}{3}t^3 + zt\right) dt$$

$$= \frac{2}{3} Bi(z) + \int_0^z [Ai(t) Bi(z) - Ai(z) Bi(t)] dt$$

10.4.45

$$Hi'(z) = \frac{2}{3} Bi'(z) + \int_0^z [Ai(t) Bi'(z) - Ai'(z) Bi(t)] dt$$

10.4.46 $Gi(z) + Hi(z) = Bi(z)$

Representations of $\int_0^z Ai(\pm t) dt$, $\int_0^z Bi(\pm t) dt$
by $Gi(\pm z)$, $Hi(\pm z)$

10.4.47

$$\int_0^z Ai(t) dt = \frac{1}{3} + \pi [Ai'(z) Gi(z) - Ai(z) Gi'(z)]$$

10.4.48

$$= -\frac{2}{3} - \pi [Ai'(z) Hi(z) - Ai(z) Hi'(z)]$$

10.4.49

$$\int_0^z Ai(-t) dt = -\frac{1}{3} - \pi [Ai'(-z) Gi(-z) - Ai(-z) Gi'(-z)]$$

10.4.50

$$= \frac{2}{3} + \pi [Ai'(-z) Hi(-z) - Ai(-z) Hi'(-z)]$$

10.4.51

$$\int_0^z Bi(t) dt = \pi [Bi'(z) Gi(z) - Bi(z) Gi'(z)]$$

10.4.52 $= -\pi [Bi'(z) Hi(z) - Bi(z) Hi'(z)]$

10.4.53

$$\int_0^z Bi(-t) dt = -\pi [Bi'(-z) Gi(-z) - Bi(-z) Gi'(-z)]$$

10.4.54 $= \pi [Bi'(-z) Hi(-z) - Bi(-z) Hi'(-z)]$

Differential Equations for $Gi(z)$, $Hi(z)$

10.4.55

$w'' - zw = -\pi^{-1}$

$$w(0) = \frac{1}{3} Bi(0) = \frac{1}{\sqrt{3}} Ai(0) = .20497\ 55424\ 78$$

$$w'(0) = \frac{1}{3} Bi'(0) = -\frac{1}{\sqrt{3}} Ai'(0) = .14942\ 94524\ 49$$

$w(z) = Gi(z)$

10.4.56

$w'' - zw = \pi^{-1}$

$$w(0) = \frac{2}{3} Bi(0) = \frac{2}{\sqrt{3}} Ai(0) = .40995\ 10849\ 56$$

$$w'(0) = \frac{2}{3} Bi'(0) = -\frac{2}{\sqrt{3}} Ai'(0) = .29885\ 89048\ 98$$

$w(z) = Hi(z)$

Differential Equation for Products of Airy Functions

10.4.57

$w''' - 4zw' - 2w = 0$

Linearly independent solutions are $Ai^2(z)$, $Ai(z) Bi(z)$, $Bi^2(z)$.

Wronskian for Products of Airy Functions

10.4.58 $W\{Ai^2(z), Ai(z) Bi(z), Bi^2(z)\} = 2\pi^{-3}$

Asymptotic Expansions for $|z|$ Large

$$c_0 = 1, c_k = \frac{\Gamma(3k + \frac{1}{2})}{54^k k! \Gamma(k + \frac{1}{2})} = \frac{(2k+1)(2k+3)\dots(6k-1)}{216^k k!}$$

$$d_0 = 1, d_k = -\frac{6k+1}{6k-1} c_k \quad (k=1, 2, 3, \dots)$$

$$\zeta = \frac{2}{3} z^{3/2}$$

10.4.59

$$Ai(z) \sim \frac{1}{2} \pi^{-1/2} z^{-1/4} e^{-\zeta} \sum_0^{\infty} (-1)^k c_k \zeta^{-k} \quad (|\arg z| < \pi)$$

10.4.60

$$Ai(-z) \sim \pi^{-1/2} z^{-1/4} \left[\sin\left(\zeta + \frac{\pi}{4}\right) \sum_0^{\infty} (-1)^k c_{2k} \zeta^{-2k} - \cos\left(\zeta + \frac{\pi}{4}\right) \sum_0^{\infty} (-1)^k c_{2k+1} \zeta^{-2k-1} \right]$$

$$(|\arg z| < \frac{3}{2}\pi)$$

10.4.61

$$Ai'(z) \sim -\frac{1}{2} \pi^{-1/2} z^{1/4} e^{-\zeta} \sum_0^{\infty} (-1)^k d_k \zeta^{-k} \quad (|\arg z| < \pi)$$

10.4.62

$$Ai'(-z) \sim -\pi^{-1/2} z^{\dagger} \left[\cos\left(\zeta + \frac{\pi}{4}\right) \sum_0^{\infty} (-1)^k d_{2k} \zeta^{-2k} + \sin\left(\zeta + \frac{\pi}{4}\right) \sum_0^{\infty} (-1)^k d_{2k+1} \zeta^{-2k-1} \right] \quad (|\arg z| < \frac{3}{2}\pi)$$

10.4.63

$$Bi(z) \sim \pi^{-1/2} z^{-\dagger} e^{\zeta} \sum_0^{\infty} c_k \zeta^{-k} \quad (|\arg z| < \frac{1}{2}\pi)$$

10.4.64

$$Bi(-z) \sim \pi^{-1/2} z^{-\dagger} \left[\cos\left(\zeta + \frac{\pi}{4}\right) \sum_0^{\infty} (-1)^k c_{2k} \zeta^{-2k} + \sin\left(\zeta + \frac{\pi}{4}\right) \sum_0^{\infty} (-1)^k c_{2k+1} \zeta^{-2k-1} \right] \quad (|\arg z| < \frac{3}{2}\pi)$$

10.4.65

Bi($ze^{\pm\pi i/3}$)

$$\sim \sqrt{2/\pi} e^{\pm\pi i/6} z^{-\dagger} \left[\sin\left(\zeta + \frac{\pi}{4} \mp \frac{i}{2} \ln 2\right) \sum_0^{\infty} (-1)^k c_{2k} \zeta^{-2k} - \cos\left(\zeta + \frac{\pi}{4} \mp \frac{i}{2} \ln 2\right) \sum_0^{\infty} (-1)^k c_{2k+1} \zeta^{-2k-1} \right] \quad (|\arg z| < \frac{3}{2}\pi)$$

10.4.66

* Bi'(z) $\sim \pi^{-1/2} z^{\dagger} e^{\zeta} \sum_0^{\infty} d_k \zeta^{-k}$ ($|\arg z| < \frac{1}{2}\pi$)

10.4.67

$$Bi'(-z) \sim \pi^{-1/2} z^{\dagger} \left[\sin\left(\zeta + \frac{\pi}{4}\right) \sum_0^{\infty} (-1)^k d_{2k} \zeta^{-2k} - \cos\left(\zeta + \frac{\pi}{4}\right) \sum_0^{\infty} (-1)^k d_{2k+1} \zeta^{-2k-1} \right] \quad (|\arg z| < \frac{3}{2}\pi)$$

10.4.68

Bi'(ze $^{\pm\pi i/3}$)

$$\sim \sqrt{2/\pi} e^{\mp\pi i/6} z^{\dagger} \left[\cos\left(\zeta + \frac{\pi}{4} \mp \frac{i}{2} \ln 2\right) \sum_0^{\infty} (-1)^k d_{2k} \zeta^{-2k} + \sin\left(\zeta + \frac{\pi}{4} \mp \frac{i}{2} \ln 2\right) \sum_0^{\infty} (-1)^k d_{2k+1} \zeta^{-2k-1} \right] \quad (|\arg z| < \frac{3}{2}\pi)$$

Modulus and Phase

10.4.69

Ai(-x) = M(x) cos $\theta(x)$, Bi(-x) = M(x) sin $\theta(x)$
 $M(x) = \sqrt{[Ai^2(-x) + Bi^2(-x)]}$,
 $\theta(x) = \arctan [Bi(-x)/Ai(-x)]$

10.4.70

Ai'(-x) = N(x) cos $\phi(x)$, Bi'(-x) = N(x) sin $\phi(x)$
 $N(x) = \sqrt{[Ai'^2(-x) + Bi'^2(-x)]}$,
 $\phi(x) = \arctan [Bi'(-x)/Ai'(-x)]$

Differential Equations for Modulus and Phase

Primes denote differentiation with respect to x

10.4.71 $M^2 \theta' = -\pi^{-1}$, $N^2 \phi' = -\pi^{-1} x$

10.4.72 $N^2 = M'^2 + M^2 \theta'^2 = M'^2 + \pi^{-2} M^{-2}$ *

10.4.73 $NN' = -xMM'$

10.4.74

$\tan(\phi - \theta) = M\theta'/M' = -(\pi MM')^{-1}$,
 $MN \sin(\phi - \theta) = \pi^{-1}$

10.4.75 $M'' + xM - \pi^{-2} M^{-3} = 0$

10.4.76 $(M^2)''' + 4x(M^2)' - 2M^2 = 0$

10.4.77 $\theta'^2 + \frac{1}{2}(\theta'''/\theta') - \frac{3}{4}(\theta''/\theta')^2 = x$

Asymptotic Expansions of Modulus and Phase for Large x

10.4.78 $M^2(x) \sim \frac{1}{\pi} x^{-1/2} \sum_0^{\infty} \frac{(-1)^k}{12^k k!} 2^{3k} \left(\frac{1}{2}\right)_{3k} (2x)^{-3k}$

10.4.79

$\theta(x) \sim \frac{1}{4}\pi - \frac{2}{3}x^{3/2} \left[1 - \frac{5}{4}(2x)^{-3} + \frac{1105}{96}(2x)^{-6} - \frac{82825}{128}(2x)^{-9} + \frac{1282031525}{14336}(2x)^{-12} - \dots \right]$

10.4.80

$N^2(x) \sim \frac{1}{\pi} x^{\dagger} \sum_0^{\infty} \frac{(-1)^{k+1} 6k+1}{12^k k!} 2^{3k} \left(\frac{1}{2}\right)_{3k} (2x)^{-3k}$

10.4.81

$\phi(x) \sim \frac{3}{4}\pi - \frac{2}{3}x^{3/2} \left[1 + \frac{7}{4}(2x)^{-3} - \frac{1463}{96}(2x)^{-6} + \frac{495271}{640}(2x)^{-9} - \frac{206530429}{2048}(2x)^{-12} + \dots \right]$

Asymptotic Forms of $\int_0^x Ai(\pm t) dt$, $\int_0^x Bi(\pm t) dt$ for Large x

10.4.82 $\int_0^x Ai(t) dt \sim \frac{1}{3} - \frac{1}{2}\pi^{-1/2} x^{-3/4} \exp\left(-\frac{2}{3}x^{3/2}\right)$

10.4.83

$\int_0^x Ai(-t) dt \sim \frac{2}{3} - \pi^{-1/2} x^{-3/4} \cos\left(\frac{2}{3}x^{3/2} + \frac{\pi}{4}\right)$

*See page II.

$$10.4.84 \quad \int_0^x \text{Bi}(t) dt \sim \pi^{-1/2} x^{-3/4} \exp\left(\frac{2}{3} x^{3/2}\right)$$

$$10.4.85 \quad \int_0^x \text{Bi}(-t) dt \sim \pi^{-1/2} x^{-3/4} \sin\left(\frac{2}{3} x^{3/2} + \frac{\pi}{4}\right)$$

Asymptotic Forms of $\text{Gi}(\pm x)$, $\text{Gi}'(\pm x)$, $\text{Hi}(\pm x)$, $\text{Hi}'(\pm x)$
for Large x

$$10.4.86 \quad \text{Gi}(x) \sim \pi^{-1} x^{-1}$$

$$10.4.87 \quad \text{Gi}(-x) \sim \pi^{-1/2} x^{-1/4} \cos\left(\frac{2}{3} x^{3/2} + \frac{\pi}{4}\right)$$

$$10.4.88 \quad \text{Gi}'(x) \sim \frac{7}{96} \pi^{-1} x^{-2}$$

$$10.4.89 \quad \text{Gi}'(-x) \sim \pi^{-1/2} x^{1/4} \sin\left(\frac{2}{3} x^{3/2} + \frac{\pi}{4}\right)$$

$$10.4.90 \quad \text{Hi}(x) \sim \pi^{-1/2} x^{-1/4} \exp\left(\frac{2}{3} x^{3/2}\right)$$

$$10.4.91 \quad \text{Hi}(-x) \sim \pi^{-1} x^{-1}$$

$$10.4.92 \quad \text{Hi}'(x) \sim \pi^{-1/2} x^{1/4} \exp\left(\frac{2}{3} x^{3/2}\right)$$

$$10.4.93 \quad \text{Hi}'(-x) \sim -\frac{3}{2} \pi^{-1} x^{-2}$$

Zeros and Their Asymptotic Expansions

$\text{Ai}(z)$, $\text{Ai}'(z)$ have zeros on the negative real axis only. $\text{Bi}(z)$, $\text{Bi}'(z)$ have zeros on the negative real axis and in the sector $\frac{1}{2}\pi < |\arg z| < \frac{3}{2}\pi$. $a_s, a'_s; b_s, b'_s$ s -th (real) negative zero of $\text{Ai}(z)$, $\text{Ai}'(z)$; $\text{Bi}(z)$, $\text{Bi}'(z)$, respectively. $\beta_s, \beta'_s; \bar{\beta}_s, \bar{\beta}'_s$ s -th complex zero of $\text{Bi}(z)$, $\text{Bi}'(z)$ in the sectors $\frac{1}{2}\pi < \arg z < \frac{3}{2}\pi$, $-\frac{1}{2}\pi < \arg z < -\frac{3}{2}\pi$, respectively.

$$10.4.94 \quad a_s = -f[3\pi(4s-1)/8]$$

$$10.4.95 \quad a'_s = -g[3\pi(4s-3)/8]$$

$$10.4.96 \quad \text{Ai}'(a_s) = (-1)^{s-1} f_1[3\pi(4s-1)/8]$$

$$10.4.97 \quad \text{Ai}(a'_s) = (-1)^{s-1} g_1[3\pi(4s-3)/8]$$

$$10.4.98 \quad b_s = -f[3\pi(4s-3)/8]$$

$$10.4.99 \quad b'_s = -g[3\pi(4s-1)/8]$$

$$10.4.100 \quad \text{Bi}'(b_s) = (-1)^{s-1} f_1[3\pi(4s-3)/8]$$

$$10.4.101 \quad \text{Bi}(b'_s) = (-1)^s g_1[3\pi(4s-1)/8]$$

$$10.4.102 \quad \beta_s = e^{\pi i/3} f \left[\frac{3\pi}{8} (4s-1) + \frac{3i}{4} \ln 2 \right]$$

$$10.4.103 \quad \beta'_s = e^{\pi i/3} g \left[\frac{3\pi}{8} (4s-3) + \frac{3i}{4} \ln 2 \right]$$

10.4.104

$$\text{Bi}'(\beta_s) = (-1)^s \sqrt{2} e^{-\pi i/6} f_1 \left[\frac{3\pi}{8} (4s-1) + \frac{3i}{4} \ln 2 \right]$$

10.4.105

$$\text{Bi}(\beta'_s) = (-1)^{s-1} \sqrt{2} e^{\pi i/6} g_1 \left[\frac{3\pi}{8} (4s-3) + \frac{3i}{4} \ln 2 \right]$$

$|z|$ sufficiently large

$$f(z) \sim z^{2/3} \left(1 + \frac{5}{48} z^{-2} - \frac{5}{36} z^{-4} + \frac{77125}{82944} z^{-6} - \frac{108056875}{6967296} z^{-8} + \frac{162375596875}{334430208} z^{-10} - \dots \right)$$

$$g(z) \sim z^{2/3} \left(1 - \frac{7}{48} z^{-2} + \frac{35}{288} z^{-4} - \frac{181223}{207360} z^{-6} + \frac{18683371}{1244160} z^{-8} - \frac{91145884361}{191102976} z^{-10} + \dots \right)$$

$$f_1(z) \sim \pi^{-1/2} z^{1/6} \left(1 + \frac{5}{48} z^{-2} - \frac{1525}{4608} z^{-4} + \frac{2397875}{663552} z^{-6} - \dots \right)$$

$$g_1(z) \sim \pi^{-1/2} z^{-1/6} \left(1 - \frac{7}{96} z^{-2} + \frac{1673}{6144} z^{-4} - \frac{84394709}{26542080} z^{-6} + \dots \right) *$$

Formal and Asymptotic Solutions of Ordinary Differential Equations of Second Order With Turning Points

An equation

$$10.4.106 \quad W'' + a(z, \lambda)W' + b(z, \lambda)W = 0$$

in which λ is a real or complex parameter and, for fixed λ , $a(z, \lambda)$ is analytic in z and $b(z, \lambda)$ is continuous in z in some region of the z -plane, may be reduced by the transformation

$$10.4.107 \quad W(z) = w(z) \exp\left(-\frac{1}{2} \int^z a(t, \lambda) dt\right)$$

to the equation

10.4.108

$$w'' + \varphi(z, \lambda)w = 0$$

$$\varphi(z, \lambda) = b(z, \lambda) - \frac{1}{4} a^2(z, \lambda) - \frac{1}{2} \frac{d}{dz} a(z, \lambda).$$

*See page 11.

If $\varphi(z, \lambda)$ can be written in the form

10.4.109 $\varphi(z, \lambda) = \lambda^2 p(z) + q(z, \lambda)$

where $q(z, \lambda)$ is bounded in a region R of the z -plane, then the zeros of $p(z)$ in R are said to be turning points of the equation **10.4.108**.

The Special Case $w'' + [\lambda^2 z + q(z, \lambda)]w = 0$

Let $\lambda = |\lambda|e^{i\omega}$ vary over a sectorial domain S : $|\lambda| \geq \lambda_0 (> 0)$, $\omega_1 \leq \omega \leq \omega_2$, and suppose that $q(z, \lambda)$ is continuous in z for $|z| < r$ and λ in S , and $q(z, \lambda) \sim \sum_0^{\infty} q_n(z)\lambda^{-n}$ as $\lambda \rightarrow \infty$ in S .

Formal Series Solution

10.4.110

$$w(z) = u(z) \sum_0^{\infty} \varphi_n(z)\lambda^{-n} + \lambda^{-1} u'(z) \sum_0^{\infty} \psi_n(z)\lambda^{-n}$$

$$w'' + \lambda^2 z w = 0$$

$$\varphi_0(z) = c_0, \quad \psi_0(z) = z^{-1} c_1, \quad c_0, c_1 \text{ constants}$$

$$\varphi_{n+1}(z) = -\frac{1}{2} \psi_n'(z) - \frac{1}{2} \int_0^z \sum_0^n q_{n-k}(t) \psi_k(t) dt$$

$$\psi_n(z) = \frac{1}{2} z^{-1} \int_0^z t^{-1} \left[\varphi_n''(t) + \sum_0^n q_{n-k}(t) \varphi_k(t) \right] dt$$

($n=0, 1, 2, \dots$)

Uniform Asymptotic Expansions of Solutions

For z real, i.e. for the equation

10.4.111 $y'' + [\lambda^2 x + q(x, \lambda)]y = 0$

where x varies in a bounded interval $a \leq x \leq b$ that includes the origin and where, for each fixed λ in S , $q(x, \lambda)$ is continuous in x for $a \leq x \leq b$, the following asymptotic representations hold.

(i) If λ is real and positive, there are solutions $y_0(x), y_1(x)$ such that, uniformly in x on $a \leq x \leq 0$,

10.4.112

$$y_0(x) = \text{Ai}(-\lambda^{2/3}x)[1 + O(\lambda^{-1})] \quad (\lambda \rightarrow \infty)$$

$$y_1(x) = \text{Bi}(-\lambda^{2/3}x)[1 + O(\lambda^{-1})]$$

and, uniformly in x on $0 \leq x \leq b$

10.4.113

$$y_0(x) = \text{Ai}(-\lambda^{2/3}x)[1 + O(\lambda^{-1})] + \text{Bi}(-\lambda^{2/3}x)O(\lambda^{-1}),$$

$$y_1(x) = \text{Bi}(-\lambda^{2/3}x)[1 + O(\lambda^{-1})] + \text{Ai}(-\lambda^{2/3}x)O(\lambda^{-1})$$

($\lambda \rightarrow \infty$)

(ii) If $\mathcal{R}\lambda \geq 0$, $\mathcal{I}\lambda \neq 0$, there are solutions $y_0(x), y_1(x)$ such that, uniformly in x on $a \leq x \leq b$,

10.4.114

$$y_0(x) = \text{Ai}(-\lambda^{2/3}x)[1 + O(\lambda^{-1})]$$

$$y_1(x) = \text{Bi}(-\lambda^{2/3}x)[1 + O(\lambda^{-1})] \quad (|\lambda| \rightarrow \infty)$$

For further representations and details, we refer to [10.4].

When z is complex (bounded or unbounded), conditions under which the formal series **10.4.110** yields a uniform asymptotic expansion of a solution are given in [10.12] if $q(z, \lambda)$ is independent of λ and $|\lambda| \rightarrow \infty$ with fixed ω , and in [10.14] if λ lies in any region of the complex plane. Further references are [10.2; 10.9; 10.10].

The General Case $w'' + [\lambda^2 p(z) + q(z, \lambda)]w = 0$

Let $\lambda = |\lambda|e^{i\omega}$ where $|\lambda| \geq \lambda_0 (> 0)$ and $-\pi \leq \omega \leq \pi$; suppose that $p(z)$ is analytic in a region R and has a zero $z = z_0$ in R , and that, for fixed λ , $q(z, \lambda)$ is analytic in z for z in R . The transformation $\xi = \xi(z)$, $v = [p(z)/\xi]^{1/4} w(z)$, where ξ is defined as the (unique) solution of the equation

10.4.115 $\xi \left(\frac{d\xi}{dz} \right)^2 = p(z),$

yields the special case

10.4.116 $\frac{d^2 v}{d\xi^2} + [\lambda^2 \xi + f(\xi, \lambda)]v = 0, \quad *$

$$f(\xi, \lambda) = \left(\frac{d\xi}{dz} \right)^{-2} q(z, \lambda) - \left(\frac{d\xi}{dz} \right)^{-1} \frac{d^2}{d\xi^2} \left[\left(\frac{d\xi}{dz} \right)^{\frac{1}{2}} \right]$$

Example:

Consider the equation

10.4.117 $y'' + [\lambda^2 - (\lambda^2 - \frac{1}{4})x^{-2}]y = 0$

for which the points $x=0, \infty$ are singular points and $x=1$ is a turning point. It has the functions $x^{\frac{1}{2}}J_{\lambda}(\lambda x), x^{\frac{1}{2}}Y_{\lambda}(\lambda x)$ as particular solutions (see **9.1.49**).

The equation **10.4.115** becomes

$$\xi \left(\frac{d\xi}{dx} \right)^2 = \frac{x^2 - 1}{x^2}$$

whence

$$\frac{2}{3} (-\xi)^{3/2} = -\sqrt{1-x^2} + \ln x^{-1} (1 + \sqrt{1-x^2}) \quad (0 < x \leq 1)$$

$$\frac{2}{3} \xi^{3/2} = \sqrt{x^2 - 1} - \arccos x^{-1} \quad (1 \leq x < \infty).$$

Thus

10.4.118 $v(\xi) = \left(\frac{x^2 - 1}{x^2 \xi} \right)^{1/4} y(x)$

*See page II.

satisfies the equation

$$10.4.119 \quad \frac{d^2v}{d\xi^2} + \left[\lambda^2\xi - \frac{5}{16\xi^2} + \frac{\xi^2}{4} \frac{x^2(x^2+4)}{(x^2-1)^3} \right] v = 0$$

which is of the form 10.4.111 with x replaced by ξ and $q(\xi, \lambda)$ independent of λ .

Suppose $\Re\lambda \geq 0, \Im\lambda \neq 0$. By the first equation of 10.4.114 there is a solution $v_0(\xi)$ of 10.4.119, i.e., a solution $y_0(x)$ of 10.4.117 for which the representation

10.4.120

$$v_0(\xi) = \left(\frac{x^2-1}{x^2\xi} \right)^{1/4} y_0(x) = \text{Ai}(-\lambda^{2/3}\xi)[1 + O(\lambda^{-1})]$$

holds uniformly in x on $0 < x < \infty$ as $|\lambda| \rightarrow \infty$.

To identify $y_0(x)$ in terms of $x^{\frac{1}{2}}J_{\lambda}(\lambda x), x^{\frac{1}{2}}Y_{\lambda}(\lambda x)$, restrict x to $0 < x \leq b < 1$ so that by 10.4.118 ξ is negative, and replace the Airy function by its asymptotic representation 10.4.59. This yields

10.4.121

$$y_0(x) = \left(\frac{x^2-1}{x^2\xi} \right)^{-1/4} \frac{1}{2} \pi^{-1/2} \lambda^{-1/6} (-\xi)^{1/4} \exp\left(\frac{2}{3}\lambda(-\xi)^{3/2}\right) [1 + O(\lambda^{-1})]$$

$$= \frac{1}{2} \pi^{-1/2} \lambda^{-1/6} \left(\frac{1-x^2}{x^2} \right)^{-1/4} \exp\left(\frac{2}{3}\lambda(-\xi)^{3/2}\right) [1 + O(\lambda^{-1})]$$

Let now λ be fixed and $x \rightarrow 0$ in 10.4.121. There results

$$10.4.122 \quad y_0(x) \sim \frac{1}{2} \pi^{-1/2} \lambda^{-1/6} x^{1/2} \left(\frac{1}{2}x\right)^{\lambda} e^{\lambda}.$$

On the other hand, $y_0(x)$ is a solution of 10.4.117 and therefore it can be written in the form

$$10.4.123 \quad y_0(x) = x^{1/2} [c_1 J_{\lambda}(\lambda x) + c_2 Y_{\lambda}(\lambda x)]$$

where, from 9.1.7 for λ fixed and $x \rightarrow 0$

$$J_{\lambda}(\lambda x) \sim \frac{(\frac{1}{2}\lambda x)^{\lambda}}{\Gamma(\lambda+1)},$$

$$Y_{\lambda}(\lambda x) \sim \frac{(\frac{1}{2}\lambda x)^{\lambda}}{\Gamma(\lambda+1)} \cot \lambda\pi - \frac{(\frac{1}{2}\lambda x)^{-\lambda}}{\Gamma(1-\lambda)} \csc \lambda\pi.$$

Thus, letting $x \rightarrow 0$ in 10.4.123 and comparing the resulting relation with 10.4.122 one finds that $c_2 = 0$ and

$$10.4.124 \quad y_0(x) = \frac{1}{2} \pi^{-1/2} \lambda^{-\lambda-1/6} e^{\lambda} \Gamma(\lambda+1) x^{1/2} J_{\lambda}(\lambda x).$$

It follows from 10.4.120 that uniformly in x on $0 < x < \infty$

10.4.125

$$J_{\lambda}(\lambda x) = \frac{2\pi^{1/2}}{\Gamma(\lambda+1)} \lambda^{\lambda+1/6} e^{-\lambda} \left(\frac{x^2-1}{\xi} \right)^{-1/4} \text{Ai}(-\lambda^{2/3}\xi) [1 + O(\lambda^{-1})] \quad (|\lambda| \rightarrow \infty)$$

Numerical Methods

10.5. Use and Extension of the Tables

Spherical Bessel Functions

To compute $j_n(x), y_n(x), n=0, 1, 2$, for values of x outside the range of Table 10.1, use formulas 10.1.11, 10.1.12 and obtain values for the circular functions from Tables 4.6-4.8.

Example 1. Compute $j_1(x)$ for $x=11.425$.

From 10.1.11, $j_1(x) = \frac{\sin x}{x^2} - \frac{\cos x}{x}$. Hence, using Tables 4.6 and 4.8,

$$j_1(11.425) = -\frac{.90920\ 500}{(11.425)^2} - \frac{.41634\ 873}{11.425}$$

$$= -.00696\ 54535 - .03644\ 1902$$

$$= -.04340\ 7356.$$

To compute $j_n(x), 11 \leq n \leq 20$, for a value of x within the range of Table 10.3, obtain from Table 10.3, directly or possibly by linear interpolation, $j_{21}(x), j_{20}(x)$ and use these as starting values in the recurrence relation 10.1.19 for decreasing n .

An alternative procedure which often yields better accuracy and which also applies to computations of $j_n(x)$ when both n and x are outside the range of Table 10.1 is the following device essentially due to J. C. P. Miller [9.20].

At some value N larger than the desired value n , assume tentatively $F_{N+1}=0, F_N=1$ and use recurrence relation 10.1.19 for decreasing N to obtain the sequence F_{N-1}, \dots, F_0 . If N was chosen large enough, each term of this sequence up to F_n is proportional, to a certain number of significant figures, to the corresponding term in the sequence $j_{N-1}(x), \dots, j_0(x)$ of true values. The factor of proportionality, p , may be obtained by comparing, say, F_0 with the true value $j_0(x)$ computed separately. The terms in the sequence pF_0, \dots, pF_n are then accurate to the number of significant figures present in the tentative values. If the accuracy obtained is not sufficient, the process may be repeated by starting from a larger value N .

Example 2. Compute $j_{15}(x)$ for $x=24.6$.
Interpolation in **Table 10.3** yields for $x=24.6$

$$x^{-21}e^{x^2/86}j_{21}(x) = (-28)3.934616$$

$$x^{-20}e^{x^2/82}j_{20}(x) = (-27)9.48683$$

whence

$$j_{21}(24.6) = .05604\ 29, \quad j_{20}(24.6) = .03896\ 98.$$

From the recurrence relation **10.1.19** there results

$j_{19}(24.6) =$.00890 67660	[.00890 70]
$j_{18}(24.6) =$	-.02484 93173	[-.02485 90]
$j_{17}(24.6) =$	-.04628 17554	[-.04628 16]
$j_{16}(24.6) =$	-.04099 87086	[-.04099 88]
$j_{15}(24.6) =$	-.00871 65122	[-.00871 67]

For comparison, the correct values are shown in brackets.

To compute $j_{15}(x)$ for $x=24.6$ by Miller's device, take, for example, $N=39$ and assume $F_{40}=0, F_{39}=1$. Using **10.1.19** with decreasing N , i.e., $F_{N-1} = [(2N+1)/x]F_N - F_{N+1}$, $N=39, 38, \dots, 1, 0$, generate the sequence $F_{38}, F_{37}, \dots, F_1, F_0$, compute from **Table 4.6**, $j_0(24.6) = (\sin 24.6)/24.6 = -.02064\ 620296$, and obtain the factor of proportionality

$$p = j_0(24.6)/F_0 = .00000\ 03839\ 17642.$$

The value pF_{15} equals $j_{15}(24.6)$ to 8 decimals. The final part of the computations is shown in the following table, in which the correct values are given for comparison.

N	F_N	pF_N	$j_N(24.6)$
15	-22704. 71107	-. 00871 67391	-. 00871 674
14	+78178. 88236	+. 03001 42522	+. 03001 425
13	+114866. 80811	+. 04409 93941	+. 04409 939
12	+47894. 44353	+. 01838 75218	+. 01838 752
11	-66193. 59317	-. 02541 28882	-. 02541 289
10	-109782. 76234	-. 04214 75392	-. 04214 754
9	-27523. 39903	-. 01056 67185	-. 01056 672
8	+88524. 85252	+. 03398 62526	+. 03398 625
7	+88699. 11017	+. 03405 31532	+. 03405 315
6	-34440. 02929	-. 01322 21348	-. 01322 213
5	-106899. 12565	-. 04104 04602	-. 04104 046
4	-13360. 39272	-. 00512 92905	-. 00512 929
3	+102011. 17704	+. 03916 38905	+. 03916 389
2	+42387. 96341	+. 01627 34870	+. 01627 349
1	-93395. 73728	-. 03585 62712	-. 03585 627
0	-53777. 68747	-. 02064 62030	-. 02064 620

It may be observed that the normalization of the sequence F_N, F_{N-1}, \dots, F_0 can also be obtained from formula **10.1.50** by computing the sum $\sigma = \sum_0^N (2k+1)F_k^2$ and finding $p = 1/\sqrt{\sigma}$. This yields, in the case of the example, $p = 1/\sqrt{\sigma} = .00000\ 03839\ 177$.

Modified Spherical Bessel Functions

To compute $\sqrt{\frac{1}{2}\pi/x}I_{n+\frac{1}{2}}(x), \sqrt{\frac{1}{2}\pi/x}K_{n+\frac{1}{2}}(x), n=0, 1, 2, \dots$ for values of x outside the range of **Table 10.8**, use formulas **10.2.13, 10.2.14** together with **10.2.4** and obtain values for the hyperbolic and exponential functions from **Tables 4.4** and **4.15**. In those cases when $\sqrt{\frac{1}{2}\pi/x}I_{n+\frac{1}{2}}(x)$ and $\sqrt{\frac{1}{2}\pi/x}I_{-n-\frac{1}{2}}(x)$ are nearly equal, i.e., when x is sufficiently large, compute $\sqrt{\frac{1}{2}\pi/x}K_{n+\frac{1}{2}}(x)$ from formula **10.2.15**, for which the coefficients $(n+\frac{1}{2}, k)$ are given in **10.1.9**.

Example 3. Compute $\sqrt{\frac{1}{2}\pi/x}I_{5/2}(x), \sqrt{\frac{1}{2}\pi/x}K_{5/2}(x)$ for $x=16.2$.

From **10.2.13**, $\sqrt{\frac{1}{2}\pi/x}I_{5/2}(x) = (3+x^2) \sinh x/x^3 - 3 \cosh x/x^2$; from **Table 4.4**, $\cosh 16.2 = (6)5.4267\ 59950$ and this equals the value of $\sinh 16.2$ to the same number of significant figures. Hence

$$\begin{aligned} \sqrt{\frac{1}{2}\pi/16.2}I_{5/2}(16.2) &= (.06243\ 402371 \\ &\quad - .01143\ 118427)[(6)5.4267\ 59950] \\ &= 338814.4594 - 62034.29298 \\ &= 276780.1664. \end{aligned}$$

To compute $\sqrt{\frac{1}{2}\pi/16.2}K_{5/2}(16.2)$ use **10.2.17** and obtain

$$\begin{aligned} \sqrt{\frac{1}{2}\pi/16.2}K_{5/2}(16.2) &= \pi e^{-16.2} \left[\frac{1}{32.4} + \frac{6}{(32.4)^2} + \frac{12}{(32.4)^3} \right] \\ &= (-7)2.8945\ 38069[.036932\ 60400] \\ &= (-8)1.0690\ 28283. \end{aligned}$$

To compute $\sqrt{\frac{1}{2}\pi/x}I_{n+\frac{1}{2}}(x), 3 \leq n \leq 8$, for a value of x within the range of **Table 10.9**, obtain from **Table 10.9**, $\sqrt{\frac{1}{2}\pi/x}I_{19/2}(x), \sqrt{\frac{1}{2}\pi/x}I_{21/2}(x)$ for the desired value of x and use these as starting values in the recurrence relation **10.2.18** for decreasing n .

To compute $\sqrt{\frac{1}{2}\pi/x}K_{n+\frac{1}{2}}(x)$ for some integer n outside the range of **Table 10.9**, obtain from **10.2.15** or from **Table 10.8**, $\sqrt{\frac{1}{2}\pi/x}K_{\frac{1}{2}}(x), \sqrt{\frac{1}{2}\pi/x}K_{3/2}(x)$ for the desired value of x and use these as starting values in the recurrence relation **10.2.18** for increasing n . If x lies within the range of **Table 10.9** and $n > 10$, the recurrence may be started with $\sqrt{\frac{1}{2}\pi/x}K_{19/2}(x), \sqrt{\frac{1}{2}\pi/x}K_{21/2}(x)$ obtained from **Table 10.9**.

Example 4. Compute $\sqrt{\frac{1}{2}\pi/x}K_{11/2}(x)$ for $x=3.6$.
Obtain from **Table 10.8** for $x=3.6$

$$\sqrt{\frac{1}{2}\pi/x}K_{1/2}(x) = .01192\ 222$$

$$\sqrt{\frac{1}{2}\pi/x}K_{3/2}(x) = .01523\ 3952$$

The recurrence relation 10.2.18 yields successively

$$\begin{aligned}
 -\sqrt{\frac{1}{2}\pi/3.6}K_{5/2}(3.6) &= -.01192\ 222 \\
 &\quad -\frac{3}{3.6} (.01523\ 3952) \\
 &= -.02461\ 718 \\
 \sqrt{\frac{1}{2}\pi/3.6}K_{7/2}(3.6) &= .01523\ 3952 \\
 &\quad +\frac{5}{3.6} (.02461\ 718) \\
 &= .04942\ 4480 \\
 -\sqrt{\frac{1}{2}\pi/3.6}K_{9/2}(3.6) &= -.02461\ 718 \\
 &\quad -\frac{7}{3.6} (.04942\ 4480) \\
 &= -.12072\ 034 \\
 \sqrt{\frac{1}{2}\pi/3.6}K_{11/2}(3.6) &= .04942\ 4480 \\
 &\quad +\frac{9}{3.6} (.12072\ 034) \\
 &= .35122\ 533.
 \end{aligned}$$

As a check, the recurrence can be carried out until $n=9$ and the value of $\sqrt{\frac{1}{2}\pi/3.6}K_{19/2}(3.6)$ so obtained can be compared with the corresponding value from Table 10.9.

To compute $\sqrt{\frac{1}{2}\pi/x}I_{n+1/2}(x)$ when both n and x are outside the range of Table 10.9, use the device described in [9.20].

Airy Functions

To compute $Ai(x)$, $Bi(x)$ for values of x beyond 1, use auxiliary functions from Table 10.11.

Example 5. Compute $Ai(x)$ for $x=4.5$.

First, for $x=4.5$,

$$\xi = \frac{2}{3}x^{3/2} = 6.36396\ 1029, \quad \xi^{-1} = .15713\ 48403.$$

Hence, from Table 10.11, $f(-\xi) = .55848\ 24$ and thus

$$\begin{aligned}
 Ai(4.5) &= \frac{1}{2}(4.5)^{-1/4}(.55848\ 24) \exp(-6.36396\ 1029) \\
 &= \frac{1}{2}(.68658\ 905)(.55848\ 24)(.00172\ 25302) \\
 &= .00033\ 02503.
 \end{aligned}$$

To compute the zeros c, c' of a solution $y(x)$ of the equation $y'' - xy = 0$ and of its derivative

$y'(x)$, respectively, the following formulas may be used, in which d, d' denote approximations to c, c' and $u = y(d)/y'(d), v = y'(d')/d'^2y(d')$.

$$\begin{aligned}
 c &= d - u - 2d \frac{u^3}{3!} + 2 \frac{u^4}{4!} - 24d^2 \frac{u^5}{5!} \\
 &\quad + 88d \frac{u^6}{6!} - (88 + 720d^3) \frac{u^7}{7!} \\
 &\quad + 5856d^2 \frac{u^8}{8!} - (16640d + 40320d^4) \frac{u^9}{9!} + \dots \\
 c' &= d' \left\{ 1 - v - \frac{v^2}{2!} - (3 + 2d'^3) \frac{v^3}{3!} - (15 + 10d'^3) \frac{v^4}{4!} \right. \\
 &\quad - (105 + 76d'^3 + 24d'^6) \frac{v^5}{5!} \\
 &\quad \left. - (945 + 756d'^3 + 272d'^6) \frac{v^6}{6!} - \dots \right\} \\
 y'(c) &= y'(d) \left\{ 1 - d \frac{u^2}{2!} + \frac{u^3}{3!} - 3d^2 \frac{u^4}{4!} + 14d \frac{u^5}{5!} \right. \\
 &\quad - (14 + 45d^3) \frac{u^6}{6!} + 471d^2 \frac{u^7}{7!} \\
 &\quad \left. - (1432d + 1575d^4) \frac{u^8}{8!} + \dots \right\} \\
 y(c') &= y(d') \left\{ 1 - d'^2 \frac{v^2}{2!} - d'^3 \frac{v^3}{3!} - (3d'^3 + 3d'^6) \frac{v^4}{4!} \right. \\
 &\quad - (15d'^3 + 14d'^6) \frac{v^5}{5!} \\
 &\quad \left. - (105d'^3 + 101d'^6 + 45d'^4) \frac{v^6}{6!} - \dots \right\}
 \end{aligned}$$

Example 6. Compute the zero of $y(x) = Ai(x) - Bi(x)$ near $d = -.4$.
From Table 10.11,

$$y(-.4) = .02420\ 467, \quad y'(-.4) = -.71276\ 627$$

whence $u = y(-.4)/y'(-.4) = -.03395\ 8776$. From the above formulas

$$\begin{aligned}
 c &= -.4 + .03395\ 8776 - .00000\ 5221 \\
 &\quad + .00000\ 0111 + .00000\ 0001 \\
 &= -.36604\ 6333. \\
 y'(c) &= (-.71276\ 627) \{ 1 + .00023\ 0640 \\
 &\quad - .00000\ 6527 - .00000\ 0027 + .00000\ 0002 \} \\
 &= (-.71276\ 627)(1.00022\ 4088) \\
 &= -.71292\ 599.
 \end{aligned}$$

References

Texts

- [10.1] H. Bateman and R. C. Archibald, A guide to tables of Bessel functions, *Math. Tables Aids Comp.* **1**, 205-308 (1944), in particular, pp. 229-240.
- [10.2] T. M. Cherry, Uniform asymptotic formulae for functions with transition points, *Trans. Amer. Math. Soc.* **68**, 224-257 (1950).
- [10.3] A. Erdélyi et al., Higher transcendental functions, vol. 1, 2 (McGraw-Hill Book Co., Inc., New York, N.Y., 1953).
- [10.4] A. Erdélyi, Asymptotic expansions, California Institute of Technology, Dept. of Math., Technical Report No. 3, Pasadena, Calif. (1955).
- [10.5] A. Erdélyi, Asymptotic solutions of differential equations with transition points or singularities, *J. Mathematical Physics* **1**, 16-26 (1960).
- [10.6] H. Jeffreys, On certain approximate solutions of linear differential equations of the second order, *Proc. London Math. Soc.* **23**, 428-436 (1925).
- [10.7] H. Jeffreys, The effect on Love waves of heterogeneity in the lower layer, *Monthly Nat. Roy. Astr. Soc., Geophys. Suppl.* **2**, 101-111 (1928).
- [10.8] H. Jeffreys, On the use of asymptotic approximations of Green's type when the coefficient has zeros, *Proc. Cambridge Philos. Soc.* **52**, 61-66 (1956).
- [10.9] R. E. Langer, On the asymptotic solutions of differential equations with an application to the Bessel functions of large complex order, *Trans. Amer. Math. Soc.* **34**, 447-480 (1932).
- [10.10] R. E. Langer, The asymptotic solutions of ordinary linear differential equations of the second order, with special reference to a turning point, *Trans. Amer. Math. Soc.* **67**, 461-490 (1949).
- [10.11] W. Magnus and F. Oberhettinger, Formeln und Sätze für die speziellen Funktionen der mathematischen Physik, 2d ed. (Springer-Verlag, Berlin, Germany, 1948).
- [10.12] F. W. J. Olver, The asymptotic solution of linear differential equations of the second order for large values of a parameter, *Philos. Trans. Roy. Soc. London [A]* **247**, 307-327 (1954-55).
- [10.13] F. W. J. Olver, The asymptotic expansion of Bessel functions of large order, *Philos. Trans. Roy. Soc. London [A]* **247**, 328-368 (1954).
- [10.14] F. W. J. Olver, Uniform asymptotic expansions of solutions of linear second-order differential equations for large values of a parameter, *Philos. Trans. Roy. Soc. London [A]* **250**, 479-517 (1958).
- [10.15] W. R. Wasow, Turning point problems for systems of linear differential equations. Part I: The formal theory; Part II: The analytic theory. *Comm. Pure Appl. Math.* **14**, 657-673 (1961); **15**, 173-187 (1962).
- [10.16] G. N. Watson, A treatise on the theory of Bessel functions, 2d ed. (Cambridge Univ. Press, Cambridge, England, 1958).

Tables

- [10.17] H. K. Crowder and G. C. Francis, Tables of spherical Bessel functions and ordinary Bessel functions of order half and odd integer of the first and second kind, Ballistic Research Laboratory Memorandum Report No. 1027, Aberdeen Proving Ground, Md. (1956).
- [10.18] A. T. Doodson, Bessel functions of half integral order [Riccati-Bessel functions], *British Assoc. Adv. Sci. Report*, 87-102 (1914).
- [10.19] A. T. Doodson, Riccati-Bessel functions, *British Assoc. Adv. Sci. Report*, 97-107 (1916).
- [10.20] A. T. Doodson, Riccati-Bessel functions, *British Assoc. Adv. Sci. Report*, 263-270 (1922).
- [10.21] Harvard University, Tables of the modified Hankel functions of order one-third and of their derivatives (Harvard Univ. Press, Cambridge, Mass., 1945).
- [10.22] E. Jahnke and F. Emde, Tables of functions, 4th ed. (Dover Publications, Inc., New York, N.Y., 1945).
- [10.23] C. W. Jones, A short table for the Bessel functions $I_{n+\frac{1}{2}}(x)$, $(2/\pi)K_{n+\frac{1}{2}}(x)$ (Cambridge Univ. Press, Cambridge, England, 1952).
- [10.24] J. C. P. Miller, The Airy integral, *British Assoc. Adv. Sci. Mathematical Tables, Part-vol. B* (Cambridge Univ. Press, Cambridge, England, 1946).
- [10.25] National Bureau of Standards, Tables of spherical Bessel functions, vols. I, II (Columbia Univ. Press, New York, N.Y., 1947).
- [10.26] National Bureau of Standards, Tables of Bessel functions of fractional order, vols. I, II (Columbia Univ. Press, New York, N.Y., 1948-49).
- [10.27] National Bureau of Standards, Integrals of Airy functions, *Applied Math. Series 52* (U.S. Government Printing Office, Washington, D.C., 1958).
- [10.28] J. Proudman, A. T. Doodson and G. Kennedy, Numerical results of the theory of the diffraction of a plane electromagnetic wave by a conducting sphere, *Philos. Trans. Roy. Soc. London [A]* **217**, 279-314 (1916-18), in particular pp. 284-288.
- [10.29] M. Rothman, The problem of an infinite plate under an inclined loading, with tables of the integrals of $Ai(\pm x)$, $Bi(\pm x)$, *Quart. J. Mech. Appl. Math.* **7**, 1-7 (1954).
- [10.30] M. Rothman, Tables of the integrals and differential coefficients of $G_i(+x)$, $H_i(-x)$, *Quart. J. Mech. Appl. Math.* **7**, 379-384 (1954).
- [10.31] Royal Society Mathematical Tables, vol. 7, Bessel functions, Part III. Zeros and associated values (Cambridge Univ. Press, Cambridge, England, 1960).

[10.32] R. S. Scorer, Numerical evaluation of integrals of the form

$$I = \int_{x_1}^{x_2} f(x) e^{i\varphi(x)} dx$$

and the tabulation of the function

$$\text{Gi}(z) = (1/\pi) \int_0^{\infty} \sin(uz + 1/3u^3) du,$$

Quart. J. Mech. Appl. Math. 3, 107-112 (1950).

[10.33] A. D. Smirnov, Tables of Airy functions (and special confluent hypergeometric functions). Translated from the Russian by D. G. Fry (Pergamon Press, New York, N.Y., 1960).

[10.34] I. M. Vinogradov and N. G. Cetaev, Tables of Bessel functions of imaginary argument (Izdat. Akad. Nauk SSSR., Moscow, U.S.S.R., 1950).

[10.35] P. M. Woodward, A. M. Woodward, R. Hensman, H. H. Davies and N. Gamble, Four-figure tables of the Airy functions in the complex plane, Phil. Mag. (7) 37, 236-261 (1946).

SPHERICAL BESSEL FUNCTIONS—ORDERS 0, 1 AND 2

Table 10.1

x	$j_0(x)$	$j_1(x)$	$j_2(x)$	$y_0(x)$	$y_1(x)$	$y_2(x)$
0.0	1.00000 000	0.00000 0000	0.00000 000000	$-\infty$	$-\infty$	$-\infty$
0.1	0.99833 417	0.03330 0012	0.00066 619061	-9.95004 17	-100.49875	-3005.0125
0.2	0.99334 665	0.06640 0381	0.00265 90561	-4.90033 29	-25.495011	-377.52483
0.3	0.98506 736	0.09910 2888	0.00596 15249	-3.18445 50	-11.599917	-112.81472
0.4	0.97354 586	0.13121 215	0.01054 5302	-2.30265 25	-6.73017 71	-48.173676
0.5	0.95885 108	0.16253 703	0.01637 1107	-1.75516 51	-4.46918 13	-25.059923
0.6	0.94107 079	0.19289 196	0.02338 8995	-1.37555 94	-3.23366 97	-14.792789
0.7	0.92031 098	0.22209 828	0.03153 8780	-1.09263 17	-2.48121 34	-9.54114 00
0.8	0.89669 511	0.24998 551	0.04075 0531	-0.87088 339	-1.98529 93	-6.57398 92
0.9	0.87036 323	0.27639 252	0.05094 5155	-0.69067 774	-1.63778 29	-4.76859 87
1.0	0.84147 098	0.30116 868	0.06203 5052	-0.54030 231	-1.38177 33	-3.60501 76
1.1	0.81018 851	0.32417 490	0.07392 4849	-0.41236 011	-1.18506 13	-2.81962 54
1.2	0.77669 924	0.34528 457	0.08651 2186	-0.30196 480	-1.02833 66	-2.26887 66
1.3	0.74119 860	0.36438 444	0.09968 8571	-0.20576 833	-0.89948 193	-1.86995 92
1.4	0.70389 266	0.38137 537	0.11334 028	-0.12140 510	-0.79061 059	-1.57276 05
1.5	0.66499 666	0.39617 297	0.12734 928	-0.04715 8134	-0.69643 541	-1.34571 27
1.6	0.62473 350	0.40870 814	0.14159 426	+0.01824 9701	-0.61332 744	-1.16823 87
1.7	0.58333 224	0.41892 749	0.15595 157	0.07579 0879	-0.53874 937	-1.02652 51
1.8	0.54102 646	0.42679 364	0.17029 628	0.12622 339	-0.47090 236	-0.91106 065
1.9	0.49805 268	0.43228 539	0.18450 320	0.17015 240	-0.40849 878	-0.81515 048
2.0	0.45464 871	0.43539 778	0.19844 795	0.20807 342	-0.35061 200	-0.73399 142
2.1	0.41105 208	0.43614 199	0.21200 791	0.24040 291	-0.29657 450	-0.66408 077
2.2	0.36749 837	0.43454 522	0.22506 330	0.26750 051	-0.24590 723	-0.60282 854
2.3	0.32421 966	0.43065 030	0.23749 812	0.28968 523	-0.19826 956	-0.54829 769
2.4	0.28144 299	0.42451 529	0.24920 113	0.30724 738	-0.15342 325	-0.49902 644
2.5	0.23938 886	0.41621 299	0.26006 673	0.32045 745	-0.11120 588	-0.45390 450
2.6	0.19826 976	0.40583 020	0.26999 585	0.32957 260	-0.07151 1067	-0.41208 537
2.7	0.15828 884	0.39346 703	0.27889 675	0.33484 153	-0.03427 3462	-0.37292 316
2.8	0.11963 863	0.37923 606	0.28668 572	0.33650 798	+0.00054 2796	-0.33592 641
2.9	0.08249 9769	0.36326 136	0.29328 784	0.33481 316	0.03295 3045	-0.30072 380
3.0	0.04704 0003	0.34567 750	0.29863 750	0.32999 750	0.06295 9164	-0.26703 834
3.1	+0.01341 3117	0.32662 847	0.30267 895	0.32230 166	0.09055 5161	-0.23466 763
3.2	-0.01824 1920	0.30626 652	0.30536 678	0.31196 712	0.11573 164	-0.20346 870
3.3	-0.04780 1726	0.28475 092	0.30666 620	0.29923 629	0.13847 939	-0.17334 594
3.4	-0.07515 9148	0.26224 678	0.30655 336	0.28435 241	0.15879 221	-0.14424 164
3.5	-0.10022 378	0.23892 369	0.30501 551	0.26755 905	0.17666 922	-0.11612 829
3.6	-0.12292 235	0.21495 446	0.30205 107	0.24909 956	0.19211 667	-0.08900 2337
3.7	-0.14319 896	0.19051 380	0.29766 961	0.22921 622	0.20514 929	-0.06287 8964
3.8	-0.16101 523	0.16577 697	0.29189 179	0.20814 940	0.21579 139	-0.03778 7773
3.9	-0.17635 030	0.14091 846	0.28474 912	0.18613 649	0.22407 760	-0.01376 9192
4.0	-0.18920 062	0.11611 075	0.27628 369	0.16341 091	0.23005 335	+0.00912 9107
4.1	-0.19957 978	0.09152 2967	0.26654 781	0.14020 096	0.23377 514	0.03085 4018
4.2	-0.20751 804	0.06731 9710	0.25560 355	0.11672 877	0.23531 060	0.05135 0236
4.3	-0.21306 185	0.04365 9843	0.24352 220	0.09320 9110	0.23473 838	0.07056 1855
4.4	-0.21627 320	+0.02069 5380	0.23038 368	0.06984 8380	0.23214 783	0.08843 4232
4.5	-0.21722 892	-0.00142 95812	0.21627 586	0.04684 3511	0.22763 858	0.10491 554
4.6	-0.21601 978	-0.02257 9838	0.20129 380	0.02438 0984	0.22132 000	0.11995 814
4.7	-0.21274 963	-0.04262 9993	0.18553 900	+0.00263 5886	0.21331 046	0.13351 972
4.8	-0.20753 429	-0.06146 5266	0.16911 850	-0.01822 8955	0.20373 659	0.14556 433
4.9	-0.20050 053	-0.07898 2225	0.15214 407	-0.03806 3749	0.19273 242	0.15606 319
5.0	-0.19178 485	-0.09508 9408	0.13473 121	-0.05673 2437	0.18043 837	0.16499 546

$$j_n(x) = \sqrt{\frac{1}{2}\pi/x} J_{n+\frac{1}{2}}(x)$$

$$y_n(x) = \sqrt{\frac{1}{2}\pi/x} Y_{n+\frac{1}{2}}(x) = (-1)^{n+1} \sqrt{\frac{1}{2}\pi/x} J_{-(n+\frac{1}{2})}(x)$$

Compiled from National Bureau of Standards, Tables of spherical Bessel functions, vols. I, II. Columbia Univ. Press, New York, N.Y., 1947 (with permission).

Table 10.1

SPHERICAL BESSEL FUNCTIONS—ORDERS 0, 1 AND 2

x	$j_0(x)$	$j_1(x)$	$j_2(x)$	$y_0(x)$	$y_1(x)$	$y_2(x)$
5.0	(-1) -1.9178	(-2) -9.5089	(-1) 1.3473	(-2) -5.6732	(-1) 1.8044	(-1) 1.6500
5.1	(-1) -1.8153	(-1) -1.0971	(-1) 1.1700	(-2) -7.4113	(-1) 1.6700	(-1) 1.7235
5.2	(-1) -1.6990	(-1) -1.2277	(-2) 9.9065	(-2) -9.0099	(-1) 1.5257	(-1) 1.7812
5.3	(-1) -1.5703	(-1) -1.3423	(-2) 8.1054	(-1) -1.0460	(-1) 1.3730	(-1) 1.8231
5.4	(-1) -1.4310	(-1) -1.4404	(-2) 6.3084	(-1) -1.1754	(-1) 1.2134	(-1) 1.8495
5.5	(-1) -1.2828	(-1) -1.5217	(-2) 4.5277	(-1) -1.2885	(-1) 1.0485	(-1) 1.8604
5.6	(-1) -1.1273	(-1) -1.5862	(-2) 2.7749	(-1) -1.3849	(-2) 8.7995	(-1) 1.8563
5.7	(-2) -9.6611	(-1) -1.6339	(-2) +1.0617	(-1) -1.4644	(-2) 7.0920	(-1) 1.8377
5.8	(-2) -8.0104	(-1) -1.6649	(-3) -6.0100	(-1) -1.5268	(-2) 5.3780	(-1) 1.8049
5.9	(-2) -6.3369	(-1) -1.6794	(-2) -2.2024	(-1) -1.5720	(-2) 3.6725	(-1) 1.7587
6.0	(-2) -4.6569	(-1) -1.6779	(-2) -3.7326	(-1) -1.6003	(-2) 1.9898	(-1) 1.6998
6.1	(-2) -2.9863	(-1) -1.6609	(-2) -5.1819	(-1) -1.6119	(-3) +3.4379	(-1) 1.6288
6.2	(-2) -1.3402	(-1) -1.6289	(-2) -6.5418	(-1) -1.6073	(-2) -1.2523	(-1) 1.5467
6.3	(-3) +2.6689	(-1) -1.5828	(-2) -7.8042	(-1) -1.5871	(-2) -2.7861	(-1) 1.4544
6.4	(-2) 1.8211	(-1) -1.5234	(-2) -8.9620	(-1) -1.5519	(-2) -4.2458	(-1) 1.3528
6.5	(-2) 3.3095	(-1) -1.4515	(-1) -1.0009	(-1) -1.5024	(-2) -5.6210	(-1) 1.2430
6.6	(-2) 4.7203	(-1) -1.3682	(-1) -1.0940	(-1) -1.4397	(-2) -6.9018	(-1) 1.1260
6.7	(-2) 6.0425	(-1) -1.2746	(-1) -1.1750	(-1) -1.3648	(-2) -8.0795	(-1) 1.0030
6.8	(-2) 7.2664	(-1) -1.1717	(-1) -1.2435	(-1) -1.2785	(-2) -9.1466	(-2) 8.7500
6.9	(-2) 8.3832	(-1) -1.0607	(-1) -1.2995	(-1) -1.1822	(-1) -1.0097	(-2) 7.4323
7.0	(-2) 9.3855	(-2) -9.4292	(-1) -1.3427	(-1) -1.0770	(-1) -1.0924	(-2) 6.0883
7.1	(-1) 1.0267	(-2) -8.1954	(-2) -1.3730	(-2) -9.6415	(-1) -1.1625	(-2) 4.7295
7.2	(-1) 1.1023	(-2) -6.9183	(-1) -1.3906	(-2) -8.4493	(-1) -1.2197	(-2) 3.3674
7.3	(-1) 1.1650	(-2) -5.6107	(-1) -1.3956	(-2) -7.2065	(-1) -1.2637	(-2) 2.0132
7.4	(-1) 1.2145	(-2) -4.2851	(-1) -1.3882	(-2) -5.9263	(-1) -1.2946	(-3) +6.7812
7.5	(-1) 1.2507	(-2) -2.9542	(-1) -1.3688	(-2) -4.6218	(-1) -1.3123	(-3) -6.2736
7.6	(-1) 1.2736	(-2) -1.6303	(-1) -1.3379	(-2) -3.3061	(-1) -1.3171	(-2) -1.8929
7.7	(-1) 1.2833	(-3) -3.2520	(-1) -1.2960	(-2) -1.9919	(-1) -1.3092	(-2) -3.1089
7.8	(-1) 1.2802	(-3) +9.4953	(-1) -1.2437	(-3) -6.9174	(-1) -1.2891	(-2) -4.2662
7.9	(-1) 1.2645	(-2) 2.1829	(-1) -1.1816	(-3) +5.8231	(-1) -1.2571	(-2) -5.3561
8.0	(-1) 1.2367	(-2) 3.3646	(-1) -1.1105	(-2) 1.8188	(-1) -1.2140	(-2) -6.3711
8.1	(-1) 1.1974	(-2) 4.4850	(-1) -1.0313	(-2) 3.0067	(-1) -1.1603	(-2) -7.3040
8.2	(-1) 1.1472	(-2) 5.5351	(-2) -9.4473	(-2) 4.1360	(-1) -1.0968	(-2) -8.1487
8.3	(-1) 1.0870	(-2) 6.5069	(-2) -8.5177	(-2) 5.1973	(-1) -1.0243	(-2) -8.8997
8.4	(-1) 1.0174	(-2) 7.3932	(-2) -7.5334	(-2) 6.1820	(-2) -9.4378	(-2) -9.5527
8.5	(-2) 9.3940	(-2) 8.1877	(-2) -6.5042	(-2) 7.0825	(-2) -8.5607	(-1) -1.0104
8.6	(-2) 8.5395	(-2) 8.8851	(-2) -5.4401	(-2) 7.8921	(-2) -7.6218	(-1) -1.0551
8.7	(-2) 7.6203	(-2) 9.4810	(-2) -4.3510	(-2) 8.6051	(-2) -6.6312	(-1) -1.0892
8.8	(-2) 6.6468	(-2) 9.9723	(-2) -3.2471	(-2) 9.2170	(-2) -5.5994	(-1) -1.1126
8.9	(-2) 5.6294	(-1) 1.0357	(-2) -2.1385	(-2) 9.7240	(-2) -4.5369	(-1) -1.1253
9.0	(-2) 4.5791	(-1) 1.0632	(-2) -1.0349	(-1) 1.0124	(-2) -3.4542	(-1) -1.1275
9.1	(-2) 3.5066	(-1) 1.0800	(-4) +5.3818	(-1) 1.0415	(-2) -2.3621	(-1) -1.1193
9.2	(-2) 2.4227	(-1) 1.0859	(-2) 1.1184	(-1) 1.0596	(-2) -1.2710	(-1) -1.1011
9.3	(-2) 1.3382	(-1) 1.0813	(-2) 2.1498	(-1) 1.0669	(-3) -1.9101	(-1) -1.0731
9.4	(-3) +2.6357	(-1) 1.0663	(-2) 3.1395	(-1) 1.0635	(-3) +8.6782	(-1) -1.0358
9.5	(-3) -7.9106	(-1) 1.0413	(-2) 4.0795	(-1) 1.0497	(-2) 1.8960	(-2) -9.8978
9.6	(-2) -1.8159	(-1) 1.0068	(-2) 4.9622	(-1) 1.0257	(-2) 2.8844	(-2) -9.3558
9.7	(-2) -2.8017	(-2) 9.6325	(-2) 5.7808	(-2) 9.9213	(-2) 3.8245	(-2) -8.7385
9.8	(-2) -3.7396	(-2) 9.1126	(-2) 6.5291	(-2) 9.4941	(-2) 4.7084	(-2) -8.0528
9.9	(-2) -4.6216	(-2) 8.5149	(-2) 7.2018	(-2) 8.9817	(-2) 5.5288	(-2) -7.3063
10.0	(-2) -5.4402	(-2) 7.8467	(-2) 7.7942	(-2) 8.3907	(-2) 6.2793	(-2) -6.5069

$$j_n(x) = \sqrt{\frac{1}{2}\pi/x} J_{n+\frac{1}{2}}(x)$$

$$y_n(x) = \sqrt{\frac{1}{2}\pi/x} Y_{n+\frac{1}{2}}(x) = (-1)^{n+1} \sqrt{\frac{1}{2}\pi/x} J_{-(n+\frac{1}{2})}(x)$$

SPHERICAL BESSEL FUNCTIONS—ORDERS 3-10

Table 10.2

x	$j_3(x)$	$j_4(x)$	$j_5(x)$	$j_6(x)$	$j_7(x)$	$j_8(x)$	$10^9 x^{-9} j_9(x)$	$10^{11} x^{-10} j_{10}(x)$
0.0	0.0000	0.0000	0.0000	0.0000	0.0000	0.0000	1.52734 93	7.27309 19
0.1	(-6) 9.5185	(-7) 1.0577	(-10) 9.6163	(-12) 7.3975	(-14) 4.9319	(-16) 2.9012	1.52698 56	7.27151 10
0.2	(-5) 7.6021	(-6) 1.6900	(-8) 3.0737	(-10) 4.7297	(-12) 6.3072	(-14) 7.4212	1.52589 53	7.26677 00
0.3	(-4) 2.5586	(-6) 8.5364	(-7) 2.3296	(-9) 5.3784	(-10) 1.0761	(-12) 1.8995	1.52407 96	7.25887 47
0.4	(-4) 6.0413	(-5) 2.6894	(-7) 9.7904	(-8) 3.0149	(-10) 8.0448	(-11) 1.8938	1.52154 09	7.24783 46
0.5	(-3) 1.1740	(-5) 6.5390	(-6) 2.9775	(-7) 1.1467	(-9) 3.8259	(-10) 1.1261	1.51828 26	7.23366 29
0.6	(-3) 2.0163	(-4) 1.3491	(-6) 7.3776	(-7) 3.4113	(-8) 1.3665	(-10) 4.8282	1.51430 88	7.21637 65
0.7	(-3) 3.1787	(-4) 2.4847	(-5) 1.5866	(-7) 8.5649	(-8) 4.0046	(-9) 1.6515	1.50962 48	7.19599 61
0.8	(-3) 4.7053	(-4) 2.0988	(-5) 3.0755	(-6) 1.8989	(-7) 1.0153	(-8) 4.7873	1.50423 66	7.17254 61
0.9	(-3) 6.6361	(-4) 6.6912	(-5) 5.5059	(-6) 3.8277	(-7) 2.3040	(-8) 1.2228	1.49815 12	7.14605 44
1.0	(-3) 9.0066	(-3) 1.0110	(-5) 9.2561	(-6) 7.1569	(-7) 4.7901	(-8) 2.8265	1.49137 65	7.11655 26
1.1	(-2) 1.1847	(-3) 1.4661	(-4) 1.4786	(-5) 1.2590	(-7) 9.2769	(-8) 6.0254	1.48392 11	7.08407 57
1.2	(-2) 1.5183	(-3) 2.0546	(-4) 2.2643	(-5) 2.1058	(-6) 1.6942	(-7) 1.2013	1.47579 48	7.04866 21
1.3	(-2) 1.9033	(-3) 2.7976	(-4) 3.3461	(-5) 3.3756	(-6) 2.9451	(-7) 2.2640	1.46700 80	7.01035 39
1.4	(-2) 2.3411	(-3) 3.7164	(-4) 4.7963	(-5) 5.2181	(-6) 4.9082	(-7) 4.0669	1.45757 18	6.96919 61
1.5	(-2) 2.8325	(-3) 4.8324	(-4) 6.6962	(-5) 7.8174	(-6) 7.8875	(-7) 7.0086	1.44749 84	6.92523 71
1.6	(-2) 3.3774	(-3) 6.1667	(-4) 9.1354	(-5) 1.1395	(-6) 1.2279	(-7) 1.1649	1.43680 05	6.87852 85
1.7	(-2) 3.9754	(-3) 7.7397	(-4) 1.2212	(-5) 1.6212	(-6) 1.8587	(-7) 1.8756	1.42549 17	6.82912 49
1.8	(-2) 4.6252	(-3) 9.5709	(-4) 1.6031	(-5) 2.2577	(-6) 2.7444	(-7) 2.9356	1.41358 63	6.77708 37
1.9	(-2) 5.3249	(-2) 1.1679	(-3) 2.0705	(-4) 3.0840	(-5) 3.9632	(-6) 4.4800	1.40109 93	6.72246 53
2.0	(-2) 6.0722	(-2) 1.4079	(-3) 2.6352	(-4) 4.1404	(-5) 5.6097	(-6) 6.6832	1.38804 63	6.66533 28
2.1	(-2) 6.8639	(-2) 1.6788	(-3) 3.3094	(-4) 5.4720	(-5) 7.7975	(-6) 9.7670	1.37444 35	6.60575 19
2.2	(-2) 7.6962	(-2) 1.9817	(-3) 4.1059	(-4) 7.1289	(-5) 1.0661	(-6) 1.4009	1.36030 78	6.54379 07
2.3	(-2) 8.5650	(-2) 2.3176	(-3) 5.0375	(-4) 9.1665	(-5) 1.4358	(-6) 1.9754	1.34565 67	6.47951 98
2.4	(-2) 9.4654	(-2) 2.6872	(-3) 6.1171	(-4) 1.1645	(-5) 1.9071	(-6) 2.7420	1.33050 81	6.41301 19
2.5	(-1) 1.0392	(-2) 3.0911	(-3) 7.3576	(-4) 1.4630	(-5) 2.5009	(-6) 3.7516	1.31488 05	6.34434 22
2.6	(-1) 1.1339	(-2) 3.5292	(-3) 8.7717	(-4) 1.8192	(-5) 3.2410	(-6) 5.0647	1.29879 28	6.27358 74
2.7	(-1) 1.2301	(-2) 4.0014	(-3) 1.0372	(-4) 2.2404	(-5) 4.1542	(-6) 6.7532	1.28226 44	6.20082 63
2.8	(-1) 1.3270	(-2) 4.5071	(-3) 1.2169	(-4) 2.7345	(-5) 5.2705	(-6) 8.9013	1.26531 50	6.12613 95
2.9	(-1) 1.4241	(-2) 5.0454	(-3) 1.4174	(-4) 3.3096	(-5) 6.6231	(-6) 1.1607	1.24796 48	6.04960 91
3.0	(-1) 1.5205	(-2) 5.6150	(-3) 1.6397	(-4) 3.9744	(-5) 8.2484	(-6) 1.4983	1.23023 41	5.97131 85
3.1	(-1) 1.6156	(-2) 6.2142	(-3) 1.8848	(-4) 4.7374	(-5) 1.0187	(-6) 1.9160	1.21214 38	5.89135 26
3.2	(-1) 1.7087	(-2) 6.8409	(-3) 2.1532	(-4) 5.6074	(-5) 1.2481	(-6) 2.4283	1.19371 48	5.80979 75
3.3	(-1) 1.7989	(-2) 7.4929	(-3) 2.4457	(-4) 6.5935	(-5) 1.5177	(-6) 3.0520	1.17496 82	5.72674 00
3.4	(-1) 1.8857	(-2) 8.1673	(-3) 2.7626	(-4) 7.7045	(-5) 1.8326	(-6) 3.8056	1.15592 54	5.64226 82
3.5	(-1) 1.9681	(-2) 8.8610	(-3) 3.1042	(-4) 8.9491	(-5) 2.1980	(-6) 4.7098	1.13660 79	5.55647 05
3.6	(-1) 2.0456	(-2) 9.5706	(-3) 3.4705	(-4) 1.0336	(-5) 2.6195	(-6) 5.7875	1.11703 73	5.46943 61
3.7	(-1) 2.1174	(-1) 1.0292	(-2) 3.8614	(-3) 1.1873	(-4) 3.1030	(-5) 7.0639	1.09723 52	5.38125 47
3.8	(-1) 2.1829	(-1) 1.1022	(-2) 4.2765	(-3) 1.3569	(-4) 3.6544	(-5) 8.5665	1.07722 33	5.29201 62
3.9	(-1) 2.2414	(-1) 1.1756	(-2) 4.7151	(-3) 1.5429	(-4) 4.2801	(-5) 1.0325	1.05702 31	5.20181 05
4.0	(-1) 2.2924	(-1) 1.2489	(-2) 5.1766	(-3) 1.7462	(-4) 4.9865	(-5) 1.2372	1.03665 63	5.11072 78
4.1	(-1) 2.3354	(-1) 1.3217	(-2) 5.6596	(-3) 1.9673	(-4) 5.7801	(-5) 1.4743	1.01614 44	5.01885 80
4.2	(-1) 2.3697	(-1) 1.3935	(-2) 6.1630	(-3) 2.2065	(-4) 6.6676	(-5) 1.7473	0.99550 88	4.92629 07
4.3	(-1) 2.3951	(-1) 1.4637	(-2) 6.6851	(-3) 2.4645	(-4) 7.6554	(-5) 2.0603	0.97477 06	4.83311 51
4.4	(-1) 2.4110	(-1) 1.5319	(-2) 7.2242	(-3) 2.7413	(-4) 8.7501	(-5) 2.4174	0.95395 10	4.73942 00
4.5	(-1) 2.4174	(-1) 1.5976	(-2) 7.7780	(-3) 3.0371	(-4) 9.9581	(-5) 2.8229	0.93307 06	4.64529 34
4.6	(-1) 2.4138	(-1) 1.6602	(-2) 8.3444	(-3) 3.3520	(-4) 1.1286	(-5) 3.2814	0.91215 01	4.55082 25
4.7	(-1) 2.4001	(-1) 1.7193	(-2) 8.9207	(-3) 3.6857	(-4) 1.2739	(-5) 3.7976	0.89120 97	4.45609 35
4.8	(-1) 2.3763	(-1) 1.7743	(-2) 9.5043	(-3) 4.0381	(-4) 1.4322	(-5) 4.3763	0.87026 94	4.36119 18
4.9	(-1) 2.3423	(-1) 1.8247	(-2) 1.0092	(-3) 4.4086	(-4) 1.6042	(-5) 5.0226	0.84934 88	4.26620 13
5.0	(-1) 2.2982	(-1) 1.8702	(-2) 1.0681	(-3) 4.7967	(-4) 1.7903	(-5) 5.7414	0.82846 70	4.17120 50

$$j_n(x) = \sqrt{\frac{1}{2\pi}} x J_{n+\frac{1}{2}}(x) \quad \left[\begin{matrix} (-5)9 \\ 4 \end{matrix} \right] \quad \left[\begin{matrix} (-4)4 \\ 4 \end{matrix} \right]$$

Compiled from National Bureau of Standards, Tables of spherical Bessel functions, vols. I, II. Columbia Univ. Press, New York, N.Y., 1947 (with permission).

Table 10.2

SPHERICAL BESSEL FUNCTIONS—ORDERS 3-10

x	$y_3(x)$	$y_4(x)$	$y_5(x)$	$y_6(x)$	$y_7(x)$	$y_8(x)$	$10^{-8}x^{10}y_9(x)$	$10^{-9}x^{11}y_{10}(x)$
0.0	$-\infty$	$-\infty$	$-\infty$	$-\infty$	$-\infty$	$-\infty$	$-\infty$	$-\infty$
0.1	(5) -1.5015	(7) -1.0507	(8) -9.4553	(11) -1.0400	(13) -1.3519	(15) -2.0277	-0.34459 42	-0.65472 90
0.2	(3) -9.4126	(5) -3.2906	(7) -1.4798	(8) -8.1359	(10) -5.2868	(12) -3.9643	-0.34469 56	-0.65490 14
0.3	(3) -1.8686	(4) -4.3489	(6) -1.3028	(7) -4.7726	(9) -2.0668	(11) -1.0329	-0.34499 99	-0.65541 86
0.4	(2) -5.9544	(4) -1.0372	(5) -2.3278	(6) -6.3910	(8) -2.0747	(9) -7.7739	-0.34550 77	-0.65628 18
							-0.34622 02	-0.65749 23
0.5	(2) -2.4613	(3) -3.4208	(4) -6.1328	(6) -1.3458	(7) -3.4929	(9) -1.0465	-0.34713 86	-0.65905 23
0.6	(2) -1.2004	(3) -1.3857	(4) -2.0665	(5) -3.7747	(6) -8.1579	(8) -2.0357	-0.34826 48	-0.66096 47
0.7	(1) -6.5670	(2) -6.4716	(3) -8.2549	(5) -1.2907	(6) -2.3888	(7) -5.1060	-0.34960 12	-0.66323 28
0.8	(1) -3.9102	(2) -3.3557	(3) -3.7361	(4) -5.1035	(5) -8.2559	(7) -1.5429	-0.35115 04	-0.66586 06
0.9	(1) -2.4854	(2) -1.8854	(3) -1.8606	(4) -2.2552	(5) -3.2389	(6) -5.3756	-0.35291 56	-0.66885 29
1.0	(1) -1.6643	(2) -1.1290	(2) -9.9944	(4) -1.0881	(5) -1.4045	(6) -2.0959	-0.35490 04	-0.67221 50
1.1	(1) -1.1631	(1) -7.1198	(2) -5.7090	(3) -5.6378	(4) -6.6058	(5) -8.9515	-0.35710 89	-0.67595 30
1.2	(0) -8.4253	(1) -4.6879	(2) -3.4317	(3) -3.0988	(4) -3.3227	(5) -4.1224	-0.35954 56	-0.68007 37
1.3	(0) -6.2927	(1) -3.2014	(2) -2.1534	(3) -1.7901	(4) -1.7686	(5) -2.0227	-0.36221 57	-0.68458 47
1.4	(0) -4.8264	(1) -2.2559	(2) -1.4020	(3) -1.0790	(3) -9.8790	(5) -1.0477	-0.36512 46	-0.68949 42
1.5	(0) -3.7893	(1) -1.6338	(1) -9.4236	(2) -6.7473	(3) -5.7534	(4) -5.6859	-0.36827 87	-0.69481 14
1.6	(0) -3.0374	(1) -1.2120	(1) -6.5140	(2) -4.3572	(3) -3.4751	(4) -3.2143	-0.37168 46	-0.70054 60
1.7	(0) -2.4804	(0) -9.1871	(1) -4.6157	(2) -2.8948	(3) -2.1675	(4) -1.8835	-0.37534 96	-0.70670 90
1.8	(0) -2.0598	(0) -7.0994	(1) -3.3437	(2) -1.9724	(3) -1.3911	(4) -1.1395	-0.37928 17	-0.71331 20
1.9	(0) -1.7366	(0) -5.5830	(1) -2.4709	(2) -1.3747	(2) -9.1587	(3) -7.0931	-0.38348 96	-0.72036 75
2.0	(0) -1.4844	(0) -4.4613	(1) -1.8591	(1) -9.7792	(2) -6.1705	(3) -4.5301	-0.38798 26	-0.72788 93
2.1	(0) -1.2846	(0) -3.6178	(1) -1.4220	(1) -7.0870	(2) -4.2450	(3) -2.9613	-0.39277 08	-0.73589 19
2.2	(0) -1.1242	(0) -2.9740	(1) -1.1042	(1) -5.2238	(2) -2.9764	(3) -1.9771	-0.39786 50	-0.74439 11
2.3	(-1) -9.9368	(0) -2.4760	(0) -8.6948	(1) -3.9108	(2) -2.1235	(3) -1.3458	-0.40327 71	-0.75340 38
2.4	(-1) -8.8622	(0) -2.0858	(0) -6.9354	(1) -2.9702	(2) -1.5395	(3) -9.3247	-0.40901 97	-0.76294 81
2.5	(-1) -7.9660	(0) -1.7766	(0) -5.5991	(1) -2.2859	(2) -1.1327	(2) -6.5676	-0.41510 62	-0.77304 34
2.6	(-1) -7.2096	(0) -1.5290	(0) -4.5716	(1) -1.7812	(1) -8.4491	(2) -4.6963	-0.42155 14	-0.78371 06
2.7	(-1) -6.5632	(0) -1.3287	(0) -3.7725	(1) -1.4041	(1) -6.3832	(2) -3.4058	-0.42837 10	-0.79497 18
2.8	(-1) -6.0041	(0) -1.1651	(0) -3.1446	(1) -1.1189	(1) -4.8802	(2) -2.5025	-0.43558 18	-0.80685 08
2.9	(-1) -5.5144	(0) -1.0303	(0) -2.6462	(0) -9.0069	(1) -3.7729	(2) -1.8615	-0.44320 20	-0.81937 31
3.0	(-1) -5.0802	(-1) -9.1835	(0) -2.2470	(0) -7.3207	(1) -2.9476	(2) -1.4006	-0.45125 11	-0.83256 59
3.1	(-1) -4.6905	(-1) -8.2448	(0) -1.9246	(0) -6.0048	(1) -2.3257	(2) -1.0653	-0.45975 01	-0.84645 82
3.2	(-1) -4.3365	(-1) -7.4514	(0) -1.6621	(0) -4.9682	(1) -1.8521	(1) -8.1850	-0.46872 14	-0.86108 11
3.3	(-1) -4.0112	(-1) -6.7752	(0) -1.4467	(0) -4.1447	(1) -1.4881	(1) -6.3496	-0.47818 95	-0.87646 78
3.4	(-1) -3.7091	(-1) -6.1940	(0) -1.2687	(0) -3.4851	(1) -1.2057	(1) -4.9707	-0.48818 03	-0.89265 39
3.5	(-1) -3.4257	(-1) -5.6901	(0) -1.1206	(0) -2.9528	(0) -9.8471	(1) -3.9249	-0.49872 20	-0.90967 72
3.6	(-1) -3.1573	(-1) -5.2492	(-1) -9.9657	(0) -2.5201	(0) -8.1040	(1) -3.1246	-0.50984 49	-0.92757 84
3.7	(-1) -2.9012	(-1) -4.8600	(-1) -8.9204	(0) -2.1660	(0) -6.7182	(1) -2.5070	-0.52158 17	-0.94640 10
3.8	(-1) -2.6551	(-1) -4.5131	(-1) -8.0339	(0) -1.8743	(0) -5.6086	(1) -2.0265	-0.53396 75	-0.96619 15
3.9	(-1) -2.4173	(-1) -4.2011	(-1) -7.2774	(0) -1.6325	(0) -4.7139	(1) -1.6498	-0.54704 05	-0.98699 97
4.0	(-1) -2.1864	(-1) -3.9175	(-1) -6.6280	(0) -1.4310	(0) -3.9878	(1) -1.3523	-0.56084 19	-1.00887 91
4.1	(-1) -1.9615	(-1) -3.6574	(-1) -6.0670	(0) -1.2620	(0) -3.3947	(1) -1.1158	-0.57541 63	-1.03188 69
4.2	(-1) -1.7418	(-1) -3.4165	(-1) -5.5793	(0) -1.1196	(0) -2.9075	(0) -9.2642	-0.59081 20	-1.05608 44
4.3	(-1) -1.5269	(-1) -3.1913	(-1) -5.1525	(-1) -9.9895	(0) -2.5048	(0) -7.7389	-0.60708 14	-1.08153 78
4.4	(-1) -1.3165	(-1) -2.9788	(-1) -4.7765	(-1) -8.9625	(0) -2.1704	(0) -6.5027	-0.62428 15	-1.10831 79
4.5	(-1) -1.1107	(-1) -2.7768	(-1) -4.4430	(-1) -8.0839	(0) -1.8910	(0) -5.4951	-0.64247 43	-1.13650 10
4.6	(-2) -9.0931	(-1) -2.5833	(-1) -4.1450	(-1) -7.3286	(0) -1.6566	(0) -4.6692	-0.66172 73	-1.16616 90
4.7	(-2) -7.1268	(-1) -2.3966	(-1) -3.8766	(-1) -6.6763	(0) -1.4590	(0) -3.9887	-0.68211 42	-1.19741 05
4.8	(-2) -5.2107	(-1) -2.2155	(-1) -3.6331	(-1) -6.1102	(0) -1.2915	(0) -3.4251	-0.70371 55	-1.23032 08
4.9	(-2) -3.3484	(-1) -2.0390	(-1) -3.4102	(-1) -5.6166	(0) -1.1491	(0) -2.9560	-0.72661 94	-1.26500 29
5.0	(-2) -1.5443	(-1) -1.8662	(-1) -3.2047	(-1) -5.1841	(0) -1.0274	(0) -2.5638	-0.75092 23	-1.30156 80

$$y_n(x) = \sqrt{\frac{1}{2}\pi/x} Y_{n+\frac{1}{2}}(x) = (-1)^{n+1} \sqrt{\frac{1}{2}\pi/x} J_{-(n+\frac{1}{2})}(x)$$

$$\begin{bmatrix} (-4) \\ 5 \end{bmatrix} \quad \begin{bmatrix} (-4) \\ 5 \end{bmatrix}$$

SPHERICAL BESSEL FUNCTIONS—ORDERS 3-10

Table 10.2

x	$j_3(x)$	$j_4(x)$	$j_5(x)$	$j_6(x)$	$j_7(x)$	$j_8(x)$	$10^9 x^{-9} j_9(x)$	$10^{11} x^{-10} j_{10}(x)$
5.0	(-1) 2.2982	(-1) 1.8702	(-1) 1.0681	(-2) 4.7967	(-2) 1.7903	(-3) 5.7414	0.82846 70	4.17120 50
5.1	(-1) 2.2441	(-1) 1.9102	(-1) 1.1268	(-2) 5.2015	(-2) 1.9908	(-3) 6.5379	0.80764 29	4.07628 42
5.2	(-1) 2.1803	(-1) 1.9443	(-1) 1.1849	(-2) 5.6221	(-2) 2.2061	(-3) 7.4172	0.78689 50	3.98151 88
5.3	(-1) 2.1069	(-1) 1.9722	(-1) 1.2421	(-2) 6.0573	(-2) 2.4365	(-3) 8.3843	0.76624 10	3.88698 72
5.4	(-1) 2.0245	(-1) 1.9935	(-1) 1.2980	(-2) 6.5057	(-2) 2.6821	(-3) 9.4443	0.74569 86	3.79276 59
5.5	(-1) 1.9335	(-1) 2.0078	(-1) 1.3522	(-2) 6.9660	(-2) 2.9429	(-2) 1.0602	0.72528 47	3.69892 98
5.6	(-1) 1.8340	(-1) 2.0150	(-1) 1.4044	(-2) 7.4364	(-2) 3.2191	(-2) 1.1862	0.70501 58	3.60555 18
5.7	(-1) 1.7270	(-1) 2.0147	(-1) 1.4542	(-2) 7.9151	(-2) 3.5104	(-2) 1.3229	0.68490 78	3.51270 30
5.8	(-1) 1.6131	(-1) 2.0069	(-1) 1.5011	(-2) 8.4000	(-2) 3.8166	(-2) 1.4707	0.66497 60	3.42045 23
5.9	(-1) 1.4928	(-1) 1.9913	(-1) 1.5448	(-2) 8.8889	(-2) 4.1374	(-2) 1.6299	0.64523 54	3.32886 66
6.0	(-1) 1.3669	(-1) 1.9679	(-1) 1.5850	(-2) 9.3796	(-2) 4.4722	(-2) 1.8010	0.62570 01	3.23801 06
6.1	(-1) 1.2361	(-1) 1.9367	(-1) 1.6213	(-2) 9.8696	(-2) 4.8205	(-2) 1.9842	0.60638 37	3.14794 66
6.2	(-1) 1.1014	(-1) 1.8977	(-1) 1.6533	(-2) 1.0356	(-2) 5.1815	(-2) 2.1797	0.58729 93	3.05873 50
6.3	(-2) 9.6346	(-1) 1.8509	(-1) 1.6807	(-1) 1.0837	(-2) 5.5543	(-2) 2.3877	0.56845 94	2.97043 34
6.4	(-2) 8.2324	(-1) 1.7966	(-1) 1.7033	(-1) 1.1309	(-2) 5.9379	(-2) 2.6084	0.54987 57	2.88309 73
6.5	(-2) 6.8161	(-1) 1.7349	(-1) 1.7206	(-1) 1.1769	(-2) 6.3311	(-2) 2.8417	0.53155 94	2.79677 98
6.6	(-2) 5.3947	(-1) 1.6661	(-1) 1.7325	(-1) 1.2214	(-2) 6.7327	(-2) 3.0876	0.51352 10	2.71153 12
6.7	(-2) 3.9773	(-1) 1.5905	(-1) 1.7388	(-1) 1.2642	(-2) 7.1412	(-2) 3.3461	0.49577 04	2.62739 98
6.8	(-2) 2.5729	(-1) 1.5084	(-1) 1.7391	(-1) 1.3049	(-2) 7.5551	(-2) 3.6168	0.47831 68	2.54443 09
6.9	(-2) +1.1905	(-1) 1.4203	(-1) 1.7335	(-1) 1.3432	(-2) 7.9728	(-2) 3.8996	0.46116 89	2.46266 76
7.0	(-3) -1.6120	(-1) 1.3265	(-1) 1.7217	(-1) 1.3789	(-2) 8.3923	(-2) 4.1940	0.44433 45	2.38215 03
7.1	(-2) -1.4736	(-1) 1.2277	(-1) 1.7036	(-1) 1.4117	(-2) 8.8118	(-2) 4.4994	0.42782 11	2.30291 70
7.2	(-2) -2.7385	(-1) 1.1243	(-1) 1.6793	(-1) 1.4412	(-2) 9.2292	(-2) 4.8154	0.41163 52	2.22500 27
7.3	(-2) -3.9479	(-1) 1.0170	(-1) 1.6486	(-1) 1.4672	(-2) 9.6425	(-2) 5.1412	0.39578 30	2.14844 05
7.4	(-2) -5.0945	(-2) 9.9628	(-1) 1.6117	(-1) 1.4895	(-1) 1.0049	(-2) 5.4759	0.38026 97	2.07326 03
7.5	(-2) -6.1713	(-2) 7.9285	(-1) 1.5685	(-1) 1.5077	(-1) 1.0448	(-2) 5.8188	0.36510 02	1.99948 99
7.6	(-2) -7.1719	(-2) 6.7736	(-1) 1.5193	(-1) 1.5217	(-1) 1.0835	(-2) 6.1686	0.35027 86	1.92715 45
7.7	(-2) -8.0904	(-2) 5.6051	(-1) 1.4642	(-1) 1.5312	(-1) 1.1209	(-2) 6.5244	0.33580 85	1.85627 66
7.8	(-2) -8.9217	(-2) 4.4300	(-1) 1.4033	(-1) 1.5360	(-1) 1.1568	(-2) 6.8849	0.32169 28	1.78687 63
7.9	(-2) -9.6613	(-2) 3.2552	(-1) 1.3370	(-1) 1.5361	(-1) 1.1908	(-2) 7.2486	0.30793 39	1.71897 14
8.0	(-1) -1.0305	(-2) 2.0880	(-1) 1.2654	(-1) 1.5312	(-1) 1.2227	(-2) 7.6143	0.29453 36	1.65257 72
8.1	(-1) -1.0851	(-3) +9.3549	(-1) 1.1890	(-1) 1.5212	(-1) 1.2524	(-2) 7.9804	0.28149 30	1.58770 64
8.2	(-1) -1.1296	(-3) -1.9533	(-1) 1.1081	(-1) 1.5060	(-1) 1.2795	(-2) 8.3451	0.26881 29	1.52436 97
8.3	(-1) -1.1638	(-2) -1.2975	(-1) 1.0231	(-1) 1.4857	(-1) 1.3039	(-2) 8.7069	0.25649 33	1.46257 53
8.4	(-1) -1.1877	(-2) -2.3644	(-2) 9.3440	(-1) 1.4601	(-1) 1.3252	(-2) 9.0640	0.24453 39	1.40232 92
8.5	(-1) -1.2014	(-2) -3.3894	(-2) 8.4249	(-1) 1.4292	(-1) 1.3434	(-2) 9.4145	0.23293 38	1.34363 53
8.6	(-1) -1.2048	(-2) -4.3664	(-2) 7.4784	(-1) 1.3932	(-1) 1.3581	(-2) 9.7564	0.22169 16	1.28649 51
8.7	(-1) -1.1982	(-2) -5.2894	(-2) 6.5099	(-1) 1.3520	(-1) 1.3693	(-1) 1.0088	0.21080 54	1.23090 84
8.8	(-1) -1.1817	(-2) -6.1529	(-2) 5.5245	(-1) 1.3059	(-1) 1.3767	(-1) 1.0407	0.20027 29	1.17687 25
8.9	(-1) -1.1558	(-2) -6.9520	(-2) 4.5278	(-1) 1.2548	(-1) 1.3801	(-1) 1.0712	0.19009 14	1.12438 32
9.0	(-1) -1.1207	(-2) -7.6819	(-2) 3.5255	(-1) 1.1991	(-1) 1.3795	(-1) 1.1000	0.18025 78	1.07343 42
9.1	(-1) -1.0770	(-2) -8.3387	(-2) 2.5233	(-1) 1.1389	(-1) 1.3746	(-1) 1.1270	0.17076 84	1.02401 72
9.2	(-1) -1.0252	(-2) -8.9186	(-2) 1.5269	(-1) 1.0744	(-1) 1.3655	(-1) 1.1520	0.16161 93	0.97612 24
9.3	(-2) -9.6572	(-2) -9.4187	(-3) +5.4232	(-1) 1.0060	(-1) 1.3520	(-1) 1.1747	0.15280 62	0.92973 83
9.4	(-2) -8.9931	(-2) -9.8365	(-3) -4.2485	(-2) 9.3394	(-1) 1.3341	(-1) 1.1949	0.14432 46	0.88485 16
9.5	(-2) -8.2662	(-1) -1.0170	(-2) -1.3689	(-2) 8.5853	(-1) 1.3117	(-1) 1.2126	0.13616 93	0.84144 75
9.6	(-2) -7.4836	(-1) -1.0419	(-2) -2.2842	(-2) 7.8016	(-1) 1.2849	(-1) 1.2275	0.12833 53	0.79950 99
9.7	(-2) -6.6527	(-1) -1.0582	(-2) -3.1654	(-2) 6.9921	(-1) 1.2536	(-1) 1.2394	0.12081 68	0.75902 10
9.8	(-2) -5.7814	(-1) -1.0659	(-2) -4.0072	(-2) 6.1608	(-1) 1.2180	(-1) 1.2482	0.11360 83	0.71996 20
9.9	(-2) -4.8776	(-1) -1.0651	(-2) -4.8048	(-2) 5.3120	(-1) 1.1780	(-1) 1.2537	0.10670 35	0.68231 26
10.0	(-2) -3.9496	(-1) -1.0559	(-2) -5.5535	(-2) 4.4501	(-1) 1.1339	(-1) 1.2558	0.10009 64	0.64605 15

$$j_n(x) = \sqrt{\frac{1}{2} \pi / x} J_{n+\frac{1}{2}}(x)$$

$$\begin{bmatrix} (-5) & 5 \\ & 4 \end{bmatrix}$$

$$\begin{bmatrix} (-4) & 2 \\ & 5 \end{bmatrix}$$

Table 10.2 SPHERICAL BESSEL FUNCTIONS—ORDERS 3-10

x	$y_3(x)$	$y_4(x)$	$y_5(x)$	$y_6(x)$	$y_7(x)$	$y_8(x)$	$10^{-8}x^{10}y_9(x)$	$10^{-9}x^{11}y_{10}(x)$
5.0	(-2) -1.5443	(-1) -1.8662	(-1) -3.2047	(-1) -5.1841	(0) -1.0274	(0) -2.5638	-0.75092 23	-1.30156 80
5.1	(-3) +1.9691	(-1) -1.6965	(-1) -3.0134	(-1) -4.8031	(-1) -9.2298	(0) -2.2343	-0.77673 01	-1.34013 68
5.2	(-2) 1.8700	(-1) -1.5295	(-1) -2.8341	(-1) -4.4658	(-1) -8.3305	(0) -1.9564	-0.80415 92	-1.38083 98
5.3	(-2) 3.4698	(-1) -1.3649	(-1) -2.6647	(-1) -4.1656	(-1) -7.5528	(0) -1.7210	-0.83333 74	-1.42381 86
5.4	(-2) 4.9908	(-1) -1.2025	(-1) -2.5033	(-1) -3.8967	(-1) -6.8777	(0) -1.5208	-0.86440 56	-1.46922 70
5.5	(-2) 6.4276	(-1) -1.0424	(-1) -2.3484	(-1) -3.6545	(-1) -6.2895	(0) -1.3499	-0.89751 90	-1.51723 25
5.6	(-2) 7.7750	(-2) -8.8447	(-1) -2.1990	(-1) -3.4349	(-1) -5.7750	(0) -1.2034	-0.93284 85	-1.56801 75
5.7	(-2) 9.0279	(-2) -7.2898	(-1) -2.0538	(-1) -3.2345	(-1) -5.3232	(0) -1.0774	-0.97058 31	-1.62178 08
5.8	(-1) 1.0182	(-2) -5.7610	(-1) -1.9121	(-1) -3.0503	(-1) -4.9248	(-1) -9.6863	-1.01093 09	-1.67873 97
5.9	(-1) 1.1232	(-2) -4.2612	(-1) -1.7732	(-1) -2.8799	(-1) -4.5723	(-1) -8.7446	-1.05412 18	-1.73913 16
6.0	(-1) 1.2175	(-2) -2.7936	(-1) -1.6365	(-1) -2.7210	(-1) -4.2589	(-1) -7.9262	-1.10040 93	-1.80321 67
6.1	(-1) 1.3007	(-2) -1.3619	(-1) -1.5017	(-1) -2.5717	(-1) -3.9791	(-1) -7.2128	-1.15007 32	-1.87128 02
6.2	(-1) 1.3726	(-4) +2.9727	(-1) -1.3683	(-1) -2.4306	(-1) -3.7281	(-1) -6.5889	-1.20342 16	-1.94363 49
6.3	(-1) 1.4329	(-2) 1.3770	(-1) -1.2362	(-1) -2.2961	(-1) -3.5018	(-1) -6.0416	-1.26079 38	-2.02062 45
6.4	(-1) 1.4815	(-2) 2.6754	(-1) -1.1052	(-1) -2.1672	(-1) -3.2969	(-1) -5.5598	-1.32256 26	-2.10262 69
6.5	(-1) 1.5183	(-2) 3.9204	(-2) -9.7544	(-1) -2.0428	(-1) -3.1101	(-1) -5.1344	-1.38913 71	-2.19005 78
6.6	(-1) 1.5432	(-2) 5.1073	(-2) -8.4678	(-1) -1.9220	(-1) -2.9390	(-1) -4.7576	-1.46096 57	-2.28337 46
6.7	(-1) 1.5564	(-2) 6.2315	(-2) -7.1937	(-1) -1.8042	(-1) -2.7933	(-1) -4.4227	-1.53853 78	-2.38308 14
6.8	(-1) 1.5580	(-2) 7.2886	(-2) -5.9337	(-1) -1.6887	(-1) -2.6351	(-1) -4.1239	-1.62238 69	-2.48973 26
6.9	(-1) 1.5482	(-2) 8.2743	(-2) -4.6896	(-1) -1.5751	(-1) -2.4985	(-1) -3.8565	-1.71309 24	-2.60393 95
7.0	(-1) 1.5273	(-2) 9.1846	(-2) -3.4641	(-1) -1.4628	(-1) -2.3703	(-1) -3.6163	-1.81128 11	-2.72637 44
7.1	(-1) 1.4956	(-1) 1.0016	(-2) -2.2599	(-1) -1.3517	(-1) -2.2489	(-1) -3.3996	-1.91762 85	-2.85777 73
7.2	(-1) 1.4535	(-1) 1.0764	(-2) -1.0801	(-1) -1.2414	(-1) -2.1334	(-1) -3.2032	-2.03285 95	-2.99896 17
7.3	(-1) 1.4016	(-1) 1.1427	(-4) +7.1768	(-1) -1.1319	(-1) -2.0228	(-1) -3.0246	-2.15774 75	-3.15082 08
7.4	(-1) 1.3404	(-1) 1.2001	(-2) 1.1922	(-1) -1.0229	(-1) -1.9162	(-1) -2.8613	-2.29311 31	-3.31433 45
7.5	(-1) 1.2705	(-1) 1.2485	(-2) 2.2774	(-2) -9.1449	(-1) -1.8129	(-1) -2.7112	-2.43982 13	-3.49057 53
7.6	(-1) 1.1925	(-1) 1.2877	(-2) 3.3235	(-2) -8.0665	(-1) -1.7122	(-1) -2.5726	-2.59877 67	-3.68071 56
7.7	(-1) 1.1073	(-1) 1.3176	(-2) 4.3267	(-2) -6.9945	(-1) -1.6136	(-1) -2.4439	-2.77091 77	-3.88603 37
7.8	(-1) 1.0156	(-1) 1.3380	(-2) 5.2830	(-2) -5.9299	(-1) -1.5166	(-1) -2.3236	-2.95720 73	-4.10791 96
7.9	(-2) 9.1812	(-1) 1.3491	(-2) 6.1887	(-2) -4.8741	(-1) -1.4209	(-1) -2.2106	-3.15862 24	-4.34788 05
8.0	(-2) 8.1577	(-1) 1.3509	(-2) 7.0400	(-2) -3.8290	(-1) -1.3262	(-1) -2.1038	-3.37613 93	-4.60754 55
8.1	(-2) 7.0941	(-1) 1.3435	(-2) 7.8334	(-2) -2.7968	(-1) -1.2322	(-1) -2.0022	-3.61071 67	-4.88866 85
8.2	(-2) 5.9992	(-1) 1.3270	(-2) 8.5654	(-2) -1.7798	(-1) -1.1387	(-1) -1.9050	-3.86327 49	-5.19312 95
8.3	(-2) 4.8821	(-1) 1.3017	(-2) 9.2329	(-3) -7.8077	(-1) -1.0456	(-1) -1.8115	-4.13466 98	-5.52293 51
8.4	(-2) 3.7517	(-1) 1.2679	(-2) 9.8330	(-3) +1.9747	(-2) -9.5274	(-1) -1.7211	-4.42566 38	-5.88021 45
8.5	(-2) 2.6172	(-1) 1.2259	(-1) 1.0363	(-2) 1.1519	(-2) -8.6015	(-1) -1.6331	-4.73689 09	-6.26721 41
8.6	(-2) 1.4876	(-1) 1.1762	(-1) 1.0821	(-2) 2.0793	(-2) -7.6780	(-1) -1.5471	-5.06881 69	-6.68628 70
8.7	(-3) +3.7160	(-1) 1.1191	(-1) 1.1205	(-2) 2.9765	(-2) -6.7573	(-1) -1.4627	-5.42169 35	-7.13987 95
8.8	(-3) -7.2210	(-1) 1.0551	(-1) 1.1513	(-2) 3.8403	(-2) -5.8403	(-1) -1.3795	-5.79550 68	-7.63051 13
8.9	(-2) -1.7852	(-2) 9.8492	(-1) 1.1745	(-2) 4.6672	(-2) -4.9278	(-1) -1.2973	-6.18991 88	-8.16074 96
9.0	(-2) -2.8097	(-2) 9.0898	(-1) 1.1899	(-2) 5.4540	(-2) -4.0214	(-1) -1.2156	-6.60420 33	-8.73317 65
9.1	(-2) -3.7880	(-2) 8.2794	(-1) 1.1976	(-2) 6.1976	(-2) -3.1227	(-1) -1.1345	-7.03717 50	-9.35034 96
9.2	(-2) -4.7130	(-2) 7.4246	(-1) 1.1976	(-2) 6.8948	(-2) -2.2335	(-1) -1.0536	-7.48710 95	-10.01475 2
9.3	(-2) -5.5782	(-2) 6.5321	(-1) 1.1900	(-2) 7.5427	(-2) -1.3560	(-2) -9.7298	-7.95166 19	-10.72873 2
9.4	(-2) -6.3774	(-2) 5.6089	(-1) 1.1748	(-2) 8.1384	(-3) -4.9250	(-2) -8.9243	-8.42777 38	-11.49443 4
9.5	(-2) -7.1053	(-2) 4.6623	(-1) 1.1522	(-2) 8.6793	(-3) +3.5462	(-2) -8.1193	-8.91157 56	-12.31371 5
9.6	(-2) -7.7572	(-2) 3.6995	(-1) 1.1225	(-2) 9.1630	(-2) 1.1827	(-2) -7.3150	-9.39828 63	-13.18805 0
9.7	(-2) -8.3288	(-2) 2.7280	(-1) 1.0860	(-2) 9.5874	(-2) 1.9892	(-2) -6.5114	-9.88210 58	-14.11841 9
9.8	(-2) -8.8169	(-2) 1.7550	(-1) 1.0429	(-2) 9.9507	(-2) 2.7712	(-2) -5.7090	-10.35610 3	-15.10518 2
9.9	(-2) -9.2189	(-3) +7.8793	(-2) 9.9352	(-1) 1.0251	(-2) 3.5259	(-2) -4.9088	-10.81210 4	-16.14793 9
10.0	(-2) -9.5327	(-3) -1.6599	(-2) 9.3834	(-1) 1.0488	(-2) 4.2506	(-2) -4.1117	-11.24057 9	-17.24536 7

$$y_n(x) = \sqrt{\frac{1}{2}\pi/x} Y_{n+\frac{1}{2}}(x) = (-1)^{n+1} \sqrt{\frac{1}{2}\pi/x} J_{-(n+\frac{1}{2})}(x) \quad \left[\begin{matrix} (-3)3 \\ 6 \end{matrix} \right] \quad \left[\begin{matrix} (-3)7 \\ 6 \end{matrix} \right]$$

SPHERICAL BESSEL FUNCTIONS—ORDERS 20 AND 21 Table 10.3

x	$10^{26} f_{20}(x)$	$10^{27} f_{21}(x)$	$10^{-24} g_{20}(x)$	$10^{-25} g_{21}(x)$
0.0	7.62597 90	1.77348 35	-0.31983 10	-1.31130 70
0.5	7.62705 91	1.77371 23	-0.31988 11	-1.31149 33
1.0	7.63028 29	1.77439 56	-0.32003 25	-1.31205 61
1.5	7.63560 15	1.77552 32	-0.32028 86	-1.31300 70
2.0	7.64293 25	1.77707 85	-0.32065 49	-1.31436 61
2.5	7.65215 99	1.77903 78	-0.32113 96	-1.31616 11
3.0	7.66313 22	1.78137 03	-0.32175 30	-1.31842 87
3.5	7.67566 19	1.78403 80	-0.32250 82	-1.32121 43
4.0	7.68952 28	1.78699 49	-0.32342 08	-1.32457 29
4.5	7.70444 90	1.79018 73	-0.32450 98	-1.32856 95
5.0	7.72013 23	1.79355 29	-0.32579 69	-1.33328 02
5.5	7.73621 95	1.79702 05	-0.32730 79	-1.33879 33
6.0	7.75231 00	1.80050 95	-0.32907 24	-1.34521 03
6.5	7.76795 28	1.80392 94	-0.33112 44	-1.35264 77
7.0	7.78264 38	1.80717 91	-0.33350 34	-1.36123 89
7.5	7.79582 23	1.81014 64	-0.33625 47	-1.37113 69
8.0	7.80686 80	1.81270 77	-0.33943 07	-1.38251 67
8.5	7.81509 84	1.81472 70	-0.34309 23	-1.39557 96
9.0	7.81976 53	1.81605 56	-0.34731 02	-1.41055 73
9.5	7.82005 32	1.81653 14	-0.35216 70	-1.42771 82
10.0	7.815076	1.815979	-0.35776 04	-1.447374
10.5	7.803876	1.814208	-0.36420 59	-1.469891
11.0	7.785428	1.811016	-0.37164 20	-1.495697
11.5	7.758627	1.806185	-0.38023 59	-1.525305
12.0	7.722309	1.799482	-0.39019 23	-1.559325
12.5	7.675238	1.790664	-0.40176 53	-1.598497
13.0	7.616116	1.779472	-0.41527 46	-1.643728
13.5	7.543601	1.765639	-0.43113 22	-1.696143
14.0	7.456316	1.748885	-0.44987 76	-1.757166
14.5	7.352841	1.728929	-0.47223 40	-1.828625
15.0	7.231764	1.705481	-0.49918 70	-1.912922
15.5	7.091689	1.678251	-0.53209 15	-2.013273
16.0	6.931265	1.646956	-0.57279 98	-2.134049
16.5	6.749220	1.611324	-0.62378 79	-2.281228
17.0	6.544411	1.571096	-0.68821 72	-2.462936
17.5	6.315851	1.526041	-0.76981 49	-2.689957
18.0	6.062784	1.475960	-0.87240 01	-2.975953
18.5	5.784739	1.420698	-0.99883 14	-3.336925
19.0	5.481584	1.360155	-1.149171	-3.789188
19.5	5.153621	1.294299	-1.317987	-4.344958
20.0	4.801647	1.223178	-1.490982	-5.004711
20.5	4.427041	1.146936	-1.641599	-5.745922
21.0	4.031843	1.065826	-1.728777	-6.508927
21.5	3.618830	0.98022 63	-1.697442	-7.182333
22.0	3.191590	0.89065 46	-1.483467	-7.592679
22.5	2.754567	0.79777 92	-1.024223	-7.504782
23.0	2.313103	0.70243 25	-0.274630	-6.640003
23.5	1.873442	0.60561 45	+0.773430	-4.717888
24.0	1.442686	0.50849 80	2.072631	-1.52185
24.5	1.028721	0.41242 27	3.508629	+3.01816
25.0	0.640055	0.31888 30	4.901591	+8.74251

$$\begin{bmatrix} (-3)3 \\ 6 \end{bmatrix} \quad \begin{bmatrix} (-4)7 \\ 5 \end{bmatrix}$$

$$j_n(x) = f_n x^n \exp(-x^2/4n+2) \quad y_n(x) = g_n x^{-(n+1)} \exp(x^2/4n+2)$$

Compiled from National Bureau of Standards, Tables of spherical Bessel functions, vols. I, II. Columbia Univ. Press, New York, N.Y., 1947(with permission).

Table 10.4

SPHERICAL BESSEL FUNCTIONS—MODULUS AND PHASE—ORDERS 9, 10, 20 AND 21

$j_n(x) = \sqrt{\frac{1}{2}\pi/x} M_{n+\frac{1}{2}}(x) \cos \theta_{n+\frac{1}{2}}(x)$		$y_n(x) = \sqrt{\frac{1}{2}\pi/x} M_{n+\frac{1}{2}}(x) \sin \theta_{n+\frac{1}{2}}(x)$			
x^{-1}	$\sqrt{\frac{1}{2}\pi x} M_{1\frac{1}{2}}(x)$	$\theta_{1\frac{1}{2}}(x) - x$	$\sqrt{\frac{1}{2}\pi x} M_{2\frac{1}{2}}(x)$	$\theta_{2\frac{1}{2}}(x) - x$	$\langle x \rangle$
0.100	1.50513 630	1.72311 121	1.84157 799	1.35401 461	10
0.095	1.41043 073	1.44562 029	1.65174 534	1.00196 372	11
0.090	1.33509 121	1.17232 718	1.50947 539	0.65310 249	11
0.085	1.27462 197	0.90378 457	1.40190 550	+0.30984 705	12
0.080	1.22560 809	0.64017 615	1.31955 792	-0.02643 915	13
0.075	1.18548 011	0.38142 613	1.25559 223	-0.35524 574	13
0.070	1.15231 423	+0.12729 416	1.20514 049	-0.67664 889	14
0.065	1.12467 134	-0.12255 277	1.16476 186	-0.99107 278	15
0.060	1.10147 221	-0.36849 087	1.13202 416	-1.29911 571	17
0.055	1.08190 340	-0.61090 826	1.10519 883	-1.60143 947	18
0.050	1.06534 781	-0.85018 673	1.08304 588	-1.89870 678	20
0.045	1.05133 389	-1.08669 229	1.06466 562	-2.19155 009	22
0.040	1.03949 892	-1.32077 114	1.04939 746	-2.48055 907	25
0.035	1.02956 235	-1.55274 891	1.03675 104	-2.76627 814	29
0.030	1.02130 658	-1.78293 175	1.02635 931	-3.04920 936	33
0.025	1.01456 304	-2.01160 832	1.01794 637	-3.32981 737	40
0.020	1.00920 210	-2.23905 224	1.01130 529	-3.60853 532	50
0.015	1.00512 574	-2.46552 469	1.00628 277	-3.88577 070	67
0.010	1.00226 240	-2.69127 701	1.00276 864	-4.16191 106	100
0.005	1.00056 327	-2.91655 326	1.00068 866	-4.43732 935	200
0.000	1.00000 000 $\left[\begin{smallmatrix} (-3)2 \\ 9 \end{smallmatrix} \right]$	-3.14159 265 $\left[\begin{smallmatrix} (-4)6 \\ 9 \end{smallmatrix} \right]$	1.00000 000 $\left[\begin{smallmatrix} (-3)6 \\ 9 \end{smallmatrix} \right]$	-4.71238 898 $\left[\begin{smallmatrix} (-4)9 \\ 10 \end{smallmatrix} \right]$	∞
x^{-1}	$\sqrt{\frac{1}{2}\pi x} M_{4\frac{1}{2}}(x)$	$\theta_{4\frac{1}{2}}(x) - x$	$\sqrt{\frac{1}{2}\pi x} M_{5\frac{1}{2}}(x)$	$\theta_{5\frac{1}{2}}(x) - x$	$\langle x \rangle$
0.040	1.31126 605	1.12909 207	1.37979 868	+0.54348 547	25
0.038	1.25741 042	0.61321 135	1.30763 025	-0.04056 472	26
0.036	1.21433 612	+0.11048 098	1.25205 767	-0.60729 830	28
0.034	1.17917 949	-0.38066 745	1.20806 627	-1.15885 172	29
0.032	1.15001 033	-0.86163 915	1.17245 178	-1.69717 688	31
0.030	1.12549 256	-1.33366 819	1.14310 153	-2.22398 514	33
0.028	1.10467 736	-1.79783 172	1.11857 851	-2.74075 480	36
0.026	1.08687 488	-2.25507 118	1.09787 629	-3.24876 024	38
0.024	1.07157 283	-2.70621 373	1.08027 122	-3.74910 503	42
0.022	1.05838 371	-3.15199 149	1.06523 083	-4.24275 239	45
0.020	1.04700 987	-3.59305 805	1.05235 561	-4.73055 105	50
0.018	1.03721 972	-4.03000 220	1.04134 092	-5.21325 651	56
0.016	1.02883 137	-4.46335 928	1.03195 154	-5.69154 843	63
0.014	1.02170 104	-4.89362 072	1.02400 423	-6.16604 479	71
0.012	1.01571 485	-5.32124 187	1.01735 560	-6.63731 350	83
0.010	1.01078 282	-5.74664 872	1.01189 351	-7.10588 196	100
0.008	1.00683 452	-6.17024 356	1.00753 093	-7.57224 522	125
0.006	1.00381 592	-6.59240 995	1.00420 153	-8.03687 285	167
0.004	1.00168 705	-7.01351 707	1.00185 654	-8.50021 498	250
0.002	1.00042 044	-7.43392 365	1.00046 253	-8.96270 770	500
0.000	1.00000 000 $\left[\begin{smallmatrix} (-3)1 \\ 9 \end{smallmatrix} \right]$	-7.85398 164 $\left[\begin{smallmatrix} (-3)2 \\ 9 \end{smallmatrix} \right]$	1.00000 000 $\left[\begin{smallmatrix} (-3)2 \\ 10 \end{smallmatrix} \right]$	-9.42477 796 $\left[\begin{smallmatrix} (-3)2 \\ 9 \end{smallmatrix} \right]$	∞

$\langle x \rangle$ = nearest integer to x .

Compiled from National Bureau of Standards, Tables of spherical Bessel functions, vols. I, II. Columbia Univ. Press, New York, N.Y., 1947 (with permission).

SPHERICAL BESSEL FUNCTIONS—VARIOUS ORDERS

Table 10.5

$j_n(x)$			
n	$x=1$	$x=2$	$x=5$
0	(- 1)8.41470 9848	(- 1)4.54648 7134	(- 1)-1.91784 8549
1	(- 1)3.01168 6789	(- 1)4.35397 7750	(- 2)-9.50894 0808
2	(- 2)6.20350 5201	(- 1)1.98447 9491	(- 1)+1.34731 2101
3	(- 3)9.00658 1117	(- 2)6.07220 9766	(- 1)2.29820 6182
4	(- 3)1.01101 5808	(- 2)1.40793 9276	(- 1)1.87017 6553
5	(- 5)9.25611 5861	(- 3)2.63516 9770	(- 1)1.06811 1615
6	(- 6)7.15693 6310	(- 4)4.14040 9734	(- 2)4.79668 9986
7	(- 7)4.79013 4199	(- 5)5.60965 5703	(- 2)1.79027 7818
8	(- 8)2.82649 8802	(- 6)6.68320 4324	(- 3)5.74143 4675
9	(- 9)1.49137 6503	(- 7)7.10679 7192	(- 3)1.61809 9715
10	(- 11)7.11655 2640	(- 8)6.82530 0865	(- 4)4.07344 2442
11	(- 12)3.09955 1855	(- 9)5.97687 1612	(- 5)9.27461 1037
12	(- 13)1.24166 2597	(- 10)4.81014 8901	(- 5)1.92878 6347
13	(- 15)4.60463 7678	(- 11)3.58145 1402	(- 6)3.69320 6998
14	(- 16)1.58957 5988	(- 12)2.48104 9119	(- 7)6.55454 3131
15	(- 18)5.13268 6115	(- 13)1.60698 2166	(- 7)1.08428 0182
16	(- 19)1.55670 8271	(- 15)9.77323 7728	(- 8)1.67993 9976
17	(- 21)4.45117 7504	(- 16)5.60205 9151	(- 9)2.44802 0198
18	(- 22)1.20385 5742	(- 17)3.03657 8644	(- 10)3.36741 6303
19	(- 24)3.08874 2364	(- 18)1.56113 3992	(- 11)4.38678 6630
20	(- 26)7.53779 5722	(- 20)7.63264 1101	(- 12)5.42772 6761
30	(- 43)5.56683 1267	(- 34)5.83661 7888	(- 22)4.28273 0217
40	(- 61)1.53821 0374	(- 49)1.66097 8779	(- 33)1.21034 7583
50	(- 81)3.61527 4717	(- 66)4.01157 5290	(- 46)2.85747 9350
100	(-190)7.44472 7742	(-160)9.36783 2591	(-120)5.53565 0303
n	$x=10$	$x=50$	$x=100$
0	(- 2)-5.44021 1109	(- 3)-5.24749 7074	(-3)-5.06365 6411
1	(- 2)+7.84669 4180	(- 2)-1.94042 7051	(-3)-8.67382 5287
2	(- 2)+7.79421 9363	(- 3)+4.08324 0843	(-3)+4.80344 1652
3	(- 2)-3.94958 4498	(- 2)+1.98125 9460	(-3)+8.91399 7370
4	(- 1)-1.05589 2851	(- 3)-1.30947 7600	(-3)-4.17946 1837
5	(- 2)-5.55345 1162	(- 2)-2.00483 0056	(-3)-9.29014 8935
6	(- 2)+4.45013 2233	(- 3)-3.10114 8524	(-3)+3.15754 5454
7	(- 1)1.13386 2307	(- 2)+1.92420 0195	(-3)+9.70062 9844
8	(- 1)1.25578 0236	(- 3)+8.87374 9108	(-3)-1.70245 0977
9	(- 1)1.00096 4095	(- 2)-1.62249 2725	(-3)-9.99004 6510
10	(- 2)6.46051 5449	(- 2)-1.50392 2146	(-4)-1.95657 8597
11	(- 2)3.55744 1489	(- 3)+9.90845 4236	(-3)+9.94895 8359
12	(- 2)1.72159 9974	(- 2)+1.95971 1041	(-3)+2.48391 8282
13	(- 3)7.46558 4477	(- 4)-1.09899 0300	(-3)-9.32797 8789
14	(- 3)2.94107 8342	(- 2)-1.96564 5589	(-3)-5.00247 2555
15	(- 3)1.06354 2715	(- 2)-1.12908 4539	(-3)+7.87726 1748
16	(- 4)3.55904 0735	(- 2)+1.26561 3175	(-3)+7.44442 3697
17	(- 4)1.10940 7280	(- 2)+1.96438 9234	(-3)-5.42060 1928
18	(- 5)3.23884 7439	(- 3)+1.09459 2888	(-3)-9.34163 4372
19	(- 6)8.89662 7269	(- 2)-1.88338 9360	(-3)+1.96419 7210
20	(- 6)2.30837 1961	(- 2)-1.57850 2990	(-2)+1.01076 7128
30	(-13)2.51205 7385	(- 3)-1.49467 3454	(-3)+8.70062 8514
40	(-22)8.43567 1634	(- 2)-2.60633 6952	(-2)+1.04341 0851
50	(-31)2.23069 6023	(- 2)+1.88291 0737	(-4)+5.79714 0882
100	(-90)5.83204 0182	(-22)+1.01901 2263	(-2)+1.08804 7701

Table 10.5 SPHERICAL BESSEL FUNCTIONS—VARIOUS ORDERS

n	$y_n(x)$		
	$x=1$	$x=2$	$x=5$
0	(-1)-5.40302 3059	(-1)+2.08073 4183	(-2)-5.67324 3709
1	(0)-1.38177 3291	(-1)-3.50612 0043	(-1)+1.80438 3675
2	(0)-3.60501 7566	(-1)-7.33991 4247	(-1)+1.64995 4576
3	(1)-1.66433 1454	(0)-1.48436 6557	(-2)-1.54429 0991
4	(2)-1.12898 1842	(0)-4.46129 1526	(-1)-1.86615 5315
5	(2)-9.99440 3434	(1)-1.85914 4531	(-1)-3.20465 0467
6	(4)-1.08809 4559	(1)-9.77916 5769	(-1)-5.18407 5714
7	(5)-1.40452 8524	(2)-6.17054 3296	(0)-1.02739 4639
8	(6)-2.09591 1840	(3)-4.53011 5815	(0)-2.56377 6345
9	(7)-3.54900 4843	(4)-3.78889 3009	(0)-7.68944 4934
10	(8)-6.72215 0083	(5)-3.55414 7201	(1)-2.66561 1441
11	(10)-1.40810 2512	(6)-3.69396 5631	(2)-1.04266 2356
12	(11)-3.23191 3629	(7)-4.21251 9003	(2)-4.52968 5692
13	(12)-8.06570 3047	(8)-5.22870 9098	(3)-2.16057 6611
14	(14)-2.17450 7909	(9)-7.01663 2092	(4)-1.12141 4513
15	(15)-6.29800 7233	(11)-1.01218 2944	(4)-6.28814 6513
16	(17)-1.95020 7734	(12)-1.56186 6932	(5)-3.78650 9387
17	(18)-6.42938 7516	(13)-2.56695 8608	(6)-2.43621 4730
18	(20)-2.24833 5423	(14)-4.47655 8894	(7)-1.66748 5217
19	(21)-8.31241 1677	(15)-8.25596 4368	(8)-1.20957 6913
20	(23)-3.23959 2219	(17)-1.60543 6493	(8)-9.26795 1403
30	(40)-2.94642 8547	(31)-1.40739 3871	(18)-7.76071 7570
40	(58)-8.02845 0851	(46)-3.72092 9322	(30)-2.05575 8716
50	(78)-2.73919 2285	(63)-1.23502 1944	(42)-6.96410 9188
100	(186)-6.68307 9463	(156)-2.65595 5830	(116)-1.79971 3983
n	$x=10$	$x=50$	$x=100$
0	(-2)+8.39071 5291	(-2)-1.92993 2057	(-3)-8.62318 8723
1	(-2)+6.27928 2638	(-3)+4.86151 0663	(-3)+4.97742 4524
2	(-2)-6.50693 0499	(-2)+1.95910 1121	(-3)+8.77251 1459
3	(-2)-9.53274 7888	(-3)-2.90240 9542	(-3)-4.53879 8951
4	(-3)-1.65993 0220	(-2)-1.99973 4855	(-3)-9.09022 7385
5	(-2)+9.38335 4168	(-4)-6.97113 1965	(-3)+3.72067 8486
6	(-1)+1.04876 8261	(-2)+1.98439 8364	(-3)+9.49950 2019
7	(-2)+4.25063 3221	(-3)+5.85654 8943	(-3)-2.48574 3224
8	(-2)-4.11173 2775	(-2)-1.80870 1896	(-3)-9.87236 3502
9	(-1)-1.12405 7894	(-2)-1.20061 3539	(-4)+8.07441 4285
10	(-1)-1.72453 6721	(-2)+1.35246 8751	(-2)+1.00257 7737
11	(-1)-2.49746 9220	(-2)+1.76865 0414	(-3)+1.29797 1820
12	(-1)-4.01964 2485	(-3)-5.38889 5605	(-3)-9.72724 3855
13	(-1)-7.55163 6993	(-2)-2.03809 5195	(-3)-3.72978 2784
14	(0)-1.63697 7739	(-3)-5.61681 8446	(-3)+8.72020 2503
15	(0)-3.99207 1745	(-2)+1.71231 9725	(-3)+6.25864 1510
16	(1)-1.07384 4467	(-2)+1.62332 0074	(-3)-6.78002 3635
17	(1)-3.14447 9567	(-3)-6.40928 4759	(-3)-8.49604 9309
18	(1)-9.93183 4017	(-2)-2.07197 0007	(-3)+3.80640 6377
19	(2)-3.36033 0630	(-3)-8.92329 3294	(-3)+9.90441 9669
20	(3)-1.21121 0605	(-2)+1.37595 3130	(-5)+5.63172 9379
30	(9)-6.90831 8646	(-2)-2.24122 6812	(-3)-5.41292 9349
40	(18)-1.51030 4919	(-5)+4.97879 7221	(-4)-7.04842 0407
50	(27)-4.52822 7272	(-2)-4.19000 0150	(-2)+1.07478 2297
100	(85)-8.57322 6309	(+18)-1.12569 2891	(-2)-2.29838 5049

ZEROS OF BESSEL FUNCTIONS OF HALF-INTEGER ORDER

Table 10.6

ν	s	$j_{\nu,s}$	$J'_\nu(j_{\nu,s})$	$y_{\nu,s}$	$(-1)^{n+1}Y'_\nu(y_{\nu,s})$	ν	s	$j_{\nu,s}$	$J'_\nu(j_{\nu,s})$	$y_{\nu,s}$	$(-1)^{n+1}Y'_\nu(y_{\nu,s})$	
1/2	1	3.141593	-0.45015 82	1.570796	-0.63661 98	15/2	1	11.657032	-0.20550 46	9.457882	+0.20754 83	
	2	6.283185	+0.31830 99	4.712389	+0.36755 26		2	15.431289	+0.19008 87	13.600629	-0.19801 01	
	3	9.424778	-0.25989 89	7.853982	-0.28470 50		3	18.922999	-0.17582 99	17.197777	+0.18264 01	
	4	12.566370	+0.22507 91	10.995574	+0.24061 97		4	22.295348	+0.16402 38	20.619612	-0.16964 44	
	5	15.707963	-0.20131 68	14.137167	-0.21220 66		5			23.955267	+0.15890 14	
	6	18.849556	+0.18377 63	17.278760	+0.19194 81							
	7	21.991149	-0.17014 38	20.420352	-0.17656 66							
	8			23.561945	+0.16437 45							
3/2	1	4.493409	-0.36741 35	2.798386	+0.44914 84	17/2	1	12.790782	-0.19382 82	10.529989	-0.19361 38	
	2	7.725252	+0.28469 20	6.121250	-0.31827 37		2	16.641003	+0.18155 15	14.777175	+0.18810 92	
	3	10.904122	-0.24061 69	9.317866	+0.25989 33		3	20.182471	-0.16922 10	18.434529	-0.17517 27	
	4	14.066194	+0.21220 57	12.486454	-0.22507 76		4	23.591275	+0.15870 04	21.898570	+0.16373 75	
	5	17.220755	-0.19194 77	15.644128	+0.20131 63	19/2	1	13.915823	-0.18376 12	11.597038	+0.18186 42	
	6	20.371303	+0.17656 64	18.796404	-0.18377 61		2	17.838643	+0.17398 80	15.942945	-0.17944 10	
	7	23.519452	-0.16437 44	21.945613	+0.17014 37		3	21.428487	-0.16326 17	19.658369	+0.16849 33	
							4	24.873214	+0.15383 84	23.163734	-0.15837 45	
5/2	1	5.763459	-0.31710 58	3.959528	-0.36184 68	21/2	1	15.033469	-0.17496 82	12.659840	-0.17179 22	
	2	9.095011	+0.25973 30	7.451610	+0.28430 75		2	19.025854	+0.16722 59	17.099480	+0.17176 97	
	3	12.322941	-0.22503 59	10.715647	-0.24053 93		3	22.662721	-0.15785 09	20.870973	-0.16247 13	
	4	15.514603	+0.20130 14	13.921686	+0.21218 15		4			24.416749	+0.15347 56	
	5	18.689036	-0.18376 96	17.103359	-0.19193 81	23/2	1	16.144743	-0.16720 39	13.719013	+0.16304 06	
	6	21.853874	+0.17014 05	20.272369	+0.17656 19		2	20.203943	+0.16113 25	18.247994	-0.16491 86	
	7			23.433926	-0.16437 21		3	23.886531	-0.15290 87	22.073692	+0.15700 50	
7/2	1	6.987932	-0.28223 71	5.088498	+0.30882 36	25/2	1	17.250455	-0.16028 44	14.775045	-0.15534 97	
	2	10.417119	+0.24019 23	8.733710	-0.25896 77		2	21.373972	+0.15560 47	19.389462	+0.15875 20	
	3	13.698023	-0.21208 02	12.067544	+0.22485 68		3			23.267630	-0.15201 34	
	4	16.923621	+0.19189 90	15.315390	-0.20124 01		27/2	1	18.351261	-0.15406 88	15.828325	+0.14852 56
	5	20.121806	-0.17654 40	18.525210	+0.18374 36	2		22.536817	+0.15056 00	20.524680	-0.15316 36	
	6	23.304247	+0.16436 28	21.714547	-0.17012 77	3				24.453705	+0.14743 15	
	7			24.891503	+0.15914 62							
	9/2	1	8.182561	-0.25620 49	6.197831	-0.27236 25	29/2	1	19.447703	-0.14844 69	16.879170	-0.14242 04
2		11.704907	+0.22432 53	9.982466	+0.23908 76	2		23.693208	+0.14593 21	21.654309	+0.14806 91	
3		15.039665	-0.20107 12	13.385287	-0.21179 27	31/2		1	20.540230	-0.14333 12	17.927842	+0.13691 88
4		18.301256	+0.18367 44	16.676625	+0.19179 35			2	24.843763	+0.14166 70	22.778902	-0.14340 05
5		21.525418	-0.17009 46	19.916796	-0.17649 69		33/2	1	21.629221	-0.13865 11	18.974562	-0.13192 99
6		24.727566	+0.15912 86	23.128642	+0.16433 89			2			23.898931	+0.13910 20
						35/2		1	22.715002	-0.13434 93	20.019515	+0.12738 05
11/2	1	9.355812	-0.23580 60	7.293692	+0.24538 14	37/2	1	23.797849	-0.13037 81	21.062860	-0.12321 33	
	2	12.966530	+0.21109 29	11.206497	-0.22293 49		39/2	1	24.878005	-0.12669 81	22.104735	+0.11937 34
	3	16.354710	-0.19155 58	14.676387	+0.20067 86							
	4	19.653152	+0.17639 49	18.011609	-0.18352 21							
	5	22.904551	-0.16428 83	21.283249	+0.17002 38							
	6			24.518929	-0.15909 15							
	13/2	1	10.512835	-0.21926 48	8.379626	-0.22441 70						
		2	14.207392	+0.19983 04	12.411301	+0.20946 65						
3		17.647975	-0.18321 82	15.945983	-0.19106 59							
4		20.983463	+0.16988 82	19.324820	+0.17619 60							
5		24.262768	-0.15902 21	22.628417	-0.16419 26							

Values to greater accuracy and over a wider range are given in [10.31].
 From National Bureau of Standards, Tables of spherical Bessel functions, vols. I, II. Columbia Univ. Press, New York, N.Y., 1947 (with permission).

Table 10.7

ZEROS OF THE DERIVATIVE OF BESSEL FUNCTIONS OF HALF-INTEGER ORDER

		$J'_\nu(j'_{\nu,s})=0$				$Y'_\nu(y'_{\nu,s})=0$					
ν	s	$j'_{\nu,s}$	$J_\nu(j'_{\nu,s})$	$y'_{\nu,s}$	$(-1)^{n+1}Y_\nu(y'_{\nu,s})$	ν	s	$j'_{\nu,s}$	$J_\nu(j'_{\nu,s})$	$y'_{\nu,s}$	$(-1)^{n+1}Y_\nu(y'_{\nu,s})$
1/2	1	1.165561	+0.679192	2.975086	-0.456186	15/2	1	9.113402	+0.330874	11.535731	+0.266883
	2	4.604217	-0.369672	6.202750	+0.319331		2	13.525575	-0.236854	15.376058	-0.217283
	3	7.789884	+0.285287	9.371475	-0.260267		3	17.153587	+0.202841	18.885886	+0.191447
	4	10.949944	-0.240870	12.526476	+0.225258		4	20.587450	-0.182077	22.266861	-0.174147
	5	14.101725	+0.212340	15.676078	-0.201419		5	23.929631	+0.167294		
	6	17.249782	-0.192029	18.822999	+0.183841						
	7	20.395842	+0.176620	21.968393	-0.170188						
	8	23.540708	-0.164412								
3/2	1	2.460536	+0.525338	4.354435	+0.388891	17/2	1	10.180054	+0.318378	12.669130	-0.257833
	2	6.029292	-0.328062	7.655545	-0.290138		2	14.702493	-0.229449	16.586323	+0.210950
	3	9.261402	+0.263295	10.856531	+0.242910		3	18.390930	+0.197291	20.145940	-0.186505
	4	12.445260	-0.226711	14.029845	-0.213417		4	21.866965	-0.177623	23.563314	+0.170098
	5	15.611585	+0.202245	17.191285	+0.192678	19/2	1	11.241675	+0.307606	13.793646	+0.249935
	6	18.769469	-0.184363	20.346496	-0.177046		2	15.868463	-0.222927	17.784362	-0.205332
	7	21.922619	+0.170542	23.498023	+0.164709		3	19.615227	+0.192335	21.392422	+0.182067
					4	23.132584	-0.173605	24.845689	-0.166427		
5/2	1	3.632797	+0.457398	5.634297	-0.350669	21/2	1	12.299124	+0.298179	14.910648	-0.242951
	2	7.367009	-0.301449	9.030902	+0.270006		2	17.025072	-0.217118	18.971857	+0.200296
	3	10.663561	+0.247304	12.278863	-0.229783		3	20.828186	+0.187870	22.627032	-0.178048
	4	13.883370	-0.215670	15.480655	+0.203956		4	24.385974	-0.169950		
	5	17.072849	+0.194015	18.661309	-0.185432	23/2	1	13.353045	+0.289825	16.021196	+0.236710
	6	20.246945	-0.177917	21.830390	+0.171262		2	18.173567	-0.211893	20.150142	-0.195742
	7	23.412100	+0.165314	24.992411	-0.159953		3	22.031181	+0.183813	23.851147	+0.174383
7/2	1	4.762196	+0.415533	6.863232	+0.324651	25/2	1	14.403937	+0.282348	17.126125	-0.231081
	2	8.653134	-0.282237	10.356373	-0.254849		2	19.314945	-0.207156	21.320300	+0.191594
	3	12.018262	+0.234875	13.656304	+0.219318		3	23.225333	+0.180103		
	4	15.279081	-0.206685	16.891400	-0.196124	27/2	1	15.452196	+0.275596	18.226109	+0.225965
	5	18.496200	+0.187103	20.095393	+0.179270		2	20.450018	-0.202830	22.483219	-0.187792
	6	21.690284	-0.172377	23.281796	-0.166245		3	24.411571	+0.176690		
	7	24.870602	+0.160741								
9/2	1	5.868420	+0.386006	8.060030	-0.305246	29/2	1	16.498138	+0.269455	19.321702	-0.221286
	2	9.904306	-0.267385	11.646354	+0.242810		2	21.579459	-0.198856	23.639641	+0.184287
	3	13.337928	+0.224788	14.999624	-0.210673	31/2	1	17.542024	+0.263833	20.413362	+0.216981
	4	16.641787	-0.199151	18.270330	+0.189472		2	22.703832	-0.195187	24.790191	-0.181040
	5	19.888934	+0.181169	21.500029	-0.173929						
	6	23.105297	-0.167534	24.705942	+0.161826						
11/2	1	6.959746	+0.363557	9.234274	+0.289946	33/2	1	18.584071	+0.258658	21.501477	-0.213000
	2	11.129856	-0.255385	12.909478	-0.232895		2	23.823614	-0.191783		
	3	14.630406	+0.216349	16.315912	+0.203344	35/2	1	19.624460	+0.253871	22.586374	+0.209303
	4	17.977886	-0.192692	19.623229	-0.183714		2	24.939214	-0.188612		
	5	21.256291	+0.175987	22.879980	+0.169229						
	6	24.496327	-0.163244								
13/2	1	8.040535	+0.345649	10.391621	-0.277420	37/2	1	20.663347	+0.249423	23.668335	-0.205855
	2	12.335631	-0.245384	14.151399	+0.224513		39/2	1	21.700865	+0.245275	24.747606
	3	15.901023	+0.209127	17.610124	-0.197009						
	4	19.291967	-0.187058	20.954335	+0.178651						
	5	22.602185	+0.171399	24.238863	-0.165043						

Values to greater accuracy and over a wider range are given in [10.31].

From National Bureau of Standards, Tables of spherical Bessel functions, vols. I, II. Columbia Univ. Press, New York, N.Y., 1947 (with permission).

MODIFIED SPHERICAL BESSEL FUNCTIONS—ORDERS 0, 1 AND 2

Table 10.8

x	$i_0(x)$	$i_1(x)$	$i_2(x)$	$k_0(x)$	$k_1(x)$	$k_2(x)$
0.0	1.00000 000	0.00000 000	0.00000 0000	∞	∞	∞
0.1	1.00166 750	0.03336 668	0.00066 7143	14.21315 293	156.344682	4704.5536
0.2	1.00668 001	0.06693 370	0.00267 4294	6.43029 630	38.58177 78	585.15696
0.3	1.01506 764	0.10090 290	0.00603 8668	3.87891 513	16.80863 22	171.96524
0.4	1.02688 081	0.13547 889	0.01078 9114	2.63234 067	9.21319 233	71.731283
0.5	1.04219 061	0.17087 071	0.01696 6360	1.90547 226	5.71641 679	36.203973
0.6	1.06108 930	0.20729 319	0.02462 3348	1.43678 550	3.83142 801	20.593926
0.7	1.08369 100	0.24496 858	0.03382 5678	1.11433 482	2.70624 170	12.712514
0.8	1.11013 248	0.28412 808	0.04465 2156	0.88225 536	1.98507 456	8.32628 49
0.9	1.14057 414	0.32501 361	0.05719 5452	0.70959 792	1.49804 005	5.70306 48
1.0	1.17520 119	0.36787 944	0.07156 2871	0.57786 367	1.15572 735	4.04504 57
1.1	1.21422 497	0.41299 416	0.08787 7251	0.47533 880	0.90746 4974	2.95024 33
1.2	1.25788 446	0.46064 259	0.10627 7995	0.39426 230	0.72281 4219	2.20129 78
1.3	1.30644 803	0.51112 785	0.12692 2227	0.32930 149	0.58261 0332	1.67378 69
1.4	1.36021 536	0.56477 365	0.14998 6112	0.27668 115	0.47431 0537	1.29306 09
1.5	1.41951 964	0.62192 665	0.17566 6332	0.23366 136	0.38943 5596	1.01253 25
1.6	1.48472 997	0.68295 906	0.20418 1728	0.19821 144	0.32209 3595	0.80213 693
1.7	1.55625 408	0.74827 140	0.23577 5138	0.16879 918	0.26809 2818	0.64190 415
1.8	1.63454 127	0.81829 550	0.27071 5433	0.14425 049	0.22438 9655	0.51823 325
1.9	1.72008 574	0.89349 778	0.30929 9770	0.12365 360	0.18873 4440	0.42165 535
2.0	1.81343 020	0.97438 274	0.35185 6089	0.10629 208	0.15943 8124	0.34544 927
2.1	1.91516 988	1.06149 681	0.39874 5868	0.09159 719	0.13521 4906	0.28476 135
2.2	2.02595 690	1.15543 247	0.45036 7165	0.07911 327	0.11507 3847	0.23603 215
2.3	2.14650 513	1.25683 283	0.50715 7959	0.06847 227	0.09824 2824	0.19661 508
2.4	2.27759 551	1.36639 653	0.56959 9849	0.05937 476	0.08411 4246	0.16451 757
2.5	2.42008 179	1.48488 308	0.63822 2102	0.05157 553	0.07220 5736	0.13822 241
2.6	2.57489 701	1.61311 877	0.71360 6125	0.04487 256	0.06213 1241	0.11656 246
2.7	2.74306 041	1.75200 304	0.79639 0365	0.03909 858	0.05357 9539	0.09863 140
2.8	2.92568 513	1.90251 546	0.88727 5704	0.03411 437	0.04629 8067	0.08371 944
2.9	3.12398 658	2.06572 335	0.98703 1387	0.02980 354	0.04008 0625	0.07126 626
3.0	3.33929 164	2.24279 012	1.09650 152	0.02606 845	0.03475 7931	0.06082 638
3.1	3.57304 872	2.43498 437	1.21661 224	0.02282 681	0.03019 0302	0.05204 323
3.2	3.82683 875	2.64368 983	1.34837 954	0.02000 910	0.02626 1944	0.04462 967
3.3	4.10238 723	2.87041 631	1.49291 787	0.01755 635	0.02287 6452	0.03835 312
3.4	4.40157 747	3.11681 153	1.65144 965	0.01541 841	0.01995 3243	0.03302 422
3.5	4.72646 494	3.38467 421	1.82531 562	0.01355 255	0.01742 4712	0.02848 802
3.6	5.07929 316	3.67596 831	2.01598 623	0.01192 222	0.01523 3952	0.02461 718
3.7	5.46251 092	3.99283 865	2.22507 418	0.01049 611	0.01333 2903	0.02130 658
3.8	5.87879 128	4.33762 799	2.45434 813	0.00924 735	0.01168 0862	0.01846 908
3.9	6.33105 220	4.71289 572	2.70574 780	0.00815 280	0.01024 3262	0.01603 223
4.0	6.82247 930	5.12143 838	2.98140 051	0.00719 253	0.00899 0668	0.01393 554
4.1	7.35655 060	5.56631 208	3.28363 932	0.00634 934	0.00789 7961	0.01212 834
4.2	7.93706 374	6.05085 704	3.61502 300	0.00560 833	0.00694 3650	0.01056 808
4.3	8.56816 571	6.57872 451	3.97835 791	0.00495 661	0.00610 9316	0.00921 893
4.4	9.25438 538	7.15390 628	4.37672 200	0.00438 300	0.00537 9136	0.00805 059
4.5	10.00066 914	7.78076 689	4.81349 122	0.00387 777	0.00473 9498	0.00703 744
4.6	10.81241 998	8.46407 908	5.29236 840	0.00343 248	0.00417 8666	0.00615 769
4.7	11.69554 012	9.20906 250	5.81741 513	0.00303 975	0.00368 6506	0.00539 284
4.8	12.65647 789	10.02142 620	6.39308 652	0.00269 318	0.00325 4257	0.00472 709
4.9	13.70227 889	10.90741 515	7.02426 961	0.00238 716	0.00287 4331	0.00414 695
5.0	14.84064 212	11.87386 128	7.71632 535	0.00211 679	0.00254 0146	0.00364 088

$$i_n(x) = \sqrt{\frac{1}{2}} \pi/x I_{n+\frac{1}{2}}(x)$$

$$k_n(x) = \sqrt{\frac{1}{2}} \pi/x K_{n+\frac{1}{2}}(x)$$

Table 10.9 MODIFIED SPHERICAL BESSEL FUNCTIONS—ORDERS 9 AND 10

x	$10^9 x^{-9} i_9(x)$	$10^{10} x^{-10} i_{10}(x)$	$10^{-7} x^{10} k_9(x)$	$10^{-9} x^{11} k_{10}(x)$
0.0	1.52734 93	0.72730 92	5.41287 38	1.02844 60
0.1	1.52771 30	0.72746 73	5.41128 21	1.02817 54
0.2	1.52880 46	0.72794 19	5.40650 99	1.02736 41
0.3	1.53062 54	0.72873 35	5.39856 70	1.02601 35
0.4	1.53317 79	0.72984 30	5.38746 92	1.02412 59
0.5	1.53646 54	0.73127 18	5.37323 85	1.02170 47
0.6	1.54049 23	0.73302 17	5.35590 33	1.01875 42
0.7	1.54526 36	0.73509 47	5.33549 79	1.01527 95
0.8	1.55078 57	0.73749 33	5.31206 23	1.01128 67
0.9	1.55706 60	0.74022 04	5.28564 31	1.00678 27
1.0	1.56411 27	0.74327 93	5.25629 13	1.00177 53
1.1	1.57193 49	0.74667 38	5.22406 45	0.99627 31
1.2	1.58054 32	0.75040 79	5.18902 48	0.99028 56
1.3	1.58994 87	0.75448 62	5.15123 93	0.98382 30
1.4	1.60016 42	0.75891 37	5.11078 01	0.97689 61
1.5	1.61120 30	0.76369 58	5.06772 38	0.96951 68
1.6	1.62308 02	0.76883 83	5.02215 07	0.96169 72
1.7	1.63581 13	0.77434 76	4.97414 57	0.95345 03
1.8	1.64941 38	0.78023 05	4.92379 68	0.94478 97
1.9	1.66390 60	0.78649 43	4.87119 57	0.93572 94
2.0	1.67930 73	0.79314 68	4.81643 66	0.92628 41
2.1	1.69563 90	0.80019 63	4.75961 72	0.91646 88
2.2	1.71292 33	0.80765 17	4.70083 65	0.90629 89
2.3	1.73118 39	0.81552 21	4.64019 67	0.89579 04
2.4	1.75044 59	0.82381 79	4.57780 09	0.88495 95
2.5	1.77073 63	0.83254 94	4.51375 41	0.87382 25
2.6	1.79208 32	0.84172 78	4.44816 23	0.86239 63
2.7	1.81451 64	0.85136 49	4.38113 22	0.85069 78
2.8	1.83806 76	0.86147 30	4.31277 10	0.83874 39
2.9	1.86277 03	0.87206 54	4.24318 63	0.82655 20
3.0	1.88865 96	0.88315 57	4.17248 53	0.81413 92
3.1	1.91577 24	0.89475 86	4.10077 50	0.80152 28
3.2	1.94414 79	0.90688 95	4.02816 19	0.78872 01
3.3	1.97382 74	0.91956 42	3.95475 12	0.77574 83
3.4	2.00485 39	0.93279 97	3.88064 76	0.76262 45
3.5	2.03727 33	0.94661 40	3.80595 33	0.74936 56
3.6	2.07113 33	0.96102 55	3.73076 99	0.73598 84
3.7	2.10648 43	0.97605 38	3.65519 70	0.72250 95
3.8	2.14337 94	0.99171 97	3.57933 16	0.70894 53
3.9	2.18187 40	1.00804 44	3.50326 88	0.69531 19
4.0	2.22202 68	1.02505 08	3.42710 13	0.68162 50
4.1	2.26389 90	1.04276 26	3.35091 95	0.66790 02
4.2	2.30755 54	1.06120 45	3.27481 07	0.65415 25
4.3	2.35306 35	1.08040 28	3.19885 96	0.64039 66
4.4	2.40049 43	1.10038 47	3.12314 76	0.62664 70
4.5	2.44992 27	1.12117 91	3.04775 39	0.61291 75
4.6	2.50142 71	1.14281 58	2.97275 34	0.59922 16
4.7	2.55508 99	1.16532 63	2.89821 88	0.58557 24
4.8	2.61099 74	1.18874 39	2.82421 90	0.57198 25
4.9	2.66924 03	1.21310 29	2.75081 98	0.55846 39
5.0	2.72991 40	1.23843 97	2.67808 38	0.54502 82

$$i_n(x) = \sqrt{\frac{1}{2}} \pi/x I_{n+\frac{1}{2}}(x)$$

$$k_n(x) = \sqrt{\frac{1}{2}} \pi/x K_{n+\frac{1}{2}}(x)$$

Compiled from C. W. Jones, A short table for the Bessel functions $I_{n+\frac{1}{2}}(x)$, $(2/\pi)K_{n+\frac{1}{2}}(x)$.
 Cambridge Univ. Press, Cambridge, England, 1952 (with permission).

MODIFIED SPHERICAL BESSEL FUNCTIONS—ORDERS 9 AND 10 Table 10.9

x	$e^{-x}I_{19}(x)$	$e^{-x}I_{21}(x)$	$\frac{2}{\pi}e^xK_{19}(x)$	$\frac{2}{\pi}e^xK_{21}(x)$
5.0	(-5) 6.40961	(-5) 1.45387	(2) 4.62276	(3) 1.88159
5.1	(-5) 7.16216	(-5) 1.65403	(2) 4.11899	(3) 1.64774
5.2	(-5) 7.97716	(-5) 1.87488	(2) 3.68187	(3) 1.44818
5.3	(-5) 8.85734	(-5) 2.11778	(2) 3.30123	(3) 1.27719
5.4	(-5) 9.80541	(-5) 2.38413	(2) 2.96863	(3) 1.13013
5.5	(-4) 1.08240	(-5) 2.67535	(2) 2.67706	(3) 1.00320
5.6	(-4) 1.19157	(-5) 2.99285	(2) 2.42066	(2) 8.93250
5.7	(-4) 1.30831	(-5) 3.33809	(2) 2.19449	(2) 7.97686
5.8	(-4) 1.43285	(-5) 3.71252	(2) 1.99441	(2) 7.14360
5.9	(-4) 1.56545	(-5) 4.11760	(2) 1.81692	(2) 6.41477
6.0	(-4) 1.70632	(-5) 4.55480	(2) 1.65905	(2) 5.77537
6.1	(-4) 1.85569	(-5) 5.02559	(2) 1.51825	(2) 5.21281
6.2	(-4) 2.01376	(-5) 5.53143	(2) 1.39236	(2) 4.71647
6.3	(-4) 2.18075	(-5) 6.07377	(2) 1.27955	(2) 4.27737
6.4	(-4) 2.35684	(-5) 6.65407	(2) 1.17821	(2) 3.88791
6.5	(-4) 2.54221	(-5) 7.27375	(2) 1.08697	(2) 3.54160
6.6	(-4) 2.73703	(-5) 7.93423	(2) 1.00464	(2) 3.23292
6.7	(-4) 2.94147	(-5) 8.63691	(1) 9.30213	(2) 2.95714
6.8	(-4) 3.15568	(-5) 9.38317	(1) 8.62775	(2) 2.71019
6.9	(-4) 3.37978	(-4) 1.01743	(1) 8.01557	(2) 2.48857
7.0	(-4) 3.61391	(-4) 1.10117	(1) 7.45880	(2) 2.28926
7.1	(-4) 3.85819	(-4) 1.18967	(1) 6.95148	(2) 2.10966
7.2	(-4) 4.11271	(-4) 1.28304	(1) 6.48840	(2) 1.94748
7.3	(-4) 4.37758	(-4) 1.38142	(1) 6.06498	(2) 1.80076
7.4	(-4) 4.65288	(-4) 1.48492	(1) 5.67717	(2) 1.66777
7.5	(-4) 4.93867	(-4) 1.59365	(1) 5.32140	(2) 1.54701
7.6	(-4) 5.23503	(-4) 1.70773	(1) 4.99452	(2) 1.43717
7.7	(-4) 5.54199	(-4) 1.82727	(1) 4.69371	(2) 1.33708
7.8	(-4) 5.85960	(-4) 1.95236	(1) 4.41649	(2) 1.24573
7.9	(-4) 6.18789	(-4) 2.08311	(1) 4.16065	(2) 1.16223
8.0	(-4) 6.52688	(-4) 2.21961	(1) 3.92420	(2) 1.08577
8.1	(-4) 6.87657	(-4) 2.36195	(1) 3.70539	(2) 1.01566
8.2	(-4) 7.23697	(-4) 2.51020	(1) 3.50262	(1) 9.51284
8.3	(-4) 7.60807	(-4) 2.66447	(1) 3.31448	(1) 8.92076
8.4	(-4) 7.98985	(-4) 2.82481	(1) 3.13970	(1) 8.37549
8.5	(-4) 8.38228	(-4) 2.99130	(1) 2.97713	(1) 7.87266
8.6	(-4) 8.78533	(-4) 3.16400	(1) 2.82574	(1) 7.40835
8.7	(-4) 9.19895	(-4) 3.34298	(1) 2.68460	(1) 6.97906
8.8	(-4) 9.62308	(-4) 3.52828	(1) 2.55287	(1) 6.58165
8.9	(-3) 1.00576	(-4) 3.71997	(1) 2.42979	(1) 6.21331
9.0	(-3) 1.05026	(-4) 3.91809	(1) 2.31467	(1) 5.87149
9.1	(-3) 1.09579	(-4) 4.12268	(1) 2.20689	(1) 5.55393
9.2	(-3) 1.14235	(-4) 4.33377	(1) 2.10586	(1) 5.25858
9.3	(-3) 1.18991	(-4) 4.55140	(1) 2.01109	(1) 4.98356
9.4	(-3) 1.23849	(-4) 4.77560	(1) 1.92209	(1) 4.72722
9.5	(-3) 1.28806	(-4) 5.00639	(1) 1.83843	(1) 4.48802
9.6	(-3) 1.33861	(-4) 5.24378	(1) 1.75973	(1) 4.26461
9.7	(-3) 1.39014	(-4) 5.48779	(1) 1.68563	(1) 4.05572
9.8	(-3) 1.44263	(-4) 5.73844	(1) 1.61578	(1) 3.86022
9.9	(-3) 1.49607	(-4) 5.99571	(1) 1.54991	(1) 3.67709
10.0	(-3) 1.55045	(-4) 6.25963	(1) 1.48772	(1) 3.50537

Table 10.9

MODIFIED SPHERICAL BESSEL FUNCTIONS—ORDERS 9 AND 10

x^{-1}	$f_9(x)$	$f_{10}(x)$	$g_9(x)$	$g_{10}(x)$	$\langle x \rangle$
0.100	1.10630 573	1.21411 149	0.65502 364	0.56777 303	10
0.095	1.08238 951	1.17260 877	0.68557 030	0.60351 931	11
0.090	1.06167 683	1.13650 462	0.71563 676	0.63926 956	11
0.085	1.04394 741	1.10534 464	0.74502 124	0.67473 612	12
0.080	1.02899 406	1.07872 041	0.77352 114	0.70961 813	13
0.075	1.01661 895	1.05626 085	0.80093 667	0.74360 745	13
0.070	1.00662 998	1.03762 412	0.82707 483	0.77639 538	14
0.065	0.99883 728	1.02248 982	0.85175 354	0.80768 018	15
0.060	0.99304 985	1.01055 159	0.87480 587	0.83717 510	17
0.055	0.98907 251	1.00151 009	0.89608 425	0.86461 675	18
0.050	0.98670 320	0.99506 643	0.91546 455	0.88977 340	20
0.045	0.98573 080	0.99091 634	0.93284 978	0.91245 301	22
0.040	0.98593 357	0.98874 519	0.94817 344	0.93251 041	25
0.035	0.98707 842	0.98822 421	0.96140 216	0.94985 358	29
0.030	0.98892 100	0.98900 824	0.97253 769	0.96444 830	33
0.025	0.99120 680	0.99073 519	0.98161 804	0.97632 121	40
0.020	0.99367 323	0.99302 746	0.98871 764	0.98556 077	50
0.015	0.99605 259	0.99549 538	0.99394 654	0.99231 623	67
0.010	0.99807 595	0.99774 259	0.99744 863	0.99679 434	100
0.005	0.99947 760	0.99937 316	0.99939 894	0.99925 415	200
0.000	1.00000 000 $\left[\begin{smallmatrix} (-4)4 \\ 6 \end{smallmatrix} \right]$	1.00000 000 $\left[\begin{smallmatrix} (-4)7 \\ 7 \end{smallmatrix} \right]$	1.00000 000 $\left[\begin{smallmatrix} (-4)3 \\ 6 \end{smallmatrix} \right]$	1.00000 000 $\left[\begin{smallmatrix} (-4)3 \\ 7 \end{smallmatrix} \right]$	∞

$$\sqrt{2\pi x} I_{\frac{19}{2}}(x) = f_9(x) e^{x-45x^{-1}}$$

$$\sqrt{2\pi x} I_{\frac{21}{2}}(x) = f_{10}(x) e^{x-55x^{-1}}$$

$$\sqrt{2x/\pi} K_{\frac{19}{2}}(x) = g_9(x) e^{-x+45x^{-1}}$$

$$\sqrt{2x/\pi} K_{\frac{21}{2}}(x) = g_{10}(x) e^{-x+55x^{-1}}$$

$\langle x \rangle =$ nearest integer to x .

Table 10.10
MODIFIED SPHERICAL BESSEL FUNCTIONS—VARIOUS ORDERS

n	$\sqrt{\frac{1}{2}} \pi/x I_{n+1/2}(x)$		
	$x=1$	$x=2$	$x=5$
0	(0) 1.17520 1194	(0) 1.81343 0204	(1) 1.48406 4212
1	(- 1) 3.67879 4412	(- 1) 9.74382 7436	(1) 1.18738 6128
2	(- 2) 7.15628 7013	(- 1) 3.51856 0886	(0) 7.71632 5346
3	(- 2) 1.00650 9052	(- 2) 9.47425 2220	(0) 4.15753 5935
4	(- 3) 1.10723 6461	(- 2) 2.02572 6087	(0) 1.89577 5037
5	(- 5) 9.99623 7520	(- 3) 3.58484 8301	(- 1) 7.45140 8690
6	(- 6) 7.65033 3778	(- 4) 5.40595 2086	(- 1) 2.56465 1251
7	(- 7) 5.08036 0873	(- 5) 7.09794 4523	(- 2) 7.83315 4364
8	(- 8) 2.97924 6909	(- 6) 8.24936 9394	(- 2) 2.14704 9422
9	(- 9) 1.56411 2692	(- 7) 8.59805 3854	(- 3) 5.33186 3294
10	(- 11) 7.43279 3549	(- 8) 8.12182 3211	(- 3) 1.20941 3702
11	(- 12) 3.22604 7141	(- 9) 7.01394 8275	(- 4) 2.52325 7454
12	(- 13) 1.28851 2381	(- 10) 5.57826 9483	(- 5) 4.87152 7330
13	(- 15) 4.76618 7751	(- 11) 4.11114 2138	(- 6) 8.74937 8858
14	(- 16) 1.64168 8672	(- 12) 2.82275 9636	(- 6) 1.46862 7470
15	(- 18) 5.29060 2725	(- 13) 1.81406 6530	(- 7) 2.31339 5316
16	(- 19) 1.60182 7153	(- 14) 1.09565 1449	(- 8) 3.43223 7424
17	(- 21) 4.57312 0086	(- 16) 6.24163 9390	(- 9) 4.81186 1587
18	(- 22) 1.23512 2995	(- 17) 3.36455 5792	(- 10) 6.39343 1309
19	(- 24) 3.16500 3796	(- 18) 1.72111 7468	(- 11) 8.07224 1852
20	(- 26) 7.71514 7565	(- 20) 8.37672 8478	(- 12) 9.70826 6441
30	(- 43) 5.65589 8686	(- 34) 6.21921 4440	(- 22) 6.36889 3001
40	(- 61) 1.55685 5122	(- 49) 1.74298 6176	(- 33) 1.63577 1994
50	(- 81) 3.65054 5412	(- 66) 4.17042 9214	(- 46) 3.64245 9664
100	(-190) 7.48149 1755	(-160) 9.55425 1030	(-120) 6.26113 6933
n	$x=10$	$x=50$	$x=100$
0	(3) 1.10132 3287	(19) 5.18470 5529	(41) 1.34405 8571
1	(2) 9.91190 9633	(19) 5.08101 1418	(41) 1.33061 7985
2	(2) 8.03965 9985	(19) 4.87984 4844	(41) 1.30414 0031
3	(2) 5.89207 9640	(19) 4.59302 6934	(41) 1.26541 0984
4	(2) 3.91520 4237	(19) 4.23682 1073	(41) 1.21556 1262
5	(2) 2.36839 5827	(19) 3.83039 9141	(41) 1.15601 0470
6	(2) 1.30996 8827	(19) 3.39413 3262	(41) 1.08840 0111
7	(1) 6.65436 3519	(19) 2.94792 4492	(41) 1.01451 8456
8	(1) 3.11814 2991	(19) 2.50975 5914	(40) 9.36222 3425
9	(1) 1.35352 0435	(19) 2.09460 7482	(40) 8.55360 6574
10	(0) 5.46454 1653	(19) 1.71380 5071	(40) 7.73703 8176
11	(0) 2.05966 6874	(19) 1.37480 9352	(40) 6.92882 8557
12	(- 1) 7.27307 8439	(19) 1.08139 2769	(40) 6.14340 7607
13	(- 1) 2.41397 2641	(18) 8.34112 9672	(40) 5.39297 6655
14	(- 2) 7.55352 3093	(18) 6.30971 7670	(40) 4.68730 3911
15	(- 2) 2.23450 9437	(18) 4.68149 3423	(40) 4.03365 8521
16	(- 3) 6.26543 8379	(18) 3.40719 1747	(40) 3.43686 9769
17	(- 3) 1.66914 7720	(18) 2.43274 6870	(40) 2.89949 1497
18	(- 4) 4.23421 3574	(18) 1.70426 8938	(40) 2.42204 7745
19	(- 4) 1.02488 6979	(18) 1.17158 7856	(40) 2.00333 3832
20	(- 5) 2.37154 3577	(17) 7.90430 4104	(40) 1.64074 7551
30	(-12) 1.22928 4325	(15) 5.67659 3929	(39) 1.30147 2327
40	(-21) 2.81471 5830	(12) 7.34905 8082	(37) 3.95371 9716
50	(-31) 5.88991 6154	(+ 9) 2.00489 8633	(35) 4.74095 0959
100	(-90) 9.54463 8661	(-17) 2.34189 3740	(20) 3.73598 8741

Table 10.10

MODIFIED SPHERICAL BESSEL FUNCTIONS—VARIOUS ORDERS

$\sqrt{\frac{1}{2}\pi/x}K_{n+\frac{1}{2}}(x)$			
n	$x=1$	$x=2$	$x=5$
0	(- 1) 5.77863 6749	(- 1) 1.06292 0829	(- 3) 2.11678 8479
1	(0) 1.15572 7350	(- 1) 1.59438 1243	(- 3) 2.54014 6175
2	(0) 4.04504 5724	(- 1) 3.45449 2694	(- 3) 3.64087 6184
3	(1) 2.13809 5597	(0) 1.02306 1298	(- 3) 6.18102 2359
4	(2) 1.53711 7375	(0) 3.92616 3812	(- 2) 1.22943 0749
5	(3) 1.40478 6594	(1) 1.86907 9845	(- 2) 2.83107 7584
6	(4) 1.56063 6427	(2) 1.06725 5553	(- 2) 7.45780 1433
7	(5) 2.04287 5221	(2) 7.12406 9079	(- 1) 2.22213 6131
8	(6) 3.07991 9195	(3) 5.44977 7364	(- 1) 7.41218 8536
9	(7) 5.25629 1384	(4) 4.70355 1451	(0) 2.74235 7715
10	(9) 1.00177 5282	(5) 4.52287 1652	(1) 1.11621 7817
11	(10) 2.10898 4384	(6) 4.79605 0749	(1) 4.96235 0604
12	(11) 4.86068 1836	(7) 5.56068 7078	(2) 2.39430 3059
13	(13) 1.21727 9443	(8) 6.99881 9354	(3) 1.24677 5036
14	(14) 3.29151 5179	(9) 9.50401 2999	(3) 6.97201 5499
15	(15) 9.55756 6814	(11) 1.38508 0704	(4) 4.16844 6493
16	(17) 2.96613 7227	(12) 2.15637 9105	(5) 2.65415 6981
17	(18) 9.79781 0417	(13) 3.57187 6330	(6) 1.79342 8072
18	(20) 3.43219 9783	(14) 6.27234 7368	(7) 1.28194 1220
19	(22) 1.27089 3701	(16) 1.16395 6139	(7) 9.66570 7838
20	(23) 4.95991 7633	(17) 2.27598 6819	(8) 7.66744 6235
30	(40) 4.55045 5450	(31) 2.06581 6824	(18) 7.97979 3303
40	(59) 1.24524 3351	(46) 5.55624 8963	(30) 2.35318 1718
50	(78) 4.25947 0196	(63) 1.86314 7755	(42) 8.49795 8757
100	(87) 1.04451 3645	(156) 4.08894 4237	(116) 2.49323 8041
n	$x=10$	$x=50$	$x=100$
0	(-6) 7.13140 4291	(-24) 6.05934 6353	(-46) 5.84348 1679
1	(-6) 7.84454 4720	(-24) 6.18053 3280	(-46) 5.90191 6495
2	(-6) 9.48476 7707	(-24) 6.43017 8350	(-46) 6.02053 9173
3	(-5) 1.25869 2857	(-24) 6.82355 1115	(-46) 6.20294 3454
4	(-5) 1.82956 1771	(-24) 7.38547 5506	(-46) 6.45474 5215
5	(-5) 2.90529 8451	(-24) 8.15293 6706	(-46) 6.78387 0523
6	(-5) 5.02539 0067	(-24) 9.17912 1581	(-46) 7.20097 0973
7	(-5) 9.43830 5538	(-23) 1.05395 0832	(-46) 7.71999 6750
8	(-4) 1.91828 4837	(-23) 1.23409 7408	(-46) 8.35897 0485
9	(-4) 4.20491 4777	(-23) 1.47354 3950	(-46) 9.14102 1732
10	(-4) 9.90762 2914	(-23) 1.79404 4109	(-45) 1.00957 6461
11	(-3) 2.50109 2290	(-23) 2.22704 2476	(-45) 1.12611 3230
12	(-3) 6.74327 4558	(-23) 2.81848 3648	(-45) 1.26858 2504
13	(-2) 1.93592 7868	(-23) 3.63628 4300	(-45) 1.44325 8856
14	(-2) 5.90133 2701	(-23) 4.78207 7170	(-45) 1.65826 2396
15	(-1) 1.90497 9270	(-23) 6.40988 9058	(-45) 1.92415 4951
16	(-1) 6.49556 9007	(-23) 8.75620 8386	(-45) 2.25475 0430
17	(0) 2.33403 5699	(-22) 1.21889 8659	(-45) 2.66822 2593
18	(0) 8.81868 1848	(-22) 1.72884 9900	(-45) 3.18862 8338
19	(1) 3.49631 5854	(-22) 2.49824 7585	(-45) 3.84801 5078
20	(2) 1.45175 0001	(-22) 3.67748 3017	(-45) 4.68935 4218
30	(9) 1.99043 6138	(-20) 4.72460 0057	(-44) 5.77221 5084
40	(17) 6.68871 7408	(-17) 3.32175 1557	(-42) 1.84121 2999
50	(27) 2.59020 6572	(-13) 1.10246 0162	(-40) 1.47876 1633
100	(85) 8.14750 7624	(+12) 5.97531 1344	(-25) 1.48279 6529

Table 10.11

AIRY FUNCTIONS

x	$Ai(-x)$	$Ai'(-x)$	$Bi(-x)$	$Bi'(-x)$	x	$Ai(-x)$	$Ai'(-x)$	$Bi(-x)$	$Bi'(-x)$
0.00	0.35502 805	-0.25881 940	0.61492 663	0.44828 836	0.50	0.47572 809	-0.20408 167	0.38035 266	0.50593 371
0.01	0.35761 619	-0.25880 157	0.61044 364	0.44831 896	0.51	0.47775 692	-0.20167 409	0.37528 379	0.50784 166
0.02	0.36020 397	-0.25874 771	0.60596 005	0.44841 015	0.52	0.47976 138	-0.19920 846	0.37019 579	0.50976 123
0.03	0.36279 102	-0.25865 731	0.60147 524	0.44856 104	0.53	0.48174 089	-0.19668 449	0.36508 853	0.51169 132
0.04	0.36537 699	-0.25852 986	0.59698 863	0.44877 074	0.54	0.48369 487	-0.19410 192	0.35996 193	0.51363 080
0.05	0.36796 149	-0.25836 484	0.59249 963	0.44903 833	0.55	0.48562 274	-0.19146 050	0.35481 589	0.51557 853
0.06	0.37054 416	-0.25816 173	0.58800 767	0.44936 293	0.56	0.48752 389	-0.18875 999	0.34965 033	0.51753 339
0.07	0.37312 460	-0.25792 001	0.58351 218	0.44974 364	0.57	0.48939 774	-0.18600 016	0.34446 520	0.51949 424
0.08	0.37570 243	-0.25763 918	0.57901 261	0.45017 955	0.58	0.49124 369	-0.18318 078	0.33926 043	0.52145 991
0.09	0.37827 725	-0.25731 872	0.57450 841	0.45066 976	0.59	0.49306 115	-0.18030 166	0.33403 599	0.52342 927
0.10	0.38084 867	-0.25695 811	0.56999 904	0.45121 336	0.60	0.49484 953	-0.17736 260	0.32879 184	0.52540 115
0.11	0.38341 628	-0.25655 685	0.56548 397	0.45180 945	0.61	0.49660 821	-0.17436 341	0.32352 796	0.52737 438
0.12	0.38597 967	-0.25611 443	0.56096 268	0.45245 712	0.62	0.49833 659	-0.17130 392	0.31824 435	0.52934 780
0.13	0.38853 843	-0.25563 033	0.55643 466	0.45315 546	0.63	0.50003 408	-0.16818 399	0.31294 101	0.53132 022
0.14	0.39109 213	-0.25510 406	0.55189 940	0.45390 355	0.64	0.50170 007	-0.16500 345	0.30761 795	0.53329 046
0.15	0.39364 037	-0.25453 511	0.54735 642	0.45470 047	0.65	0.50333 395	-0.16176 218	0.30227 521	0.53525 733
0.16	0.39618 269	-0.25392 297	0.54280 523	0.45554 530	0.66	0.50493 511	-0.15846 007	0.29691 282	0.53721 964
0.17	0.39871 868	-0.25326 716	0.53824 536	0.45643 713	0.67	0.50650 295	-0.15509 701	0.29153 084	0.53917 618
0.18	0.40124 789	-0.25256 716	0.53367 634	0.45737 503	0.68	0.50803 685	-0.15167 290	0.28612 932	0.54112 575
0.19	0.40376 987	-0.25182 250	0.52909 771	0.45835 806	0.69	0.50953 620	-0.14818 768	0.28070 835	0.54306 714
0.20	0.40628 419	-0.25103 267	0.52450 903	0.45938 529	0.70	0.51100 040	-0.14464 129	0.27526 801	0.54499 912
0.21	0.40879 038	-0.25019 720	0.51990 986	0.46045 578	0.71	0.51242 882	-0.14103 366	0.26980 840	0.54692 048
0.22	0.41128 798	-0.24931 559	0.51529 977	0.46156 860	0.72	0.51382 087	-0.13736 479	0.26432 964	0.54883 000
0.23	0.41377 653	-0.24838 737	0.51067 835	0.46272 279	0.73	0.51517 591	-0.13363 464	0.25883 185	0.55072 642
0.24	0.41625 557	-0.24741 206	0.50604 518	0.46391 740	0.74	0.51649 336	-0.12984 322	0.25331 516	0.55260 852
0.25	0.41872 461	-0.24638 919	0.50139 987	0.46515 148	0.75	0.51777 258	-0.12599 055	0.24777 973	0.55447 506
0.26	0.42118 319	-0.24531 828	0.49674 203	0.46642 408	0.76	0.51901 296	-0.12207 665	0.24222 571	0.55632 480
0.27	0.42363 082	-0.24419 888	0.49207 127	0.46773 423	0.77	0.52021 390	-0.11810 157	0.23665 329	0.55815 647
0.28	0.42606 701	-0.24303 053	0.48738 722	0.46908 095	0.78	0.52137 479	-0.11406 538	0.23106 265	0.55996 884
0.29	0.42849 126	-0.24181 276	0.48268 953	0.47046 327	0.79	0.52249 501	-0.10996 815	0.22545 398	0.56176 063
0.30	0.43090 310	-0.24054 513	0.47797 784	0.47188 022	0.80	0.52357 395	-0.10580 999	0.21982 751	0.56353 059
0.31	0.43330 200	-0.23922 719	0.47325 181	0.47333 081	0.81	0.52461 101	-0.10159 101	0.21418 345	0.56527 745
0.32	0.43568 747	-0.23785 851	0.46851 112	0.47481 405	0.82	0.52560 557	-0.09731 134	0.20852 204	0.56699 994
0.33	0.43805 900	-0.23643 865	0.46375 543	0.47632 895	0.83	0.52655 703	-0.09297 113	0.20284 354	0.56869 679
0.34	0.44041 607	-0.23496 718	0.45898 443	0.47787 450	0.84	0.52746 479	-0.08857 055	0.19714 820	0.57036 671
0.35	0.44275 817	-0.23344 368	0.45419 784	0.47944 970	0.85	0.52832 824	-0.08410 979	0.19143 630	0.57200 845
0.36	0.44508 477	-0.23186 773	0.44939 534	0.48105 354	0.86	0.52914 678	-0.07958 904	0.18570 813	0.57362 071
0.37	0.44739 535	-0.23023 893	0.44457 667	0.48268 500	0.87	0.52991 982	-0.07500 854	0.17996 399	0.57520 220
0.38	0.44968 937	-0.22855 687	0.43974 156	0.48434 307	0.88	0.53064 676	-0.07036 852	0.17420 419	0.57675 165
0.39	0.45196 631	-0.22682 116	0.43488 973	0.48602 670	0.89	0.53132 700	-0.06566 925	0.16842 906	0.57826 777
0.40	0.45422 561	-0.22503 141	0.43002 094	0.48773 486	0.90	0.53195 995	-0.06091 100	0.16263 895	0.57974 926
0.41	0.45646 675	-0.22318 723	0.42513 495	0.48946 652	0.91	0.53254 502	-0.05609 407	0.15683 420	0.58119 484
0.42	0.45868 918	-0.22128 826	0.42023 153	0.49122 062	0.92	0.53308 163	-0.05121 879	0.15101 518	0.58260 321
0.43	0.46089 233	-0.21933 412	0.41531 047	0.49299 611	0.93	0.53356 920	-0.04628 549	0.14518 226	0.58397 309
0.44	0.46307 567	-0.21732 447	0.41037 154	0.49479 193	0.94	0.53400 715	-0.04129 452	0.13933 585	0.58530 317
0.45	0.46523 864	-0.21525 894	0.40541 457	0.49660 702	0.95	0.53439 490	-0.03624 628	0.13347 634	0.58659 217
0.46	0.46738 066	-0.21313 721	0.40043 934	0.49844 031	0.96	0.53473 189	-0.03114 116	0.12760 415	0.58783 879
0.47	0.46950 119	-0.21095 893	0.39544 570	0.50029 070	0.97	0.53501 754	-0.02597 957	0.12171 971	0.58904 174
0.48	0.47159 965	-0.20872 379	0.39043 348	0.50215 713	0.98	0.53525 129	-0.02076 197	0.11582 346	0.59019 973
0.49	0.47367 548	-0.20643 147	0.38540 251	0.50403 850	0.99	0.53543 259	-0.01548 880	0.10991 587	0.59131 145
0.50	0.47572 809	-0.20408 167	0.38035 266	0.50593 371	1.00	0.53556 088	-0.01016 057	0.10399 739	0.59237 563
	$\begin{bmatrix} (-6)3 \\ 4 \end{bmatrix}$	$\begin{bmatrix} (-6)7 \\ 4 \end{bmatrix}$	$\begin{bmatrix} (-6)2 \\ 4 \end{bmatrix}$	$\begin{bmatrix} (-6)8 \\ 4 \end{bmatrix}$		$\begin{bmatrix} (-6)7 \\ 4 \end{bmatrix}$	$\begin{bmatrix} (-6)8 \\ 4 \end{bmatrix}$	$\begin{bmatrix} (-6)2 \\ 4 \end{bmatrix}$	$\begin{bmatrix} (-6)6 \\ 4 \end{bmatrix}$

AIRY FUNCTIONS

Table 10.11

x	$Ai(-x)$	$Ai'(-x)$	$Bi(-x)$	$Bi'(-x)$	x	$Ai(-x)$	$Ai'(-x)$	$Bi(-x)$	$Bi'(-x)$
1.0	0.53556 088	-0.01016 057	+0.10399 739	0.59237 563	5.5	+0.01778 154	0.86419 722	-0.36781 345	+0.02511 158
1.1	0.53381 051	+0.04602 915	+0.04432 659	0.60011 970	5.6	-0.06833 070	0.85003 256	-0.36017 223	-0.17783 760
1.2	0.52619 437	0.10703 157	-0.01582 137	0.60171 016	5.7	-0.15062 016	0.78781 722	-0.33245 825	-0.37440 903
1.3	0.51227 201	0.17199 181	-0.07576 964	0.59592 975	5.8	-0.22435 192	0.67943 152	-0.28589 021	-0.55300 203
1.4	0.49170 018	0.23981 912	-0.13472 406	0.58165 624	5.9	-0.28512 278	0.52962 857	-0.22282 969	-0.70247 952
1.5	0.46425 658	0.30918 697	-0.19178 486	0.55790 810	6.0	-0.32914 517	0.34593 549	-0.14669 838	-0.81289 879
1.6	0.42986 298	0.37854 219	-0.24596 320	0.52389 354	6.1	-0.35351 168	+0.13836 394	-0.06182 255	-0.87622 530
1.7	0.38860 704	0.44612 455	-0.29620 266	0.47906 134	6.2	-0.35642 107	-0.08106 856	+0.02679 081	-0.88697 896
1.8	0.34076 156	0.50999 763	-0.34140 583	0.42315 137	6.3	-0.33734 765	-0.29899 161	0.11373 701	-0.84276 110
1.9	0.28680 006	0.56809 172	-0.38046 588	0.35624 251	6.4	-0.29713 762	-0.50147 985	0.19354 136	-0.74461 387
2.0	0.22740 743	0.61825 902	-0.41230 259	0.27879 517	6.5	-0.23802 030	-0.67495 249	0.26101 266	-0.59717 067
2.1	0.16348 451	0.65834 069	-0.43590 235	0.19168 563	6.6	-0.16352 646	-0.80711 925	0.31159 995	-0.40856 734
2.2	0.09614 538	0.68624 482	-0.45036 098	+0.09622 919	6.7	-0.07831 247	-0.88790 797	0.34172 774	-0.19009 878
2.3	+0.02670 633	0.70003 366	-0.45492 823	-0.00581 106	6.8	+0.01210 452	-0.91030 401	0.34908 418	+0.04437 678
2.4	-0.04333 414	0.69801 760	-0.44905 228	-0.11223 237	6.9	0.10168 800	-0.87103 106	0.33283 784	0.27926 391
2.5	-0.11232 507	0.67885 273	-0.43242 247	-0.22042 015	7.0	0.18428 084	-0.77100 817	0.29376 207	0.49824 459
2.6	-0.17850 243	0.64163 799	-0.40500 828	-0.32739 717	7.1	0.25403 633	-0.61552 879	0.23425 088	0.68542 058
2.7	-0.24003 811	0.58600 720	-0.36709 211	-0.42989 534	7.2	0.30585 152	-0.41412 428	0.15821 739	0.82650 634
2.8	-0.29509 759	0.51221 098	-0.31929 389	-0.52445 040	7.3	0.33577 037	-0.18009 580	+0.07087 411	0.90998 427
2.9	-0.34190 510	0.42118 281	-0.26258 500	-0.60751 829	7.4	0.34132 375	+0.07027 632	-0.02159 652	0.92812 809
3.0	-0.37881 429	0.31458 377	-0.19828 963	-0.67561 122	7.5	0.32177 572	0.31880 951	-0.11246 349	0.87780 228
3.1	-0.40438 222	0.19482 045	-0.12807 165	-0.72544 957	7.6	0.27825 023	0.54671 882	-0.19493 376	0.76095 509
3.2	-0.41744 342	+0.06503 115	-0.05390 576	-0.75412 455	7.7	0.21372 037	0.73605 242	-0.26267 007	0.58474 045
3.3	-0.41718 094	-0.07096 362	+0.02196 800	-0.75926 518	7.8	0.13285 154	0.87115 540	-0.31030 057	0.36122 930
3.4	-0.40319 048	-0.20874 905	0.09710 619	-0.73920 163	7.9	+0.04170 188	0.94004 300	-0.33387 856	+0.10670 215
3.5	-0.37553 382	-0.34344 343	0.16893 984	-0.69311 628	8.0	-0.05270 505	0.93556 094	-0.33125 158	-0.15945 050
3.6	-0.33477 748	-0.46986 397	0.23486 631	-0.62117 283	8.1	-0.14290 815	0.85621 859	-0.30230 331	-0.41615 664
3.7	-0.28201 306	-0.58272 780	0.29235 261	-0.52461 361	8.2	-0.22159 945	0.70659 870	-0.24904 019	-0.64232 293
3.8	-0.21885 598	-0.67688 257	0.33904 647	-0.40581 592	8.3	-0.28223 176	0.49727 679	-0.17550 556	-0.81860 044
3.9	-0.14741 991	-0.74755 809	0.37289 058	-0.26829 836	8.4	-0.31959 219	+0.24422 089	-0.08751 798	-0.92910 958
4.0	-0.07026 553	-0.79062 858	0.39223 471	-0.11667 057	8.5	-0.33029 024	-0.03231 335	+0.00775 444	-0.96296 917
4.1	+0.00967 698	-0.80287 254	0.39593 974	+0.04347 872	8.6	-0.31311 245	-0.30933 027	0.10235 647	-0.91547 918
4.2	0.08921 076	-0.78221 561	0.38346 736	0.20575 691	8.7	-0.26920 454	-0.56297 685	0.18820 363	-0.78882 623
4.3	0.16499 781	-0.72794 081	0.35494 906	0.36520 468	8.8	-0.20205 445	-0.77061 301	0.25778 240	-0.59221 371
4.4	0.23370 326	-0.64085 018	0.31122 860	0.50858 932	8.9	-0.11726 631	-0.91289 276	0.30483 241	-0.34136 475
4.5	0.29215 278	-0.52336 253	0.25387 266	0.63474 477	9.0	-0.02213 372	-0.97566 398	0.32494 732	-0.05740 051
4.6	0.33749 598	-0.37953 391	0.18514 576	0.73494 444	9.1	+0.07495 989	-0.95149 682	0.31603 471	+0.23484 379
4.7	0.36736 748	-0.21499 018	0.10794 695	0.80328 926	9.2	0.16526 800	-0.84067 107	0.27858 425	0.50894 402
4.8	0.38003 668	-0.03676 510	+0.02570 779	0.83508 976	9.3	0.24047 380	-0.65149 241	0.21570 835	0.73928 028
4.9	0.37453 635	+0.14695 743	-0.05774 655	0.82721 903	9.4	0.29347 756	-0.39986 237	0.13293 876	0.90348 537
5.0	0.35076 101	0.32719 282	-0.13836 913	0.77841 177	9.5	0.31910 325	-0.10809 532	+0.03778 543	0.98471 407
5.1	0.30952 600	0.49458 600	-0.21208 913	0.68948 513	9.6	0.31465 158	+0.19695 044	-0.06091 293	0.97349 918
5.2	0.25258 034	0.63990 517	-0.27502 704	0.56345 898	9.7	0.28823 750	0.48628 629	-0.15379 421	0.86898 283
5.3	0.18256 793	0.75457 542	-0.32371 608	0.40555 694	9.8	0.21886 743	0.73154 486	-0.23186 331	0.67936 774
5.4	0.10293 460	0.83122 307	-0.35531 708	0.22307 496	9.9	0.13623 503	0.90781 333	-0.28738 356	0.42147 209
5.5	0.01778 154	0.86419 722	-0.36781 345	0.02511 158	10.0	0.04024 124	0.99626 504	-0.31467 983	0.11941 411
	$\left[\begin{smallmatrix} (-3)2 \\ 8 \end{smallmatrix} \right]$	$\left[\begin{smallmatrix} (-3)5 \\ 8 \end{smallmatrix} \right]$	$\left[\begin{smallmatrix} (-3)2 \\ 8 \end{smallmatrix} \right]$	$\left[\begin{smallmatrix} (-3)5 \\ 9 \end{smallmatrix} \right]$		$\left[\begin{smallmatrix} (-3)4 \\ 9 \end{smallmatrix} \right]$	$\left[\begin{smallmatrix} (-2)1 \\ 10 \end{smallmatrix} \right]$	$\left[\begin{smallmatrix} (-3)4 \\ 9 \end{smallmatrix} \right]$	$\left[\begin{smallmatrix} (-2)1 \\ 10 \end{smallmatrix} \right]$

AIRY FUNCTIONS—AUXILIARY FUNCTIONS FOR LARGE NEGATIVE ARGUMENTS

ζ^{-1}	x	$f_1(\zeta)$	$f_2(\zeta)$	$g_1(\zeta)$	$g_2(\zeta)$	$\langle \zeta \rangle$
0.05	9.654894	0.39752 21	0.40028 87	0.40092 31	0.39704 87	20
0.04	11.203512	0.39781 14	0.40002 58	0.40052 06	0.39741 99	25
0.03	13.572088	0.39809 83	0.39975 97	0.40012 11	0.39779 49	33
0.02	17.784467	0.39838 24	0.39949 03	0.39972 48	0.39817 37	50
0.01	28.231081	0.39866 38	0.39921 79	0.39933 19	0.39855 62	100
0.00	∞	0.39894 23	0.39894 23	0.39894 23	0.39894 23	∞
		$\left[\begin{smallmatrix} (-7)4 \\ 3 \end{smallmatrix} \right]$	$\left[\begin{smallmatrix} (-7)4 \\ 3 \end{smallmatrix} \right]$	$\left[\begin{smallmatrix} (-7)4 \\ 3 \end{smallmatrix} \right]$	$\left[\begin{smallmatrix} (-7)5 \\ 3 \end{smallmatrix} \right]$	

$$Ai(-x) = x^{-\frac{1}{4}} [f_1(\zeta) \cos \zeta + f_2(\zeta) \sin \zeta] \quad Bi(-x) = x^{-\frac{1}{4}} [f_2(\zeta) \cos \zeta - f_1(\zeta) \sin \zeta]$$

$$Ai'(-x) = x^{\frac{1}{4}} [g_1(\zeta) \sin \zeta - g_2(\zeta) \cos \zeta] \quad Bi'(-x) = x^{\frac{1}{4}} [g_1(\zeta) \cos \zeta + g_2(\zeta) \sin \zeta]$$

$\zeta = \frac{2}{3} x^{\frac{3}{2}}$ $\langle \zeta \rangle =$ nearest integer to ζ .

Table 10.12 INTEGRALS OF AIRY FUNCTIONS

x	$\int_0^x Ai(t) dt$	$\int_0^x Ai(-t) dt$	$\int_0^x Bi(t) dt$	$\int_0^x Bi(-t) dt$	x	$\int_0^x Ai(t) dt$	$\int_0^x Ai(-t) dt$	$\int_0^x Bi(-t) dt$
0.0	0.00000 30	0.00000 00	0.00000 00	0.00000 00	5.0	0.33328 76	-0.71788 22	-0.15873 09
0.1	0.03421 01	-0.03679 54	0.06373 67	-0.05924 87	5.1	0.33329 73	-0.75103 62	-0.14113 39
0.2	0.06585 15	-0.07615 70	0.13199 45	-0.11398 10	5.2	0.33330 50	-0.77926 27	-0.11667 30
0.3	0.09497 09	-0.11802 51	0.20487 68	-0.16411 57	5.3	0.33331 11	-0.80111 58	-0.08660 41
0.4	0.12194 06	-0.16229 44	0.28256 70	-0.20952 89	5.4	0.33331 59	-0.81545 49	-0.05250 03
0.5	0.14595 33	-0.20880 95	0.36533 85	-0.25006 28	5.5	0.33331 97	-0.82151 82	-0.01617 86
0.6	0.16801 79	-0.25736 07	0.45356 50	-0.28553 62	5.6	0.33332 27	-0.81897 90	+0.02038 99
0.7	0.18795 52	-0.30768 05	0.54773 36	-0.31575 56	5.7	0.33332 50	-0.80797 96	0.05518 54
0.8	0.20589 45	-0.35944 15	0.64845 82	-0.34052 58	5.8	0.33332 69	-0.78914 06	0.08625 18
0.9	0.22196 97	-0.41225 56	0.75649 64	-0.35966 27	5.9	0.33332 83	-0.76354 19	0.11181 25
1.0	0.23631 73	-0.46567 40	0.87276 91	-0.37300 50	6.0	0.33332 95	-0.73267 53	0.13038 11
1.1	0.24907 33	-0.51918 94	0.99838 41	-0.38042 77	6.1	0.33333 03	-0.69836 93	0.14086 00
1.2	0.26037 12	-0.57224 05	1.13466 38	-0.38185 43	6.2	0.33333 10	-0.66268 96	0.14262 05
1.3	0.27034 09	-0.62421 79	1.28318 00	-0.37726 99	6.3	0.33333 16	-0.62781 93	0.13555 73
1.4	0.27910 66	-0.67447 31	1.44579 42	-0.36673 34	6.4	0.33333 20	-0.59592 62	0.12011 15
1.5	0.28678 67	-0.72232 88	1.62470 81	-0.35038 81	6.5	0.33333 23	-0.56902 35	0.09726 08
1.6	0.29349 24	-0.76709 26	1.82252 33	-0.32847 24	6.6	0.33333 25	-0.54885 59	0.06847 29
1.7	0.29932 75	-0.80807 24	2.04231 52	-0.30132 67	6.7	0.33333 27	-0.52667 65	0.03562 42
1.8	0.30438 82	-0.84459 41	2.28772 12	-0.26939 97	6.8	0.33333 29	-0.50334 74	+0.00088 60
1.9	0.30876 29	-0.87602 06	2.56304 90	-0.23325 04	6.9	0.33333 30	-0.47906 98	-0.03340 40
2.0	0.31253 28	-0.90177 28	2.87340 83	-0.19354 74	7.0	0.33333 31	-0.455345 17	-0.06491 67
2.1	0.31577 11	-0.92135 09	.	-0.15106 46	7.1	0.33333 31	-0.432549 72	-0.09147 36
2.2	0.31854 43	-0.93435 56	.	-0.10667 18	7.2	0.33333 32	-0.410635 96	-0.11121 47
2.3	0.32091 19	-0.94050 97	.	-0.06132 23	7.3	0.33333 32	-0.38593 60	-0.12273 90
2.4	0.32292 74	-0.93967 67	.	-0.01603 45	7.4	0.33333 33	-0.361999 96	-0.12521 80
2.5	0.32463 80	-0.93187 78	.	+0.02812 94	7.5	0.33333 33	-0.70336 19	-0.11847 31
2.6	0.32608 57	-0.91730 54	.	0.07009 01	7.6	.	-0.73355 34	-0.10300 57
2.7	0.32730 74	-0.89633 20	.	0.10878 06	7.7	.	-0.75830 99	-0.07997 85
2.8	0.32833 55	-0.86951 37	.	0.14317 88	7.8	.	-0.77575 13	-0.05114 35
2.9	0.32919 83	-0.83758 77	.	0.17234 20	7.9	.	-0.78453 65	-0.01872 22
3.0	0.32992 04	-0.80146 29	.	0.19544 25	8.0	.	-0.78398 26	+0.01475 64
3.1	0.33052 31	-0.76220 32	.	0.21180 21	8.1	.	-0.77413 57	0.04664 84
3.2	0.33102 49	-0.72100 37	.	0.22092 49	8.2	.	-0.75578 95	0.07440 43
3.3	0.33144 15	-0.67915 91	.	0.22252 61	8.3	.	-0.73041 93	0.09577 87
3.4	0.33178 65	-0.63802 56	.	0.21655 57	8.4	.	-0.70011 70	0.10902 22
3.5	0.33207 15	-0.59897 71	.	0.20321 50	8.5	.	-0.66739 21	0.11303 86
3.6	0.33230 63	-0.56335 61	.	0.18296 47	8.6	.	-0.63499 08	0.10749 35
3.7	0.33249 93	-0.53242 25	.	0.15652 33	8.7	.	-0.60566 32	0.09285 98
3.8	0.33265 76	-0.50730 05	.	0.12485 43	8.8	.	-0.58192 70	0.07039 64
3.9	0.33278 70	-0.48892 77	.	0.08914 28	8.9	.	-0.56584 22	0.04205 63
4.0	0.33289 27	-0.47800 75	.	+0.05076 01	9.0	.	-0.55881 97	+0.01033 04
4.1	0.33297 86	-0.47496 79	.	+0.01121 78	9.1	.	-0.56148 12	-0.02196 26
4.2	0.33304 84	-0.47992 95	.	-0.02788 79	9.2	.	-0.57358 51	-0.05192 24
4.3	0.33310 50	-0.49268 51	.	-0.06494 00	9.3	.	-0.59403 00	-0.07682 93
4.4	0.33315 07	-0.51269 28	.	-0.09837 02	9.4	.	-0.62093 76	-0.09439 87
4.5	0.33318 76	-0.53908 35	.	-0.12673 04	9.5	.	-0.65181 01	-0.10300 27
4.6	0.33321 73	-0.57068 59	.	-0.14876 50	9.6	.	-0.68375 25	-0.10183 70
4.7	0.33324 11	-0.60606 63	.	-0.16347 66	9.7	.	-0.71733 85	-0.09101 44
4.8	0.33326 02	-0.64358 51	.	-0.17018 59	9.8	.	-0.73889 84	-0.07157 33
4.9	0.33327 54	-0.68146 70	.	-0.16857 74	9.9	.	-0.75680 07	-0.04539 57
5.0	0.33328 76	-0.71788 22	.	-0.15873 09	10.0	.	-0.76569 84	-0.01504 04

Table 10.13 ZEROS AND ASSOCIATED VALUES OF AIRY FUNCTIONS AND THEIR DERIVATIVES

s	a_s	$Ai'(a_s)$	a'_s	$Ai(a'_s)$	b_s	$Bi'(b_s)$	b'_s	$Bi(b'_s)$
1	-2.33810 741	+0.70121 082	-1.01879 297	+0.53565 666	-1.17371 322	+0.60195 789	-2.29443 968	-0.45494 438
2	-4.08794 944	-0.80311 137	-3.24819 758	-0.41901 548	-3.27109 330	-0.76031 014	-4.07315 509	+0.39652 284
3	-5.52055 983	+0.86520 403	-4.82009 921	+0.38040 647	-4.83073 784	+0.83699 101	-5.51239 573	+0.36796 916
4	-6.78670 809	-0.91085 074	-6.16330 736	-0.35790 794	-6.16985 213	-0.88947 990	-6.78129 445	+0.34949 912
5	-7.94413 359	+0.94733 571	-7.37217 726	+0.34230 124	-7.37676 208	+0.92998 364	-7.94017 869	-0.33602 624
6	-9.02265 085	-0.97792 281	-8.48848 673	-0.33047 623	-8.49194 885	-0.96323 443	-9.01958 336	+0.32550 974
7	-10.04017 434	+1.00437 012	-9.53544 905	+0.32102 229	-9.53819 438	+0.99158 637	-10.03769 633	-0.31693 465
8	-11.00852 430	-1.02773 869	-10.52766 040	-0.31318 539	-10.52991 351	-1.01638 966	-11.00646 267	+0.30972 594
9	-11.93601 556	+1.04872 065	-11.47505 663	+0.30651 729	-11.47695 355	+1.03849 429	-11.93426 165	-0.30352 766
10	-12.82877 675	-1.06779 386	-12.38478 837	-0.30073 083	-12.38641 714	-1.05847 184	-12.82725 831	+0.29810 491

AUXILIARY TABLE—COMPLEX ZEROS AND ASSOCIATED VALUES OF $Bi(z)$ AND $Bi'(z)$

s	$e^{-\pi i/3\beta_s}$		$Bi'(\beta_s)$		$e^{-\pi i/3\beta'_s}$		$Bi(\beta'_s)$	
	Modulus	Phase	Modulus	Phase	Modulus	Phase	Modulus	Phase
1	2.354	0.095	0.993	+2.641	1.121	0.331	0.750	+0.466
2	4.093	0.042	1.136	-0.513	3.257	0.059	0.592	-2.632
3	5.524	0.027	1.224	+2.625	4.824	0.033	0.538	+0.515
4	6.789	0.020	1.288	-0.519	6.166	0.023	0.506	-2.624
5	7.946	0.015	1.340	+2.622	7.374	0.017	0.484	+0.519

From J. C. P. Miller, The Airy integral, British Assoc. Adv. Sci. Mathematical Tables Part—vol. B. Cambridge Univ. Press, Cambridge, England, 1946 and F. W. J. Olver, The asymptotic expansion of Bessel functions of large order. Philos. Trans. Roy. Soc. London [A] 247, 328–368, 1954 (with permission).

11. Integrals of Bessel Functions

YUDELL L. LUKE¹

Contents

	Page
Mathematical Properties	480
11.1. Simple Integrals of Bessel Functions	480
11.2. Repeated Integrals of $J_n(z)$ and $K_0(z)$	482
11.3. Reduction Formulas for Indefinite Integrals	483
11.4. Definite Integrals	485
Numerical Methods	488
11.5. Use and Extension of the Tables	488
References	490
Table 11.1 Integrals of Bessel Functions	492

$$\left. \begin{array}{l} \int_0^x J_0(t)dt, \int_0^x Y_0(t)dt, 10D \\ e^{-x} \int_0^x I_0(t)dt, e^x \int_x^\infty K_0(t)dt, 7D \end{array} \right\} x=0(.1)10$$

Table 11.2 Integrals of Bessel Functions	494
---	-----

$$\left. \begin{array}{l} \int_0^x \frac{[1-J_0(t)]dt}{t}, \int_x^\infty \frac{Y_0(t)dt}{t}, 8D \\ e^{-x} \int_0^x \frac{[I_0(t)-1]dt}{t}, 8D; xe^x \int_x^\infty \frac{K_0(t)dt}{t}, 6D \end{array} \right\} x=0(.1)5$$

The author acknowledges the assistance of Geraldine Coombs, Betty Kahn, Marilyn Kemp, Betty Ruhlman, and Anna Lee Samuels for checking formulas and developing numerical examples, only a portion of which could be accommodated here.

¹ Midwest Research Institute. (Prepared under contract with the National Bureau of Standards.)

11. Integrals of Bessel Functions

Mathematical Properties

11.1. Simple Integrals of Bessel Functions

$$\int_0^z t^\mu J_\nu(t) dt$$

11.1.1

$$\int_0^z t^\mu J_\nu(t) dt = \frac{z^\mu \Gamma\left(\frac{\nu+\mu+1}{2}\right)}{\Gamma\left(\frac{\nu-\mu+1}{2}\right)}$$

$$\times \sum_{k=0}^{\infty} \frac{(\nu+2k+1) \Gamma\left(\frac{\nu-\mu+1}{2} + k\right)}{\Gamma\left(\frac{\nu+\mu+3}{2} + k\right)} J_{\nu+2k+1}(z) \quad (\Re(\mu+\nu+1) > 0)$$

11.1.2

$$\int_0^z J_\nu(t) dt = 2 \sum_{k=0}^{\infty} J_{\nu+2k+1}(z) \quad (\Re \nu > -1)$$

11.1.3 $\int_0^z J_{2n}(t) dt = \int_0^z J_0(t) dt - 2 \sum_{k=0}^{n-1} J_{2k+1}(z)$

11.1.4 $\int_0^z J_{2n+1}(t) dt = 1 - J_0(z) - 2 \sum_{k=1}^n J_{2k}(z)$

Recurrence Relations

11.1.5

$$\int_0^z J_{n+1}(t) dt = \int_0^z J_{n-1}(t) dt - 2J_n(z) \quad (n > 0)$$

11.1.6 $\int_0^z J_1(t) dt = 1 - J_0(z)$

$$\int J_0(t) dt, \int Y_0(t) dt, \int I_0(t) dt, \int K_0(t) dt$$

11.1.7

$$\int_0^z \mathcal{C}_0(t) dt = x \mathcal{C}_0(x) + \frac{1}{2} \pi x \{ \mathbf{H}_0(x) \mathcal{C}_1(x) - \mathbf{H}_1(x) \mathcal{C}_0(x) \}$$

$$\mathcal{C}_\nu(x) = A J_\nu(x) + B Y_\nu(x), \nu = 0, 1$$

A and B are constants.

11.1.8

$$\int_0^z Z_0(t) dt = x Z_0(x) + \frac{1}{2} \pi x \{ -\mathbf{L}_0(x) Z_1(x) + \mathbf{L}_1(x) Z_0(x) \}$$

$$Z_\nu(x) = A I_\nu(x) + B e^{i\nu\pi} K_\nu(x), \nu = 0, 1$$

A and B are constants.

$\mathbf{H}_\nu(x)$ and $\mathbf{L}_\nu(x)$ are Struve functions (see chapter 12).

11.1.9

$$\int_0^z K_0(t) dt = -\left(\gamma + \ln \frac{x}{2}\right) x \sum_{k=0}^{\infty} \frac{(x/2)^{2k}}{(k!)^2 (2k+1)} + x \sum_{k=0}^{\infty} \frac{(x/2)^{2k}}{(k!)^2 (2k+1)^2} + x \sum_{k=1}^{\infty} \frac{(x/2)^{2k}}{(k!)^2 (2k+1)} \left(1 + \frac{1}{2} + \dots + \frac{1}{k}\right)$$

$$\gamma \text{ (Euler's constant)} = .57721\ 56649 \dots$$

In this and all other integrals of 11.1, x is real and positive although all the results remain valid for extended portions of the complex plane unless stated to the contrary.

11.1.10

$$\int_0^{-iz} K_0(t) dt = \frac{\pi}{2} \int_0^z J_0(t) dt + i \frac{\pi}{2} \int_0^z Y_0(t) dt$$

Asymptotic Expansions

11.1.11

$$\int_x^\infty [J_0(t) + i Y_0(t)] dt \sim \left(\frac{2}{\pi x}\right)^{\frac{1}{2}} e^{i(x-\pi/4)} \times \left[\sum_{k=0}^{\infty} (-)^k a_{2k+1} x^{-2k-1} + i \sum_{k=0}^{\infty} (-)^k a_{2k} x^{-2k} \right]$$

11.1.12 $a_k = \frac{\Gamma(k+\frac{1}{2})}{\Gamma(\frac{1}{2})} \sum_{s=0}^k \frac{\Gamma(s+\frac{1}{2})}{2^s s! \Gamma(\frac{1}{2})}$

11.1.13

$$2(k+1)a_{k+1} = 3 \left(k + \frac{1}{2}\right) \left(k + \frac{5}{6}\right) a_k - \left(k + \frac{1}{2}\right)^2 \left(k - \frac{1}{2}\right) a_{k-1}$$

11.1.14 $x^{\frac{1}{2}}e^{-x} \int_0^x I_0(t)dt \sim (2\pi)^{-\frac{1}{2}} \sum_{k=0}^{\infty} a_k x^{-k}$

where the a_k are defined as in 11.1.12.

11.1.15 $x^{\frac{1}{2}}e^x \int_x^{\infty} K_0(t)dt \sim \left(\frac{\pi}{2}\right)^{\frac{1}{2}} \sum_{k=0}^{\infty} (-)^k a_k x^{-k}$

where the a_k are defined as in 11.1.12.

Polynomial Approximations²

11.1.16 $8 \leq x \leq \infty$

$$\int_x^{\infty} [J_0(t) + iY_0(t)]dt$$

$$= x^{-\frac{1}{2}} e^{i(x-\pi/4)} \left[\sum_{k=0}^7 (-)^k a_k (x/8)^{-2k-1} + i \sum_{k=0}^7 (-)^k b_k (x/8)^{-2k} + \epsilon(x) \right]$$

$$|\epsilon(x)| \leq 2 \times 10^{-9}$$

k	a_k	b_k
0	.06233 47304	.79788 45600
1	.00404 03539	.01256 42405
2	.00100 89872	.00178 70944
3	.00053 66169	.00067 40148
4	.00039 92825	.00041 00676
5	.00027 55037	.00025 43955
6	.00012 70039	.00011 07299
7	.00002 68482	.00002 26238

11.1.17 $8 \leq x \leq \infty$

$$x^{\frac{1}{2}}e^{-x} \int_0^x I_0(t) dt = \sum_{k=0}^6 d_k (x/8)^{-k} + \epsilon(x)$$

$$|\epsilon(x)| \leq 2 \times 10^{-9}$$

k	d_k
0	.39894 23
1	.03117 34
2	.00591 91
3	.00559 56
4	-.01148 58
5	.01774 40
6	-.00739 95

² Approximation 11.1.16 is from A. J. M. Hitchcock. Polynomial approximations to Bessel functions of order zero and one and to related functions, Math. Tables Aids Comp. 11, 86-88 (1957) (with permission).

11.1.18 $7 \leq x \leq \infty$

$$x^{\frac{1}{2}}e^x \int_x^{\infty} K_0(t)dt = \sum_{k=0}^6 (-)^k e_k (x/7)^{-k} + \epsilon(x)$$

$$|\epsilon(x)| \leq 2 \times 10^{-7}$$

k	e_k
0	1.25331 414
1	0.11190 289
2	.02576 646
3	.00933 994
4	.00417 454
5	.00163 271
6	.00033 934

$$\frac{\int J_0(t)dt}{t}, \frac{\int Y_0(t)dt}{t}, \frac{\int K_0(t)dt}{t}$$

11.1.19

$$\int_0^x \frac{1-J_0(t)}{t} dt$$

$$= 2x^{-1} \sum_{k=0}^{\infty} (2k+3) [\psi(k+2) - \psi(1)] J_{2k+3}(x)$$

$$= 1 - 2x^{-1} J_1(x)$$

$$+ 2x^{-1} \sum_{k=0}^{\infty} (2k+5) [\psi(k+3) - \psi(1) - 1] J_{2k+5}(x)$$

For $\psi(z)$, see 6.3.

11.1.20

$$\int_x^{\infty} \frac{J_0(t)dt}{t} + \gamma + \ln \frac{x}{2} = \int_0^x \frac{[1-J_0(t)]dt}{t}$$

$$= - \sum_{k=1}^{\infty} \frac{(-)^k \left(\frac{x}{2}\right)^{2k}}{2k(k!)^2}$$

11.1.21

$$\int_x^{\infty} \frac{Y_0(t)dt}{t} = -\frac{1}{\pi} \left(\ln \frac{x}{2}\right)^2 - \frac{2\gamma}{\pi} \left(\ln \frac{x}{2}\right) + \frac{1}{\pi} \left(\frac{\pi^2}{6} - \gamma^2\right)$$

$$+ \frac{2}{\pi} \sum_{k=1}^{\infty} \frac{(-)^k \left(\frac{x}{2}\right)^{2k}}{2k(k!)^2} \left\{ \psi(k+1) + \frac{1}{2k} - \ln \frac{x}{2} \right\}$$

11.1.22

$$\int_x^{\infty} \frac{K_0(t)dt}{t} = \frac{1}{2} \left(\ln \frac{x}{2}\right)^2 + \gamma \ln \frac{x}{2} + \frac{\pi^2}{24} + \frac{\gamma^2}{2}$$

$$- \sum_{k=1}^{\infty} \frac{\left(\frac{x}{2}\right)^{2k}}{2k(k!)^2} \left\{ \psi(k+1) + \frac{1}{2k} - \ln \frac{x}{2} \right\}$$

11.1.23

$$\int_{-ix}^{-i\infty} \frac{K_0(t)dt}{t} = \frac{i\pi}{2} \int_x^{\infty} \frac{J_0(t)dt}{t} - \frac{\pi}{2} \int_x^{\infty} \frac{Y_0(t)dt}{t}$$

Asymptotic Expansions

$$11.1.24 \int_x^\infty \frac{\mathcal{C}_0(t)dt}{t} = \frac{2g_1(x)\mathcal{C}_0(x)}{x^2} - \frac{g_0(x)\mathcal{C}_1(x)}{x}$$

where

$$g_0(x) \sim \sum_{k=0}^\infty (-)^k \left(\frac{x}{2}\right)^{-2k} (k!)^2,$$

$$g_1(x) \sim \sum_{k=0}^\infty (-)^k \left(\frac{x}{2}\right)^{-2k} k!(k+1)!$$

$$11.1.25 \quad g_0(x) = 2x^2 \int_x^\infty \frac{g_1(t)dt}{t^3}$$

$$11.1.26 \quad x^{3/2}e^x \int_x^\infty \frac{K_0(t)dt}{t} \sim \left(\frac{\pi}{2}\right)^{1/2} \sum_{k=0}^\infty (-)^k c_k x^{-k}$$

where

$$11.1.27 \quad c_0 = 1, c_1 = \frac{13}{8}$$

$$2(k+1)c_{k+1} = \left[3(k+1)^2 + \frac{1}{4}\right]c_k - \left(k + \frac{1}{2}\right)^3 c_{k-1}$$

$$11.1.28 \quad x^{3/2}e^{-x} \int_0^x \frac{[I_0(t)-1]dt}{t} \sim (2\pi)^{-1/2} \sum_{k=0}^\infty c_k x^{-k}$$

where c_k is defined as in 11.1.27.

Polynomial Approximations

$$11.1.29 \quad 5 \leq x \leq \infty$$

$$\int_x^\infty \frac{\mathcal{C}_0(t)dt}{t} = \frac{2g_1(x)\mathcal{C}_0(x)}{x^2} - \frac{g_0(x)\mathcal{C}_1(x)}{x}$$

where

$$g_0(x) = \sum_{k=0}^9 (-)^k a_k (x/5)^{-2k} + \epsilon(x),$$

$$g_1(x) = \sum_{k=0}^9 (-)^k b_k (x/5)^{-2k} + \epsilon(x)$$

$$|\epsilon(x)| \leq 2 \times 10^{-7}$$

k	a_k	b_k
0	1.0	1.0
1	0.15999 2815	0.31998 5629
2	.10161 9385	.30485 8155
3	.13081 1585	.52324 6341
4	.20740 4022	1.03702 0112
5	.28330 0508	1.69980 3050
6	.27902 9488	1.95320 6413
7	.17891 5710	1.43132 5684
8	.06622 8328	0.59605 4956
9	.01070 2234	.10702 2336

$$11.1.30 \quad 4 \leq x \leq \infty$$

$$x^{3/2}e^x \int_x^\infty \frac{K_0(t)dt}{t} = \sum_{k=0}^6 (-)^k d_k \left(\frac{x}{4}\right)^{-k} + \epsilon(x)$$

$$|\epsilon(x)| \leq 6 \times 10^{-6}$$

k	d_k
0	1.25331 41
1	0.50913 39
2	.32191 84
3	.26214 46
4	.20601 26
5	.11103 96
6	.02724 00

$$11.1.31 \quad 5 \leq x \leq \infty$$

$$x^{3/2}e^{-x} \int_0^x \frac{[I_0(t)-1]dt}{t} = \sum_{k=0}^{10} f_k \left(\frac{x}{5}\right)^{-k} + \epsilon(x)$$

$$|\epsilon(x)| \leq 1.1 \times 10^{-5}$$

k	f_k
0	0.39893 14
1	.13320 55
2	-.04938 43
3	1.47800 44
4	-8.65560 13
5	28.12214 78
6	-48.05241 15
7	40.39473 40
8	-11.90943 95
9	-3.51950 09
10	2.19454 64

11.2. Repeated Integrals of $J_n(z)$ and $K_0(z)$

Repeated Integrals of $J_n(z)$

Let

$$11.2.1$$

$$f_{0,n}(z) = J_n(z),$$

$$f_{1,n}(z) = \int_0^z J_n(t)dt, \dots, f_{r,n}(z) = \int_0^z f_{r-1,n}(t)dt$$

$$11.2.2$$

$$f_{-r,n}(z) = \frac{d^r}{dz^r} J_n(z)$$

Then

$$11.2.3$$

$$f_{r,n}(z) = \frac{1}{\Gamma(r)} \int_0^z (z-t)^{r-1} J_n(t)dt \quad (\Re r > 0)$$

$$11.2.4 \quad f_{r,n}(z) = \frac{2^r}{\Gamma(r)} \sum_{k=0}^\infty \frac{\Gamma(k+r)}{k!} J_{n+r+2k}(z)$$

Recurrence Relations

11.2.5

$$r(r-1)f_{r+1, n}(z) = 2(r-1)zf_{r, n}(z) - [(1-r)^2 - n^2 + z^2]f_{r-1, n}(z) + (2r-3)zf_{r-2, n}(z) - z^2f_{r-3, n}(z)$$

11.2.6

$$rf_{r+1, 0}(z) = zf_{r, 0}(z) - (r-1)f_{r-1, 0}(z) + zf_{r-2, 0}(z)$$

11.2.7

$$f_{r+1, n+1}(z) = f_{r+1, n-1}(z) - 2f_{r, n}(z)$$

Repeated Integrals of $K_0(z)$

Let

11.2.8

$$Ki_0(z) = K_0(z),$$

$$Ki_1(z) = \int_z^\infty K_0(t)dt, \dots, Ki_r(z) = \int_z^\infty Ki_{r-1}(t)dt$$

11.2.9

$$Ki_{-r}(z) = (-1)^r \frac{d^r}{dz^r} K_0(z)$$

Then

11.2.10

$$Ki_r(z) = \int_0^\infty \frac{e^{-z \cosh t} dt}{\cosh^r t} \quad (\Re z \geq 0, \Re r > 0, \Re z > 0, r=0)$$

11.2.11

$$Ki_r(z) = \frac{1}{\Gamma(r)} \int_z^\infty (t-z)^{r-1} K_0(t)dt \quad (\Re z \geq 0, \Re r > 0)$$

11.2.12

$$Ki_{2r}(0) = \frac{\Gamma(r)\Gamma(\frac{3}{2})}{\Gamma(r+\frac{1}{2})} \quad (\Re r > 0)$$

11.2.13

$$Ki_{2r+1}(0) = \frac{\frac{\pi}{2}\Gamma(r+\frac{1}{2})}{\Gamma(\frac{1}{2})\Gamma(r+1)} \quad (\Re r > -\frac{1}{2})$$

11.2.14

$$rKi_{r+1}(z) = -zKi_r(z) + (r-1)Ki_{r-1}(z) + zKi_{r-2}(z)$$

11.3. Reduction Formulas for Indefinite Integrals

Let

$$11.3.1 \quad g_{\mu, \nu}(z) = \int e^{-\nu t} t^\mu Z_\nu(t) dt$$

where $Z_\nu(z)$ represents any of the Bessel functions of the first three kinds or the modified Bessel functions. The parameters a and b appearing in the reduction formulae are associated with the particular type of Bessel function as delineated in the following table.

11.3.2

$Z_\nu(z)$	a	b
$J_\nu(z), Y_\nu(z), H_\nu^{(1)}(z), H_\nu^{(2)}(z)$	1	1
$I_\nu(z)$	-1	1
$K_\nu(z)$	1	-1

11.3.3

$$pg_{\mu, \nu}(z) = -e^{-\nu z} z^\mu Z_\nu(z) + (\mu + \nu)g_{\mu-1, \nu}(z) - ag_{\mu, \nu+1}(z)$$

11.3.4

$$pg_{\mu, \nu+1}(z) = -e^{-\nu z} z^\mu Z_{\nu+1}(z) + (\mu - \nu - 1)g_{\mu-1, \nu+1}(z) + bg_{\mu, \nu}(z)$$

11.3.5

$$(p^2 + ab)g_{\mu, \nu}(z) = ae^{-\nu z} z^\mu Z_{\nu+1}(z) + (\mu - \nu - 1)e^{-\nu z} z^{\mu-1} Z_\nu(z) - pe^{-\nu z} z^\mu Z_\nu(z) + p(2\mu - 1)g_{\mu-1, \nu}(z) + [\nu^2 - (\mu - 1)^2]g_{\mu-2, \nu}(z)$$

11.3.6

$$a(\nu - \mu)g_{\mu, \nu+1}(z) = -2\nu e^{-\nu z} z^\mu Z_\nu(z) - 2\nu pg_{\mu, \nu}(z) + b(\mu + \nu)g_{\mu, \nu-1}(z)$$

Case 1: $p^2 + ab = 0, \nu = \pm(\mu - 1)$

$$11.3.7 \quad g_{\nu, \nu}(z) = \frac{e^{-\nu z} z^{\nu+1}}{2\nu+1} \left\{ Z_\nu(z) - \frac{a}{p} Z_{\nu+1}(z) \right\}$$

$$11.3.8 \quad g_{-\nu, \nu}(z) = -\frac{e^{-\nu z} z^{-\nu+1}}{2\nu-1} \left\{ Z_\nu(z) + \frac{b}{p} Z_{\nu-1}(z) \right\}$$

11.3.9

$$\int_0^z e^{it} t^\nu J_\nu(t) dt = \frac{e^{iz} z^{\nu+1}}{2\nu+1} [J_\nu(z) - iJ_{\nu+1}(z)] \quad (\Re \nu > -\frac{1}{2})$$

11.3.10

$$\int_0^z e^{it} t^{-\nu} J_\nu(t) dt = -\frac{e^{iz} z^{-\nu+1}}{2\nu-1} [J_\nu(z) + iJ_{\nu-1}(z)] + \frac{i}{2^{\nu-1}(2\nu-1)\Gamma(\nu)} \quad (\nu \neq \frac{1}{2})$$

11.3.11

$$\int_0^z e^{it} t^\nu Y_\nu(t) dt = \frac{e^{iz} z^{\nu+1}}{2\nu+1} [Y_\nu(z) - iY_{\nu+1}(z)] - \frac{i2^{\nu+1}\Gamma(\nu+1)}{\pi(2\nu+1)} \quad (\Re \nu > -\frac{1}{2})$$

11.3.12

$$\int_0^z e^{\pm it} t^\nu I_\nu(t) dt = \frac{e^{\pm iz} z^{\nu+1}}{2\nu+1} [I_\nu(z) \mp I_{\nu+1}(z)] \quad (\Re \nu > -\frac{1}{2})$$

11.3.13

$$\int_0^z e^{-t} I_n(t) dt = z e^{-z} [I_0(z) + I_1(z)] \\ + n [e^{-z} I_0(z) - 1] + 2e^{-z} \sum_{k=1}^{n-1} (n-k) I_k(z)$$

11.3.14

$$\int_0^z e^{\pm t} t^{-\nu} I_\nu(t) dt = -\frac{e^{\pm z} z^{-\nu+1}}{2\nu-1} [I_\nu(z) \mp I_{\nu-1}(z)] \\ \mp \frac{1}{2^{\nu-1} (2\nu-1) \Gamma(\nu)} \quad (\nu \neq \frac{1}{2})$$

11.3.15

$$\int_0^z e^{\pm t} t^\nu K_\nu(t) dt = \frac{e^{\pm z} z^{\nu+1}}{2\nu+1} [K_\nu(z) \pm K_{\nu+1}(z)] \\ \mp \frac{2^\nu \Gamma(\nu+1)}{2\nu+1} \quad (\Re \nu > -\frac{1}{2})$$

King's integral (see [11.5])

$$11.3.16 \quad \int_0^z e^t K_0(t) dt = z e^z [K_0(z) + K_1(z)] - 1$$

11.3.17

$$\int_z^\infty e^t t^{-\nu} K_\nu(t) dt \\ = \frac{e^z z^{-\nu+1}}{2\nu-1} [K_\nu(z) + K_{\nu-1}(z)] \quad (\Re \nu > \frac{1}{2})$$

Case 2:

$$p=0, \mu=\pm\nu$$

11.3.18

$$b g_{\nu, \nu-1}(z) = z^\nu Z_\nu(z)$$

11.3.19

$$a g_{-\nu, \nu+1}(z) = -z^{-\nu} Z_\nu(z)$$

11.3.20

$$\int_0^z t^\nu J_{\nu-1}(t) dt = z^\nu J_\nu(z) \quad (\Re \nu > 0)$$

11.3.21

$$\int_0^z t^{-\nu} J_{\nu+1}(t) dt = \frac{1}{2^\nu \Gamma(\nu+1)} - z^{-\nu} J_\nu(z)$$

11.3.22

$$2n \int_0^z \frac{J_{2n}(t) dt}{t} = 1 - \frac{2}{z} \sum_{k=1}^n (2k-1) J_{2k-1}(z) \\ = \frac{2}{z} \sum_{k=n+1}^\infty (2k-1) J_{2k-1}(z) \quad (n > 0)$$

11.3.23

$$(2n+1) \int_0^z \frac{J_{2n+1}(t) dt}{t} = \int_0^z J_0(t) dt \\ - J_1(z) - \frac{4}{z} \sum_{k=1}^n k J_{2k}(z)$$

11.3.24

$$\int_0^z t^\nu Y_{\nu-1}(t) dt = z^\nu Y_\nu(z) + \frac{2^\nu \Gamma(\nu)}{\pi} \quad (\Re \nu > 0)$$

$$11.3.25 \quad \int_0^z t^\nu I_{\nu-1}(t) dt = z^\nu I_\nu(z) \quad (\Re \nu > 0)$$

$$11.3.26 \quad \int_0^z t^{-\nu} I_{\nu+1}(t) dt = z^{-\nu} I_\nu(z) - \frac{1}{2^\nu \Gamma(\nu+1)}$$

11.3.27

$$\int_0^z t^\nu K_{\nu-1}(t) dt = -z^\nu K_\nu(z) + 2^{\nu-1} \Gamma(\nu) \quad (\Re \nu > 0)$$

$$11.3.28 \quad \int_z^\infty t^{-\nu} K_{\nu+1}(t) dt = z^{-\nu} K_\nu(z)$$

Indefinite Integrals of Products of Bessel Functions

Let $\mathcal{C}_\mu(z)$ and $\mathcal{D}_\nu(z)$ denote any two cylinder functions of orders μ and ν respectively.

11.3.29

$$\int^z \left\{ (k^2 - l^2) t - \frac{(\mu^2 - \nu^2)}{t} \right\} \mathcal{C}_\mu(kt) \mathcal{D}_\nu(lt) dt \\ = z \{ k \mathcal{C}_{\mu+1}(kz) \mathcal{D}_\nu(lz) - l \mathcal{C}_\mu(kz) \mathcal{D}_{\nu+1}(lz) \} \\ - (\mu - \nu) \mathcal{C}_\mu(kz) \mathcal{D}_\nu(lz) \quad *$$

11.3.30

$$\int^z t^{-\mu-\nu-1} \mathcal{C}_{\mu+1}(t) \mathcal{D}_{\nu+1}(t) dt \\ = -\frac{z^{-\mu-\nu}}{2(\mu+\nu+1)} \{ \mathcal{C}_\mu(z) \mathcal{D}_\nu(z) + \mathcal{C}_{\mu+1}(z) \mathcal{D}_{\nu+1}(z) \}$$

11.3.31

$$\int^z t^{\mu+\nu+1} \mathcal{C}_\mu(t) \mathcal{D}_\nu(t) dt \\ = \frac{z^{\mu+\nu+2}}{2(\mu+\nu+1)} \{ \mathcal{C}_\mu(z) \mathcal{D}_\nu(z) + \mathcal{C}_{\mu+1}(z) \mathcal{D}_{\nu+1}(z) \}$$

11.3.32

$$\int_0^z t J_{\nu-1}^2(t) dt = 2 \sum_{k=0}^\infty (\nu+2k) J_{\nu+2k}^2(z) \quad (\Re \nu > 0)$$

11.3.33

$$\int_0^z t [J_{\nu-1}^2(t) - J_{\nu+1}^2(t)] dt = 2\nu J_\nu^2(z) \quad (\Re \nu > 0)$$

$$11.3.34 \quad \int_0^z t J_0^2(t) dt = \frac{z^2}{2} [J_0^2(z) + J_1^2(z)]$$

11.3.35

$$\int_0^z J_n(t) J_{n+1}(t) dt = \frac{1}{2} [1 - J_0^2(z)] - \sum_{k=1}^n J_k^2(z) \\ = \sum_{k=n+1}^\infty J_k^2(z)$$

*See page II.

11.3.36

$$\begin{aligned}
 &(\mu + \nu) \int^z t^{-1} \mathcal{C}_\mu(t) \mathcal{D}_\nu(t) dt \\
 &\quad - (\mu + \nu + 2n) \int^z t^{-1} \mathcal{C}_{\mu+n}(t) \mathcal{D}_{\nu+n}(t) dt \\
 &= \mathcal{C}_\mu(z) \mathcal{D}_\nu(z) + \mathcal{C}_{\mu+n}(z) \mathcal{D}_{\nu+n}(z) + 2 \sum_{k=1}^{n-1} \mathcal{C}_{\mu+k}(z) \mathcal{D}_{\nu+k}(z)
 \end{aligned}$$

Convolution Type Integrals

11.3.37

$$\int_0^z J_\mu(t) J_\nu(z-t) dt = 2 \sum_{k=0}^{\infty} (-1)^k J_{\mu+\nu+2k+1}(z) \quad (\Re\mu > -1, \Re\nu > -1)$$

11.3.38

$$\int_0^z J_\nu(t) J_{1-\nu}(z-t) dt = J_0(z) - \cos z \quad (-1 < \Re\nu < 2)$$

11.3.39

$$\int_0^z J_\nu(t) J_{-\nu}(z-t) dt = \sin z \quad (|\Re\nu| < 1)$$

11.3.40

$$\int_0^z t^{-1} J_\mu(t) J_\nu(z-t) dt = \frac{J_{\mu+\nu}(z)}{\mu} \quad (\Re\mu > 0, \Re\nu > -1)$$

11.3.41

$$\int_0^z \frac{J_\mu(t) J_\nu(z-t) dt}{t(z-t)} = \frac{(\mu + \nu) J_{\mu+\nu}(z)}{\mu\nu z} \quad (\Re\mu > 0, \Re\nu > 0)$$

11.4. Definite Integrals

Orthogonality Properties of Bessel Functions

Let $\mathcal{C}_\nu(z)$ be a cylinder function of order ν . In particular, let

11.4.1 $\mathcal{C}_\nu(z) = AJ_\nu(z) + BY_\nu(z)$

where A and B are real constants. Then

11.4.2

$$\begin{aligned}
 &\int_a^b t \mathcal{C}_\nu(\lambda_m t) \mathcal{C}_\nu(\lambda_n t) dt = 0 \quad (m \neq n) \\
 &= \left[\frac{1}{2} t^2 \left\{ \left(1 - \frac{\nu^2}{\lambda_n^2 t^2} \right) \mathcal{C}_\nu'(\lambda_n t) + \mathcal{C}_\nu'^2(\lambda_n t) \right\} \right]_a^b \\
 &\quad (m = n) (0 < a < b)
 \end{aligned}$$

provided the following two conditions hold:

1. λ_n is a real zero of

11.4.3 $h_1 \lambda \mathcal{C}_{\nu+1}(\lambda b) - h_2 \mathcal{C}_\nu(\lambda b) = 0$

2. There must exist numbers k_1 and k_2 (both not zero) so that for all n

11.4.4 $k_1 \lambda_n \mathcal{C}_{\nu+1}(\lambda_n a) - k_2 \mathcal{C}_\nu(\lambda_n a) = 0$

In connection with these formulae, see 11.3.29. If $a=0$, the above is valid provided $B=0$. This case is covered by the following result.

11.4.5

$$\begin{aligned}
 \int_0^1 t J_\nu(\alpha_n t) J_\nu(\alpha_n t) dt &= 0 \quad (m \neq n, \nu > -1) \\
 &= \frac{1}{2} [J_\nu'(\alpha_n)]^2 \quad (m = n, b = 0, \nu > -1) \\
 &= \frac{1}{2\alpha_n^2} \left[\frac{a^2}{b^2} + \alpha_n^2 - \nu^2 \right] [J_\nu(\alpha_n)]^2 \quad (m = n, b \neq 0, \nu \geq -1)
 \end{aligned}$$

$\alpha_1, \alpha_2, \dots$ are the positive zeros of $aJ_\nu(x) + bxJ_\nu'(x) = 0$, where a and b are real constants.

11.4.6

$$\begin{aligned}
 \int_0^\infty t^{-1} J_{\nu+2n+1}(t) J_{\nu+2m+1}(t) dt &= 0 \quad (m \neq n) \\
 &= \frac{1}{2(2n + \nu + 1)} \quad (m = n) (\nu + n + m > -1)
 \end{aligned}$$

Definite Integrals Over a Finite Range

11.4.7 $\int_0^{\frac{\pi}{2}} J_{2n}(2z \sin t) dt = \frac{\pi}{2} J_n^2(z)$

11.4.8 $\int_0^\pi J_0(2z \sin t) \cos 2nt dt = \pi J_n^2(z)$

11.4.9 $\int_0^{\frac{\pi}{2}} Y_0(2z \sin t) \cos 2nt dt = \frac{\pi}{2} J_n(z) Y_n(z)$

11.4.10

$$\begin{aligned}
 &\int_0^{\frac{\pi}{2}} J_\mu(z \sin t) \sin^{\mu+1} t \cos^{2\nu+1} t dt \\
 &= \frac{2^\nu \Gamma(\nu+1)}{z^{\nu+1}} J_{\mu+\nu+1}(z) \quad (\Re\mu > -1, \Re\nu > -1)
 \end{aligned}$$

11.4.11

$$\begin{aligned}
 &\int_0^{\frac{\pi}{2}} J_\mu(z \sin^2 t) J_\nu(z \cos^2 t) \csc 2t dt \\
 &= \frac{(\mu + \nu)}{4\mu\nu} J_{\mu+\nu}(z) \quad (\Re\mu > 0, \Re\nu > 0)
 \end{aligned}$$

Infinite Integrals

Integrals of the Form $\int_0^\infty e^{-\nu t} t^\mu Z_\nu(t) dt$

11.4.12

$$\int_0^\infty e^{it} t^{\mu-1} J_\nu(t) dt = \frac{e^{\frac{1}{2}i\pi(\mu+\nu)} \Gamma(\mu+\nu) \Gamma(\frac{1}{2}-\mu)}{\Gamma(\frac{1}{2}) 2^\mu \Gamma(\nu-\mu+1)} \\ \left(\Re \mu < \frac{1}{2}, \Re(\mu+\nu) > 0 \right)$$

11.4.13

$$\int_0^\infty e^{-t} t^{\mu-1} I_\nu(t) dt = \frac{\Gamma(\mu+\nu) \Gamma(\frac{1}{2}-\mu)}{\Gamma(\frac{1}{2}) 2^\mu \Gamma(\nu-\mu+1)} \\ \left(\Re \mu < \frac{1}{2}, \Re(\mu+\nu) > 0 \right)$$

11.4.14

$$\int_0^\infty \cos bt K_0(t) dt = \frac{\frac{1}{2}\pi}{(1+b^2)^{\frac{1}{2}}} \quad (|\Re b| < 1)$$

11.4.15

$$\int_0^\infty \sin bt K_0(t) dt = \frac{\text{arc sinh } b}{(1+b^2)^{\frac{1}{2}}} \quad (|\Re b| < 1)$$

$$11.4.16 \quad \int_0^\infty t^\mu J_\nu(t) dt = \frac{2^\mu \Gamma\left(\frac{\nu+\mu+1}{2}\right)}{\Gamma\left(\frac{\nu-\mu+1}{2}\right)} \\ \left(\Re(\mu+\nu) > -1, \Re \mu < \frac{1}{2} \right)$$

$$11.4.17 \quad \int_0^\infty J_\nu(t) dt = 1 \quad (\Re \nu > -1)$$

11.4.18

$$\int_0^\infty \frac{[1-J_0(t)] dt}{t^\mu} = \frac{\Gamma\left(\frac{\mu-1}{2}\right) \Gamma\left(\frac{3-\mu}{2}\right)}{2^\mu \left\{ \Gamma\left(\frac{\mu+1}{2}\right) \right\}^2} \quad (1 < \Re \mu < 3)$$

11.4.19

$$\int_0^\infty t^\mu Y_\nu(t) dt = \frac{2^\mu}{\pi} \Gamma\left(\frac{\mu+\nu+1}{2}\right) \Gamma\left(\frac{\mu-\nu+1}{2}\right) \\ \times \sin \frac{\pi}{2}(\mu-\nu) \left(\Re(\mu\pm\nu) > -1, \Re \mu < \frac{1}{2} \right)$$

$$11.4.20 \quad \int_0^\infty Y_\nu(t) dt = -\tan \frac{\nu\pi}{2} \quad (|\Re \nu| < 1)$$

$$11.4.21 \quad \int_0^\infty Y_0(t) dt = 0$$

11.4.22

$$\int_0^\infty t^\mu K_\nu(t) dt = 2^{\mu-1} \Gamma\left(\frac{\mu+\nu+1}{2}\right) \Gamma\left(\frac{\mu-\nu+1}{2}\right) \\ \left(\Re(\mu\pm\nu) > -1 \right)$$

$$11.4.23 \quad \int_0^\infty K_0(t) dt = \frac{\pi}{2}$$

$$11.4.24 \quad \int_{-\infty}^\infty e^{-i\omega t} J_n(t) dt = \frac{2(-i)^n T_n(\omega)}{(1-\omega^2)^{\frac{1}{2}}} \quad (\omega^2 < 1) \\ = 0 \quad (\omega^2 > 1)$$

where $T_n(\omega)$ is the Chebyshev polynomial of the first kind (see chapter 22).

11.4.25

$$\int_{-\infty}^\infty t^{-1} e^{-i\omega t} J_n(t) dt \\ = \frac{2i}{n} (-i)^n (1-\omega^2)^{\frac{1}{2}} U_{n-1}(\omega) \quad (\omega^2 < 1) \\ = 0 \quad (\omega^2 > 1)$$

where $U_n(\omega)$ is the Chebyshev polynomial of the second kind (see chapter 22).

11.4.26

$$\int_{-\infty}^\infty t^{-\frac{1}{2}} e^{-i\omega t} J_{n+\frac{1}{2}}(t) dt = (-i)^n (2\pi)^{\frac{1}{2}} P_n(\omega) \quad (\omega^2 < 1) \\ = 0 \quad (\omega^2 > 1)$$

where $P_n(\omega)$ is the Legendre polynomial (see chapter 22).

11.4.27

$$\int_0^\infty e^{-t} t^{\frac{a}{2}-1} J_a[2(zt)^{\frac{1}{2}}] dt = \frac{\gamma(a, z)}{z^{a/2}} \quad (\Re a > 0, \Re z > 0)$$

where $\gamma(a, z)$ is the incomplete gamma function (see chapter 6).

Integrals of the Form $\int_0^\infty e^{-a^2 t^2} t^\mu Z_\nu(bt) dt$

11.4.28

$$\int_0^\infty e^{-a^2 t^2} t^{\mu-1} J_\nu(bt) dt \\ = \frac{\Gamma\left(\frac{1}{2}\nu + \frac{1}{2}\mu\right) \left(\frac{1}{2}\frac{b}{a}\right)^\nu}{2a^\mu \Gamma(\nu+1)} M\left(\frac{1}{2}\nu + \frac{1}{2}\mu, \nu+1, -\frac{b^2}{4a^2}\right) \\ \left(\Re(\mu+\nu) > 0, \Re a^2 > 0 \right)$$

where the notation $M(a, b, z)$ stands for the confluent hypergeometric function (see chapter 13).

11.4.29

$$\int_0^\infty e^{-a^2 t^2} t^{\nu+1} J_\nu(bt) dt \\ = \frac{b^\nu}{(2a^2)^{\nu+1}} e^{-\frac{b^2}{4a^2}} \quad (\Re \nu > -1, \Re a^2 > 0)$$

11.4.30

$$\int_0^\infty e^{-a^2 t^2} Y_{2\nu}(bt) dt = -\frac{\pi^{\frac{1}{2}}}{2a} e^{-\frac{b^2}{8a^2}} \left[I_\nu \left(\frac{b^2}{8a^2} \right) \tan \nu\pi + \frac{1}{\pi} K_\nu \left(\frac{b^2}{8a^2} \right) \sec \nu\pi \right] \quad \left(|\Re \nu| < \frac{1}{2}, \Re a^2 > 0 \right)$$

11.4.31

$$\int_0^\infty e^{-a^2 t^2} I_\nu(bt) dt = \frac{\pi^{\frac{1}{2}}}{2a} e^{-\frac{b^2}{8a^2}} I_{\frac{1}{2}\nu} \left(\frac{b^2}{8a^2} \right) \quad (\Re \nu > -1, \Re a^2 > 0)$$

11.4.32

$$\int_0^\infty e^{-a^2 t^2} K_0(bt) dt = \frac{\pi^{\frac{1}{2}}}{4a} e^{-\frac{b^2}{8a^2}} K_0 \left(\frac{b^2}{8a^2} \right) \quad (\Re a^2 > 0)$$

Weber-Schafheitlin Type Integrals

11.4.33

$$\int_0^\infty \frac{J_\mu(at) J_\nu(bt) dt}{t^\lambda} = \frac{b^\nu \Gamma \left(\frac{\mu + \nu - \lambda + 1}{2} \right)}{2^\lambda a^{\nu - \lambda + 1} \Gamma(\nu + 1) \Gamma \left(\frac{\mu - \nu + \lambda + 1}{2} \right)} \times {}_2F_1 \left(\frac{\mu + \nu - \lambda + 1}{2}, \frac{\nu - \mu - \lambda + 1}{2}; \nu + 1; \frac{b^2}{a^2} \right) \quad (\Re(\mu + \nu - \lambda + 1) > 0, \Re \lambda > -1, 0 < b < a)$$

11.4.34

$$\int_0^\infty \frac{J_\mu(at) J_\nu(bt) dt}{t^\lambda} = \frac{a^\mu \Gamma \left(\frac{\mu + \nu - \lambda + 1}{2} \right)}{2^\lambda b^{\mu - \lambda + 1} \Gamma(\mu + 1) \Gamma \left(\frac{\nu - \mu + \lambda + 1}{2} \right)} \times {}_2F_1 \left(\frac{\mu + \nu - \lambda + 1}{2}, \frac{\mu - \nu - \lambda + 1}{2}; \mu + 1; \frac{a^2}{b^2} \right) \quad (\Re(\mu + \nu - \lambda + 1) > 0, \Re \lambda > -1, 0 < a < b)$$

For ${}_2F_1$, see chapter 15.

Special Cases of the Discontinuous Weber-Schafheitlin Integral

11.4.35

$$\int_0^\infty \frac{J_\mu(at) \sin bt dt}{t} = \frac{1}{\mu} \sin \left[\mu \arcsin \frac{b}{a} \right] \quad (0 \leq b \leq a) \\ = \frac{a^\mu \sin \frac{\pi\mu}{2}}{\mu [b + (b^2 - a^2)^{\frac{1}{2}}]^\mu} \quad (b \geq a > 0) \quad (\Re \mu > -1)$$

11.4.36

$$\int_0^\infty \frac{J_\mu(at) \cos bt dt}{t} = \frac{1}{\mu} \cos \left[\mu \arcsin \frac{b}{a} \right] \quad (0 \leq b \leq a) \\ = \frac{a^\mu \cos \frac{\pi\mu}{2}}{\mu [b + (b^2 - a^2)^{\frac{1}{2}}]^\mu} \quad (b \geq a > 0) \quad (\Re \mu > 0)$$

11.4.37

$$\int_0^\infty J_\mu(at) \cos bt dt = \frac{\cos \left[\mu \arcsin \frac{b}{a} \right]}{(a^2 - b^2)^{\frac{1}{2}}} \quad (0 \leq b < a) \\ = \frac{-a^\mu \sin \frac{\pi\mu}{2}}{(b^2 - a^2)^{\frac{1}{2}} [b + (b^2 - a^2)^{\frac{1}{2}}]^\mu} \quad (b > a > 0) \quad (\Re \mu > -1)$$

11.4.38

$$\int_0^\infty J_\mu(at) \sin bt dt = \frac{\sin \left[\mu \arcsin \frac{b}{a} \right]}{(a^2 - b^2)^{\frac{1}{2}}} \quad (0 \leq b < a) \\ = \frac{a^\mu \cos \frac{\pi\mu}{2}}{(b^2 - a^2)^{\frac{1}{2}} [b + (b^2 - a^2)^{\frac{1}{2}}]^\mu} \quad (b > a > 0) \quad (\Re \mu > -2)$$

11.4.39

$$\int_0^\infty e^{ibt} J_0(at) dt = \frac{1}{(a^2 - b^2)^{\frac{1}{2}}} \quad (0 \leq b < a) \\ = \frac{i}{(b^2 - a^2)^{\frac{1}{2}}} \quad (0 < a < b)$$

11.4.40

$$\int_0^\infty e^{ibt} Y_0(at) dt = \frac{2i}{\pi(a^2 - b^2)^{\frac{1}{2}}} \arcsin \frac{b}{a} \quad (0 \leq b < a) \\ = \frac{-1}{(b^2 - a^2)^{\frac{1}{2}}} + \frac{2i}{\pi(b^2 - a^2)^{\frac{1}{2}}} \times \ln \left\{ \frac{b - (b^2 - a^2)^{\frac{1}{2}}}{a} \right\} \quad (0 < a < b)$$

11.4.41

$$\int_0^\infty t^{\mu - \nu + 1} J_\mu(at) J_\nu(bt) dt = 0 \quad (0 < b < a) \\ = \frac{2^{\mu - \nu + 1} a^\mu (b^2 - a^2)^{\nu - \mu - 1}}{b^\nu \Gamma(\nu - \mu)} \quad (b > a > 0) \quad (\Re \nu > \Re \mu > -1)$$

11.4.42

$$\int_0^\infty J_\mu(at) J_{\mu-1}(bt) dt = \frac{b^{\mu-1}}{a^\mu} \quad (0 < b < a) \\ = \frac{1}{2b} \quad (0 < b = a) \\ = 0 \quad (b > a > 0) \quad (\Re \mu > 0)$$

11.4.43

$$\int_0^\infty \frac{J_0(at)}{t} \{1 - J_0(bt)\} dt = 0 \quad (0 < b \leq a) \\ = \ln \frac{b}{a} \quad (b \geq a > 0)$$

Hankel-Nicholson Type Integrals

11.4.44

$$\int_0^\infty \frac{t^{\nu+1} J_\nu(at) dt}{(t^2+z^2)^{\mu+1}} = \frac{a^\mu z^{\nu-\mu}}{2^\mu \Gamma(\mu+1)} K_{\nu-\mu}(az)$$

$$\left(a > 0, \Re z > 0, -1 < \Re \nu < 2\Re \mu + \frac{3}{2} \right)$$

11.4.45

$$\int_0^\infty \frac{J_\nu(at) dt}{t^\nu (t^2+z^2)} = \frac{\pi}{2z^{\nu+1}} [I_\nu(az) - L_\nu(az)]$$

$$\left(a > 0, \Re z > 0, \Re \nu > -\frac{5}{2} \right)$$

11.4.46

$$\int_0^\infty \frac{Y_0(at) dt}{t^2+z^2} = -\frac{K_0(az)}{z} \quad (a > 0, \Re z > 0)$$

11.4.47

$$\int_0^\infty \frac{K_\nu(at) dt}{t^\nu (t^2+z^2)} = \frac{\pi^2}{4z^{\nu+1} \cos \nu\pi} [\mathbf{H}_\nu(az) - Y_\nu(az)]$$

$$(\Re a > 0, \Re z > 0, \Re \nu < \frac{1}{2})$$

11.4.48

$$\int_0^\infty \frac{J_\nu(at) dt}{(t^2+z^2)^{\frac{1}{2}}} = I_{\frac{1}{2}}(\frac{1}{2}az) K_{\frac{1}{2}}(\frac{1}{2}az)$$

$$(a > 0, \Re z > 0, \Re \nu > -1)$$

11.4.49

$$\int_0^\infty \frac{J_\nu(at) dt}{t^\nu (t^2+z^2)^{\nu+\frac{1}{2}}} = \frac{\left(\frac{2a}{z^2}\right)^\nu \Gamma(\nu+1)}{\Gamma(2\nu+1)} I_\nu(\frac{1}{2}az) K_\nu(\frac{1}{2}az)$$

$$(a > 0, \Re z > 0, \Re \nu > -\frac{1}{2})$$

Numerical Methods

11.5. Use and Extension of the Tables

$$\int_0^x J_0(t) dt, \int_0^x Y_0(t) dt, \int_0^x I_0(t) dt, \int_x^\infty K_0(t) dt$$

For moderate values of x , use 11.1.2 and 11.1.7-11.1.10 as appropriate. For x sufficiently large, use the asymptotic expansions or the polynomial approximations 11.1.11-11.1.18.

Example 1. Compute $\int_0^{3.05} J_0(t) dt$ to 5D. Using 11.1.2 and interpolating in Tables 9.1 and 9.2, we have

$$\int_0^{3.05} J_0(t) dt = 2[.32019\ 09 + .31783\ 69 + .04611\ 52$$

$$+ .00283\ 19 + .00009\ 72 + .00000\ 21]$$

$$= 1.37415$$

Example 2. Compute $\int_0^{3.05} J_0(t) dt$ to 5D by interpolation of Table 11.1 using Taylor's formula. We have

$$\int_0^{x+h} J_0(t) dt = \int_0^x J_0(t) dt + hJ_0(x) - \frac{h^2}{2} J_1(x)$$

$$+ \frac{h^3}{12} [J_2(x) - J_0(x)] + \frac{h^4}{96} [3J_1(x) - J_3(x)] + \dots$$

Then with $x=3.0$ and $h=.05$,

$$\int_0^{3.05} J_0(t) dt = 1.387567 + (.05)(-.260052)$$

$$- (.00125)(.339059)$$

$$+ (.000010)(.746143) = 1.37415$$

This value is readily checked using $x=-3.1$ and $h=-.05$. Now $|J_0(x)| \leq 1$ for all x and $|J_n(x)| < 2^{-n}$, $n \geq 1$ for all x . In Table 11.1, we can always choose $|h| \leq .05$. Thus if all terms of $O(h^4)$ and higher are neglected, then a bound for the absolute error is $2^4 h^4 / 48 < .2 \cdot 10^{-6}$ for all x if $|h| \leq .05$. Similarly, the absolute error for quadratic interpolation does not exceed

$$h^3(2^3+2)/24 < .2 \cdot 10^{-4}.$$

Example 3. Interpolation of $\int_0^x J_0(t) dt$ using Simpson's rule. We have

$$\int_0^{x+h} J_0(t) dt = \int_0^x J_0(t) dt + \int_x^{x+h} J_0(t) dt$$

$$\int_x^{x+h} J_0(t) dt = \frac{h}{6} \left[J_0(x) + 4J_0\left(x + \frac{h}{2}\right) + J_0(x+h) \right] + R$$

$$R = -\frac{h^5}{2880} J_0^{(4)}(\xi), \quad x < \xi < x+h$$

Now

$$J_0^{(4)}(x) = \frac{1}{8} [J_4(x) - 4J_2(x) + 3J_0(x)]$$

$$|J_0^{(4)}(x)| < \frac{6+5\sqrt{2}}{16} < .82$$

and with $|h| \leq .05$, it follows that

$$|R| < .9 \cdot 10^{-10}$$

Thus if $x=3.0$ and $h=.05$

$$\int_0^{3.05} J_0(t) dt = 1.38756\ 72520 + \frac{(.05)}{6} [-.26005\ 19549$$

$$+ 4(-.26841\ 13883) - .27653\ 49599]$$

$$= 1.37414\ 86481$$

which is correct to 10D. The above procedure gives high accuracy though it may be necessary to interpolate twice in $J_0(x)$ to compute $J_0\left(x+\frac{h}{2}\right)$ and $J_0(x+h)$. A similar technique based on the trapezoidal rule is less accurate, but at most only one interpolation of $J_0(x)$ is required.

Example 4. Compute $\int_0^3 J_0(t)dt$ and $\int_0^3 Y_0(t)dt$ to 5D using the representation in terms of Struve functions and the tables in chapters 9 and 12.

For $x=3$, from **Tables 9.1 and 12.1**

$$\begin{aligned} J_0 &= -.260052 & J_1 &= .339059 \\ Y_0 &= .376850 & Y_1 &= .324674 \\ H_0 &= .574306 & H_1 &= 1.020110 \end{aligned}$$

Using 11.1.7, we have

$$\begin{aligned} \int_0^3 J_0(t)dt &= 3(-.260052) + \frac{3\pi}{2} [(.574306)(.339059) \\ &\quad - (1.020110)(-.260052)] \\ &= 1.38757 \end{aligned}$$

Similarly,

$$\int_0^3 Y_0(t)dt = .19766$$

Using 11.1.8 and **Tables 9.8 and 12.1**, one can compute $\int_0^x I_0(t)dt$ and $\int_0^x K_0(t)dt$.

$$\int_x^\infty \frac{J_0(t)dt}{t}, \int_x^\infty \frac{Y_0(t)dt}{t}, \int_0^x \frac{[I_0(t)-1]dt}{t}, \int_x^\infty \frac{K_0(t)dt}{t}$$

For moderate values of x , use 11.1.19–11.1.23. For x sufficiently large, use the asymptotic expansions or the polynomial approximations 11.1.24–11.1.31.

Repeated Integrals of $J_0(x)$

For moderate values of x and r , use 11.2.4. If $r=1$, see **Example 1**. For moderate values of x , use the recurrence formula 11.2.5. If x is large and $x \gg r$, see the discussion below.

Example 5. Compute $f_{r,0}(x) = f_r(x)$ to 5D for $x=2$ and $r=0(1)5$ using 11.2.6. We have

$$rf_{r+1}(x) = xf_r(x) - (r-1)f_{r-1}(x) + xf_{r-2}(x)$$

$$f_{-1}(x) = -J_1(x), f_0(x) = J_0(x), f_1(x) = \int_0^x J_0(t) dt$$

and the terms on this last line are tabulated. Thus for $x=2$,

$$f_{-1} = -.57672 48, f_0 = .22389 08, f_1 = 1.42577 03$$

The recurrence formula gives

$$f_2 = 2(f_1 + f_{-1}) = 1.69809 10$$

Similarly,

$$f_3 = 1.20909 66, f_4 = .62451 73, f_5 = .25448 17$$

When $x \gg r$, it is convenient to use the auxiliary function

$$g_r(x) = (r-1)!x^{-r+1}f_r(x)$$

This satisfies the recurrence relation

$$\begin{aligned} x^2g_{r+1}(x) &= x^2g_r - (r-1)^2g_{r-1}(x) \\ &\quad + (r-1)(r-2)g_{r-2}(x), r \geq 3 \end{aligned}$$

$$\begin{aligned} g_1(x) &= \int_0^x J_0(t)dt, g_2(x) = g_1(x) - J_1(x) \\ g_3(x) &= [x^2g_2(x) - g_1(x) + xJ_0(x)]/x^2 \end{aligned}$$

Example 6. Compute $g_r(x)$ to 5D for $x=10$ and $r=0(1)6$. We have for $x=10$,

$$J_0 = -.24593 58, J_1 = .04347 27, g_1 = 1.06701 13$$

Thus

$$g_2 = 1.02353 86, g_3 = .98827 49$$

and the forward recurrence formula gives

$$g_4 = .96867 36, g_5 = .94114 12, g_6 = .90474 64$$

For tables of $2^{-r}f_r(x)$, see [11.16].

Repeated Integrals of $K_0(x)$

For moderate values of x , use the recurrence formula 11.2.14 for all r .

Example 7. Compute $Ki_r(x)$ to 5D for $x=2$ and $r=0(1)5$. We have

$$rKi_{r+1}(x) = -xKi_r(x) + (r-1)Ki_{r-1}(x) + xKi_{r-2}(x)$$

$$Ki_{-1}(x) = K_1(x), Ki_0(x) = K_0(x), Ki_1(x) = \int_x^\infty K_0(t)dt$$

and the functions on this last line are tabulated. Thus for $x=2$,

$$K_0 = .11389 39, K_1 = .13986 59, Ki_1 = .09712 06$$

and

$$Ki_2 = -2Ki_1 + 2K_1 = .08549 06$$

Similarly,

$$Ki_3 = .07696 36, Ki_4 = .07043 17, Ki_5 = .06525 22$$

If x/r is not large the formula can still be used provided that the starting values are sufficiently accurate to offset the growth of rounding error.

For tables of $Ki_r(x)$, see [11.11].

$$f_m(x) = x^{-m} \int_0^x t^m K_0(t) dt$$

Now

$$f_0(x) = \int_0^x K_0(t) dt, f_1(x) = [1 - xK_1(x)]/x$$

the latter following from 11.3.27 with $\nu=1$. In 11.3.5, put $a=1, b=-1, p=0$ and $\nu=0$. Let $\mu=m$. Then

$$f_m(x) = [(m-1)^2 f_{m-2}(x) - x^2 K_1(x) - x(m-1)K_0(x)]/x^2 \quad (m > 1)$$

Using tabular values of f_0 and f_1 , one can compute in succession f_2, f_3, \dots provided that m/x is not large.

Example 8. Compute $f_m(x)$ to 5D for $x=5$ and $m=0(1)6$. We have, retaining two additional decimals

$$K_0 = .00369 \ 11 \quad K_1 = .00404 \ 46$$

$$f_0 = 1.56738 \ 74 \quad f_1 = .19595 \ 54$$

Thus

$$f_2 = .05791 \ 27, f_4 = .01458 \ 93, f_6 = .00685 \ 36$$

Similarly starting with f_1 , we can compute f_3 and f_5 .

If $m > x$, employ the recurrence formula in backward form and write

$$f_{m-2}(x) = [x^2 f_m(x) + x^2 K_1(x) + x(m-1)K_0(x)]/(m-1)^2$$

In the latter expression, replace f_m by g_m . Fix x . Take $r > m$ and assume $g_r = 0$. Compute g_{r-2}, g_{r-4} , etc. Then

$$\lim_{r \rightarrow \infty} g_{r-2k}(x) = f_m(x), \quad m = r - 2k$$

Apart from round-off error, the value of r needed to achieve a stated accuracy for given x and m can be determined a priori. Let

$$\epsilon_r = |g_r - f_r|$$

Then

$$\epsilon_{r-2k} = \frac{x^{2k} \epsilon_r}{(r-1)^2 (r-3)^2 \dots (r-2k+1)^2}$$

$$\epsilon_r \leq [x^2 K_1(x) + x(r-1)K_0(x)]/(r-1)^2$$

since for x fixed, $f_r(x)$ is positive and decreases as r increases.

Example 9. Compute $f_m(x)$ to 5D for $x=3$ and $m=0(2)10$. We have

$$K_0 = .03473 \ 95 \quad K_1 = .04015 \ 64$$

If $r=16$,

$$\epsilon_{16} < .86 \cdot 10^{-2} \quad \epsilon_{10} < 1.4 \cdot 10^{-6}$$

Taking $g_{16} = 0$, we compute the following values of $g_{14}, g_{12}, \dots, g_0$ by recurrence. Also recorded are the required values of f_m to 5D.

m	g_m	f_m
14	.00855 42	
12	.01061 09	
10	.01325 05	.01325
8	.01751 39	.01751
6	.02548 09	.02548
4	.04447 31	.04447
2	.11936 90	.11937
0	1.53994 71	1.53995

For tables of $f_m(x)$, see [11.21].

References

- Texts**
- [11.1] H. Bateman and R. C. Archibald, A guide to tables of Bessel functions, Math. Tables Aids Comp. 1, 247-252 (1943). See also Supplements I, II, IV, same journal, 1, 403-404 (1943); 2, 59 (1946); 2, 190 (1946), respectively.
 - [11.2] A. Erdélyi et al., Higher transcendental functions, vol. 2, ch. 7 (McGraw-Hill Book Co., Inc., New York, N.Y., 1953).
 - [11.3] A. Erdélyi et al., Tables of integral transforms, vols. 1, 2 (McGraw-Hill Book Co., Inc., New York, N.Y., 1954).
 - [11.4] W. Gröbner and N. Hofreiter, Integraltafel, II Teil (Springer-Verlag, Wien and Innsbruck, Austria, 1949-1950).
 - [11.5] L. V. King, On the convection of heat from small cylinders in a stream of fluid, Trans. Roy. Soc. London 214A, 373-432 (1914).
 - [11.6] Y. L. Luke, Some notes on integrals involving Bessel functions, J. Math. Phys. 29, 27-30 (1950).
 - [11.7] Y. L. Luke, An associated Bessel function, J. Math. Phys. 31, 131-138 (1952).
 - [11.8] F. Oberhettinger, On some expansions for Bessel integral functions, J. Research NBS 59, 197-201 (1957) RP 2786.
 - [11.9] G. Petiau, La théorie des fonctions de Bessel (Centre National de la Recherche Scientifique, Paris, France, 1955).
 - [11.10] G. N. Watson, A treatise on the theory of Bessel functions, 2d ed. (Cambridge Univ. Press, Cambridge, England, 1958).
- Tables**
- [11.11] W. G. Bickley and J. Nayler, A short table of the functions $Ki_n(x)$, from $n=1$ to $n=16$. Philos. Mag. 7, 20, 343-347 (1935). $Ki_1(x) = \int_x^\infty K_0(t) dt$, $Ki_n(x) = \int_x^\infty Ki_{n-1}(t) dt$, $n=1(1)16$, $x=0(.05)2$ (.1)2, 3, 9D.

- [11.12] V. R. Bursian and V. Fock, Table of the functions $\int_x^\infty K_0(x) dx, \int_0^x I_0(x) dx, e^x \int_x^\infty K_0(x) dx, e^{-x} \int_0^x I_0(x) dx$, Akad. Nauk, Leningrad, Inst. Fiz. Mat., Trudy (Travaux) 2, 6-10 (1931). $\int_x^\infty K_0(t) dt, x=0(.1)12, 7D$; $e^x \int_x^\infty K_0(t) dt, x=0(.1)16, 7D$; $\int_0^x I_0(t) dt, x=0(.1)6, 7D$; $e^{-x} \int_0^x I_0(t) dt, x=0(.1)16, 7D$.
- [11.13] E. A. Chistova, Tablitsy funktsii Besselya ot deistvitel' nogo argumenta i integralov ot nikh (Izdat. Akad. Nauk SSSR., Moscow, U.S.S.R., 1958). $J_n(x), Y_n(x), \int_x^\infty \frac{J_n(t)}{t} dt, \int_x^\infty \frac{Y_n(t)}{t} dt, n=0, 1; x=0(.001)15(.01)100, 7D$. Also tabulated are auxiliary expressions to facilitate interpolation near the origin.
- [11.14] A. J. M. Hitchcock, Polynomial approximations to Bessel functions of order zero and one and to related functions, Math. Tables Aids Comp. 11, 86-88 (1957). Polynomial approximations for $\int_0^x J_0(t) dt$ and $\int_x^\infty K_0(t) dt$.
- [11.15] C. W. Horton, A short table of Struve functions and of some integrals involving Bessel and Struve functions, J. Math. Phys. 29, 56-58 (1950). $C_n(x) = \int_0^x t^n J_n(t) dt, n=1(1)4, x=0(.1)10, 4D$; $D_n(x) = \int_0^x t^n \mathbf{H}_n(t) dt, n=0(1)4, x=0(.1)10, 4D$, where $\mathbf{H}_n(x)$ is Struve's function; see chapter 12.
- [11.16] J. C. Jaeger, Repeated integrals of Bessel functions and the theory of transients in filter circuits, J. Math. Phys. 27, 210-219 (1948). $f_1(x) = \int_0^x J_0(t) dt, f_r(x) = \int_0^x f_{r-1}(t) dt, 2^{-r} f_r(x), r=1(1)7, x=0(1)24, 8D$. Also $\Phi_n(x) = \int_0^\infty J_0[2(xt)^n] J_n(t) dt, \Phi_n(x), \Phi'_n(x), n=1(1)7, x=0(1)24, 4D$.
- [11.17] L. N. Karmazina and E. A. Chistova, Tablitsy funktsii Besselya ot mnimogo argumenta i integralov ot nikh (Izdat. Akad. Nauk SSSR., Moscow, U.S.S.R., 1958). $e^{-x} I_0(x), e^{-x} I_1(x), e^x K_0(x), e^x K_1(x), e^x, e^{-x} \int_0^x I_0(t) dt, e^x \int_x^\infty K_0(t) dt, x=0(.001)5(.005)15(.01)100, 7D$ except for e^x which is 7S. Also tabulated are auxiliary expressions to facilitate interpolation near the origin.
- [11.18] H. L. Knudsen, Bidrag til teorien for antennesystemer med hel eller delvis rotations-symmetri. I (Kommission Has Teknisk Forlag, Copenhagen, Denmark, 1953). $\int_0^x J_n(t) dt, n=0(1)8, x=0(.01)10, 5D$. Also $\int_0^x J_n(t) e^{\alpha t} dt, \alpha=t, \alpha=x-t$.
- [11.19] Y. L. Luke and D. Ufford, Tables of the function $\bar{K}_0(x) = \int_0^x K_0(t) dt$. Math. Tables Aids Comp. UMT 129. $\bar{K}_0(x) = -[\gamma + \ln(x/2)]A_1(x) + A_2(x), A_1(x), A_2(x). x=0(.01).5(.05)1, 8D$.
- [11.20] C. Mack and M. Castle, Tables of $\int_0^a I_0(x) dx$ and $\int_a^\infty K_0(x) dx$, Roy. Soc. Unpublished Math. Table File No. 6. $a=0(.02)2(.1)4, 9D$.
- [11.21] G. M. Muller, Table of the function
$$Kj_n(x) = x^{-n} \int_0^x u^n K_0(u) du,$$
 Office of Technical Services, U.S. Department of Commerce, Washington, D.C. (1954). $n=0(1)31, x=0(.01)2(.02)5, 8S$.
- [11.22] National Bureau of Standards, Tables of functions and zeros of functions, Applied Math. Series 37 (U.S. Government Printing Office, Washington, D.C., 1954). (1) pp. 21-31: $\int_0^x J_0(t) dt, \int_0^x Y_0(t) dt, x=0(.01)10, 10D$. (2) pp. 33-39: $\int_x^\infty J_0(t) dt/t, x=0(.1)10(1)22, 10D$; $F(x) = \int_x^\infty J_0(t) dt/t + \ln(x/2), x=0(.1)3, 10D$; $F^{(n)}(x)/n!, x=10(1)22, n=0(1)13, 12D$.
- [11.23] National Physical Laboratory, Integrals of Bessel functions, Roy. Soc. Unpublished Math. Table File No. 17. $\int_0^x J_0(t) dt, \int_0^x Y_0(t) dt, x=0(.5)50, 10D$.
- [11.24] M. Rothman, Table of $\int_0^x I_0(x) dx$ for $0(.1)20(1)25$, Quart. J. Mech. Appl. Math. 2, 212-217 (1949). 8S-9S.
- [11.25] P. W. Schmidt, Tables of $\int_0^x J_0(t) dt$ for large x , J. Math. Phys. 34, 169-172 (1955). $x=10(.2)40, 6D$.
- [11.26] G. N. Watson, A treatise on the theory of Bessel functions, 2d ed. (Cambridge Univ. Press, Cambridge, England, 1958). Table VIII, p. 752: $\frac{1}{2} \int_0^x J_0(t) dt, \frac{1}{2} \int_0^x Y_0(t) dt, x=0(.02)1, 7D$, with the first 16 maxima and minima of the integrals to 7D.

Table 11.1

INTEGRALS OF BESSEL FUNCTIONS

x	$\int_0^x J_0(t) dt$	$\int_0^x Y_0(t) dt$	$e^{-x} \int_0^x I_0(t) dt$	$e^x \int_x^\infty K_0(t) dt$
0.0	0.00000 00000	0.00000 00000	0.00000 00	1.57079 63
0.1	0.09991 66979	-0.21743 05666	0.09055 92	1.35784 82
0.2	0.19933 43325	-0.34570 88380	0.16429 28	1.25032 54
0.3	0.29775 75802	-0.43928 31758	0.22391 79	1.17280 09
0.4	0.39469 85653	-0.50952 48283	0.27172 46	1.11171 28
0.5	0.48968 05066	-0.56179 54559	0.30964 29	1.06127 17
0.6	0.58224 12719	-0.59927 15570	0.33929 99	1.01836 48
0.7	0.67193 68094	-0.62409 96341	0.36206 71	0.98109 70
0.8	0.75834 44308	-0.63786 88991	0.37910 05	0.94821 80
0.9	0.84106 59149	-0.64184 01770	0.39137 42	0.91885 56
1.0	0.91973 04101	-0.63706 93766	0.39970 88	0.89237 52
1.1	0.99399 71082	-0.62447 91607	0.40479 52	0.86829 97
1.2	1.06355 76711	-0.60490 26964	0.40721 52	0.84626 10
1.3	1.12813 83885	-0.57911 12548	0.40745 78	0.82596 89
1.4	1.18750 20495	-0.54783 19295	0.40593 39	0.80719 04
1.5	1.24144 95144	-0.51175 90340	0.40298 85	0.78973 57
1.6	1.28982 09734	-0.47156 13039	0.39891 09	0.77344 80
1.7	1.33249 68829	-0.42788 62338	0.39394 29	0.75819 62
1.8	1.36939 85727	-0.38136 24134	0.38828 68	0.74386 97
1.9	1.40048 85208	-0.33260 04453	0.38211 11	0.73037 44
2.0	1.42577 02932	-0.28219 28501	0.37555 57	0.71762 95
2.1	1.44528 81525	-0.23071 32490	0.36873 67	0.70556 50
2.2	1.45912 63387	-0.17871 50399	0.36174 98	0.69412 02
2.3	1.46740 80303	-0.12672 97284	0.35467 38	0.68324 16
2.4	1.47029 39949	-0.07526 50420	0.34757 29	0.67288 26
2.5	1.46798 09446	-0.02480 29261	0.34049 93	0.66300 15
2.6	1.46069 96081	+0.02420 24953	0.33349 48	0.65356 16
2.7	1.44871 25408	0.07132 69288	0.32659 30	0.64452 98
2.8	1.43231 16899	0.11617 78353	0.31981 99	0.63587 68
2.9	1.41181 57386	0.15839 62206	0.31319 59	0.62757 60
3.0	1.38756 72520	0.19765 82565	0.30673 62	0.61960 34
3.1	1.35992 96508	0.23367 66986	0.30045 18	0.61193 74
3.2	1.32928 40386	0.26620 20748	0.29435 04	0.60455 84
3.3	1.29602 59125	0.29502 36222	0.28843 67	0.59744 84
3.4	1.26056 17835	0.31996 99576	0.28271 31	0.59059 11
3.5	1.22330 57382	0.34090 94657	0.27718 02	0.58397 14
3.6	1.18467 59706	0.35775 03989	0.27183 70	0.57757 57
3.7	1.14509 13136	0.37044 06831	0.26668 11	0.57139 13
3.8	1.10496 78009	0.37896 74266	0.26170 94	0.56540 66
3.9	1.06471 52877	0.38335 61369	0.25691 78	0.55961 09
4.0	1.02473 41595	0.38366 96479	0.25230 18	0.55399 42
4.1	0.98541 21560	0.38000 67672	0.24785 61	0.54854 72
4.2	0.94712 13375	0.37250 06552	0.24357 56	0.54326 15
4.3	0.91021 52175	0.36131 69475	0.23945 46	0.53812 91
4.4	0.87502 60866	0.34665 16398	0.23548 74	0.53314 27
4.5	0.84186 25481	0.32872 87513	0.23166 83	0.52829 52
4.6	0.81100 72858	0.30779 77892	0.22799 15	0.52358 03
4.7	0.78271 50802	0.28413 10351	0.22445 13	0.51899 19
4.8	0.75721 10902	0.25802 06786	0.22104 21	0.51452 43
4.9	0.73468 94106	0.22977 58227	0.21775 83	0.51017 24
5.0	0.71531 19178	0.19971 93876	0.21459 46	0.50593 10
	$\left[\begin{smallmatrix} (-4)7 \\ 7 \end{smallmatrix} \right]$		$\left[\begin{smallmatrix} (-3)2 \\ 6 \end{smallmatrix} \right]$	

INTEGRALS OF BESSEL FUNCTIONS

Table 11.1

x	$\int_0^x J_0(t) dt$	$\int_0^x Y_0(t) dt$	$e^{-x} \int_0^x I_0(t) dt$	$e^x \int_x^\infty K_0(t) dt$
5.0	0.71531 19178	0.19971 93876	0.21459 46	0.50593 10
5.1	0.69920 74098	0.16818 49405	0.21154 58	0.50179 55
5.2	0.68647 10457	0.13551 34784	0.20860 68	0.49776 16
5.3	0.67716 40870	0.10205 01932	0.20577 28	0.49382 50
5.4	0.67131 39407	0.06814 12463	0.20303 89	0.48998 19
5.5	0.66891 44989	0.03413 05806	0.20040 08	0.48622 86
5.6	0.66992 67724	+0.00035 67983	0.19785 40	0.48256 16
5.7	0.67427 98068	-0.03284 98697	0.19539 44	0.47897 75
5.8	0.68187 18713	-0.06517 04775	0.19301 81	0.47547 34
5.9	0.69257 19078	-0.09630 01348	0.19072 13	0.47204 60
6.0	0.70622 12236	-0.12595 06129	0.18850 02	0.46869 29
6.1	0.72263 54100	-0.15385 27646	0.18635 16	0.46541 11
6.2	0.74160 64692	-0.17975 87372	0.18427 20	0.46219 83
6.3	0.76290 51256	-0.20344 39625	0.18225 84	0.45905 20
6.4	0.78628 33012	-0.22470 89068	0.18030 78	0.45596 99
6.5	0.81147 67291	-0.24338 05692	0.17841 74	0.45294 98
6.6	0.83820 76824	-0.25931 37161	0.17658 44	0.44998 97
6.7	0.86618 77897	-0.27239 18447	0.17480 64	0.44708 76
6.8	0.89512 09137	-0.28252 78684	0.17308 09	0.44424 15
6.9	0.92470 60635	-0.28966 45218	0.17140 55	0.44144 97
7.0	0.95464 03155	-0.29377 44843	0.16977 82	0.43871 05
7.1	0.98462 17153	-0.29486 02239	0.16819 68	0.43602 22
7.2	1.01435 21344	-0.29295 35658	0.16665 93	0.43338 34
7.3	1.04354 00558	-0.28811 49927	0.16516 39	0.43079 23
7.4	1.07190 32638	-0.28043 26862	0.16370 89	0.42824 76
7.5	1.09917 14142	-0.27002 13202	0.16229 24	0.42574 81
7.6	1.12508 84628	-0.25702 06208	0.16091 30	0.42329 20
7.7	1.14941 49299	-0.24159 37080	0.15956 91	0.42087 86
7.8	1.17192 99830	-0.22392 52368	0.15825 93	0.41850 63
7.9	1.19243 33198	-0.20421 93575	0.15698 21	0.41617 40
8.0	1.21074 68348	-0.18269 75150	0.15573 64	0.41388 07
8.1	1.22671 60587	-0.15959 61109	0.15452 08	0.41162 52
8.2	1.24021 13565	-0.13516 40494	0.15333 42	0.40940 65
8.3	1.25112 88778	-0.10966 01934	0.15217 55	0.40722 37
8.4	1.25939 12520	-0.08335 07540	0.15104 36	0.40507 56
8.5	1.26494 80240	-0.05650 66385	0.14993 74	0.40296 15
8.6	1.26777 58297	-0.02940 07834	0.14885 61	0.40088 04
8.7	1.26787 83120	-0.00230 54965	0.14779 88	0.39883 15
8.8	1.26528 57796	+0.02451 01664	0.14676 44	0.39681 40
8.9	1.26005 46162	0.05078 29664	0.14575 23	0.39482 69
9.0	1.25226 64460	0.07625 79635	0.14476 16	0.39286 97
9.1	1.24202 70675	0.10069 08937	0.14379 16	0.39094 15
9.2	1.22946 51666	0.12385 04194	0.14284 16	0.38904 17
9.3	1.21473 08237	0.14552 02334	0.14191 08	0.38716 95
9.4	1.19799 38314	0.16550 09969	0.14099 87	0.38532 41
9.5	1.17944 18392	0.18361 20962	0.14010 46	0.38350 53
9.6	1.15927 83464	0.19969 32017	0.13922 78	0.38171 20
9.7	1.13772 05614	0.21360 56169	0.13836 79	0.37994 39
9.8	1.11499 71504	0.22523 34059	0.13752 43	0.37820 03
9.9	1.09134 58985	0.23448 42919	0.13669 65	0.37648 06
10.0	1.06701 13040	0.24129 03183	0.13588 40	0.37478 43
	$\left[\begin{smallmatrix} (-4)4 \\ 7 \end{smallmatrix} \right]$	$\left[\begin{smallmatrix} (-4)4 \\ 7 \end{smallmatrix} \right]$	$\left[\begin{smallmatrix} (-5)1 \\ 4 \end{smallmatrix} \right]$	$\left[\begin{smallmatrix} (-5)1 \\ 4 \end{smallmatrix} \right]$

Table 11.2

INTEGRALS OF BESSEL FUNCTIONS

x	$\int_0^x \frac{1-J_0(t)}{t} dt$	$\int_x^\infty \frac{Y_0(t)}{t} dt$	$e^{-x} \int_0^x \frac{I_0(t)-1}{t} dt$	$x e^x \int_x^\infty \frac{K_0(t)}{t} dt$
0.0	0.00000 000	$-\infty$	0.00000 000	0.000000
0.1	0.00124 961	-1.34138 382	0.00113 140	0.368126
0.2	0.00499 375	-0.43423 067	0.00409 877	0.460111
0.3	0.01121 841	-0.05107 832	0.00835 768	0.506394
0.4	0.01990 030	+0.15238 037	0.01347 363	0.532910
0.5	0.03100 699	0.26968 854	0.01910 285	0.548819
0.6	0.04449 711	0.33839 213	0.02497 622	0.558366
0.7	0.06032 057	0.37689 807	0.03088 584	0.563828
0.8	0.07841 882	0.39543 866	0.03667 383	0.566545
0.9	0.09872 519	0.40022 301	0.04222 295	0.567355
1.0	0.12116 525	0.39527 290	0.04744 889	0.566811
1.1	0.14565 721	0.38332 909	0.05229 376	0.565291
1.2	0.17211 240	0.36633 694	0.05672 080	0.563058
1.3	0.20043 570	0.34572 398	0.06070 995	0.560302
1.4	0.23052 610	0.32256 701	0.06425 420	0.557163
1.5	0.26227 724	0.29769 696	0.06735 663	0.553745
1.6	0.29557 796	0.27176 713	0.07002 797	0.550126
1.7	0.33031 288	0.24529 896	0.07228 458	0.546364
1.8	0.36636 308	0.21871 360	0.07414 688	0.542506
1.9	0.40360 666	0.19235 409	0.07563 806	0.538587
2.0	0.44191 940	0.16650 135	0.07678 298	0.534635
2.1	0.48117 541	0.14138 594	0.07760 744	0.530670
2.2	0.52124 775	0.11719 681	0.07813 746	0.526711
2.3	0.56200 913	0.09408 798	0.07839 884	0.522768
2.4	0.60333 248	0.07218 365	0.07841 674	0.518854
2.5	0.64509 164	0.05158 229	0.07821 544	0.514976
2.6	0.68716 194	0.03235 987	0.07781 809	0.511139
2.7	0.72942 081	+0.01457 248	0.07724 664	0.507350
2.8	0.77174 836	-0.00174 144	0.07652 168	0.503610
2.9	0.81402 795	-0.01655 931	0.07566 245	0.499924
3.0	0.85614 669	-0.02987 272	0.07468 681	0.496292
3.1	0.89799 596	-0.04168 613	0.07361 124	0.492717
3.2	0.93947 188	-0.05201 554	0.07245 090	0.489198
3.3	0.98047 571	-0.06088 740	0.07121 963	0.485736
3.4	1.02091 428	-0.06833 756	0.06993 006	0.482332
3.5	1.06070 032	-0.07441 025	0.06859 360	0.478984
3.6	1.09975 277	-0.07915 722	0.06722 060	0.475694
3.7	1.13799 707	-0.08263 683	0.06582 033	0.472459
3.8	1.17536 536	-0.08491 323	0.06440 109	0.469280
3.9	1.21179 667	-0.08605 553	0.06297 029	0.466155
4.0	1.24723 707	-0.08613 706	0.06153 450	0.463085
4.1	1.28163 975	-0.08523 459	0.06009 952	0.460067
4.2	1.31496 504	-0.08342 762	0.05867 042	0.457100
4.3	1.34718 044	-0.08079 769	0.05725 166	0.454185
4.4	1.37826 060	-0.07742 769	0.05584 708	0.451320
4.5	1.40818 716	-0.07340 123	0.05446 000	0.448503
4.6	1.43694 870	-0.06880 199	0.05309 325	0.445734
4.7	1.46454 052	-0.06371 317	0.05174 921	0.443012
4.8	1.49096 446	-0.05821 690	0.05042 989	0.440335
4.9	1.51622 864	-0.05239 371	0.04913 691	0.437703
5.0	1.54034 722	-0.04632 205	0.04787 161	0.435114
	$\left[\begin{smallmatrix} (-4) \\ 6 \end{smallmatrix} \right]$		$\left[\begin{smallmatrix} (-4) \\ 7 \end{smallmatrix} \right]$	

12. Struve Functions and Related Functions

MILTON ABRAMOWITZ¹

Contents

	Page
Mathematical Properties	496
12.1. Struve Function $\mathbf{H}_\nu(z)$	496
12.2. Modified Struve Function $\mathbf{L}_\nu(z)$	498
12.3. Anger and Weber Functions	498
Numerical Methods	499
12.4. Use and Extension of the Tables	499
References	500
Table 12.1. Struve Functions ($0 \leq x \leq \infty$)	501
$\mathbf{H}_0(x), \mathbf{H}_1(x), \int_0^x \mathbf{H}_0(t)dt, I_0(x) - \mathbf{L}_0(x), I_1(x) - \mathbf{L}_1(x), \int_0^x [I_0(t) - \mathbf{L}_0(t)]dt$ $(2/\pi) \int_x^\infty t^{-1} \mathbf{H}_0(t)dt, x=0(.1)5, 5D \text{ to } 7D$	
Table 12.2. Struve Functions for Large Arguments	502
$\mathbf{H}_0(x) - Y_0(x), \mathbf{H}_1(x) - Y_1(x), \int_0^x [\mathbf{H}_0(t) - Y_0(t)]dt - (2/\pi) \ln x$ $I_0(x) - \mathbf{L}_0(x), I_1(x) - \mathbf{L}_1(x), \int_0^x [\mathbf{L}_0(t) - I_0(t)]dt - (2/\pi) \ln x$ $\int_x^\infty [\mathbf{H}_0(t) - Y_0(t)]t^{-1}dt, x^{-1}=.2(-.01)0, 6D$	

The author acknowledges the assistance of Bertha H. Walter in the preparation and checking of the tables.

¹ National Bureau of Standards. (Deceased.)

12. Struve Functions and Related Functions

Mathematical Properties

12.1. Struve Function $\mathbf{H}_\nu(z)$

Differential Equation and General Solution

12.1.1

$$z^2 \frac{d^2 w}{dz^2} + z \frac{dw}{dz} + (z^2 - \nu^2)w = \frac{4(\frac{1}{2}z)^{\nu+1}}{\sqrt{\pi}\Gamma(\nu + \frac{1}{2})}$$

The general solution is

12.1.2 $w = aJ_\nu(z) + bY_\nu(z) + \mathbf{H}_\nu(z)$ (a, b , constants)

where $z^{-\nu}\mathbf{H}_\nu(z)$ is an entire function of z .

Power Series Expansion

12.1.3

$$\mathbf{H}_\nu(z) = (\frac{1}{2}z)^{\nu+1} \sum_{k=0}^{\infty} \frac{(-1)^k (\frac{1}{2}z)^{2k}}{\Gamma(k + \frac{3}{2})\Gamma(k + \nu + \frac{3}{2})}$$

12.1.4 $\mathbf{H}_0(z) = \frac{2}{\pi} \left[z - \frac{z^3}{1 \cdot 2 \cdot 3^2} + \frac{z^5}{1 \cdot 2 \cdot 3^2 \cdot 5^2} - \dots \right]$

12.1.5

$$\mathbf{H}_1(z) = \frac{2}{\pi} \left[\frac{z^2}{1 \cdot 2 \cdot 3} - \frac{z^4}{1 \cdot 2 \cdot 3^2 \cdot 5} + \frac{z^6}{1 \cdot 2 \cdot 3^2 \cdot 5^2 \cdot 7} - \dots \right]$$

Integral Representations

If $\Re \nu > -\frac{1}{2}$,

12.1.6

$$\mathbf{H}_\nu(z) = \frac{2(\frac{1}{2}z)^\nu}{\sqrt{\pi}\Gamma(\nu + \frac{1}{2})} \int_0^1 (1-t^2)^{\nu-\frac{1}{2}} \sin(zt) dt$$

12.1.7 $= \frac{2(\frac{1}{2}z)^\nu}{\sqrt{\pi}\Gamma(\nu + \frac{1}{2})} \int_0^{\frac{\pi}{2}} \sin(z \cos \theta) \sin^{2\nu} \theta d\theta$

12.1.8 $= Y_\nu(z)$

$$+ \frac{2(\frac{1}{2}z)^\nu}{\sqrt{\pi}\Gamma(\nu + \frac{1}{2})} \int_0^\infty e^{-zt} (1+t^2)^{\nu-\frac{1}{2}} dt$$

($|\arg z| < \frac{\pi}{2}$)

Recurrence Relations

12.1.9 $\mathbf{H}_{\nu-1} + \mathbf{H}_{\nu+1} = \frac{2\nu}{z} \mathbf{H}_\nu + \frac{(\frac{1}{2}z)^\nu}{\sqrt{\pi}\Gamma(\nu + \frac{3}{2})}$

12.1.10 $\mathbf{H}_{\nu-1} - \mathbf{H}_{\nu+1} = 2\mathbf{H}'_\nu - \frac{(\frac{1}{2}z)^\nu}{\sqrt{\pi}\Gamma(\nu + \frac{3}{2})}$

12.1.11 $\mathbf{H}'_0 = (2/\pi) - \mathbf{H}_1$

12.1.12 $\frac{d}{dz} (z^\nu \mathbf{H}_\nu) = z^\nu \mathbf{H}_{\nu-1}$

12.1.13 $\frac{d}{dz} (z^{-\nu} \mathbf{H}_\nu) = \frac{1}{\sqrt{\pi} 2^\nu \Gamma(\nu + \frac{3}{2})} - z^{-\nu} \mathbf{H}_{\nu+1}$

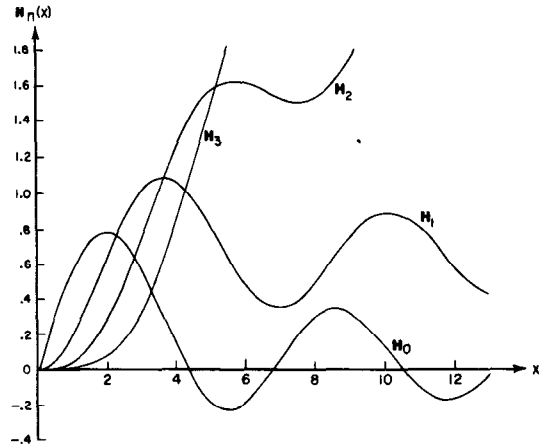

FIGURE 12.1. Struve functions.

$\mathbf{H}_n(x)$, $n=0(1)3$

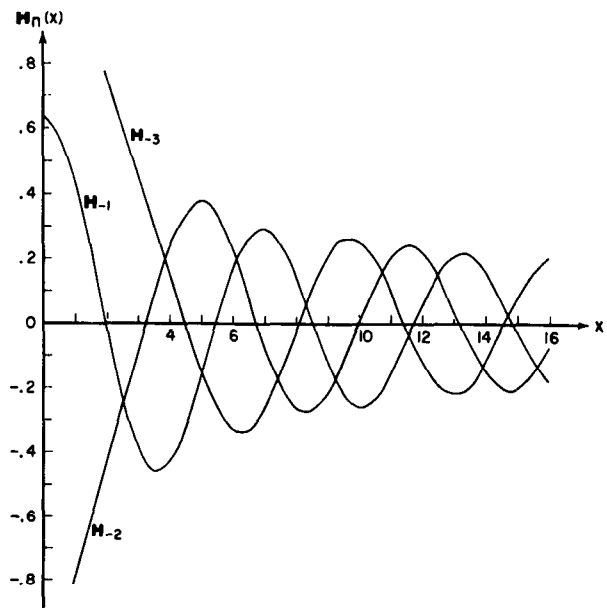

FIGURE 12.2. Struve functions.

$\mathbf{H}_n(x)$, $-n=1(1)3$

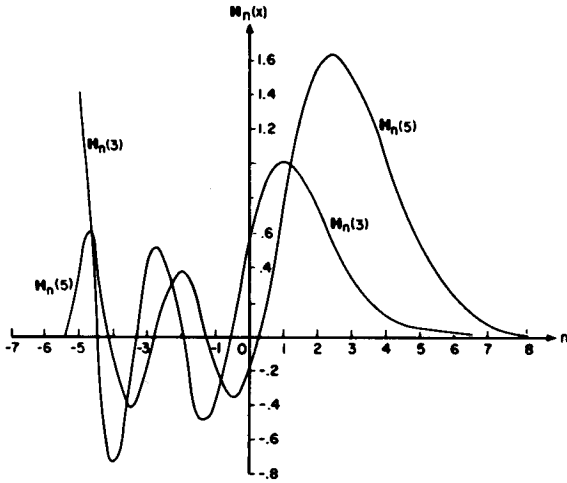

FIGURE 12.3. Struve functions.

$$\mathbf{H}_n(x), x=3, 5$$

Special Properties

12.1.14 $\mathbf{H}_\nu(x) \geq 0$ ($x > 0$ and $\nu \geq \frac{1}{2}$)

12.1.15

$$\mathbf{H}_{-(n+\frac{1}{2})}(z) = (-1)^n \mathbf{J}_{n+\frac{1}{2}}(z) \quad (n \text{ an integer } \geq 0)$$

12.1.16 $\mathbf{H}_1(z) = \left(\frac{2}{\pi z}\right)^{\frac{1}{2}} (1 - \cos z)$

12.1.17

$$\mathbf{H}_1(z) = \left(\frac{z}{2\pi}\right)^{\frac{1}{2}} \left(1 + \frac{2}{z^2}\right) - \left(\frac{2}{\pi z}\right)^{\frac{1}{2}} \left(\sin z + \frac{\cos z}{z}\right)$$

12.1.18 $\mathbf{H}_\nu(ze^{m\pi i}) = e^{m(\nu+1)\pi i} \mathbf{H}_\nu(z)$ (m an integer)

12.1.19 $\mathbf{H}_0(z) = \frac{4}{\pi} \sum_{k=0}^{\infty} \frac{J_{2k+1}(z)}{2k+1}$

12.1.20 $\mathbf{H}_1(z) = \frac{2}{\pi} \frac{2}{\pi} J_0(z) + \frac{4}{\pi} \sum_{k=1}^{\infty} \frac{J_{2k}(z)}{4k^2-1}$

12.1.21 $\mathbf{H}_\nu(z) = \frac{2(z/2)^{\nu+1}}{\sqrt{\pi} \Gamma(\nu+\frac{3}{2})} {}_1F_2\left(1; \frac{3}{2}+\nu, \frac{3}{2}-\frac{z^2}{4}\right)$

Integrals (See chapter 11)

12.1.22 $\int_0^{\infty} t^{-1} \mathbf{H}_0(t) dt = \frac{\pi}{2}$

12.1.23

$$\int_0^z \mathbf{H}_0(t) dt = \frac{2}{\pi} \left[\frac{z^2}{2} - \frac{z^4}{1^2 \cdot 3^2 \cdot 4} + \frac{z^6}{1^2 \cdot 3^2 \cdot 5^2 \cdot 6} - \dots \right]$$

12.1.24 $\int_0^z t^{-\nu} \mathbf{H}_{\nu+1}(t) dt = \frac{z}{2^{\nu} \sqrt{\pi} \Gamma(\nu+\frac{3}{2})} z^{-\nu} \mathbf{H}_\nu(z)$

Struve's Integral

12.1.25

$$\frac{4}{\pi} \int_z^{\infty} t^{-2} \mathbf{H}_1(t) dt = \frac{2}{\pi z} \mathbf{H}_1(z) + \frac{2}{\pi} \int_z^{\infty} t^{-1} \mathbf{H}_0(t) dt$$

12.1.26

$$\frac{2}{\pi} \int_z^{\infty} t^{-1} \mathbf{H}_0(t) dt = 1 - \frac{4}{\pi^2} \left[z - \frac{z^3}{1^2 \cdot 3^2 \cdot 3} + \frac{z^5}{1^2 \cdot 3^2 \cdot 5^2 \cdot 5} - \dots \right]$$

12.1.27

$$\int_0^{\infty} t^{\mu-\nu-1} \mathbf{H}_\nu(t) dt = \frac{\Gamma(\frac{1}{2}\mu) 2^{\mu-\nu-1} \tan(\frac{1}{2}\pi\mu)}{\Gamma(\nu-\frac{1}{2}\mu+1)} \quad (|\Re\mu| < 1, \Re\nu > \Re\mu - \frac{3}{2})$$

If $f_\nu(z) = \int_0^z \mathbf{H}_\nu(t) t^\nu dt$

12.1.28

$$f_{\nu+1} = (2\nu+1)f_\nu(z) - z^{\nu+1} \mathbf{H}_\nu(z) + \frac{z^{2\nu+2}}{(\nu+1)2^{\nu+1}\Gamma(\frac{1}{2})\Gamma(\nu+\frac{3}{2})} \quad (\Re\nu > -\frac{1}{2})$$

Asymptotic Expansions for Large $|z|$

12.1.29

$$\mathbf{H}_\nu(z) - Y_\nu(z) = \frac{1}{\pi} \sum_{k=0}^{m-1} \frac{\Gamma(k+\frac{1}{2})}{\Gamma(\nu+\frac{1}{2}-k)} \left(\frac{z}{2}\right)^{2k-\nu+1} + R_m \quad (\arg z | < \pi)$$

where $R_m = O(|z|^{-2m-1})$. If ν is real, z positive* and $m+\frac{1}{2}-\nu \geq 0$, the remainder after m terms is of the same sign and numerically less than the first term neglected.

12.1.30

$$\mathbf{H}_0(z) - Y_0(z) \sim \frac{2}{\pi} \left[\frac{1}{z} - \frac{1}{z^3} + \frac{1^2 \cdot 3^2}{z^5} - \frac{1^2 \cdot 3^2 \cdot 5^2}{z^7} + \dots \right] \quad (\arg z | < \pi)$$

12.1.31

$$\mathbf{H}_1(z) - Y_1(z) \sim \frac{2}{\pi} \left[1 + \frac{1}{z^2} - \frac{1^2 \cdot 3}{z^4} + \frac{1^2 \cdot 3^2 \cdot 5}{z^6} - \dots \right] \quad (\arg z | < \pi)$$

12.1.32

$$\int_0^z [\mathbf{H}_0(t) - Y_0(t)] dt \sim \frac{2}{\pi} [\ln(2z) + \gamma] \sim \frac{2}{\pi} \sum_{k=1}^{\infty} \frac{(-1)^{k+1} (2k)! (2k-1)!}{(k!)^2 (2z)^{2k}} \quad (\arg z | < \pi)$$

where $\gamma = .57721 56649 \dots$ is Euler's constant.

12.1.33

$$\int_z^{\infty} t^{-1} [\mathbf{H}_0(t) - Y_0(t)] dt \sim \frac{2}{\pi z} \sum_{k=0}^{\infty} \frac{(-1)^k [(2k)!]^2}{(k!)^2 (2k+1) (2z)^{2k}} \quad (\arg z | < \pi)$$

*See page 11.

Asymptotic Expansions for Large Orders

12.1.34

$$\mathbf{H}_\nu(z) - Y_\nu(z) \sim \frac{2(\frac{1}{2}z)^\nu}{\sqrt{\pi}\Gamma(\nu+\frac{1}{2})} \sum_{k=0}^{\infty} \frac{k! b_k}{z^{k+1}} \quad (|\arg z| < \frac{1}{2}\pi, |\nu| < |z|)$$

$$b_0=1, b_1=2\nu/z, b_2=6(\nu/z)^2-\frac{1}{2}, b_3=20(\nu/z)^3-4(\nu/z)$$

12.1.35

$$\mathbf{H}_\nu(z) + iJ_\nu(z) \sim \frac{2(\frac{1}{2}z)^\nu}{\sqrt{\pi}\Gamma(\nu+\frac{1}{2})} \sum_{k=0}^{\infty} \frac{k! b_k}{z^{k+1}} \quad (|\nu| > |z|)$$

12.2. Modified Struve Function $\mathbf{L}_\nu(z)$

Power Series Expansion

12.2.1
$$\mathbf{L}_\nu(z) = -ie^{-\frac{i\pi\nu}{2}} \mathbf{H}_\nu(iz)$$

$$= (\frac{1}{2}z)^{\nu+1} \sum_{k=0}^{\infty} \frac{(z/2)^{2k}}{\Gamma(k+\frac{3}{2})\Gamma(k+\nu+\frac{3}{2})}$$

Integral Representations

12.2.2
$$\mathbf{L}_\nu(z) = \frac{2(z/2)^\nu}{\sqrt{\pi}\Gamma(\nu+\frac{1}{2})} \int_0^{\frac{\pi}{2}} \sinh(z \cos \theta) \sin^{2\nu} \theta d\theta$$

$$(\Re \nu > -\frac{1}{2})$$

12.2.3

$$I_{-\nu}(x) - \mathbf{L}_\nu(x) = \frac{2(x/2)^\nu}{\sqrt{\pi}\Gamma(\nu+\frac{1}{2})} \int_0^\infty \sin(tx) (1+t^2)^{\nu-1} dt$$

$$(\Re \nu < \frac{1}{2}, x > 0)$$

Recurrence Relations

12.2.4
$$\mathbf{L}_{\nu-1} - \mathbf{L}_{\nu+1} = \frac{2\nu}{z} \mathbf{L}_\nu + \frac{(z/2)^\nu}{\sqrt{\pi}\Gamma(\nu+\frac{3}{2})}$$

12.2.5
$$\mathbf{L}_{\nu-1} + \mathbf{L}_{\nu+1} = 2\mathbf{L}'_\nu - \frac{(z/2)^\nu}{\sqrt{\pi}\Gamma(\nu+\frac{3}{2})}$$

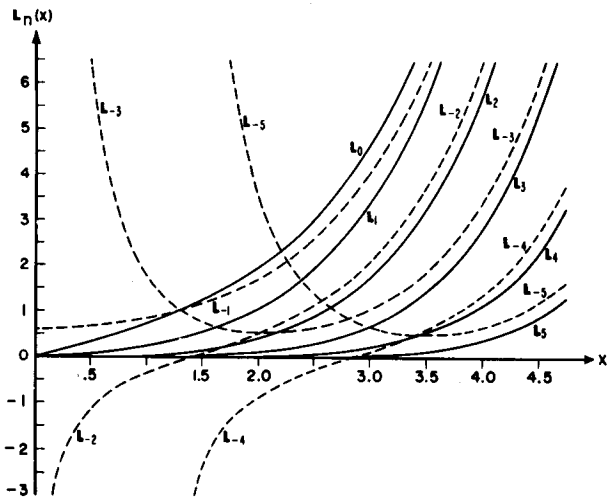

FIGURE 12.4. Modified Struve functions.

$$\mathbf{L}_n(x), \pm n=0(1)5$$

Asymptotic Expansion for Large $|z|$

12.2.6 $\mathbf{L}_\nu(z) - I_{-\nu}(z)$

$$\sim \frac{1}{\pi} \sum_{k=0}^{\infty} \frac{(-1)^{k+1} \Gamma(k+\frac{1}{2})}{\Gamma(\nu+\frac{1}{2}-k)} \left(\frac{z}{2}\right)^{2k-\nu+1} \quad (|\arg z| < \frac{1}{2}\pi)$$

Integrals

12.2.7

$$\int_0^z \mathbf{L}_0(t) dt = \frac{2}{\pi} \left[\frac{z^2}{2} + \frac{z^4}{1^2 \cdot 3^2 \cdot 4} + \frac{z^6}{1^2 \cdot 3^2 \cdot 5^2 \cdot 6} + \dots \right]$$

12.2.8
$$\int_0^z [I_0(t) - \mathbf{L}_0(t)] dt = \frac{2}{\pi} [\ln(2z) + \gamma]$$

$$\sim -\frac{2}{\pi} \sum_{k=1}^{\infty} \frac{(2k)! (2k-1)!}{(k!)^2 (2z)^{2k}} \quad (|\arg z| < \frac{1}{2}\pi)$$

12.2.9
$$\int_0^z \mathbf{L}_1(t) dt = \mathbf{L}_0(z) - \frac{2}{\pi} z$$

Relation to Modified Spherical Bessel Function

12.2.10
$$\mathbf{L}_{-(n+\frac{1}{2})}(z) = I_{(n+\frac{1}{2})}(z) \quad (n \text{ an integer } \geq 0)$$

12.3. Anger and Weber Functions

Anger's Function

12.3.1
$$\mathbf{J}_\nu(z) = \frac{1}{\pi} \int_0^\pi \cos(\nu\theta - z \sin \theta) d\theta$$

12.3.2
$$\mathbf{J}_n(z) = J_n(z) \quad (n \text{ an integer})$$

Weber's Function

12.3.3
$$\mathbf{E}_\nu(z) = \frac{1}{\pi} \int_0^\pi \sin(\nu\theta - z \sin \theta) d\theta$$

Relations Between Anger's and Weber's Function

12.3.4
$$\sin(\nu\pi) \mathbf{J}_\nu(z) = \cos(\nu\pi) \mathbf{E}_\nu(z) - \mathbf{E}_{-\nu}(z)$$

12.3.5
$$\sin(\nu\pi) \mathbf{E}_\nu(z) = \mathbf{J}_{-\nu}(z) - \cos(\nu\pi) \mathbf{J}_\nu(z)$$

Relations Between Weber's Function and Struve's Function

If n is a positive integer or zero,

12.3.6
$$\mathbf{E}_n(z) = \frac{1}{\pi} \sum_{k=0}^{\lfloor \frac{n-1}{2} \rfloor} \frac{\Gamma(k+\frac{1}{2}) (\frac{1}{2}z)^{n-2k-1}}{\Gamma(n+\frac{1}{2}-k)} \mathbf{H}_n(z) \quad *$$

12.3.7

$$\mathbf{E}_{-n}(z) = \frac{(-1)^{n+1}}{\pi} \sum_{k=0}^{\lfloor \frac{n-1}{2} \rfloor} \frac{\Gamma(n-k-\frac{1}{2}) (\frac{1}{2}z)^{-n+2k+1}}{\Gamma(k+\frac{3}{2})} \mathbf{H}_{-n}(z) \quad *$$

*See page II.

12.3.8 $E_0(z) = -H_0(z)$

12.3.9 $E_1(z) = \frac{2}{\pi} H_1(z)$

12.3.10 $E_2(z) = \frac{2z}{3\pi} H_2(z)$

Numerical Methods

12.4. Use and Extension of the Tables

Example 1. Compute $L_0(2)$ to 6D. From **Table 12.1** $I_0(2) - L_0(2) = .342152$; from **Table 9.11** we have $I_0(2) = 2.279585$ so that $L_0(2) = 1.937433$.

Example 2. Compute $H_0(10)$ to 6D. From **Table 12.2** for $x^{-1} = .1$, $H_0(10) - Y_0(10) = .063072$; from **Table 9.1** we have $Y_0(10) = .055671$. Thus, $H_0(10) = .118743$.

Example 3. Compute $\int_0^x H_0(t) dt$ for $x=6$ to 5D. Using **Tables 12.2, 11.1** and 4.2, we have

$$\begin{aligned} \int_0^6 H_0(t) dt &= \int_0^6 Y_0(t) dt + \frac{2}{\pi} \ln 6 + f_1(6) \\ &= -.125951 + (.636620)(1.791759) \\ &\quad + .816764 \\ &= 1.83148 \end{aligned}$$

Example 4. Compute $H_n(x)$ for $x=4$, $-n=0(1)8$ to 6S. From **Table 12.1** we have $H_0(4) = .1350146$, $H_1(4) = 1.0697267$. Using **12.1.9** we find

$H_{-1}(4) = -.433107$	$H_{-5}(4) = .689652$
$H_{-2}(4) = .240694$	$H_{-6}(4) = -1.21906$
$H_{-3}(4) = .152624$	$H_{-7}(4) = 2.82066$
$H_{-4}(4) = -.439789$	$H_{-8}(4) = -8.24933$

Example 5. Compute $H_n(x)$ for $x=4$, $n=0(1)10$ to 7S. Starting with the values of $H_0(4)$ and $H_1(4)$ and using **12.1.9** with forward recurrence, we get

$H_0(4) = .13501 46$	$H_6(4) = .05433 54$
$H_1(4) = 1.06972 67$	$H_7(4) = .01510 37$
$H_2(4) = 1.24867 51$	$H_8(4) = .00367 33$
$H_3(4) = .85800 95$	$H_9(4) = .00080 02$
$H_4(4) = .42637 41$	$H_{10}(4) = .00018 25$
$H_5(4) = .16719 87$	

We note that for $n > 6$ there is a rapid loss of significant figures. On the other hand using **12.1.3** for $x=4$ we find $H_6(4) = .0007935729$, $H_{10}(4) = .00015447630$ and backward recurrence with **12.1.9** gives

$H_8(4) = .00367 1495$	$H_3(4) = .85800 94$
$H_7(4) = .01510 315$	$H_2(4) = 1.24867 6$
$H_6(4) = .05433 519$	$H_1(4) = 1.06972 7$
$H_5(4) = .16719 87$	$H_0(4) = .13501 4$
$H_4(4) = .42637 43$	

Example 6. Compute $L_n(.5)$ for $n=0(1)5$ to 8S. From **12.2.1** we find $L_5(.5) = 9.6307462 \times 10^{-7}$, $L_4(.5) = 2.1212342 \times 10^{-5}$. Then, with **12.2.4** we get

$L_3(.5) = 3.82465 03 \times 10^{-4}$	$L_1(.5) = .05394 2181$
$L_2(.5) = 5.36867 34 \times 10^{-3}$	$L_0(.5) = .32724 068$

Example 7. Compute $L_n(.5)$ for $-n=0(1)5$ to 6S. From **Tables 12.1** and **9.8** we find $L_0(.5) = .327240$, $L_1(.5) = .053942$. Then employing **12.2.4** with backward recurrence we get

$L_{-1}(.5) = .690562$	$L_{-4}(.5) = -75.1418$
$L_{-2}(.5) = -1.16177$	$L_{-5}(.5) = 1056.92$
$L_{-3}(.5) = 7.43824$	

Example 8. Compute $L_n(x)$ for $x=6$ and $-n=0(1)6$ to 8S. From **Tables 12.2** and **9.8** we find $L_0(6) = 67.124454$, $L_1(6) = 60.725011$. Using **12.2.4** we get

$L_{-1}(6) = 61.361631$	$L_{-4}(6) = 16.626028$
$L_{-2}(6) = 46.776680$	$L_{-5}(6) = 7.984089$
$L_{-3}(6) = 30.159494$	$L_{-6}(6) = 3.32780$

We note that there is no essential loss of accuracy until $n = -6$. However, if further values were necessary the recurrence procedure becomes unstable. To avoid the instability use the methods described in **Examples 5** and **6**.

References

Texts

- [12.1] R. K. Cook, Some properties of Struve functions, *J. Washington Acad. Sci.* **47**, 11, 365–368 (1957).
- [12.2] A. Erdélyi et al., Higher transcendental functions, vol. 2, ch. 7 (McGraw-Hill Book Co., Inc., New York, N.Y., 1953).
- [12.3] A. Gray and G. B. Mathews, A treatise on Bessel functions, ch. 14 (The Macmillan Co., New York, N.Y., 1931).
- [12.4] N. W. McLachlan, Bessel functions for engineers, 2d ed. ch. 4 (Clarendon Press, Oxford, England, 1955).
- [12.5] F. Oberhettinger, On some expansions for Bessel integral functions, *J. Research NBS* **59** (1957) RP2786.
- [12.6] G. Petiau, La théorie des fonctions de Bessel, ch. 10 (Centre National de la Recherche Scientifique, Paris, France, 1955).
- [12.7] G. N. Watson, A treatise on the theory of Bessel functions, ch. 10 (Cambridge Univ. Press, Cambridge, England, 1958).

Tables

- [12.8] M. Abramowitz, Tables of integrals of Struve functions, *J. Math. Phys.* **29**, 49–51 (1950).
- [12.9] C. W. Horton, On the extension of some Lommel integrals to Struve functions with an application to acoustic radiation, *J. Math. Phys.* **29**, 31–37 (1950).
- [12.10] C. W. Horton, A short table of Struve functions and of some integrals involving Bessel and Struve functions, *J. Math. Phys.* **29**, 56–58 (1950).
- [12.11] Mathematical Tables Project, Table of the Struve functions $L_n(x)$ and $H_n(x)$, *J. Math. Phys.* **25**, 252–259 (1946).

STRUVE FUNCTIONS

Table 12.1

x	$H_0(x)$	$H_1(x)$	$\int_0^x H_0(t)dt$	$I_0(x) - L_0(x)$	$I_1(x) - L_1(x)$	$f_0(x)$	$\frac{2}{\pi} \int_x^\infty \frac{H_0(t)}{t} dt$
0.0	0.00000 00	0.00000 00	0.000000	1.000000	0.000000	0.00000	1.000000
0.1	0.06359 13	0.00212 07	0.003181	0.938769	0.047939	0.09690	0.959487
0.2	0.12675 90	0.00846 57	0.012704	0.882134	0.091990	0.18791	0.919063
0.3	0.18908 29	0.01898 43	0.028505	0.829724	0.132480	0.27347	0.878819
0.4	0.25014 97	0.03359 25	0.050479	0.781198	0.169710	0.35398	0.838843
0.5	0.30955 59	0.05217 37	0.078480	0.736243	0.203952	0.42982	0.799223
0.6	0.36691 14	0.07457 97	0.112322	0.694573	0.235457	0.50134	0.760044
0.7	0.42184 24	0.10063 17	0.151781	0.655927	0.264454	0.56884	0.721389
0.8	0.47399 44	0.13012 25	0.196597	0.620063	0.291151	0.63262	0.683341
0.9	0.52303 50	0.16281 75	0.246476	0.586763	0.315740	0.69294	0.645976
1.0	0.56865 66	0.19845 73	0.301090	0.555823	0.338395	0.75005	0.609371
1.1	0.61057 87	0.23675 97	0.360084	0.527058	0.359276	0.80418	0.573596
1.2	0.64855 00	0.27742 18	0.423074	0.500300	0.378530	0.85553	0.538719
1.3	0.68235 03	0.32012 31	0.489655	0.475391	0.396290	0.90430	0.504803
1.4	0.71179 25	0.36452 80	0.559399	0.452188	0.412679	0.95066	0.471907
1.5	0.73672 35	0.41028 85	0.631863	0.430561	0.427810	0.99479	0.440086
1.6	0.75702 55	0.45704 72	0.706590	0.410388	0.441783	1.03682	0.409388
1.7	0.77261 68	0.50444 07	0.783111	0.391558	0.454694	1.07691	0.379857
1.8	0.78345 23	0.55210 21	0.860954	0.373970	0.466629	1.11518	0.351533
1.9	0.78952 36	0.59966 45	0.939643	0.357530	0.477666	1.15174	0.324450
2.0	0.79085 88	0.64676 37	1.018701	0.342152	0.487877	1.18672	0.298634
2.1	0.78752 22	0.69304 18	1.097659	0.327756	0.497329	1.22020	0.274109
2.2	0.77961 35	0.73814 96	1.176053	0.314270	0.506083	1.25230	0.250891
2.3	0.76726 65	0.78174 98	1.253434	0.301627	0.514194	1.28309	0.228992
2.4	0.75064 85	0.82351 98	1.329364	0.289765	0.521712	1.31265	0.208417
2.5	0.72995 77	0.86315 42	1.403427	0.278627	0.528685	1.34106	0.189168
2.6	0.70542 23	0.90036 74	1.475227	0.268162	0.535156	1.36840	0.171238
2.7	0.67729 77	0.93489 57	1.544392	0.258319	0.541164	1.39472	0.154618
2.8	0.64586 46	0.96649 98	1.610577	0.249056	0.546746	1.42008	0.139293
2.9	0.61142 64	0.99496 63	1.673465	0.240332	0.551933	1.44455	0.125242
3.0	0.57430 61	1.02010 96	1.732773	0.232107	0.556757	1.46816	0.112439
3.1	0.53484 44	1.04177 30	1.788248	0.224348	0.561246	1.49098	0.100857
3.2	0.49339 57	1.05983 03	1.839675	0.217022	0.565426	1.51305	0.090460
3.3	0.45032 57	1.07418 63	1.886873	0.210099	0.569319	1.53440	0.081212
3.4	0.40600 80	1.08477 74	1.929699	0.203553	0.572948	1.55508	0.073071
3.5	0.36082 08	1.09157 23	1.968046	0.197357	0.576333	1.57512	0.065992
3.6	0.31514 40	1.09457 16	2.001847	0.191488	0.579492	1.59456	0.059928
3.7	0.26935 59	1.09380 77	2.031071	0.185924	0.582442	1.61343	0.054829
3.8	0.22382 98	1.08934 44	2.055726	0.180646	0.585199	1.63176	0.050642
3.9	0.17893 12	1.08127 62	2.075858	0.175634	0.587776	1.64957	0.047311
4.0	0.13501 46	1.06972 67	2.091545	0.170872	0.590187	1.66689	0.044781
4.1	0.09242 08	1.05484 79	2.102905	0.166343	0.592445	1.68375	0.042994
4.2	0.05147 40	1.03681 86	2.110084	0.162032	0.594560	1.70017	0.041891
4.3	+0.01247 93	1.01584 22	2.113265	0.157926	0.596542	1.71616	0.041414
4.4	-0.02427 98	0.99214 51	2.112655	0.154012	0.598402	1.73176	0.041502
4.5	-0.05854 33	0.96597 44	2.108492	0.150279	0.600147	1.74697	0.042096
4.6	-0.09007 71	0.93759 56	2.101037	0.146714	0.601787	1.76182	0.043139
4.7	-0.11867 42	0.90729 01	2.090574	0.143309	0.603328	1.77632	0.044571
4.8	-0.14415 67	0.87535 28	2.077406	0.140053	0.604777	1.79049	0.046335
4.9	-0.16637 66	0.84208 90	2.061852	0.136938	0.606142	1.80434	0.048376
5.0	-0.18521 68	0.80781 19	2.044244	0.133955	0.607426	1.81788	0.050640
	$\left[\begin{smallmatrix} (-4)6 \\ 5 \end{smallmatrix} \right]$	$\left[\begin{smallmatrix} (-4)5 \\ 5 \end{smallmatrix} \right]$	$\left[\begin{smallmatrix} (-4)8 \\ 5 \end{smallmatrix} \right]$	$\left[\begin{smallmatrix} (-4)6 \\ 5 \end{smallmatrix} \right]$	$\left[\begin{smallmatrix} (-4)5 \\ 5 \end{smallmatrix} \right]$	$\left[\begin{smallmatrix} (-4)7 \\ 4 \end{smallmatrix} \right]$	$\left[\begin{smallmatrix} (-4)2 \\ 4 \end{smallmatrix} \right]$

$$\int_0^x [I_0(t) - L_0(t)] dt = f_0(x)$$

$H_0(x)$, $H_1(x)$, $L_0(x)$, $L_1(x)$, compiled from Mathematical Tables Project, Table of the Struve functions $L_\nu(x)$ and $H_\nu(x)$, J. Math. Phys. 25, 252-259, 1946 (with permission).

$\int_0^x H_0(t)dt$, $\int_0^x [I_0(t) - L_0(t)]dt$, $\frac{2}{\pi} \int_x^\infty \frac{H_0(t)}{t} dt$, compiled from M. Abramowitz, Tables of integrals of Struve functions, J. Math. Phys. 29, 49-51, 1950 (with permission).

Table 12.2 STRUVE FUNCTIONS FOR LARGE ARGUMENTS

x^{-1}	$H_0(x) - Y_0(x)$	$H_1(x) - Y_1(x)$	$f_1(x)$	$I_0(x) - L_0(x)$	$I_1(x) - L_1(x)$	$f_2(x)$	$f_3(x)$	$\langle x \rangle$
0.20	0.123301	0.659949	0.819924	0.133955	0.607426	0.793280	0.125868	5
0.19	0.117449	0.657819	0.818935	0.126683	0.610467	0.794902	0.119694	5
0.18	0.111556	0.655774	0.817981	0.119468	0.613348	0.796448	0.113505	6
0.17	0.105625	0.653818	0.817062	0.112319	0.616060	0.797910	0.107299	6
0.16	0.099655	0.651952	0.816182	0.105242	0.618598	0.799279	0.101079	6
0.15	0.093647	0.650180	0.815341	0.098241	0.620955	0.800551	0.094843	7
0.14	0.087602	0.648504	0.814541	0.091318	0.623129	0.801721	0.088593	7
0.13	0.081521	0.646927	0.813785	0.084474	0.625119	0.802787	0.082328	8
0.12	0.075404	0.645452	0.813074	0.077706	0.626927	0.803750	0.076051	8
0.11	0.069254	0.644081	0.812411	0.071010	0.628558	0.804611	0.069761	9
0.10	0.063072	0.642817	0.811796	0.064379	0.630018	0.805374	0.063460	10
0.09	0.056860	0.641663	0.811232	0.057805	0.631315	0.806047	0.057147	11
0.08	0.050620	0.640622	0.810722	0.051279	0.632457	0.806634	0.050824	13
0.07	0.044354	0.639696	0.810266	0.044793	0.633450	0.807140	0.044492	14
0.06	0.038064	0.638888	0.809866	0.038340	0.634302	0.807572	0.038152	17
0.05	0.031753	0.638200	0.809525	0.031912	0.635016	0.807933	0.031805	20
0.04	0.025425	0.637634	0.809244	0.025506	0.635596	0.808225	0.025451	25
0.03	0.019082	0.637191	0.809023	0.019116	0.636045	0.808450	0.019093	33
0.02	0.012727	0.636874	0.808865	0.012738	0.636365	0.808611	0.012731	50
0.01	0.006366	0.636683	0.808770	0.006367	0.636556	0.808706	0.006366	100
0.00	0.000000	0.636620	0.808738	0.000000	0.636620	0.808738	0.000000	∞
	$\left[\begin{smallmatrix} (-6)5 \\ 3 \end{smallmatrix} \right]$	$\left[\begin{smallmatrix} (-5)2 \\ 3 \end{smallmatrix} \right]$	$\left[\begin{smallmatrix} (-6)8 \\ 3 \end{smallmatrix} \right]$	$\left[\begin{smallmatrix} (-5)1 \\ 3 \end{smallmatrix} \right]$	$\left[\begin{smallmatrix} (-5)2 \\ 3 \end{smallmatrix} \right]$	$\left[\begin{smallmatrix} (-5)1 \\ 3 \end{smallmatrix} \right]$	$\left[\begin{smallmatrix} (-6)2 \\ 3 \end{smallmatrix} \right]$	

$$\int_0^x [H_0(t) - Y_0(t)] dt = \frac{2}{\pi} \ln x + f_1(x)$$

$$\int_0^x [L_0(t) - I_0(t)] dt = \frac{2}{\pi} \ln x + f_2(x)$$

$$\int_x^\infty \left[\frac{H_0(t) - Y_0(t)}{t} \right] dt = f_3(x)$$

$\langle x \rangle =$ nearest integer to x .

Starting with $H_0(x)$ and $H_1(x)$, recurrence formula 12.1.9 may be used to generate $H_n(x)$ for $n < 0$. As long as $n < x/2$ (approx.), $H_n(x)$ may be generated by forward recurrence. When $n > x/2$, forward recurrence is unstable. To avoid the instability, choose $n > x$, compute $H_k(x)$ and $H_{k+1}(x)$ with 12.1.3, and then use backward recurrence with 12.1.9.

If $n > 0$, $L_n(x)$ must be generated by backward recurrence. If $n < 0$, $L_n(x)$ may be generated by backward recurrence as long as $L_n(x)$ increases. If $n < 0$ and $L_n(x)$ is decreasing, forward recurrence should be used.

See Examples 4-8.

13. Confluent Hypergeometric Functions

LUCY JOAN SLATER¹

Contents

	Page
Mathematical Properties	504
13.1. Definitions of Kummer and Whittaker Functions	504
13.2. Integral Representations	505
13.3. Connections With Bessel Functions	506
13.4. Recurrence Relations and Differential Properties	506
13.5. Asymptotic Expansions and Limiting Forms	508
13.6. Special Cases	509
13.7. Zeros and Turning Values	510
Numerical Methods	511
13.8. Use and Extension of the Tables	511
13.9. Calculation of Zeros and Turning Points	513
13.10. Graphing $M(a, b, x)$	513
References	514
Table 13.1. Confluent Hypergeometric Function $M(a, b, x)$	516
$x=.1(.1)1(1)10, a=-1(.1)1, b=.1(.1)1, 8S$	
Table 13.2. Zeros of $M(a, b, x)$	535
$a=-1(.1)-.1, b=.1(.1)1, 7D$	

The tables were calculated by the author on the electronic calculator EDSACI in the Mathematical Laboratory of Cambridge University, by kind permission of its director, Dr. M. V. Wilkes. The table of $M(a, b, x)$ was recomputed by Alfred E. Beam for uniformity to eight significant figures.

¹ University Mathematical Laboratory, Cambridge. (Prepared under contract with the National Bureau of Standards.)

13. Confluent Hypergeometric Functions

Mathematical Properties

13.1. Definitions of Kummer and Whittaker Functions

Kummer's Equation

$$13.1.1 \quad z \frac{d^2 w}{dz^2} + (b-z) \frac{dw}{dz} - aw = 0$$

It has a regular singularity at $z=0$ and an irregular singularity at ∞ .

Independent solutions are

Kummer's Function

13.1.2

$$M(a, b, z) = 1 + \frac{az}{b} + \frac{(a)_2 z^2}{(b)_2 2!} + \dots + \frac{(a)_n z^n}{(b)_n n!} + \dots$$

where

$$(a)_n = a(a+1)(a+2) \dots (a+n-1), (a)_0 = 1,$$

and

13.1.3

$$U(a, b, z) = \frac{\pi}{\sin \pi b} \left\{ \frac{M(a, b, z)}{\Gamma(1+a-b)\Gamma(b)} - z^{1-b} \frac{M(1+a-b, 2-b, z)}{\Gamma(a)\Gamma(2-b)} \right\}$$

<i>Parameters</i> (<i>m, n</i> positive integers)	<i>M(a, b, z)</i>
$b \neq -n \quad a \neq -m$	a convergent series for all values of a, b and z
$b \neq -n \quad a = -m$	a polynomial of degree m in z
$b = -n \quad a \neq -m$	
$b = -n \quad a = -m,$	a simple pole at $b = -n$
$m > n$	

$b = -n \quad a = -m,$ undefined
 $m \leq n$

$U(a, b, z)$ is defined even when $b \rightarrow \pm n$
As $|z| \rightarrow \infty,$

13.1.4

$$M(a, b, z) = \frac{\Gamma(b)}{\Gamma(a)} e^z z^{a-b} [1 + O(|z|^{-1})] \quad (\Re z > 0)$$

and

13.1.5

$$M(a, b, z) = \frac{\Gamma(b)}{\Gamma(b-a)} (-z)^{-a} [1 + O(|z|^{-1})] \quad (\Re z < 0)$$

$U(a, b, z)$ is a many-valued function. Its principal branch is given by $-\pi < \arg z \leq \pi$.

Logarithmic Solution

13.1.6

$$U(a, n+1, z) = \frac{(-1)^{n+1}}{n! \Gamma(a-n)} \left[M(a, n+1, z) \ln z + \sum_{r=0}^n \frac{(a)_r z^r}{(n+1)_r r!} \{ \psi(a+r) - \psi(1+r) - \psi(1+n+r) \} \right] + \frac{(n-1)!}{\Gamma(a)} z^{-n} M(a-n, 1-n, z)_n$$

for $n=0, 1, 2, \dots$, where the last function is the sum to n terms. It is to be interpreted as zero when $n=0$, and $\psi(a) = \Gamma'(a)/\Gamma(a)$.

$$13.1.7 \quad U(a, 1-n, z) = z^n U(a+n, 1+n, z)$$

As $\Re z \rightarrow \infty$

$$13.1.8 \quad U(a, b, z) = z^{-a} [1 + O(|z|^{-1})]$$

Analytic Continuation

13.1.9

$$U(a, b, z e^{\pm \pi i}) = \frac{\pi}{\sin \pi b} e^{-z} \left\{ \frac{M(b-a, b, z)}{\Gamma(1+a-b)\Gamma(b)} - \frac{e^{\pm \pi i(1-b)} z^{1-b} M(1-a, 2-b, z)}{\Gamma(a)\Gamma(2-b)} \right\}$$

where either upper or lower signs are to be taken throughout.

13.1.10

$$U(a, b, z e^{2\pi i n}) = [1 - e^{-2\pi i b n}] \frac{\Gamma(1-b)}{\Gamma(1+a-b)} M(a, b, z) + e^{-2\pi i b n} U(a, b, z)$$

Alternative Notations

${}_1F_1(a; b; z)$ or $\Phi(a; b; z)$ for $M(a, b, z)$

$z^{-a} {}_2F_0(a, 1+a-b; ; -1/z)$ or $\Psi(a; b; z)$ for $U(a, b, z)$

Complete Solution

$$13.1.11 \quad y = AM(a, b, z) + BU(a, b, z)$$

where A and B are arbitrary constants, $b \neq -n$.

Eight Solutions

$$13.1.12 \quad y_1 = M(a, b, z)$$

$$13.1.13 \quad y_2 = z^{1-b} M(1+a-b, 2-b, z)$$

$$13.1.14 \quad y_3 = e^z M(b-a, b, -z)$$

13.1.15 $y_4 = z^{1-b}e^z M(1-a, 2-b, -z)$

13.1.16 $y_5 = U(a, b, z)$

13.1.17 $y_6 = z^{1-b}U(1+a-b, 2-b, z)$

13.1.18 $y_7 = e^z U(b-a, b, -z)$

13.1.19 $y_8 = z^{1-b}e^z U(1-a, 2-b, -z)$

Wronskians

If $W\{m, n\} = y_m y_n' - y_n y_m'$ and
 $\epsilon = \text{sgn}(\Im z) = 1$ if $\Im z > 0$,
 $= -1$ if $\Im z \leq 0$

13.1.20

$W\{1, 2\} = W\{3, 4\} = W\{1, 4\} = -W\{2, 3\}$
 $= (1-b)z^{-b}e^z$

13.1.21

$W\{1, 3\} = W\{2, 4\} = W\{5, 6\} = W\{7, 8\} = 0$

13.1.22 $W\{1, 5\} = -\Gamma(b)z^{-b}e^z/\Gamma(a)$

13.1.23 $W\{1, 7\} = \Gamma(b)e^{\epsilon\pi i b}z^{-b}e^z/\Gamma(b-a)$

13.1.24 $W\{2, 5\} = -\Gamma(2-b)z^{-b}e^z/\Gamma(1+a-b)$

13.1.25 $W\{2, 7\} = -\Gamma(2-b)z^{-b}e^z/\Gamma(1-a)$

13.1.26 $W\{5, 7\} = e^{\epsilon\pi i(b-a)}z^{-b}e^z$

Kummer Transformations

13.1.27 $M(a, b, z) = e^z M(b-a, b, -z)$

13.1.28

$z^{1-b}M(1+a-b, 2-b, z) = z^{1-b}e^z M(1-a, 2-b, -z)$

13.1.29 $U(a, b, z) = z^{1-b}U(1+a-b, 2-b, z)$

13.1.30

$e^z U(b-a, b, -z) = e^{\epsilon\pi i(1-b)}e^z z^{1-b}U(1-a, 2-b, -z)$

Whittaker's Equation

13.1.31 $\frac{d^2 w}{dz^2} + \left[-\frac{1}{4} + \frac{\kappa}{z} + \frac{(\frac{1}{2} - \mu^2)}{z^2}\right] w = 0$

Solutions:

Whittaker's Functions

13.1.32 $M_{\kappa, \mu}(z) = e^{-\frac{1}{2}z} z^{\frac{1}{2}+\mu} M(\frac{1}{2}+\mu-\kappa, 1+2\mu, z)$

13.1.33

$W_{\kappa, \mu}(z) = e^{-\frac{1}{2}z} z^{\frac{1}{2}+\mu} U(\frac{1}{2}+\mu-\kappa, 1+2\mu, z)$
 $(-\pi < \arg z \leq \pi, \kappa = \frac{1}{2}b-a, \mu = \frac{1}{2}b-\frac{1}{2})$

13.1.34

$W_{\kappa, \mu}(z) = \frac{\Gamma(-2\mu)}{\Gamma(\frac{1}{2}-\mu-\kappa)} M_{\kappa, \mu}(z) + \frac{\Gamma(2\mu)}{\Gamma(\frac{1}{2}+\mu-\kappa)} M_{\kappa, -\mu}(z)$

General Confluent Equation

13.1.35

$w'' + \left[\frac{2A}{Z} + 2f' + \frac{bh'}{h} - h' - \frac{h''}{h'}\right] w'$
 $+ \left[\left(\frac{bh'}{h} - h' - \frac{h''}{h'}\right)\left(\frac{A}{Z} + f'\right) + \frac{A(A-1)}{Z^2}\right. \\ \left. + \frac{2Af'}{Z} + f'' + f'^2 - \frac{ah'^2}{h}\right] w = 0$

Solutions:

13.1.36 $Z^{-A}e^{-f(Z)}M(a, b, h(Z))$

13.1.37 $Z^{-A}e^{-f(Z)}U(a, b, h(Z))$

13.2. Integral Representations

$\Re b > \Re a > 0$

13.2.1

$\frac{\Gamma(b-a)\Gamma(a)}{\Gamma(b)} M(a, b, z)$
 $= \int_0^1 e^{zt} t^{a-1} (1-t)^{b-a-1} dt$

13.2.2

$= 2^{1-b} e^{\frac{1}{2}z} \int_{-1}^{+1} e^{-\frac{1}{2}zt} (1+t)^{b-a-1} (1-t)^{a-1} dt$

13.2.3

$= 2^{1-b} e^{\frac{1}{2}z} \int_0^\pi e^{-\frac{1}{2}z \cos \theta} \sin^{b-1} \theta \cot^{b-2a}(\frac{1}{2}\theta) d\theta$

13.2.4

$= e^{-Az} \int_A^B e^{zt} (t-A)^{a-1} (B-t)^{b-a-1} dt$
 $(A=B-1)$
 $\Re a > 0, \Re z > 0$

13.2.5

$\Gamma(a)U(a, b, z) = \int_0^\infty e^{-zt} t^{a-1} (1+t)^{b-a-1} dt$

13.2.6

$= e^z \int_1^\infty e^{-zt} (t-1)^{a-1} t^{b-a-1} dt$

13.2.7

$= 2^{1-b} e^{\frac{1}{2}z} \int_0^\infty e^{-\frac{1}{2}z \cosh \theta} \sinh^{b-1} \theta \coth^{b-2a}(\frac{1}{2}\theta) d\theta$ *

*See page II.

13.2.8 $\Gamma(a)U(a, b, z)$

$$= e^{Az} \int_A^\infty e^{-zt} (t-A)^{a-1} (t+B)^{b-a-1} dt$$

$$(A=1-B)$$

Similar integrals for $M_{\kappa, \mu}(z)$ and $W_{\kappa, \mu}(z)$ can be deduced with the help of 13.1.32 and 13.1.33.

Barnes-type Contour Integrals

13.2.9

$$\frac{\Gamma(a)}{\Gamma(b)} M(a, b, z) = \frac{1}{2\pi i} \int_{c-i\infty}^{c+i\infty} \frac{\Gamma(-s)\Gamma(a+s)}{\Gamma(b+s)} (-z)^s ds$$

for $|\arg(-z)| < \frac{1}{2}\pi$, $a, b \neq 0, -1, -2, \dots$. The contour must separate the poles of $\Gamma(-s)$ from those of $\Gamma(a+s)$; c is finite.

13.2.10

$$\Gamma(a)\Gamma(1+a-b)z^a U(a, b, z)$$

$$= \frac{1}{2\pi i} \int_{c-i\infty}^{c+i\infty} \Gamma(-s)\Gamma(a+s)\Gamma(1+a-b+s)z^{-s} ds$$

for $|\arg z| < \frac{3\pi}{2}$, $a \neq 0, -1, -2, \dots$, $b-a \neq 1, 2, 3, \dots$. The contour must separate the poles of $\Gamma(-s)$ from those of $\Gamma(a+s)$ and $\Gamma(1+a-b+s)$.

13.3. Connections With Bessel Functions

(see chapters 9 and 10)

Bessel Functions as Limiting Cases

If b and z are fixed,

13.3.1 $\lim_{a \rightarrow \infty} \{M(a, b, z/a)/\Gamma(b)\} = z^{\frac{1}{2}b} I_{b-1}(2\sqrt{z})$

13.3.2 $\lim_{a \rightarrow \infty} \{M(a, b, -z/a)/\Gamma(b)\} = z^{\frac{1}{2}b} J_{b-1}(2\sqrt{z})$

13.3.3

$$\lim_{a \rightarrow \infty} \{\Gamma(1+a-b)U(a, b, z/a)\} = 2z^{\frac{1}{2}b} K_{b-1}(2\sqrt{z})$$

13.3.4

$$\lim_{a \rightarrow \infty} \{\Gamma(1+a-b)U(a, b, -z/a)\}$$

$$= -\pi i e^{\pi i b} z^{\frac{1}{2}b} H_{b-1}^{(1)}(2\sqrt{z}) \quad (\mathcal{I}z > 0)$$

13.3.5 $= \pi i e^{-\pi i b} z^{\frac{1}{2}b} H_{b-1}^{(2)}(2\sqrt{z}) \quad (\mathcal{I}z < 0)$

Expansions in Series

13.3.6

$$M(a, b, z) = e^{\frac{1}{2}z} \Gamma(b-a-\frac{1}{2}) (\frac{1}{2}z)^{a-b+\frac{1}{2}}$$

$$* \sum_{n=0}^{\infty} \frac{(2b-2a-1)_n (b-2a)_n (b-a-\frac{1}{2}+n)}{n! (b)_n}$$

$$(-1)^n I_{b-a-\frac{1}{2}+n}(\frac{1}{2}z) \quad (b \neq 0, -1, -2, \dots)$$

13.3.7

$$\frac{M(a, b, z)}{\Gamma(b)} = e^{\frac{1}{2}z} (\frac{1}{2}bz - az)^{\frac{1}{2}-b}$$

$$\cdot \sum_{n=0}^{\infty} A_n (\frac{1}{2}z)^{\frac{1}{2}n} (b-2a)^{-\frac{1}{2}n} J_{b-1+n}(\sqrt{2zb-4za})$$

where

$$A_0=1, A_1=0, A_2=\frac{1}{2}b,$$

$$(n+1)A_{n+1} = (n+b-1)A_{n-1} + (2a-b)A_{n-2},$$

(a real)

13.3.8

$$\frac{M(a, b, z)}{\Gamma(b)}$$

$$= e^{hz} \sum_{n=0}^{\infty} C_n z^n (-az)^{\frac{1}{2}(1-b-n)} J_{b-1+n}(2\sqrt{-az})$$

where

$$C_0=1, C_1=-bh, C_2=-\frac{1}{2}(2h-1)a + \frac{1}{2}b(b+1)h^2,$$

$$(n+1)C_{n+1} = [(1-2h)n - bh]C_n$$

$$+ [(1-2h)a - h(h-1)(b+n-1)]C_{n-1}$$

$$- h(h-1)aC_{n-2} \quad (h \text{ real})$$

13.3.9

$$M(a, b, z) = \sum_{n=0}^{\infty} C_n(a, b) I_n(z)$$

where

$$C_0=1, C_1(a, b) = 2a/b,$$

$$C_{n+1}(a, b) = 2aC_n(a+1, b+1)/b - C_{n-1}(a, b)$$

13.4. Recurrence Relations and Differential Properties

13.4.1

$$(b-a)M(a-1, b, z) + (2a-b+z)M(a, b, z)$$

$$- aM(a+1, b, z) = 0$$

13.4.2

$$b(b-1)M(a, b-1, z) + b(1-b-z)M(a, b, z)$$

$$+ z(b-a)M(a, b+1, z) = 0$$

13.4.3

$$(1+a-b)M(a, b, z) - aM(a+1, b, z)$$

$$+ (b-1)M(a, b-1, z) = 0$$

13.4.4

$$bM(a, b, z) - bM(a-1, b, z) - zM(a, b+1, z) = 0$$

13.4.5

$$b(a+z)M(a, b, z) + z(a-b)M(a, b+1, z)$$

$$- abM(a+1, b, z) = 0$$

*See page II.

13.4.6

$$(a-1+z)M(a, b, z) + (b-a)M(a-1, b, z) + (1-b)M(a, b-1, z) = 0$$

13.4.7

$$b(1-b+z)M(a, b, z) + b(b-1)M(a-1, b-1, z) - azM(a+1, b+1, z) = 0$$

13.4.8 $M'(a, b, z) = \frac{a}{b} M(a+1, b+1, z)$

13.4.9 $\frac{d^n}{dz^n} \{M(a, b, z)\} = \frac{(a)_n}{(b)_n} M(a+n, b+n, z)$

13.4.10 $aM(a+1, b, z) = aM(a, b, z) + zM'(a, b, z)$

13.4.11

$$(b-a)M(a-1, b, z) = (b-a-z)M(a, b, z) + zM'(a, b, z)$$

13.4.12

$$(b-a)M(a, b+1, z) = bM(a, b, z) - bM'(a, b, z)$$

13.4.13

$$(b-1)M(a, b-1, z) = (b-1)M(a, b, z) + zM'(a, b, z)$$

13.4.14

$$(b-1)M(a-1, b-1, z) = (b-1-z)M(a, b, z) + zM'(a, b, z)$$

13.4.15

$$U(a-1, b, z) + (b-2a-z)U(a, b, z) + a(1+a-b)U(a+1, b, z) = 0$$

13.4.16

$$(b-a-1)U(a, b-1, z) + (1-b-z)U(a, b, z) + zU(a, b+1, z) = 0$$

13.4.17

$$U(a, b, z) - aU(a+1, b, z) - U(a, b-1, z) = 0$$

13.4.18

$$(b-a)U(a, b, z) + U(a-1, b, z) - zU(a, b+1, z) = 0$$

13.4.19

$$(a+z)U(a, b, z) - zU(a, b+1, z) + a(b-a-1)U(a+1, b, z) = 0$$

13.4.20

$$(a+z-1)U(a, b, z) - U(a-1, b, z) + (1+a-b)U(a, b-1, z) = 0$$

13.4.21 $U'(a, b, z) = -aU(a+1, b+1, z)$

13.4.22

$$\frac{d^n}{dz^n} \{U(a, b, z)\} = (-1)^n (a)_n U(a+n, b+n, z)$$

13.4.23

$$a(1+a-b)U(a+1, b, z) = aU(a, b, z) + zU'(a, b, z)$$

13.4.24

$$(1+a-b)U(a, b-1, z) = (1-b)U(a, b, z) - zU'(a, b, z)$$

13.4.25 $U(a, b+1, z) = U(a, b, z) - U'(a, b, z)$

13.4.26

$$U(a-1, b, z) = (a-b+z)U(a, b, z) - zU'(a, b, z)$$

13.4.27

$$U(a-1, b-1, z) = (1-b+z)U(a, b, z) - zU'(a, b, z)$$

13.4.28 $2\mu M_{\kappa-\frac{1}{2}, \mu-\frac{1}{2}}(z) - z^{\frac{1}{2}} M_{\kappa, \mu}(z) = 2\mu M_{\kappa+\frac{1}{2}, \mu-\frac{1}{2}}(z)$

13.4.29

$$(1+2\mu+2\kappa)M_{\kappa+1, \mu}(z) - (1+2\mu-2\kappa)M_{\kappa-1, \mu}(z) = 2(2\kappa-z)M_{\kappa, \mu}(z)$$

13.4.30

$$W_{\kappa+\frac{1}{2}, \mu}(z) - z^{\frac{1}{2}} W_{\kappa, \mu+\frac{1}{2}}(z) + (\kappa+\mu)W_{\kappa-\frac{1}{2}, \mu}(z) = 0$$

13.4.31

$$(2\kappa-z)W_{\kappa, \mu}(z) + W_{\kappa+1, \mu}(z) = (\mu-\kappa+\frac{1}{2})(\mu+\kappa-\frac{1}{2})W_{\kappa-1, \mu}(z)$$

13.4.32

$$z M'_{\kappa, \mu}(z) = (\frac{1}{2}z-\kappa)M_{\kappa, \mu}(z) + (\frac{1}{2}+\mu+\kappa)M_{\kappa+1, \mu}(z)$$

13.4.33 $z W'_{\kappa, \mu}(z) = (\frac{1}{2}z-\kappa)W_{\kappa, \mu}(z) - W_{\kappa+1, \mu}(z)$

13.5. Asymptotic Expansions and Limiting Forms

For $|z|$ large, (a, b fixed)

13.5.1

$$\frac{M(a, b, z)}{\Gamma(b)} = \frac{e^{\pm i\pi a} z^{-a}}{\Gamma(b-a)} \left\{ \sum_{n=0}^{R-1} \frac{(a)_n (1+a-b)_n}{n!} (-z)^{-n} + O(|z|^{-R}) \right\} + \frac{e^{\pm i\pi a} z^{-a}}{\Gamma(a)} \left\{ \sum_{n=0}^{S-1} \frac{(b-a)_n (1-a)_n}{n!} z^{-n} + O(|z|^{-S}) \right\}$$

the upper sign being taken if $-\frac{1}{2}\pi < \arg z < \frac{3}{2}\pi$, the lower sign if $-\frac{3}{2}\pi < \arg z \leq -\frac{1}{2}\pi$.

13.5.2

$$U(a, b, z) = z^{-a} \left\{ \sum_{n=0}^{R-1} \frac{(a)_n (1+a-b)_n}{n!} (-z)^{-n} + O(|z|^{-R}) \right\} \quad \left(-\frac{3}{2}\pi < \arg z < \frac{3}{2}\pi \right)$$

Converging Factors for the Remainders

13.5.3

$$O(|z|^{-R}) = \frac{(a)_R (1+a-b)_R}{R!} (-z)^{-R} \left[\frac{1}{2} + \frac{(\frac{1}{2} + \frac{1}{4}b - \frac{1}{2}a + \frac{1}{4}z - \frac{1}{4}R)}{z} + O(|z|^{-2}) \right]$$

and

13.5.4

$$O(|z|^{-S}) = \frac{(b-a)_S (1-a)_S}{S!} z^{-S} \left[\frac{3}{2} - b + 2a + z - S + O(|z|^{-1}) \right]$$

where the R 'th and S 'th terms are the smallest in the expansions 13.5.1 and 13.5.2.

For small z (a, b fixed)

13.5.5 As $|z| \rightarrow 0$, $M(a, b, 0) = 1$, $b \neq -n$

13.5.6 $U(a, b, z) = \frac{\Gamma(b-1)}{\Gamma(a)} z^{1-b} + O(|z|^{\mathcal{R}b-2})$
($\mathcal{R}b \geq 2, b \neq 2$)

13.5.7 $= \frac{\Gamma(b-1)}{\Gamma(a)} z^{1-b} + O(|\ln z|)$
($b=2$)

13.5.8 $= \frac{\Gamma(b-1)}{\Gamma(a)} z^{1-b} + O(1)$
($1 < \mathcal{R}b < 2$)

13.5.9 $= -\frac{1}{\Gamma(a)} [\ln z + \psi(a)] + O(|z \ln z|)$
($b=1$)

13.5.10 $U(a, b, z) = \frac{\Gamma(1-b)}{\Gamma(1+a-b)} + O(|z|^{1-\mathcal{R}b})$
($0 < \mathcal{R}b < 1$)

13.5.11 $= \frac{1}{\Gamma(1+a)} + O(|z \ln z|)$ ($b=0$)

13.5.12 $= \frac{\Gamma(1-b)}{\Gamma(1+a-b)} + O(|z|)$
($\mathcal{R}b \leq 0, b \neq 0$)

For large a (b, z fixed)

13.5.13

$$M(a, b, z) = \Gamma(b) e^{i\pi(\frac{1}{2}bz - az)^{1-1/b}} J_{b-1}(\sqrt{(2bz-4az)}) [1 + O(|\frac{1}{2}b - a|^{-\sigma})]$$

where

$$|z| = \left| \frac{1}{2}b - a \right|^{\rho} \text{ and } \sigma = \min(1 - \rho, \frac{1}{2} - \frac{3}{2}\rho), 0 \leq \rho < \frac{1}{2}.$$

13.5.14

$$M(a, b, x) = \Gamma(b) e^{i\pi(\frac{1}{2}bx - ax)^{1-1/b}} \pi^{-1/2} \cos(\sqrt{(2bx-4ax)} - \frac{1}{2}b\pi + \frac{1}{4}\pi) [1 + O(|\frac{1}{2}b - a|^{-\sigma})]$$

as $a \rightarrow -\infty$ for b bounded, x real.

13.5.15

$$U(a, b, z) = \Gamma(\frac{1}{2}b - a + \frac{1}{2}) e^{i\pi z^{1-1/b}} [\cos(a\pi) J_{b-1}(\sqrt{(2bz-4az)}) - \sin(a\pi) Y_{b-1}(\sqrt{(2bz-4az)})] [1 + O(|\frac{1}{2}b - a|^{-\sigma})]$$

where σ is defined in 13.5.13.

13.5.16

$$U(a, b, x) = \Gamma(\frac{1}{2}b - a + \frac{1}{2}) \pi^{-1/2} e^{i\pi x^{1-1/b}} \cos(\sqrt{(2bx-4ax)} - \frac{1}{2}b\pi + a\pi + \frac{1}{4}\pi) [1 + O(|\frac{1}{2}b - a|^{-\sigma})]$$

as $a \rightarrow -\infty$ for b bounded, x real.

For large real a, b, z

If $\cosh^2 \theta = x/(2b-4a)$ so that $x > 2b-a > 1$,

13.5.17

$$M(a, b, x) = \Gamma(b) \sin(a\pi) \exp[(b-2a)(\frac{1}{2} \sinh 2\theta - \theta + \cosh^2 \theta)] [(b-2a) \cosh \theta]^{1-b} [\pi(\frac{1}{2}b - a) \sinh 2\theta]^{-1/2} [1 + O(|\frac{1}{2}b - a|^{-1})]$$

13.5.18

$$U(a, b, x) = \exp[(b-2a)(\frac{1}{2} \sinh 2\theta - \theta + \cosh^2 \theta)] [(b-2a) \cosh \theta]^{1-b} [(\frac{1}{2}b - a) \sinh 2\theta]^{-1/2} [1 + O(|\frac{1}{2}b - a|^{-1})]$$

If $x = (2b - 4a)[1 + t/(b - 2a)^{1/2}]$, so that

$$x \sim 2b - 4a$$

13.5.19

$$M(a, b, x) = e^{1/2x}(b - 2a)^{-1/2} \Gamma(b) [\text{Ai}(t) \cos(a\pi) + \text{Bi}(t) \sin(a\pi) + O(|\frac{1}{2}b - a|^{-1})]$$

13.5.20

$$U(a, b, x) = e^{1/2x+a-1/2} \Gamma(\frac{1}{2}) \pi^{-1/2} x^{b-1/2} \{1 - t \Gamma(\frac{5}{6})(bx - 2ax)^{-1/2} 3^{1/2} \pi^{-1/2} + O(|\frac{1}{2}b - a|^{-1})\}$$

If $\cos^2 \theta = x/(2b - 4a)$ so that $2b - 4a > x > 0$,

13.5.21

$$M(a, b, x) = \Gamma(b) \exp\{(b - 2a) \cos^2 \theta\} [(b - 2a) \cos \theta]^{1-b} [\pi(\frac{1}{2}b - a) \sin 2\theta]^{-1/2} [\sin(a\pi) + \sin\{(\frac{1}{2}b - a)(2\theta - \sin 2\theta) + \frac{1}{4}\pi\}] + O(|\frac{1}{2}b - a|^{-1})$$

13.5.22

$$U(a, b, x) = \exp[(b - 2a) \cos^2 \theta] [(b - 2a) \cos \theta]^{1-b} [(\frac{1}{2}b - a) \sin 2\theta]^{-1/2} \{\sin[(\frac{1}{2}b - a)(2\theta - \sin 2\theta) + \frac{1}{4}\pi] + O(|\frac{1}{2}b - a|^{-1})\}$$

13.6. Special Cases

	M(a, b, z)			Relation	Function
	a	b	z		
13.6.1	$\nu + \frac{1}{2}$	$2\nu + 1$	$2iz$	$\Gamma(1 + \nu) e^{iz} (\frac{1}{2}z)^{-\nu} J_\nu(z)$	Bessel
13.6.2	$-\nu + \frac{1}{2}$	$-2\nu + 1$	$2iz$	$\Gamma(1 - \nu) e^{iz} (\frac{1}{2}z)^\nu [\cos(\nu\pi) J_\nu(z) - \sin(\nu\pi) Y_\nu(z)]$	Bessel
13.6.3	$\nu + \frac{1}{2}$	$2\nu + 1$	$2z$	$\Gamma(1 + \nu) e^{iz} (\frac{1}{2}z)^{-\nu} I_\nu(z)$	Modified Bessel
13.6.4	$n + 1$	$2n + 2$	$2iz$	$\Gamma(\frac{1}{2} + n) e^{iz} (\frac{1}{2}z)^{-n-1/2} J_{n+1/2}(z)$	Spherical Bessel
13.6.5	$-n$	$-2n$	$2iz$	$\Gamma(\frac{1}{2} - n) e^{iz} (\frac{1}{2}z)^{n+1/2} J_{-n-1/2}(z)$	Spherical Bessel
13.6.6	$n + 1$	$2n + 2$	$2z$	$\Gamma(\frac{1}{2} + n) e^{iz} (\frac{1}{2}z)^{-n-1/2} I_{n+1/2}(z)$ *	Spherical Bessel
13.6.7	$n + \frac{1}{2}$	$2n + 1$	$-2\sqrt{iz}$	$\Gamma(1 + n) e^{-2iz} (\frac{1}{2}iz\pi)^{-n} (\text{ber}_n x + i \text{bei}_n x)$	Kelvin
13.6.8	$L + 1 - i\eta$	$2L + 2$	$2ix$	$e^{ix} F_L(\eta, x) x^{L-1} / C_L(\eta)$	Coulomb Wave
13.6.9	$-n$	$\alpha + 1$	x	$\frac{n!}{(\alpha + 1)_n} L_n^{(\alpha)}(x)$	Laguerre
13.6.10	a	$a + 1$	$-x$	$ax^{-a} \gamma(a, x)$	Incomplete Gamma
13.6.11	$-n$	$1 + \nu - n$	x	$\frac{(n!)^2 x^{1/2}}{(1 + \nu - n)_n} \rho_n(\nu, x)$	Poisson-Charlier
13.6.12	a	a	z	e^z	Exponential
13.6.13	1	2	$-2iz$	$\frac{e^{-iz}}{z} \sin z$	Trigonometric
13.6.14	1	2	$2z$	$\frac{e^z}{z} \sinh z$	Hyperbolic
13.6.15	$-\frac{1}{2}\nu$	$\frac{1}{2}$	$\frac{1}{2}z^2$	$2^{-1/2} \exp(\frac{1}{2}z^2) E_\nu^{(0)}(z)$	Weber
13.6.16	$\frac{1}{2} - \frac{1}{2}\nu$	$\frac{3}{2}$	$\frac{1}{2}z^2$	$\frac{\exp(\frac{1}{2}z^2)}{2z} E_\nu^{(1)}(z)$	or Parabolic Cylinder
13.6.17	$-n$	$\frac{1}{2}$	$\frac{1}{2}z^2$	$\frac{n!}{(2n)!} (-\frac{1}{2})^{-n} He_{2n}(x)$	Hermite
13.6.18	$-n$	$\frac{3}{2}$	$\frac{1}{2}z^2$	$\frac{n!}{(2n+1)!} (-\frac{1}{2})^{-n} \frac{1}{x} He_{2n+1}(x)$ *	Hermite
13.6.19	$\frac{1}{2}$	$\frac{3}{2}$	$-x^2$	$\frac{\pi^{1/2}}{2x} \text{erf } x$	Error Integral
13.6.20	$\frac{1}{2}m + \frac{1}{2}$	$1 + n$	r^2	$\frac{n! r^{-2n+m-1}}{\Gamma(\frac{1}{2}m + \frac{1}{2})} e^{r^2} T(m, n, r)$ *	Toronto

*See page II.

13.6. Special Cases—Continued

	$U(a, b, z)$			Relation	Function
	a	b	z		
13.6.21	$\nu + \frac{1}{2}$	$2\nu + 1$	$2z$	$\pi^{-1}e^z(2z)^{-\nu}K_\nu(z)$	Modified Bessel
13.6.22	$\nu + \frac{1}{2}$	$2\nu + 1$	$-2iz$	$\frac{1}{2}\pi^{1/2}e^{i[\pi(\nu + \frac{1}{2}) - z]}(2z)^{-\nu}H_\nu^{(1)}(z)^*$	Hankel
13.6.23	$\nu + \frac{1}{2}$	$2\nu + 1$	$2iz$	$\frac{1}{2}\pi^{1/2}e^{-i[\pi(\nu + \frac{1}{2}) - z]}(2z)^{-\nu}H_\nu^{(2)}(z)^*$	Hankel
13.6.24	$n + 1$	$2n + 2$	$2z$	$\pi^{-1/2}e^z(2z)^{-n-1/2}K_{n+1/2}(z)$	Spherical Bessel
13.6.25	$\frac{2}{3}$	$\frac{2}{3}$	$\frac{2}{3}z^{3/2}$	$\pi^{1/2}z^{-1} \exp(\frac{2}{3}z^{3/2})2^{-2/3}3^{5/6} \text{Ai}(z)$	Airy
13.6.26	$n + \frac{1}{2}$	$2n + 1$	\sqrt{ix}	$i^n \pi^{-1/2} e^{\sqrt{ix}} (2\sqrt{ix})^{-n} [\text{ker}_n x + i \text{kei}_n x]$	Kelvin
13.6.27	$-n$	$\alpha + 1$	x	$(-1)^n n! L_n^{(\alpha)}(x)$	Laguerre
13.6.28	$1 - a$	$1 - a$	x	$e^x \Gamma(a, x)$	Incomplete Gamma
13.6.29	1	1	$-x$	$-e^{-x} \text{Ei}(x)$	Exponential Integral
13.6.30	1	1	x	$e^x E_1(x)$	Exponential Integral
13.6.31	1	1	$-\ln x$	$-\frac{1}{x} \text{li}(x)$	Logarithmic Integral
13.6.32	$\frac{1}{2}m - n$	$1 + m$	x	$\Gamma(1 + n - \frac{1}{2}m) e^{x - \pi i(\frac{1}{2}m - n)} \omega_{n, m}(x)$	Cunningham
13.6.33	$-\frac{1}{2}\nu$	0	$2x$	$\Gamma(1 + \frac{1}{2}\nu) e^{2k_\nu(x)}$ for $x > 0$	Bateman
13.6.34	1	1	ix	$e^{ix} [-\frac{1}{2}\pi i + i \text{Si}(x) - \text{Ci}(x)]$	Sine and Cosine Integral
13.6.35	1	1	$-ix$	$e^{-ix} [\frac{1}{2}\pi i - i \text{Si}(x) - \text{Ci}(x)]$	Sine and Cosine Integral
13.6.36	$-\frac{1}{2}\nu$	$\frac{1}{2}$	$\frac{1}{2}z^2$	$2^{-1/2} e^{z^2/4} D_\nu(z)$	Weber
13.6.37	$\frac{1}{2} - \frac{1}{2}\nu$	$\frac{3}{2}$	$\frac{1}{2}z^2$	$2^{1/2} e^{z^2/4} D_\nu(z)/z^*$	Parabolic Cylinder
13.6.38	$\frac{1}{2} - \frac{1}{2}n$	$\frac{3}{2}$	x^2	$2^{-n} H_n(x)/x^*$	Hermite
13.6.39	$\frac{1}{2}$	$\frac{1}{2}$	x^2	$\sqrt{\pi} \exp(x^2) \text{erfc } x$	Error Integral

13.7. Zeros and Turning Values

If $j_{b-1, r}$ is the r 'th positive zero of $J_{b-1}(x)$, then a first approximation X_0 to the r 'th positive zero of $M(a, b, x)$ is

13.7.1 $X_0 = j_{b-1, r}^2 \{1/(2b-4a) + O(1/(\frac{1}{2}b-a)^2)\}$

13.7.2 $X_0 \approx \frac{\pi^2(r + \frac{1}{2}b - \frac{3}{4})^2}{2b-4a}$

A closer approximation is given by

13.7.3 $X_1 = X_0 - M(a, b, X_0)/M'(a, b, X_0)$

For the derivative,

13.7.4

$M'(a, b, X_1) =$

$$M'(a, b, X_0) \left\{ 1 + (b - X_0) \frac{M(a, b, X_0)}{M'(a, b, X_0)} \right\}$$

If X'_0 is the first approximation to a turning value of $M(a, b, x)$, that is, to a zero of $M'(a, b, x)$ then a better approximation is

13.7.5 $X'_1 = X'_0 - \frac{X'_0 M'(a, b, X'_0)}{a M(a, b, X'_0)}$

*See page II.

The self-adjoint equation 13.1.1 can also be written

$$13.7.6 \quad \frac{d}{dz}[z^b e^{-z} \frac{dw}{dz}] = a z^{b-1} e^{-z} w$$

The Sonine-Polya Theorem

The maxima and minima of $|w|$ form an increasing or decreasing sequence according as

$$-a x^{2b-1} e^{-2x}$$

is an increasing or decreasing function of x , that is, they form an increasing sequence for $M(a, b, x)$ if $a > 0, x < b - \frac{1}{2}$ or if $a < 0, x > b - \frac{1}{2}$, and a decreasing sequence if $a > 0$ and $x > b - \frac{1}{2}$ or if $a < 0$ and $x < b - \frac{1}{2}$.

The turning values of $|w|$ lie near the curves

13.7.7

$$w = \pm \Gamma(b) \pi^{-1/2} e^{x/2} (\frac{1}{2} b x - a x)^{b-1/2} \{1 - x/(2b-4a)\}^{-1/4}$$

Numerical Methods

13.8. Use and Extension of the Tables

Calculation of $M(a, b, x)$

Kummer's Transformation

Example 1. Compute $M(.3, .2, -.1)$ to 7S. Using 13.1.27 and Tables 4.4 and 13.1 we have $a = .3, b = .2$ so that

$$M(.3, .2, -.1) = e^{-.1} M(-.1, .2, .1) = .85784 \ 90.$$

Thus 13.1.27 can be used to extend Table 13.1 to negative values of x . Kummer's transformation should also be used when a and b are large and nearly equal, for x large or small.

Example 2. Compute $M(17, 16, 1)$ to 7S. Here $a = 17, b = 16$, and

$$M(17, 16, 1) = e^1 M(-1, 16, -1) = 2.71828 \ 18 \times 1.06250 \ 00 = 2.88817 \ 44.$$

Recurrence Relations

Example 3. Compute $M(-1.3, 1.2, .1)$ to 7S. Using 13.4.1 and Table 13.1 we have $a = -.3, b = .2$ so that

$$M(-1.3, .2, .1) = 2[.7 M(-.3, .2, .1) - .3 M(.7, .2, .1)] = .35821 \ 23.$$

By 13.4.5 when $a = -1.3$ and $b = .2$,

$$M(-1.3, 1.2, .1) = [.26 M(-.3, .2, .1) - .24 M(-1.3, .2, .1)] / .15 = .89241 \ 08.$$

Similarly when $a = -.3$ and $b = .2$

$$M(-.3, 1.2, .1) = .97459 \ 52.$$

Check, by 13.4.6,

$$M(-1.3, 1.2, .1) = [.2 M(-.3, .2, .1) + 1.2 M(-.3, 1.2, .1)] / 1.5 = .89241 \ 08.$$

In this way 13.4.1-13.4.7 can be used together with 13.1.27 to extend Table 13.1 to the range

$$-10 \leq a \leq 10, -10 \leq b \leq 10, -10 \leq x \leq 10.$$

This extension of ten units in any direction is possible with the loss of about 1S. All the recurrence relations are stable except i) if $a < 0, b < 0$ and $|a| > |b|, x > 0$, or ii) $b < a, b < 0, |b-a| > |b|, x < 0$, when the oscillations may become large, especially if $|x|$ also is large.

Neither interpolation nor the use of recurrence relations should be attempted in the strips $b = -n \pm .1$ where the function is very large numerically. In particular $M(a, b, x)$ cannot be evaluated in the neighborhood of the points $a = -m, b = -n, m \leq n$, as near these points small changes in a, b or x can produce very large changes in the numerical value of $M(a, b, x)$.

Example 4. At the point $(-1, -1, x), M(a, b, x)$ is undefined.

When $a = -1, M(-1, b, x) = 1 - \frac{x}{b}$ for all x .

Hence $\lim_{b \rightarrow -1} M(-1, b, x) = 1 + x$. But $M(b, b, x) = e^x$ for all x , when $a = b$. Hence $\lim_{b \rightarrow -1} M(b, b, x) = e^x$.

In the first case $b \rightarrow -1$ along the line $a = -1$, and in the second case $b \rightarrow -1$ along the line $a = b$.

Derivatives

Example 5. To evaluate $M'(-.7, -.6, .5)$ to 7S. By 13.4.8, when $a = -.7$ and $b = -.6$, we have

$$M'(-.7, -.6, .5) = \frac{-.7}{-.6} M(.3, .4, .5) = 1.724128.$$

Asymptotic Formulas

For $x \geq 10, a$ and b small, $M(a, b, x)$ should be evaluated by 13.5.1 using converging factors 13.5.3 and 13.5.4 to improve the accuracy if necessary.

Example 6. Calculate $M(.9, .1, 10)$ to 7S, using 13.5.1.

$$M(.9, .1, 10) = \frac{\Gamma(.1)}{\Gamma(-.8)} e^{.9\pi i} 10^{-.9} \sum_{n=0}^N \frac{(.9)_n (1.8)_n}{n! (-10)^n} + \frac{\Gamma(.1)}{\Gamma(.9)} e^{10i} 10^{-.8} \sum_{n=0}^N \frac{(-.8)_n (.1)_n}{n! 10^n} + O(10^{-N})$$

$$= -.198(.869) + 1237253(.99190 \ 285) + O(1)$$

$$= 1227235.23 - .17 + O(1)$$

$$= 1227235 + O(1)$$

Check, from Table 13.1, $M(.9, .1, 10) = 1227235$. To evaluate $M(a, b, x)$ with a large, x small and b small or large 13.5.13-14 should be used.

Example 7. Compute $M(-52.5, .1, 1)$ to 3S, using 13.5.14.

$$M(-52.5, .1, 1) = \Gamma(.1) e^{.5} (.05 + 52.5)^{.25 - .05} .5642 \cos [(.2 - 4(-52.5))^{.5} - .05\pi + .25\pi]$$

$$[1 + O((.05 + 52.5)^{-.5})] = -16.34 + O(.2)$$

By direct application of a recurrence relation, $M(-52.5, .1, 1)$ has been calculated as -16.447 . To evaluate $M(a, b, x)$ with x, a and/or b large, 13.5.17, 19 or 21 should be tried.

Example 8. Compute $M(-52.5, .1, 1)$ using 13.5.21 to 3S, $\cos \theta = \sqrt{1/210.2}$.

$$M(-52.5, .1, 1) = \Gamma(.1) e^{105.1 \cos^2 \theta} [105.1 \cos \theta]^{1 - .1.5641} 52.55^{-.5} \sin 2\theta^{-.5} [\sin(-52.5\pi) + \sin \{52.55(2\theta - \sin 2\theta) + \frac{1}{2}\pi\}] + O((52.55)^{-1}) = -16.47 + O(.02)$$

A full range of asymptotic formulas to cover all possible cases is not yet known.

Calculation of $U(a, b, x)$

For $-10 \leq x \leq 10, -10 \leq a \leq 10, -10 \leq b \leq 10$ this is possible by 13.1.3, using Table 13.1 and the recurrence relations 13.4.15-20.

Example 9. Compute $U(1.1, .2, 1)$ to 5S. Using Tables 13.1, 4.12 and 6.1 and 13.1.3, we have

$$U(1, .2, 1) = \frac{\pi}{\sin(.2\pi)} \left\{ \frac{M(1, .2, 1)}{\Gamma(.9)\Gamma(.2)} - \frac{M(.9, 1.8, 1)}{\Gamma(.1)\Gamma(1.8)} \right\}.$$

But $M(.9, 1.8, 1) = .8[M(.9, .8, 1) - M(-.1, .8, 1)] = 1.72329$, using 13.4.4.

Hence

$$U(1, .2, 1) = 5.344799(.371765 - .194486) = .94752.$$

Similarly

$$U(-.9, .2, 1) = .91272.$$

Hence by 13.4.15

$$U(1.1, .2, 1) = [U(1, .2, 1) - U(-.9, .2, 1)] / .09 = .38664.$$

Example 10. To compute $U'(-.9, -.8, 1)$ to 5S. By 13.4.21

$$U'(-.9, -.8, 1) = .9U(1, .2, 1) = (.9)(.94752) = .85276.$$

Asymptotic Formulas

Example 11. To compute $U(1, .1, 100)$ to 5S. By 13.5.2

$$U(1, .1, 100) = \frac{1}{100} \left\{ 1 - \frac{1.9}{100} + \frac{1.9}{100} \frac{2.9}{100} - \frac{1.9}{100} \frac{2.9}{100} \frac{3.9}{100} + O(10^{-9}) \right\}.$$

$$= .01 \{ 1 - .019 + .000551 - .000021 + O(10^{-9}) \},$$

$$= .00981 \ 53.$$

Example 12. To evaluate $U(1, .2, .01)$. For x small, 13.5.6-12 should be used.

$$U(1, .2, .01) = \frac{\Gamma(1-.2)}{\Gamma(1.1-.2)} + O((.01)^{1-.2}) = \frac{\Gamma(.8)}{\Gamma(.9)} + O((.01)^{.8}) = 1.09 \text{ to 3S, by 13.5.10.}$$

To evaluate $U(a, b, x)$ with a large, x small and b small or large 13.5.15 or 16 should be used.

To evaluate $U(a, b, x)$ with x, a and/or b large 13.5.18, 20 or 22 should be tried. In all these cases the size of the remainder term is the guide to the number of significant figures obtainable.

Calculation of the Whittaker Functions

Example 13. Compute $M_{0, -.4}(1)$ and $W_{0, -.4}(1)$ to 5S. By formulas 13.1.32 and 13.1.33 and Tables 13.1, 4.4

$$M_{0, -.4}(1) = e^{-.5} M(1, .2, 1) = 1.10622,$$

$$W_{0, -.4}(1) = e^{-.5} U(1, .2, 1) = .57469.$$

Thus the values of $M_{\kappa,\mu}(x)$ and $W_{\kappa,\mu}(x)$ can always be found if the values of $M(a, b, x)$ and $U(a, b, x)$ are known.

13.9. Calculation of Zeros and Turning Points

Example 14. Compute the smallest positive zero of $M(-4, .6, x)$. This is outside the range of **Table 13.2**. Using **13.7.2** we have, as a first approximation

$$X_0 = \frac{(.55\pi)^2}{17.2} = .174.$$

Using **13.7.3** we have

$$X_1 = X_0 - M(-4, .6, X_0) / M'(-4, .6, X_0).$$

But, by **13.4.8**,

$$M'(-4, .6, X_0) = -(.15)^{-1} M(-3, 1.6, X_0)$$

Hence

$$\begin{aligned} X_1 &= X_0 + .15M(-4, .6, X_0) / M(-3, 1.6, X_0), \\ &= .174 + (.15)(.030004) \\ &= .17850 \text{ as a second approximation.} \end{aligned}$$

If we repeat this calculation, we find that

$$X_2 = X_1 + .0000299 = .1785299 \text{ to } 7S.$$

Calculation of Maxima and Minima

Example 15. Compute the value of x at which $M(-1.8, -.2, x)$ has a turning value. Using **13.4.8** and **Table 13.2**, we find that $M'(-1.8, -.2, x) = 9M(-.8, .8, x) = 0$ when $x = .9429159$. Also $M''(-1.8, -.2, x) = 9M'(-.8, .8, x) = -9M(.2, 1.8, x)$ and $M(.2, 1.8, .9429159) > 0$. Hence $M(-1.8, -.2, x)$ has a maximum in x when $x = .9429159$.

Example 16. Compute the smallest positive value of x for which $M(-3, .6, x)$ has a turning value, X'_1 . This is outside the range of **Table 13.2**. Using **13.4.8** we have

$$M'(-3, .6, x) = -3M(-2, 1.6, x) / .6.$$

By **13.7.2** for $M(-2, 1.6, x)$,

$$X_0 = (1.05\pi)^2 / (11.2) = .9715.$$

This is a first approximation to X'_0 for $M(-3, .6, x)$. Using **13.7.5** and **13.4.8** we find a second approximation

$$\begin{aligned} X'_1 &= X'_0 \left[1 - \frac{M'(-3, .6, X'_0)}{-3M(-3, .6, X'_0)} \right] \\ &= X'_0 \left[1 - M(-2, 1.6, X'_0) / .6M(-3, .6, X'_0) \right] \\ &= .9715 \times 1.0163 = .9873 \text{ to } 4S. \end{aligned}$$

This process can be repeated to give as many significant figures as are required.

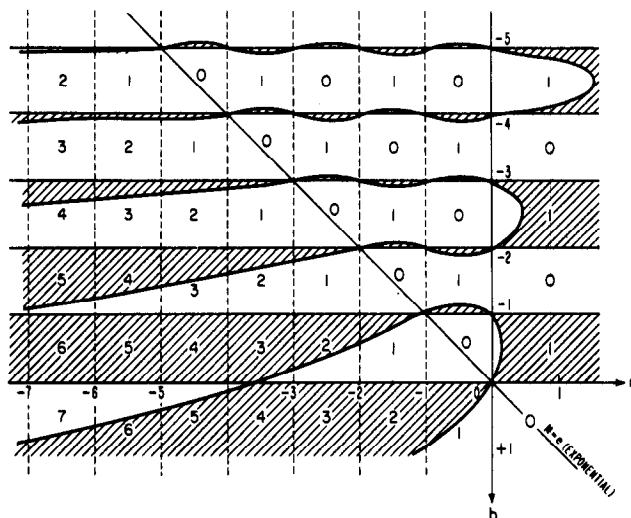

FIGURE 13.1.

Figure 13.1 shows the curves on which $M(a, b, x) = 0$ in the a, b plane when $x = 1$. The function is positive in the unshaded areas, and negative in the shaded areas. The number in each square gives the number of real positive zeros of $M(a, b, x)$ as a function of x in that square. The vertical boundaries to the left are to be included in each square.

13.10. Graphing $M(a, b, x)$

Example 17. Sketch $M(-4.5, 1, x)$. Firstly, from **Figure 13.1** we see that the function has five real positive zeros. From **13.5.1**, we find that $M \rightarrow -\infty, M' \rightarrow -\infty$ as $x \rightarrow +\infty$ and that $M \rightarrow +\infty, M' \rightarrow +\infty$ as $x \rightarrow -\infty$. By **13.7.2** we have as first approximations to the zeros, .3, 1.5, 3.7, 6.9, 10.6, and by **13.7.2** and **13.4.8** we find as first approximations to the turning values .9, 2.8, 5.8, 9.9. From **13.7.7**, we see that these must lie near the curves

$$y = \pm e^{1/2}(5x)^{-1/2}(1-x/11)^{-1/2}\pi^{-1/2}.$$

From these facts we can form a rough graph of the behavior of the function, **Figure 13.2**.

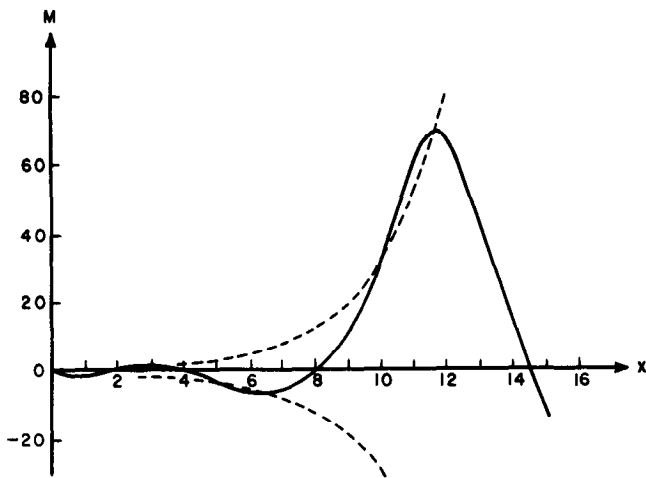

FIGURE 13.2. $M(-4.5, 1, x)$.

(From F. G. Tricomi, *Funzioni ipergeometriche confluenti*, Edizioni Cremonese, Rome, Italy, 1954, with permission.)

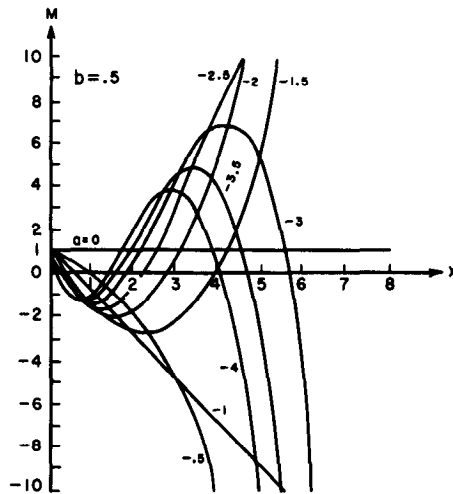
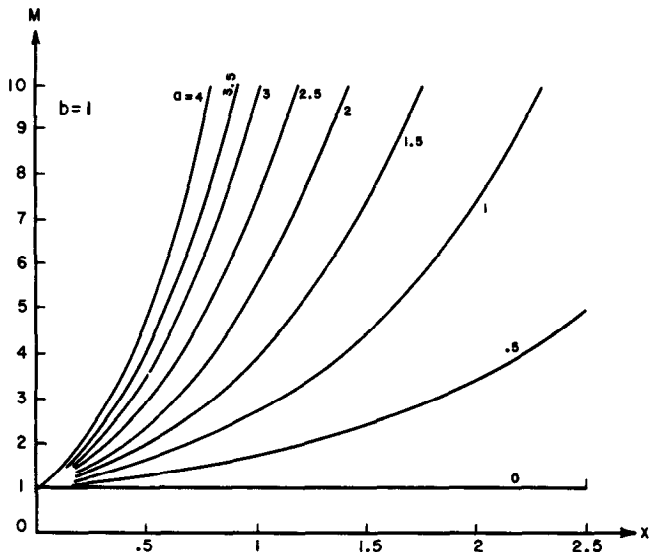
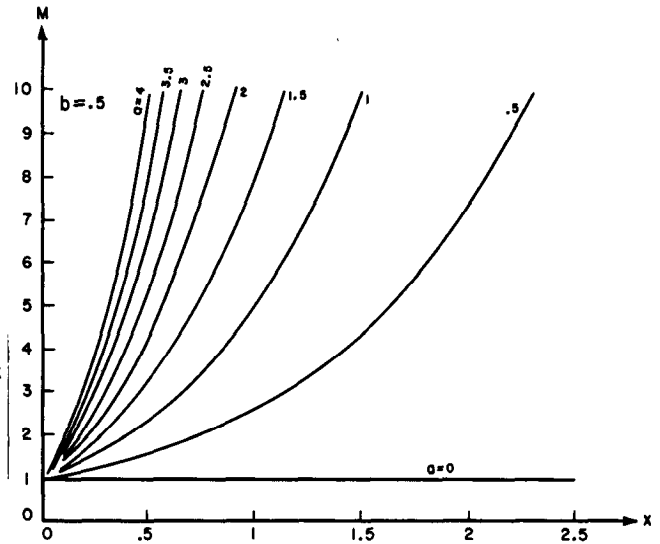

FIGURE 13.4. $M(a, .5, x)$.

(From E. Jahnke and F. Emde, *Tables of functions*, Dover Publications, Inc., New York, N.Y., 1945, with permission.)

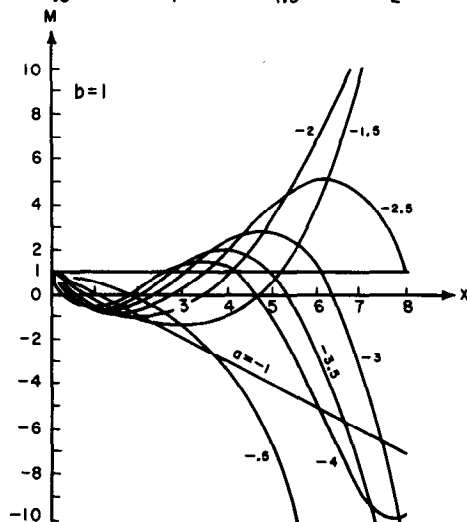

FIGURE 13.3. $M(a, 1, x)$.

(From E. Jahnke and F. Emde, *Tables of functions*, Dover Publications, Inc., New York, N.Y., 1945, with permission.)

References

Texts

- [13.1] H. Buchholz, *Die konfluente hypergeometrische Funktion* (Springer-Verlag, Berlin, Germany, 1953). On Whittaker functions, with a large bibliography.
- [13.2] A. Erdélyi et al., *Higher transcendental functions*, vol. 1, ch. 6 (McGraw-Hill Book Co., Inc., New York, N.Y., 1953). On Kummer functions.
- [13.3] H. Jeffreys and B. S. Jeffreys, *Methods of mathematical physics*, ch. 23 (Cambridge Univ. Press, Cambridge, England, 1950). On Kummer functions.
- [13.4] J. C. P. Miller, Note on the general solutions of the confluent hypergeometric equation, *Math. Tables Aids Comp.* **9**, 97-99 (1957).
- [13.5] L. J. Slater, On the evaluation of the confluent hypergeometric function, *Proc. Cambridge Philos. Soc.* **49**, 612-622 (1953).

- [13.6] L. J. Slater, The evaluation of the basic confluent hypergeometric function, Proc. Cambridge Philos. Soc. **50**, 404-413 (1954).
- [13.7] L. J. Slater, The real zeros of the confluent hypergeometric function, Proc. Cambridge Philos. Soc. **52**, 626-635 (1956).
- [13.8] C. A. Swanson and A. Erdélyi, Asymptotic forms of confluent hypergeometric functions, Memoir **25**, Amer. Math. Soc. (1957).
- [13.9] F. G. Tricomi, Funzioni ipergeometriche confluenti (Edizioni Cremonese, Rome, Italy, 1954). On Kummer functions.
- [13.10] E. T. Whittaker and G. N. Watson, A course of modern analysis, ch. 16, 4th ed. (Cambridge Univ. Press, Cambridge, England, 1952). On Whittaker functions.
- [13.11] J. R. Airey, The confluent hypergeometric function, British Association Reports, Oxford, 276-294 (1926), and Leeds, 220-244 (1927). $M(a, b, x)$, $a = -4(.5)4$, $b = \frac{1}{2}, 1, \frac{3}{2}, 2, 3, 4$, $x = .1(.1)2(.2)3(.5)8$, 5D.
- [13.12] J. R. Airey and H. A. Webb, The practical importance of the confluent hypergeometric function, Phil. Mag. **36**, 129-141 (1918). $M(a, b, x)$, $a = -3(.5)4$, $b = 1(1)7$, $x = 1(1)6(2)10$, 4S.
- [13.13] E. Jahnke and F. Emde, Tables of functions, ch. 10, 4th ed. (Dover Publications, Inc., New York, N.Y., 1945). Graphs of $M(a, b, x)$ based on the tables of [13.11].
- [13.14] P. Nath, Confluent hypergeometric functions, Sankhya J. Indian Statist. Soc. **11**, 153-166 (1951). $M(a, b, x)$, $a = 1(1)40$, $b = 3$, $x = .02(.02).1(.1)1(1)10(10)50, 100, 200$, 6D.
- [13.15] S. Rushton and E. D. Lang, Tables of the confluent hypergeometric function, Sankhya J. Indian Statist. Soc. **13**, 369-411 (1954). $M(a, b, x)$, $a = .5(.5)40$, $b = .5(.5)3.5$, $x = .02(.02).1(.1)1(1)10(10)50, 100, 200$, 7S.
- [13.16] L. J. Slater, Confluent hypergeometric functions (Cambridge Univ. Press, Cambridge, England, 1960). $M(a, b, x)$, $a = -1(.1)1$, $b = .1(.1)1$, $x = .1(.1)10$, 8S; $M(a, b, 1)$, $a = -11(.2)2$, $b = -4(.2)1$, 8S; and smallest positive values of x for which $M(a, b, x) = 0$, $a = -4(.1) - .1$, $b = .1(.1)2.5$, 8S.

Tables

Table 13.1 CONFLUENT HYPERGEOMETRIC FUNCTION $M(a, b, x)$

		$x=0.1$									
$a \setminus b$		0.1	0.2	0.3	0.4	0.5					
-1.0		0.00000 00	(-1) 5.00000 00	(-1) 6.66666 67	(-1) 7.50000 00	(-1) 8.00000 00	(-1)				
-0.9	(-2)	9.58364 34	(-1) 5.48093 23	(-1) 6.98827 46	(-1) 7.74183 96	(-1) 8.19391 07	(-1)				
-0.8	(-1)	1.92586 25	(-1) 5.96605 00	(-1) 7.31245 77	(-1) 7.98547 23	(-1) 8.38915 99	(-1)				
-0.7	(-1)	2.90253 86	(-1) 6.45537 25	(-1) 7.63922 74	(-1) 8.23090 56	(-1) 8.58575 33	(-1)				
-0.6	(-1)	3.88843 71	(-1) 6.94891 92	(-1) 7.96859 49	(-1) 8.47814 73	(-1) 8.78369 61	(-1)				
-0.5	(-1)	4.88360 25	(-1) 7.44670 94	(-1) 8.30057 19	(-1) 8.72720 49	(-1) 8.98299 40	(-1)				
-0.4	(-1)	5.88807 94	(-1) 7.94876 28	(-1) 8.63516 97	(-1) 8.97808 60	(-1) 9.18365 22	(-1)				
-0.3	(-1)	6.90191 26	(-1) 8.45509 89	(-1) 8.97239 98	(-1) 9.23079 84	(-1) 9.38567 64	(-1)				
-0.2	(-1)	7.92514 70	(-1) 8.96573 73	(-1) 9.31227 38	(-1) 9.48534 97	(-1) 9.58907 21	(-1)				
-0.1	(-1)	8.95782 77	(-1) 9.48069 78	(-1) 9.65480 34	(-1) 9.74174 76	(-1) 9.79384 48	(-1)				
0.0	(0)	1.00000 00	(0) 1.00000 00	(0) 1.00000 00	(0) 1.00000 00	(0) 1.00000 00	(0)				
0.1	(0)	1.10517 09	(0) 1.05236 64	(0) 1.03478 75	(0) 1.02601 15	(0) 1.02075 43	(0)				
0.2	(0)	1.21130 01	(0) 1.10517 09	(0) 1.06984 41	(0) 1.05220 99	(0) 1.04164 80	(0)				
0.3	(0)	1.31839 21	(0) 1.15841 56	(0) 1.10517 09	(0) 1.07859 61	(0) 1.06268 16	(0)				
0.4	(0)	1.42645 14	(0) 1.21210 24	(0) 1.14076 91	(0) 1.10517 09	(0) 1.08385 58	(0)				
0.5	(0)	1.53548 28	(0) 1.26623 34	(0) 1.17663 99	(0) 1.13193 51	(0) 1.10517 09	(0)				
0.6	(0)	1.64549 07	(0) 1.32081 05	(0) 1.21278 44	(0) 1.15888 93	(0) 1.12662 77	(0)				
0.7	(0)	1.75647 99	(0) 1.37583 59	(0) 1.24920 38	(0) 1.18603 45	(0) 1.14822 66	(0)				
0.8	(0)	1.86845 49	(0) 1.43131 14	(0) 1.28589 94	(0) 1.21337 14	(0) 1.16996 83	(0)				
0.9	(0)	1.98142 05	(0) 1.48723 92	(0) 1.32287 23	(0) 1.24090 08	(0) 1.19185 34	(0)				
1.0	(0)	2.09538 12	(0) 1.54362 12	(0) 1.36012 38	(0) 1.26862 36	(0) 1.21388 22	(0)				
$a \setminus b$		0.6	0.7	0.8	0.9	1.0					
-1.0	(-1)	8.33333 33	(-1) 8.57142 86	(-1) 8.75000 00	(-1) 8.88888 89	(-1) 9.00000 00	(-1)				
-0.9	(-1)	8.49524 54	(-1) 8.71045 21	(-1) 8.87183 35	(-1) 8.99733 47	(-1) 9.09772 21	(-1)				
-0.8	(-1)	8.65820 31	(-1) 8.85031 91	(-1) 8.99436 39	(-1) 9.10636 73	(-1) 9.19594 59	(-1)				
-0.7	(-1)	8.82221 06	(-1) 8.99103 26	(-1) 9.11759 38	(-1) 9.21598 87	(-1) 9.29467 31	(-1)				
-0.6	(-1)	8.98727 18	(-1) 9.13259 59	(-1) 9.24152 56	(-1) 9.32620 11	(-1) 9.39390 52	(-1)				
-0.5	(-1)	9.15339 10	(-1) 9.27501 22	(-1) 9.36616 18	(-1) 9.43700 64	(-1) 9.49364 42	(-1)				
-0.4	(-1)	9.32057 22	(-1) 9.41828 47	(-1) 9.49150 52	(-1) 9.54840 68	(-1) 9.59389 16	(-1)				
-0.3	(-1)	9.48881 96	(-1) 9.56241 64	(-1) 9.61755 81	(-1) 9.66040 42	(-1) 9.69464 91	(-1)				
-0.2	(-1)	9.65813 72	(-1) 9.70741 08	(-1) 9.74432 32	(-1) 9.77300 09	(-1) 9.79591 86	(-1)				
-0.1	(-1)	9.82852 93	(-1) 9.85327 09	(-1) 9.87180 29	(-1) 9.88619 88	(-1) 9.89770 16	(-1)				
0.0	(0)	1.00000 00	(0) 1.00000 00	(0) 1.00000 00	(0) 1.00000 00	(0) 1.00000 00	(0)				
0.1	(0)	1.01725 53	(0) 1.01476 01	(0) 1.01289 17	(0) 1.01144 07	(0) 1.01028 15	(0)				
0.2	(0)	1.03461 94	(0) 1.02960 78	(0) 1.02585 56	(0) 1.02294 21	(0) 1.02061 50	(0)				
0.3	(0)	1.05209 25	(0) 1.04454 34	(0) 1.03889 21	(0) 1.03450 45	(0) 1.03100 04	(0)				
0.4	(0)	1.06967 52	(0) 1.05956 71	(0) 1.05200 13	(0) 1.04612 80	(0) 1.04143 81	(0)				
0.5	(0)	1.08736 79	(0) 1.07467 94	(0) 1.06518 35	(0) 1.05781 30	(0) 1.05192 82	(0)				
0.6	(0)	1.10517 09	(0) 1.08988 06	(0) 1.07843 90	(0) 1.06955 95	(0) 1.06247 09	(0)				
0.7	(0)	1.12308 48	(0) 1.10517 09	(0) 1.09176 81	(0) 1.08136 79	(0) 1.07306 64	(0)				
0.8	(0)	1.14110 98	(0) 1.12055 08	(0) 1.10517 09	(0) 1.09323 83	(0) 1.08371 47	(0)				
0.9	(0)	1.15924 65	(0) 1.13602 05	(0) 1.11864 79	(0) 1.10517 09	(0) 1.09441 62	(0)				
1.0	(0)	1.17749 53	(0) 1.15158 03	(0) 1.13219 91	(0) 1.11716 60	(0) 1.10517 09	(0)				

For $0 \leq x \leq 1$, linear interpolation in a , b or x provides 3-4S. Lagrange four-point interpolation gives 7S in a , b or x over most of the table, but the Lagrange six-point formula is needed over the range $1 \leq x \leq 10$. Any interpolation formula can be reapplied to give two dimensional interpolates in a and b , a and x or b and x . This calculation can be checked by being repeated in a different order.

CONFLUENT HYPERGEOMETRIC FUNCTION $M(a, b, x)$

Table 13.1

$x=0.2$

$a \setminus b$	0.1	0.2	0.3	0.4	0.5
-1.0	(0) -1.00000 00	0.00000 00	(-1) 3.33333 33	(-1) 5.00000 00	(-1) 6.00000 00
-0.9	(-1) -8.16955 02	(-2) 9.22415 48	(-1) 3.95232 64	(-1) 5.46684 38	(-1) 6.37527 43
-0.8	(-1) -6.30239 72	(-1) 1.86164 63	(-1) 4.58166 34	(-1) 5.94088 89	(-1) 6.75592 38
-0.7	(-1) -4.39817 97	(-1) 2.81785 03	(-1) 5.22143 72	(-1) 6.42219 72	(-1) 7.14199 30
-0.6	(-1) -2.45653 39	(-1) 3.79118 64	(-1) 5.87174 11	(-1) 6.91083 10	(-1) 7.53352 62
-0.5	(-2) -4.77093 96	(-1) 4.78181 44	(-1) 6.53266 92	(-1) 7.40685 28	(-1) 7.93056 84
-0.4	(-1) +1.54050 87	(-1) 5.78989 52	(-1) 7.20431 59	(-1) 7.91032 56	(-1) 8.33316 46
-0.3	(-1) 3.59664 50	(-1) 6.81559 07	(-1) 7.88677 63	(-1) 8.42131 28	(-1) 8.74136 01
-0.2	(-1) 5.69168 81	(-1) 7.85906 39	(-1) 8.58014 62	(-1) 8.93987 82	(-1) 9.15520 06
-0.1	(-1) 7.82601 37	(-1) 8.92047 86	(-1) 9.28452 18	(-1) 9.46608 57	(-1) 9.57473 18
0.0	(0) 1.00000 00	(0) 1.00000 00	(0) 1.00000 00	(0) 1.00000 00	(0) 1.00000 00
0.1	(0) 1.22140 28	(0) 1.10977 94	(0) 1.07266 78	(0) 1.05416 86	(0) 1.04310 51
0.2	(0) 1.44684 80	(0) 1.22140 28	(0) 1.14646 55	(0) 1.10912 09	(0) 1.08679 33
0.3	(0) 1.67637 41	(0) 1.33488 69	(0) 1.22140 28	(0) 1.16486 34	(0) 1.13106 91
0.4	(0) 1.91002 01	(0) 1.45024 87	(0) 1.29748 97	(0) 1.22140 28	(0) 1.17593 74
0.5	(0) 2.14782 49	(0) 1.56750 53	(0) 1.37473 61	(0) 1.27874 56	(0) 1.22140 28
0.6	(0) 2.38982 79	(0) 1.68667 37	(0) 1.45315 23	(0) 1.33689 87	(0) 1.26747 01
0.7	(0) 2.63606 85	(0) 1.80777 12	(0) 1.53274 81	(0) 1.39586 86	(0) 1.31414 41
0.8	(0) 2.88658 67	(0) 1.93081 51	(0) 1.61353 39	(0) 1.45566 22	(0) 1.36142 97
0.9	(0) 3.14142 25	(0) 2.05582 28	(0) 1.69551 97	(0) 1.51628 63	(0) 1.40933 17
1.0	(0) 3.40061 61	(0) 2.18281 20	(0) 1.77871 60	(0) 1.57774 76	(0) 1.45785 51
$a \setminus b$	0.6	0.7	0.8	0.9	1.0
-1.0	(-1) 6.66666 67	(-1) 7.14285 71	(-1) 7.50000 00	(-1) 7.77777 78	(-1) 8.00000 00
-0.9	(-1) 6.98070 53	(-1) 7.41302 26	(-1) 7.73716 33	(-1) 7.98920 01	(-1) 8.19077 41
-0.8	(-1) 7.29894 21	(-1) 7.68657 38	(-1) 7.97712 40	(-1) 8.20297 76	(-1) 8.38356 13
-0.7	(-1) 7.62141 04	(-1) 7.96353 68	(-1) 8.21990 25	(-1) 8.41912 68	(-1) 8.57837 54
-0.6	(-1) 7.94814 35	(-1) 8.24393 73	(-1) 8.46551 94	(-1) 8.63766 45	(-1) 8.77523 03
-0.5	(-1) 8.27917 51	(-1) 8.52780 14	(-1) 8.71399 57	(-1) 8.85860 76	(-1) 8.97413 99
-0.4	(-1) 8.61453 89	(-1) 8.81515 54	(-1) 8.96535 20	(-1) 9.08197 30	(-1) 9.17511 81
-0.3	(-1) 8.95426 91	(-1) 9.10602 57	(-1) 9.21960 95	(-1) 9.30777 78	(-1) 9.37817 91
-0.2	(-1) 9.29839 97	(-1) 9.40043 88	(-1) 9.47678 92	(-1) 9.53603 91	(-1) 9.58333 69
-0.1	(-1) 9.64696 51	(-1) 9.69842 13	(-1) 9.73691 22	(-1) 9.76677 40	(-1) 9.79060 58
0.0	(0) 1.00000 00	(0) 1.00000 00	(0) 1.00000 00	(0) 1.00000 00	(0) 1.00000 00
0.1	(0) 1.03575 39	(0) 1.03052 02	(0) 1.02660 74	(0) 1.02357 34	(0) 1.02115 34
0.2	(0) 1.07196 17	(0) 1.06140 54	(0) 1.05351 56	(0) 1.04739 95	(0) 1.04252 22
0.3	(0) 1.10862 70	(0) 1.09265 84	(0) 1.08072 66	(0) 1.07147 98	(0) 1.06410 78
0.4	(0) 1.14575 32	(0) 1.12428 18	(0) 1.10824 29	(0) 1.09581 63	(0) 1.08591 18
0.5	(0) 1.18334 39	(0) 1.15627 85	(0) 1.13606 64	(0) 1.12041 07	(0) 1.10793 56
0.6	(0) 1.22140 28	(0) 1.18865 12	(0) 1.16419 94	(0) 1.14526 47	(0) 1.13018 06
0.7	(0) 1.25993 33	(0) 1.22140 28	(0) 1.19264 41	(0) 1.17038 02	(0) 1.15264 83
0.8	(0) 1.29893 91	(0) 1.25453 59	(0) 1.22140 28	(0) 1.19575 89	(0) 1.17534 02
0.9	(0) 1.33842 39	(0) 1.28805 34	(0) 1.25047 76	(0) 1.22140 28	(0) 1.19825 79
1.0	(0) 1.37839 12	(0) 1.32195 81	(0) 1.27987 08	(0) 1.24731 35	(0) 1.22140 28

Table 13.1 CONFLUENT HYPERGEOMETRIC FUNCTION $M(a, b, x)$

		$x=0.3$										
$a \setminus b$		0.1		0.2		0.3		0.4		0.5		
-1.0	(0)	-2.00000 00	(-1)	-5.00000 00	(-1)	0.00000 00	(-1)	2.50000 00	(-1)	4.00000 00	(-1)	4.00000 00
-0.9	(0)	-1.73884 94	(-1)	-3.67762 19	(-2)	8.90939 59	(-1)	3.17420 35	(-1)	4.54351 25	(-1)	4.54351 25
-0.8	(0)	-1.46940 36	(-1)	-2.31724 76	(-1)	1.80524 85	(-1)	3.86467 39	(-1)	5.09916 51	(-1)	5.09916 51
-0.7	(0)	-1.19153 81	(-2)	-9.18332 95	(-1)	2.74324 64	(-1)	4.57162 39	(-1)	5.66711 03	(-1)	5.66711 03
-0.6	(-1)	-9.05127 09	(-2)	+5.19671 16	(-1)	3.70525 58	(-1)	5.29526 85	(-1)	6.24750 17	(-1)	6.24750 17
-0.5	(-1)	-6.10043 44	(-1)	1.99731 93	(-1)	4.69160 23	(-1)	6.03582 44	(-1)	6.84049 44	(-1)	6.84049 44
-0.4	(-1)	-3.06158 84	(-1)	3.51517 11	(-1)	5.70261 46	(-1)	6.79351 05	(-1)	7.44624 48	(-1)	7.44624 48
-0.3	(-3)	+6.65629 62	(-1)	5.07379 19	(-1)	6.73862 42	(-1)	7.56854 74	(-1)	8.06491 07	(-1)	8.06491 07
-0.2	(-1)	3.28532 83	(-1)	6.67375 21	(-1)	7.79996 60	(-1)	8.36115 78	(-1)	8.69665 13	(-1)	8.69665 13
-0.1	(-1)	6.59602 92	(-1)	8.31562 77	(-1)	8.88697 76	(-1)	9.17156 65	(-1)	9.34162 71	(-1)	9.34162 71
0.0	(0)	1.00000 00	(0)	1.00000 00	(0)	1.00000 00	(0)	1.00000 00	(0)	1.00000 00	(0)	1.00000 00
0.1	(0)	1.34985 88	(0)	1.17274 56	(0)	1.11393 77	(0)	1.08466 87	(0)	1.06719 33	(0)	1.06719 33
0.2	(0)	1.70931 54	(0)	1.34985 88	(0)	1.23054 56	(0)	1.17118 59	(0)	1.13575 92	(0)	1.13575 92
0.3	(0)	2.07850 71	(0)	1.53139 94	(0)	1.34985 88	(0)	1.25957 47	(0)	1.20571 42	(0)	1.20571 42
0.4	(0)	2.45757 28	(0)	1.71742 78	(0)	1.47191 26	(0)	1.34985 88	(0)	1.27707 51	(0)	1.27707 51
0.5	(0)	2.84665 23	(0)	1.90800 49	(0)	1.59674 26	(0)	1.44206 18	(0)	1.34985 88	(0)	1.34985 88
0.6	(0)	3.24588 71	(0)	2.10319 22	(0)	1.72438 49	(0)	1.53620 75	(0)	1.42408 24	(0)	1.42408 24
0.7	(0)	3.65541 99	(0)	2.30305 18	(0)	1.85487 58	(0)	1.63232 02	(0)	1.49976 30	(0)	1.49976 30
0.8	(0)	4.07539 50	(0)	2.50764 63	(0)	1.98825 19	(0)	1.73042 41	(0)	1.57691 80	(0)	1.57691 80
0.9	(0)	4.50595 77	(0)	2.71703 89	(0)	2.12455 03	(0)	1.83054 38	(0)	1.65556 49	(0)	1.65556 49
1.0	(0)	4.94725 50	(0)	2.93129 36	(0)	2.26380 82	(0)	1.93270 41	(0)	1.73572 13	(0)	1.73572 13
		$x=0.6$										
$a \setminus b$		0.6		0.7		0.8		0.9		1.0		
-1.0	(-1)	5.00000 00	(-1)	5.71428 57	(-1)	6.25000 00	(-1)	6.66666 67	(-1)	7.00000 00	(-1)	7.00000 00
-0.9	(-1)	5.45594 63	(-1)	6.10737 55	(-1)	6.59572 25	(-1)	6.97537 97	(-1)	7.27897 71	(-1)	7.27897 71
-0.8	(-1)	5.92137 29	(-1)	6.50811 03	(-1)	6.94776 02	(-1)	7.28940 91	(-1)	7.56249 82	(-1)	7.56249 82
-0.7	(-1)	6.39639 42	(-1)	6.91657 86	(-1)	7.30618 39	(-1)	7.60881 20	(-1)	7.85061 06	(-1)	7.85061 06
-0.6	(-1)	6.88112 54	(-1)	7.33287 00	(-1)	7.67106 45	(-1)	7.93364 63	(-1)	8.14336 18	(-1)	8.14336 18
-0.5	(-1)	7.37568 28	(-1)	7.75707 44	(-1)	8.04247 38	(-1)	8.26397 01	(-1)	8.44079 99	(-1)	8.44079 99
-0.4	(-1)	7.88018 36	(-1)	8.18928 28	(-1)	8.42048 41	(-1)	8.59984 20	(-1)	8.74297 33	(-1)	8.74297 33
-0.3	(-1)	8.39474 59	(-1)	8.62958 68	(-1)	8.80516 81	(-1)	8.94132 11	(-1)	9.04993 07	(-1)	9.04993 07
-0.2	(-1)	8.91948 91	(-1)	9.07807 88	(-1)	9.19659 93	(-1)	9.28846 71	(-1)	9.36172 12	(-1)	9.36172 12
-0.1	(-1)	9.45453 34	(-1)	9.53485 19	(-1)	9.59485 17	(-1)	9.64133 99	(-1)	9.67839 44	(-1)	9.67839 44
0.0	(0)	1.00000 00	(0)	1.00000 00	(0)	1.00000 00	(0)	1.00000 00	(0)	1.00000 00	(0)	1.00000 00
0.1	(0)	1.05560 11	(0)	1.04736 18	(0)	1.04121 19	(0)	1.03645 08	(0)	1.03265 88	(0)	1.03265 88
0.2	(0)	1.11226 90	(0)	1.09558 01	(0)	1.08312 85	(0)	1.07349 27	(0)	1.06582 10	(0)	1.06582 10
0.3	(0)	1.17001 62	(0)	1.14466 45	(0)	1.12575 75	(0)	1.11113 16	(0)	1.09949 16	(0)	1.09949 16
0.4	(0)	1.22885 51	(0)	1.19462 48	(0)	1.16910 65	(0)	1.14937 40	(0)	1.13367 58	(0)	1.13367 58
0.5	(0)	1.28879 84	(0)	1.24547 07	(0)	1.21318 32	(0)	1.18822 61	(0)	1.16837 88	(0)	1.16837 88
0.6	(0)	1.34985 88	(0)	1.29721 20	(0)	1.25799 56	(0)	1.22769 42	(0)	1.20360 57	(0)	1.20360 57
0.7	(0)	1.41204 93	(0)	1.34985 88	(0)	1.30355 15	(0)	1.26778 47	(0)	1.23936 18	(0)	1.23936 18
0.8	(0)	1.47538 27	(0)	1.40342 10	(0)	1.34985 88	(0)	1.30850 41	(0)	1.27565 25	(0)	1.27565 25
0.9	(0)	1.53987 22	(0)	1.45790 88	(0)	1.39692 56	(0)	1.34985 88	(0)	1.31248 30	(0)	1.31248 30
1.0	(0)	1.60553 08	(0)	1.51333 23	(0)	1.44475 99	(0)	1.39185 54	(0)	1.34985 88	(0)	1.34985 88

CONFLUENT HYPERGEOMETRIC FUNCTION $M(a, b, x)$

Table 13.1

$x=0.4$

$a \setminus b$	0.1	0.2	0.3	0.4	0.5
-1.0	(0) -3.00000 00	(0) -1.00000 00	(-1) -3.33333 33	0.00000 00	(-1) 2.00000 00
-0.9	(0) -2.67035 54	(-1) -8.32139 43	(-1) -2.19718 27	(-2) 8.63057 33	(-1) 2.69801 05
-0.8	(0) -2.32590 02	(-1) -6.57495 96	(-1) -1.01932 12	(-1) 1.75514 40	(-1) 3.41768 30
-0.7	(0) -1.96633 24	(-1) -4.75937 91	(-2) +2.01024 24	(-1) 2.67677 48	(-1) 4.15938 56
-0.6	(0) -1.59134 63	(-1) -2.87331 90	(-1) 1.46463 65	(-1) 3.62847 08	(-1) 4.92349 10
-0.5	(0) -1.20063 19	(-2) -9.15428 01	(-1) 2.77230 84	(-1) 4.61075 95	(-1) 5.71037 59
-0.4	(-1) -7.93875 31	(-1) +1.11566 21	(-1) 4.12484 23	(-1) 5.62417 45	(-1) 6.52042 19
-0.3	(-1) -3.70758 28	(-1) 3.22133 74	(-1) 5.52305 08	(-1) 6.66925 61	(-1) 7.35401 47
-0.2	(-2) +6.90415 20	(-1) 5.40300 15	(-1) 6.96775 63	(-1) 7.74655 09	(-1) 8.21154 46
-0.1	(-1) 5.25850 66	(-1) 7.66207 59	(-1) 8.45979 18	(-1) 8.85661 23	(-1) 9.09340 66
0.0	(0) 1.00000 00	(0) 1.00000 00	(0) 1.00000 00	(0) 1.00000 00	(0) 1.00000 00
0.1	(0) 1.49182 47	(0) 1.24182 32	(0) 1.15892 34	(0) 1.11772 81	(0) 1.09317 29
0.2	(0) 2.00166 43	(0) 1.49182 47	(0) 1.32283 59	(0) 1.23890 28	(0) 1.18890 02
0.3	(0) 2.52986 27	(0) 1.75015 41	(0) 1.49182 47	(0) 1.36358 21	(0) 1.28722 33
0.4	(0) 3.07676 82	(0) 2.01696 26	(0) 1.66597 84	(0) 1.49182 47	(0) 1.38818 41
0.5	(0) 3.64273 38	(0) 2.29240 35	(0) 1.84538 67	(0) 1.62369 00	(0) 1.49182 47
0.6	(0) 4.22811 68	(0) 2.57663 20	(0) 2.03014 00	(0) 1.75923 82	(0) 1.59818 80
0.7	(0) 4.83327 91	(0) 2.86980 51	(0) 2.22033 03	(0) 1.89852 99	(0) 1.70731 73
0.8	(0) 5.45858 73	(0) 3.17208 18	(0) 2.41605 02	(0) 2.04162 67	(0) 1.81925 64
0.9	(0) 6.10441 27	(0) 3.48362 30	(0) 2.61739 39	(0) 2.18859 08	(0) 1.93404 94
1.0	(0) 6.77113 12	(0) 3.80459 19	(0) 2.82445 63	(0) 2.33948 51	(0) 2.05174 12

$a \setminus b$	0.6	0.7	0.8	0.9	1.0
-1.0	(-1) 3.33333 33	(-1) 4.28571 43	(-1) 5.00000 00	(-1) 5.55555 56	(-1) 6.00000 00
-0.9	(-1) 3.92050 85	(-1) 4.79315 51	(-1) 5.44722 84	(-1) 5.95564 45	(-1) 6.36214 28
-0.8	(-1) 4.52459 74	(-1) 5.31423 36	(-1) 5.90572 12	(-1) 6.36521 50	(-1) 6.73238 89
-0.7	(-1) 5.14587 62	(-1) 5.84916 36	(-1) 6.37564 87	(-1) 6.78440 52	(-1) 7.11085 21
-0.6	(-1) 5.78462 40	(-1) 6.39816 17	(-1) 6.85718 29	(-1) 7.21335 46	(-1) 7.49764 78
-0.5	(-1) 6.44112 32	(-1) 6.96144 64	(-1) 7.35049 77	(-1) 7.65220 44	(-1) 7.89289 21
-0.4	(-1) 7.11565 94	(-1) 7.53923 92	(-1) 7.85576 88	(-1) 8.10109 70	(-1) 8.29670 27
-0.3	(-1) 7.80852 14	(-1) 8.13176 35	(-1) 8.37317 41	(-1) 8.56017 66	(-1) 8.70919 82
-0.2	(-1) 8.52000 13	(-1) 8.73924 56	(-1) 8.90289 30	(-1) 9.02958 86	(-1) 9.13049 86
-0.1	(-1) 9.25039 46	(-1) 9.36191 40	(-1) 9.44510 72	(-1) 9.50948 02	(-1) 9.56072 51
0.0	(0) 1.00000 00	(0) 1.00000 00	(0) 1.00000 00	(0) 1.00000 00	(0) 1.00000 00
0.1	(0) 1.07691 20	(0) 1.06537 37	(0) 1.05677 57	(0) 1.05012 98	(0) 1.04484 47
0.2	(0) 1.15580 59	(0) 1.13233 62	(0) 1.11485 65	(0) 1.10135 26	(0) 1.09061 91
0.3	(0) 1.23671 28	(0) 1.20091 13	(0) 1.17426 15	(0) 1.15368 38	(0) 1.13733 58
0.4	(0) 1.31966 37	(0) 1.27112 31	(0) 1.23500 97	(0) 1.20713 88	(0) 1.18500 76
0.5	(0) 1.40469 04	(0) 1.34299 62	(0) 1.29712 04	(0) 1.26173 33	(0) 1.23364 74
0.6	(0) 1.49182 47	(0) 1.41655 50	(0) 1.36061 33	(0) 1.31748 31	(0) 1.28326 80
0.7	(0) 1.58109 90	(0) 1.49182 47	(0) 1.42550 81	(0) 1.37440 41	(0) 1.33388 28
0.8	(0) 1.67254 59	(0) 1.56883 03	(0) 1.49182 47	(0) 1.43251 25	(0) 1.38550 48
0.9	(0) 1.76619 84	(0) 1.64759 75	(0) 1.55958 33	(0) 1.49182 47	(0) 1.43814 76
1.0	(0) 1.86208 99	(0) 1.72815 18	(0) 1.62880 44	(0) 1.55235 70	(0) 1.49182 47

Table 13.1

CONFLUENT HYPERGEOMETRIC FUNCTION $M(a, b, x)$

		$x=0.5$										
$a \setminus b$		0.1		0.2		0.3		0.4		0.5		
-1.0	(0)	-4.00000 00	(0)	-1.50000 00	(-1)	-6.66666 67	(-1)	-2.50000 00	(-1)	-1.46751 27	(-2)	0.00000 00
-0.9	(0)	-3.61201 86	(0)	-1.30112 70	(-1)	-5.31342 47	(-1)	-1.46751 27	(-1)	-3.89499 09	(-1)	8.38114 43
-0.8	(0)	-3.20079 89	(0)	-1.09161 33	(-1)	-3.89475 90	(-1)	-3.89499 09	(-2)	+7.35066 66	(-1)	1.71019 66
-0.7	(0)	-2.76573 85	(-1)	-8.71196 18	(-1)	-2.40912 78	(-2)	+7.35066 66	(-1)	1.90722 60	(-1)	2.61697 96
-0.6	(0)	-2.30622 47	(-1)	-6.39608 65	(-2)	-8.54965 30	(-1)	1.90722 60	(-1)		(-1)	3.55920 78
-0.5	(0)	-1.82163 45	(-1)	-3.96579 38	(-2)	+7.69319 06	(-1)	3.12803 64	(-1)		(-1)	4.53763 61
-0.4	(0)	-1.31133 45	(-1)	-1.41832 63	(-1)	2.46534 08	(-1)	4.39857 14	(-1)		(-1)	5.55303 09
-0.3	(-1)	-7.74681 00	(-1)	+1.24911 75	(-1)	4.23474 05	(-1)	5.71992 06	(-1)		(-1)	6.60617 00
-0.2	(-1)	-2.11019 41	(-1)	4.03938 42	(-1)	6.07918 46	(-1)	7.09319 04	(-1)		(-1)	7.69784 21
-0.1	(-1)	+3.80315 52	(-1)	6.95536 57	(-1)	8.00036 50	(-1)	8.51950 36	(-1)		(-1)	8.82884 81
0.0	(0)	1.00000 00	(0)	1.00000 00	(0)	1.00000 00	(0)	1.00000 00	(0)	1.00000 00	(0)	1.00000 00
0.1	(0)	1.64872 13	(0)	1.31762 72	(0)	1.20798 34	(0)	1.15358 36	(0)	1.12121 22	(0)	1.12121 22
0.2	(0)	2.32717 78	(0)	1.64872 13	(0)	1.42416 39	(0)	1.31281 87	(0)	1.24660 50	(0)	1.24660 50
0.3	(0)	3.03607 92	(0)	1.99359 02	(0)	1.64872 13	(0)	1.47782 42	(0)	1.37626 32	(0)	1.37626 32
0.4	(0)	3.77614 69	(0)	2.35254 68	(0)	1.88183 81	(0)	1.64872 13	(0)	1.51027 29	(0)	1.51027 29
0.5	(0)	4.54811 35	(0)	2.72590 86	(0)	2.12369 98	(0)	1.82563 24	(0)	1.64872 13	(0)	1.64872 13
0.6	(0)	5.35272 38	(0)	3.11399 83	(0)	2.37449 45	(0)	2.00868 23	(0)	1.79169 69	(0)	1.79169 69
0.7	(0)	6.19073 40	(0)	3.51714 35	(0)	2.63441 32	(0)	2.19799 70	(0)	1.93928 94	(0)	1.93928 94
0.8	(0)	7.06291 26	(0)	3.93567 68	(0)	2.90364 98	(0)	2.39370 49	(0)	2.09159 01	(0)	2.09159 01
0.9	(0)	7.97004 04	(0)	4.36993 59	(0)	3.18240 09	(0)	2.59593 60	(0)	2.24869 11	(0)	2.24869 11
1.0	(0)	8.91291 03	(0)	4.82026 39	(0)	3.47086 63	(0)	2.80482 21	(0)	2.41068 61	(0)	2.41068 61
$a \setminus b$		0.6		0.7		0.8		0.9		1.0		
-1.0	(-1)	1.66666 67	(-1)	2.85714 29	(-1)	3.75000 00	(-1)	4.44444 44	(-1)	5.00000 00	(-1)	5.00000 00
-0.9	(-1)	2.37390 35	(-1)	3.46998 42	(-1)	4.29138 21	(-1)	4.92975 27	(-1)	5.44007 21	(-1)	5.44007 21
-0.8	(-1)	3.10765 94	(-1)	4.10420 52	(-1)	4.85042 16	(-1)	5.42992 21	(-1)	5.89284 39	(-1)	5.89284 39
-0.7	(-1)	3.86848 36	(-1)	4.76023 18	(-1)	5.42745 70	(-1)	5.94522 72	(-1)	6.35854 17	(-1)	6.35854 17
-0.6	(-1)	4.65693 33	(-1)	5.43849 54	(-1)	6.02283 14	(-1)	6.47594 62	(-1)	6.83739 50	(-1)	6.83739 50
-0.5	(-1)	5.47357 40	(-1)	6.13943 38	(-1)	6.63689 23	(-1)	7.02236 09	(-1)	7.32963 60	(-1)	7.32963 60
-0.4	(-1)	6.31897 89	(-1)	6.86349 09	(-1)	7.26999 22	(-1)	7.58475 70	(-1)	7.83550 00	(-1)	7.83550 00
-0.3	(-1)	7.19372 99	(-1)	7.61111 66	(-1)	7.92248 85	(-1)	8.16342 38	(-1)	8.35522 55	(-1)	8.35522 55
-0.2	(-1)	8.09841 67	(-1)	8.38276 72	(-1)	8.59474 31	(-1)	8.75865 45	(-1)	8.88905 38	(-1)	8.88905 38
-0.1	(-1)	9.03363 78	(-1)	9.17890 54	(-1)	9.28712 29	(-1)	9.37074 63	(-1)	9.43722 94	(-1)	9.43722 94
0.0	(0)	1.00000 00	(0)	1.00000 00	(0)	1.00000 00	(0)	1.00000 00	(0)	1.00000 00	(0)	1.00000 00
0.1	(0)	1.09981 19	(0)	1.08465 27	(0)	1.07337 51	(0)	1.06467 21	(0)	1.05776 16	(0)	1.05776 16
0.2	(0)	1.20286 18	(0)	1.17189 67	(0)	1.14887 58	(0)	1.13112 17	(0)	1.11703 33	(0)	1.11703 33
0.3	(0)	1.30921 31	(0)	1.26178 10	(0)	1.22654 08	(0)	1.19938 02	(0)	1.17784 06	(0)	1.17784 06
0.4	(0)	1.41892 99	(0)	1.35435 51	(0)	1.30640 94	(0)	1.26947 93	(0)	1.24020 96	(0)	1.24020 96
0.5	(0)	1.53207 73	(0)	1.44966 91	(0)	1.38852 11	(0)	1.34145 10	(0)	1.30416 68	(0)	1.30416 68
0.6	(0)	1.64872 13	(0)	1.54777 40	(0)	1.47291 64	(0)	1.41532 79	(0)	1.36973 88	(0)	1.36973 88
0.7	(0)	1.76892 87	(0)	1.64872 13	(0)	1.55963 60	(0)	1.49114 29	(0)	1.43695 27	(0)	1.43695 27
0.8	(0)	1.89276 74	(0)	1.75256 32	(0)	1.64872 13	(0)	1.56892 95	(0)	1.50583 59	(0)	1.50583 59
0.9	(0)	2.02030 62	(0)	1.85935 29	(0)	1.74021 40	(0)	1.64872 13	(0)	1.57641 61	(0)	1.57641 61
1.0	(0)	2.15161 47	(0)	1.96914 38	(0)	1.83415 67	(0)	1.73055 26	(0)	1.64872 13	(0)	1.64872 13

CONFLUENT HYPERGEOMETRIC FUNCTION $M(a, b, x)$

Table 13.1

		$x=0.6$									
$a \setminus b$		0.1	0.2	0.3	0.4	0.5	0.6	0.7	0.8	0.9	1.0
-1.0	(0)	-5.00000 00	(0) -2.00000 00	(0) -1.00000 00	(-1) -5.00000 00	(-1) -2.00000 00	(-1) 0.00000 00	(-1) 0.00000 00	(-1) 0.00000 00	(-1) 0.00000 00	(-1) 0.00000 00
-0.9	(0)	-4.56442 36	(0) -1.77497 83	(-1) -8.45926 51	(-1) -3.81848 50	(-1) -1.03687 14	(-1) 0.00000 00	(-1) 0.00000 00	(-1) 0.00000 00	(-1) 0.00000 00	(-1) 0.00000 00
-0.8	(0)	-4.09525 03	(0) -1.53457 51	(-1) -6.82397 09	(-1) -2.57117 79	(-3) -2.46606 50	(-1) 0.00000 00	(-1) 0.00000 00	(-1) 0.00000 00	(-1) 0.00000 00	(-1) 0.00000 00
-0.7	(0)	-3.59141 57	(0) -1.27832 65	(-1) -5.09139 76	(-1) -1.25627 00	(-1) +1.03792 44	(-1) 0.00000 00	(-1) 0.00000 00	(-1) 0.00000 00	(-1) 0.00000 00	(-1) 0.00000 00
-0.6	(0)	-3.05183 34	(0) -1.00575 96	(-1) -3.25877 35	(-2) +1.28080 81	(-1) 2.15219 91	(-1) 0.00000 00	(-1) 0.00000 00	(-1) 0.00000 00	(-1) 0.00000 00	(-1) 0.00000 00
-0.5	(0)	-2.47539 54	(-1) -7.16392 12	(-1) -1.32327 40	(-1) 1.58375 09	(-1) 3.31950 22	(-1) 0.00000 00	(-1) 0.00000 00	(-1) 0.00000 00	(-1) 0.00000 00	(-1) 0.00000 00
-0.4	(0)	-1.86097 11	(-1) -4.09732 38	(-2) +7.17978 94	(-1) 3.11265 10	(-1) 4.54119 67	(-1) 0.00000 00	(-1) 0.00000 00	(-1) 0.00000 00	(-1) 0.00000 00	(-1) 0.00000 00
-0.3	(0)	-1.20740 73	(-2) -8.52791 51	(-1) 2.86791 75	(-1) 4.71672 67	(-1) 5.81866 96	(-1) 0.00000 00	(-1) 0.00000 00	(-1) 0.00000 00	(-1) 0.00000 00	(-1) 0.00000 00
-0.2	(-1)	-5.13527 80	(-1) +2.57478 49	(-1) 5.12952 90	(-1) 6.39795 93	(-1) 7.15333 26	(-1) 0.00000 00	(-1) 0.00000 00	(-1) 0.00000 00	(-1) 0.00000 00	(-1) 0.00000 00
-0.1	(-1)	+2.21866 89	(-1) 6.19061 29	(-1) 7.50585 66	(-1) 8.15836 59	(-1) 8.54662 21	(-1) 0.00000 00	(-1) 0.00000 00	(-1) 0.00000 00	(-1) 0.00000 00	(-1) 0.00000 00
0.0	(0)	1.00000 00	(0) 1.00000 00	(0) 1.00000 00	(0) 1.00000 00	(0) 1.00000 00	(0) 1.00000 00	(0) 1.00000 00	(0) 1.00000 00	(0) 1.00000 00	(0) 1.00000 00
0.1	(0)	1.82211 88	(0) 1.40083 55	(0) 1.26151 16	(0) 1.19249 52	(0) 1.15149 54	(0) 1.00000 00	(0) 1.00000 00	(0) 1.00000 00	(0) 1.00000 00	(0) 1.00000 00
0.2	(0)	2.68949 50	(0) 1.82211 88	(0) 1.53544 21	(0) 1.39353 51	(0) 1.30929 96	(0) 1.00000 00	(0) 1.00000 00	(0) 1.00000 00	(0) 1.00000 00	(0) 1.00000 00
0.3	(0)	3.60342 49	(0) 2.26441 16	(0) 1.82211 88	(0) 1.60333 61	(0) 1.47356 68	(0) 1.00000 00	(0) 1.00000 00	(0) 1.00000 00	(0) 1.00000 00	(0) 1.00000 00
0.4	(0)	4.56523 01	(0) 2.72828 58	(0) 2.12187 52	(0) 1.82211 88	(0) 1.64445 34	(0) 1.00000 00	(0) 1.00000 00	(0) 1.00000 00	(0) 1.00000 00	(0) 1.00000 00
0.5	(0)	5.57625 77	(0) 3.21432 45	(0) 2.43505 08	(0) 2.05010 75	(0) 1.82211 88	(0) 1.00000 00	(0) 1.00000 00	(0) 1.00000 00	(0) 1.00000 00	(0) 1.00000 00
0.6	(0)	6.63788 04	(0) 3.72312 11	(0) 2.76199 12	(0) 2.28753 06	(0) 2.00672 51	(0) 1.00000 00	(0) 1.00000 00	(0) 1.00000 00	(0) 1.00000 00	(0) 1.00000 00
0.7	(0)	7.75149 76	(0) 4.25528 05	(0) 3.10304 83	(0) 2.53462 03	(0) 2.19843 71	(0) 1.00000 00	(0) 1.00000 00	(0) 1.00000 00	(0) 1.00000 00	(0) 1.00000 00
0.8	(0)	8.91853 48	(0) 4.81141 85	(0) 3.45858 04	(0) 2.79161 30	(0) 2.39742 24	(0) 1.00000 00	(0) 1.00000 00	(0) 1.00000 00	(0) 1.00000 00	(0) 1.00000 00
0.9	(1)	1.01404 45	(0) 5.39216 24	(0) 3.82895 20	(0) 3.05874 93	(0) 2.60385 15	(0) 1.00000 00	(0) 1.00000 00	(0) 1.00000 00	(0) 1.00000 00	(0) 1.00000 00
1.0	(1)	1.14187 08	(0) 5.99815 10	(0) 4.21453 44	(0) 3.33627 37	(0) 2.81789 78	(0) 1.00000 00	(0) 1.00000 00	(0) 1.00000 00	(0) 1.00000 00	(0) 1.00000 00

$a \setminus b$		0.6	0.7	0.8	0.9	1.0
-1.0		0.00000 00	(-1) 1.42857 14	(-1) 2.50000 00	(-1) 3.33333 33	(-1) 4.00000 00
-0.9	(-2)	8.15612 80	(-1) 2.13746 25	(-1) 3.12786 69	(-1) 3.89744 84	(-1) 4.51255 49
-0.8	(-1)	1.66954 03	(-1) 2.87723 99	(-1) 3.78124 01	(-1) 4.48302 85	(-1) 5.04345 12
-0.7	(-1)	2.56274 99	(-1) 3.64865 28	(-1) 4.46071 49	(-1) 5.09055 63	(-1) 5.59308 68
-0.6	(-1)	3.49622 62	(-1) 4.45246 33	(-1) 5.16689 67	(-1) 5.72052 24	(-1) 6.16186 59
-0.5	(-1)	4.47097 05	(-1) 5.28944 63	(-1) 5.90040 05	(-1) 6.37342 52	(-1) 6.75019 92
-0.4	(-1)	5.48800 20	(-1) 6.16039 00	(-1) 6.66185 18	(-1) 7.04977 12	(-1) 7.35850 35
-0.3	(-1)	6.54835 72	(-1) 7.06609 56	(-1) 7.45188 61	(-1) 7.75007 48	(-1) 7.98720 24
-0.2	(-1)	7.65309 05	(-1) 8.00737 79	(-1) 8.27114 95	(-1) 8.47485 87	(-1) 8.63672 59
-0.1	(-1)	8.80327 45	(-1) 8.98506 53	(-1) 9.12029 84	(-1) 9.22465 40	(-1) 9.30751 06
0.0	(0)	1.00000 00	(0) 1.00000 00	(0) 1.00000 00	(0) 1.00000 00	(0) 1.00000 00
0.1	(0)	1.12443 77	(0) 1.10530 38	(0) 1.09109 32	(0) 1.08014 45	(0) 1.07146 44
0.2	(0)	1.25375 32	(0) 1.21450 50	(0) 1.18537 84	(0) 1.16295 44	(0) 1.14519 01
0.3	(0)	1.38806 15	(0) 1.32769 20	(0) 1.28292 55	(0) 1.24848 64	(0) 1.22122 33
0.4	(0)	1.52747 91	(0) 1.44495 47	(0) 1.38380 56	(0) 1.33679 79	(0) 1.29961 13
0.5	(0)	1.67212 47	(0) 1.56638 46	(0) 1.48809 10	(0) 1.42794 70	(0) 1.38040 19
0.6	(0)	1.82211 88	(0) 1.69207 45	(0) 1.59585 51	(0) 1.52199 31	(0) 1.46364 36
0.7	(0)	1.97758 41	(0) 1.82211 88	(0) 1.70717 25	(0) 1.61899 63	(0) 1.54938 57
0.8	(0)	2.13864 53	(0) 1.95661 34	(0) 1.82211 88	(0) 1.71901 75	(0) 1.63767 83
0.9	(0)	2.30542 91	(0) 2.09565 57	(0) 1.94077 10	(0) 1.82211 88	(0) 1.72857 22
1.0	(0)	2.47806 43	(0) 2.23934 48	(0) 2.06320 72	(0) 1.92836 31	(0) 1.82211 88

Table 13.1 CONFLUENT HYPERGEOMETRIC FUNCTION $M(a, b, x)$

$x=0.7$

$a \setminus b$	0.1	0.2	0.3	0.4	0.5
-1.0	(0) -6.00000 00	(0) -2.50000 00	(0) -1.33333 33	(-1) -7.50000 00	(-1) -4.00000 00
-0.9	(0) -5.52819 79	(0) -2.25396 47	(0) -1.16362 83	(-1) -6.19090 30	(-1) -2.92768 78
-0.8	(0) -5.01049 23	(0) -1.98691 64	(-1) -9.81007 11	(-1) -4.79194 87	(-1) -1.78834 77
-0.7	(0) -4.44515 47	(0) -1.69810 26	(-1) -7.85028 60	(-1) -3.30020 58	(-2) -5.79886 90
-0.6	(0) -3.83041 49	(0) -1.38675 31	(-1) -5.75241 82	(-1) -1.71267 91	(-2) +6.99831 62
-0.5	(0) -3.16446 06	(0) -1.05207 99	(-1) -3.51185 70	(-3) -2.63083 59	(-1) 2.05299 00
-0.4	(0) -2.44543 68	(-1) -6.93277 09	(-1) -1.12388 92	(-1) +1.76203 27	(-1) 3.48181 61
-0.3	(0) -1.67144 46	(-1) -3.09520 29	(-1) +1.41630 28	(-1) 3.65553 75	(-1) 4.98858 44
-0.2	(-1) -8.40541 00	(-1) +1.00033 57	(-1) 4.11364 25	(-1) 5.65746 78	(-1) 6.57561 66
-0.1	(-2) +4.92624 47	(-1) 5.36246 53	(-1) 6.97316 13	(-1) 7.77115 48	(-1) 8.24528 23
0.0	(0) 1.00000 00	(0) 1.00000 00	(0) 1.00000 00	(0) 1.00000 00	(0) 1.00000 00
0.1	(0) 2.01375 27	(0) 1.49219 50	(0) 1.31994 11	(0) 1.23474 77	(0) 1.18422 38
0.2	(0) 3.09264 92	(0) 2.01375 27	(0) 1.65767 60	(0) 1.48171 31	(0) 1.37745 14
0.3	(0) 4.23886 64	(0) 2.56561 44	(0) 2.01375 27	(0) 1.74125 83	(0) 1.57993 98
0.4	(0) 5.45463 06	(0) 3.14874 21	(0) 2.38873 10	(0) 2.01375 27	(0) 1.79195 11
0.5	(0) 6.74221 79	(0) 3.76411 90	(0) 2.78318 26	(0) 2.29957 36	(0) 2.01375 27
0.6	(0) 8.10395 56	(0) 4.41274 94	(0) 3.19769 12	(0) 2.59910 58	(0) 2.24561 74
0.7	(0) 9.54222 25	(0) 5.09565 95	(0) 3.63285 27	(0) 2.91274 21	(0) 2.48782 35
0.8	(1) 1.10594 50	(0) 5.81389 76	(0) 4.08927 57	(0) 3.24088 34	(0) 2.74065 46
0.9	(1) 1.26581 24	(0) 6.56853 43	(0) 4.56758 14	(0) 3.58393 85	(0) 3.00440 00
1.0	(1) 1.43407 83	(0) 7.36066 31	(0) 5.06840 38	(0) 3.94232 46	(0) 3.27935 49

$a \setminus b$	0.6	0.7	0.8	0.9	1.0
-1.0	(-1) -1.66666 67	0.00000 00	(-1) 1.25000 00	(-1) 2.22222 22	(-1) 3.00000 00
-0.9	(-2) -7.54915 03	(-2) 7.95165 75	(-1) 1.95634 74	(-1) 2.85846 10	(-1) 3.57936 92
-0.8	(-2) +2.09154 67	(-1) 1.63250 20	(-1) 2.69751 66	(-1) 3.52400 18	(-1) 4.18377 43
-0.7	(-1) 1.22710 86	(-1) 2.51322 11	(-1) 3.47447 03	(-1) 4.21962 49	(-1) 4.81385 81
-0.6	(-1) 2.30054 51	(-1) 3.43855 96	(-1) 4.28819 01	(-1) 4.94612 53	(-1) 5.47027 56
-0.5	(-1) 3.43109 52	(-1) 4.40977 87	(-1) 5.13967 66	(-1) 5.70431 32	(-1) 6.15369 36
-0.4	(-1) 4.62042 36	(-1) 5.42816 47	(-1) 6.02994 98	(-1) 6.49501 40	(-1) 6.86479 13
-0.3	(-1) 5.87022 82	(-1) 6.49502 91	(-1) 6.96004 90	(-1) 7.31906 85	(-1) 7.60426 03
-0.2	(-1) 7.18224 16	(-1) 7.61170 97	(-1) 7.93103 40	(-1) 8.17733 33	(-1) 8.37280 46
-0.1	(-1) 8.55823 13	(-1) 8.77956 99	(-1) 8.94398 42	(-1) 9.07068 09	(-1) 9.17114 12
0.0	(0) 1.00000 00	(0) 1.00000 00	(0) 1.00000 00	(0) 1.00000 00	(0) 1.00000 00
0.1	(0) 1.15093 86	(0) 1.12744 17	(0) 1.11002 02	(0) 1.09661 96	(0) 1.08601 24
0.2	(0) 1.30882 66	(0) 1.26042 67	(0) 1.22457 33	(0) 1.19701 89	(0) 1.17522 70
0.3	(0) 1.47385 50	(0) 1.39910 20	(0) 1.34377 57	(0) 1.30129 20	(0) 1.26772 07
0.4	(0) 1.64621 90	(0) 1.54361 79	(0) 1.46774 58	(0) 1.40953 43	(0) 1.36357 19
0.5	(0) 1.82611 74	(0) 1.69412 73	(0) 1.59660 44	(0) 1.52184 32	(0) 1.46286 04
0.6	(0) 2.01375 27	(0) 1.85078 59	(0) 1.73047 46	(0) 1.63831 77	(0) 1.56566 72
0.7	(0) 2.20933 17	(0) 2.01375 27	(0) 1.86948 15	(0) 1.75905 87	(0) 1.67207 52
0.8	(0) 2.41306 50	(0) 2.18318 94	(0) 2.01375 27	(0) 1.88416 89	(0) 1.78216 81
0.9	(0) 2.62516 74	(0) 2.35926 09	(0) 2.16341 82	(0) 2.01375 27	(0) 1.89603 16
1.0	(0) 2.84585 75	(0) 2.54213 50	(0) 2.31861 02	(0) 2.14791 66	(0) 2.01375 27

CONFLUENT HYPERGEOMETRIC FUNCTION $M(a, b, x)$

Table 13.1

$x=0.8$

$a \setminus b$	0.1	0.2	0.3	0.4	0.5
-1.0	(0) -7.00000 00	(0) -3.00000 00	(0) -1.66666 67	(0) -1.00000 00	(-1) -6.00000 00
-0.9	(0) -6.50401 48	(0) -2.73837 67	(0) -1.48461 68	(-1) -8.58588 03	(-1) -4.83512 37
-0.8	(0) -5.94785 78	(0) -2.44921 23	(0) -1.28563 99	(-1) -7.05401 18	(-1) -3.58242 29
-0.7	(0) -5.32888 96	(0) -2.13135 83	(0) -1.06906 32	(-1) -5.39992 81	(-1) -2.23871 07
-0.6	(0) -4.64439 77	(0) -1.78363 55	(-1) -8.34197 05	(-1) -3.61905 04	(-2) -8.00722 55
-0.5	(0) -3.89159 56	(0) -1.40483 36	(-1) -5.80333 58	(-1) -1.70668 54	(-2) +7.34885 63
-0.4	(0) -3.06762 06	(-1) -9.93710 17	(-1) -3.06747 02	(-2) +3.41976 74	(-1) 2.37153 85
-0.3	(0) -2.16953 29	(-1) -5.48990 22	(-2) -1.26930 95	(-1) 2.53186 47	(-1) 4.11274 30
-0.2	(0) -1.19431 35	(-2) -6.93656 36	(-1) +3.02591 28	(-1) 4.86802 83	(-1) 5.96208 97
-0.1	(-1) -1.38863 05	(-1) +4.46505 60	(-1) 6.39888 38	(-1) 7.35564 06	(-1) 7.92325 45
0.0	(0) +1.00000 00	(0) 1.00000 00	(0) 1.00000 00	(0) 1.00000 00	(0) 1.00000 00
0.1	(0) 2.22554 09	(0) 1.59252 93	(0) 1.38374 79	(0) 1.28065 33	(0) 1.21961 77
0.2	(0) 3.54111 04	(0) 2.22554 09	(0) 1.79197 39	(0) 1.57807 97	(0) 1.45157 28
0.3	(0) 4.95014 63	(0) 2.90051 91	(0) 2.22554 09	(0) 1.89284 81	(0) 1.69626 83
0.4	(0) 6.45617 50	(0) 3.61898 52	(0) 2.68533 25	(0) 2.22554 09	(0) 1.95411 70
0.5	(0) 8.06281 37	(0) 4.38249 84	(0) 3.17225 39	(0) 2.57675 45	(0) 2.22554 09
0.6	(0) 9.77377 18	(0) 5.19265 68	(0) 3.68723 21	(0) 2.94709 89	(0) 2.51097 18
0.7	(1) 1.15928 53	(0) 6.05109 78	(0) 4.23121 63	(0) 3.33719 88	(0) 2.81085 12
0.8	(1) 1.35239 56	(0) 6.95949 89	(0) 4.80517 86	(0) 3.74769 30	(0) 3.12563 06
0.9	(1) 1.55710 78	(0) 7.91957 87	(0) 5.41011 38	(0) 4.17923 55	(0) 3.45577 20
1.0	(1) 1.77383 16	(0) 8.93309 73	(0) 6.04704 06	(0) 4.63249 51	(0) 3.80174 73

$a \setminus b$	0.6	0.7	0.8	0.9	1.0
-1.0	(-1) -3.33333 33	(-1) -1.42857 14	0.00000 00	(-1) 1.11111 11	(-1) 2.00000 00
-0.9	(-1) -2.33826 62	(-2) -5.57356 94	(-2) 7.76467 88	(-1) 1.81250 42	(-1) 2.64028 04
-0.8	(-1) -1.27465 48	(-2) +3.69102 15	(-1) 1.59854 95	(-1) 2.55227 74	(-1) 3.31335 07
-0.7	(-2) -1.40115 64	(-1) 1.35264 99	(-1) 2.46770 86	(-1) 3.33161 66	(-1) 4.02018 75
-0.6	(-1) +1.06779 15	(-1) 2.39517 31	(-1) 3.38544 19	(-1) 4.15173 34	(-1) 4.76178 82
-0.5	(-1) 2.35156 45	(-1) 3.49860 15	(-1) 4.35327 95	(-1) 5.01386 60	(-1) 5.53917 14
-0.4	(-1) 3.71375 95	(-1) 4.66490 92	(-1) 5.37278 55	(-1) 5.91927 92	(-1) 6.35337 71
-0.3	(-1) 5.15699 27	(-1) 5.89611 50	(-1) 6.44555 87	(-1) 6.86926 51	(-1) 7.20546 73
-0.2	(-1) 6.68394 10	(-1) 7.19428 36	(-1) 7.57323 29	(-1) 7.86514 37	(-1) 8.09652 62
-0.1	(-1) 8.29734 28	(-1) 8.56152 59	(-1) 8.75747 79	(-1) 8.90826 31	(-1) 9.02766 05
0.0	(0) 1.00000 00	(0) 1.00000 00	(0) 1.00000 00	(0) 1.00000 00	(0) 1.00000 00
0.1	(0) 1.17947 78	(0) 1.15119 12	(0) 1.13025 42	(0) 1.11417 60	(0) 1.10146 98
0.2	(0) 1.36846 08	(0) 1.30995 18	(0) 1.26668 86	(0) 1.23349 80	(0) 1.20729 30
0.3	(0) 1.56724 87	(0) 1.47651 22	(0) 1.40948 49	(0) 1.35811 24	(0) 1.31758 99
0.4	(0) 1.77614 79	(0) 1.65110 80	(0) 1.55882 92	(0) 1.48816 89	(0) 1.43248 29
0.5	(0) 1.99547 19	(0) 1.83397 98	(0) 1.71491 10	(0) 1.62382 02	(0) 1.55209 71
0.6	(0) 2.22554 09	(0) 2.02537 37	(0) 1.87792 43	(0) 1.76522 23	(0) 1.67656 00
0.7	(0) 2.46668 24	(0) 2.22554 09	(0) 2.04806 69	(0) 1.91253 43	(0) 1.80600 17
0.8	(0) 2.71923 11	(0) 2.43473 81	(0) 2.22554 09	(0) 2.06591 86	(0) 1.94055 51
0.9	(0) 2.98352 90	(0) 2.65322 74	(0) 2.41055 26	(0) 2.22554 09	(0) 2.08035 55
1.0	(0) 3.25992 56	(0) 2.88127 68	(0) 2.60331 27	(0) 2.39157 03	(0) 2.22554 09

Table 13.1 CONFLUENT HYPERGEOMETRIC FUNCTION $M(a, b, x)$

		$x=0.9$				
$a \backslash b$		0.1	0.2	0.3	0.4	0.5
-1.0	(0)	-8.00000 00	(0) -3.50000 00	(0) -2.00000 00	(0) -1.25000 00	(-1) -8.00000 00
-0.9	(0)	-7.49259 77	(0) -3.22852 60	(0) -1.80907 26	(0) -1.10046 05	(-1) -6.76001 98
-0.8	(0)	-6.90878 25	(0) -2.92208 06	(0) -1.59665 35	(-1) -9.35972 27	(-1) -5.40855 15
-0.7	(0)	-6.24470 96	(0) -2.57899 21	(0) -1.36176 43	(-1) -7.55885 89	(-1) -3.94096 49
-0.6	(0)	-5.49641 35	(0) -2.19753 81	(0) -1.10339 79	(-1) -5.59533 56	(-1) -2.35250 18
-0.5	(0)	-4.65980 55	(0) -1.77594 43	(-1) -8.20518 02	(-1) -3.46228 53	(-2) -6.38272 88
-0.4	(0)	-3.73067 11	(0) -1.31238 34	(-1) -5.12058 10	(-1) -1.15264 70	(-1) +1.20674 49
-0.3	(0)	-2.70466 65	(-1) -8.04973 88	(-1) -1.76920 97	(-1) +1.34083 75	(-1) 3.18771 09
-0.2	(0)	-1.57731 62	(-1) -2.51778 79	(-1) +1.86021 91	(-1) 4.02562 81	(-1) 5.30992 39
-0.1	(-1)	-3.44010 11	(-1) +3.49195 37	(-1) 5.77931 14	(-1) 6.90939 03	(-1) 7.57882 50
0.0	(0)	+1.00000 00	(0) 1.00000 00	(0) 1.00000 00	(0) 1.00000 00	(0) 1.00000 00
0.1	(0)	2.45960 31	(0) 1.70274 56	(0) 1.45345 52	(0) 1.33055 47	(0) 1.25791 83
0.2	(0)	4.03983 23	(0) 2.45960 31	(0) 1.93955 77	(0) 1.68343 42	(0) 1.53222 60
0.3	(0)	5.74586 78	(0) 3.27280 52	(0) 2.45960 31	(0) 2.05949 16	(0) 1.82352 69
0.4	(0)	7.58304 06	(0) 4.14464 74	(0) 3.01492 28	(0) 2.45960 31	(0) 2.13244 07
0.5	(0)	9.55683 50	(0) 5.07749 00	(0) 3.60688 44	(0) 2.88466 81	(0) 2.45960 31
0.6	(1)	1.16728 93	(0) 6.07375 88	(0) 4.23689 27	(0) 3.33560 96	(0) 2.80566 62
0.7	(1)	1.39370 17	(0) 7.13594 69	(0) 4.90639 03	(0) 3.81337 52	(0) 3.17129 88
0.8	(1)	1.63551 72	(0) 8.26661 58	(0) 5.61685 85	(0) 4.31893 69	(0) 3.55718 66
0.9	(1)	1.89334 94	(0) 9.46839 74	(0) 6.36981 80	(0) 4.85329 20	(0) 3.96403 28
1.0	(1)	2.16782 87	(1) 1.07439 95	(0) 7.16683 00	(0) 5.41746 38	(0) 4.39255 83
$a \backslash b$		0.6	0.7	0.8	0.9	1.0
-1.0	(-1)	-5.00000 00	(-1) -2.85714 29	(-1) -1.25000 00	0.00000 00	(-1) 1.00000 00
-0.9	(-1)	-3.93506 44	(-1) -1.92058 43	(-2) -4.12148 81	(-2) 7.59274 35	(-1) 1.69504 02
-0.8	(-1)	-2.78312 29	(-2) -9.13906 92	(-2) +4.83592 97	(-1) 1.56725 54	(-1) 2.43169 00
-0.7	(-1)	-1.54071 44	(-2) +1.65565 38	(-1) 1.43934 85	(-1) 2.42566 24	(-1) 3.21136 46
-0.6	(-2)	-2.04284 74	(-1) 1.32057 89	(-1) 2.45729 51	(-1) 3.33625 68	(-1) 4.03551 32
-0.5	(-1)	+1.22981 53	(-1) 2.55395 12	(-1) 3.53966 52	(-1) 4.30084 39	(-1) 4.90562 01
-0.4	(-1)	2.76533 21	(-1) 3.86857 31	(-1) 4.68874 74	(-1) 5.32127 33	(-1) 5.82320 50
-0.3	(-1)	4.40611 09	(-1) 5.26740 93	(-1) 5.90688 76	(-1) 6.39943 94	(-1) 6.78982 39
-0.2	(-1)	6.15609 81	(-1) 6.75350 07	(-1) 7.19649 04	(-1) 7.53728 29	(-1) 7.80706 95
-0.1	(-1)	8.01934 30	(-1) 8.32996 53	(-1) 8.56001 96	(-1) 8.73679 14	(-1) 8.87657 20
0.0	(0)	1.00000 00	(0) 1.00000 00	(0) 1.00000 00	(0) 1.00000 00	(0) 1.00000 00
0.1	(0)	1.21023 31	(0) 1.17668 82	(0) 1.15190 18	(0) 1.13289 93	(0) 1.11790 61
0.2	(0)	1.43307 07	(0) 1.36339 71	(0) 1.31197 24	(0) 1.27259 03	(0) 1.24155 02
0.3	(0)	1.66896 10	(0) 1.56047 09	(0) 1.48048 31	(0) 1.41929 15	(0) 1.37111 10
0.4	(0)	1.91836 37	(0) 1.76826 25	(0) 1.65771 19	(0) 1.57322 64	(0) 1.50677 14
0.5	(0)	2.18175 01	(0) 1.98713 34	(0) 1.84394 34	(0) 1.73462 38	(0) 1.64871 85
0.6	(0)	2.45960 31	(0) 2.21745 38	(0) 2.03946 90	(0) 1.90371 79	(0) 1.79714 36
0.7	(0)	2.75241 80	(0) 2.45960 31	(0) 2.24458 71	(0) 2.08074 81	(0) 1.95224 22
0.8	(0)	3.06070 20	(0) 2.71396 99	(0) 2.45960 31	(0) 2.26595 96	(0) 2.11421 45
0.9	(0)	3.38497 53	(0) 2.98095 21	(0) 2.68482 96	(0) 2.45960 31	(0) 2.28326 51
1.0	(0)	3.72577 04	(0) 3.26095 72	(0) 2.92058 65	(0) 2.66193 52	(0) 2.45960 31

CONFLUENT HYPERGEOMETRIC FUNCTION $M(a, b, x)$

Table 13.1

$x=1.0$

$a \setminus b$	0.1	0.2	0.3	0.4	0.5
-1.0	(0) -9.00000 00	(0) -4.00000 00	(0) -2.33333 33	(0) -1.50000 00	(0) -1.00000 00
-0.9	(0) -8.49472 34	(0) -3.72474 63	(0) -2.13718 91	(0) -1.34483 48	(-1) -8.70327 28
-0.8	(0) -7.89481 34	(0) -3.40618 57	(0) -1.91443 23	(0) -1.17116 05	(-1) -7.26851 39
-0.7	(0) -7.19487 27	(0) -3.04197 32	(0) -1.66369 18	(-1) -9.78067 35	(-1) -5.68924 14
-0.6	(0) -6.38931 44	(0) -2.62968 42	(0) -1.38355 11	(-1) -7.64616 83	(-1) -3.95877 20
-0.5	(0) -5.47235 71	(0) -2.16681 22	(0) -1.07254 74	(-1) -5.29840 46	(-1) -2.07021 66
-0.4	(0) -4.43802 02	(0) -1.65076 69	(-1) -7.29170 37	(-1) -2.72739 30	(-3) -1.64753 21
-0.3	(0) -3.28011 86	(0) -1.07887 24	(-1) -3.51861 30	(-3) +7.71680 36	(-1) +2.20976 75
-0.2	(0) -1.99225 77	(-1) -4.48364 63	(-2) +6.09884 13	(-1) 3.12589 94	(-1) 4.61604 79
-0.1	(-1) -5.67828 07	(-1) +2.43610 69	(-1) 5.11038 28	(-1) 6.42974 92	(-1) 7.21012 79
0.0	(0) +1.00000 00	(0) 1.00000 00	(0) 1.00000 00	(0) 1.00000 00	(0) 1.00000 00
0.1	(0) 2.71828 18	(0) 1.82384 44	(0) 1.52963 87	(0) 1.38482 77	(0) 1.29938 93
0.2	(0) 4.59430 40	(0) 2.71828 18	(0) 2.10177 40	(0) 1.79865 55	(0) 1.62002 78
0.3	(0) 6.63559 00	(0) 3.68654 94	(0) 2.71828 18	(0) 2.24271 69	(0) 1.96278 70
0.4	(0) 8.84990 62	(0) 4.73198 60	(0) 3.38109 51	(0) 2.71828 18	(0) 2.32856 41
0.5	(1) 1.12452 68	(0) 5.85803 42	(0) 4.09220 54	(0) 3.22665 79	(0) 2.71828 18
0.6	(1) 1.38299 44	(0) 7.06824 32	(0) 4.85366 43	(0) 3.76919 11	(0) 3.13288 93
0.7	(1) 1.66124 65	(0) 8.36627 13	(0) 5.66758 48	(0) 4.34726 65	(0) 3.57336 26
0.8	(1) 1.96016 30	(0) 9.75588 81	(0) 6.53614 27	(0) 4.96230 95	(0) 4.04070 56
0.9	(1) 2.28065 08	(1) 1.12409 78	(0) 7.46157 79	(0) 5.61578 62	(0) 4.53595 02
1.0	(1) 2.62364 52	(1) 1.28255 41	(0) 8.44619 60	(0) 6.30920 50	(0) 5.06015 69

$a \setminus b$	0.6	0.7	0.8	0.9	1.0
-1.0	(-1) -6.66666 67	(-1) -4.28571 43	(-1) -2.50000 00	(-1) -1.11111 11	0.00000 00
-0.9	(-1) -5.54597 35	(-1) -3.29502 50	(-1) -1.60990 29	(-2) -3.01549 81	(-2) 7.43386 23
-0.8	(-1) -4.31756 71	(-1) -2.21753 45	(-2) -6.48146 54	(-2) +5.68299 01	(-1) 1.53827 23
-0.7	(-1) -2.97660 48	(-1) -1.04950 02	(-2) +3.88236 65	(-1) 1.50083 68	(-1) 2.38663 42
-0.6	(-1) -1.51809 81	(-2) +2.12929 76	(-1) 1.50229 88	(-1) 2.49853 18	(-1) 3.29050 15
-0.5	(-3) +6.30910 70	(-1) 1.57371 99	(-1) 2.69717 87	(-1) 3.56392 05	(-1) 4.25195 83
-0.4	(-1) 1.77225 36	(-1) 3.03694 92	(-1) 3.97610 35	(-1) 4.69960 88	(-1) 5.27314 45
-0.3	(-1) 3.61483 67	(-1) 4.60681 41	(-1) 5.34239 08	(-1) 5.90827 38	(-1) 6.35625 70
-0.2	(-1) 5.59644 73	(-1) 6.28763 08	(-1) 6.79945 04	(-1) 7.19266 55	(-1) 7.50355 07
-0.1	(-1) 7.72285 59	(-1) 8.08383 81	(-1) 8.35078 67	(-1) 8.55560 76	(-1) 8.71734 01
0.0	(0) 1.00000 00	(0) 1.00000 00	(0) 1.00000 00	(0) 1.00000 00	(0) 1.00000 00
0.1	(0) 1.24339 88	(0) 1.20408 08	(0) 1.17507 89	(0) 1.15288 20	(0) 1.13539 67
0.2	(0) 1.50311 03	(0) 1.42110 86	(0) 1.36069 55	(0) 1.31451 22	(0) 1.27817 41
0.3	(0) 1.77978 05	(0) 1.65157 89	(0) 1.55723 97	(0) 1.48520 44	(0) 1.42858 86
0.4	(0) 2.07407 40	(0) 1.89600 10	(0) 1.76511 25	(0) 1.66528 05	(0) 1.58690 33
0.5	(0) 2.38667 38	(0) 2.15489 81	(0) 1.98472 52	(0) 1.85507 07	(0) 1.75338 77
0.6	(0) 2.71828 18	(0) 2.42880 78	(0) 2.21650 01	(0) 2.05491 39	(0) 1.92831 84
0.7	(0) 3.06961 97	(0) 2.71828 18	(0) 2.46087 06	(0) 2.26515 76	(0) 2.11197 89
0.8	(0) 3.44142 89	(0) 3.02388 72	(0) 2.71828 18	(0) 2.48615 84	(0) 2.30465 98
0.9	(0) 3.83447 12	(0) 3.34620 59	(0) 2.98919 01	(0) 2.71828 18	(0) 2.50665 90
1.0	(0) 4.24952 89	(0) 3.68583 55	(0) 3.27406 39	(0) 2.96190 29	(0) 2.71828 18

Table 13.1

CONFLUENT HYPERGEOMETRIC FUNCTION $M(a, b, x)$ $x=2.0$

$a \setminus b$	0.1	0.2	0.3	0.4	0.5
-1.0	(1) -1.90000 00	(0) -9.00000 00	(0) -5.66666 67	(0) -4.00000 00	(0) -3.00000 00
-0.9	(1) -1.94803 05	(0) -9.11450 17	(0) -5.67351 46	(0) -3.96130 19	(0) -2.93919 07
-0.8	(1) -1.95774 57	(0) -9.05346 68	(0) -5.57239 85	(0) -3.84746 13	(0) -2.82231 32
-0.7	(1) -1.92363 39	(0) -8.79313 67	(0) -5.34952 69	(0) -3.64939 40	(0) -2.64293 64
-0.6	(1) -1.83976 09	(0) -8.30798 80	(0) -4.99011 57	(0) -3.35738 15	(0) -2.39419 32
-0.5	(1) -1.69974 68	(0) -7.57063 96	(0) -4.47833 69	(0) -2.96103 91	(0) -2.06875 95
-0.4	(1) -1.49674 24	(0) -6.55175 56	(0) -3.79726 52	(0) -2.44928 29	(0) -1.65883 14
-0.3	(1) -1.22340 44	(0) -5.21994 53	(0) -2.92882 34	(0) -1.81029 53	(0) -1.15610 27
-0.2	(0) -8.71869 85	(0) -3.54165 86	(0) -1.85372 46	(0) -1.03148 90	(-1) -5.51740 45
-0.1	(0) -4.33729 58	(0) -1.48107 68	(-1) -5.51412 64	(-2) -9.94703 39	(-1) +1.63639 81
0.0	(0) +1.00000 00	(0) +1.00000 00	(0) +1.00000 00	(0) +1.00000 00	(0) 1.00000 00
0.1	(0) 7.38905 61	(0) 3.94227 09	(0) 2.82379 65	(0) 2.28204 66	(0) 1.96790 63
0.2	(1) 1.49320 73	(0) 7.38905 61	(0) 4.94472 25	(0) 3.76272 10	(0) 3.07855 71
0.3	(1) 2.37378 96	(1) 1.13864 24	(0) 7.38905 61	(0) 5.45904 52	(0) 4.34381 17
0.4	(1) 3.39223 44	(1) 1.59833 25	(1) 1.01846 79	(0) 7.38905 61	(0) 5.77622 05
0.5	(1) 4.56085 43	(1) 2.12317 23	(1) 1.33611 54	(0) 9.57185 22	(0) 7.38905 61
0.6	(1) 5.89272 84	(1) 2.71867 46	(1) 1.69497 98	(1) 1.20276 42	(0) 9.19634 52
0.7	(1) 7.40173 79	(1) 3.39068 27	(1) 2.09837 67	(1) 1.47777 93	(1) 1.12129 02
0.8	(1) 9.10260 50	(1) 4.14538 60	(1) 2.54981 38	(1) 1.78448 86	(1) 1.34543 65
0.9	(2) 1.10109 32	(1) 4.98933 60	(1) 3.05299 98	(1) 2.12527 66	(1) 1.59372 26
1.0	(2) 1.31432 41	(1) 5.92946 26	(1) 3.61185 28	(1) 2.50266 00	(1) 1.86788 78

$a \setminus b$	0.6	0.7	0.8	0.9	1.0
-1.0	(0) -2.33333 33	(0) -1.85714 29	(0) -1.50000 00	(0) -1.22222 22	(0) -1.00000 00
-0.9	(0) -2.26126 09	(0) -1.77944 34	(0) -1.41981 77	(0) -1.14139 10	(-1) -9.19616 98
-0.8	(0) -2.14541 69	(0) -1.66645 90	(0) -1.31049 88	(0) -1.03604 27	(-1) -8.18288 30
-0.7	(0) -1.98102 67	(0) -1.51452 14	(0) -1.16915 08	(-1) -9.03849 17	(-1) -6.94107 82
-0.6	(0) -1.76300 12	(0) -1.31972 79	(-1) -9.92701 33	(-1) -7.42341 04	(-1) -5.45057 11
-0.5	(0) -1.48592 22	(0) -1.07793 00	(-1) -7.77889 97	(-1) -5.48901 84	(-1) -3.69000 42
-0.4	(0) -1.14402 63	(-1) -7.84722 05	(-1) -5.21259 33	(-1) -3.20761 19	(-1) -1.63679 56
-0.3	(-1) -7.31188 76	(-1) -4.35429 49	(-1) -2.19146 36	(-2) -5.49879 73	(-2) +7.32914 71
-0.2	(-1) -2.40906 72	(-2) -2.50963 14	(-1) +1.32327 01	(-1) +2.51516 76	(-1) 3.44431 99
-0.1	(-1) +3.33718 60	(-1) +4.51527 65	(-1) 5.37263 41	(-1) 6.02027 13	(-1) 6.52400 38
0.0	(0) 1.00000 00	(0) 1.00000 00	(0) 1.00000 00	(0) 1.00000 00	(0) 1.00000 00
0.1	(0) 1.76568 32	(0) 1.62619 96	(0) 1.52511 88	(0) 1.44908 29	(0) 1.39018 53
0.2	(0) 2.63896 63	(0) 2.33634 06	(0) 2.11745 72	(0) 1.95312 22	(0) 1.82606 83
0.3	(0) 3.62852 02	(0) 3.13698 76	(0) 2.78211 92	(0) 2.51617 15	(0) 2.31092 49
0.4	(0) 4.74350 99	(0) 4.03507 07	(0) 3.52448 69	(0) 3.14250 04	(0) 2.84820 19
0.5	(0) 5.99361 56	(0) 5.03790 12	(0) 4.35023 19	(0) 3.83660 34	(0) 3.44152 39
0.6	(0) 7.38905 61	(0) 6.15318 83	(0) 5.26532 81	(0) 4.60320 94	(0) 4.09470 06
0.7	(0) 8.94061 15	(0) 7.38905 61	(0) 6.27606 41	(0) 5.44729 15	(0) 4.81173 45
0.8	(1) 1.06596 48	(0) 8.75406 09	(0) 7.38905 61	(0) 6.37407 66	(0) 5.59682 82
0.9	(1) 1.25581 43	(1) 1.02572 10	(0) 8.61126 21	(0) 7.38905 61	(0) 6.45439 28
1.0	(1) 1.46487 09	(1) 1.19079 79	(0) 9.94999 53	(0) 8.49799 64	(0) 7.38905 61

CONFLUENT HYPERGEOMETRIC FUNCTION $M(a, b, x)$

Table 13.1

		$x=3.0$									
$a \setminus b$		0.1	0.2	0.3	0.4	0.5	0.6	0.7	0.8	0.9	1.0
-1.0	(1)	-2.90000 00	(1) -1.40000 00	(0) -9.00000 00	(0) -6.50000 00	(0) -5.00000 00	(0) -4.00000 00	(0) -3.00000 00	(0) -2.00000 00	(0) -1.00000 00	(0) 0.00000 00
-0.9	(1)	-3.33062 11	(1) -1.57397 85	(0) -9.93407 08	(0) -7.05978 63	(0) -5.35304 11	(0) -4.15304 11	(0) -3.00000 00	(0) -1.80000 00	(0) -0.60000 00	(0) 0.60000 00
-0.8	(1)	-3.67972 78	(1) -1.71028 23	(1) -1.06346 98	(0) -7.45607 06	(0) -5.58342 63	(0) -4.20000 00	(0) -2.90000 00	(0) -1.60000 00	(0) -0.30000 00	(0) 0.90000 00
-0.7	(1)	-3.92295 55	(1) -1.79849 94	(1) -1.10419 34	(0) -7.64967 21	(0) -5.66362 13	(0) -4.30000 00	(0) -3.00000 00	(0) -1.70000 00	(0) -0.40000 00	(0) 1.00000 00
-0.6	(1)	-4.03286 65	(1) -1.82694 57	(1) -1.10887 39	(0) -7.59691 35	(0) -5.56302 55	(0) -4.40000 00	(0) -3.10000 00	(0) -1.80000 00	(0) -0.50000 00	(0) 1.30000 00
-0.5	(1)	-3.97869 07	(1) -1.78256 05	(1) -1.07004 00	(0) -7.24926 51	(0) -5.24773 50	(0) -4.10000 00	(0) -2.80000 00	(0) -1.50000 00	(0) -0.20000 00	(0) 1.60000 00
-0.4	(1)	-3.72604 95	(1) -1.65079 47	(0) -9.79393 09	(0) -6.55296 82	(0) -4.68029 11	(0) -3.50000 00	(0) -2.20000 00	(0) -0.90000 00	(0) 0.40000 00	(0) 1.80000 00
-0.3	(1)	-3.23666 24	(1) -1.41549 22	(0) -8.27742 10	(0) -5.44863 43	(0) -3.81941 32	(0) -2.60000 00	(0) -1.30000 00	(0) 0.00000 00	(0) 0.70000 00	(0) 2.10000 00
-0.2	(1)	-2.46803 49	(1) -1.05876 41	(0) -6.04935 06	(0) -3.87082 13	(0) -2.61971 67	(0) -1.40000 00	(0) 0.10000 00	(0) 0.80000 00	(0) 1.50000 00	(0) 2.40000 00
-0.1	(1)	-1.37312 67	(0) -5.60854 66	(0) -2.99786 41	(0) -1.74758 43	(0) -1.03141 44	(0) 0.20000 00	(0) 0.90000 00	(0) 1.60000 00	(0) 2.30000 00	(0) 2.80000 00
0.0	(0)	+1.00000 00	(0) +1.00000 00	(0) +1.0000 00	(0) +1.00000 00	(0) +1.00000 00	(0) +1.00000 00	(0) +1.00000 00	(0) +1.00000 00	(0) +1.00000 00	(0) +1.00000 00
0.1	(1)	2.00855 37	(0) 9.47722 60	(0) 6.07912 54	(0) 4.45833 69	(0) 3.53408 59	(0) 2.60000 00	(0) 1.70000 00	(0) 0.80000 00	(0) 0.00000 00	(0) 0.20000 00
0.2	(1)	4.41540 99	(1) 2.00855 37	(1) 1.23871 81	(0) 8.72184 59	(0) 6.63580 90	(0) 4.80000 00	(0) 3.00000 00	(0) 1.50000 00	(0) 0.50000 00	(0) 0.00000 00
0.3	(1)	7.38953 06	(1) 3.31122 04	(1) 2.00855 37	(1) 1.38935 23	(1) 1.03759 15	(0) 0.50000 00	(0) 0.20000 00	(0) 0.00000 00	(0) 0.00000 00	(0) 0.00000 00
0.4	(2)	1.10064 09	(1) 4.88711 46	(1) 2.93502 26	(1) 2.00855 37	(1) 1.48313 21	(0) 0.80000 00	(0) 0.40000 00	(0) 0.10000 00	(0) 0.00000 00	(0) 0.00000 00
0.5	(2)	1.53485 39	(1) 6.77048 23	(1) 4.03729 70	(1) 2.74198 55	(1) 2.00855 37	(0) 1.00000 00	(0) 0.50000 00	(0) 0.20000 00	(0) 0.00000 00	(0) 0.00000 00
0.6	(2)	2.05059 14	(1) 8.99862 23	(1) 5.33622 57	(1) 3.60289 07	(1) 2.62290 97	(0) 1.20000 00	(0) 0.60000 00	(0) 0.30000 00	(0) 0.10000 00	(0) 0.00000 00
0.7	(2)	2.65765 56	(2) 1.16120 98	(1) 6.85444 79	(1) 4.60562 86	(1) 3.33600 27	(0) 1.50000 00	(0) 0.70000 00	(0) 0.30000 00	(0) 0.10000 00	(0) 0.00000 00
0.8	(2)	3.36670 66	(2) 1.46549 60	(1) 8.61651 37	(1) 5.76574 86	(1) 4.15843 31	(0) 1.80000 00	(0) 0.90000 00	(0) 0.40000 00	(0) 0.10000 00	(0) 0.00000 00
0.9	(2)	4.18932 19	(2) 1.81749 79	(2) 1.06490 11	(1) 7.10006 77	(1) 5.10165 02	(0) 2.00000 00	(0) 1.00000 00	(0) 0.50000 00	(0) 0.20000 00	(0) 0.00000 00
1.0	(2)	5.13805 80	(2) 2.22239 01	(2) 1.29806 99	(1) 8.62675 30	(1) 6.17800 67	(0) 2.30000 00	(0) 1.20000 00	(0) 0.60000 00	(0) 0.30000 00	(0) 0.00000 00

$a \setminus b$		0.6	0.7	0.8	0.9	1.0
-1.0	(0)	-4.00000 00	(0) -3.28571 43	(0) -2.75000 00	(0) -2.33333 33	(0) -2.00000 00
-0.9	(0)	-4.22698 22	(0) -3.43076 30	(0) -2.83937 20	(0) -2.38362 40	(0) -2.02218 41
-0.8	(0)	-4.35776 62	(0) -3.49795 59	(0) -2.86423 28	(0) -2.37946 93	(0) -1.99773 27
-0.7	(0)	-4.37205 21	(0) -3.47180 10	(0) -2.81244 38	(0) -2.31115 68	(0) -1.91873 96
-0.6	(0)	-4.24734 55	(0) -3.33517 91	(0) -2.67062 69	(0) -2.16800 92	(0) -1.77653 50
-0.5	(0)	-3.95879 09	(0) -3.06922 34	(0) -2.42407 50	(0) -1.93831 65	(0) -1.56163 15
-0.4	(0)	-3.47899 58	(0) -2.65319 12	(0) -2.05665 59	(0) -1.60926 29	(0) -1.26366 85
-0.3	(0)	-2.77784 38	(0) -2.06432 89	(0) -1.55071 23	(0) -1.16684 98	(-1) -8.71351 71
-0.2	(0)	-1.82229 72	(0) -1.27772 88	(-1) -8.86954 74	(-1) -5.95815 42	(-1) -3.72391 35
-0.1	(-1)	-5.76188 60	(-1) -2.66178 30	(-2) -4.43495 10	(-1) +1.20451 21	(-1) +2.46564 64
0.0	(0)	+1.00000 00	(0) +1.00000 00	(0) +1.00000 00	(0) 1.00000 00	(0) 1.00000 00
0.1	(0)	2.94937 02	(0) 2.55311 64	(0) 2.27097 84	(0) 2.06241 49	(0) 1.90360 36
0.2	(0)	5.31885 34	(0) 4.42829 20	(0) 3.79559 01	(0) 3.32891 38	(0) 2.97434 69
0.3	(0)	8.15947 04	(0) 6.66364 61	(0) 5.60309 84	(0) 4.82245 42	(0) 4.23056 48
0.4	(1)	1.15266 06	(0) 9.30049 38	(0) 7.72517 18	(0) 6.56784 35	(0) 5.69204 18
0.5	(1)	1.54802 96	(1) 1.23835 54	(1) 1.01960 38	(0) 8.59185 66	(0) 7.38010 13
0.6	(1)	2.00855 37	(1) 1.59611 70	(1) 1.30526 48	(1) 1.09233 58	(0) 9.31770 09
0.7	(1)	2.54126 00	(1) 2.00855 37	(1) 1.63348 43	(1) 1.35934 30	(1) 1.15295 31
0.8	(1)	3.15373 75	(1) 2.48129 50	(1) 2.00855 37	(1) 1.66355 12	(1) 1.40421 20
0.9	(1)	3.85417 22	(1) 3.02040 57	(1) 2.43509 06	(1) 2.00855 37	(1) 1.68839 43
1.0	(1)	4.65138 52	(1) 3.63241 26	(1) 2.91805 85	(1) 2.39820 88	(1) 2.00855 37

Table 13.1 CONFLUENT HYPERGEOMETRIC FUNCTION $M(a, b, x)$

		$x=4.0$									
$a \setminus b$		0.1	0.2	0.3	0.4	0.5	0.6	0.7	0.8	0.9	1.0
-1.0	(1)	-3.90000 00	(1)-1.90000 00	(1)-1.23333 33	(0)-9.00000 00	(0)-7.00000 00	(0)-5.66666 67	(0)-4.71428 57	(0)-4.00000 00	(0)-3.44444 44	(0)-3.00000 00
-0.9	(1)	-5.28985 40	(1)-2.48147 20	(1)-1.55982 88	(1)-1.10723 65	(0)-8.40761 69	(0)-6.66432 27	(0)-5.44175 41	(0)-4.54078 84	(0)-3.85159 75	(0)-3.30880 92
-0.8	(1)	-6.56662 17	(1)-3.00867 57	(1)-1.85166 07	(1)-1.28958 24	(0)-9.62460 70	(0)-7.50985 56	(0)-6.04428 51	(0)-4.97675 07	(0)-4.16932 54	(0)-3.54030 67
-0.7	(1)	-7.65252 34	(1)-3.44868 41	(1)-2.09004 11	(1)-1.43486 25	(1)-1.05661 02	(0)-8.14117 89	(0)-6.47484 53	(0)-5.27129 22	(0)-4.36854 34	(0)-3.67096 90
-0.6	(1)	-8.45540 43	(1)-3.76267 54	(1)-2.25292 22	(1)-1.52885 30	(1)-1.11333 79	(0)-8.48636 64	(0)-6.67916 15	(0)-5.38234 50	(0)-4.41593 73	(0)-3.67394 51
-0.5	(1)	-8.86704 80	(1)-3.90525 49	(1)-2.31462 88	(1)-1.55505 56	(1)-1.12123 61	(0)-8.46261 04	(0)-6.59496 95	(0)-5.26181 06	(0)-4.27354 17	(0)-3.51873 12
-0.4	(1)	-8.76134 25	(1)-3.82372 05	(1)-2.24546 12	(1)-1.49445 23	(1)-1.06719 99	(0)-7.97509 54	(0)-6.15120 28	(0)-4.85495 90	(0)-3.89828 45	(0)-3.17081 98
-0.3	(1)	-7.99228 75	(1)-3.45726 34	(1)-2.01126 30	(1)-1.32524 14	(0)-9.36252 11	(0)-6.91578 17	(0)-5.26711 67	(0)-4.09978 13	(0)-3.24149 77	(0)-2.59132 26
-0.2	(1)	-6.39183 19	(1)-2.73610 36	(1)-1.57295 45	(1)-1.02255 01	(0)-7.11353 67	(0)-5.16209 26	(0)-3.85134 51	(0)-2.92629 19	(0)-2.24839 06	(0)-1.73656 51
-0.1	(1)	-3.76752 93	(1)-1.58055 26	(0)-8.86027 55	(0)-5.58125 37	(0)-3.73199 87	(0)-2.57549 99	(0)-1.80088 43	(0)-1.25577 95	(-1)-8.57483 35	(-1)-5.57651 91
0.0	(0)	+1.00000 00	(0)+1.00000 00	(0)+1.00000 00	(0)+1.00000 00	(0)+1.00000 00	(0)+1.00000 00	(0)+1.00000 00	(0)+1.00000 00	(0)+1.00000 00	(0)+1.00000 00
0.1	(1)	5.45981 50	(1) 2.40818 08	(1) 1.44217 35	(0) 9.87867 71	(0) 7.32759 68	(0) 5.73952 56	(0) 4.68094 79	(0) 3.93968 87	(0) 3.40078 42	(0) 2.99716 17
0.2	(2)	1.25936 21	(1) 5.45981 50	(1) 3.20473 65	(1) 2.14598 18	(1) 1.55257 11	(1) 1.18390 73	(0) 9.38676 76	(0) 7.67325 59	(0) 6.43024 18	(0) 5.50132 78
0.3	(2)	2.18189 72	(1) 9.38520 09	(1) 5.45981 50	(1) 3.61972 65	(1) 2.59017 89	(1) 1.95174 11	(1) 1.52787 90	(1) 1.23229 94	(1) 1.01831 42	(0) 8.58729 05
0.4	(2)	3.34927 25	(2) 1.43304 83	(1) 8.28815 42	(1) 5.45981 50	(1) 3.87987 49	(1) 2.90181 11	(1) 2.25363 21	(1) 1.80245 87	(1) 1.47644 52	(1) 1.23377 53
0.5	(2)	4.80147 67	(2) 2.04591 31	(2) 1.17799 11	(1) 7.72277 23	(1) 5.45981 50	(1) 4.06117 30	(1) 3.13582 01	(1) 2.49282 52	(1) 2.02901 97	(1) 1.68439 84
0.6	(2)	6.58320 17	(2) 2.79535 32	(2) 1.60355 04	(2) 1.04714 53	(1) 7.37235 87	(1) 5.45981 50	(1) 4.19644 69	(1) 3.31999 64	(1) 2.68883 75	(1) 2.22065 21
0.7	(2)	8.74427 45	(2) 3.70166 95	(2) 2.11665 31	(2) 1.37755 99	(1) 9.66443 28	(1) 7.13090 76	(1) 5.45981 50	(1) 4.30227 62	(1) 3.46999 38	(1) 2.85359 16
0.8	(3)	1.13401 20	(2) 4.78740 93	(2) 2.72967 48	(2) 1.77124 33	(2) 1.23879 22	(1) 9.11107 21	(1) 6.95271 64	(1) 5.45981 50	(1) 4.38798 40	(1) 3.59535 37
0.9	(3)	1.44322 61	(2) 6.07756 33	(2) 3.45631 21	(2) 2.23672 99	(2) 1.56000 85	(2) 1.14406 67	(1) 8.70463 66	(1) 6.81475 87	(1) 5.45981 50	(1) 4.45924 13
1.0	(3)	1.80888 49	(2) 7.59977 67	(2) 4.31169 57	(2) 2.78343 47	(2) 1.93640 05	(2) 1.41640 95	(2) 1.07479 72	(1) 8.39140 83	(1) 6.70412 50	(1) 5.45981 50

CONFLUENT HYPERGEOMETRIC FUNCTION $M(a, b, x)$

Table 13.1

$x=5.0$

$a \setminus b$	0.1	0.2	0.3	0.4	0.5
-1.0	(1) -4.90000 00	(1) -2.40000 00	(1) -1.56666 67	(1) -1.15000 00	(0) -9.00000 00
-0.9	(1) -8.48135 46	(1) -3.90138 34	(1) -2.41382 36	(1) -1.69201 76	(1) -1.27235 43
-0.8	(2) -1.20177 53	(1) -5.37054 86	(1) -3.23511 34	(1) -2.21244 58	(1) -1.62630 91
-0.7	(2) -1.52985 90	(1) -6.71922 90	(1) -3.98065 33	(1) -2.67925 47	(1) -1.93973 31
-0.6	(2) -1.80596 42	(1) -7.83737 80	(1) -4.58862 62	(1) -3.05298 12	(1) -2.18551 10
-0.5	(2) -1.99749 08	(1) -8.58991 93	(1) -4.98353 39	(1) -3.28566 20	(1) -2.33084 19
-0.4	(2) -2.06475 40	(1) -8.81313 79	(1) -5.07426 08	(1) -3.31965 25	(1) -2.33646 31
-0.3	(2) -1.95997 71	(1) -8.31068 13	(1) -4.75193 11	(1) -3.08632 11	(1) -2.15579 45
-0.2	(2) -1.62617 59	(1) -6.84913 57	(1) -3.88754 12	(1) -2.50460 94	(1) -1.73399 46
-0.1	(1) -9.95925 89	(1) -4.15313 99	(1) -2.32934 93	(1) -1.47944 56	(1) -1.00692 28
0.0	(0) +1.00000 00	(0) +1.00000 00	(0) +1.00000 00	(0) +1.00000 00	(0) +1.00000 00
0.1	(2) 1.48413 16	(1) 6.28624 01	(1) 3.60663 62	(1) 2.36223 07	(1) 1.67304 26
0.2	(2) 3.53395 30	(2) 1.48413 16	(1) 8.42893 34	(1) 5.45552 50	(1) 3.81153 30
0.3	(2) 6.28371 74	(2) 2.62678 96	(2) 1.48413 16	(1) 9.55023 72	(1) 6.62935 70
0.4	(2) 9.87643 86	(2) 4.11434 26	(2) 2.31584 25	(2) 1.48413 16	(2) 1.02565 96
0.5	(3) 1.44760 74	(2) 6.01287 11	(2) 3.37396 77	(2) 2.15510 54	(2) 1.48413 16
0.6	(3) 2.02699 13	(2) 8.39773 11	(2) 4.69942 40	(2) 2.99320 90	(2) 2.05515 14
0.7	(3) 2.74711 92	(3) 1.13545 79	(2) 6.33864 72	(2) 4.02706 82	(2) 2.75772 43
0.8	(3) 3.63219 45	(3) 1.49804 92	(2) 8.34418 40	(2) 5.28902 72	(2) 3.61329 22
0.9	(3) 4.70961 17	(3) 1.93851 85	(3) 1.07753 37	(2) 6.81553 64	(2) 4.64598 46
1.0	(3) 6.01029 56	(3) 2.46923 43	(3) 1.36988 66	(2) 8.64757 36	(2) 5.88289 14

$a \setminus b$	0.6	0.7	0.8	0.9	1.0
-1.0	(0) -7.33333 33	(0) -6.14285 71	(0) -5.25000 00	(0) -4.55555 56	(0) -4.00000 00
-0.9	(1) -1.00125 62	(0) -8.13469 15	(0) -6.76712 82	(0) -5.73274 31	(0) -4.92670 46
-0.8	(1) -1.25327 68	(0) -9.98761 99	(0) -8.16187 54	(0) -6.80132 29	(0) -5.75641 51
-0.7	(1) -1.47334 02	(1) -1.15809 94	(0) -9.34109 21	(0) -7.68780 55	(0) -6.43011 23
-0.6	(1) -1.64188 17	(1) -1.27685 52	(1) -1.01924 14	(0) -8.30396 66	(0) -6.87726 99
-0.5	(1) -1.73534 19	(1) -1.33749 40	(1) -1.05817 04	(0) -8.54492 28	(0) -7.01437 97
-0.4	(1) -1.72563 11	(1) -1.31918 93	(1) -1.03502 42	(0) -8.28701 58	(0) -6.74333 16
-0.3	(1) -1.57953 99	(1) -1.19740 11	(0) -9.31162 41	(0) -7.38548 98	(0) -5.94963 73
-0.2	(1) -1.25808 94	(0) -9.43413 73	(0) -7.24837 36	(0) -5.67194 55	(0) -4.50048 61
-0.1	(0) -7.15818 24	(0) -5.23827 09	(0) -3.90821 47	(0) -2.95155 22	(0) -2.24261 78
0.0	(0) +1.00000 00	(0) +1.00000 00	(0) +1.00000 00	(0) +1.00000 00	(0) +1.00000 00
0.1	(1) 1.25021 43	(0) 9.72559 33	(0) 7.81074 40	(0) 6.43982 88	(0) 5.42870 50
0.2	(1) 2.80473 44	(1) 2.14485 95	(1) 1.69066 81	(1) 1.36614 90	(1) 1.12729 02
0.3	(1) 4.84355 66	(1) 3.67515 33	(1) 2.87239 67	(1) 2.29989 34	(1) 1.87930 66
0.4	(1) 7.45788 26	(1) 5.62973 09	(1) 4.37580 33	(1) 3.48308 09	(1) 2.82840 13
0.5	(2) 1.07513 41	(1) 8.08378 40	(1) 6.25698 73	(1) 4.95851 46	(1) 4.00784 46
0.6	(2) 1.48413 16	(2) 1.11223 46	(1) 8.57928 78	(1) 6.77444 40	(1) 5.45508 08
0.7	(2) 1.98603 96	(2) 1.48413 16	(2) 1.14140 27	(1) 8.98511 69	(1) 7.21214 61
0.8	(2) 2.59579 43	(2) 1.93485 65	(2) 1.48413 16	(2) 1.16513 78	(1) 9.32612 06
0.9	(2) 3.33018 07	(2) 2.47651 46	(2) 1.89509 28	(2) 1.48413 16	(2) 1.18496 18
1.0	(2) 4.20801 74	(2) 3.12265 96	(2) 2.38432 45	(2) 1.86309 66	(2) 1.48413 16

Table 13.1 CONFLUENT HYPERGEOMETRIC FUNCTION $M(a, b, x)$

		$x=6.0$									
$a \setminus b$		0.1	0.2	0.3	0.4	0.5	0.6	0.7	0.8	0.9	1.0
-1.0	(1)	-5.90000 00	(1)-2.90000 00	(1)-1.90000 00	(1)-1.40000 00	(1)-1.10000 00	(0)-9.00000 00	(0)-7.57142 86	(0)-6.50000 00	(0)-5.66666 67	(0)-5.00000 00
-0.9	(2)	-1.44132 92	(1)-6.43961 14	(1)-3.88390 81	(1)-2.66287 93	(1)-1.96459 57	(1)-1.52103 70	(1)-1.21887 04	(1)-1.00236 52	(0)-8.41150 68	(0)-7.17389 32
-0.8	(2)	-2.33128 14	(2)-1.01116 95	(1)-5.92627 62	(1)-3.95288 49	(1)-2.84081 83	(1)-2.14539 69	(1)-1.67928 88	(1)-1.35080 52	(1)-1.11025 64	(0)-9.28639 79
-0.7	(2)	-3.20791 31	(2)-1.37008 05	(1)-7.90656 11	(1)-5.19335 87	(1)-3.67618 94	(1)-2.73534 89	(1)-2.11028 68	(1)-1.67379 50	(1)-1.35713 62	(1)-1.12032 42
-0.6	(2)	-4.00174 16	(2)-1.69209 38	(1)-9.66592 36	(1)-6.28400 93	(1)-4.40252 67	(1)-3.24219 87	(1)-2.47582 00	(1)-1.94390 70	(1)-1.56045 26	(1)-1.27553 63
-0.5	(2)	-4.62243 63	(2)-1.94024 69	(2)-1.10002 61	(1)-7.09668 98	(1)-4.93318 77	(1)-3.60439 87	(1)-2.73056 65	(1)-2.12682 93	(1)-1.69364 40	(1)-1.37333 18
-0.4	(2)	-4.95505 80	(2)-2.06773 13	(2)-1.16523 15	(1)-7.47062 14	(1)-5.15995 73	(1)-3.74541 77	(1)-2.81841 55	(1)-2.18026 23	(1)-1.72410 15	(1)-1.38810 25
-0.3	(2)	-4.85579 61	(2)-2.01621 45	(2)-1.13027 51	(1)-7.20700 55	(1)-4.94954 27	(1)-3.57134 39	(1)-2.67076 84	(1)-2.05268 12	(1)-1.61224 68	(1)-1.28887 64
-0.2	(2)	-4.14715 07	(2)-1.71394 56	(1)-9.56011 20	(1)-6.06296 12	(1)-4.13963 47	(1)-2.96819 67	(1)-2.20463 65	(1)-1.68195 09	(1)-1.31050 12	(1)-1.03853 60
-0.1	(2)	-2.61250 17	(2)-1.07362 31	(1)-5.94951 89	(1)-3.74471 97	(1)-2.53449 16	(1)-1.79891 61	(1)-1.32051 32	(0)-9.93780 50	(0)-7.62137 49	(0)-5.92948 86
0.0	(0)	+1.00000 00	(0)+1.00000 00	(0)+1.00000 00	(0)+1.00000 00	(0)+1.00000 00	(0)+1.00000 00	(0)+1.00000 00	(0)+1.00000 00	(0)+1.00000 00	(0)+1.00000 00
0.1	(2)	4.03428 79	(2) 1.66280 07	(1) 9.26969 34	(1) 5.89051 37	(1) 4.04184 10	(1) 2.92224 67	(1) 2.19683 71	(1) 1.70335 65	(1) 1.35491 58	(1) 1.10148 13
0.2	(2)	9.83405 67	(2) 4.03428 79	(2) 2.23669 33	(2) 1.41226 82	(1) 9.61906 66	(1) 6.89588 66	(1) 5.13440 78	(1) 3.93817 92	(1) 3.09503 99	(1) 2.48291 09
0.3	(3)	1.78513 43	(2) 7.30095 48	(2) 4.03428 79	(2) 2.53795 01	(2) 1.72165 84	(2) 1.22879 89	(1) 9.10486 02	(1) 6.94664 31	(1) 5.42797 37	(1) 4.32726 56
0.4	(3)	2.86060 97	(3) 1.16700 13	(2) 6.43121 54	(2) 4.03428 79	(2) 2.72837 67	(2) 1.94097 77	(2) 1.43316 97	(2) 1.08938 21	(1) 8.47842 06	(1) 6.73053 68
0.5	(3)	4.27068 45	(3) 1.73835 48	(2) 9.55746 91	(2) 5.98067 12	(2) 4.03428 79	(2) 2.86223 27	(2) 2.10737 78	(2) 1.59705 69	(2) 1.23903 18	(1) 9.80333 40
0.6	(3)	6.08625 44	(3) 2.47231 35	(3) 1.35639 99	(2) 8.46913 69	(2) 5.69983 97	(2) 4.03428 79	(2) 2.96297 41	(2) 2.23967 22	(2) 1.73291 89	(2) 1.36726 52
0.7	(3)	8.38957 36	(3) 3.40149 55	(3) 1.86253 97	(3) 1.16059 73	(2) 7.79473 21	(2) 5.50517 98	(2) 4.03428 79	(2) 3.04245 98	(2) 2.34847 33	(2) 1.84838 13
0.8	(4)	1.12757 14	(3) 4.56354 65	(3) 2.49428 70	(3) 1.55134 92	(3) 1.03990 56	(2) 7.33002 58	(2) 5.36065 25	(2) 4.03428 79	(2) 3.10736 70	(2) 2.44026 08
0.9	(4)	1.48541 80	(3) 6.00176 64	(3) 3.27475 26	(3) 2.03319 84	(3) 1.36045 49	(2) 9.57187 15	(2) 6.98699 63	(2) 5.24808 61	(2) 4.03428 79	(2) 3.16176 35
1.0	(4)	1.92506 91	(3) 7.76580 14	(3) 4.23039 92	(3) 2.62218 79	(3) 1.75159 77	(3) 1.23026 21	(2) 8.96449 42	(2) 6.72131 30	(2) 5.15728 26	(2) 4.03428 79

CONFLUENT HYPERGEOMETRIC FUNCTION $M(a, b, x)$

Table 13.1

$x=7.0$

$a \setminus b$	0.1	0.2	0.3	0.4	0.5
-1.0	(1) -6.90000 00	(1) -3.40000 00	(1) -2.23333 33	(1) -1.65000 00	(1) -1.30000 00
-0.9	(2) -2.66288 80	(2) -1.15002 17	(1) -6.72111 28	(1) -4.47674 11	(1) -3.21693 87
-0.8	(2) -4.82834 55	(2) -2.03315 80	(2) -1.15809 32	(1) -7.51697 57	(1) -5.26450 27
-0.7	(2) -7.06530 95	(2) -2.93971 82	(2) -1.65375 76	(2) -1.05973 99	(1) -7.32517 82
-0.6	(2) -9.19980 13	(2) -3.79893 33	(2) -2.12025 19	(2) -1.34754 31	(1) -9.23583 79
-0.5	(3) -1.09929 51	(2) -4.51426 47	(2) -2.50491 09	(2) -1.58243 03	(2) -1.07780 84
-0.4	(3) -1.21270 91	(2) -4.95796 49	(2) -2.73838 73	(2) -1.72158 27	(2) -1.16671 10
-0.3	(3) -1.21896 61	(2) -4.96479 64	(2) -2.73134 11	(2) -1.71005 68	(2) -1.15389 05
-0.2	(3) -1.06546 71	(2) -4.32480 32	(2) -2.37063 77	(2) -1.47850 91	(1) -9.93558 67
-0.1	(2) -6.86139 84	(2) -2.77502 15	(2) -1.51499 28	(1) -9.40594 48	(1) -6.28867 03
0.0	(0) +1.00000 00	(0) +1.00000 00	(0) +1.00000 00	(0) +1.00000 00	(0) +1.00000 00
0.1	(3) 1.09663 32	(2) 4.42900 71	(2) 2.41753 11	(2) 1.50292 87	(2) 1.00798 98
0.2	(3) 2.72330 73	(3) 1.09663 32	(2) 5.96600 60	(2) 3.69501 44	(2) 2.46763 45
0.3	(3) 5.02903 83	(3) 2.02058 34	(3) 1.09663 32	(2) 6.77457 83	(2) 4.51182 31
0.4	(3) 8.19139 01	(3) 3.28466 83	(3) 1.77901 54	(3) 1.09663 32	(2) 7.28692 93
0.5	(4) 1.24220 89	(3) 4.97211 80	(3) 2.68791 51	(3) 1.65368 85	(3) 1.09663 32
0.6	(4) 1.79722 28	(3) 7.18148 47	(3) 3.87554 96	(3) 2.38009 49	(3) 1.57543 68
0.7	(4) 2.51381 30	(4) 1.00289 02	(3) 5.40336 15	(3) 3.31282 90	(3) 2.18907 73
0.8	(4) 3.42679 34	(4) 1.36506 23	(3) 7.34333 78	(3) 4.49515 29	(3) 2.96556 40
0.9	(4) 4.57689 88	(4) 1.82058 62	(3) 9.77948 66	(3) 5.97748 66	(3) 3.93749 79
1.0	(4) 6.01161 32	(4) 2.38799 82	(4) 1.28094 89	(3) 7.81838 27	(3) 5.14269 05

$a \setminus b$	0.6	0.7	0.8	0.9	1.0
-1.0	(1) -1.06666 67	(0) -9.00000 00	(0) -7.75000 00	(0) -6.77777 78	(0) -6.00000 00
-0.9	(1) -2.43203 85	(1) -1.90770 95	(1) -1.53927 06	(1) -1.27012 46	(1) -1.06732 11
-0.8	(1) -3.88035 55	(1) -2.96917 41	(1) -2.33863 78	(1) -1.88526 21	(1) -1.54912 65
-0.7	(1) -5.32790 43	(1) -4.02257 88	(1) -3.12617 60	(1) -2.48676 78	(1) -2.01662 21
-0.6	(1) -6.65941 15	(1) -4.98346 93	(1) -3.83826 01	(1) -3.02562 11	(1) -2.43133 06
-0.5	(1) -7.72147 28	(1) -5.74011 58	(1) -4.39120 14	(1) -3.43770 69	(1) -2.74320 50
-0.4	(1) -8.31498 75	(1) -6.14818 51	(1) -4.67738 87	(1) -3.64095 75	(1) -2.88847 09
-0.3	(1) -8.18647 83	(1) -6.02463 60	(1) -4.56087 46	(1) -3.53208 76	(1) -2.78716 65
-0.2	(1) -7.01816 36	(1) -5.14074 94	(1) -3.87234 20	(1) -2.98287 74	(1) -2.34034 55
-0.1	(1) -4.41663 81	(1) -3.21419 15	(1) -2.40338 13	(1) -1.83595 18	(1) -1.42690 55
0.0	(0) +1.00000 00	(0) +1.00000 00	(0) +1.00000 00	(0) +1.00000 00	(0) +1.00000 00
0.1	(1) 7.11674 98	(1) 5.21962 63	(1) 3.94472 08	(1) 3.05562 65	(1) 2.41701 00
0.2	(2) 1.73382 30	(2) 1.26468 67	(1) 9.49891 56	(1) 7.30700 42	(1) 5.73511 61
0.3	(2) 3.16073 31	(2) 2.29812 96	(2) 1.72012 72	(2) 1.31824 90	(2) 1.03047 87
0.4	(2) 5.09262 36	(2) 3.69345 22	(2) 2.75715 27	(2) 2.10704 18	(2) 1.64217 15
0.5	(2) 7.64800 47	(2) 5.53466 48	(2) 4.12222 44	(2) 3.14277 19	(2) 2.44332 54
0.6	(3) 1.09663 32	(2) 7.92047 08	(2) 5.88720 07	(2) 4.47895 79	(2) 3.47456 13
0.7	(3) 1.52109 75	(3) 1.09663 32	(2) 8.13601 69	(2) 6.17802 12	(2) 4.78318 84
0.8	(3) 2.05725 48	(3) 1.48067 73	(3) 1.09663 32	(2) 8.31248 87	(2) 6.42409 85
0.9	(3) 2.72726 12	(3) 1.95979 60	(3) 1.44913 63	(3) 1.09663 32	(2) 8.46076 16
1.0	(3) 3.55678 22	(3) 2.55205 62	(3) 1.88419 29	(3) 1.42364 54	(3) 1.09663 32

Table 13.1 CONFLUENT HYPERGEOMETRIC FUNCTION $M(a, b, x)$

		$x=8.0$									
$a \setminus b$		0.1	0.2	0.3	0.4	0.5	0.6	0.7	0.8	0.9	1.0
-1.0	(1)	-7.90000 00	(1) -3.90000 00	(1) -2.56666 67	(1) -1.90000 00	(1) -1.50000 00	(1) -1.23333 33	(1) -1.04285 71	(0) -9.00000 00	(0) -7.88888 89	(0) -7.00000 00
-0.9	(2)	-5.35947 58	(2) -2.23970 82	(2) -1.26764 73	(1) -8.18608 14	(1) -5.71092 02	(1) -4.19816 11	(1) -3.20746 94	(1) -2.52522 99	(1) -2.03685 45	(1) -1.67621 46
-0.8	(3)	-1.05913 37	(2) -4.34517 66	(2) -2.41159 61	(2) -1.52562 18	(2) -1.04182 83	(1) -7.49216 65	(1) -5.59749 62	(1) -4.30847 38	(1) -3.39751 08	(1) -2.73380 70
-0.7	(3)	-1.62135 82	(2) -6.59589 37	(2) -3.62791 31	(2) -2.27325 01	(2) -1.53682 58	(2) -1.09361 95	(1) -8.08183 59	(1) -6.15107 90	(1) -4.79493 78	(1) -3.81325 44
-0.6	(3)	-2.18025 86	(2) -8.82153 60	(2) -4.82414 97	(2) -3.00441 34	(2) -2.01811 79	(2) -1.42648 08	(2) -1.04680 37	(1) -7.90952 94	(1) -6.11965 64	(1) -4.82945 42
-0.5	(3)	-2.67429 61	(3) -1.07763 74	(2) -5.86783 06	(2) -3.63786 60	(2) -2.43202 00	(2) -1.71051 24	(2) -1.24874 83	(1) -9.38477 69	(1) -7.22077 10	(1) -5.66582 71
-0.4	(3)	-3.01799 53	(3) -1.21208 08	(2) -6.57678 93	(2) -4.06244 15	(2) -2.70544 00	(2) -1.89519 44	(2) -1.37780 10	(2) -1.03097 46	(1) -7.89678 13	(1) -6.16743 32
-0.3	(3)	-3.09632 67	(3) -1.23996 24	(2) -6.70780 36	(2) -4.13029 89	(2) -2.74155 31	(2) -1.91386 58	(2) -1.38635 99	(2) -1.03347 63	(1) -7.88488 72	(1) -6.13297 12
-0.2	(3)	-2.75810 97	(3) -1.10164 91	(2) -5.94329 13	(2) -3.64902 75	(2) -2.41475 59	(2) -1.68033 35	(2) -1.21307 63	(1) -9.01063 22	(1) -6.84858 28	(1) -5.30551 30
-0.1	(3)	-1.80829 89	(2) -7.20419 31	(2) -3.87580 16	(2) -2.37245 74	(2) -1.56480 05	(2) -1.08493 76	(1) -7.80116 43	(1) -5.76904 74	(1) -4.36332 11	(1) -3.36181 13
0.0	(0)	+1.00000 00	(0) +1.00000 00	(0) +1.00000 00	(0) +1.00000 00	(0) +1.00000 00	0.0	0.0	0.0	0.0	0.0
0.1	(3)	2.98095 80	(3) 1.18444 63	(2) 6.35818 11	(2) 3.88567 25	(2) 2.56061 41	0.1	(2) 1.77542 34	(1) 9.47420 10	(1) 7.19400 22	(1) 5.57451 38
0.2	(3)	7.51808 32	(3) 2.98095 80	(3) 1.59656 00	(2) 9.73282 54	(2) 6.39631 86	0.2	(2) 4.42157 41	(2) 2.34287 19	(2) 1.77165 46	(2) 1.36651 86
0.3	(4)	1.40881 29	(3) 5.57611 41	(3) 2.98095 80	(3) 1.81369 75	(3) 1.18950 58	0.3	(2) 8.20490 47	(2) 4.32702 55	(2) 3.26355 40	(2) 2.51027 48
0.4	(4)	2.32720 88	(3) 9.19616 72	(3) 4.90796 57	(3) 2.98095 80	(3) 1.95153 01	0.4	(3) 1.34359 84	(2) 7.05759 09	(2) 5.31172 06	(2) 4.07661 58
0.5	(4)	3.57745 28	(4) 1.41150 69	(3) 7.52139 08	(3) 4.56094 12	(3) 2.98095 80	0.5	(3) 2.04885 12	(3) 1.07237 41	(2) 8.05582 19	(2) 6.17064 03
0.6	(4)	5.24445 76	(4) 2.06625 00	(4) 1.09940 42	(3) 6.65669 18	(3) 4.34399 08	0.6	(3) 2.98095 80	(3) 1.55511 32	(3) 1.16622 16	(2) 8.91734 62
0.7	(4)	7.42998 57	(4) 2.92330 17	(4) 1.55324 53	(3) 9.39119 38	(3) 6.11953 13	0.7	(3) 4.19313 16	(3) 2.18075 96	(3) 1.63280 79	(3) 1.24646 81
0.8	(5)	1.02553 76	(4) 4.02964 70	(4) 2.13822 46	(4) 1.29105 19	(3) 8.40117 14	0.8	(3) 5.74840 89	(3) 2.98095 80	(3) 2.22860 68	(3) 1.69869 84
0.9	(5)	1.38646 40	(4) 5.44098 22	(4) 2.88342 27	(4) 1.73873 91	(4) 1.12994 43	0.9	(3) 7.72114 36	(3) 3.99294 06	(3) 2.98095 80	(3) 2.26888 68
1.0	(5)	1.84279 80	(4) 7.22305 38	(4) 3.82312 68	(4) 2.30252 22	(4) 1.49443 61	1.0	(4) 1.01986 91	(3) 7.22067 87	(3) 5.26034 65	(3) 2.98095 80

CONFLUENT HYPERGEOMETRIC FUNCTION $M(a, b, x)$

Table 13.1

$x=9.0$

$a \setminus b$	0.1	0.2	0.3	0.4	0.5
-1.0	(1) -8.90000 00	(1) -4.40000 00	(1) -2.90000 00	(1) -2.15000 00	(1) -1.70000 00
-0.9	(3) -1.15822 92	(2) -4.70696 01	(2) -2.58988 67	(2) -1.62573 25	(2) -1.10263 21
-0.8	(3) -2.42781 38	(2) -9.74816 44	(2) -5.29323 09	(2) -3.27532 02	(2) -2.18739 83
-0.7	(3) -3.83823 48	(3) -1.53240 98	(2) -8.26992 61	(2) -5.08337 71	(2) -3.37079 66
-0.6	(3) -5.28795 76	(3) -2.10310 78	(3) -1.13032 66	(2) -6.91755 27	(2) -4.56573 11
-0.5	(3) -6.62068 16	(3) -2.62521 11	(3) -1.40643 82	(2) -8.57840 43	(2) -5.64186 81
-0.4	(3) -7.60990 61	(3) -3.00975 26	(3) -1.60814 10	(2) -9.78118 66	(2) -6.41404 87
-0.3	(3) -7.94036 79	(3) -3.13336 92	(3) -1.67025 41	(3) -1.01340 64	(2) -6.62844 84
-0.2	(3) -7.18584 92	(3) -2.82979 30	(3) -1.50519 87	(2) -9.11218 60	(2) -5.94613 42
-0.1	(3) -4.78278 15	(3) -1.87974 72	(2) -9.97775 31	(2) -6.02698 67	(2) -3.92362 38
0.0	(0) +1.00000 00	(0) +1.00000 00	(0) +1.00000 00	(0) +1.00000 00	(0) +1.00000 00
0.1	(3) 8.10308 39	(3) 3.17569 47	(3) 1.68114 27	(3) 1.01296 25	(2) 6.57992 17
0.2	(4) 2.07097 19	(3) 8.10308 39	(3) 4.28218 60	(3) 2.57548 14	(3) 1.66969 39
0.3	(4) 3.93063 86	(4) 1.53566 77	(3) 8.10308 39	(3) 4.86584 85	(3) 3.14939 48
0.4	(4) 6.57367 60	(4) 2.56471 76	(4) 1.35137 30	(3) 8.10308 39	(3) 5.23683 11
0.5	(5) 1.02271 23	(4) 3.98485 11	(4) 2.09683 16	(4) 1.25557 31	(3) 8.10308 39
0.6	(5) 1.51686 28	(4) 5.90279 86	(4) 3.10207 78	(4) 1.85508 62	(4) 1.19562 36
0.7	(5) 2.17356 27	(4) 8.44810 69	(4) 4.43426 09	(4) 2.64844 50	(4) 1.70478 81
0.8	(5) 3.03359 16	(5) 1.17771 47	(4) 6.17433 59	(4) 3.68332 96	(4) 2.36805 96
0.9	(5) 4.14598 16	(5) 1.60777 16	(4) 8.41941 52	(4) 5.01687 01	(4) 3.22165 07
1.0	(5) 5.56941 19	(5) 2.15743 14	(5) 1.12854 63	(4) 6.71721 10	(4) 4.30870 75

$a \setminus b$	0.6	0.7	0.8	0.9	1.0
-1.0	(1) -1.40000 00	(1) -1.18571 43	(1) -1.02500 00	(0) -9.00000 00	(0) -8.00000 00
-0.9	(1) -7.88310 88	(1) -5.86101 35	(1) -4.49394 10	(1) -3.53363 88	(1) -2.83797 81
-0.8	(2) -1.53831 87	(2) -1.12401 55	(1) -8.46300 77	(1) -6.53007 44	(1) -5.14354 17
-0.7	(2) -2.35259 85	(2) -1.70516 69	(2) -1.27296 76	(1) -9.73476 07	(1) -7.59652 04
-0.6	(2) -3.17089 67	(2) -2.28631 95	(2) -1.69747 84	(2) -1.29066 47	(2) -1.00113 60
-0.5	(2) -3.90366 91	(2) -2.80365 84	(2) -2.07304 42	(2) -1.56947 14	(2) -1.21196 37
-0.4	(2) -4.42433 15	(2) -3.16741 38	(2) -2.33416 78	(2) -1.76099 80	(2) -1.35492 40
-0.3	(2) -4.56001 78	(2) -3.25546 25	(2) -2.39208 63	(2) -1.79922 96	(2) -1.37997 11
-0.2	(2) -4.08061 95	(2) -2.90574 94	(2) -2.12938 18	(2) -1.59711 34	(2) -1.22131 75
-0.1	(2) -2.68584 35	(2) -1.90735 35	(2) -1.39363 74	(2) -1.04195 05	(1) -7.94021 75
0.0	(0) +1.00000 00	(0) +1.00000 00	(0) +1.00000 00	(0) +1.00000 00	(0) +1.00000 00
0.1	(2) 4.49581 13	(2) 3.18820 43	(2) 2.32750 60	(2) 1.73981 39	(2) 1.32662 16
0.2	(3) 1.13844 85	(2) 8.05506 28	(2) 5.86608 76	(2) 4.37321 78	(2) 3.32490 16
0.3	(3) 2.14370 76	(3) 1.51408 89	(3) 1.10059 12	(2) 8.18906 59	(2) 6.21332 82
0.4	(3) 3.55908 19	(3) 2.50977 29	(3) 1.82136 70	(3) 1.35291 34	(3) 1.02470 26
0.5	(3) 5.49915 09	(3) 3.87215 54	(3) 2.80582 25	(3) 2.08094 05	(3) 1.57360 49
0.6	(3) 8.10308 39	(3) 5.69778 22	(3) 4.12286 14	(3) 3.05330 38	(3) 2.30549 09
0.7	(4) 1.15389 32	(3) 8.10308 39	(3) 5.85547 03	(3) 4.33052 37	(3) 3.26534 78
0.8	(4) 1.60085 54	(4) 1.12277 41	(3) 8.10308 39	(3) 5.98502 62	(3) 4.50694 55
0.9	(4) 2.17532 51	(4) 1.52385 32	(4) 1.09842 88	(3) 8.10308 39	(3) 6.09425 86
1.0	(4) 2.90602 06	(4) 2.03337 24	(4) 1.46399 00	(4) 1.07870 28	(3) 8.10308 39

Table 13.1 CONFLUENT HYPERGEOMETRIC FUNCTION $M(a, b, x)$

		$x=10.0$													
$a \setminus b$		0.1		0.2		0.3		0.4		0.5					
-1.0	(1)	-9.90000	00	(1)	-4.90000	00	(1)	-3.23333	33	(1)	-2.40000	00	(1)	-1.90000	00
-0.9	(3)	-2.63572	95	(3)	-1.04774	98	(2)	-5.63504	48	(2)	-3.45535	97	(2)	-2.28812	39
-0.8	(3)	-5.74321	45	(3)	-2.26606	51	(3)	-1.20865	20	(2)	-7.34339	26	(2)	-4.81371	33
-0.7	(3)	-9.29414	29	(3)	-3.65315	21	(3)	-1.94041	89	(3)	-1.17365	02	(2)	-7.65615	62
-0.6	(4)	-1.30473	07	(3)	-5.11412	18	(3)	-2.70839	91	(3)	-1.63300	24	(3)	-1.06170	13
-0.5	(4)	-1.66086	19	(3)	-6.49508	42	(3)	-3.43144	26	(3)	-2.06370	40	(3)	-1.33814	35
-0.4	(4)	-1.93829	90	(3)	-7.56478	22	(3)	-3.98819	28	(3)	-2.39329	23	(3)	-1.54831	36
-0.3	(4)	-2.05153	93	(3)	-7.99213	74	(3)	-4.20553	66	(3)	-2.51877	45	(3)	-1.62617	94
-0.2	(4)	-1.88191	87	(3)	-7.31898	36	(3)	-3.84460	18	(3)	-2.29844	83	(3)	-1.48115	57
-0.1	(4)	-1.26894	82	(3)	-4.92715	82	(3)	-2.58388	05	(3)	-1.54205	59	(2)	-9.91916	94
0.0	(0)	+1.00000	00	(0)	+1.00000	00	(0)	+1.00000	00	(0)	+1.00000	00	(0)	+1.00000	00
0.1	(4)	2.20264	66	(3)	8.52983	30	(3)	4.46140	89	(3)	2.65569	71	(3)	1.70399	66
0.2	(4)	5.69563	19	(4)	2.20264	66	(4)	1.15043	71	(3)	6.83804	74	(3)	4.38084	00
0.3	(5)	1.09330	93	(4)	4.22272	41	(4)	2.20264	66	(4)	1.30747	73	(3)	8.36496	74
0.4	(5)	1.84869	24	(4)	7.13160	87	(4)	3.71537	68	(4)	2.20264	66	(4)	1.40739	54
0.5	(5)	2.90713	00	(5)	1.12016	64	(4)	5.82887	58	(4)	3.45147	55	(4)	2.20264	66
0.6	(5)	4.35713	28	(5)	1.67700	20	(4)	8.71652	20	(4)	5.15540	77	(4)	3.28620	65
0.7	(5)	6.30765	47	(5)	2.42511	79	(5)	1.25912	31	(4)	7.43887	06	(4)	4.73642	75
0.8	(5)	8.89199	75	(5)	3.41517	02	(5)	1.77129	13	(5)	1.04535	82	(4)	6.64873	73
0.9	(6)	1.22723	53	(5)	4.70872	70	(5)	2.43971	24	(5)	1.43835	42	(4)	9.13874	32
1.0	(6)	1.66450	66	(5)	6.38024	53	(5)	3.30250	83	(5)	1.94508	11	(5)	1.23458	19
$a \setminus b$		0.6		0.7		0.8		0.9		1.0					
-1.0	(1)	-1.56666	67	(1)	-1.32857	14	(1)	-1.15000	00	(1)	-1.01111	11	(0)	-9.00000	00
-0.9	(2)	-1.59656	19	(2)	-1.15824	17	(1)	-8.66482	26	(1)	-6.64811	79	(1)	-5.21121	29
-0.8	(2)	-3.32180	59	(2)	-2.38103	41	(2)	-1.75833	05	(2)	-1.33052	77	(2)	-1.02772	90
-0.7	(2)	-5.25566	60	(2)	-3.74603	08	(2)	-2.74969	50	(2)	-2.06733	55	(2)	-1.58596	75
-0.6	(2)	-7.26224	96	(2)	-5.15669	48	(2)	-3.77001	68	(2)	-2.82246	37	(2)	-2.15560	45
-0.5	(2)	-9.12749	57	(2)	-6.46204	50	(2)	-4.70972	63	(2)	-3.51454	04	(2)	-2.67503	59
-0.4	(3)	-1.05359	27	(2)	-7.44065	06	(2)	-5.40890	80	(2)	-4.02538	09	(2)	-3.05522	11
-0.3	(3)	-1.10424	16	(2)	-7.78122	74	(2)	-5.64358	20	(2)	-4.19006	43	(2)	-3.17236	75
-0.2	(3)	-1.00381	19	(2)	-7.05925	89	(2)	-5.10920	02	(2)	-3.78501	43	(2)	-2.85915	68
-0.1	(2)	-6.70959	43	(2)	-4.70898	38	(2)	-3.40090	10	(2)	-2.51375	92	(2)	-1.89427	82
0.0	(0)	+1.00000	00	(0)	+1.00000	00	(0)	+1.00000	00	(0)	+1.00000	00	(0)	+1.00000	00
0.1	(3)	1.14989	01	(2)	8.05237	11	(2)	5.80387	50	(2)	4.28243	19	(2)	3.22252	43
0.2	(3)	2.95153	65	(3)	2.06339	28	(3)	1.48456	77	(3)	1.09332	07	(2)	8.21055	88
0.3	(3)	5.62785	57	(3)	3.92867	40	(3)	2.82236	24	(3)	2.07532	55	(3)	1.55600	88
0.4	(3)	9.45635	54	(3)	6.59238	53	(3)	4.72945	31	(3)	3.47272	61	(3)	2.59995	59
0.5	(4)	1.47812	55	(4)	1.02914	95	(3)	7.37367	65	(3)	5.40715	90	(3)	4.04275	54
0.6	(4)	2.20264	66	(4)	1.53174	58	(4)	1.09611	92	(3)	8.02783	98	(3)	5.99449	62
0.7	(4)	3.17106	89	(4)	2.20264	66	(4)	1.57436	46	(4)	1.15166	83	(3)	8.58922	62
0.8	(4)	4.44649	42	(4)	3.08513	39	(4)	2.20264	66	(4)	1.60942	26	(4)	1.19892	63
0.9	(4)	6.10528	43	(4)	4.23152	76	(4)	3.01784	47	(4)	2.20264	66	(4)	1.63901	69
1.0	(4)	8.23940	35	(4)	5.70477	12	(4)	4.06428	07	(4)	2.96327	38	(4)	2.20264	66

ZEROS OF $M(a, b, x)$

Table 13.2

$a \setminus b$	0.1	0.2	0.3	0.4	0.5
-1.0	0.10000 00	0.20000 00	0.30000 00	0.40000 00	0.50000 00
-0.9	0.11054 47	0.22012 64	0.32894 15	0.43713 15	0.54480 16
-0.8	0.12357 83	0.24477 52	0.36411 44	0.48196 35	0.59858 98
-0.7	0.14010 11	0.27567 24	0.40779 72	0.53721 21	0.66443 91
-0.6	0.16173 42	0.31555 72	0.46354 99	0.60707 04	0.74705 02
-0.5	0.19128 98	0.36906 09	0.53728 03	0.69839 96	0.85403 26
-0.4	0.23411 73	0.44470 78	0.63961 58	0.82334 00	0.99868 55
-0.3	0.30182 31	0.56019 88	0.79200 44	1.00591 69	1.20695 84
-0.2	0.42537 31	0.75993 80	1.04632 32	1.30289 37	1.53918 36
-0.1	0.72703 16	1.20342 40	1.58016 05	1.90320 51	2.19258 90
$a \setminus b$	0.6	0.7	0.8	0.9	1.0
-1.0	0.60000 00	0.70000 00	0.80000 00	0.90000 00	1.00000 00
-0.9	0.65203 19	0.75888 50	0.86541 05	0.97164 85	1.07763 19
-0.8	0.71419 38	0.82892 89	0.94291 59	1.05625 10	1.16901 22
-0.7	0.78986 07	0.91376 55	1.03637 62	1.15786 85	1.27838 33
-0.6	0.88415 45	1.01887 44	1.15158 21	1.28256 70	1.41205 79
-0.5	1.00529 53	1.15298 99	1.29771 21	1.43991 63	1.57995 68
-0.4	1.16751 37	1.33112 03	1.49044 27	1.64618 10	1.79887 13
-0.3	1.39828 59	1.58200 88	1.75960 56	1.93215 19	2.10045 49
-0.2	1.76075 91	1.97114 63	2.17271 84	2.36714 89	2.55566 24
-0.1	2.45881 88	2.70808 56	2.94434 51	3.17028 02	3.38779 57

Table 13.2 gives the smallest zeros in x of $M(a, b, x)$, near $a=b=0$, that is, the smallest positive roots in x of the equation $M(a, b, x)=0$. Linear interpolation gives 3-4S. Interpolation by the Lagrange six-point formula in two dimensions gives 7S.

14. Coulomb Wave Functions

MILTON ABRAMOWITZ¹

Contents

	Page
Mathematical Properties	538
14.1. Differential Equation, Series Expansions	538
14.2. Recurrence and Wronskian Relations	539
14.3. Integral Representations	539
14.4. Bessel Function Expansions	539
14.5. Asymptotic Expansions	540
14.6. Special Values and Asymptotic Behavior	542
Numerical Methods	543
14.7. Use and Extension of the Tables	543
References	544
Table 14.1. Coulomb Wave Functions of Order Zero ($.5 \leq \eta \leq 20$, $1 \leq \rho \leq 20$)	546
$F_0(\eta, \rho), \frac{d}{d\rho} F_0(\eta, \rho), \quad G_0(\eta, \rho), \frac{d}{d\rho} G_0(\eta, \rho)$	
$\eta = .5(5)20, \rho = 1(1)20, \quad 5S$	
Table 14.2. $C_0(\eta) = e^{-\frac{1}{2}\pi\eta} \Gamma(1+i\eta) $	554
$\eta = 0(.05)3, \quad 6S$	

The author wishes to acknowledge the assistance of David S. Liepman in checking the formulas and tables.

¹ National Bureau of Standards (deceased).

14. Coulomb Wave Functions

Mathematical Properties

14.1. Differential Equation, Series Expansions

Differential Equation

14.1.1

$$\frac{d^2 w}{d\rho^2} + \left[1 - \frac{2\eta}{\rho} - \frac{L(L+1)}{\rho^2}\right] w = 0$$

($\rho > 0$, $-\infty < \eta < \infty$, L a non-negative integer)

The Coulomb wave equation has a regular singularity at $\rho=0$ with indices $L+1$ and $-L$; it has an irregular singularity at $\rho=\infty$.

General Solution

14.1.2

$$w = C_1 F_L(\eta, \rho) + C_2 G_L(\eta, \rho) \quad (C_1, C_2 \text{ constants})$$

where $F_L(\eta, \rho)$ is the regular Coulomb wave function and $G_L(\eta, \rho)$ is the irregular (logarithmic) Coulomb wave function.

Regular Coulomb Wave Function $F_L(\eta, \rho)$

14.1.3

$$F_L(\eta, \rho) = C_L(\eta) \rho^{L+1} e^{-i\eta\rho} M(L+1-i\eta, 2L+2, 2i\rho)$$

14.1.4

$$= C_L(\eta) \rho^{L+1} \Phi_L(\eta, \rho)$$

14.1.5

$$\Phi_L(\eta, \rho) = \sum_{k=L+1}^{\infty} A_k^L(\eta) \rho^{k-L-1}$$

14.1.6

$$A_{L+1}^L = 1, \quad A_{L+2}^L = \frac{\eta}{L+1},$$

$$(k+L)(k-L-1)A_k^L = 2\eta A_{k-1}^L - A_{k-2}^L \quad (k > L+2)$$

$$14.1.7 \quad C_L(\eta) = \frac{2^L e^{-\frac{\pi\eta}{2}} |\Gamma(L+1+i\eta)|}{\Gamma(2L+2)}$$

(See chapter 6.)

$$14.1.8 \quad C_0^2(\eta) = 2\pi\eta (e^{2\pi\eta} - 1)^{-1}$$

$$14.1.9 \quad C_L^2(\eta) = \frac{p_L(\eta) C_0^2(\eta)}{2\eta(2L+1)}$$

$$14.1.10 \quad C_L(\eta) = \frac{(L^2 + \eta^2)^{\frac{1}{2}}}{L(2L+1)} C_{L-1}(\eta)$$

$$14.1.11 \quad \frac{p_L(\eta)}{2\eta} = \frac{(1+\eta^2)(4+\eta^2)\dots(L^2+\eta^2)2^{2L}}{(2L+1) [(2L)!]^2}$$

$$14.1.12 \quad F_L' = \frac{d}{d\rho} F_L(\eta, \rho) = C_L(\eta) \rho^L \Phi_L^*(\eta, \rho)$$

$$14.1.13 \quad \Phi_L^*(\eta, \rho) = \sum_{k=L+1}^{\infty} k A_k^L(\eta) \rho^{k-L-1}$$

Irregular Coulomb Wave Function $G_L(\eta, \rho)$

14.1.14

$$G_L(\eta, \rho) = \frac{2\eta}{C_0^2(\eta)} F_L(\eta, \rho) [\ln 2\rho + \frac{q_L(\eta)}{p_L(\eta)}] + \theta_L(\eta, \rho)$$

$$14.1.15 \quad \theta_L(\eta, \rho) = D_L(\eta) \rho^{-L} \psi_L(\eta, \rho)$$

$$14.1.16 \quad D_L(\eta) C_L(\eta) = \frac{1}{2L+1}$$

$$14.1.17 \quad \psi_L(\eta, \rho) = \sum_{k=-L}^{\infty} a_k^L(\eta) \rho^{k+L}$$

14.1.18

$$a_L^L = 1, \quad a_{L+1}^L = 0,$$

$$(k-L-1)(k+L)a_k^L = 2\eta a_{k-1}^L - a_{k-2}^L - (2k-1)p_L(\eta)A_k^L$$

14.1.19

$$\frac{q_L(\eta)}{p_L(\eta)} = \sum_{s=1}^L \frac{s}{s^2 + \eta^2} - \sum_{s=1}^{2L+1} \frac{1}{s}$$

$$+ \mathcal{O}\left\{\frac{\Gamma'(1+i\eta)}{\Gamma(1+i\eta)}\right\} + 2\gamma + \frac{r_L(\eta)}{p_L(\eta)}$$

(See Table 6.8.)

14.1.20

$$r_L(\eta) = \frac{(-1)^{L+1}}{(2L)!} \mathcal{J} \left\{ \frac{1}{2L+1} + \frac{2(i\eta-L)}{2L(1!)} \right. \\ \left. + \frac{2^2(i\eta-L)(i\eta-L+1)}{(2L-1)(2!)} + \dots \right. \\ \left. + \frac{2^{2L}(i\eta-L)(i\eta-L+1)\dots(i\eta+L-1)}{(2L)!} \right\}$$

14.1.21

$$G_L' = \frac{dG_L}{d\rho} = \frac{2\eta}{C_0^2(\eta)} \{ F_L' [\ln 2\rho + \frac{q_L(\eta)}{p_L(\eta)}] + \rho^{-1} F_L(\eta, \rho) \} \\ + \theta_L^L(\eta, \rho)$$

14.1.22 $\theta'_L = \frac{d}{d\rho} \theta_L(\eta, \rho) = D_L(\eta) \rho^{-L-1} \psi_L^*(\eta, \rho)$

14.1.23 $\psi_L^*(\eta, \rho) = \sum_{k=-L}^{\infty} k a_k^L(\eta) \rho^{k+L}$

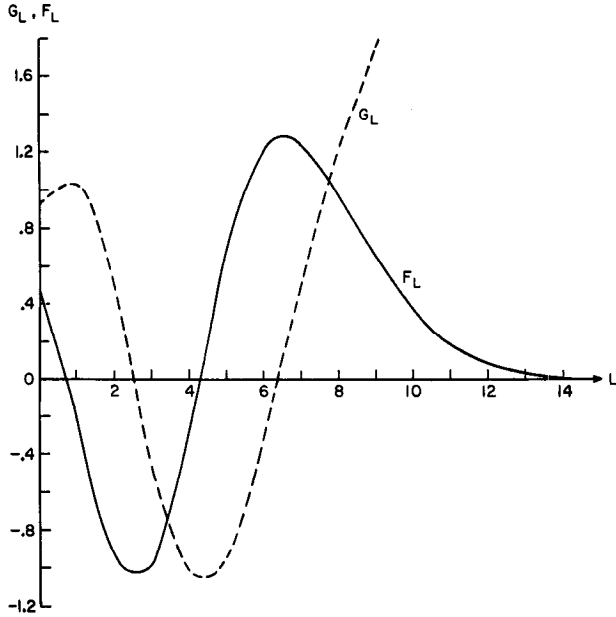

FIGURE 14.1. $F_L(\eta, \rho), G_L(\eta, \rho)$.
 $\eta=1, \rho=10$

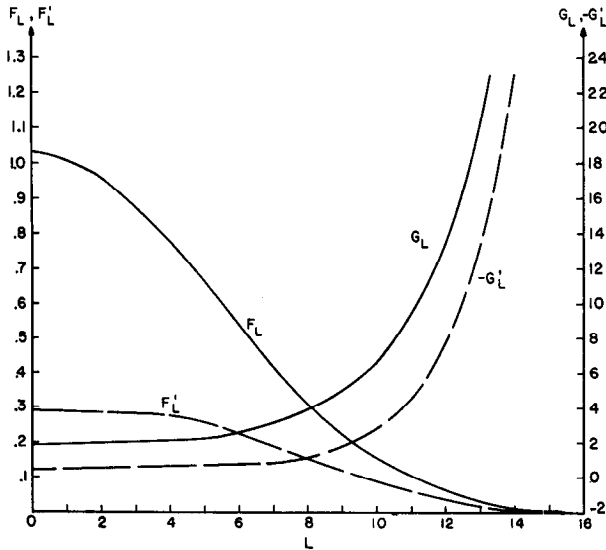

FIGURE 14.2. F_L, F'_L, G_L and G'_L .
 $\eta=10, \rho=20$

14.2. Recurrence and Wronskian Relations

Recurrence Relations

If $u_L = F_L(\eta, \rho)$ or $G_L(\eta, \rho)$,

14.2.1 $L \frac{du_L}{d\rho} = (L^2 + \eta^2) u_{L-1} - \left(\frac{L^2}{\rho} + \eta\right) u_L$

14.2.2

$(L+1) \frac{du_L}{d\rho} = \left[\frac{(L+1)^2}{\rho} + \eta\right] u_L - [(L+1)^2 + \eta^2] u_{L+1}$

14.2.3

$L[(L+1)^2 + \eta^2] u_{L+1} = (2L+1) \left[\eta + \frac{L(L+1)}{\rho}\right] u_L - (L+1)[L^2 + \eta^2] u_{L-1}$

Wronskian Relations

14.2.4 $F'_L G_L - F_L G'_L = 1$

14.2.5 $F_{L-1} G_L - F_L G_{L-1} = L(L^2 + \eta^2)^{-1/2}$

14.3. Integral Representations

14.3.1

$F_L + iG_L = \frac{ie^{-i\rho} \rho^{-L}}{(2L+1)! C_L(\eta)} \int_0^{\infty} e^{-t} t^{L-i\eta} (t+2i\rho)^{L+i\eta} dt$

14.3.2

$F_L - iG_L =$

$\frac{e^{-\pi\eta} \rho^{L+1}}{(2L+1)! C_L(\eta)} \int_{-1}^{-i\infty} e^{-i\rho t} (1-t)^{L-i\eta} (1+t)^{L+i\eta} dt$

14.3.3

$F_L + iG_L = \frac{e^{-\pi\eta} \rho^{L+1}}{(2L+1)! C_L(\eta)} \int_0^{\infty} \{ (1 - \tanh^2 t)^{L+1} \exp[-i(\rho \tanh t - 2\eta t)] + i(1+t^2)^L \exp[-\rho t + 2\eta \arctan t] \} dt$

14.4. Bessel Function Expansions

Expansion in Terms of Bessel-Clifford Functions

14.4.1

$F_L(\eta, \rho) = C_L(\eta) \frac{(2L+1)!}{(2\eta)^{2L+1}} \rho^{-L} \sum_{k=2L+1}^{\infty} b_k t^{k/2} I_k(2\sqrt{t})$
 $(t=2\eta\rho, \eta>0)$

14.4.2

$G_L(\eta, \rho) \sim D_L(\eta) \lambda_L(\eta) \rho^{-L} \sum_{k=2L+1}^{\infty} (-1)^k b_k t^{k/2} K_k(2\sqrt{t})$

14.4.3

$$b_{2L+1}=1, \quad b_{2L+2}=0, \\ 4\eta^2(k-2L)b_{k+1}+kb_{k-1}+b_{k-2}=0 \quad (k>2L+2)$$

14.4.4

$$\lambda_L(\eta) \sum_{k=2L+1}^{\infty} (-1)^k (k-1)! b_k = 2$$

(See chapter 9.)

Expansion in Terms of Spherical Bessel Functions

14.4.5

$$F_L(\eta, \rho) = 1 \cdot 3 \cdot 5 \dots (2L+1) \rho C_L(\eta) \sum_{k=L}^{\infty} b_k \sqrt{\frac{\pi}{2\rho}} J_{k+\frac{1}{2}}(\rho)$$

14.4.6

$$b_L=1, \quad b_{L+1} = \frac{2L+3}{L+1} \eta$$

$$b_k = \frac{(2k+1)}{k(k+1) - L(L+1)}$$

$$\left\{ 2\eta b_{k-1} - \frac{(k-1)(k-2) - L(L+1)}{2k-3} b_{k-2} \right\} \\ (k > L+1)$$

14.4.7

$$F'_L(\eta, \rho) = 1 \cdot 3 \cdot 5 \dots (2L+1) \rho C_L(\eta) \\ \left\{ \frac{(L+1)}{(2L+1)} b_L \sqrt{\frac{\pi}{2\rho}} J_{L-\frac{1}{2}}(\rho) + \frac{(L+2)}{(2L+3)} b_{L+1} \right. \\ \left. \cdot \sqrt{\frac{\pi}{2\rho}} J_{L+\frac{1}{2}}(\rho) + \sum_{k=L+1}^{\infty} b'_k \sqrt{\frac{\pi}{2\rho}} J_{k+\frac{1}{2}}(\rho) \right\}$$

$$14.4.8 \quad b'_k = \frac{(k+2)}{(2k+3)} b_{k+1} - \frac{(k-1)}{(2k-1)} b_{k-1}$$

Expansion in Terms of Airy Functions

$$x = (2\eta - \rho)/(2\eta)^{1/3} \quad \mu = (2\eta)^{2/3}, \quad \eta \gg \rho \\ |\rho - 2\eta| < 2\eta$$

14.4.9

$$F_0(\eta, \rho) = \pi^{1/2} (2\eta)^{1/2} \left\{ \frac{\text{Ai}(x)}{\text{Bi}(x)} \left[1 + \frac{g_1}{\mu} + \frac{g_2}{\mu^2} + \dots \right] \right. \\ \left. + \frac{\text{Ai}'(x)}{\text{Bi}'(x)} \left[\frac{f_1}{\mu} + \frac{f_2}{\mu^2} + \dots \right] \right\}$$

14.4.10

$$F'_0(\eta, \rho) = -\pi^{1/2} (2\eta)^{-1/2} \left\{ \frac{\text{Ai}(x)}{\text{Bi}(x)} \left[\frac{g'_1 + x f_1}{\mu} \right. \right. \\ \left. \left. + \frac{g'_2 + x f_2}{\mu^2} + \dots \right] + \frac{\text{Ai}'(x)}{\text{Bi}'(x)} \left[1 + \frac{(g_1 + f_1)}{\mu} \right. \right. \\ \left. \left. + \frac{(g_2 + f_2)}{\mu^2} + \dots \right] \right\}$$

$$f_1 = (1/5)x^2$$

$$f_2 = \frac{1}{35} (2x^3 + 6)$$

$$f_3 = \frac{1}{63000} (84x^7 + 1480x^4 + 2320x)$$

$$g_1 = -(1/5)x$$

$$g_2 = \frac{1}{350} (7x^5 - 30x^2)$$

$$g_3 = \frac{1}{63000} (1056x^6 - 1160x^3 - 2240)$$

(See chapter 10.)

14.5. Asymptotic Expansions

Asymptotic Expansion for Large Values of ρ

$$14.5.1 \quad F_L = g \cos \theta_L + f \sin \theta_L$$

$$14.5.2 \quad G_L = f \cos \theta_L - g \sin \theta_L$$

$$14.5.3 \quad F'_L = g^* \cos \theta_L + f^* \sin \theta_L$$

$$14.5.4 \quad G'_L = f^* \cos \theta_L - g^* \sin \theta_L, \quad gf^* - fg^* = 1$$

$$14.5.5 \quad \theta_L = \rho - \eta \ln 2\rho - L \frac{\pi}{2} + \sigma_L$$

$$14.5.6 \quad \sigma_L = \arg \Gamma(L+1+i\eta)$$

(See 6.1.27, 6.1.44.)

$$14.5.7 \quad \sigma_{L+1} = \sigma_L + \arctan \frac{\eta}{L+1}$$

(See Tables 4.14, 6.7.)

$$14.5.8 \quad f \sim \sum_{k=0}^{\infty} f_k, \quad g \sim \sum_{k=0}^{\infty} g_k, \quad f^* \sim \sum_{k=0}^{\infty} f_k^*, \quad g^* \sim \sum_{k=0}^{\infty} g_k^*$$

where

$$f_0 = 1, \quad g_0 = 0, \quad f_0^* = 0, \quad g_0^* = 1 - \eta/\rho$$

$$f_{k+1} = a_k f_k - b_k g_k$$

$$g_{k+1} = a_k g_k + b_k f_k$$

$$f_{k+1}^* = a_k f_k^* - b_k g_k^* - f_{k+1}/\rho$$

$$g_{k+1}^* = a_k g_k^* + b_k f_k^* - g_{k+1}/\rho$$

$$a_k = \frac{(2k+1)\eta}{(2k+2)\rho}, \quad b_k = \frac{L(L+1) - k(k+1) + \eta^2}{(2k+2)\rho}$$

14.5.9

$$f + ig \sim 1 + \frac{(i\eta - L)(i\eta + L + 1)}{1!(2i\rho)} + \frac{(i\eta - L)(i\eta - L + 1)(i\eta + L + 1)(i\eta + L + 2)}{2!(2i\rho)^2} + \dots$$

$$+ \frac{(i\eta - L)(i\eta - L + 1)(i\eta - L + 2)(i\eta + L + 1)(i\eta + L + 2)(i\eta + L + 3)}{3!(2i\rho)^3} + \dots$$

Asymptotic Expansion for $L=0, \rho=2\eta \gg 0$

14.5.10
$$\frac{F_0(2\eta)}{G_0(2\eta)/\sqrt{3}} \sim \frac{\Gamma(1/3)\beta^{3/2}}{2\sqrt{\pi}} \left\{ 1 \mp \frac{2}{35} \frac{\Gamma(2/3)}{\Gamma(1/3)} \frac{1}{\beta^4} - \frac{32}{8100} \frac{1}{\beta^6} \mp \frac{92672}{7371 \cdot 10^4} \frac{\Gamma(2/3)}{\Gamma(1/3)} \frac{1}{\beta^{10}} - \dots \right\}$$

14.5.11

$$\frac{F'_0(2\eta)}{G'_0(2\eta)/\sqrt{3}} \sim \frac{\Gamma(2/3)}{2\sqrt{\pi}\beta^{3/2}} \left\{ \pm 1 + \frac{1}{15} \frac{\Gamma(1/3)}{\Gamma(2/3)} \frac{1}{\beta^2} \pm \frac{8}{56700} \frac{1}{\beta^6} + \frac{11488}{18711 \cdot 10^3} \frac{\Gamma(1/3)}{\Gamma(2/3)} \frac{1}{\beta^8} \pm \dots \right\}$$

$$\beta = (2\eta/3)^{1/2}, \Gamma(1/3) = 2.6789 38534 \dots, \Gamma(2/3) = 1.3541 17939 \dots$$

14.5.12

$$\frac{F_0(2\eta)}{G_0(2\eta)} \sim \left\{ \begin{matrix} .70633 & 26373 \\ 1.22340 & 4016 \end{matrix} \right\} \eta^{1/6} \left\{ 1 \mp \frac{.04959 \ 570165}{\eta^{3/2}} - \frac{.00888 \ 88888 \ 89}{\eta^2} \right.$$

$$\left. \mp \frac{.00245 \ 51991 \ 81}{\eta^{9/2}} - \frac{.00091 \ 08958 \ 061}{\eta^4} \mp \frac{.00025 \ 34684 \ 115}{\eta^{15/2}} - \dots \right\}$$

14.5.13

$$\frac{F'_0(2\eta)}{G'_0(2\eta)} \sim \left\{ \begin{matrix} .40869 \ 57323 \\ -.70788 \ 17734 \end{matrix} \right\} \eta^{-1/6} \left\{ 1 \pm \frac{.17282 \ 60369}{\eta^{3/2}} + \frac{.00031 \ 74603 \ 174}{\eta^2} \right.$$

$$\left. \pm \frac{.00358 \ 12148 \ 50}{\eta^{9/2}} + \frac{.00031 \ 17824 \ 680}{\eta^4} \pm \frac{.00090 \ 73966 \ 427}{\eta^{15/2}} + \dots \right\}$$

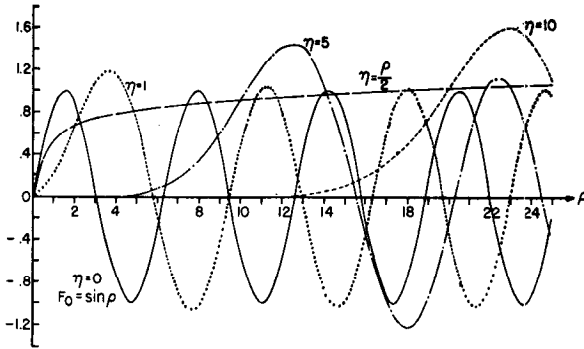

FIGURE 14.3. $F_0(\eta, \rho)$.

$\eta = 0, 1, 5, 10, \rho/2$

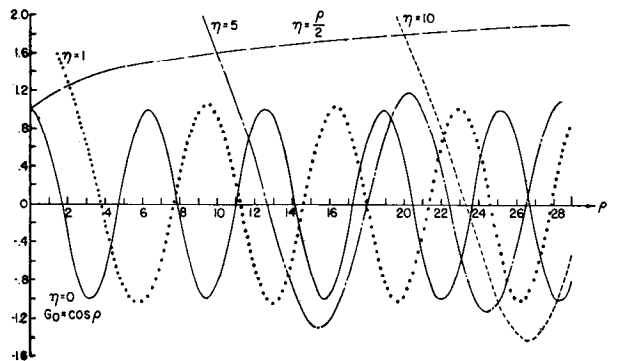

FIGURE 14.5. $G_0(\eta, \rho)$.

$\eta = 0, 1, 5, 10, \rho/2$

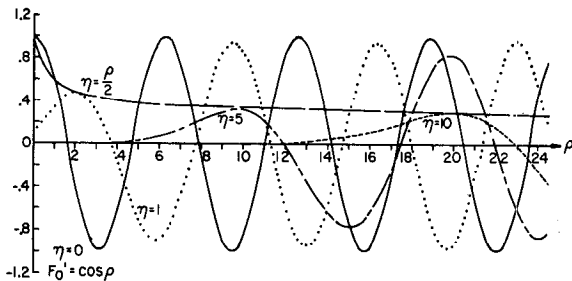

FIGURE 14.4. $F'_0(\eta, \rho)$.

$\eta = 0, 1, 5, 10, \rho/2$

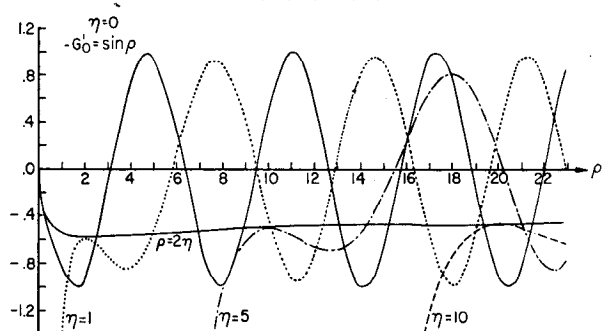

FIGURE 14.6. $G'_0(\eta, \rho)$.

$\eta = 0, 1, 5, 10, \rho/2$

14.6. Special Values and Asymptotic Behavior

14.6.1 $L > 0, \rho = 0$

$$F_L = 0, F'_L = 0$$

$$G_L = \infty, G'_L = -\infty$$

14.6.2 $L = 0, \rho = 0$

$$F_0 = 0, F'_0 = C_0(\eta)$$

$$G_0 = 1/C_0(\eta), G'_0 = -\infty$$

14.6.3 $L \rightarrow \infty$

$$F_L \sim C_L(\eta)\rho^{L+1}, G_L \sim D_L(\eta)\rho^{-L}$$

14.6.4 $L = 0, \eta = 0$

$$F_0 = \sin \rho, F'_0 = \cos \rho$$

$$G_0 = \cos \rho, G'_0 = -\sin \rho$$

14.6.5 $\rho \rightarrow \infty$

$$G_L + iF_L \sim \exp i[\rho - \eta \ln 2\rho - \frac{L\pi}{2} + \sigma_L]$$

14.6.6 $L \geq 0, \eta = 0$

$$F_L = (\frac{1}{2}\pi\rho)^{\frac{1}{2}} J_{L+\frac{1}{2}}(\rho)$$

$$G_L = (-1)^L (\frac{1}{2}\pi\rho)^{\frac{1}{2}} J_{-(L+\frac{1}{2})}(\rho)$$

14.6.7 $L \geq 0, 2\eta \gg \rho$

$$F_L \sim \frac{(2L+1)!C_L(\eta)}{(2\eta)^{L+1}} (2\eta\rho)^{\frac{1}{2}} I_{2L+1}[2(2\eta\rho)^{\frac{1}{2}}]$$

$$G_L \sim \frac{2(2\eta)^L}{(2L+1)!C_L(\eta)} (2\eta\rho)^{\frac{1}{2}} K_{2L+1}[2(2\eta\rho)^{\frac{1}{2}}]$$

14.6.8 $L = 0, 2\eta \gg \rho$

$$F_0 \sim e^{-\pi\eta} (\pi\rho)^{\frac{1}{2}} I_0[2(2\eta\rho)^{\frac{1}{2}}]$$

$$F'_0 \sim e^{-\pi\eta} (2\pi\eta)^{\frac{1}{2}} I_0[2(2\eta\rho)^{\frac{1}{2}}]$$

$$G_0 \sim 2e^{\pi\eta} \left(\frac{\rho}{\pi}\right)^{\frac{1}{2}} K_1[2(2\eta\rho)^{\frac{1}{2}}]$$

$$G'_0 \sim -2 \left(\frac{2\eta}{\pi}\right)^{\frac{1}{2}} e^{\pi\eta} K_0[2(2\eta\rho)^{\frac{1}{2}}]$$

14.6.9 $L = 0, 2\eta \gg \rho$

$$F_0 \sim \frac{1}{2} \beta e^\alpha; F'_0 \sim \frac{1}{2} \beta^{-1} e^\alpha$$

$$G_0 \sim \beta e^{-\alpha}; G'_0 \sim -\beta^{-1} e^{-\alpha}$$

$$\alpha = 2\sqrt{2\eta\rho} - \pi\eta$$

$$\beta = (\rho/2\eta)^{\frac{1}{2}}$$

14.6.10 $L = 0, 2\eta \gg \rho$

$$F_0 \sim \frac{1}{2} \beta e^\alpha; F'_0 \sim \left\{ \beta^{-2} + \frac{1}{8\eta} t^{-2} \beta^4 \right\} F_0$$

$$G_0 \sim \beta e^{-\alpha}; G'_0 \sim \left\{ -\beta^{-2} + \frac{1}{8\eta} t^{-2} \beta^4 \right\} G_0$$

$$t = \rho/2\eta$$

$$\alpha = 2\eta \left\{ [t(1-t)]^{\frac{1}{2}} + \arcsin t^{\frac{1}{2}} - \frac{1}{2}\pi \right\}$$

$$\beta = \{t/(1-t)\}^{\frac{1}{2}}$$

14.6.11 $L = 0, \rho \gg 2\eta$

$$F_0 = \alpha \sin \beta; F'_0 = -t^2(bF_0 - aG_0)$$

$$G_0 = \alpha \cos \beta; G'_0 = -t^2(aF_0 + bG_0)$$

$$t = \frac{2\eta}{\rho}$$

$$\alpha = \left(\frac{1}{1-t}\right)^{\frac{1}{2}} \exp \left[-\frac{8t^3 - 3t^4}{64(2\eta)^2(1-t)^3} \right]$$

$$\beta = \frac{\pi}{4} + 2\eta \left\{ \frac{(1-t)^{\frac{1}{2}}}{t} + \frac{1}{2} \ln \left[\frac{1-(1-t)^{\frac{1}{2}}}{1+(1-t)^{\frac{1}{2}}} \right] \right\}$$

$$a = t^{-2}(1-t)^{\frac{1}{2}}, b = [8\eta(1-t)]^{-1}$$

14.6.12 $\eta \gg 0, 2\eta \sim \rho$

$$\begin{aligned} F_L(\eta, \rho) \\ G_L(\eta, \rho) \end{aligned} \sim \sqrt{\pi} \left\{ \frac{\rho_L}{1 + \frac{L(L+1)}{\rho_L^2}} \right\}^{1/6} \begin{Bmatrix} \text{Ai}(x) \\ \text{Bi}(x) \end{Bmatrix}$$

$$\rho_L = \eta + [\eta^2 + L(L+1)]^{1/2}$$

$$x = (\rho_L - \rho) \left[\frac{1}{\rho_L} + \frac{L(L+1)}{\rho_L^3} \right]^{1/3}$$

14.6.13 $\eta \gg 0, 2\eta \sim \rho$

$$x = (2\eta - \rho)(2\eta)^{-1/3}$$

$$[G_0 + iF_0] \sim \pi^{1/2} (2\eta)^{1/6} [\text{Bi}(x) + i\text{Ai}(x)]$$

$$[G'_0 + iF'_0] \sim -\pi^{1/2} (2\eta)^{-1/6} [\text{Bi}'(x) + i\text{Ai}'(x)]$$

14.6.14 $\eta \gg 0$

$$\rho_L = \eta + [\eta^2 + L(L+1)]^{1/2}$$

$$\begin{aligned} F_L(\rho_L) \\ G_L(\rho_L)/\sqrt{3} \end{aligned} \sim \frac{\Gamma(1/3)}{2\sqrt{\pi}} \left(\frac{\rho_L}{3}\right)^{1/6} \left\{ 1 + \frac{L(L+1)}{\rho_L^2} \right\}^{-1/6}$$

$$\begin{aligned} F'_L(\rho_L) \\ G'_L(\rho_L)/\sqrt{3} \end{aligned} \sim \pm \frac{\Gamma(2/3)}{2\sqrt{\pi}} \left(\frac{\rho_L}{3}\right)^{-1/6} \left\{ 1 + \frac{L(L+1)}{\rho_L^2} \right\}^{1/6}$$

14.6.15 $\rho=2\eta \gg 0$
 $F_0 \sim \frac{\Gamma(1/3)}{2\sqrt{\pi}} (2\eta)^{1/6}$
 $G_0/\sqrt{3} \sim \frac{\Gamma(1/3)}{2\sqrt{\pi}} (2\eta)^{1/6}$
 $F'_0 \sim \frac{\Gamma(2/3)}{2\sqrt{\pi}(2\eta/3)^{1/6}}$
 $-G'_0/\sqrt{3} \sim \frac{\Gamma(2/3)}{2\sqrt{\pi}(2\eta/3)^{1/6}}$

14.6.16 $\eta \rightarrow \infty$
 $\sigma_0(\eta) \sim [\frac{\pi}{4} + \eta(\ln \eta - 1)]$
 $C_0(\eta) \sim (2\pi\eta)^{1/2} e^{-\pi\eta}$
 (Equality to 8S for $\eta > 3$.)

14.6.17 $\eta \rightarrow 0$
 $\sigma_0(\eta) \sim -\gamma\eta$ (γ =Euler's constant)
 $C_L(\eta) \sim \frac{2^L L!}{(2L+1)!}$

14.6.18 $L \rightarrow \infty$
 $C_L(\eta) \sim \frac{2^L L!}{(2L+1)!} e^{-\pi\eta/2}$

Numerical Methods

14.7. Use and Extension of the Tables

In general the tables as presented are not simply interpolable. However, values for $L > 0$ may be obtained with the help of the recurrence relations. The values of $G_L(\eta, \rho)$ may be obtained by applying the recurrence relations in increasing order of L . Forward recurrence may be used for $F_L(\eta, \rho)$ as long as the instability does not produce errors in excess of the accuracy needed. In this case the backwards recurrence scheme (see Example 1) should be used.

Example 1. Compute $F_L(\eta, \rho)$ and $F'_L(\eta, \rho)$ for $\eta=2, \rho=5, L=0(1)5$. Starting with $F_{10}^*=1, F_{11}^*=0$, where $F_L^*=cF_L$, we compute from 14.2.3 in decreasing order of L :

L	(1) F_L^*	(2) F_L	(3) F_L	(4) F'_L
11	0.			
10	1.			
9	4.49284			
8	17.5225			
7	61.3603			
6	191.238			
5	523.472	.090791	.091	.1043
4	1238.53	.21481	.215	.2030
3	2486.72	.43130	.4313	.3205
2	4158.46	.72124	.72125	.3952
1	5727.97	.99346	.99347	.3709
0	6591.81	1.1433	1.1433	.29380

$F_0/F_0^* = 1.7344 \times 10^{-4} = c^{-1}$.

The values in the second column are obtained from those in the first by multiplying by the normalization constant, F_0/F_0^* where F_0 is the known value obtained from Table 14.1.

Repetition starting with $F_{15}^*=1$ and $F_{16}^*=0$ yields the same results.

In column 3, the results have been given when 14.2.3 is used in increasing order of L .

F'_L (column 4) follows from 14.2.2.

Example 2. Compute $G_L(\eta, \rho)$ and $G'_L(\eta, \rho)$ for $\eta=2, \rho=5, L=1(1)5$.

Using 14.2.2 and $G_0(2, 5) = .79445, G'_0 = -.67049$ from Table 14.1 we find $G_1(2, 5) = 1.0815$. Then by forward recurrence using 14.2.3 we find:

L	G_L	$-G'_L$ *
1	1.0815	.60286
2	1.4969	.56619
3	2.0487	.79597
4	3.0941	1.7318
5	5.6298	4.5493

The values of G'_L are obtained with 14.2.1.

Example 3. Compute $G_0(\eta, \rho)$ for $\eta=2, \rho=2.5$. From Table 14.1, $G_0(2, 2) = 3.5124, G'_0(2, 2) = -2.5554$. Successive differentiation of 14.1.1 for $L=0$ gives

$$\rho \frac{d^{k+2}w}{d\rho^{k+2}} = (2\eta - \rho) \frac{d^k w}{d\rho^k} - k \left\{ \frac{d^{k+1}w}{d\rho^{k+1}} + \frac{d^{k-1}w}{d\rho^{k-1}} \right\}$$

Taylor's expansion is $w(\rho + \Delta\rho) = w(\rho) + (\Delta\rho)w' + \frac{(\Delta\rho)^2}{2!} w'' + \dots$ With $w = G_0(\eta, \rho)$ and $\Delta\rho = .5$ we get:

k	$\frac{d^k G_0}{d\rho^k}$	$\frac{(\Delta\rho)^k}{k!} \frac{d^k G_0}{d\rho^k}$
0	3.5124	3.5124
1	-2.5554	-1.2777
2	3.5124	.43905
3	-6.0678	-.12641
4	12.136	.03160
5	-29.540	-.00769
6	83.352	.00181
7	-268.26	-.00042

$G_0(2, 2.5) = 2.5726$

As a check the result is obtained with $\eta=2, \rho=3, \Delta\rho = -.5$. The derivative $G'_0(\eta, \rho)$ may be obtained using Taylor's formula with $w = G'_0(\eta, \rho)$.

*See page 11.

References

Texts

- [14.1] M. Abramowitz and H. A. Antosiewicz, Coulomb wave functions in the transition region. *Phys. Rev.* **96**, 75-77 (1954).
- [14.2] Biedenharn, Gluckstern, Hull, and Breit, Coulomb functions for large charges and small velocities. *Phys. Rev.* **97**, 542 (1955).
- [14.3] I. Bloch et al., Coulomb functions for reactions of protons and alpha-particles with the lighter nuclei. *Rev. Mod. Phys.* **23**, 147-182 (1951).
- [14.4] Carl-Erik Fröberg, Numerical treatment of Coulomb wave functions. *Rev. Mod. Phys.* **27**, 399-411 (1955).
- [14.5] I. A. Stegun and M. Abramowitz, Generation of Coulomb wave functions from their recurrence relations. *Phys. Rev.* **98**, 1851 (1955).

Tables

- [14.6] M. Abramowitz and P. Rabinowitz, Evaluation of Coulomb wave functions along the transition line. *Phys. Rev.* **96**, 77-79 (1954). Tabulates F_0, F'_0, G_0, G'_0 for $\rho=2\eta=0(.5)20(2)50$, 8S.
- [14.7] National Bureau of Standards, Tables of Coulomb wave functions, vol. I, Applied Math. Series 17 (U.S. Government Printing Office, Washington, D.C., 1952). Tabulates $\Phi_L(\eta, \rho)$ and $\frac{1}{k!} \frac{d^k \Phi_k(\eta, \rho)}{d\eta^k}$ for $\rho=0(.2)5$, $\eta=-5(1)5$, $L=0(1)5, 10, 11, 20, 21$, 7D.
- [14.8] Numerical Computation Bureau, Tables of Whittaker functions (Wave functions in a Coulomb field). Report No. 9, Japan (1956).
- [14.9] A. Tubis, Tables of non-relativistic Coulomb wave functions, Los Alamos Scientific Laboratory La-2150, Los Alamos, N. Mex. (1958). Values of F_0, F'_0, G_0, G'_0 , $\rho=0(.2)40$; $\eta=0(.05)12$, 5S.

Table 14.1 COULOMB WAVE FUNCTIONS OF ORDER ZERO

$\eta \setminus \rho$	$F_0(\eta, \rho)$				
	1	2	3	4	5
0.5	(-1) 5.1660	(0) 1.0211	(0) 1.0432	(-1) 4.1924	(-1) -4.9046
1.0	(-1) 2.2753	(-1) 6.6178	(0) 1.0841	(0) 1.1571	(-1) +6.8494
1.5	(-2) 8.4815	(-1) 3.3159	(-1) 7.3013	(0) 1.1186	(0) 1.2327
2.0	(-2) 2.8898	(-1) 1.4445	(-1) 3.9861	(-1) 7.7520	(0) 1.1433
2.5	(-3) 9.3008	(-2) 5.7560	(-1) 1.9162	(-1) 4.4865	(-1) 8.0955
3.0	(-3) 2.8751	(-2) 2.1538	(-2) 8.4417	(-1) 2.3093	(-1) 4.8882
3.5	(-4) 8.6200	(-3) 7.6857	(-2) 3.4863	(-1) 1.0927	(-1) 2.6473
4.0	(-4) 2.5224	(-3) 2.6417	(-2) 1.3692	(-2) 4.8493	(-1) 1.3227
4.5	(-5) 7.2358	(-4) 8.8072	(-3) 5.1636	(-2) 2.0448	(-2) 6.2060
5.0	(-5) 2.0413	(-4) 2.8622	(-3) 1.8829	(-3) 8.2690	(-2) 2.7673
5.5	(-6) 5.6770	(-5) 9.1017	(-4) 6.6735	(-3) 3.2283	(-2) 1.1829
6.0	(-6) 1.5593	(-5) 2.8403	(-4) 2.3080	(-3) 1.2230	(-3) 4.8778
6.5	(-7) 4.2367	(-6) 8.7187	(-5) 7.8131	(-4) 4.5136	(-3) 1.9502
7.0	(-7) 1.1400	(-6) 2.6375	(-5) 2.5954	(-4) 1.6280	(-4) 7.5886
7.5	(-8) 3.0407	(-7) 7.8750	(-6) 8.4780	(-5) 5.7536	(-4) 2.8831
8.0	(-9) 8.0474	(-7) 2.3238	(-6) 2.7278	(-5) 1.9966	(-4) 1.0722
8.5	(-9) 2.1146	(-8) 6.7842	(-7) 8.6573	(-6) 6.8154	(-5) 3.9115
9.0	(-10) 5.5203	(-8) 1.9614	(-7) 2.7136	(-6) 2.2918	(-5) 1.4023
9.5	(-10) 1.4325	(-9) 5.6202	(-8) 8.4089	(-7) 7.6019	(-6) 4.9481
10.0	(-11) 3.6966	(-9) 1.5971	(-8) 2.5785	(-7) 2.4900	(-6) 1.7207
10.5	(-12) 9.4903	(-10) 4.5043	(-9) 7.8306	(-8) 8.0621	(-7) 5.9043
11.0	(-12) 2.4248	(-10) 1.2613	(-9) 2.3567	(-8) 2.5824	(-7) 2.0009
11.5	(-13) 6.1679	(-11) 3.5086	(-10) 7.0332	(-9) 8.1895	(-8) 6.7032
12.0	(-13) 1.5623	(-12) 9.6998	(-10) 2.0826	(-9) 2.5730	(-8) 2.2216
12.5	(-14) 3.9419	(-12) 2.6660	(-11) 6.1216	(-10) 8.0134	(-9) 7.2896
13.0	(-15) 9.9089	(-13) 7.2878	(-11) 1.7870	(-10) 2.4754	(-9) 2.3694
13.5	(-15) 2.4822	(-13) 1.9819	(-12) 5.1827	(-11) 7.5877	(-10) 7.6337
14.0	(-16) 6.1972	(-14) 5.3636	(-12) 1.4939	(-11) 2.3090	(-10) 2.4390
14.5	(-16) 1.5424	(-14) 1.4449	(-13) 4.2812	(-12) 6.9781	(-11) 7.7314
15.0	(-17) 3.8274	(-15) 3.8752	(-13) 1.2201	(-12) 2.0952	(-11) 2.4326
15.5	(-18) 9.4708	(-15) 1.0350	(-14) 3.4592	(-13) 6.2521	(-12) 7.5998
16.0	(-18) 2.3372	(-16) 2.7536	(-15) 9.7586	(-13) 1.8547	(-12) 2.3584
16.5	(-19) 5.7529	(-17) 7.2980	(-15) 2.7399	(-14) 5.4712	(-13) 7.2719
17.0	(-19) 1.4126	(-17) 1.9272	(-16) 7.6580	(-14) 1.6053	(-13) 2.2286
17.5	(-20) 3.4602	(-18) 5.0719	(-16) 2.1311	(-15) 4.6864	(-14) 6.7904
18.0	(-21) 8.4571	(-18) 1.3304	(-17) 5.9063	(-15) 1.3614	(-14) 2.0575
18.5	(-21) 2.0625	(-19) 3.4785	(-17) 1.6304	(-16) 3.9364	(-15) 6.2009
19.0	(-22) 5.0197	(-20) 9.0677	(-18) 4.4834	(-16) 1.1331	(-15) 1.8594
19.5	(-22) 1.2192	(-20) 2.3568	(-18) 1.2284	(-17) 3.2476	(-16) 5.5480
20.0	(-23) 2.9556	(-21) 6.1087	(-19) 3.3538	(-18) 9.2696	(-16) 1.6477
			$\frac{d}{d\rho} F_0(\eta, \rho)$		
0.5	(-1) 5.9292	(-1) 3.2960	(-1) -3.1699	(-1) -8.6672	(-1) -8.3314
1.0	(-1) 3.4873	(-1) 4.8156	(-1) +3.0192	(-1) -1.9273	(-1) -7.2364
1.5	(-1) 1.5684	(-1) 3.3631	(-1) 4.3300	(-1) +2.9671	(-1) -1.0456
2.0	(-2) 6.1308	(-1) 1.7962	(-1) 3.2695	(-1) 4.0401	(-1) +2.9380
2.5	(-2) 2.1980	(-2) 8.2804	(-1) 1.9237	(-1) 3.1922	(-1) 3.8386
3.0	(-3) 7.4239	(-2) 3.4693	(-2) 9.8019	(-1) 2.0030	(-1) 3.1264
3.5	(-3) 2.3993	(-2) 1.3575	(-2) 4.5336	(-1) 1.0945	(-1) 2.0555
4.0	(-4) 7.4933	(-3) 5.0436	(-2) 1.9532	(-2) 5.4362	(-1) 1.1839
4.5	(-4) 2.2767	(-3) 1.7984	(-3) 7.9650	(-2) 2.5140	(-2) 6.2113
5.0	(-5) 6.7615	(-4) 6.2008	(-3) 3.1077	(-2) 1.0992	(-2) 3.0360
5.5	(-5) 1.9700	(-4) 2.0789	(-3) 1.1690	(-3) 4.5914	(-2) 1.4028
6.0	(-6) 5.6457	(-5) 6.8046	(-4) 4.2638	(-3) 1.8462	(-3) 6.1885
6.5	(-6) 1.5950	(-5) 2.1817	(-4) 1.5145	(-4) 7.1867	(-3) 2.6259
7.0	(-7) 4.4497	(-6) 6.8691	(-5) 5.2563	(-4) 2.7200	(-3) 1.0777
7.5	(-7) 1.2276	(-6) 2.1283	(-5) 1.7875	(-4) 1.0045	(-4) 4.2964
8.0	(-8) 3.3527	(-7) 6.5001	(-6) 5.9696	(-5) 3.6292	(-4) 1.6695
8.5	(-9) 9.0744	(-7) 1.9597	(-6) 1.9614	(-5) 1.2859	(-5) 6.3417
9.0	(-9) 2.4359	(-8) 5.8395	(-7) 6.3501	(-6) 4.4771	(-5) 2.3601
9.5	(-10) 6.4900	(-8) 1.7215	(-7) 2.0285	(-6) 1.5341	(-6) 8.6225
10.0	(-10) 1.7173	(-9) 5.0256	(-8) 6.4011	(-7) 5.1804	(-6) 3.0976
10.5	(-11) 4.5150	(-9) 1.4539	(-8) 1.9973	(-7) 1.7262	(-6) 1.0958
11.0	(-11) 1.1801	(-10) 4.1713	(-9) 6.1672	(-8) 5.6813	(-7) 3.8219
11.5	(-12) 3.0676	(-10) 1.1875	(-9) 1.8860	(-8) 1.8487	(-7) 1.3157
12.0	(-13) 7.9334	(-11) 3.3562	(-10) 5.7160	(-9) 5.9521	(-8) 4.4743
12.5	(-13) 2.0420	(-12) 9.4217	(-10) 1.7179	(-9) 1.8975	(-8) 1.5045
13.0	(-14) 5.2322	(-12) 2.6282	(-11) 5.1227	(-10) 5.9935	(-9) 5.0060
13.5	(-14) 1.3350	(-13) 7.2879	(-11) 1.5163	(-10) 1.8768	(-9) 1.6492
14.0	(-15) 3.3929	(-13) 2.0096	(-12) 4.4571	(-11) 5.8291	(-10) 5.3830
14.5	(-16) 8.5905	(-14) 5.5121	(-12) 1.3016	(-11) 1.7966	(-10) 1.7417
15.0	(-16) 2.1673	(-14) 1.5043	(-13) 3.7774	(-12) 5.4972	(-11) 5.5888
15.5	(-17) 5.4495	(-15) 4.0861	(-13) 1.0899	(-12) 1.6705	(-11) 1.7794
16.0	(-17) 1.3659	(-15) 1.1049	(-14) 3.1270	(-13) 5.0433	(-12) 5.6234
16.5	(-18) 3.4129	(-16) 2.9747	(-15) 8.9243	(-13) 1.5132	(-12) 1.7647
17.0	(-19) 8.5032	(-17) 7.9764	(-15) 2.5341	(-14) 4.5133	(-13) 5.5009
17.5	(-19) 2.1127	(-17) 2.1304	(-16) 7.1612	(-14) 1.3386	(-13) 1.7038
18.0	(-20) 5.2352	(-18) 5.6690	(-16) 2.0144	(-15) 3.9490	(-14) 5.2453
18.5	(-20) 1.2940	(-18) 1.5031	(-17) 5.6414	(-15) 1.1590	(-14) 1.6054
19.0	(-21) 3.1905	(-19) 3.9718	(-17) 1.5733	(-16) 3.3848	(-15) 4.8863
19.5	(-22) 7.8484	(-19) 1.0461	(-18) 4.3698	(-17) 9.8388	(-15) 1.4793
20.0	(-22) 1.9263	(-20) 2.7464	(-18) 1.2090	(-17) 2.8470	(-16) 4.4556

For use of this table see Examples 1-3.

COULOMB WAVE FUNCTIONS OF ORDER ZERO Table 14.1

$\eta \backslash \rho$	$G_0(\eta, \rho)$				
	1	2	3	4	5
0.5	(0) 1.1975	(-1) 5.3221	(-1) -3.4105	(-1) -9.8570	(-1) -9.3493
1.0	(0) 2.0431	(0) 1.2758	(-1) +6.2704	(-1) -1.8901	(-1) -8.9841
1.5	(0) 4.0886	(0) 2.0276	(0) 1.3423	(-1) +7.1836	(-2) -5.3716
2.0	(0) 9.8003	(0) 3.5124	(0) 2.0405	(0) 1.3975	(-1) +7.9445
2.5	(1) 2.6401	(0) 7.1318	(0) 3.2733	(0) 2.0592	(0) 1.4442
3.0	(1) 7.6551	(1) 1.6390	(0) 6.0195	(0) 3.1445	(0) 2.0788
3.5	(2) 2.3355	(1) 4.0982	(1) 1.2493	(0) 5.4049	(0) 3.0657
4.0	(2) 7.4015	(2) 1.0878	(1) 2.8313	(1) 1.0423	(0) 5.0146
4.5	(3) 2.4167	(2) 3.0209	(1) 6.8403	(1) 2.1964	(0) 9.1424
5.0	(3) 8.0855	(2) 8.6969	(2) 1.7354	(1) 4.9434	(1) 1.8193
5.5	(4) 2.7606	(3) 2.5792	(2) 4.5790	(2) 1.1708	(1) 3.8704
6.0	(4) 9.5899	(3) 7.8428	(3) 1.2482	(2) 2.8891	(1) 8.6736
6.5	(5) 3.3815	(4) 2.4367	(3) 3.4980	(2) 7.3782	(2) 2.0275
7.0	(6) 1.2081	(4) 7.7137	(4) 1.0041	(3) 1.9403	(2) 4.9101
7.5	(6) 4.3664	(5) 2.4826	(4) 2.9432	(3) 5.2344	(3) 1.2258
8.0	(7) 1.5946	(5) 8.1086	(4) 8.7893	(4) 1.4441	(3) 3.1422
8.5	(7) 5.8778	(6) 2.6837	(5) 2.6689	(4) 4.0648	(3) 8.2458
9.0	(8) 2.1850	(6) 8.9891	(5) 8.2266	(5) 1.1648	(4) 2.2097
9.5	(8) 8.1855	(7) 3.0439	(6) 2.5706	(5) 3.3928	(4) 6.0344
10.0	(9) 3.0882	(8) 1.0411	(6) 8.1333	(6) 1.0029	(5) 1.6764
10.5	(10) 1.1727	(8) 3.5934	(7) 2.6029	(6) 3.0052	(5) 4.7305
11.0	(10) 4.4801	(9) 1.2509	(7) 8.4187	(6) 9.1181	(6) 1.3542
11.5	(11) 1.7211	(9) 4.3888	(8) 2.7496	(7) 2.7986	(6) 3.9285
12.0	(11) 6.6465	(10) 1.5511	(8) 9.0625	(7) 8.6825	(7) 1.1537
12.5	(12) 2.5793	(10) 5.5199	(9) 3.0124	(8) 2.7207	(7) 3.4272
13.0	(13) 1.0055	(11) 1.9769	(10) 1.0093	(8) 8.6053	(8) 1.0290
13.5	(13) 3.9366	(11) 7.1230	(10) 3.4069	(9) 2.7457	(8) 3.1205
14.0	(14) 1.5474	(12) 2.5811	(11) 1.1581	(9) 8.8331	(8) 9.5523
14.5	(14) 6.1061	(12) 9.4029	(11) 3.9629	(10) 2.8638	(9) 2.9500
15.0	(15) 2.4181	(13) 3.4429	(12) 1.3645	(10) 9.3530	(9) 9.1867
15.5	(15) 9.6091	(14) 1.2667	(12) 4.7264	(11) 3.0758	(10) 2.8835
16.0	(16) 3.8309	(14) 4.6814	(13) 1.6463	(12) 1.0182	(10) 9.1182
16.5	(17) 1.5320	(15) 1.7377	(13) 5.7652	(12) 3.3917	(11) 2.9039
17.0	(17) 6.1445	(15) 6.4769	(14) 2.0292	(13) 1.1365	(11) 9.3107
17.5	(18) 2.4714	(16) 2.4236	(14) 7.1771	(13) 3.8299	(12) 3.0045
18.0	(18) 9.9670	(16) 9.1034	(15) 2.5502	(14) 1.2976	(12) 9.7548
18.5	(19) 4.0300	(17) 3.4316	(15) 9.1019	(14) 4.4194	(13) 3.1857
19.0	(20) 1.6335	(18) 1.2981	(16) 3.2623	(15) 1.5126	(14) 1.0462
19.5	(20) 6.6365	(18) 4.9263	(17) 1.1741	(15) 5.2016	(14) 3.4544
20.0	(21) 2.7024	(19) 1.8756	(17) 4.2418	(16) 1.7969	(15) 1.1464
	$\frac{d}{d\rho} G_0(\eta, \rho)$				
0.5	(-1) -5.6132	(-1) -8.0753	(-1) -8.5494	(-1) -3.4747	(-1) +4.5076
1.0	(0) -1.2636	(-1) -5.8273	(-1) -7.4783	(-1) -8.3273	(-1) -5.1080
1.5	(0) -4.2300	(-1) -9.5930	(-1) -5.7358	(-1) -7.0346	(-1) -8.0665
2.0	(1) -1.3813	(0) -2.5554	(-1) -8.3499	(-1) -5.6167	(-1) -6.7049
2.5	(1) -4.5128	(0) -7.1137	(0) -1.9326	(-1) -7.6379	(-1) -5.5046
3.0	(2) -1.5015	(1) -2.0029	(0) -4.8566	(0) -1.6029	(-1) -7.1618
3.5	(2) -5.1001	(1) -5.7725	(1) -1.2438	(0) -3.7375	(0) -1.3970
4.0	(3) -1.7657	(2) -1.7086	(1) -3.2646	(0) -8.9366	(0) -3.0719
4.5	(3) -6.2161	(2) -5.1859	(1) -8.8150	(1) -2.1901	(0) -6.9633
5.0	(4) -2.2206	(3) -1.6097	(2) -2.4467	(1) -5.5222	(1) -1.6176
5.5	(4) -8.0354	(3) -5.0961	(2) -6.9635	(2) -1.4325	(1) -3.8641
6.0	(5) -2.9409	(4) -1.6418	(3) -2.0268	(2) -3.8154	(1) -9.4968
6.5	(6) -1.0873	(4) -5.3723	(3) -6.0185	(3) -1.0408	(2) -2.3977
7.0	(6) -4.0566	(5) -1.7825	(4) -1.8195	(3) -2.9006	(2) -6.2044
7.5	(7) -1.5259	(5) -5.9890	(4) -5.5897	(3) -8.2422	(3) -1.6419
8.0	(7) -5.7831	(6) -2.0352	(5) -1.7425	(4) -2.3835	(3) -4.4339
8.5	(8) -2.2067	(6) -6.9879	(5) -5.5045	(4) -7.0031	(4) -1.2197
9.0	(8) -8.4732	(7) -2.4222	(6) -1.7601	(5) -2.0878	(4) -3.4122
9.5	(9) -3.2724	(7) -8.4693	(6) -5.6909	(5) -6.3080	(4) -9.6943
10.0	(10) -1.2706	(8) -2.9853	(7) -1.8591	(6) -1.9295	(5) -2.7937
10.5	(10) -4.9580	(9) -1.0602	(7) -6.1315	(6) -5.9693	(5) -8.1574
11.0	(11) -1.9437	(9) -3.7915	(8) -2.0402	(7) -1.8664	(6) -2.4111
11.5	(11) -7.6530	(10) -1.3647	(8) -6.8449	(7) -5.8932	(6) -7.2077
12.0	(12) -3.0256	(10) -4.9424	(9) -2.3143	(8) -1.8780	(7) -2.1776
12.5	(13) -1.2008	(11) -1.8002	(9) -7.8819	(8) -6.0367	(7) -6.6446
13.0	(13) -4.7827	(11) -6.5922	(10) -2.7027	(9) -1.9562	(8) -2.0464
13.5	(14) -1.9115	(12) -2.4263	(10) -9.3274	(9) -6.3878	(8) -6.3581
14.0	(14) -7.6643	(12) -8.9735	(11) -3.2386	(10) -2.1009	(9) -1.9918
14.5	(15) -3.0826	(13) -3.3539	(12) -1.1310	(10) -6.9573	(9) -6.2887
15.0	(16) -1.2434	(14) -1.2440	(12) -3.9713	(11) -2.3188	(10) -2.0003
15.5	(16) -5.0296	(14) -4.6610	(13) -1.4017	(11) -7.7763	(10) -6.4071
16.0	(17) -2.0399	(15) -1.7532	(13) -4.9720	(12) -2.6230	(11) -2.0660
16.5	(17) -8.2941	(15) -6.6194	(14) -1.7719	(12) -8.8973	(11) -6.7044
17.0	(18) -3.3805	(16) -2.5081	(14) -6.3433	(13) -3.0340	(12) -2.1889
17.5	(19) -1.3810	(16) -9.5361	(15) -2.2806	(14) -1.0399	(12) -7.1879
18.0	(19) -5.6545	(17) -3.6376	(15) -8.2334	(14) -3.5813	(13) -2.3735
18.5	(20) -2.3201	(18) -1.3919	(16) -2.9841	(15) -1.2392	(13) -7.8789
19.0	(20) -9.5394	(18) -5.3424	(17) -1.0857	(15) -4.3069	(14) -2.6288
19.5	(21) -3.9299	(19) -2.0564	(17) -3.9642	(16) -1.5033	(14) -8.8139
20.0	(22) -1.6221	(19) -7.9378	(18) -1.4526	(16) -5.2691	(15) -2.9690

*See page 11.

Table 14.1 COULOMB WAVE FUNCTIONS OF ORDER ZERO

$\eta \setminus \rho$	6	7	8	9	10
	$F_0(\eta, \rho)$				
0.5	(0) -1.0286	(- 1) -7.6744	(- 1) +1.0351	(- 1) +8.8802	(- 1) +9.3919
1.0	(- 1) -1.6718	(- 1) -9.0632	(0) -1.0333	(- 1) -4.3441	(- 1) +4.7756
1.5	(- 1) +8.7682	(- 1) +1.1034	(- 1) -7.0763	(0) -1.1015	(- 1) -8.0125
2.0	(0) 1.2850	(0) 1.0148	(- 1) +3.3340	(- 1) -4.9930	(0) -1.0616
2.5	(0) 1.1633	(0) 1.3237	(0) 1.1181	(- 1) +5.1312	(- 1) -3.0351
3.0	(- 1) 8.3763	(0) 1.1803	(0) 1.3540	(0) 1.1984	(- 1) +6.6010
3.5	(- 1) 5.2251	(- 1) 8.6154	(0) 1.1952	(0) 1.3786	(0) 1.2627
4.0	(- 1) 2.9445	(- 1) 5.5158	(- 1) 8.8245	(0) 1.2085	(0) 1.3992
4.5	(- 1) 1.5362	(- 1) 3.2100	(- 1) 5.7720	(- 1) 9.0109	(0) 1.2207
5.0	(- 2) 7.5384	(- 1) 1.7351	(- 1) 3.4502	(- 1) 6.0014	(- 1) 9.1794
5.5	(- 2) 3.5181	(- 2) 8.8379	(- 1) 1.9214	(- 1) 3.6697	(- 1) 6.2092
6.0	(- 2) 1.5740	(- 2) 4.2849	(- 1) 1.0100	(- 1) 2.0964	(- 1) 3.8720
6.5	(- 3) 6.7927	(- 2) 1.9924	(- 2) 5.0593	(- 1) 1.1325	(- 1) 2.2615
7.0	(- 3) 2.8407	(- 3) 8.9366	(- 2) 2.4318	(- 2) 5.8352	(- 1) 1.2511
7.5	(- 3) 1.1557	(- 3) 3.8839	(- 2) 1.1277	(- 2) 2.8870	(- 2) 6.6087
8.0	(- 4) 4.5875	(- 3) 1.6415	(- 3) 5.0678	(- 2) 1.3786	(- 2) 3.3543
8.5	(- 4) 1.7814	(- 4) 6.7674	(- 3) 2.2145	(- 3) 6.3805	(- 2) 1.6440
9.0	(- 5) 6.7813	(- 4) 2.7281	(- 4) 9.4374	(- 3) 2.8716	(- 3) 7.8106
9.5	(- 5) 2.5352	(- 4) 1.0776	(- 4) 3.9317	(- 3) 1.2603	(- 3) 3.6091
10.0	(- 6) 9.3224	(- 5) 4.1786	(- 4) 1.6046	(- 4) 5.4065	(- 3) 1.6263
10.5	(- 6) 3.3763	(- 5) 1.5930	(- 5) 6.4260	(- 4) 2.2716	(- 4) 7.1627
11.0	(- 6) 1.2058	(- 6) 5.9782	(- 5) 2.5293	(- 5) 9.3643	(- 4) 3.0895
11.5	(- 7) 4.2504	(- 6) 2.2113	(- 6) 9.7972	(- 5) 3.7930	(- 4) 1.3072
12.0	(- 7) 1.4802	(- 7) 8.0697	(- 6) 3.7389	(- 5) 1.5115	(- 5) 5.4341
12.5	(- 8) 5.0971	(- 7) 2.9081	(- 6) 1.4073	(- 6) 5.9333	(- 5) 2.2220
13.0	(- 8) 1.7367	(- 7) 1.0358	(- 7) 5.2291	(- 6) 2.2964	(- 6) 8.9480
13.5	(- 9) 5.8586	(- 8) 3.6487	(- 7) 1.9195	(- 7) 8.7713	(- 6) 3.5521
14.0	(- 9) 1.9579	(- 8) 1.2720	(- 8) 6.9669	(- 7) 3.3091	(- 6) 1.3913
14.5	(-10) 6.4858	(- 9) 4.3915	(- 8) 2.5016	(- 7) 1.2340	(- 7) 5.3814
15.0	(-10) 2.1306	(- 9) 1.5022	(- 9) 8.8925	(- 8) 4.5511	(- 7) 2.0569
15.5	(-11) 6.9438	(-10) 5.0935	(- 9) 3.1309	(- 8) 1.6612	(- 8) 7.7746
16.0	(-11) 2.2461	(-10) 1.7129	(- 9) 1.0924	(- 9) 6.0045	(- 8) 2.9076
16.5	(-12) 7.2135	(-11) 5.7147	(-10) 3.7787	(- 9) 2.1502	(- 8) 1.0765
17.0	(-12) 2.3009	(-11) 1.8924	(-10) 1.2965	(-10) 7.6316	(- 9) 3.9479
17.5	(-13) 7.2918	(-12) 6.2217	(-11) 4.4135	(-10) 2.6859	(- 9) 1.4347
18.0	(-13) 2.2965	(-12) 2.0316	(-11) 1.4913	(-11) 9.3772	(-10) 5.1691
18.5	(-14) 7.1900	(-13) 6.5907	(-12) 5.0033	(-11) 3.2487	(-10) 1.8470
19.0	(-14) 2.2382	(-13) 2.1247	(-12) 1.6672	(-11) 1.1173	(-11) 6.5478
19.5	(-15) 6.9296	(-14) 6.8088	(-13) 5.5194	(-12) 3.8154	(-11) 2.3038
20.0	(-15) 2.1342	(-14) 2.1694	(-13) 1.8158	(-12) 1.2942	(-12) 8.0470
	$\frac{d}{d\rho} F_0(\eta, \rho)$				
0.5	(- 1) -1.6439	(- 1) +6.5317	(- 1) +9.6217	(- 1) +4.8856	(- 1) -3.9577
1.0	(- 1) -8.9251	(- 1) -4.9515	(- 1) +2.6293	(- 1) +8.6117	(- 1) +8.4114
1.5	(- 1) -5.9833	(- 1) -8.7151	(- 1) -6.7918	(- 2) -5.9095	(- 1) +6.3051
2.0	(- 2) -4.4197	(- 1) -4.9758	(- 1) -8.2026	(- 1) -7.7036	(- 1) -2.9353
2.5	(- 1) +2.9104	(- 3) -1.2700	(- 1) -4.1714	(- 1) -7.6083	(- 1) -8.0858
3.0	(- 1) 3.6867	(- 1) +2.8830	(- 2) +3.0507	(- 1) -3.5216	(- 1) -7.0180
3.5	(- 1) 3.0694	(- 1) 3.5660	(- 1) 2.8559	(- 2) +5.4822	(- 1) -2.9887
4.0	(- 1) 2.0917	(- 1) 3.0193	(- 1) 3.4667	(- 1) 2.8296	(- 2) +7.3929
4.5	(- 1) 1.2557	(- 1) 2.1173	(- 1) 2.9748	(- 1) 3.3827	(- 1) 2.8044
5.0	(- 2) 6.8842	(- 1) 1.3148	(- 1) 2.1357	(- 1) 2.9346	(- 1) 3.3103
5.5	(- 2) 3.5199	(- 2) 7.4742	(- 1) 1.3640	(- 1) 2.1489	(- 1) 2.8982
6.0	(- 2) 1.7018	(- 2) 3.9680	(- 2) 7.9960	(- 1) 1.4058	(- 1) 2.1583
6.5	(- 3) 7.8549	(- 2) 1.9931	(- 2) 4.3832	(- 2) 8.4608	(- 1) 1.4416
7.0	(- 3) 3.4861	(- 3) 9.5595	(- 2) 2.2750	(- 2) 4.7685	(- 2) 8.8777
7.5	(- 3) 1.4956	(- 3) 4.4083	(- 2) 1.1280	(- 2) 2.5468	(- 2) 5.1268
8.0	(- 4) 6.2296	(- 3) 1.9647	(- 3) 5.3775	(- 2) 1.2999	(- 2) 2.8081
8.5	(- 4) 2.5276	(- 4) 8.4983	(- 3) 2.4777	(- 3) 6.3815	(- 2) 1.4707
9.0	(- 4) 1.0018	(- 4) 3.5795	(- 3) 1.1077	(- 3) 3.0279	(- 3) 7.4103
9.5	(- 5) 3.8880	(- 4) 1.4721	(- 4) 4.8216	(- 3) 1.3940	(- 3) 3.6095
10.0	(- 5) 1.4803	(- 5) 5.9256	(- 4) 2.0487	(- 4) 6.2477	(- 3) 1.7060
10.5	(- 6) 5.5384	(- 5) 2.3388	(- 5) 8.5166	(- 4) 2.7329	(- 4) 7.8494
11.0	(- 6) 2.0392	(- 6) 9.0675	(- 5) 3.4707	(- 4) 1.1694	(- 4) 3.5246
11.5	(- 7) 7.3981	(- 6) 3.4579	(- 5) 1.3887	(- 5) 4.9038	(- 4) 1.5479
12.0	(- 7) 2.6475	(- 7) 1.2988	(- 6) 5.4642	(- 5) 2.0187	(- 5) 6.6617
12.5	(- 8) 9.3549	(- 7) 4.8095	(- 6) 2.1167	(- 6) 8.1695	(- 5) 2.8139
13.0	(- 8) 3.2665	(- 7) 1.7578	(- 7) 8.0818	(- 6) 3.2541	(- 5) 1.1682
13.5	(- 8) 1.1280	(- 8) 6.3458	(- 7) 3.0443	(- 6) 1.2772	(- 6) 4.7727
14.0	(- 9) 3.8550	(- 8) 2.2647	(- 7) 1.1324	(- 7) 4.9445	(- 6) 1.9209
14.5	(- 9) 1.3046	(- 9) 7.9952	(- 8) 4.1623	(- 7) 1.8896	(- 7) 7.6241
15.0	(-10) 4.3743	(- 9) 2.7940	(- 8) 1.5130	(- 8) 7.1342	(- 7) 2.9865
15.5	(-10) 1.4540	(-10) 9.6701	(- 9) 5.4422	(- 8) 2.6629	(- 7) 1.1555
16.0	(-11) 4.7930	(-10) 3.3165	(- 9) 1.9382	(- 9) 9.8333	(- 8) 4.4191
16.5	(-11) 1.5677	(-10) 1.1277	(-10) 6.8378	(- 9) 3.5942	(- 8) 1.6715
17.0	(-12) 5.0893	(-11) 3.8030	(-10) 2.3909	(- 9) 1.3011	(- 9) 6.2571
17.5	(-12) 1.6405	(-11) 1.2726	(-11) 8.2893	(-10) 4.6667	(- 9) 2.3192
18.0	(-13) 5.2523	(-12) 4.2267	(-11) 2.8507	(-10) 1.6593	(-10) 8.5155
18.5	(-13) 1.6708	(-12) 1.3939	(-12) 9.7283	(-11) 5.8508	(-10) 3.0988
19.0	(-14) 5.2819	(-13) 4.5659	(-12) 3.2955	(-11) 2.0467	(-10) 1.1181
19.5	(-14) 1.6599	(-13) 1.4859	(-12) 1.1085	(-12) 7.1053	(-11) 4.0014
20.0	(-15) 5.1871	(-14) 4.8057	(-13) 3.7036	(-12) 2.4488	(-11) 1.4209

COULOMB WAVE FUNCTIONS

COULOMB WAVE FUNCTIONS OF ORDER ZERO

Table 14.1

$\eta \setminus \rho$	$G_0(\eta, \rho)$				
	6	7	8	9	10
0.5	(-1) -1.8864	(-1) +7.0035	(0) +1.0284	(-1) +5.2116	(-1) -4.1435
1.0	(0) -1.0908	(-1) -5.9842	(-1) +2.9114	(-1) +9.7148	(-1) +9.4287
1.5	(-1) -7.8946	(0) -1.1433	(-1) -8.7095	(-2) -9.0032	(-1) +7.4235
2.0	(-2) +5.7313	(-1) -6.8439	(0) -1.1353	(0) -1.0415	(-1) -3.9931
2.5	(-1) 8.5834	(-1) +1.4966	(-1) -5.8782	(0) -1.1041	(0) -1.1456
3.0	(0) 1.4847	(-1) 9.1321	(-1) +2.2822	(-1) -5.0095	(0) -1.0601
3.5	(0) 2.0980	(0) 1.5205	(-1) 9.6127	(-1) +2.9641	(-1) -4.2253
4.0	(0) 3.0138	(0) 2.1165	(0) 1.5526	(0) 1.0040	(-1) +3.5656
4.5	(0) 4.7449	(0) 2.9779	(0) 2.1340	(0) 1.5818	(0) 1.0426
5.0	(0) 8.2720	(0) 4.5475	(0) 2.9524	(0) 2.1507	(0) 1.6085
5.5	(1) 1.5713	(0) 7.6426	(0) 4.3971	(0) 2.9338	(0) 2.1665
6.0	(1) 3.1910	(1) 1.3964	(0) 7.1665	(0) 4.2789	(0) 2.9202
6.5	(1) 6.8300	(1) 2.7266	(1) 2.2667	(0) 6.7939	(0) 4.1837
7.0	(2) 1.5259	(1) 5.6125	(1) 2.3913	(1) 1.1669	(0) 6.4944
7.5	(2) 3.5340	(2) 1.2063	(1) 4.7587	(1) 2.1389	(1) 1.0879
8.0	(2) 8.4429	(2) 2.6887	(1) 9.8888	(1) 4.1320	(1) 1.9428
8.5	(3) 2.0726	(2) 6.1843	(2) 2.1316	(1) 8.3352	(1) 3.6553
9.0	(3) 5.2121	(3) 1.4623	(2) 4.7425	(2) 1.7442	(1) 7.1811
9.5	(4) 1.3393	(3) 3.5456	(3) 1.0850	(2) 3.7678	(2) 1.4634
10.0	(4) 3.5096	(3) 8.7792	(3) 2.5448	(2) 8.3709	(2) 3.0787
10.5	(4) 9.3615	(4) 2.2190	(3) 6.1041	(3) 1.9070	(2) 6.6618
11.0	(5) 2.5381	(4) 5.7119	(4) 1.4943	(3) 4.4437	(3) 1.4783
11.5	(5) 6.9851	(5) 1.4951	(4) 3.7266	(4) 1.0570	(3) 3.3559
12.0	(6) 1.9492	(5) 3.9745	(4) 9.4543	(4) 2.5623	(3) 7.7783
12.5	(6) 5.5096	(6) 1.0718	(5) 2.4367	(4) 6.3199	(4) 1.8375
13.0	(7) 1.5761	(6) 2.9250	(5) 6.3731	(5) 1.5841	(4) 4.4178
13.5	(7) 4.5596	(6) 8.1041	(6) 1.6898	(5) 4.0302	(5) 1.0796
14.0	(8) 1.3330	(7) 2.2686	(6) 4.5378	(6) 1.0398	(5) 2.6784
14.5	(8) 3.9356	(7) 6.4200	(7) 1.2333	(6) 2.7177	(5) 6.7399
15.0	(9) 1.1728	(8) 1.8356	(7) 3.3897	(6) 7.1908	(6) 1.7186
15.5	(9) 3.5260	(8) 5.2995	(7) 9.4158	(7) 1.9247	(6) 4.4374
16.0	(10) 1.0689	(9) 1.5441	(8) 2.6418	(7) 5.2078	(7) 1.1592
16.5	(10) 3.2661	(9) 4.5382	(8) 7.4830	(8) 1.4237	(7) 3.0621
17.0	(11) 1.0055	(10) 1.3449	(9) 2.1387	(8) 3.9301	(7) 8.1738
17.5	(11) 3.1176	(10) 4.0168	(9) 6.1650	(9) 1.0950	(8) 2.2037
18.0	(11) 9.7326	(11) 1.2087	(10) 1.7916	(9) 3.0778	(8) 5.9978
18.5	(12) 3.0582	(11) 3.6634	(10) 5.2473	(9) 8.7237	(9) 1.6472
19.0	(12) 9.6692	(12) 1.1179	(11) 1.5483	(10) 2.4925	(9) 4.5626
19.5	(13) 3.0754	(12) 3.4335	(11) 4.6007	(10) 7.1762	(10) 1.2742
20.0	(13) 9.8379	(13) 1.0612	(12) 1.3764	(11) 2.0813	(10) 3.5867
			$\frac{d}{d\rho} G_0(\eta, \rho)$		
0.5	(-1) +9.4204	(-1) +7.0722	(-1) -1.0134	(-1) -8.3938	(-1) -8.9014
1.0	(-1) +1.5804	(-1) +7.7643	(-1) +8.9368	(-1) +3.7613	(-1) -4.3326
1.5	(-1) -6.0177	(-2) -5.6347	(-1) +5.7724	(-1) +9.0303	(-1) +6.6389
2.0	(-1) -7.8017	(-1) -6.4993	(-1) -2.0611	(-1) +3.9589	(-1) +8.3156
2.5	(-1) -6.4488	(-1) -7.5553	(-1) -6.7507	(-1) -3.1180	(-1) +2.4273
3.0	(-1) -5.4037	(-1) -6.2420	(-1) -7.3342	(-1) -6.8725	(-1) -3.8780
3.5	(-1) -6.8137	(-1) -5.3135	(-1) -6.0700	(-1) -7.1359	(-1) -6.9193
4.0	(0) -1.2552	(-1) -6.5441	(-1) -5.2327	(-1) -5.9237	(-1) -6.9585
4.5	(0) -2.6310	(0) -1.1510	(-1) -6.3266	(-1) -5.1597	(-1) -5.7969
5.0	(0) -5.7112	(0) -2.3175	(0) -1.0709	(-1) -6.1460	(-1) -5.0932
5.5	(1) -1.2704	(0) -4.8515	(0) -2.0829	(0) -1.0071	(-1) -5.9925
6.0	(1) -2.9032	(1) -1.0407	(0) -4.2272	(0) -1.9007	(-1) -9.5489
6.5	(1) -6.8237	(1) -2.2915	(0) -8.7913	(0) -3.7545	(0) -1.7550
7.0	(2) -1.6477	(1) -5.1862	(1) -1.8751	(0) -7.6010	(0) -3.3846
7.5	(2) -4.0793	(2) -1.2056	(1) -4.1077	(1) -1.5769	(0) -6.6920
8.0	(3) -1.0333	(2) -2.8738	(1) -9.2394	(1) -3.3574	(1) -1.3548
8.5	(3) -2.6728	(2) -7.0107	(2) -2.1308	(1) -7.3362	(1) -2.8128
9.0	(3) -7.0464	(3) -1.7469	(2) -5.0295	(2) -1.6432	(1) -5.9900
9.5	(4) -1.8904	(3) -4.4387	(3) -1.2129	(2) -3.7670	(2) -1.3072
10.0	(4) -5.1540	(4) -1.1482	(3) -2.9831	(2) -8.8229	(2) -2.9193
10.5	(5) -1.4262	(4) -3.0197	(3) -7.4717	(3) -2.1080	(2) -6.6607
11.0	(5) -4.0011	(4) -8.0639	(4) -1.9033	(3) -5.1298	(3) -1.5503
11.5	(6) -1.1369	(5) -2.1843	(4) -4.9246	(4) -1.2698	(3) -3.6759
12.0	(6) -3.2694	(5) -5.9953	(5) -1.2929	(4) -3.1937	(3) -8.8669
12.5	(6) -9.5069	(6) -1.6661	(5) -3.4407	(4) -8.1522	(4) -2.1734
13.0	(7) -2.7936	(6) -4.6835	(5) -9.2739	(5) -2.1099	(4) -5.4080
13.5	(7) -8.2899	(7) -1.3312	(6) -2.5296	(5) -5.5322	(5) -1.3647
14.0	(8) -2.4829	(7) -3.8226	(6) -6.9781	(6) -1.4684	(5) -3.4894
14.5	(8) -7.5021	(8) -1.1083	(7) -1.9454	(6) -3.9424	(5) -9.0337
15.0	(9) -2.2856	(8) -3.2430	(7) -5.4781	(7) -1.0701	(6) -2.3663
15.5	(9) -7.0183	(8) -9.5716	(8) -1.5573	(7) -2.9344	(6) -6.2673
16.0	(10) -2.1712	(9) -2.8485	(8) -4.4670	(7) -8.1256	(7) -1.6775
16.5	(10) -6.7650	(9) -8.5435	(9) -1.2923	(8) -2.2710	(7) -4.5347
17.0	(11) -2.1221	(10) -2.5817	(9) -3.7692	(8) -6.4031	(8) -1.2375
17.5	(11) -6.7001	(10) -7.8569	(10) -1.1079	(9) -1.8206	(8) -3.4078
18.0	(12) -2.1285	(11) -2.4075	(10) -3.2807	(9) -5.2180	(8) -9.4651
18.5	(12) -6.8019	(11) -7.4250	(10) -9.7840	(10) -1.5070	(9) -2.6506
19.0	(13) -2.1860	(12) -2.3043	(11) -2.9377	(10) -4.3845	(9) -7.4812
19.5	(13) -7.0638	(12) -7.1939	(11) -8.8779	(11) -1.2846	(10) -2.1275
20.0	(14) -2.2945	(13) -2.2589	(12) -2.6998	(11) -3.7889	(10) -6.0938

Table 14.1 COULOMB WAVE FUNCTIONS OF ORDER ZERO

$\eta \backslash \rho$	11	12	$F_0(\eta, \rho)$	13	14	15
0.5	(-1)+2.0734	(-1)-6.9792	(0)-1.0101	(-1)-4.5964	(-1)+4.8492	
1.0	(0)+1.0298	(-1)+7.9515	(-2)-5.5932	(-1)-8.6120	(-1)-9.7879	
1.5	(-2)+2.4612	(-1)+8.3008	(0)+1.0493	(-1)+5.1243	(-1)-3.9930	
2.0	(0)-1.0170	(-1)-3.6119	(-1)+5.1844	(0)+1.0566	(-1)+8.8343	
2.5	(-1)-9.6841	(0)-1.1262	(-1)-6.5977	(-1)+1.8869	(-1)+9.1875	
3.0	(-1)-1.2613	(-1)-8.5079	(0)-1.1642	(-1)-8.7866	(-1)-1.1758	
3.5	(-1)+7.8227	(-2)+3.2549	(-1)-7.2395	(0)-1.1551	(0)-1.0318	
4.0	(0) 1.3156	(-1) 8.8532	(-1)+1.7404	(-1)-5.9595	(0)-1.1153	
4.5	(0) 1.4169	(0) 1.3600	(-1) 9.7341	(-1)+3.0035	(-1)-4.7101	
5.0	(0) 1.2318	(0) 1.4324	(0) 1.3978	(0) 1.0496	(-1)+4.1342	
5.5	(-1) 9.3335	(0) 1.2422	(0) 1.4462	(0) 1.4305	(0) 1.1161	
6.0	(-1) 6.3994	(-1) 9.4757	(0) 1.2519	(0) 1.4586	(0) 1.4592	
6.5	(-1) 4.0596	(-1) 6.5749	(-1) 9.6077	(0) 1.2610	(0) 1.4698	
7.0	(-1) 2.4178	(-1) 4.2347	(-1) 6.7378	(-1) 9.7312	(0) 1.2697	
7.5	(-1) 1.3660	(-1) 2.5662	(-1) 4.3989	(-1) 6.8900	(-1) 9.8472	
8.0	(-2) 7.3768	(-1) 1.4773	(-1) 2.7074	(-1) 4.5535	(-1) 7.0328	
8.5	(-2) 3.8306	(-2) 8.1375	(-1) 1.5852	(-1) 2.8422	(-1) 4.6997	
9.0	(-2) 1.9215	(-2) 4.3132	(-2) 8.8895	(-1) 1.6898	(-1) 2.9711	
9.5	(-3) 9.3472	(-2) 2.2096	(-2) 4.8001	(-2) 9.6316	(-1) 1.7913	
10.0	(-3) 4.4228	(-2) 1.0980	(-2) 2.5064	(-2) 5.2898	(-1) 1.0363	
10.5	(-3) 2.0410	(-3) 5.3087	(-2) 1.2700	(-2) 2.8108	(-2) 5.7809	
11.0	(-4) 9.2064	(-3) 2.5036	(-3) 6.2624	(-2) 1.4498	(-2) 3.1214	
11.5	(-4) 4.0667	(-3) 1.1541	(-3) 3.0126	(-3) 7.2798	(-2) 1.6367	
12.0	(-4) 1.7621	(-4) 5.2102	(-3) 1.4168	(-3) 3.5666	(-2) 8.3567	
12.5	(-5) 7.5001	(-4) 2.3072	(-4) 6.5253	(-3) 1.7085	(-3) 4.1640	
13.0	(-5) 3.1398	(-4) 1.0036	(-4) 2.9480	(-4) 8.0157	(-3) 2.0290	
13.5	(-5) 1.2943	(-5) 4.2931	(-4) 1.3082	(-4) 3.6890	(-4) 9.6841	
14.0	(-6) 5.2587	(-5) 1.8082	(-5) 5.7090	(-4) 1.6677	(-4) 4.5343	
14.5	(-6) 2.1078	(-6) 7.5055	(-5) 2.4529	(-5) 7.4139	(-4) 2.0854	
15.0	(-7) 8.3417	(-6) 3.0731	(-5) 1.0386	(-5) 3.2448	(-5) 9.4326	
15.5	(-7) 3.2617	(-6) 1.2422	(-6) 4.3371	(-5) 1.3994	(-5) 4.2002	
16.0	(-7) 1.2609	(-7) 4.9601	(-6) 1.7878	(-6) 5.9525	(-5) 1.8429	
16.5	(-8) 4.8223	(-7) 1.9580	(-7) 7.2797	(-6) 2.4990	(-6) 7.9746	
17.0	(-8) 1.8255	(-8) 7.6449	(-7) 2.9299	(-6) 1.0363	(-6) 3.4058	
17.5	(-9) 6.8436	(-8) 2.9542	(-7) 1.1663	(-7) 4.2471	(-6) 1.4366	
18.0	(-9) 2.5420	(-8) 1.1303	(-8) 4.5940	(-7) 1.7213	(-7) 5.9886	
18.5	(-10) 9.3587	(-9) 4.2845	(-8) 1.7916	(-8) 6.9031	(-7) 2.4686	
19.0	(-10) 3.4166	(-9) 1.6095	(-9) 6.9206	(-8) 2.7406	(-7) 1.0068	
19.5	(-10) 1.2373	(-10) 5.9943	(-9) 2.6491	(-8) 1.0776	(-8) 4.0646	
20.0	(-11) 4.4462	(-10) 2.2143	(-9) 1.0052	(-9) 4.1981	(-8) 1.6250	
			$\frac{d}{d\rho} F_0(\eta, \rho)$			
0.5	(-1)-9.5680	(-1)-7.1349	(-1)+1.3869	(-1)+8.7670	(-1)+8.6352	
1.0	(-1)+1.8546	(-1)-6.2449	(-1)-9.5769	(-1)-5.3599	(-1)+3.1951	
1.5	(-1)+9.2360	(-1)+5.8520	(-1)-1.7814	(-1)-8.2728	(-1)-8.7421	
2.0	(-1)+3.8476	(-1)+8.5839	(-1)+7.9972	(-1)+2.0967	(-1)-5.3804	
2.5	(-1)-4.5774	(-1)+1.6399	(-1)+7.2679	(-1)+8.8132	(-1)+4.9591	
3.0	(-1)-8.1670	(-1)-5.7064	(-2)-2.2037	(-1)+5.7220	(-1)+8.7738	
3.5	(-1)-6.4636	(-1)-8.0763	(-1)-6.4688	(-1)-1.7427	(-1)+4.1643	
4.0	(-1)-2.5453	(-1)-5.9550	(-1)-7.8882	(-1)-6.9700	(-1)-2.9695	
4.5	(-2)+8.9270	(-1)-2.1713	(-1)-5.4930	(-1)-7.6466	(-1)-7.2842	
5.0	(-1) 2.7803	(-1)+1.0181	(-1)-1.8523	(-1)-5.0747	(-1)-5.0747	
5.5	(-1) 3.2469	(-1) 2.7572	(-1)+1.1221	(-1)-1.5772	(-1)-4.6963	
6.0	(-1) 2.8649	(-1) 3.1907	(-1) 2.7353	(-1)+1.2094	(-1)-1.3378	
6.5	(-1) 2.1649	(-1) 2.8342	(-1) 3.1402	(-1) 2.7144	(-1) 1.2836	
7.0	(-1) 1.4725	(-1) 2.1694	(-1) 2.8059	(-1) 3.0946	(-1) 2.6945	
7.5	(-2) 9.2538	(-1) 1.4994	(-1) 2.1722	(-1) 2.7794	(-1) 3.0530	
8.0	(-2) 5.4607	(-2) 9.5947	(-1) 1.5231	(-1) 2.1737	(-1) 2.7548	
8.5	(-2) 3.0589	(-2) 5.7724	(-2) 9.9053	(-1) 1.5440	(-1) 2.1743	
9.0	(-2) 1.6394	(-2) 3.2995	(-2) 6.0640	(-1) 1.0189	(-1) 1.5625	
9.5	(-3) 8.4560	(-2) 1.8054	(-2) 3.5301	(-2) 6.3375	(-1) 1.0450	
10.0	(-3) 4.2172	(-3) 9.5118	(-2) 1.9685	(-2) 3.7513	(-2) 6.5943	
10.5	(-3) 2.0412	(-3) 4.8467	(-2) 1.0573	(-2) 2.1282	(-2) 3.9633	
11.0	(-4) 9.6175	(-3) 2.3971	(-3) 5.4937	(-2) 1.1634	(-2) 2.2844	
11.5	(-4) 4.4224	(-3) 1.1542	(-3) 2.7714	(-3) 6.1551	(-2) 1.2693	
12.0	(-4) 1.9888	(-4) 5.4237	(-3) 1.3612	(-3) 3.1620	(-3) 6.8276	
12.5	(-5) 8.7636	(-4) 2.4927	(-4) 6.5256	(-3) 1.5818	(-3) 3.5670	
13.0	(-5) 3.7897	(-4) 1.1224	(-4) 3.0596	(-4) 7.7243	(-3) 1.8150	
13.5	(-5) 1.6105	(-5) 4.9597	(-4) 1.4055	(-4) 3.6892	(-4) 9.0158	
14.0	(-6) 6.7342	(-5) 2.1535	(-5) 6.3355	(-4) 1.7264	(-4) 4.3806	
14.5	(-6) 2.7736	(-6) 9.1993	(-5) 2.8061	(-5) 7.9271	(-4) 2.0855	
15.0	(-6) 1.1263	(-6) 3.8704	(-5) 1.2227	(-5) 3.5765	(-5) 9.7427	
15.5	(-7) 4.5133	(-6) 1.6053	(-6) 5.2466	(-5) 1.5873	(-5) 4.4720	
16.0	(-7) 1.7861	(-7) 6.5690	(-6) 2.2191	(-6) 6.9375	(-5) 2.0192	
16.5	(-8) 6.9850	(-7) 2.6544	(-7) 9.2602	(-6) 2.9885	(-6) 8.9777	
17.0	(-8) 2.7014	(-7) 1.0598	(-7) 3.8151	(-6) 1.2700	(-6) 3.9341	
17.5	(-8) 1.0337	(-8) 4.1839	(-7) 1.5529	(-7) 5.3278	(-6) 1.7006	
18.0	(-9) 3.9159	(-8) 1.6340	(-8) 6.2491	(-7) 2.2081	(-7) 7.2565	
18.5	(-9) 1.4693	(-9) 6.3169	(-8) 2.4875	(-8) 9.0465	(-7) 3.0587	
19.0	(-10) 5.4629	(-9) 2.4184	(-9) 9.8001	(-8) 3.6658	(-7) 1.2744	
19.5	(-10) 2.0135	(-10) 9.1730	(-9) 3.8231	(-8) 1.4700	(-8) 5.2514	
20.0	(-11) 7.3598	(-10) 3.4487	(-9) 1.4774	(-9) 5.8367	(-8) 2.1413	

COULOMB WAVE FUNCTIONS OF ORDER ZERO

Table 14.1

$\eta \setminus \rho$	$G_0(\eta, \rho)$				
	11	12	13	14	15
0.5	(0) -1.0028	(- 1) -7.4645	(- 1) +1.4266	(- 1) +9.0905	(- 1) +8.9435
1.0	(- 1) +2.1054	(- 1) -6.8021	(0) -1.0410	(- 1) -5.8152	(- 1) +3.4046
1.5	(0) +1.0819	(- 1) +6.8165	(- 1) -1.9619	(- 1) -9.3005	(- 1) -9.7885
2.0	(- 1) +4.6526	(0) +1.0451	(- 1) +9.6524	(- 1) +2.5664	(- 1) -6.2172
2.5	(- 1) -6.4066	(- 1) +1.9303	(- 1) +9.1486	(0) +1.0999	(- 1) +6.1593
3.0	(0) -1.2065	(- 1) -8.2667	(- 2) -5.4999	(- 1) +7.4014	(0) +1.1292
3.5	(0) -1.0105	(0) -1.2387	(- 1) -9.6933	(- 1) -2.7342	(- 1) +5.4881
4.0	(- 1) -3.5145	(- 1) -9.5867	(0) -1.2515	(0) -1.0783	(- 1) -4.6254
4.5	(- 1) +4.1032	(- 1) -2.8667	(- 1) -9.0670	(0) -1.2510	(0) -1.1612
5.0	(0) 1.0777	(- 1) +4.5891	(- 1) -2.2730	(- 1) -8.5560	(0) -1.2413
5.5	(0) 1.6333	(0) 1.1100	(- 1) +5.0322	(- 1) -1.7259	(- 1) -8.0595
6.0	(0) 2.1816	(0) 1.6563	(0) 1.1399	(- 1) +5.4393	(- 1) -1.2194
6.5	(0) 2.9102	(0) 2.1960	(0) 1.6778	(0) 1.1677	(- 1) +5.8159
7.0	(0) 4.1056	(0) 2.9029	(0) 2.2097	(0) 1.6980	(0) 1.1937
7.5	(0) 6.2486	(0) 4.0404	(0) 2.8977	(0) 2.2229	(0) 1.7172
8.0	(1) 1.0238	(0) 6.0432	(0) 3.9853	(0) 2.8940	(0) 2.2355
8.5	(1) 1.7863	(0) 9.7072	(0) 5.8691	(0) 3.9383	(0) 2.8916
9.0	(1) 3.2824	(1) 1.6587	(0) 9.2614	(0) 5.7197	(0) 3.8977
9.5	(1) 6.2966	(1) 2.9836	(1) 1.5529	(0) 8.8817	(0) 5.5902
10.0	(2) 1.2529	(1) 5.6013	(1) 2.7395	(1) 1.4638	(0) 8.5544
10.5	(2) 2.5735	(2) 1.0506	(1) 5.0429	(1) 2.5369	(1) 1.3878
11.0	(2) 5.4370	(2) 2.1519	(1) 9.6258	(1) 4.5863	(1) 2.3662
11.5	(3) 1.1780	(2) 4.5309	(2) 1.8964	(1) 8.5960	(1) 4.2071
12.0	(3) 2.6115	(2) 9.6654	(2) 3.8424	(2) 1.6627	(1) 7.7536
12.5	(3) 5.9114	(3) 2.0635	(2) 7.9840	(2) 3.3072	(2) 1.4744
13.0	(4) 1.3640	(3) 4.6148	(3) 1.6974	(2) 6.7457	(2) 2.8830
13.5	(4) 3.2036	(4) 1.0421	(3) 3.6852	(3) 1.4078	(2) 5.7803
14.0	(4) 7.6488	(4) 2.3953	(3) 8.1567	(3) 3.0002	(3) 1.1857
14.5	(5) 1.8544	(4) 5.5578	(4) 1.8380	(3) 6.5186	(3) 2.4836
15.0	(5) 4.5606	(5) 1.3286	(4) 4.2110	(4) 1.4419	(3) 5.3038
15.5	(6) 1.1368	(5) 3.1990	(4) 9.7988	(4) 3.2432	(4) 1.1531
16.0	(6) 2.8697	(5) 7.8082	(5) 2.3136	(4) 7.4095	(4) 2.5494
16.5	(6) 7.3309	(6) 1.9303	(5) 5.5378	(5) 1.7177	(4) 5.7251
17.0	(7) 1.8940	(6) 4.8301	(6) 1.3427	(5) 4.0372	(5) 1.3047
17.5	(7) 4.9456	(7) 1.2225	(6) 3.2955	(5) 9.6130	(5) 3.0146
18.0	(8) 1.3046	(7) 3.1276	(6) 8.1823	(6) 2.3172	(6) 7.0570
18.5	(8) 3.4746	(7) 8.0845	(7) 2.0539	(6) 5.6510	(6) 1.6726
19.0	(8) 9.3396	(8) 2.1103	(7) 5.2096	(7) 1.3934	(6) 4.0107
19.5	(9) 2.5325	(8) 5.5602	(8) 1.3345	(7) 3.4722	(6) 9.7253
20.0	(9) 6.9249	(9) 1.4781	(8) 3.4512	(7) 8.7394	(7) 2.3833
			$\frac{d}{d\rho} G_0(\eta, \rho)$		
0.5	(- 1) -1.9549	(- 1) +6.6972	(- 1) +9.7040	(- 1) +4.4173	(- 1) -4.6958
1.0	(- 1) -9.3312	(- 1) -7.2341	(- 2) +5.5060	(- 1) +7.9924	(- 1) +9.1053
1.5	(- 2) -3.0001	(- 1) -7.2415	(- 1) -9.1975	(- 1) -4.4998	(- 1) +3.6132
2.0	(- 1) +8.0730	(- 1) +2.8479	(- 1) -4.3994	(- 1) -8.9553	(- 1) -7.5330
2.5	(- 1) +7.2980	(- 1) +8.5982	(- 1) +5.0789	(- 1) -1.6218	(- 1) -7.5598
3.0	(- 1) +1.1621	(- 1) +6.2091	(- 1) +8.5795	(- 1) +6.5611	(- 2) +7.8968
3.5	(- 1) -4.4342	(- 2) +1.2156	(- 1) +5.1517	(- 1) +8.2450	(- 1) +7.4771
4.0	(- 1) -6.9211	(- 1) -4.8470	(- 2) -7.3596	(- 1) +4.1682	(- 1) +7.7350
4.5	(- 1) -6.7991	(- 1) -6.8955	(- 1) -5.1566	(- 1) -1.4460	(- 1) +3.2728
5.0	(- 1) -5.6855	(- 1) -6.6551	(- 1) -6.8530	(- 1) -5.3907	(- 1) -2.0374
5.5	(- 1) -5.0324	(- 1) -5.5663	(- 1) -6.5243	(- 1) -6.8002	(- 1) -5.5683
6.0	(- 1) -5.8597	(- 1) -4.9764	(- 1) -5.4972	(- 1) -6.4050	(- 1) -6.7414
6.5	(- 1) -9.1132	(- 1) -5.7431	(- 1) -4.9245	(- 1) -5.4165	(- 1) -6.2956
7.0	(0) -1.6356	(- 1) -8.7431	(- 1) -5.6396	(- 1) -4.8763	(- 1) -5.3428
7.5	(0) -3.0877	(0) -1.5360	(- 1) -8.4240	(- 1) -5.5466	(- 1) -4.8313
8.0	(0) -5.9776	(0) -2.8442	(0) -1.4516	(- 1) -8.1456	(- 1) -5.4626
8.5	(1) -1.1842	(0) -5.4029	(0) -2.6410	(0) -1.3790	(- 1) -7.9001
9.0	(1) -2.4038	(1) -1.0496	(0) -4.9315	(0) -2.4689	(0) -1.3159
9.5	(1) -5.0022	(1) -2.0879	(0) -9.4124	(0) -4.5385	(0) -2.3213
10.0	(2) -1.0663	(1) -4.2551	(1) -1.8382	(0) -8.5238	(0) -4.2061
10.5	(2) -2.3257	(1) -8.8802	(1) -3.6758	(1) -1.6369	(0) -7.7837
11.0	(2) -5.1822	(2) -1.8956	(1) -7.5239	(1) -3.2170	(1) -1.4720
11.5	(3) -1.1779	(2) -4.1335	(2) -1.5749	(1) -6.4688	(1) -2.8470
12.0	(3) -2.7275	(2) -9.1940	(2) -3.3666	(2) -1.3297	(1) -5.6316
12.5	(3) -6.4259	(3) -2.0833	(2) -7.3407	(2) -2.7912	(2) -1.1385
13.0	(4) -1.5386	(3) -4.8031	(3) -1.6305	(2) -5.9750	(2) -2.3496
13.5	(4) -3.7400	(4) -1.1255	(3) -3.6849	(3) -1.3029	(2) -4.9448
14.0	(4) -9.2211	(4) -2.6777	(3) -8.4644	(3) -2.8906	(3) -1.0599
14.5	(5) -2.3041	(4) -6.4624	(4) -1.9742	(3) -6.5183	(3) -2.3115
15.0	(5) -5.8301	(5) -1.5838	(4) -4.6712	(4) -1.4925	(3) -5.1233
15.5	(6) -1.4929	(5) -3.9163	(5) -1.1203	(4) -3.4670	(4) -1.1531
16.0	(6) -3.8658	(5) -9.8198	(5) -2.7217	(4) -8.1642	(4) -2.6329
16.5	(7) -1.0118	(6) -2.4904	(5) -6.6925	(5) -1.9474	(4) -6.0946
17.0	(7) -2.6753	(6) -6.3846	(6) -1.6647	(5) -4.7022	(5) -1.4291
17.5	(7) -7.1420	(7) -1.6537	(6) -4.1862	(6) -1.1486	(5) -3.3924
18.0	(8) -1.9243	(7) -4.3256	(7) -1.0637	(6) -2.8369	(5) -8.1473
18.5	(8) -5.2302	(8) -1.1421	(7) -2.7299	(6) -7.0806	(6) -1.9785
19.0	(9) -1.4335	(8) -3.0423	(7) -7.0724	(7) -1.7850	(6) -4.8557
19.5	(9) -3.9609	(8) -8.1738	(8) -1.8489	(7) -4.5433	(7) -1.2038
20.0	(10) -1.1028	(9) -2.2141	(8) -4.8757	(8) -1.1670	(7) -3.0133

Table 14.1 COULOMB WAVE FUNCTIONS OF ORDER ZERO

$\eta \backslash \rho$	16	17	$F_0(\eta, \rho)$	18	19	20
0.5	(0)+1.0105	(- 1)+6.6039	(- 1)-2.6356	(- 1)-9.5714	(- 1)-8.1320	
1.0	(- 1)-3.0813	(- 1)+6.1193	(0)+1.0298	(- 1)+5.9819	(- 1)-3.2923	
1.5	(0)-1.0106	(- 1)-8.5450	(- 2)-4.2659	(- 1)+8.0098	(0)+1.0154	
2.0	(- 1)+1.0271	(- 1)-7.4809	(0)-1.0610	(- 1)-6.0110	(- 1)+3.0159	
2.5	(0)+1.0681	(- 1)+5.2505	(- 1)-3.6504	(0)-1.0050	(- 1)-9.4813	
3.0	(- 1)+7.0689	(0)+1.1097	(- 1)+8.3235	(- 2)+3.2093	(- 1)-7.8654	
3.5	(- 1)-3.8460	(- 1)+4.6531	(0)+1.0517	(0)+1.0266	(- 1)+3.8780	
4.0	(0)-1.1328	(- 1)-6.0877	(- 1)+2.2016	(- 1)+9.2908	(0)+1.1240	
4.5	(0)-1.0557	(0)-1.1932	(- 1)-7.9196	(- 2)-1.3928	(- 1)+7.6776	
5.0	(- 1)-3.5128	(- 1)-9.8377	(0)-1.2226	(- 1)-9.3827	(- 1)-2.2935	
5.5	(- 1)+5.1503	(- 1)-2.3772	(- 1)-9.0447	(0)-1.2281	(0)-1.0524	
6.0	(0) 1.1748	(- 1)+6.0673	(- 1)-1.3066	(- 1)-8.2121	(0)-1.2155	
6.5	(0) 1.4845	(0) 1.2270	(- 1)+6.8982	(- 2)-3.0049	(- 1)-7.3630	
7.0	(0) 1.4802	(0) 1.5072	(0) 1.2736	(- 1)+7.6541	(- 2)+6.4345	
7.5	(0) 1.2778	(0) 1.4897	(0) 1.5276	(0) 1.3157	(- 1) 8.3446	
8.0	(- 1) 9.9567	(0) 1.2856	(0) 1.4986	(0) 1.5461	(0) 1.3538	
8.5	(- 1) 7.1674	(0) 1.0060	(0) 1.2930	(0) 1.5069	(0) 1.5630	
9.0	(- 1) 4.8384	(- 1) 7.2948	(0) 1.0159	(0) 1.3001	(0) 1.5147	
9.5	(- 1) 3.0947	(- 1) 4.9703	(- 1) 7.4157	(0) 1.0253	(0) 1.3070	
10.0	(- 1) 1.8899	(- 1) 3.2134	(- 1) 5.0960	(- 1) 7.5308	(0) 1.0343	
10.5	(- 1) 1.1084	(- 1) 1.9857	(- 1) 3.3276	(- 1) 5.2163	(- 1) 7.6406	
11.0	(- 2) 6.2723	(- 1) 1.1794	(- 1) 2.0789	(- 1) 3.4376	(- 1) 5.3315	
11.5	(- 2) 3.4374	(- 2) 6.7632	(- 1) 1.2493	(- 1) 2.1696	(- 1) 3.5437	
12.0	(- 2) 1.8300	(- 2) 3.7577	(- 2) 7.2527	(- 1) 1.3181	(- 1) 2.2578	
12.5	(- 3) 9.4892	(- 2) 2.0290	(- 2) 4.0816	(- 2) 7.7405	(- 1) 1.3858	
13.0	(- 3) 4.8032	(- 2) 1.0674	(- 2) 2.2331	(- 2) 4.4084	(- 2) 8.2258	
13.5	(- 3) 2.3779	(- 3) 5.4824	(- 2) 1.1907	(- 2) 2.4418	(- 2) 4.7375	
14.0	(- 3) 1.1532	(- 3) 2.7546	(- 3) 6.2000	(- 2) 1.3185	(- 2) 2.6546	
14.5	(- 4) 5.4870	(- 3) 1.3560	(- 3) 3.1586	(- 3) 6.9542	(- 2) 1.4504	
15.0	(- 4) 2.5646	(- 4) 6.5497	(- 3) 1.5768	(- 3) 3.5893	(- 3) 7.7433	
15.5	(- 4) 1.1789	(- 4) 3.1079	(- 4) 7.7245	(- 3) 1.8156	(- 3) 4.0459	
16.0	(- 5) 5.3346	(- 4) 1.4504	(- 4) 3.7177	(- 4) 9.0130	(- 3) 2.0721	
16.5	(- 5) 2.3787	(- 5) 6.6636	(- 4) 1.7598	(- 4) 4.3962	(- 3) 1.0416	
17.0	(- 5) 1.0460	(- 5) 3.0167	(- 5) 8.2016	(- 4) 2.1092	(- 4) 5.1452	
17.5	(- 6) 4.5399	(- 5) 1.3469	(- 5) 3.7665	(- 5) 9.9629	(- 4) 2.5000	
18.0	(- 6) 1.9459	(- 6) 5.9345	(- 5) 1.7058	(- 5) 4.6375	(- 4) 1.1961	
18.5	(- 7) 8.2424	(- 6) 2.5824	(- 6) 7.6243	(- 5) 2.1289	(- 5) 5.6392	
19.0	(- 7) 3.4522	(- 6) 1.1105	(- 6) 3.3654	(- 6) 9.6448	(- 5) 2.6221	
19.5	(- 7) 1.4304	(- 7) 4.7213	(- 6) 1.4679	(- 6) 4.3152	(- 5) 1.2032	
20.0	(- 8) 5.8668	(- 7) 1.9859	(- 7) 6.3305	(- 6) 1.9078	(- 6) 5.4529	
			$\frac{d}{d\rho} F_0(\eta, \rho)$			
0.5	(- 1)+1.0374	(- 1)-7.4873	(- 1)-9.5176	(- 1)-3.2396	(- 1)+5.8913	
1.0	(- 1)+9.2398	(- 1)+7.7918	(- 3)-6.9768	(- 1)-7.9198	(- 1)-9.2215	
1.5	(- 1)-2.6352	(- 1)+5.5592	(- 1)+9.5486	(- 1)+6.1234	(- 1)-2.1544	
2.0	(- 1)-9.2711	(- 1)-6.6487	(- 2)+8.1839	(- 1)+7.7886	(- 1)+9.0561	
2.5	(- 1)-2.1794	(- 1)-8.0683	(- 1)-8.6636	(- 1)-3.3293	(- 1)+4.4171	
3.0	(- 1)+6.8521	(- 2)+7.3796	(- 1)-6.0115	(- 1)-9.0956	(- 1)-6.3111	
3.5	(- 1)+8.2181	(- 1)+7.9551	(- 1)+3.1511	(- 1)-3.6640	(- 1)-8.4454	
4.0	(- 1)+2.6981	(- 1)+7.3722	(- 1)+8.4585	(- 1)+5.0199	(- 1)-1.3528	
4.5	(- 1)-3.9491	(- 1)+1.3669	(- 1)+6.3816	(- 1)+8.5260	(- 1)+6.3846	
5.0	(- 1)-7.4641	(- 1)-4.7259	(- 2)+1.8327	(- 1)+5.3380	(- 1)+8.2868	
5.5	(- 1)-7.0977	(- 1)-7.5469	(- 1)-5.3380	(- 2)-8.5571	(- 1)+4.2976	
6.0	(- 1)-4.3534	(- 1)-6.8162	(- 1)-7.5595	(- 1)-5.8167	(- 1)-1.7601	
6.5	(- 1)-1.1279	(- 1)-4.0420	(- 1)-6.5393	(- 1)-7.5212	(- 1)-6.1873	
7.0	(- 1)+1.3471	(- 2)-9.4232	(- 1)-3.7584	(- 1)-6.2703	(- 1)-7.4462	
7.5	(- 1) 2.6755	(- 1)+1.4020	(- 2)-7.7728	(- 1)-3.4994	(- 1)-6.0113	
8.0	(- 1) 3.0148	(- 1) 2.6574	(- 1)+1.4497	(- 2)-6.2964	(- 1)-3.2623	
8.5	(- 1) 2.7316	(- 1) 2.9796	(- 1) 2.6401	(- 1)+1.4915	(- 2)-4.9686	
9.0	(- 1) 2.1740	(- 1) 2.7098	(- 1) 2.9470	(- 1) 2.6235	(- 1)+1.5282	
9.5	(- 1) 1.5790	(- 1) 2.1730	(- 1) 2.6893	(- 1) 2.9166	(- 1) 2.6076	
10.0	(- 1) 1.0690	(- 1) 1.5938	(- 1) 2.1715	(- 1) 2.6698	(- 1) 2.8881	
10.5	(- 2) 6.8361	(- 1) 1.0912	(- 1) 1.6072	(- 1) 2.1696	(- 1) 2.6513	
11.0	(- 2) 4.1667	(- 2) 7.0640	(- 1) 1.1118	(- 1) 1.6191	(- 1) 2.1673	
11.5	(- 2) 2.4370	(- 2) 4.3620	(- 2) 7.2792	(- 1) 1.1309	(- 1) 1.6300	
12.0	(- 2) 1.3747	(- 2) 2.5860	(- 2) 4.5494	(- 2) 7.4828	(- 1) 1.1487	
12.5	(- 3) 7.5088	(- 2) 1.4792	(- 2) 2.7313	(- 2) 4.7295	(- 2) 7.6757	
13.0	(- 3) 3.9846	(- 3) 8.1964	(- 2) 1.5829	(- 2) 2.8730	(- 2) 4.9026	
13.5	(- 3) 2.0598	(- 3) 4.4133	(- 3) 8.8884	(- 2) 1.6854	(- 2) 3.0112	
14.0	(- 3) 1.0396	(- 3) 2.3153	(- 3) 4.8514	(- 3) 9.5832	(- 2) 1.7867	
14.5	(- 4) 5.1328	(- 3) 1.1861	(- 3) 2.5805	(- 3) 5.2978	(- 2) 1.0279	
15.0	(- 4) 2.4832	(- 4) 5.9443	(- 3) 1.3405	(- 3) 2.8547	(- 3) 5.7512	
15.5	(- 4) 1.1789	(- 4) 2.9194	(- 4) 6.8135	(- 3) 1.5025	(- 3) 3.1370	
16.0	(- 5) 5.4992	(- 4) 1.4071	(- 4) 3.3940	(- 4) 7.7388	(- 3) 1.6717	
16.5	(- 5) 2.5233	(- 5) 6.6637	(- 4) 1.6592	(- 4) 3.9067	(- 4) 8.7182	
17.0	(- 5) 1.1401	(- 5) 3.1043	(- 5) 7.9706	(- 4) 1.9356	(- 4) 4.4568	
17.5	(- 6) 5.0769	(- 5) 1.4240	(- 5) 3.7665	(- 5) 9.4242	(- 4) 2.2364	
18.0	(- 6) 2.2330	(- 6) 6.4378	(- 5) 1.7526	(- 5) 4.5139	(- 4) 1.1028	
18.5	(- 7) 9.6688	(- 6) 2.8708	(- 6) 8.0374	(- 5) 2.1289	(- 5) 5.3499	
19.0	(- 7) 4.1409	(- 6) 1.2636	(- 6) 3.6355	(- 6) 9.8957	(- 5) 2.5557	
19.5	(- 7) 1.7529	(- 7) 5.4935	(- 6) 1.6231	(- 6) 4.5369	(- 5) 1.2033	
20.0	(- 8) 7.3379	(- 7) 2.3605	(- 7) 7.1576	(- 6) 2.0531	(- 6) 5.5878	

COULOMB WAVE FUNCTIONS OF ORDER ZERO

Table 14.1

$\eta \setminus \rho$	16	17	$G_0(\eta, \rho)$	18	19	20
0.5	(-1)+1.0821	(-1)-7.7111	(-1)-9.7953	(-1)-3.3354	(-1)+6.0387	
1.0	(-1)+9.8687	(-1)+8.3065	(-3)-5.5146	(-1)-8.3622	(-1)-9.7243	
1.5	(-1)-2.9626	(-1)+6.0950	0)+1.0457	(-1)+6.6931	(-1)-2.3123	
2.0	0)-1.0694	(-1)-7.6383	(-2)+8.8035	(-1)+8.7398	0)+1.0133	
2.5	(-1)-2.5363	(-1)-9.5594	0)-1.0212	(-1)-3.9315	(-1)+5.0534	
3.0	(-1)+8.7388	(-1)+1.0254	(-1)-7.2872	0)-1.0987	(-1)-7.5896	
3.5	0)+1.0876	0)+1.0419	(-1)+4.1434	(-1)-4.5088	0)-1.0436	
4.0	(-1)+3.5629	0)+1.0004	0)+1.1362	(-1)+6.7042	(-1)-1.6256	
4.5	(-1)-6.2482	(-1)+1.7088	(-1)+8.8526	0)+1.1729	(-1)+8.7013	
5.0	0)-1.2237	(-1)-7.6338	(-3)-3.2476	(-1)+7.5425	0)+1.1657	
5.5	(0)-1.2251	(0)-1.2701	(-1)-8.8135	(-1)-1.6427	(-1)+6.1562	
6.0	(-1)-7.5801	0)-1.2045	0)-1.3038	(-1)-9.8158	(-1)-3.1172	
6.5	(-2)-7.4816	(-1)-7.1189	0)-1.1808	0)-1.3275	0)-1.0666	
7.0	(-1)+6.1662	(-2)-3.0805	(-1)-6.6763	0)-1.1549	0)-1.3430	
7.5	0) 1.2182	(-1)+6.4936	(-2)+1.0458	(-1)-6.2518	0)-1.1277	
8.0	0) 1.7353	0) 1.2413	(-1) 6.8010	(-2)+4.9276	(-1)-5.8448	
8.5	0) 2.2476	0) 1.7525	0) 1.2631	(-1) 7.0906	(-2)+8.5910	
9.0	0) 2.8903	0) 2.2593	0) 1.7689	0) 1.2839	(-1) 7.3645	
9.5	0) 3.8625	0) 2.8897	0) 2.2705	0) 1.7846	0) 1.3037	
10.0	0) 5.4768	0) 3.8316	0) 2.8898	0) 2.2814	0) 1.7997	
10.5	(0) 8.2695	(0) 5.3768	(0) 3.8044	(0) 2.8904	(0) 2.2919	
11.0	(1) 1.3223	(0) 8.0173	(0) 5.2879	(0) 3.7803	(0) 2.8915	
11.5	(1) 2.2207	(1) 1.2652	(0) 7.7978	(0) 5.2085	(0) 3.7589	
12.0	(1) 3.8880	(1) 2.0953	(1) 1.2151	(0) 7.6004	(0) 5.1370	
12.5	(1) 7.0544	(1) 3.6153	(1) 1.9863	(1) 1.1707	(0) 7.4234	
13.0	(2) 1.3205	(1) 6.4666	(1) 3.3826	(1) 1.8906	(1) 1.1312	
13.5	(2) 2.5411	(2) 1.1927	(1) 5.9669	(1) 3.1797	(1) 1.8061	
14.0	(2) 5.0139	(2) 2.2615	(2) 1.0855	(1) 5.5380	(1) 3.0021	
14.5	(3) 1.0121	(2) 4.3958	(2) 2.0297	(1) 9.9453	(1) 5.1664	
15.0	(3) 2.0860	(2) 8.7404	(2) 3.8903	(2) 1.8354	(1) 9.1659	
15.5	(3) 4.3833	(3) 1.7745	(2) 7.6267	(2) 3.4717	(2) 1.6708	
16.0	(3) 9.3774	(3) 3.6727	(3) 1.5265	(2) 6.7162	(2) 3.1213	
16.5	(4) 2.0400	(3) 7.7388	(3) 3.1148	(3) 1.3264	(2) 5.9630	
17.0	(4) 4.5079	(4) 1.6582	(3) 6.4702	(3) 2.6703	(3) 1.1629	
17.5	(5) 1.0109	(4) 3.6090	(4) 1.3667	(3) 5.4726	(3) 2.3115	
18.0	(5) 2.2987	(4) 7.9717	(4) 2.9323	(4) 1.1404	(3) 4.6772	
18.5	(5) 5.2957	(5) 1.7855	(4) 6.3851	(4) 2.4141	(3) 9.6229	
19.0	(6) 1.2353	(5) 4.0519	(5) 1.4098	(4) 5.1860	(4) 2.0110	
19.5	(6) 2.9156	(5) 9.3105	(5) 3.1542	(5) 1.1297	(4) 4.2650	
20.0	(6) 6.9590	(6) 2.1648	(5) 7.1454	(5) 2.4935	(4) 9.1723	
$d G_0(\eta, \rho)$						
0.5	(-1)-9.7855	(-1)-6.4000	(-1)+2.5695	(-1)+9.3189	(-1)+7.9224	
1.0	(-1)+2.8609	(-1)-5.7650	(-1)-9.7102	(-1)-5.6460	(-1)+3.1370	
1.5	(-1)+9.1227	(-1)+7.7374	(-2)+3.6067	(-1)-7.3679	(-1)-9.3578	
2.0	(-2)-8.3491	(-1)+6.5767	(-1)+9.3570	(-1)+5.3119	(-1)-2.7296	
2.5	(-1)-8.8452	(-1)-4.3562	(-1)+3.1578	(-1)+8.6483	(-1)+8.1928	
3.0	(-1)-5.6757	(-1)-8.9431	(-1)-6.7512	(-2)-1.9960	(-1)+6.6241	
3.5	(-1)+2.7609	(-1)-3.6790	(-1)-8.2667	(-1)-8.1315	(-1)-3.0592	
4.0	(-1)+7.9794	(-1)+4.3113	(-1)-1.7673	(-1)-7.1410	(-1)-8.7013	
4.5	(-1)+7.1352	(-1)+8.1848	(-1)+5.4934	(-3)-3.4829	(-1)-5.7890	
5.0	(-1)+2.4665	(-1)+6.4978	(-1)+8.1799	(-1)+6.3669	(-1)+1.4822	
5.5	(-1)-2.5327	(-1)+1.7444	(-1)+5.8546	(-1)+8.0282	(-1)+6.9880	
6.0	(-1)-5.7031	(-1)-2.9499	(-1)+1.0993	(-1)+5.2246	(-1)+7.7756	
6.5	(-1)-6.6792	(-1)-5.8050	(-1)-3.3031	(-2)+5.2317	(-1)+4.6186	
7.0	(-1)-6.1949	(-1)-6.6155	(-1)-5.8814	(-1)-3.6035	(-4)+8.3738	
7.5	(-1)-5.2752	(-1)-6.1017	(-1)-6.5515	(-1)-5.9378	(-1)-3.8601	
8.0	(-1)-4.7892	(-1)-5.2127	(-1)-6.0151	(-1)-6.4880	(-1)-5.9783	
8.5	(-1)-5.3860	(-1)-4.7495	(-1)-5.1547	(-1)-5.9344	(-1)-6.4254	
9.0	(-1)-7.6818	(-1)-5.3157	(-1)-4.7121	(-1)-5.1007	(-1)-5.8590	
9.5	0)-1.2605	(-1)-7.4860	(-1)-5.2509	(-1)-4.6767	(-1)-5.0502	
10.0	0)-2.1932	0)-1.2115	(-1)-7.3093	(-1)-5.1908	(-1)-4.6431	
10.5	(0)-3.9217	(0)-2.0812	(0)-1.1677	(-1)-7.1488	(-1)-5.1349	
11.0	(0)-7.1592	(0)-3.6757	(0)-1.9822	(0)-1.1284	(-1)-7.0023	
11.5	(1)-1.3348	(0)-6.6261	(0)-3.4609	(0)-1.8942	(0)-1.0929	
12.0	(1)-2.5439	(1)-1.2193	(0)-6.1663	(0)-3.2719	(0)-1.8154	
12.5	(1)-4.9562	(1)-2.2921	(1)-1.1209	(0)-5.7662	(0)-3.1044	
13.0	(1)-9.8652	(1)-4.4031	(1)-2.0805	(1)-1.0363	(0)-5.4152	
13.5	(2)-2.0042	(1)-8.6387	(1)-3.9443	(1)-1.9007	(0)-9.6285	
14.0	(2)-4.1515	(2)-1.7295	(1)-7.6350	(1)-3.5594	(1)-1.7465	
14.5	(2)-8.7576	(2)-3.5297	(2)-1.5077	(1)-6.8033	(1)-3.2330	
15.0	(3)-1.8795	(2)-7.3354	(2)-3.0346	(2)-1.3263	(1)-6.1066	
15.5	(3)-4.0993	(3)-1.5507	(2)-6.2186	(2)-2.6348	(2)-1.1761	
16.0	(3)-9.0788	(3)-3.3317	(3)-1.2962	(2)-5.3284	(2)-2.3079	
16.5	(4)-2.0399	(3)-7.2680	(3)-2.7456	(3)-1.0960	(2)-4.6095	
17.0	(4)-4.6466	(4)-1.6085	(3)-5.9047	(3)-2.2906	(2)-9.3627	
17.5	(5)-1.0722	(4)-3.6089	(4)-1.2883	(3)-4.8605	(3)-1.9322	
18.0	(5)-2.5048	(4)-8.2028	(4)-2.8495	(4)-1.0463	(3)-4.0483	
18.5	(5)-5.9202	(5)-1.8875	(4)-6.3850	(4)-2.2832	(3)-8.6039	
19.0	(6)-1.4150	(5)-4.3947	(5)-1.4484	(4)-5.0474	(4)-1.8537	
19.5	(6)-3.4181	(6)-1.0347	(5)-3.3247	(5)-1.1297	(4)-4.0457	
20.0	(6)-8.3412	(6)-2.4624	(5)-7.7176	(5)-2.5583	(4)-8.9396	

Table 14.2

$$C_0(\eta) = e^{-\frac{1}{2}\pi\eta} |\Gamma(1+i\eta)|$$

η	$C_0(\eta)$	η	$C_0(\eta)$	η	$C_0(\eta)$
0.00	1.000000	1.00	(-1) 1.08423	2.00	(-3) 6.61992
0.05	0.922568	1.05	(-2) 9.49261	2.05	(-3) 5.72791
0.10	0.847659	1.10	(-2) 8.30211	2.10	(-3) 4.95461
0.15	0.775700	1.15	(-2) 7.25378	2.15	(-3) 4.28450
0.20	0.707063	1.20	(-2) 6.33205	2.20	(-3) 3.70402
0.25	0.642052	1.25	(-2) 5.52279	2.25	(-3) 3.20136
0.30	0.580895	1.30	(-2) 4.81320	2.30	(-3) 2.76623
0.35	0.523742	1.35	(-2) 4.19173	2.35	(-3) 2.38968
0.40	0.470665	1.40	(-2) 3.64804	2.40	(-3) 2.06392
0.45	0.421667	1.45	(-2) 3.17287	2.45	(-3) 1.78218
0.50	0.376686	1.50	(-2) 2.75796	2.50	(-3) 1.53858
0.55	0.335605	1.55	(-2) 2.39599	2.55	(-3) 1.32801
0.60	0.298267	1.60	(-2) 2.08045	2.60	(-3) 1.14604
0.65	0.264478	1.65	(-2) 1.80558	2.65	(-4) 9.88816
0.70	0.234025	1.70	(-2) 1.56632	2.70	(-4) 8.53013
0.75	0.206680	1.75	(-2) 1.35817	2.75	(-4) 7.35735
0.80	0.182206	1.80	(-2) 1.17720	2.80	(-4) 6.34476
0.85	0.160370	1.85	(-2) 1.01996	2.85	(-4) 5.47066
0.90	0.140940	1.90	(-3) 8.83391	2.90	(-4) 4.71626
0.95	0.123694	1.95	(-3) 7.64847	2.95	(-4) 4.06528
1.00	0.108423	2.00	(-3) 6.61992	3.00	(-4) 3.50366
	$\left[\begin{smallmatrix} (-4)5 \\ 5 \end{smallmatrix} \right]$				

For $\ln \Gamma(1+iy)$, see Table 6.7.

15. Hypergeometric Functions

FRITZ OBERHETTINGER¹

Contents

	Page
Mathematical Properties	556
15.1. Gauss Series, Special Elementary Cases, Special Values of the Argument	556
15.2. Differentiation Formulas and Gauss' Relations for Contiguous Functions.	557
15.3. Integral Representations and Transformation Formulas . . .	558
15.4. Special Cases of $F(a, b; c; z)$, Polynomials and Legendre Functions.	561
15.5. The Hypergeometric Differential Equation	562
15.6. Riemann's Differential Equation	564
15.7. Asymptotic Expansions	565
References	565

¹ National Bureau of Standards. (Presently, Oregon State University, Corvallis, Oregon.)

15. Hypergeometric Functions

Mathematical Properties

15.1. Gauss Series, Special Elementary Cases, Special Values of the Argument

Gauss Series

The circle of convergence of the Gauss hypergeometric series

15.1.1

$$F(a, b; c; z) = {}_2F_1(a, b; c; z)$$

$$= F(b, a; c; z) = \sum_{n=0}^{\infty} \frac{(a)_n (b)_n}{(c)_n} \frac{z^n}{n!}$$

$$= \frac{\Gamma(c)}{\Gamma(a)\Gamma(b)} \sum_{n=0}^{\infty} \frac{\Gamma(a+n)\Gamma(b+n)}{\Gamma(c+n)} \frac{z^n}{n!}$$

is the unit circle $|z|=1$. The behavior of this series on its circle of convergence is:

- (a) Divergence when $\Re(c-a-b) \leq -1$.
- (b) Absolute convergence when $\Re(c-a-b) > 0$.
- (c) Conditional convergence when $-1 < \Re(c-a-b) \leq 0$; the point $z=1$ is excluded. The Gauss series reduces to a polynomial of degree n in z when a or b is equal to $-n$, ($n=0, 1, 2, \dots$). (For these cases see also 15.4.) The series 15.1.1 is not defined when c is equal to $-m$, ($m=0, 1, 2, \dots$), provided a or b is not a negative integer n with $n < m$. For $c = -m$

15.1.2

$$\lim_{c \rightarrow -m} \frac{1}{\Gamma(c)} F(a, b; c; z) =$$

$$\frac{(a)_{m+1} (b)_{m+1}}{(m+1)!} z^{m+1} F(a+m+1, b+m+1; m+2; z)$$

Special Elementary Cases of Gauss Series

(For cases involving higher functions see 15.4.)

$$15.1.3 \quad F(1, 1; 2; z) = -z^{-1} \ln(1-z) *$$

$$15.1.4 \quad F\left(\frac{1}{2}, 1; \frac{3}{2}; z^2\right) = \frac{1}{2} z^{-1} \ln\left(\frac{1+z}{1-z}\right)$$

$$15.1.5 \quad F\left(\frac{1}{2}, 1; \frac{3}{2}; -z^2\right) = z^{-1} \arctan z$$

15.1.6

$$F\left(\frac{1}{2}, \frac{1}{2}; \frac{3}{2}; z^2\right) = (1-z^2)^{-\frac{1}{2}} F(1, 1; \frac{3}{2}; z^2) = z^{-1} \arcsin z$$

15.1.7

$$F\left(\frac{1}{2}, \frac{1}{2}; \frac{3}{2}; -z^2\right) = (1+z^2)^{-\frac{1}{2}} F(1, 1; \frac{3}{2}; -z^2) \\ = z^{-1} \ln[z + (1+z^2)^{\frac{1}{2}}]$$

$$15.1.8 \quad F(a, b; b; z) = (1-z)^{-a}$$

$$15.1.9 \quad F(a, \frac{1}{2}+a; \frac{1}{2}; z^2) = \frac{1}{2} [(1+z)^{-2a} + (1-z)^{-2a}]$$

15.1.10

$$F(a, \frac{1}{2}+a; \frac{3}{2}; z^2) = \\ \frac{1}{2} z^{-1} (1-2a)^{-1} [(1+z)^{1-2a} - (1-z)^{1-2a}]$$

15.1.11

$$F(-a, a; \frac{1}{2}; -z^2) = \frac{1}{2} \{ [(1+z^2)^{\frac{1}{2}} + z]^{2a} + [(1+z^2)^{\frac{1}{2}} - z]^{2a} \}$$

15.1.12

$$F(a, 1-a; \frac{1}{2}; -z^2) = \\ \frac{1}{2} (1+z^2)^{-\frac{1}{2}} \{ [(1+z^2)^{\frac{1}{2}} + z]^{2a-1} + [(1+z^2)^{\frac{1}{2}} - z]^{2a-1} \}$$

15.1.13

$$F(a, \frac{1}{2}+a; 1+2a; z) = 2^{2a} [1 + (1-z)^{\frac{1}{2}}]^{-2a} \\ = (1-z)^{\frac{1}{2}} F(1+a, \frac{1}{2}+a; 1+2a; z)$$

15.1.14

$$F(a, \frac{1}{2}+a; 2a; z) = 2^{2a-1} (1-z)^{-\frac{1}{2}} [1 + (1-z)^{\frac{1}{2}}]^{1-2a}$$

$$15.1.15 \quad F(a, 1-a; \frac{3}{2}; \sin^2 z) = \frac{\sin[(2a-1)z]}{(2a-1) \sin z}$$

$$15.1.16 \quad F(a, 2-a; \frac{3}{2}; \sin^2 z) = \frac{\sin[(2a-2)z]}{(a-1) \sin(2z)}$$

$$15.1.17 \quad F(-a, a; \frac{1}{2}; \sin^2 z) = \cos(2az)$$

$$15.1.18 \quad F(a, 1-a; \frac{1}{2}; \sin^2 z) = \frac{\cos[(2a-1)z]}{\cos z}$$

$$15.1.19 \quad F(a, \frac{1}{2}+a; \frac{1}{2}; -\tan^2 z) = \cos^{2a} z \cos(2az)$$

Special Values of the Argument

15.1.20

$$F(a, b; c; 1) = \frac{\Gamma(c)\Gamma(c-a-b)}{\Gamma(c-a)\Gamma(c-b)}$$

$$(c \neq 0, -1, -2, \dots, \Re(c-a-b) > 0)$$

*See page II.

15.1.21

$$F(a, b; a-b+1; -1) = 2^{-a} \pi^{\frac{1}{2}} \frac{\Gamma(1+a-b)}{\Gamma(1+\frac{1}{2}a-b)\Gamma(\frac{1}{2}+\frac{1}{2}a)}$$

(1+a-b ≠ 0, -1, -2, ...)

15.1.22

$$F(a, b; a-b+2; -1) = 2^{-a} \pi^{1/2} (b-1)^{-1} \Gamma(a-b+2)$$

$$\left[\frac{1}{\Gamma(\frac{1}{2}a)\Gamma(\frac{3}{2}+\frac{1}{2}a-b)} - \frac{1}{\Gamma(\frac{1}{2}+\frac{1}{2}a)\Gamma(1+\frac{1}{2}a-b)} \right]$$

(a-b+2 ≠ 0, -1, -2, ...)

15.1.23 $F(1, a; a+1; -1) = \frac{1}{2}a[\psi(\frac{1}{2}+\frac{1}{2}a) - \psi(\frac{1}{2}a)]$

15.1.24

$$F(a, b; \frac{1}{2}a+\frac{1}{2}b+\frac{1}{2}; \frac{1}{2}) = \pi^{\frac{1}{2}} \frac{\Gamma(\frac{1}{2}+\frac{1}{2}a+\frac{1}{2}b)}{\Gamma(\frac{1}{2}+\frac{1}{2}a)\Gamma(\frac{1}{2}+\frac{1}{2}b)}$$

(\frac{1}{2}a+\frac{1}{2}b+\frac{1}{2} ≠ 0, -1, -2, ...)

15.1.25

$$F(a, b; \frac{1}{2}a+\frac{1}{2}b+1; \frac{1}{2}) = 2\pi^{\frac{1}{2}}(a-b)^{-1} \Gamma(1+\frac{1}{2}a+\frac{1}{2}b)$$

$$\{[\Gamma(\frac{1}{2}a)\Gamma(\frac{1}{2}+\frac{1}{2}b)]^{-1} - [\Gamma(\frac{1}{2}+\frac{1}{2}a)\Gamma(\frac{1}{2}b)]^{-1}\}$$

(\frac{1}{2}(a+b)+1 ≠ 0, -1, -2, ...)

15.1.26

$$F(a, 1-a; b; \frac{1}{2}) = 2^{1-b} \pi^{\frac{1}{2}} \Gamma(b) [\Gamma(\frac{1}{2}a+\frac{1}{2}b) \Gamma(\frac{1}{2}+\frac{1}{2}b-\frac{1}{2}a)]^{-1}$$

(b ≠ 0, -1, -2, ...)

15.1.27

$$F(1, 1; a+1; \frac{1}{2}) = a[\psi(\frac{1}{2}+\frac{1}{2}a) - \psi(\frac{1}{2}a)]$$

(a ≠ -1, -2, -3, ...)

15.1.28

$$F(a, a; a+1; \frac{1}{2}) = 2^{a-1} a [\psi(\frac{1}{2}+\frac{1}{2}a) - \psi(\frac{1}{2}a)]$$

(a ≠ -1, -2, -3, ...)

15.1.29

$$F(a, \frac{1}{2}+a; \frac{3}{2}-2a; -\frac{1}{2}) = (\frac{3}{2})^{-2a} \frac{\Gamma(\frac{1}{2})\Gamma(\frac{3}{2}-2a)}{\Gamma(\frac{3}{2})\Gamma(\frac{1}{2}-2a)}$$

(\frac{3}{2}-2a ≠ 0, -1, -2, ...)

15.1.30

$$F(a, \frac{1}{2}+a; \frac{5}{2}+a; \frac{1}{2}) = (\frac{5}{2})^a \pi^{\frac{1}{2}} \frac{\Gamma(\frac{5}{2}+\frac{2}{3}a)}{\Gamma(\frac{1}{2}+\frac{1}{3}a)\Gamma(\frac{5}{6}+\frac{1}{3}a)}$$

(\frac{5}{6}+\frac{2}{3}a ≠ 0, -1, -2, ...)

15.1.31

$$F(a, \frac{1}{3}a+\frac{1}{3}; \frac{2}{3}a+\frac{2}{3}; e^{i\pi/3})$$

$$= 2^{\frac{2}{3}a+\frac{2}{3}} \pi^{\frac{1}{2}} 3^{-\frac{1}{2}(a+1)} e^{i\pi a/6} \frac{\Gamma(\frac{1}{3}a+\frac{2}{3})}{\Gamma(\frac{1}{3}a+\frac{2}{3})\Gamma(\frac{2}{3})}$$

(\frac{1}{3}a ≠ -\frac{2}{3}, -\frac{1}{3}, -\frac{1}{6}, ...)

15.2. Differentiation Formulas and Gauss' Relations for Contiguous Functions

Differentiation Formulas

15.2.1 $\frac{d}{dz} F(a, b; c; z) = \frac{ab}{c} F(a+1, b+1; c+1; z)$

15.2.2

$$\frac{d^n}{dz^n} F(a, b; c; z) = \frac{(a)_n (b)_n}{(c)_n} F(a+n, b+n; c+n; z)$$

15.2.3

$$\frac{d^n}{dz^n} [z^{a+n-1} F(a, b; c; z)] = (a)_n z^{a-1} F(a+n, b; c; z)$$

15.2.4

$$\frac{d^n}{dz^n} [z^{c-1} F(a, b; c; z)] = (c-n)_n z^{c-n-1} F(a, b; c-n; z)$$

15.2.5

$$\frac{d^n}{dz^n} [z^{c-a+n-1} (1-z)^{a+b-c} F(a, b; c; z)]$$

$$= (c-a)_n z^{c-a-1} (1-z)^{a+b-c-n} F(a-n, b; c; z)$$

15.2.6

$$\frac{d^n}{dz^n} [(1-z)^{a+b-c} F(a, b; c; z)]$$

$$= \frac{(c-a)_n (c-b)_n}{(c)_n} (1-z)^{a+b-c-n} F(a, b; c+n; z)$$

15.2.7

$$\frac{d^n}{dz^n} [(1-z)^{a+n-1} F(a, b; c; z)]$$

$$= \frac{(-1)^n (a)_n (c-b)_n}{(c)_n} (1-z)^{a-1} F(a+n, b; c+n; z)$$

15.2.8

$$\frac{d^n}{dz^n} [z^{c-1} (1-z)^{b-c+n} F(a, b; c; z)]$$

$$= (c-n)_n z^{c-n-1} (1-z)^{b-c} F(a-n, b; c-n; z)$$

15.2.9

$$\frac{d^n}{dz^n} [z^{c-1} (1-z)^{a+b-c} F(a, b; c; z)]$$

$$= (c-n)_n z^{c-n-1} (1-z)^{a+b-c-n} F(a-n, b-n; c-n; z)$$

Gauss' Relations for Contiguous Functions

The six functions $F(a \pm 1, b; c; z)$, $F(a, b \pm 1; c; z)$, $F(a, b; c \pm 1; z)$ are called contiguous to $F(a, b; c; z)$. Relations between $F(a, b; c; z)$ and

any two contiguous functions have been given by Gauss. By repeated application of these relations the function $F(a+m, b+n; c+l; z)$ with integral $m, n, l (c+l \neq 0, -1, -2, \dots)$ can be expressed as a linear combination of $F(a, b; c; z)$ and one of its contiguous functions with coefficients which are rational functions of a, b, c, z .

15.2.10

$$(c-a)F(a-1, b; c; z) + (2a-c-az+bz)F(a, b; c; z) \\ + a(z-1)F(a+1, b; c; z) = 0$$

15.2.11

$$(c-b)F(a, b-1; c; z) + (2b-c-bz+az)F(a, b; c; z) \\ + b(z-1)F(a, b+1; c; z) = 0$$

15.2.12

$$c(c-1)(z-1)F(a, b; c-1; z) \\ + c[c-1-(2c-a-b-1)z]F(a, b; c; z) \\ + (c-a)(c-b)zF(a, b; c+1; z) = 0$$

15.2.13

$$[c-2a-(b-a)z]F(a, b; c; z) \\ + a(1-z)F(a+1, b; c; z) \\ - (c-a)F(a-1, b; c; z) = 0$$

15.2.14

$$(b-a)F(a, b; c; z) + aF(a+1, b; c; z) \\ - bF(a, b+1; c; z) = 0$$

15.2.15

$$(c-a-b)F(a, b; c; z) + a(1-z)F(a+1, b; c; z) \\ - (c-b)F(a, b-1; c; z) = 0$$

15.2.16

$$c[a-(c-b)z]F(a, b; c; z) - ac(1-z)F(a+1, b; c; z) \\ + (c-a)(c-b)zF(a, b; c+1; z) = 0$$

15.2.17

$$(c-a-1)F(a, b; c; z) + aF(a+1, b; c; z) \\ - (c-1)F(a, b; c-1; z) = 0$$

15.2.18

$$(c-a-b)F(a, b; c; z) - (c-a)F(a-1, b; c; z) \\ + b(1-z)F(a, b+1; c; z) = 0$$

15.2.19

$$(b-a)(1-z)F(a, b; c; z) - (c-a)F(a-1, b; c; z) \\ + (c-b)F(a, b-1; c; z) = 0$$

15.2.20

$$c(1-z)F(a, b; c; z) - cF(a-1, b; c; z) \\ + (c-b)zF(a, b; c+1; z) = 0$$

15.2.21

$$[a-1-(c-b-1)z]F(a, b; c; z) \\ + (c-a)F(a-1, b; c; z) \\ - (c-1)(1-z)F(a, b; c-1; z) = 0$$

15.2.22

$$[c-2b+(b-a)z]F(a, b; c; z) \\ + b(1-z)F(a, b+1; c; z) \\ - (c-b)F(a, b-1; c; z) = 0$$

15.2.23

$$c[b-(c-a)z]F(a, b; c; z) - bc(1-z)F(a, b+1; c; z) \\ + (c-a)(c-b)zF(a, b; c+1; z) = 0$$

15.2.24

$$(c-b-1)F(a, b; c; z) + bF(a, b+1; c; z) \\ - (c-1)F(a, b; c-1; z) = 0$$

15.2.25

$$c(1-z)F(a, b; c; z) - cF(a, b-1; c; z) \\ * + (c-a)zF(a, b; c+1; z) = 0$$

15.2.26

$$[b-1-(c-a-1)z]F(a, b; c; z) \\ + (c-b)F(a, b-1; c; z) \\ - (c-1)(1-z)F(a, b; c-1; z) = 0$$

15.2.27

$$c[c-1-(2c-a-b-1)z]F(a, b; c; z) \\ + (c-a)(c-b)zF(a, b; c+1; z) \\ - c(c-1)(1-z)F(a, b; c-1; z) = 0$$

15.3. Integral Representations and Transformation Formulas**Integral Representations****15.3.1**

$$F(a, b; c; z) = \\ \frac{\Gamma(c)}{\Gamma(b)\Gamma(c-b)} \int_0^1 t^{b-1}(1-t)^{c-b-1}(1-tz)^{-a} dt \\ (\Re c > \Re b > 0)$$

The integral represents a one valued analytic function in the z -plane cut along the real axis from 1 to ∞ and hence 15.3.1 gives the analytic continuation of 15.1.1, $F(a, b; c; z)$. Another integral representation is in the form of a Mellin-Barnes integral

$$15.3.2 \quad F(a, b; c; z) = \frac{\Gamma(c)}{2\pi i \Gamma(a)\Gamma(b)} \int_{-i\infty}^{i\infty} \frac{\Gamma(a+s)\Gamma(b+s)\Gamma(-s)}{\Gamma(c+s)} (-z)^s ds$$

$$= \frac{1}{2}i \frac{\Gamma(c)}{\Gamma(a)\Gamma(b)} \int_{-i\infty}^{i\infty} \frac{\Gamma(a+s)\Gamma(b+s)}{\Gamma(1+s)\Gamma(c+s)} \csc(\pi s) (-z)^s ds$$

Here $-\pi < \arg(-z) < \pi$ and the path of integration is chosen such that the poles of $\Gamma(a+s)$ and $\Gamma(b+s)$ i.e. the points $s = -a - n$ and $s = -b - m$ ($n, m = 0, 1, 2, \dots$) respectively, are at its left side and the poles of $\csc(\pi s)$ or $\Gamma(-s)$ i.e. $s = 0, 1, 2, \dots$ are at its right side. The cases in which $-a, -b$ or $-c$ are non-negative integers or $a - b$ equal to an integer are excluded.

Linear Transformation Formulas

From 15.3.1 and 15.3.2 a number of transformation formulas for $F(a, b; c; z)$ can be derived.

$$15.3.3 \quad F(a, b; c; z) = (1-z)^{c-a-b} F(c-a, c-b; c; z)$$

$$15.3.4 \quad = (1-z)^{-a} F\left(a, c-b; c; \frac{z}{z-1}\right)$$

$$15.3.5 \quad = (1-z)^{-b} F\left(b, c-a; c; \frac{z}{z-1}\right)$$

$$15.3.6 \quad = \frac{\Gamma(c)\Gamma(c-a-b)}{\Gamma(c-a)\Gamma(c-b)} F(a, b; a+b-c+1; 1-z)$$

$$+ (1-z)^{c-a-b} \frac{\Gamma(c)\Gamma(a+b-c)}{\Gamma(a)\Gamma(b)} F(c-a, c-b; c-a-b+1; 1-z)$$

($|\arg(1-z)| < \pi$)

$$15.3.7 \quad = \frac{\Gamma(c)\Gamma(b-a)}{\Gamma(b)\Gamma(c-a)} (-z)^{-a} F\left(a, 1-c+a; 1-b+a; \frac{1}{z}\right)$$

$$+ \frac{\Gamma(c)\Gamma(a-b)}{\Gamma(a)\Gamma(c-b)} (-z)^{-b} F\left(b, 1-c+b; 1-a+b; \frac{1}{z}\right) \quad (|\arg(-z)| < \pi)$$

$$15.3.8 \quad = (1-z)^{-a} \frac{\Gamma(c)\Gamma(b-a)}{\Gamma(b)\Gamma(c-a)} F\left(a, c-b; a-b+1; \frac{1}{1-z}\right)$$

$$+ (1-z)^{-b} \frac{\Gamma(c)\Gamma(a-b)}{\Gamma(a)\Gamma(c-b)} F\left(b, c-a; b-a+1; \frac{1}{1-z}\right) \quad (|\arg(1-z)| < \pi)$$

$$15.3.9 \quad = \frac{\Gamma(c)\Gamma(c-a-b)}{\Gamma(c-a)\Gamma(c-b)} z^{-a} F\left(a, a-c+1; a+b-c+1; 1-\frac{1}{z}\right)$$

$$+ \frac{\Gamma(c)\Gamma(a+b-c)}{\Gamma(a)\Gamma(b)} (1-z)^{c-a-b} z^{a-c} F\left(c-a, 1-a; c-a-b+1; 1-\frac{1}{z}\right)$$

($|\arg z| < \pi, |\arg(1-z)| < \pi$)

Each term of 15.3.6 has a pole when $c = a + b \pm m$, ($m = 0, 1, 2, \dots$); this case is covered by

$$15.3.10 \quad F(a, b; a+b; z) = \frac{\Gamma(a+b)}{\Gamma(a)\Gamma(b)} \sum_{n=0}^{\infty} \frac{(a)_n (b)_n}{(n!)^2} [2\psi(n+1) - \psi(a+n) - \psi(b+n) - \ln(1-z)] (1-z)^n$$

($|\arg(1-z)| < \pi, |1-z| < 1$)

Furthermore for $m = 1, 2, 3, \dots$

$$15.3.11 \quad F(a, b; a+b+m; z) = \frac{\Gamma(m)\Gamma(a+b+m)}{\Gamma(a+m)\Gamma(b+m)} \sum_{n=0}^{m-1} \frac{(a)_n (b)_n}{n!(1-m)_n} (1-z)^n$$

$$- \frac{\Gamma(a+b+m)}{\Gamma(a)\Gamma(b)} (z-1)^m \sum_{n=0}^{\infty} \frac{(a+m)_n (b+m)_n}{n!(n+m)!} (1-z)^n [\ln(1-z) - \psi(n+1) - \psi(n+m+1) + \psi(a+n+m) + \psi(b+n+m)]$$

($|\arg(1-z)| < \pi, |1-z| < 1$)

$$\begin{aligned}
 15.3.12 \quad F(a, b; a+b-m; z) &= \frac{\Gamma(m)\Gamma(a+b-m)}{\Gamma(a)\Gamma(b)} (1-z)^{-m} \sum_{n=0}^{m-1} \frac{(a-m)_n (b-m)_n}{n!(1-m)_n} (1-z)^n \\
 &\quad - \frac{(-1)^m \Gamma(a+b-m)}{\Gamma(a-m)\Gamma(b-m)} \sum_{n=0}^{\infty} \frac{(a)_n (b)_n}{n!(n+m)!} (1-z)^n [\ln(1-z) - \psi(n+1) \\
 &\quad \quad \quad - \psi(n+m+1) + \psi(a+n) + \psi(b+n)] \\
 &\quad \quad \quad (|\arg(1-z)| < \pi, |1-z| < 1)
 \end{aligned}$$

Similarly each term of 15.3.7 has a pole when $b=a \pm m$ or $b-a = \pm m$ and the case is covered by

$$\begin{aligned}
 15.3.13 \quad F(a, a; c; z) &= \frac{\Gamma(c)}{\Gamma(a)\Gamma(c-a)} (-z)^{-a} \sum_{n=0}^{\infty} \frac{(a)_n (1-c+a)_n}{(n!)^2} z^{-n} [\ln(-z) + 2\psi(n+1) - \psi(a+n) - \psi(c-a-n)] \\
 &\quad (|\arg(-z)| < \pi, |z| > 1, (c-a) \neq 0, \pm 1, \pm 2, \dots)
 \end{aligned}$$

The case $b-a=m$, ($m=1, 2, 3, \dots$) is covered by

$$\begin{aligned}
 15.3.14 \quad F(a, a+m; c; z) &= F(a+m, a; c; z) \\
 &= \frac{\Gamma(c)(-z)^{-a-m}}{\Gamma(a+m)\Gamma(c-a)} \sum_{n=0}^{\infty} \frac{(a)_{n+m} (1-c+a)_{n+m}}{n!(n+m)!} z^{-n} [\ln(-z) + \psi(1+m+n) + \psi(1+n) \\
 &\quad \quad \quad - \psi(a+m+n) - \psi(c-a-m-n)] + (-z)^{-a} \frac{\Gamma(c)}{\Gamma(a+m)} \sum_{n=0}^{m-1} \frac{\Gamma(m-n)(a)_n}{n!\Gamma(c-a-n)} z^{-n} \\
 &\quad \quad \quad (|\arg(-z)| < \pi, |z| > 1, (c-a) \neq 0, \pm 1, \pm 2, \dots)
 \end{aligned}$$

The case $c-a=0, -1, -2, \dots$ becomes elementary, 15.3.3, and the case $c-a=1, 2, 3, \dots$ can be obtained from 15.3.14, by a limiting process (see [15.2]).

Quadratic Transformation Formulas

If, and only if the numbers $\pm(1-c)$, $\pm(a-b)$, $\pm(a+b-c)$ are such, that two of them are equal or one of them is equal to $\frac{1}{2}$, then there exists a quadratic transformation. The basic formulas are due to Kummer [15.7] and a complete list is due to Goursat [15.3]. See also [15.2].

$$15.3.15 \quad F(a, b; 2b; z) = (1-z)^{-1/2} F\left(\frac{1}{2}a, b - \frac{1}{2}a; b + \frac{1}{2}; \frac{z^2}{4z-4}\right)$$

$$15.3.16 \quad = (1 - \frac{1}{2}z)^{-a} F\left(\frac{1}{2}a, \frac{1}{2} + \frac{1}{2}a; b + \frac{1}{2}; z^2(2-z)^{-2}\right)$$

$$15.3.17 \quad = \left(\frac{1}{2} + \frac{1}{2}\sqrt{1-z}\right)^{-2a} F\left[a, a-b + \frac{1}{2}; b + \frac{1}{2}; \left(\frac{1-\sqrt{1-z}}{1+\sqrt{1-z}}\right)^2\right]$$

$$15.3.18 \quad = (1-z)^{-1/2} F\left(a, 2b-a; b + \frac{1}{2}; -\frac{(1-\sqrt{1-z})^2}{4\sqrt{1-z}}\right)$$

$$15.3.19 \quad F(a, a + \frac{1}{2}; c; z) = \left(\frac{1}{2} + \frac{1}{2}\sqrt{1-z}\right)^{-2a} F\left(2a, 2a-c+1; c; \frac{1-\sqrt{1-z}}{1+\sqrt{1-z}}\right)$$

$$15.3.20 \quad = (1 \pm \sqrt{z})^{-2a} F\left(2a, c - \frac{1}{2}; 2c-1; \pm \frac{2\sqrt{z}}{1 \pm \sqrt{z}}\right)$$

$$15.3.21 \quad = (1-z)^{-a} F\left(2a, 2c-2a-1; c; \frac{\sqrt{1-z}-1}{2\sqrt{1-z}}\right)$$

$$15.3.22 \quad F(a, b; a+b + \frac{1}{2}; z) = F(2a, 2b; a+b + \frac{1}{2}; \frac{1}{2} - \frac{1}{2}\sqrt{1-z})$$

$$15.3.23 \quad = \left(\frac{1}{2} + \frac{1}{2}\sqrt{1-z}\right)^{-2a} F\left(2a, a-b + \frac{1}{2}; a+b + \frac{1}{2}; \frac{\sqrt{1-z}-1}{\sqrt{1-z}+1}\right)$$

- 15.3.24 $F(a, b; a+b-\frac{1}{2}; z) = (1-z)^{-1} F(2a-1, 2b-1; a+b-\frac{1}{2}; \frac{1}{2}-\frac{1}{2}\sqrt{1-z})$
- 15.3.25 $= (1-z)^{-1} (\frac{1}{2}+\frac{1}{2}\sqrt{1-z})^{1-2a} F(2a-1, a-b+\frac{1}{2}; a+b-\frac{1}{2}; \frac{\sqrt{1-z}-1}{\sqrt{1-z}+1})$
- 15.3.26 $F(a, b; a-b+1; z) = (1+z)^{-a} F(\frac{1}{2}a, \frac{1}{2}a+\frac{1}{2}; a-b+1; 4z(1+z)^{-2})$
- 15.3.27 $= (1\pm\sqrt{z})^{-2a} F(a, a-b+\frac{1}{2}; 2a-2b+1; \pm 4\sqrt{z}(1\pm\sqrt{z})^{-2})$
- 15.3.28 $= (1-z)^{-a} F(\frac{1}{2}a, \frac{1}{2}a-b+\frac{1}{2}; a-b+1; -4z(1-z)^{-2})$
- 15.3.29 $F(a, b; \frac{1}{2}a+\frac{1}{2}b+\frac{1}{2}; z) = (1-2z)^{-a} F(\frac{1}{2}a, \frac{1}{2}a+\frac{1}{2}; \frac{1}{2}a+\frac{1}{2}b+\frac{1}{2}; \frac{4z^2-4z}{(1-2z)^2})$
- 15.3.30 $= F(\frac{1}{2}a, \frac{1}{2}b; \frac{1}{2}a+\frac{1}{2}b+\frac{1}{2}; 4z-4z^2)$
- 15.3.31 $F(a, 1-a; c; z) = (1-z)^{c-1} F(\frac{1}{2}c-\frac{1}{2}a, \frac{1}{2}c+\frac{1}{2}a-\frac{1}{2}; c; 4z-4z^2)$
- 15.3.32 $= (1-z)^{c-1} (1-2z)^{a-c} F(\frac{1}{2}c-\frac{1}{2}a, \frac{1}{2}c-\frac{1}{2}a+\frac{1}{2}; c; (4z^2-4z)(1-2z)^{-2})$

Cubic transformations are listed in [15.2] and [15.3].

In the formulas above, the square roots are defined so that their value is real and positive when $0 \leq z < 1$. All formulas are valid in the neighborhood of $z=0$.

15.4. Special Cases of $F(a, b; c; z)$

Polynomials

When a or b is equal to a negative integer, then

15.4.1 $F(-m, b; c; z) = \sum_{n=0}^m \frac{(-m)_n (b)_n}{(c)_n} \frac{z^n}{n!}$

This formula is also valid when $c = -m-l; m, l = 0, 1, 2, \dots$

15.4.2 $F(-m, b; -m-l; z) = \sum_{n=0}^m \frac{(-m)_n (b)_n}{(-m-l)_n} \frac{z^n}{n!}$

Some particular cases are

15.4.3 $F(-n, n; \frac{1}{2}; x) = T_n(1-2x)$

15.4.4 $F(-n, n+1; 1; x) = P_n(1-2x)$

15.4.5 $F(-n, n+2\alpha; \alpha+\frac{1}{2}; x) = \frac{n!}{(2\alpha)_n} C_n^{(\alpha)}(1-2x)$

15.4.6 $F(-n, \alpha+1+\beta+n; \alpha+1; x) = \frac{n!}{(\alpha+1)_n} P_n^{(\alpha, \beta)}(1-2x)$

Here $T_n, P_n, C_n^{(\alpha)}, P_n^{(\alpha, \beta)}$ denote Chebyshev, Legendre's, Gegenbauer's and Jacobi's polynomials respectively (see chapter 22).

Legendre Functions

Legendre functions are connected with those special cases of the hypergeometric function for which a quadratic transformation exists (see 15.3).

15.4.7 $F(a, b; 2b; z) = 2^{2b-1} \Gamma(\frac{1}{2}+b) z^{1-b} (1-z)^{1(b-a-1)} P_{a-b-\frac{1}{2}}^{1-b} \left[\left(1-\frac{z}{2}\right) (1-z)^{-1} \right]$

15.4.8 $= 2^{2b} \pi^{-1} \frac{\Gamma(\frac{1}{2}+b)}{\Gamma(2b-a)} z^{-b} (1-z)^{1(b-a)} e^{i\pi(a-b)} P_{b-\frac{1}{2}}^{b-a} \left(\frac{2}{z}-1 \right)$

15.4.9 $F(a, b; 2b; -z) = 2^{2b} \pi^{-1} \frac{\Gamma(\frac{1}{2}+b)}{\Gamma(a)} z^{-b} (1+z)^{1(b-a)} e^{-i\pi(a-b)} P_{b-\frac{1}{2}}^{a-b} \left(1+\frac{2}{z} \right) \left(|\arg z| < \pi, |\arg(1\pm z)| < \pi \right)$

$$15.4.10 \quad F(a, a + \frac{1}{2}; c; z) = 2^{c-1} \Gamma(c) z^{\frac{1}{2}-ic} (1-z)^{\frac{1}{2}-a-ic} P_{2a-\frac{1}{2}}^{1-c} [(1-z)^{-\frac{1}{2}}] \\ (|\arg z| < \pi, |\arg(1-z)| < \pi, z \text{ not between } 0 \text{ and } -\infty)$$

$$15.4.11 \quad F(a, a + \frac{1}{2}; c; x) = 2^{c-1} \Gamma(c) (-x)^{\frac{1}{2}-ic} (1-x)^{\frac{1}{2}-a-ic} P_{2a-\frac{1}{2}}^{1-c} [(1-x)^{-\frac{1}{2}}] \quad (-\infty < x < 0)$$

$$15.4.12 \quad F(a, b; a+b + \frac{1}{2}; z) = 2^{a+b-1} \Gamma(\frac{1}{2}+a+b) (-z)^{\frac{1}{2}(1-a-b)} P_{a-\frac{1}{2}}^{1-a-b} [(1-z)^{\frac{1}{2}}] \\ (|\arg(-z)| < \pi, z \text{ not between } 0 \text{ and } 1)$$

$$15.4.13 \quad F(a, b; a+b + \frac{1}{2}; x) = 2^{a+b-1} \Gamma(\frac{1}{2}+a+b) x^{\frac{1}{2}(1-a-b)} P_{a-\frac{1}{2}}^{1-a-b} [(1-x)^{\frac{1}{2}}] \quad (0 < x < 1)$$

$$15.4.14 \quad F(a, b; a-b+1; z) = \Gamma(a-b+1) z^{\frac{1}{2}-ia} (1-z)^{-b} P_{-b}^{b-a} \left(\frac{1+z}{1-z} \right) \\ (|\arg(1-z)| < \pi, z \text{ not between } 0 \text{ and } -\infty)$$

$$15.4.15 \quad F(a, b; a-b+1; x) = \Gamma(a-b+1) (1-x)^{-b} (-x)^{\frac{1}{2}-ia} P_{-b}^{b-a} \left(\frac{1+x}{1-x} \right) \quad (-\infty < x < 0)$$

$$15.4.16 \quad F(a, 1-a; c; z) = \Gamma(c) (-z)^{\frac{1}{2}-ic} (1-z)^{ic-1} P_{-a}^{1-c} (1-2z) \\ (|\arg(-z)| < \pi, |\arg(1-z)| < \pi, z \text{ not between } 0 \text{ and } 1)$$

$$15.4.17 \quad F(a, 1-a; c; x) = \Gamma(c) x^{\frac{1}{2}-ic} (1-x)^{ic-1} P_{-a}^{1-c} (1-2x) \quad (0 < x < 1)$$

$$15.4.18 \quad F(a, b; \frac{1}{2}a + \frac{1}{2}b + \frac{1}{2}; z) = \Gamma(\frac{1}{2} + \frac{1}{2}a + \frac{1}{2}b) [z(z-1)]^{\frac{1}{2}(1-a-b)} P_{\frac{1}{2}(a-b-1)}^{1-a-b} (1-2z) \\ (|\arg z| < \pi, |\arg(z-1)| < \pi, z \text{ not between } 0 \text{ and } 1)$$

$$15.4.19 \quad F(a, b; \frac{1}{2}a + \frac{1}{2}b + \frac{1}{2}; x) = \Gamma(\frac{1}{2} + \frac{1}{2}a + \frac{1}{2}b) (x-x^2)^{\frac{1}{2}(1-a-b)} P_{\frac{1}{2}(a-b-1)}^{1-a-b} (1-2x) \quad (0 < x < 1)$$

$$15.4.20 \quad F(a, b; a+b - \frac{1}{2}; z) = 2^{a+b-1} \Gamma(a+b - \frac{1}{2}) (-z)^{\frac{1}{2}(1-a-b)} (1-z)^{-1} P_{a-\frac{1}{2}}^{1-a-b} [(1-z)^{\frac{1}{2}}] \\ (|\arg(-z)| < \pi, |\arg(1-z)| < \pi, \Re[(1-z)^{\frac{1}{2}}] > 0, z \text{ not between } 0 \text{ and } 1)$$

$$15.4.21 \quad F(a, b; a+b - \frac{1}{2}; x) = 2^{a+b-1} \Gamma(a+b - \frac{1}{2}) x^{\frac{1}{2}(1-a-b)} (1-x)^{-1} P_{a-\frac{1}{2}}^{1-a-b} [(1-x)^{\frac{1}{2}}] \quad (0 < x < 1)$$

$$15.4.22 \quad F(a, b; \frac{1}{2}; z) = \pi^{-1} 2^{a+b-1} \Gamma(\frac{1}{2}+a) \Gamma(\frac{1}{2}+b) (z-1)^{\frac{1}{2}(1-a-b)} [P_{a-\frac{1}{2}}^{1-a-b}(z^{\frac{1}{2}}) + P_{a-\frac{1}{2}}^{1-a-b}(-z^{\frac{1}{2}})] \\ (|\arg z| < \pi, |\arg(z-1)| < \pi, z \text{ not between } 0 \text{ and } 1)$$

$$15.4.23 \quad F(a, b; \frac{1}{2}; x) = \pi^{-1} 2^{a+b-1} \Gamma(\frac{1}{2}+a) \Gamma(\frac{1}{2}+b) (1-x)^{\frac{1}{2}(1-a-b)} [P_{a-\frac{1}{2}}^{1-a-b}(x^{\frac{1}{2}}) + P_{a-\frac{1}{2}}^{1-a-b}(-x^{\frac{1}{2}})] \quad (0 < x < 1)$$

$$15.4.24 \quad F(a, b; \frac{1}{2}; -z) = \pi^{-1} 2^{a+b-1} \Gamma(\frac{1}{2}+a) \Gamma(1-b) (z+1)^{-\frac{1}{2}(1-a-b)} e^{\pm \frac{\pi}{2}(b-a)} \{ P_{a+\frac{1}{2}}^{b-a} [z^{\frac{1}{2}}(1+z)^{-\frac{1}{2}}] \\ + P_{a+\frac{1}{2}}^{b-a} [-z^{\frac{1}{2}}(1+z)^{-\frac{1}{2}}] \} \\ (\pm \text{ according as } \Im z \geq 0, z \text{ not between } 0 \text{ and } \infty)$$

$$* 15.4.25 \quad F(a, b; \frac{1}{2}; -x) = \pi^{-1} 2^{a+b-1} \Gamma(\frac{1}{2}+a) \Gamma(1-b) (1+x)^{-\frac{1}{2}(1-a-b)} \{ P_{a+\frac{1}{2}}^{b-a} [x^{\frac{1}{2}}(1+x)^{-\frac{1}{2}}] + P_{a+\frac{1}{2}}^{b-a} [-x^{1/2}(1+x)^{-\frac{1}{2}}] \} \\ (0 < x < \infty)$$

$$15.4.26 \quad F(a, b; \frac{3}{2}; x) = -\pi^{-1} 2^{a+b-1} \Gamma(a-\frac{1}{2}) \Gamma(b-\frac{1}{2}) x^{-\frac{1}{2}} (1-x)^{\frac{1}{2}(1-a-b)} \{ P_{a-\frac{1}{2}}^{1-a-b}(x^{\frac{1}{2}}) - P_{a-\frac{1}{2}}^{1-a-b}(-x^{\frac{1}{2}}) \} \quad (0 < x < 1)$$

15.5. The Hypergeometric Differential Equation

The hypergeometric differential equation

$$15.5.1 \quad z(1-z) \frac{d^2 w}{dz^2} + [c - (a+b+1)z] \frac{dw}{dz} - abw = 0$$

has three (regular) singular points $z=0, 1, \infty$. The pairs of exponents at these points are

$$15.5.2 \quad \rho_{1,2}^{(0)}=0, 1-c, \quad \rho_{1,2}^{(1)}=0, c-a-b, \quad \rho_{1,2}^{(\infty)}=a, b$$

respectively. The general theory of differential equations of the Fuchsian type distinguishes between the following cases.

A. None of the numbers $c, c-a-b; a-b$ is equal to an integer. Then two linearly independent solutions of 15.5.1 in the neighborhood of the singular points $0, 1, \infty$ are respectively

$$15.5.3 \quad w_{1(0)}=F(a, b; c; z)=(1-z)^{c-a-b}F(c-a, c-b; c; z)$$

$$15.5.4 \quad w_{2(0)}=z^{1-c}F(a-c+1, b-c+1; 2-c; z)=z^{1-c}(1-z)^{c-a-b}F(1-a, 1-b; 2-c; z)$$

$$15.5.5 \quad w_{1(1)}=F(a, b; a+b+1-c; 1-z)=z^{1-c}F(1+b-c, 1+a-c; a+b+1-c; 1-z)$$

$$15.5.6 \quad w_{2(1)}=(1-z)^{c-a-b}F(c-b, c-a; c-a-b+1; 1-z)=z^{1-c}(1-z)^{c-a-b}F(1-a, 1-b; c-a-b+1; 1-z)$$

$$15.5.7 \quad w_{1(\infty)}=z^{-a}F(a, a-c+1; a-b+1; z^{-1})=z^{b-c}(z-1)^{c-a-b}F(1-b, c-b; a-b+1; z^{-1})$$

$$15.5.8 \quad w_{2(\infty)}=z^{-b}F(b, b-c+1; b-a+1; z^{-1})=z^{a-c}(z-1)^{c-a-b}F(1-a, c-a; b-a+1; z^{-1})$$

The second set of the above expressions is obtained by applying 15.3.3 to the first set.

Another set of representations is obtained by applying 15.3.4 to 15.5.3 through 15.5.8. This gives 15.5.9–15.5.14.

$$15.5.9 \quad w_{1(0)}=(1-z)^{-a}F\left(a, c-b; c; \frac{z}{z-1}\right)=(1-z)^{-b}F\left(b, c-a; c; \frac{z}{z-1}\right)$$

$$15.5.10 \quad w_{2(0)}=z^{1-c}(1-z)^{c-a-1}F\left(a-c+1, 1-b; 2-c; \frac{z}{z-1}\right)=z^{1-c}(1-z)^{c-b-1}F\left(b-c+1, 1-a; 2-c; \frac{z}{z-1}\right)$$

$$15.5.11 \quad w_{1(1)}=z^{-a}F(a, a-c+1; a+b-c+1; 1-z^{-1})=z^{-b}F(b, b-c+1; a+b-c+1; 1-z^{-1})$$

15.5.12

$$w_{2(1)}=z^{a-c}(1-z)^{c-a-b}F(c-a, 1-a; c-a-b+1; 1-z^{-1})=z^{b-c}(1-z)^{c-a-b}F(c-b, 1-b; c-a-b+1; 1-z^{-1})$$

$$15.5.13 \quad w_{1(\infty)}=(z-1)^{-a}F\left(a, c-b; a-b+1; \frac{1}{1-z}\right)=(z-1)^{-b}F\left(b, c-a; b-a+1; \frac{1}{1-z}\right)$$

15.5.14

$$w_{2(\infty)}=z^{1-c}(z-1)^{c-a-1}F\left(a-c+1, 1-b; a-b+1; \frac{1}{1-z}\right)=z^{1-c}(z-1)^{c-b-1}F\left(b-c+1, 1-a; b-a+1; \frac{1}{1-z}\right)$$

15.5.3 to 15.5.14 constitute Kummer's 24 solutions of the hypergeometric equation. The analytic continuation of $w_{1,2(0)}(z)$ can then be obtained by means of 15.3.3 to 15.3.9.

B. One of the numbers $a, b, c-a, c-b$ is an integer. Then one of the hypergeometric series for instance $w_{1,2(0)}$, 15.5.3, 15.5.4 terminates and the corresponding solution is of the form

$$15.5.15 \quad w=z^a(1-z)^b p_n(z)$$

where $p_n(z)$ is a polynomial in z of degree n . This case is referred to as the degenerate case of the hypergeometric differential equation and its solutions are listed and discussed in great detail in [15.2].

C. The number $c-a-b$ is an integer, c nonintegral. Then 15.3.10 to 15.3.12 give the analytic continuation of $w_{1,2(0)}$ into the neighborhood of $z=1$. Similarly 15.3.13 and 15.3.14 give the analytic continuation of $w_{1,2(0)}$ into the neighborhood of $z=\infty$ in case $a-b$ is an integer but not c , subject of course to the further restrictions $c-a=0, \pm 1, \pm 2 \dots$ (For a detailed discussion of all possible cases, see [15.2]).

D. The number $c=1$. Then 15.5.3, 15.5.4 are replaced by

$$15.5.16 \quad w_{1(0)}=F(a, b; 1; z)$$

$$15.5.17 \quad w_{2(0)} = F(a, b; 1; z) \ln z + \sum_{n=1}^{\infty} \frac{(a)_n (b)_n}{(n!)^2} z^n [\psi(a+n) - \psi(a) + \psi(b+n) - \psi(b) - 2\psi(n+1) + 2\psi(1)] \quad (|z| < 1)$$

E. The number $c = m + 1, m = 1, 2, 3, \dots$. A fundamental system is

$$15.5.18 \quad w_{1(0)} = F(a, b; m + 1; z)$$

$$15.5.19 \quad w_{2(0)} = F(a, b; m + 1; z) \ln z + \sum_{n=1}^{\infty} \frac{(a)_n (b)_n}{(1+m)_n n!} z^n [\psi(a+n) - \psi(a) + \psi(b+n) - \psi(b) - \psi(m+1+n) + \psi(m+1) - \psi(n+1) + \psi(1)] - \sum_{n=1}^m \frac{(n-1)! (-m)_n}{(1-a)_n (1-b)_n} z^{-n} \quad (|z| < 1 \text{ and } a, b \neq 0, 1, 2, \dots, (m-1))$$

F. The number $c = 1 - m, m = 1, 2, 3, \dots$. A fundamental system is

$$15.5.20 \quad w_{1(0)} = z^m F(a + m, b + m; 1 + m; z)$$

15.5.21

$$w_{2(0)} = z^m F(a + m, b + m; 1 + m; z) \ln z + z^m \sum_{n=1}^{\infty} z^n \frac{(a+m)_n (b+m)_n}{(1+m)_n n!} [\psi(a+m+n) - \psi(a+m) + \psi(b+m+n) - \psi(b+m) - \psi(m+1+n) + \psi(m+1) - \psi(n+1) + \psi(1)] - \sum_{n=1}^m \frac{(n-1)! (-m)_n}{(1-a-m)_n (1-b-m)_n} z^{m-n} \quad (|z| < 1 \text{ and } a, b \neq 0, -1, -2, \dots, -(m-1))$$

15.6. Riemann's Differential Equation

The hypergeometric differential equation 15.5.1 with the (regular) singular points $0, 1, \infty$ is a special case of Riemann's differential equation with three (regular) singular points a, b, c

15.6.1

$$\frac{d^2 w}{dz^2} + \left[\frac{1-\alpha-\alpha'}{z-a} + \frac{1-\beta-\beta'}{z-b} + \frac{1-\gamma-\gamma'}{z-c} \right] \frac{dw}{dz} + \left[\frac{\alpha\alpha'(a-b)(a-c)}{z-a} + \frac{\beta\beta'(b-c)(b-a)}{z-b} + \frac{\gamma\gamma'(c-a)(c-b)}{z-c} \right] \frac{w}{(z-a)(z-b)(z-c)} = 0$$

The pairs of the exponents with respect to the singular points $a; b; c$ are $\alpha, \alpha'; \beta, \beta'; \gamma, \gamma'$ respectively subject to the condition

$$15.6.2 \quad \alpha + \alpha' + \beta + \beta' + \gamma + \gamma' = 1$$

The complete set of solutions of 15.6.1 is denoted by the symbol

$$15.6.3 \quad w = P \left\{ \begin{matrix} a & b & c & \\ \alpha & \beta & \gamma & z \\ \alpha' & \beta' & \gamma' & \end{matrix} \right\}$$

Special Cases of Riemann's P Function

(a) The generalized hypergeometric function

15.6.4

$$w = P \left\{ \begin{matrix} 0 & \infty & 1 & \\ \alpha & \beta & \gamma & z \\ \alpha' & \beta' & \gamma' & \end{matrix} \right\}$$

(b) The hypergeometric function $F(a, b; c; z)$

15.6.5

$$w = P \left\{ \begin{matrix} 0 & \infty & 1 & \\ 0 & a & 0 & z \\ 1-c & b & c-a-b & \end{matrix} \right\}$$

(c) The Legendre functions $P_\nu^\mu(z), Q_\nu^\mu(z)$

15.6.6

$$w = P \left\{ \begin{matrix} 0 & \infty & 1 & \\ -\frac{1}{2}\nu & \frac{1}{2}\mu & 0 & (1-z^2)^{-1} \\ \frac{1}{2} + \frac{1}{2}\nu & -\frac{1}{2}\mu & \frac{1}{2} & \end{matrix} \right\}$$

(d) The confluent hypergeometric function

15.6.7

$$w = P \left\{ \begin{matrix} 0 & \infty & c & \\ \frac{1}{2} + u & -c & c-k & z \\ \frac{1}{2} - u & 0 & k & \end{matrix} \right\}$$

provided $\lim c \rightarrow \infty$.

Transformation Formulas for Riemann's P Function

$$15.6.8 \quad \left(\frac{z-a}{z-b}\right)^k \left(\frac{z-c}{z-b}\right)^l P \left\{ \begin{matrix} a & b & c \\ \alpha & \beta & \gamma & z \\ \alpha' & \beta' & \gamma' \end{matrix} \right\} = P \left\{ \begin{matrix} a & b & c \\ \alpha+k & \beta-k-l & \gamma+l & z \\ \alpha'+k & \beta'-k-l & \gamma'+l \end{matrix} \right\}$$

$$15.6.9 \quad P \left\{ \begin{matrix} a & b & c \\ \alpha & \beta & \gamma & z \\ \alpha' & \beta' & \gamma' \end{matrix} \right\} = P \left\{ \begin{matrix} a_1 & b_1 & c_1 \\ \alpha & \beta & \gamma & z_1 \\ \alpha' & \beta' & \gamma' \end{matrix} \right\}$$

where

$$15.6.10 \quad z = \frac{Az_1+B}{Cz_1+D}, \quad a = \frac{Aa_1+B}{Ca_1+D}, \quad b = \frac{Ab_1+B}{Cb_1+D}, \quad c = \frac{Ac_1+B}{Cc_1+D}$$

and A, B, C, D are arbitrary constants such that $AD-BC \neq 0$.

Riemann's P function reduced to the hypergeometric function is

$$15.6.11 \quad P \left\{ \begin{matrix} a & b & c \\ \alpha & \beta & \gamma & z \\ \alpha' & \beta' & \gamma' \end{matrix} \right\} = \left(\frac{z-a}{z-b}\right)^\alpha \left(\frac{z-c}{z-b}\right)^\gamma P \left\{ \begin{matrix} 0 & \infty & 1 \\ 0 & \alpha+\beta+\gamma & 0 \frac{(z-a)(c-b)}{(z-b)(c-a)} \\ \alpha'-\alpha & \alpha+\beta'+\gamma & \gamma'-\gamma \end{matrix} \right\}$$

The P function on the right hand side is Gauss' hypergeometric function (see 15.6.5). If it is replaced by Kummer's 24 solutions 15.5.3 to 15.5.14 the complete set of 24 solutions for Riemann's differential equation 15.6.1 is obtained. The first of these solutions is for instance by 15.5.3 and 15.6.5

$$15.6.12 \quad w = \left(\frac{z-a}{z-b}\right)^\alpha \left(\frac{z-c}{z-b}\right)^\gamma F \left[\alpha+\beta+\gamma, \alpha+\beta'+\gamma; 1+\alpha-\alpha'; \frac{(z-a)(c-b)}{(z-b)(c-a)} \right]$$

15.7. Asymptotic Expansions

The behavior of $F(a, b; c; z)$ for large $|z|$ is described by the transformation formulas of 15.3.

For fixed a, b, z and large $|c|$ one has [15.8]

15.7.1

$$F(a, b; c; z) = \sum_{n=0}^m \frac{(a)_n (b)_n z^n}{(c)_n n!} + O(|c|^{-m-1})$$

For fixed $a, c, z, (c \neq 0, -1, -2, \dots, 0 < |z| < 1)$ and large $|b|$ one has [15.2]

15.7.2

$$F(a, b; c; z) = e^{-i\pi a} [\Gamma(c)/\Gamma(c-a)] (bz)^{-a} [1 + O(|bz|^{-1})] + [\Gamma(c)/\Gamma(a)] e^{bz} (bz)^{a-c} [1 + O(|bz|^{-1})] \left(-\frac{3\pi}{2} < \arg(bz) < \frac{1}{2}\pi \right)$$

15.7.3

$$F(a, b; c; z) = e^{i\pi a} [\Gamma(c)/\Gamma(c-a)] (bz)^{-a} [1 + O(|bz|^{-1})] + [\Gamma(c)/\Gamma(a)] e^{bz} (bz)^{a-c} [1 + O(|bz|^{-1})] \left(-\frac{1}{2}\pi < \arg(bz) < \frac{3}{2}\pi \right)$$

For the case when more than one of the parameters are large consult [15.2].

References

[15.1] P. Appell and J. Kampé de Fériet, *Fonctions hypergéométriques et hypersphériques* (Gauthiers-Villars, Paris, France, 1926).
 [15.2] A. Erdélyi et al., *Higher transcendental functions*, vol. 1 (McGraw-Hill Book Co., Inc., New York, N.Y., 1953).
 [15.3] E. Goursat, *Ann. Sci. École Norm. Sup*(2)10, 3-142(1881).
 [15.4] E. Goursat, *Propriétés générales de l'équation d'Euler et de Gauss* (Actualités scientifiques et industrielles 333, Paris, France, 1936).
 [15.5] J. Kampé de Fériet, *La fonction hypergéométrique* (Gauthiers-Villars, Paris, France, 1937).
 [15.6] F. Klein, *Vorlesungen über die hypergeometrische Funktion* (B. G. Teubner, Berlin, Germany, 1933).

- [15.7] E. E. Kummer, Über die hypergeometrische Reihe, *J. Reine Angew. Math.* **15**, 39–83, 127–172(1836).
- [15.8] T. M. MacRobert, *Proc. Edinburgh Math. Soc.* **42**, 84–88(1923).
- [15.9] T. M. MacRobert, *Functions of a complex variable*, 4th ed. (Macmillan and Co., Ltd., London, England, 1954).
- [15.10] E. G. C. Poole, *Introduction to the theory of linear differential equations* (Clarendon Press, Oxford, England, 1936).
- [15.11] C. Snow, *The hypergeometric and Legendre functions with applications to integral equations of potential theory*, Applied Math. Series 19 (U.S. Government Printing Office, Washington, D.C., 1952).
- [15.12] E. T. Whittaker and G. N. Watson, *A course of modern analysis*, 4th ed. (Cambridge Univ. Press, Cambridge, England, 1952).

16. Jacobian Elliptic Functions and Theta Functions

L. M. MILNE-THOMSON¹

Contents

	Page
Mathematical Properties	569
16.1. Introduction	569
16.2. Classification of the Twelve Jacobian Elliptic Functions . .	570
16.3. Relation of the Jacobian Functions to the Copolar Trio . .	570
16.4. Calculation of the Jacobian Functions by Use of the Arith- metic-Geometric Mean (A.G.M.)	571
16.5. Special Arguments	571
16.6. Jacobian Functions when $m=0$ or 1	571
16.7. Principal Terms	572
16.8. Change of Argument	572
16.9. Relations Between the Squares of the Functions	573
16.10. Change of Parameter	573
16.11. Reciprocal Parameter (Jacobi's Real Transformation) . . .	573
16.12. Descending Landen Transformation (Gauss' Transforma- tion)	573
16.13. Approximation in Terms of Circular Functions	573
16.14. Ascending Landen Transformation	573
16.15. Approximation in Terms of Hyperbolic Functions	574
16.16. Derivatives	574
16.17. Addition Theorems	574
16.18. Double Arguments	574
16.19. Half Arguments	574
16.20. Jacobi's Imaginary Transformation	574
16.21. Complex Arguments	575
16.22. Leading Terms of the Series in Ascending Powers of u . .	575
16.23. Series Expansion in Terms of the Nome q	575
16.24. Integrals of the Twelve Jacobian Elliptic Functions	575
16.25. Notation for the Integrals of the Squares of the Twelve Jacobian Elliptic Functions	576
16.26. Integrals in Terms of the Elliptic Integral of the Second Kind	576
16.27. Theta Functions; Expansions in Terms of the Nome q . .	576
16.28. Relations Between the Squares of the Theta Functions . .	576
16.29. Logarithmic Derivatives of the Theta Functions	576
16.30. Logarithms of Theta Functions of Sum and Difference . .	577
16.31. Jacobi's Notation for Theta Functions	577
16.32. Calculation of Jacobi's Theta Function $\Theta(u m)$ by Use of the Arithmetic-Geometric Mean	577

¹ University of Arizona. (Prepared under contract with the National Bureau of Standards.)

	Page
16.33. Addition of Quarter-Periods to Jacobi's Eta and Theta Functions	577
16.34. Relation of Jacobi's Zeta Function to the Theta Functions.	578
16.35. Calculation of Jacobi's Zeta Function $Z(u m)$ by Use of the Arithmetic-Geometric Mean	578
16.36. Neville's Notation for Theta Functions	578
16.37. Expression as Infinite Products	579
16.38. Expression as Infinite Series	579
Numerical Methods	579
16.39. Use and Extension of the Tables	579
References	581
Table 16.1. Theta Functions	582

$$\vartheta_s(\epsilon^\circ \backslash \alpha^\circ), \sqrt{\sec \alpha} \vartheta_c(\epsilon_1^\circ \backslash \alpha^\circ)$$

$$\vartheta_n(\epsilon^\circ \backslash \alpha^\circ), \sqrt{\sec \alpha} \vartheta_d(\epsilon_1^\circ \backslash \alpha^\circ)$$

$$\alpha = 0^\circ(5^\circ)85^\circ, \epsilon, \epsilon_1 = 0^\circ(5^\circ)90^\circ, \quad 9-10D$$

Table 16.2. Logarithmic Derivatives of Theta Functions	584
---	-----

$$\frac{d}{du} \ln \vartheta_s(u) = f(\epsilon^\circ \backslash \alpha^\circ)$$

$$\frac{d}{du} \ln \vartheta_c(u) = -f(\epsilon_1^\circ \backslash \alpha^\circ)$$

$$\frac{d}{du} \ln \vartheta_n(u) = g(\epsilon^\circ \backslash \alpha^\circ)$$

$$\frac{d}{du} \ln \vartheta_d(u) = -g(\epsilon_1^\circ \backslash \alpha^\circ)$$

$$\alpha = 0^\circ(5^\circ)85^\circ, \epsilon, \epsilon_1 = 0^\circ(5^\circ)90^\circ, \quad 5-6D$$

The author wishes to acknowledge his great indebtedness to his friend, the late Professor E. H. Neville, for invaluable assistance in reading and criticizing the manuscript. Professor Neville generously supplied material from his own work and was responsible for many improvements in matter and arrangement.

The author's best thanks are also due to David S. Liepman and Ruth Zucker for the preparation and checking of the tables and graphs.

16. Jacobian Elliptic Functions and Theta Functions

Mathematical Properties

Jacobian Elliptic Functions

16.1. Introduction

A doubly periodic meromorphic function is called an *elliptic function*.

Let m, m_1 be numbers such that

$$m + m_1 = 1.$$

We call m the *parameter*, m_1 the *complementary parameter*.

In what follows we shall assume that the parameter m is a real number. Without loss of generality we can then suppose that $0 \leq m \leq 1$ (see 16.10, 16.11).

We define *quarter-periods* K and iK' by

16.1.1

$$K(m) = K = \int_0^{\pi/2} \frac{d\theta}{(1 - m \sin^2 \theta)^{1/2}},$$

$$iK'(m) = iK' = i \int_0^{\pi/2} \frac{d\theta}{(1 - m_1 \sin^2 \theta)^{1/2}}$$

so that K and K' are real numbers. K is called the real, iK' the imaginary quarter-period.

We note that

16.1.2

$$K(m) = K'(m_1) = K'(1 - m).$$

We also note that if any *one* of the numbers $m, m_1, K(m), K'(m), K'(m)/K(m)$ is given, all the rest are determined. Thus K and K' can not both be chosen arbitrarily.

In the Argand diagram denote the points $0, K, K + iK', iK'$ by s, c, d, n respectively. These points are at the vertices of a rectangle. The translations of this rectangle by $\lambda K, \mu iK'$, where λ, μ are given all integral values positive or negative, will lead to the lattice

.s	.c	.s	.c
.n	.d	.n	.d
.s	.c	.s	.c
.n	.d	.n	.d

the pattern being repeated indefinitely on all sides.

Let p, q be any two of the letters s, c, d, n . Then p, q determine in the lattice a minimum rectangle whose sides are of length K and K' and whose vertices s, c, d, n are in counterclockwise order.

Definition

The Jacobian elliptic function $pq u$ is defined by the following three properties.

(i) $pq u$ has a simple zero at p and a simple pole at q .

(ii) The step from p to q is a half-period of $pq u$. Those of the numbers $K, iK', K + iK'$ which differ from this step are only quarter-periods.

(iii) The coefficient of the leading term in the expansion of $pq u$ in ascending powers of u about $u=0$ is unity. With regard to (iii) the leading term is $u, 1/u, 1$ according as $u=0$ is a zero, a pole, or an ordinary point.

Thus the functions with a pole or zero at the origin (i.e., the functions in which one letter is s) are odd, and the others are even.

Should we wish to call explicit attention to the value of the parameter, we write $pq(u|m)$ instead of $pq u$.

The Jacobian elliptic functions can also be defined with respect to certain integrals. Thus if

16.1.3

$$u = \int_0^\varphi \frac{d\theta}{(1 - m \sin^2 \theta)^{1/2}},$$

the angle φ is called the *amplitude*

16.1.4

$$\varphi = \operatorname{am} u$$

and we define

16.1.5

$$\operatorname{sn} u = \sin \varphi, \operatorname{cn} u = \cos \varphi,$$

$$\operatorname{dn} u = (1 - m \sin^2 \varphi)^{1/2} = \Delta(\varphi).$$

Similarly all the functions $pq u$ can be expressed in terms of φ . This second set of definitions, although seemingly different, is mathematically equivalent to the definition previously given in terms of a lattice. For further explanation of notations, including the interpretation, of such expressions as $\operatorname{sn}(\varphi \backslash \alpha), \operatorname{cn}(u|m), \operatorname{dn}(u, k)$, see 17.2.

16.2. Classification of the Twelve Jacobian Elliptic Functions
According to Poles and Half-Periods

	Pole iK'	Pole $K+iK'$	Pole K	Pole 0	
Half period iK'	$\text{sn } u$	$\text{cd } u$	$\text{dc } u$	$\text{ns } u$	Periods $2iK', 4K+4iK', 4K$
Half period $K+iK'$	$\text{cn } u$	$\text{sd } u$	$\text{nc } u$	$\text{ds } u$	Periods $4iK', 2K+2iK', 4K$
Half period K	$\text{dn } u$	$\text{nd } u$	$\text{sc } u$	$\text{cs } u$	Periods $4iK', 4K+4iK', 2K$

The three functions in a vertical column are *copolar*.

The four functions in a horizontal line are *coperiodic*. Of the periods quoted in the last line of each row only two are independent.

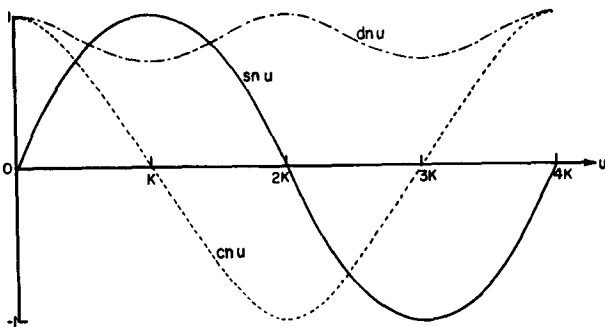

FIGURE 16.1. *Jacobian elliptic functions*
 $\text{sn } u, \text{cn } u, \text{dn } u$
 $m = \frac{1}{2}$

The curve for $\text{cn}(u\frac{1}{2})$ is the boundary between those which have an inflexion and those which have not.

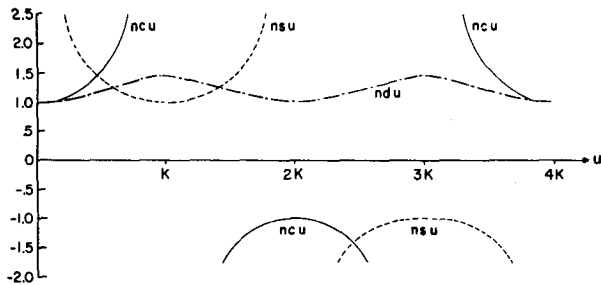

FIGURE 16.2. *Jacobian elliptic functions*
 $\text{ns } u, \text{nc } u, \text{nd } u$
 $m = \frac{1}{2}$

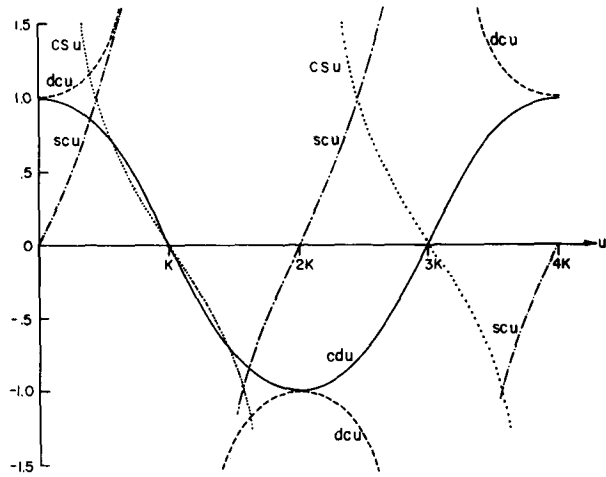

FIGURE 16.3. *Jacobian elliptic functions*
 $\text{sc } u, \text{cs } u, \text{cd } u, \text{dc } u$
 $m = \frac{1}{2}$

16.3. Relation of the Jacobian Functions to the Copolar Trio $\text{sn } u, \text{cn } u, \text{dn } u$

16.3.1 $\text{cd } u = \frac{\text{cn } u}{\text{dn } u}$ $\text{dc } u = \frac{\text{dn } u}{\text{cn } u}$ $\text{ns } u = \frac{1}{\text{sn } u}$

16.3.2 $\text{sd } u = \frac{\text{sn } u}{\text{dn } u}$ $\text{nc } u = \frac{1}{\text{cn } u}$ $\text{ds } u = \frac{\text{dn } u}{\text{sn } u}$

16.3.3 $\text{nd } u = \frac{1}{\text{dn } u}$ $\text{sc } u = \frac{\text{sn } u}{\text{cn } u}$ $\text{cs } u = \frac{\text{cn } u}{\text{sn } u}$

And generally if p, q, r are any three of the letters s, c, d, n ,

16.3.4 $\text{pq } u = \frac{\text{pr } u}{\text{qr } u}$

provided that when two letters are the same, e.g., $\text{pp } u$, the corresponding function is put equal to unity.

16.4. Calculation of the Jacobian Functions by Use of the Arithmetic-Geometric Mean (A.G.M.)

For the A.G.M. scale see 17.6.

To calculate $\text{sn}(u|m)$, $\text{cn}(u|m)$, and $\text{dn}(u|m)$ form the A.G.M. scale starting with

16.4.1 $a_0=1, b_0=\sqrt{m_1}, c_0=\sqrt{m},$

terminating at the step N when c_N is negligible to the accuracy required. Find φ_N in degrees where

16.4.2 $\varphi_N=2^N a_N u \frac{180^\circ}{\pi}$

and then compute successively $\varphi_{N-1}, \varphi_{N-2}, \dots, \varphi_1, \varphi_0$ from the recurrence relation

16.4.3 $\sin(2\varphi_{n-1}-\varphi_n) = \frac{c_n}{a_n} \sin \varphi_n.$

Then

16.4.4

$\text{sn}(u|m) = \sin \varphi_0, \text{cn}(u|m) = \cos \varphi_0$

$\text{dn}(u|m) = \frac{\cos \varphi_0}{\cos(\varphi_1-\varphi_0)}$

From these all the other functions can be determined.

16.5. Special Arguments

	u	$\text{sn } u$	$\text{cn } u$	$\text{dn } u$
16.5.1	0	0	1	1
16.5.2	$\frac{1}{2}K$	$\frac{1}{(1+m_1^{1/2})^{1/2}}$	$\frac{m_1^{1/4}}{(1+m_1^{1/2})^{1/2}}$	$m_1^{1/4}$
16.5.3	K	1	0	$m_1^{1/2}$
16.5.4	$\frac{1}{2}(iK')$	$im^{-1/4}$	$\frac{(1+m^{1/2})^{1/2}}{m^{1/4}}$	$(1+m^{1/2})^{1/2}$
16.5.5	$\frac{1}{2}(K+iK')$	$2^{-1/2}m^{-1/4}[(1+m^{1/2})^{1/2} + i(1-m^{1/2})^{1/2}]$	$\left(\frac{m_1}{4m}\right)^{1/4}(1-i)$	$\left(\frac{m_1}{4}\right)^{1/4}[(1+m_1^{1/2})^{1/2} - i(1-m_1^{1/2})^{1/2}]$
16.5.6	$K + \frac{1}{2}(iK')$	$m^{-1/4}$	$-i\left(\frac{1-m^{1/2}}{m^{1/2}}\right)^{1/2}$	$(1-m^{1/2})^{1/2}$
16.5.7	iK'	∞	∞	∞
16.5.8	$\frac{1}{2}K + iK'$	$(1-m_1^{1/2})^{-1/2}$	$-i\left(\frac{m_1^{1/2}}{1-m_1^{1/2}}\right)^{1/2}$	$-im_1^{1/4}$
16.5.9	$K + iK'$	$m^{-1/2}$	$-i(m_1/m)^{1/2}$	0

16.6. Jacobian Functions when $m=0$ or 1

		$m=0$	$m=1$
16.6.1	$\text{sn}(u m)$	$\sin u$	$\tanh u$
16.6.2	$\text{cn}(u m)$	$\cos u$	$\text{sech } u$
16.6.3	$\text{dn}(u m)$	1	$\text{sech } u$
16.6.4	$\text{cd}(u m)$	$\cos u$	1
16.6.5	$\text{sd}(u m)$	$\sin u$	$\sinh u$
16.6.6	$\text{nd}(u m)$	1	$\cosh u$
16.6.7	$\text{dc}(u m)$	$\sec u$	1
16.6.8	$\text{nc}(u m)$	$\sec u$	$\cosh u$
16.6.9	$\text{sc}(u m)$	$\tan u$	$\sinh u$
16.6.10	$\text{ns}(u m)$	$\csc u$	$\coth u$
16.6.11	$\text{ds}(u m)$	$\csc u$	$\text{csch } u$
16.6.12	$\text{cs}(u m)$	$\cot u$	$\text{csch } u$
16.6.13	$\text{am}(u m)$	u	$\text{gd } u$

*See page II.

16.9. Relations Between the Squares of the Functions

16.9.1 $-\text{dn}^2 u + m_1 = -m \text{cn}^2 u = m \text{sn}^2 u - m$

16.9.2 $-m_1 \text{nd}^2 u + m_1 = -m m_1 \text{sd}^2 u = m \text{cd}^2 u - m$

16.9.3 $m_1 \text{sc}^2 u + m_1 = m_1 \text{nc}^2 u = \text{dc}^2 u - m$

16.9.4 $\text{cs}^2 u + m_1 = \text{ds}^2 u = \text{ns}^2 u - m$

In using the above results remember that $m + m_1 = 1$.

If $pq u$, $rt u$ are any two of the twelve functions, one entry expresses $tq^2 u$ in terms of $pq^2 u$ and another expresses $qt^2 u$ in terms of $rt^2 u$. Since $tq^2 u \cdot qt^2 u = 1$, we can obtain from the table the bilinear relation between $pq^2 u$ and $rt^2 u$. Thus for the functions $cd u$, $sn u$ we have

16.9.5 $\text{nd}^2 u = \frac{1 - m \text{cd}^2 u}{m_1}$, $\text{dn}^2 u = 1 - m \text{sn}^2 u$

and therefore

16.9.6 $(1 - m \text{cd}^2 u)(1 - m \text{sn}^2 u) = m_1$.

16.10. Change of Parameter

Negative Parameter

If m is a positive number, let

16.10.1 $\mu = \frac{m}{1+m}$, $\mu_1 = \frac{1}{1+m}$, $v = \frac{u}{\mu_1}$ ($0 < \mu < 1$)

16.10.2 $\text{sn}(u|m) = \mu_1 \text{sd}(v|\mu)$

16.10.3 $\text{cn}(u|m) = \text{cd}(v|\mu)$

16.10.4 $\text{dn}(u|m) = \text{nd}(v|\mu)$.

16.11. Reciprocal Parameter (Jacobi's Real Transformation)

16.11.1 $m > 0$, $\mu = m^{-1}$, $v = um^{1/2}$

16.11.2 $\text{sn}(u|m) = \mu^{1/2} \text{sn}(v|\mu)$

16.11.3 $\text{cn}(u|m) = \text{dn}(v|\mu)$

16.11.4 $\text{dn}(u|m) = \text{cn}(v|\mu)$

Here if $m > 1$ then $m^{-1} = \mu < 1$.

Thus elliptic functions whose parameter is real can be made to depend on elliptic functions whose parameter lies between 0 and 1.

16.12. Descending Landen Transformation (Gauss' Transformation)

To decrease the parameter, let

16.12.1 $\mu = \left(\frac{1 - m_1^{1/2}}{1 + m_1^{1/2}}\right)^2$, $v = \frac{u}{1 + \mu^{1/2}}$,

then

16.12.2 $\text{sn}(u|m) = \frac{(1 + \mu^{1/2}) \text{sn}(v|\mu)}{1 + \mu^{1/2} \text{sn}^2(v|\mu)}$

16.12.3 $\text{cn}(u|m) = \frac{\text{cn}(v|\mu) \text{dn}(v|\mu)}{1 + \mu^{1/2} \text{sn}^2(v|\mu)}$

16.12.4 $\text{dn}(u|m) = \frac{\text{dn}^2(v|\mu) - (1 - \mu^{1/2})}{(1 + \mu^{1/2}) - \text{dn}^2(v|\mu)}$

Note that successive applications can be made conveniently to find $\text{sn}(u|m)$ in terms of $\text{sn}(v|\mu)$ and $\text{dn}(u|m)$ in terms of $\text{dn}(v|\mu)$, but that the calculation of $\text{cn}(u|m)$ requires all three functions.

16.13. Approximation in Terms of Circular Functions

When the parameter m is so small that we may neglect m^2 and higher powers, we have the approximations

16.13.1

$\text{sn}(u|m) \approx \sin u - \frac{1}{4} m(u - \sin u \cos u) \cos u$

16.13.2

$\text{cn}(u|m) \approx \cos u + \frac{1}{4} m(u - \sin u \cos u) \sin u$

16.13.3

$\text{dn}(u|m) \approx 1 - \frac{1}{2} m \sin^2 u$

16.13.4

$\text{am}(u|m) \approx u - \frac{1}{4} m(u - \sin u \cos u)$.

One way of calculating the Jacobian functions is to use Landen's descending transformation to reduce the parameter sufficiently for the above formulae to become applicable. See also 16.14.

16.14. Ascending Landen Transformation

To increase the parameter, let

16.14.1 $\mu = \frac{4m^{1/2}}{(1+m^{1/2})^2}$, $\mu_1 = \left(\frac{1-m^{1/2}}{1+m^{1/2}}\right)^2$, $v = \frac{u}{1+\mu_1^{1/2}}$

16.14.2 $\text{sn}(u|m) = (1 + \mu_1^{1/2}) \frac{\text{sn}(v|\mu) \text{cn}(v|\mu)}{\text{dn}(v|\mu)}$

16.14.3 $\text{cn}(u|m) = \frac{1 + \mu_1^{1/2}}{\mu} \frac{\text{dn}^2(v|\mu) - \mu_1^{1/2}}{\text{dn}(v|\mu)}$

16.14.4 $\text{dn}(u|m) = \frac{1 - \mu_1^{1/2}}{\mu} \frac{\text{dn}^2(v|\mu) + \mu_1^{1/2}}{\text{dn}(v|\mu)}$

Note that, when successive applications are to be made, it is simplest to calculate $\text{dn}(u|m)$ since this is expressed always in terms of the same function. The calculation of $\text{cn}(u|m)$ leads to that of $\text{dn}(v|\mu)$.

The calculation of $\text{sn}(u|m)$ necessitates the evaluation of all three functions.

16.15. Approximation in Terms of Hyperbolic Functions

When the parameter m is so close to unity that m_1^2 and higher powers of m_1 can be neglected we have the approximations

16.15.1

$$\text{sn}(u|m) \approx \tanh u + \frac{1}{4} m_1 (\sinh u \cosh u - u) \text{sech}^2 u$$

16.15.2

$$\text{cn}(u|m) \approx \text{sech } u - \frac{1}{4} m_1 (\sinh u \cosh u - u) \tanh u \text{sech } u$$

16.15.3

$$\text{dn}(u|m) \approx \text{sech } u + \frac{1}{4} m_1 (\sinh u \cosh u + u) \tanh u \text{sech } u$$

16.15.4

$$\text{am}(u|m) \approx \text{gd } u + \frac{1}{4} m_1 (\sinh u \cosh u - u) \text{sech } u.$$

Another way of calculating the Jacobian functions is to use Landen's ascending transformation to increase the parameter sufficiently for the above formulae to become applicable. See also 16.13.

16.16. Derivatives

	Function	Derivative	
16.16.1	$\text{sn } u$	$\text{cn } u \text{ dn } u$	Pole n
16.16.2	$\text{cn } u$	$-\text{sn } u \text{ dn } u$	
16.16.3	$\text{dn } u$	$-m \text{ sn } u \text{ cn } u$	
16.16.4	$\text{cd } u$	$-m_1 \text{ sd } u \text{ nd } u$	Pole d
16.16.5	$\text{sd } u$	$\text{cd } u \text{ nd } u$	
16.16.6	$\text{nd } u$	$m \text{ sd } u \text{ cd } u$	
16.16.7	$\text{dc } u$	$m_1 \text{ sc } u \text{ nc } u$	Pole c
16.16.8	$\text{nc } u$	$\text{sc } u \text{ dc } u$	
16.16.9	$\text{sc } u$	$\text{dc } u \text{ nc } u$	
16.16.10	$\text{ns } u$	$-\text{ds } u \text{ cs } u$	Pole s
16.16.11	$\text{ds } u$	$-\text{cs } u \text{ ns } u$	
16.16.12	$\text{cs } u$	$-\text{ns } u \text{ ds } u$	

Note that the derivative is proportional to the product of the two copolar functions.

16.17. Addition Theorems

16.17.1 $\text{sn}(u+v)$

$$\frac{\text{sn } u \cdot \text{cn } v \cdot \text{dn } v + \text{sn } v \cdot \text{cn } u \cdot \text{dn } u}{1 - m \text{ sn}^2 u \cdot \text{sn}^2 v}$$

16.17.2 $\text{cn}(u+v)$

$$\frac{\text{cn } u \cdot \text{cn } v - \text{sn } u \cdot \text{dn } u \cdot \text{sn } v \cdot \text{dn } v}{1 - m \text{ sn}^2 u \cdot \text{sn}^2 v}$$

16.17.3 $\text{dn}(u+v) = \frac{\text{dn } u \cdot \text{dn } v - m \text{ sn } u \cdot \text{cn } u \cdot \text{sn } v \cdot \text{cn } v}{1 - m \text{ sn}^2 u \cdot \text{sn}^2 v}$

Addition theorems are derivable one from another and are expressible in a great variety of forms. Thus $\text{ns}(u+v)$ comes from $1/\text{sn}(u+v)$ in the form $(1 - m \text{ sn}^2 u \text{ sn}^2 v) / (\text{sn } u \text{ cn } v \text{ dn } v + \text{sn } v \text{ cn } u \text{ dn } u)$ from 16.17.1.

Alternatively $\text{ns}(u+v) = m^{1/2} \text{sn} \{ (iK' - u) - v \}$ which again from 16.17.1 yields the form $(\text{ns } u \text{ cs } v \text{ ds } v - \text{ns } v \text{ cs } u \text{ ds } u) / (\text{ns}^2 u - \text{ns}^2 v)$.

The function $\text{pq}(u+v)$ is a rational function of the four functions $\text{pq } u, \text{pq } v, \text{pq}' u, \text{pq}' v$.

16.18. Double Arguments

16.18.1 $\text{sn } 2u$

$$\frac{2 \text{sn } u \cdot \text{cn } u \cdot \text{dn } u}{1 - m \text{ sn}^4 u} = \frac{2 \text{sn } u \cdot \text{cn } u \cdot \text{dn } u}{\text{cn}^2 u + \text{sn}^2 u \cdot \text{dn}^2 u}$$

16.18.2 $\text{cn } 2u$

$$\frac{\text{cn}^2 u - \text{sn}^2 u \cdot \text{dn}^2 u}{1 - m \text{ sn}^4 u} = \frac{\text{cn}^2 u - \text{sn}^2 u \cdot \text{dn}^2 u}{\text{cn}^2 u + \text{sn}^2 u \cdot \text{dn}^2 u}$$

16.18.3 $\text{dn } 2u$

$$\frac{\text{dn}^2 u - m \text{ sn}^2 u \cdot \text{cn}^2 u}{1 - m \text{ sn}^4 u} = \frac{\text{dn}^2 u + \text{cn}^2 u (\text{dn}^2 u - 1)}{\text{dn}^2 u - \text{cn}^2 u (\text{dn}^2 u - 1)}$$

16.18.4 $\frac{1 - \text{cn } 2u}{1 + \text{cn } 2u} = \frac{\text{sn}^2 u \cdot \text{dn}^2 u}{\text{cn}^2 u}$

16.18.5 $\frac{1 - \text{dn } 2u}{1 + \text{dn } 2u} = \frac{m \text{ sn}^2 u \cdot \text{cn}^2 u}{\text{dn}^2 u}$

16.19. Half Arguments

16.19.1 $\text{sn}^2 \frac{1}{2} u = \frac{1 - \text{cn } u}{1 + \text{dn } u}$

16.19.2 $\text{cn}^2 \frac{1}{2} u = \frac{\text{dn } u + \text{cn } u}{1 + \text{dn } u}$

16.19.3 $\text{dn}^2 \frac{1}{2} u = \frac{m_1 + \text{dn } u + m \text{ cn } u}{1 + \text{dn } u}$

16.20. Jacobi's Imaginary Transformation

16.20.1 $\text{sn}(iu|m) = i \text{sc}(u|m_1)$

16.20.2 $\text{cn}(iu|m) = \text{nc}(u|m_1)$

16.20.3 $\text{dn}(iu|m) = \text{dc}(u|m_1)$

16.21. Complex Arguments

With the abbreviations

16.21.1

$$s = \text{sn}(x|m), c = \text{cn}(x|m), d = \text{dn}(x|m), s_1 = \text{sn}(y|m_1), \\ c_1 = \text{cn}(y|m_1), d_1 = \text{dn}(y|m_1)$$

16.21.2 $\text{sn}(x+iy|m) = \frac{s \cdot d_1 + ic \cdot d \cdot s_1 \cdot c_1}{c_1^2 + ms^2 \cdot s_1^2}$

16.21.3 $\text{cn}(x+iy|m) = \frac{c \cdot c_1 - is \cdot d \cdot s_1 \cdot d_1}{c_1^2 + ms^2 \cdot s_1^2}$

16.21.4 $\text{dn}(x+iy|m) = \frac{d \cdot c_1 \cdot d_1 - im s \cdot c \cdot s_1}{c_1^2 + ms^2 \cdot s_1^2}$

16.22. Leading Terms of the Series in Ascending Powers of u

16.22.1

$$\text{sn}(u|m) = u - (1+m) \frac{u^3}{3!} + (1+14m+m^2) \frac{u^5}{5!} \\ - (1+135m+135m^2+m^3) \frac{u^7}{7!} + \dots$$

16.22.2

$$\text{cn}(u|m) = 1 - \frac{u^2}{2!} + (1+4m) \frac{u^4}{4!} \\ - (1+44m+16m^2) \frac{u^6}{6!} + \dots$$

16.22.3

$$\text{dn}(u|m) = 1 - m \frac{u^2}{2!} + m(4+m) \frac{u^4}{4!} \\ - m(16+44m+m^2) \frac{u^6}{6!} + \dots$$

No formulae are known for the general coefficients in these series.

16.23. Series Expansions in Terms of the Nome $q = e^{-\pi K'/K}$ and the Argument $v = \pi u/(2K)$

16.23.1 $\text{sn}(u|m) = \frac{2\pi}{m^{1/2}K} \sum_{n=0}^{\infty} \frac{q^{n+1/2}}{1-q^{2n+1}} \sin(2n+1)v$

16.23.2 $\text{cn}(u|m) = \frac{2\pi}{m^{1/2}K} \sum_{n=0}^{\infty} \frac{q^{n+1/2}}{1+q^{2n+1}} \cos(2n+1)v$

16.23.3 $\text{dn}(u|m) = \frac{\pi}{2K} + \frac{2\pi}{K} \sum_{n=1}^{\infty} \frac{q^n}{1+q^{2n}} \cos 2nv$

16.23.4

$$\text{cd}(u|m) = \frac{2\pi}{m^{1/2}K} \sum_{n=0}^{\infty} \frac{(-1)^n q^{n+1/2}}{1-q^{2n+1}} \cos(2n+1)v$$

16.23.5

$$\text{sd}(u|m) = \frac{2\pi}{(mm_1)^{1/2}K} \sum_{n=0}^{\infty} (-1)^n \frac{q^{n+1/2}}{1+q^{2n+1}} \sin(2n+1)v$$

16.23.6

$$\text{nd}(u|m) = \frac{\pi}{2m_1^{1/2}K} + \frac{2\pi}{m_1^{1/2}K} \sum_{n=1}^{\infty} (-1)^n \frac{q^n}{1+q^{2n}} \cos 2nv$$

16.23.7

$$\text{dc}(u|m) = \frac{\pi}{2K} \sec v \\ + \frac{2\pi}{K} \sum_{n=0}^{\infty} (-1)^n \frac{q^{2n+1}}{1-q^{2n+1}} \cos(2n+1)v$$

16.23.8

$$\text{nc}(u|m) = \frac{\pi}{2m_1^{1/2}K} \sec v \\ - \frac{2\pi}{m_1^{1/2}K} \sum_{n=0}^{\infty} (-1)^n \frac{q^{2n+1}}{1+q^{2n+1}} \cos(2n+1)v$$

16.23.9

$$\text{sc}(u|m) = \frac{\pi}{2m_1^{1/2}K} \tan v \\ + \frac{2\pi}{m_1^{1/2}K} \sum_{n=1}^{\infty} (-1)^n \frac{q^{2n}}{1+q^{2n}} \sin 2nv$$

16.23.10

$$\text{ns}(u|m) = \frac{\pi}{2K} \csc v - \frac{2\pi}{K} \sum_{n=0}^{\infty} \frac{q^{2n+1}}{1-q^{2n+1}} \sin(2n+1)v$$

16.23.11

$$\text{ds}(u|m) = \frac{\pi}{2K} \csc v - \frac{2\pi}{K} \sum_{n=0}^{\infty} \frac{q^{2n+1}}{1+q^{2n+1}} \sin(2n+1)v$$

16.23.12

$$\text{cs}(u|m) = \frac{\pi}{2K} \cot v - \frac{2\pi}{K} \sum_{n=1}^{\infty} \frac{q^{2n}}{1+q^{2n}} \sin 2nv$$

16.24. Integrals of the Twelve Jacobian Elliptic Functions

16.24.1 $\int \text{sn } u \, du = m^{-1/2} \ln(\text{dn } u - m^{1/2} \text{cn } u)$

16.24.2 $\int \text{cn } u \, du = m^{-1/2} \arccos(\text{dn } u)$

16.24.3 $\int \text{dn } u \, du = \arcsin(\text{sn } u)$

16.24.4 $\int \text{cd } u \, du = m^{-1/2} \ln(\text{nd } u + m^{1/2} \text{sd } u)$

16.24.5 $\int \text{sd } u \, du = (mm_1)^{-1/2} \arcsin(-m^{1/2} \text{cd } u)$

16.24.6 $\int \text{nd } u \, du = m_1^{-1/2} \arccos(\text{cd } u)$

16.24.7 $\int \text{dc } u \, du = \ln(\text{nc } u + \text{sc } u)$

16.24.8 $\int \text{nc } u \, du = m_1^{-1/2} \ln(\text{dc } u + m_1^{1/2} \text{sc } u)$

16.24.9 $\int \text{sc } u \, du = m_1^{-1/2} \ln(\text{dc } u + m_1^{1/2} \text{nc } u)$

16.24.10 $\int \text{ns } u \, du = \ln(\text{ds } u - \text{cs } u)$

16.24.11 $\int \text{ds } u \, du = \ln(\text{ns } u - \text{cs } u)$

16.24.12 $\int \text{cs } u \, du = \ln(\text{ns } u - \text{ds } u)$

In numerical use of the above table certain restrictions must be put on u in order to keep the arguments of the logarithms positive and to avoid

trouble with many-valued inverse circular functions.

16.25. Notation for the Integrals of the Squares of the Twelve Jacobian Elliptic Functions

16.25.1 $Pq u = \int_0^u pq^2t dt$ when $q \neq s$

16.25.2 $Ps u = \int_0^u \left(pq^2t - \frac{1}{t^2} \right) dt - \frac{1}{u}$

Examples

$Cd u = \int_0^u cd^2t dt, Ns u = \int_0^u \left(ns^2t - \frac{1}{t^2} \right) dt - \frac{1}{u}$

16.26. Integrals in Terms of the Elliptic Integral of the Second Kind (see 17.4)

16.26.1 $mSn u = -E(u) + u$

16.26.2 $mCn u = E(u) - m_1u$ Pole n

16.26.3 $Dn u = E(u)$

16.26.4 $mCd u = -E(u) + u + msn u cd u$

16.26.5 $mm_1Sd u = E(u) - m_1u - msn u cd u$ Pole d

16.26.6 $m_1Nd u = E(u) - msn u cd u$

16.26.7 $Dc u = -E(u) + u + sn u dc u$

16.26.8 $m_1Nc u = -E(u) + m_1u + sn u dc u$ Pole c

16.26.9 $m_1Sc u = -E(u) + sn u dc u$

16.26.10 $Ns u = -E(u) + u - cn u ds u$

16.26.11 $Ds u = -E(u) + m_1u - cn u ds u$ Pole s

16.26.12 $Cs u = -E(u) - cn u ds u$

All the above may be expressed in terms of Jacobi's zeta function (see 17.4.27).

$$Z(u) = E(u) - \frac{E}{K}u, \text{ where } E = E(K)$$

16.27. Theta Functions; Expansions in Terms of the Nome q

16.27.1 $\vartheta_1(z, q) = \vartheta_1(z) = 2q^{1/4} \sum_{n=0}^{\infty} (-1)^n q^{n(n+1)} \sin(2n+1)z$

16.27.2 $\vartheta_2(z, q) = \vartheta_2(z) = 2q^{1/4} \sum_{n=0}^{\infty} q^{n(n+1)} \cos(2n+1)z$

16.27.3 $\vartheta_3(z, q) = \vartheta_3(z) = 1 + 2 \sum_{n=1}^{\infty} q^{n^2} \cos 2nz$

16.27.4 $\vartheta_4(z, q) = \vartheta_4(z) = 1 + 2 \sum_{n=1}^{\infty} (-1)^n q^{n^2} \cos 2nz$

Theta functions are important because every one of the Jacobian elliptic functions can be expressed as the ratio of two theta functions. See 16.36.

The notation shows these functions as depending on the variable z and the nome $q, |q| < 1$. In this case, here and elsewhere, the convergence is not dependent on the trigonometrical terms. In their relation to the Jacobian elliptic functions, we note that the nome q is given by

$$q = e^{-\pi K'/K},$$

where K and iK' are the quarter periods. Since $q = q(m)$ is determined when the parameter m is given, we can also regard the theta functions as dependent upon m and then we write

$$\vartheta_a(z, q) = \vartheta_a(z|m), a = 1, 2, 3, 4$$

but when no ambiguity is to be feared, we write $\vartheta_a(z)$ simply.

The above notations are those given in Modern Analysis [16.6].

There is a bewildering variety of notations, for example the function $\vartheta_4(z)$ above is sometimes denoted by $\vartheta_0(z)$ or $\vartheta(z)$; see the table given in Modern Analysis [16.6]. Further the argument $u = 2Kz/\pi$ is frequently used so that in consulting books caution should be exercised.

16.28. Relations Between the Squares of the Theta Functions

16.28.1 $\vartheta_1^2(z)\vartheta_4^2(0) = \vartheta_3^2(z)\vartheta_2^2(0) - \vartheta_2^2(z)\vartheta_3^2(0)$

16.28.2 $\vartheta_2^2(z)\vartheta_4^2(0) = \vartheta_4^2(z)\vartheta_2^2(0) - \vartheta_1^2(z)\vartheta_3^2(0)$

16.28.3 $\vartheta_3^2(z)\vartheta_4^2(0) = \vartheta_4^2(z)\vartheta_3^2(0) - \vartheta_2^2(z)\vartheta_1^2(0)$

16.28.4 $\vartheta_4^2(z)\vartheta_4^2(0) = \vartheta_3^2(z)\vartheta_2^2(0) - \vartheta_2^2(z)\vartheta_3^2(0)$

16.28.5 $\vartheta_2^4(0) + \vartheta_4^4(0) = \vartheta_3^4(0)$

Note also the important relation

16.28.6 $\vartheta_1'(0) = \vartheta_2(0)\vartheta_3(0)\vartheta_4(0)$ or $\vartheta_1' = \vartheta_2\vartheta_3\vartheta_4$

16.29. Logarithmic Derivatives of the Theta Functions

16.29.1 $\frac{\vartheta_1'(u)}{\vartheta_1(u)} = \cot u + 4 \sum_{n=1}^{\infty} \frac{q^{2n}}{1 - q^{2n}} \sin 2nu$

16.29.2

$$\frac{\vartheta_2'(u)}{\vartheta_2(u)} = -\tan u + 4 \sum_{n=1}^{\infty} (-1)^n \frac{q^{2n}}{1-q^{2n}} \sin 2nu$$

16.29.3 $\frac{\vartheta_3'(u)}{\vartheta_3(u)} = 4 \sum_{n=1}^{\infty} (-1)^n \frac{q^n}{1-q^{2n}} \sin 2nu$

16.29.4 $\frac{\vartheta_4'(u)}{\vartheta_4(u)} = 4 \sum_{n=1}^{\infty} \frac{q^n}{1-q^{2n}} \sin 2nu$

16.30. Logarithms of Theta Functions of Sum and Difference

16.30.1

$$\ln \frac{\vartheta_1(\alpha+\beta)}{\vartheta_1(\alpha-\beta)} = \ln \frac{\sin(\alpha+\beta)}{\sin(\alpha-\beta)} + 4 \sum_{n=1}^{\infty} \frac{1}{n} \frac{q^{2n}}{1-q^{2n}} \sin 2n\alpha \sin 2n\beta$$

16.30.2

$$\ln \frac{\vartheta_2(\alpha+\beta)}{\vartheta_2(\alpha-\beta)} = \ln \frac{\cos(\alpha+\beta)}{\cos(\alpha-\beta)} + 4 \sum_{n=1}^{\infty} \frac{(-1)^n}{n} \frac{q^{2n}}{1-q^{2n}} \sin 2n\alpha \sin 2n\beta$$

16.30.3

$$\ln \frac{\vartheta_3(\alpha+\beta)}{\vartheta_3(\alpha-\beta)} = 4 \sum_{n=1}^{\infty} \frac{(-1)^n}{n} \frac{q^n}{1-q^{2n}} \sin 2n\alpha \sin 2n\beta$$

16.30.4

$$\ln \frac{\vartheta_4(\alpha+\beta)}{\vartheta_4(\alpha-\beta)} = 4 \sum_{n=1}^{\infty} \frac{1}{n} \frac{q^n}{1-q^{2n}} \sin 2n\alpha \sin 2n\beta$$

The corresponding expressions when $\beta = i\gamma$ are easily deduced by use of the formulae 4.3.55 and 4.3.56.

16.31. Jacobi's Notation for Theta Functions

16.31.1 $\Theta(u|m) = \Theta(u) = \vartheta_4(v), \quad v = \frac{\pi u}{2K}$

16.31.2 $\Theta_1(u|m) = \Theta_1(u) = \vartheta_3(v) = \Theta(u+K)$

16.31.3 $H(u|m) = H(u) = \vartheta_1(v)$

16.31.4 $H_1(u|m) = H_1(u) = \vartheta_2(v) = H(u+K)$

16.32. Calculation of Jacobi's Theta Function $\Theta(u|m)$ by Use of the Arithmetic-Geometric Mean

Form the A.G.M. scale starting with

16.32.1 $a_0 = 1, b_0 = \sqrt{m_1}, c_0 = \sqrt{m}$

terminating with the N th step when c_N is negligible to the accuracy required. Find φ_N in degrees, where

16.32.2 $\varphi_N = 2^N a_N u \frac{180^\circ}{\pi}$

and then compute successively $\varphi_{N-1}, \varphi_{N-2}, \dots, \varphi_1, \varphi_0$ from the recurrence relation

16.32.3 $\sin(2\varphi_{n-1} - \varphi_n) = \frac{c_n}{a_n} \sin \varphi_n.$

Then

16.32.4

$$\ln \Theta(u|m) = \frac{1}{2} \ln \frac{2m_1^{1/2}K(m)}{\pi} + \frac{1}{2} \ln \frac{\cos(\varphi_1 - \varphi_0)}{\cos \varphi_0} + \frac{1}{4} \ln \sec(2\varphi_0 - \varphi_1) + \frac{1}{8} \ln \sec(2\varphi_1 - \varphi_2) + \dots + \frac{1}{2^{N+1}} \ln \sec(2\varphi_{N-1} - \varphi_N)$$

16.33. Addition of Quarter-Periods to Jacobi's Eta and Theta Functions

u	$-u$	$u+K$	$u+2K$	$u+iK'$	$u+2iK'$	$u+K+iK'$	$u+2K+2iK'$
16.33.1 $H(u)$	$-H(u)$	$H_1(u)$	$-H(u)$	$iM(u)\Theta(u)$	$-N(u)H(u)$	$M(u)\Theta_1(u)$	$N(u)H(u)$
16.33.2 $H_1(u)$	$H_1(u)$	$-H(u)$	$-H_1(u)$	$M(u)\Theta_1(u)$	$N(u)H_1(u)$	$-iM(u)\Theta(u)$	$-N(u)H_1(u)$
16.33.3 $\Theta_1(u)$	$\Theta_1(u)$	$\Theta(u)$	$\Theta_1(u)$	$M(u)H_1(u)$	$N(u)\Theta_1(u)$	$iM(u)H(u)$	$N(u)\Theta_1(u)$
16.33.4 $\Theta(u)$	$\Theta(u)$	$\Theta_1(u)$	$\Theta(u)$	$iM(u)H(u)$	$-N(u)\Theta(u)$	$M(u)H_1(u)$	$-N(u)\Theta(u)$

where

$$M(u) = \left[\exp\left(-\frac{\pi i u}{2K}\right) \right] q^{-1/2},$$

$$N(u) = \left[\exp\left(-\frac{\pi i u}{K}\right) \right] q^{-1}$$

$H(u)$ and $H_1(u)$ have the period $4K$. $\Theta(u)$ and $\Theta_1(u)$ have the period $2K$.

$2iK'$ is a quasi-period for all four functions, that is to say, increase of the argument by $2iK'$ multiplies the function by a factor.

16.34. Relation of Jacobi's Zeta Function to the Theta Functions

$$Z(u) = \frac{\partial}{\partial u} \ln \Theta(u)$$

16.34.1
$$Z(u) = \frac{\pi}{2K} \frac{\vartheta_1' \left(\frac{\pi u}{2K} \right)}{\vartheta_1 \left(\frac{\pi u}{2K} \right)} - \frac{\operatorname{cn} u \operatorname{dn} u}{\operatorname{sn} u}$$

16.34.2
$$= \frac{\pi}{2K} \frac{\vartheta_2' \left(\frac{\pi u}{2K} \right)}{\vartheta_2 \left(\frac{\pi u}{2K} \right)} + \frac{\operatorname{dn} u \operatorname{sn} u}{\operatorname{cn} u}$$

16.34.3
$$= \frac{\pi}{2K} \frac{\vartheta_3' \left(\frac{\pi u}{2K} \right)}{\vartheta_3 \left(\frac{\pi u}{2K} \right)} - m \frac{\operatorname{sn} u \operatorname{cn} u}{\operatorname{dn} u}$$

16.34.4
$$= \frac{\pi}{2K} \frac{\vartheta_4' \left(\frac{\pi u}{2K} \right)}{\vartheta_4 \left(\frac{\pi u}{2K} \right)}$$

16.35. Calculation of Jacobi's Zeta Function $Z(u|m)$ by Use of the Arithmetic-Geometric Mean

Form the A.G.M. scale 17.6 starting with

16.35.1
$$a_0 = 1, b_0 = \sqrt{m}, c_0 = \sqrt{m}$$

terminating at the N th step when c_N is negligible to the accuracy required. Find φ_N in degrees where

16.35.2
$$\varphi_N = 2^N a_N u \frac{180^\circ}{\pi}$$

and then compute successively $\varphi_{N-1}, \varphi_{N-2}, \dots, \varphi_1, \varphi_0$ from the recurrence relation

16.35.3
$$\sin(2\varphi_{n-1} - \varphi_n) = \frac{c_n}{a_n} \sin \varphi_n.$$

Then

16.35.4

$$Z(u|m) = c_1 \sin \varphi_1 + c_2 \sin \varphi_2 + \dots + c_N \sin \varphi_N.$$

16.36. Neville's Notation for Theta Functions

These functions are defined in terms of Jacobi's theta functions of 16.31 by

16.36.1
$$\vartheta_s(u) = \frac{H(u)}{H'(0)}, \vartheta_c(u) = \frac{H(u+K)}{H(K)}$$

16.36.2
$$\vartheta_d(u) = \frac{\Theta(u+K)}{\Theta(K)}, \vartheta_n(u) = \frac{\Theta(u)}{\Theta(0)}$$

If λ, μ are any integers positive, negative, or zero the points $u_0 + 2\lambda K + 2\mu iK'$ are said to be congruent to u_0 .

$\vartheta_s(u)$ has zeros at the points congruent to 0
 $\vartheta_c(u)$ has zeros at the points congruent to K
 $\vartheta_n(u)$ has zeros at the points congruent to iK'
 $\vartheta_d(u)$ has zeros at the points congruent to $K + iK'$

Thus the suffix secures that the function $\vartheta_p(u)$ has zeros at the points marked p in the introductory diagram in 16.1.2, and the constant by which Jacobi's function is divided secures that the leading coefficient of $\vartheta_p(u)$ at the origin is unity. Therefore the functions have the fundamentally important property that if p, q are any two of the letters s, c, n, d, the Jacobian elliptic function $pq u$ is given by

16.36.3
$$pq u = \frac{\vartheta_p(u)}{\vartheta_q(u)}$$

These functions also have the property

16.36.4
$$m_1^{-1/4} \vartheta_c(K-u) = \vartheta_s(u)$$

16.36.5
$$m_1^{-1/4} \vartheta_d(K-u) = \vartheta_n(u),$$

for complementary arguments u and $K-u$.

In terms of the theta functions defined in 16.27, let $v = \pi u / (2K)$, then

16.36.6
$$\vartheta_s(u) = \frac{2K \vartheta_1(v)}{\vartheta_1'(0)}, \vartheta_c(u) = \frac{\vartheta_2(v)}{\vartheta_2(0)}$$

16.36.7
$$\vartheta_d(u) = \frac{\vartheta_3(v)}{\vartheta_3(0)}, \vartheta_n(u) = \frac{\vartheta_4(v)}{\vartheta_4(0)}$$

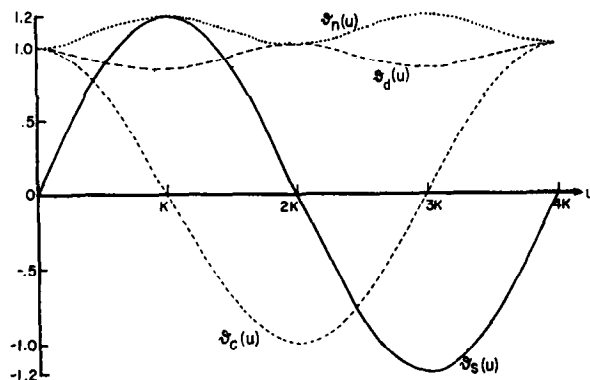

FIGURE 16.4. Neville's theta functions $\vartheta_s(u), \vartheta_c(u), \vartheta_d(u), \vartheta_n(u)$
 $m = \frac{1}{2}$

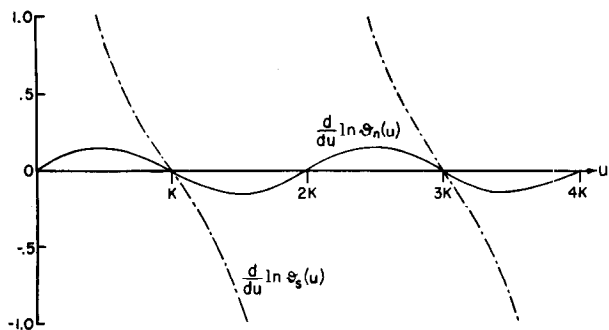

FIGURE 16.5. Logarithmic derivatives of theta functions

$$\frac{d}{du} \ln \vartheta_s(u), \frac{d}{du} \ln \vartheta_n(u)$$

$$m = \frac{1}{2}$$

16.37. Expression as Infinite Products

$$q = q(m), v = \pi u / (2K)$$

16.37.1

$$\vartheta_s(u) = \left(\frac{16q}{m m_1}\right)^{1/6} \sin v \prod_{n=1}^{\infty} (1 - 2q^{2n} \cos 2v + q^{4n})$$

16.37.2

$$\vartheta_c(u) = \left(\frac{16q m_1^{1/2}}{m}\right)^{1/6} \cos v \prod_{n=1}^{\infty} (1 + 2q^{2n} \cos 2v + q^{4n})$$

16.37.3

$$\vartheta_d(u) = \left(\frac{m m_1}{16q}\right)^{1/12} \prod_{n=1}^{\infty} (1 + 2q^{2n-1} \cos 2v + q^{4n-2})$$

16.37.4

$$\vartheta_n(u) = \left(\frac{m}{16q m_1^2}\right)^{1/12} \prod_{n=1}^{\infty} (1 - 2q^{2n-1} \cos 2v + q^{4n-2})$$

16.38. Expression as Infinite Series

$$\text{Let } v = \pi u / (2K)$$

16.38.1

$$\vartheta_s(u) = \left[\frac{2\pi q^{1/2}}{m^{1/2} m_1^{1/2} K}\right]^{1/2} \sum_{n=0}^{\infty} (-1)^n q^{n(n+1)} \sin (2n+1)v$$

16.38.2 $\vartheta_c(u) = \left[\frac{2\pi q^{1/2}}{m^{1/2} K}\right]^{1/2} \sum_{n=0}^{\infty} q^{n(n+1)} \cos (2n+1)v$

16.38.3 $\vartheta_d(u) = \left[\frac{\pi}{2K}\right]^{1/2} \left\{1 + 2 \sum_{n=1}^{\infty} q^{n^2} \cos 2nv\right\}$

16.38.4

$$\vartheta_n(u) = \left[\frac{\pi}{2m_1^{1/2} K}\right]^{1/2} \left\{1 + 2 \sum_{n=1}^{\infty} (-1)^n q^{n^2} \cos 2nv\right\}$$

16.38.5 $(2K/\pi)^{1/2} = 1 + 2q + 2q^4 + 2q^9 + \dots = \vartheta_3(0, q)$

16.38.6

$$(2K'/\pi)^{1/2} = 1 + 2q_1 + 2q_1^4 + 2q_1^9 + \dots = \vartheta_3(0, q_1)$$

16.38.7

$$(2m^{1/2} K/\pi)^{1/2} = 2q^{1/4} (1 + q^2 + q^6 + q^{12} + q^{20} + \dots) = \vartheta_2(0, q)$$

16.38.8

$$(2m_1^{1/2} K/\pi)^{1/2} = 1 - 2q + 2q^4 - 2q^9 + \dots = \vartheta_4(0, q).$$

Numerical Methods

16.39. Use and Extension of the Tables

Example 1. Calculate $nc(1.99650|.64)$ to 4S. From Table 17.1, $1.99650 = K + .001$. From the table of principal terms

$$nc u = -m_1^{-1/2} / (u - K) + \dots$$

$$nc(K + .001|.64) = \frac{-(.36)^{-1/2}}{.001} + \dots$$

$$= -\frac{10000}{6} + \dots$$

$$= -1667 + \dots$$

and since the next term is of order .001 this value -1667 is correct to at least 4S.

Example 2. Use the descending Landen transformation to calculate $dn(.20|.19)$ to 6D.

Here $m = .19$, $m_1^{1/2} = .9$ and so from 16.12.1

$$\mu = \left(\frac{1}{19}\right)^2, 1 + \mu^{1/2} = \frac{20}{19}, v = .19.$$

Also

$$\mu^2 = \left(\frac{1}{19}\right)^4 = 10^{-6} \times 7.67$$

which is negligible.

From 16.12.4

$$dn(.20|.19) = \frac{dn^2 \left[.19 \left| \left(\frac{1}{19}\right)^2 \right. \right] - \left(1 - \frac{1}{19}\right)}{\left(1 + \frac{1}{19}\right) - dn^2 \left[.19 \left| \left(\frac{1}{19}\right)^2 \right. \right]}$$

Now from 16.13.3

$$dn \left[.19 \left| \left(\frac{1}{19}\right)^2 \right. \right] = .999951$$

whence $dn(.20|.19) = .996253$.

Example 3. Use the ascending Landen transformation to calculate $dn(.20|.81)$ to 5D.

From 16.14.1

$$\mu = \frac{4(.9)}{(1.9)^2} = \frac{360}{361}, \mu_1 = \left(\frac{1}{19}\right)^2$$

$$1 + \mu_1^{1/2} = \frac{20}{19}, v = \frac{19}{20} \times .20 = .19,$$

μ_1^2 is negligible to 4D. Thus

$$\operatorname{dn}(.20|.81) = \frac{19}{20} \times \frac{\operatorname{dn}^2\left(.19 \left| \frac{360}{361} \right.\right) + \frac{1}{19}}{\operatorname{dn}\left(.19 \left| \frac{360}{361} \right.\right)}$$

From 16.15.3

$$\begin{aligned} \operatorname{dn}\left(.19 \left| \frac{360}{361} \right.\right) &= \operatorname{sech}(.19) + \frac{1}{4} \times \frac{1}{361} \tanh .19 \operatorname{sech} .19 \\ &\quad [\sinh .19 \cosh .19 + .19] \\ &= .982218 + \frac{1}{4} \times \frac{1}{361} (.187746)(.982218) \\ &\quad [(.191145)(1.01810) + .19] \\ &= .982218 + \frac{1}{4} \times \frac{1}{361} (.184408)[.384605] \\ &= .982218 + .000049 = .982267. \end{aligned}$$

Thus $\operatorname{dn}(.20|.81) = .98406$.

Example 4. Use the ascending Landen transformation to calculate $\operatorname{cn}(.20|.81)$ to 6D.

Using 16.14.4, we calculate $\operatorname{dn}(.20|.81)$ and deduce $\operatorname{cn}(.20|.81)$ from 16.14.3 settling the sign from Figure 16.1.

As in the preceding example, we reduce the calculation of $\operatorname{dn}(.20|.81)$ to that of $\operatorname{dn}\left(.19 \left| \frac{360}{361} \right.\right)$, when

$$\operatorname{dn}\left(.19 \left| \frac{360}{361} \right.\right) = .982267$$

$$\operatorname{dn}(.20|.81) = .984056$$

$$\operatorname{cn}(.20|.81) = .980278.$$

Example 5. Use the A.G.M. scale to compute $\operatorname{dc}(.672|.36)$ to 4D.

From 16.9.6 we have $\operatorname{dc}^2(.672|.36) = .36 + \frac{.64}{1 - \operatorname{sn}^2(.672|.36)}$. We now calculate $\operatorname{sn}(.672|.36)$ by the method given in 16.4. Form the A.G.M. scale

n	a_n	b_n	c_n	$\frac{c_n}{a_n}$	φ_n	$\sin \varphi_n$	$\sin(2\varphi_{n-1} - \varphi_n)$	$2\varphi_{n-1} - \varphi_n$
0	1	.8	.6	.6	.65546	.60952		
1	.9	.89443	.1	.11111	1.2069	.93452	.10383	.10402
2	.89721	.89721	.00279	.00311	2.4117	.66679	.00207	.00207
3	.89721	.89721	0	0	4.8234	-.99384	0	0

$$\varphi_n = 2^n a_n u \quad \varphi_3 = 2^3 (.89721)(.672) = 4.8234$$

continuing until $c_n = 0$ to 5D.

Then complete as indicated in 16.4 to find φ_0 and so $\operatorname{sn} u$ and hence $\operatorname{dc} u$,

$$\varphi_0 = .65546 \quad \operatorname{sn} u = .60952 \quad \operatorname{dc} u = 1.1740.$$

Example 6. Use the A.G.M. scale to compute $\Theta(.6|.36)$ to 5D.

We use the method explained in 16.32 with $a_0 = 1$, $b_0 = .8$, $c_0 = .6$.

Computing the A.G.M. as explained in 17.6, we find

(For values of a_n, b_n, c_n , see Example 5.)

n	φ_n	$\sin \varphi_n$	$\sin(2\varphi_{n-1} - \varphi_n)$	$2\varphi_{n-1} - \varphi_n$	$\sec(2\varphi_{n-1} - \varphi_n)$	$\frac{1}{2^{n+1}} \ln \sec(2\varphi_{n-1} - \varphi_n)$
0	.58803	.55472				
1	1.0780	.88101	.09789	.09805	1.0048	.00120
2	2.1533	.83509	.00260	.00260	1.	0
3	4.3066	-.91879	0	0	1.	0

and then complete the calculation outlined in 16.32 to give

$$\begin{aligned} \ln \Theta(u|m) &= -.05734 + .02935 + .00120 \\ &= -.02679 \\ \Theta(u|m) &= .97357. \end{aligned}$$

The series expansion for Θ is preferable.

Example 7. Use the q -series to compute $\text{cs}(.53601\ 62|.09)$.

Here we use the series 16.23.12, $K=1.60804\ 862$, $q=.00589\ 414$, $v=\frac{\pi u}{2K}=\frac{\pi}{6}$ radians or 30° .

Since q^4 is negligible to 8D, we have to 7D $\text{cs}(.53601\ 62|.09)$

$$\begin{aligned} &= \frac{\pi}{2K} \cot 30^\circ - \frac{2\pi}{K} \left\{ \frac{q^2}{1+q^2} \sin 60^\circ \right\} \\ &= (.97683\ 3852)(1.73205\ 081) \\ &\quad - 3.90733\ 541[(.00003\ 4740)(.86602\ 5404)] \\ &= 1.69180\ 83. \end{aligned}$$

Example 8. Use theta functions to compute $\text{sn}(.61802|.5)$ to 5D.

Here $K(\frac{1}{2})=1.85407$

$$\epsilon^\circ = \frac{.61802}{1.85407} \times 90^\circ = 30^\circ$$

$$\sin^2 \alpha = 1/2, \alpha = 45^\circ.$$

Thus

$$\begin{aligned} \text{sn}(.61802|.5) &= \frac{\vartheta_s(30^\circ \backslash 45^\circ)}{\vartheta_n(30^\circ \backslash 45^\circ)} \\ &= \frac{.59128}{1.04729} = .56458 \end{aligned}$$

from Table 16.1.

Example 9. Use theta functions to compute $\text{sc}(.61802|.5)$ to 5D.

As in the preceding example

$$\epsilon^\circ = 30^\circ, \alpha^\circ = 45^\circ$$

so that

$$\text{sc}(.61802|.5) = \frac{\vartheta_s(30^\circ \backslash 45^\circ)}{\vartheta_c(30^\circ \backslash 45^\circ)}$$

We use Table 16.1 to give

$$\vartheta_s(30^\circ \backslash 45^\circ) = .59128$$

$$(\sec 45^\circ)^4 \vartheta_c(30^\circ \backslash 45^\circ) = 1.02796.$$

Therefore

$$\begin{aligned} \text{sc}(.61802|.5) &= \frac{.59128}{1.02796} (\sec 45^\circ)^4 \\ &= .68402. \end{aligned}$$

Example 10. Find $\text{sn}(.75342|.7)$ by inverse interpolation in Table 17.5.

This method is explained in chapter 17, Example 7.

Example 11. Find u , given that $\text{cs}(u|.5) = .75$. From 16.9.4 we have

$$\text{sn}^2 u = \frac{1}{1 + \text{cs}^2 u}$$

Thus

$$\text{sn}^2(u|.5) = .64$$

and

$$\text{sn}(u|.5) = .8.$$

We have therefore replaced the problem by that of finding u given $\text{sn}(u|m)$, where m is known.

If $\varphi = \text{am } u$

$$\sin \varphi = \text{sn } u \text{ and so}$$

$$\varphi = .9272952 \text{ radians or } 53.13010^\circ.$$

From Table 17.5,

$$u = F(53.13010^\circ \backslash 45^\circ) = .99391.$$

Alternatively, starting with the above value of φ we can use the A.G.M. scale to calculate $F(\varphi \backslash \alpha)$ as explained in 17.6. This method is to be preferred if more figures are required, or if α differs from a tabular value in Table 17.5.

References

Texts

- [16.1] A. Erdélyi et al., Higher transcendental functions, vol. 2 (McGraw-Hill Book Co., Inc., New York, N.Y., 1953).
- [16.2] L. V. King, On the direct numerical calculation of elliptic functions and integrals (Cambridge Univ. Press, Cambridge, England, 1924).
- [16.3] W. Magnus and F. Oberhettinger, Formulas and theorems for the special functions of mathematical physics (Chelsea Publishing Co., New York, N.Y., 1949).
- [16.4] E. H. Neville, Jacobian elliptic functions, 2d ed. (Oxford Univ. Press, London, England, 1951).
- [16.5] F. Tricomi, Elliptische Funktionen (Akademische Verlagsgesellschaft, Leipzig, Germany, 1948).
- [16.6] E. T. Whittaker and G. N. Watson, A course of modern analysis, chs. 20, 21, 22, 4th ed. (Cambridge Univ. Press, Cambridge, England, 1952).

Tables

- [16.7] E. P. Adams and R. L. Hippisley, Smithsonian mathematical formulae and tables of elliptic functions, 3d reprint (The Smithsonian Institution, Washington, D.C., 1957).
- [16.8] J. Houël, Recueil de formules et de tables numériques (Gauthier-Villars, Paris, France, 1901).
- [16.9] E. Jahnke and F. Emde, Tables of functions, 4th ed. (Dover Publications, Inc., New York, N.Y., 1945).
- [16.10] L. M. Milne-Thomson, Die elliptischen Funktionen von Jacobi (Julius Springer, Berlin, Germany, 1931).
- [16.11] L. M. Milne-Thomson, Jacobian elliptic function tables (Dover Publications, Inc., New York, N.Y., 1956).
- [16.12] G. W. and R. M. Spenceley, Smithsonian elliptic function tables, Smithsonian Miscellaneous Collection, vol. 109 (Washington, D.C., 1947).

Table 16.1

THETA FUNCTIONS

$\epsilon \backslash \alpha$		$\vartheta_s(\epsilon \backslash \alpha)$						α / ϵ_1
ϵ°	0°	5°	10°	15°	20°	25°	90°	
0°	0.00000 0000	0.00000 0000	0.00000 0000	0.00000 0000	0.00000 0000	0.00000 0000	90°	
5	0.08715 5743	0.08732 1966	0.08782 4152	0.08867 3070	0.08988 7414	0.09149 5034	85	
10	0.17364 8178	0.17397 9362	0.17497 9967	0.17667 1584	0.17909 1708	0.18229 6223	80	
15	0.25881 9045	0.25931 2677	0.26080 4191	0.26332 6099	0.26693 4892	0.27171 4833	75	
20	0.34202 0143	0.34267 2476	0.34464 3695	0.34797 7361	0.35274 9211	0.35907 2325	70	
25	0.42261 8262	0.42342 4343	0.42586 0446	0.42998 1306	0.43588 2163	0.44370 5382	65	
30	0.50000 0000	0.50095 3708	0.50383 6358	0.50871 3952	0.51570 1435	0.52497 0857	60	
35	0.57357 6436	0.57467 0526	0.57797 7994	0.58357 6134	0.59159 9683	0.60225 0597	55	
40	0.64278 7610	0.64401 3768	0.64772 1085	0.65399 8067	0.66299 9145	0.67495 6130	50	
45	0.70710 6781	0.70845 5688	0.71253 4820	0.71944 3681	0.72935 6053	0.74253 3161	45	
50	0.76604 4443	0.76750 5843	0.77192 5893	0.77941 4712	0.79016 4790	0.80446 5863	40	
55	0.81915 2044	0.82071 4821	0.82544 2256	0.83345 4505	0.84496 1783	0.86028 0899	35	
60	0.86602 5404	0.86767 7668	0.87267 6562	0.88115 1505	0.89332 9083	0.90955 1166	30	
65	0.90630 7787	0.90803 6964	0.91326 9273	0.92214 2410	0.93489 7610	0.95189 9199	25	
70	0.93969 2621	0.94148 5546	0.94691 1395	0.95611 4956	0.96935 0025	0.98700 0216	20	
75	0.96592 5826	0.96776 8848	0.97334 6839	0.98281 0311	0.99642 3213	1.01458 4761	15	
80	0.98480 7753	0.98668 6836	0.99237 4367	1.00202 5068	1.01591 0350	1.03444 0908	10	
85	0.99619 4698	0.99809 5528	1.00384 9133	1.01361 2807	1.02766 2527	1.04641 6011	5	
90	1.00000 0000	1.00190 8098	1.00768 3786	1.01748 5224	1.03158 9925	1.05041 7974	0	
$\epsilon \backslash \alpha$	30°	35°	40°	45°	50°	55°	α / ϵ_1	
0°	0.00000 0000	0.00000 0000	0.00000 0000	0.00000 0000	0.00000 0000	0.00000 0000	90°	
5	0.09353 4894	0.09606 0073	0.09914 2353	0.10287 9331	0.10740 5819	0.11291 2907	85	
10	0.18636 3367	0.19139 9811	0.19754 9961	0.20501 0420	0.21405 3194	0.22506 4618	80	
15	0.27778 4006	0.28530 3629	0.29449 2321	0.30564 8349	0.31918 5434	0.33569 3043	75	
20	0.36710 5393	0.37706 5455	0.38924 7478	0.40405 4995	0.42204 9614	0.44403 4769	70	
25	0.45365 1078	0.46599 3521	0.48110 6437	0.49950 2749	0.52189 9092	0.54932 5515	65	
30	0.53676 4494	0.55141 5176	0.56937 7735	0.59127 8602	0.61799 6720	0.65080 1843	60	
35	0.61581 3814	0.63268 1725	0.65339 2178	0.67868 8658	0.70961 8904	0.74770 4387	55	
40	0.69019 6708	0.70917 3264	0.73250 7761	0.76106 3101	0.79606 0581	0.83928 2749	50	
45	0.75934 4980	0.78030 3503	0.80611 4729	0.83776 1607	0.87664 1114	0.92480 2089	45	
50	0.82272 9031	0.84552 4503	0.87364 0739	0.90817 9128	0.95071 1025	1.00355 1297	40	
55	0.87986 2121	0.90433 1298	0.93455 6042	0.97175 1955	1.01765 9399	1.07485 2509	35	
60	0.93030 4365	0.95626 6326	0.98837 8598	1.02796 3895	1.07692 1759	1.13807 1621	30	
65	0.97366 6431	1.00092 3589	1.03467 8996	1.07635 2410	1.12798 8100	1.19262 9342	25	
70	1.00961 2870	1.03795 2481	1.07308 5074	1.11651 4503	1.17041 0792	1.23801 2299	20	
75	1.03786 5044	1.06706 1179	1.10328 6100	1.14811 2152	1.20381 2008	1.27378 3626	15	
80	1.05820 3585	1.08801 9556	1.12503 6391	1.17087 7087	1.22789 0346	1.29959 2533	10	
85	1.07047 0366	1.10066 1511	1.13815 8265	1.18461 4727	1.24242 6337	1.31518 2322	5	
90	1.07456 9932	1.10488 6686	1.14254 4218	1.18920 7115	1.24728 6586	1.32039 6454	0	
$\epsilon \backslash \alpha$	60°	65°	70°	75°	80°	85°	α / ϵ_1	
0°	0.00000 0000	0.00000 0000	0.00000 0000	0.00000 0000	0.00000 0000	0.00000 0000	90°	
5	0.11968 1778	0.12814 8474	0.13904 1489	0.15372 0475	0.17522 3596	0.21321 7690	85	
10	0.23861 4577	0.25558 9564	0.27747 6571	0.30706 5715	0.35063 9262	0.42844 3440	80	
15	0.35604 4091	0.38160 3032	0.41467 2740	0.45960 9511	0.52633 5260	0.64743 4941	75	
20	0.47120 6153	0.50544 4270	0.54994 7578	0.61082 7702	0.70219 9693	0.87146 4767	70	
25	0.58332 3727	0.62633 5361	0.68254 9331	0.76005 8920	0.87783 8622	1.10111 6239	65	
30	0.69160 6043	0.74345 9784	0.81164 3704	0.90647 6281	1.05251 4778	1.33612 3616	60	
35	0.79525 0355	0.85596 1570	0.93630 8263	1.04907 2506	1.22511 1680	1.57526 8297	55	
40	0.89344 6594	0.96294 9380	1.05553 5305	1.18666 0037	1.39412 6403	1.81633 9939	50	
45	0.98538 4972	1.06350 5669	1.16824 3466	1.31788 6740	1.55769 2334	2.05616 7815	45	
50	1.07026 6403	1.15670 0687	1.27329 7730	1.44126 6644	1.71363 1283	2.29072 3417	40	
55	1.14731 5349	1.24161 0747	1.36953 6895	1.55522 4175	1.85953 2258	2.51529 0558	35	
60	1.21579 4546	1.31733 9855	1.45580 7011	1.65814 9352	1.99285 2358	2.72469 4161	30	
65	1.27502 0900	1.38304 3549	1.53099 8883	1.74846 0610	2.11103 3523	2.91357 4159	25	
70	1.32438 1718	1.43795 3601	1.59408 7380	1.82467 1332	2.21162 7685	3.07668 6743	20	
75	1.36335 0417	1.48140 2159	1.64417 0149	1.88545 5864	2.29242 2061	3.20921 2227	15	
80	1.39150 0813	1.51284 3876	1.68050 3336	1.92971 0721	2.35155 6149	3.30704 7313	10	
85	1.40851 9209	1.53187 4716	1.70253 2036	1.95660 6998	2.38762 2438	3.36705 9918	5	
90	1.41421 3562	1.53824 6269	1.70991 3565	1.96563 0511	2.39974 3837	3.38728 7004	0	

$$\sqrt{\sec \alpha} \vartheta_c(\epsilon_1 \backslash \alpha)$$

$$\epsilon^\circ = \frac{n}{K} \cdot 90^\circ \quad \epsilon_1^\circ = 90^\circ - \epsilon^\circ \quad \alpha = \arcsin \sqrt{m} \quad \vartheta_s(n|m) = \vartheta_s(\epsilon^\circ \backslash \alpha)$$

In calculating elliptic functions from theta functions, when the modular angle exceeds about 60°, use the descending Landen transformation 16.12 to induce dependence on a smaller modular angle.

Compiled from E. P. Adams and R. L. Hippisley, Smithsonian mathematical formulae and tables of elliptic functions, 3d reprint (The Smithsonian Institution, Washington, D.C., 1957) (with permission).

THETA FUNCTIONS

Table 16.1

$\epsilon \backslash \alpha$		$\vartheta_n(\epsilon \backslash \alpha)$							α / ϵ_1		
		0°	5°	10°	15°	20°	25°				
0°	1	1.00000	00000	1.00000	00000	1.00000	00000	1.00000	00000	90°	
5	1	1.00001	44942	1.00005	83670	1.00013	28199	1.00023	99605	85	
10	1	1.00005	75362	1.00023	16945	1.00052	72438	1.00095	25510	80	
15	1	1.00012	78184	1.00051	47160	1.00117	12875	1.00211	61200	75	
20	1	1.00022	32051	1.00089	88322	1.00204	53820	1.00369	53131	70	
25	1	1.00034	07982	1.00137	23717	1.00312	29684	1.00564	21475	65	
30	1	1.00047	70246	1.00192	09464	1.00437	13049	1.00789	74700	60	
35	1	1.00062	77451	1.00252	78880	1.00575	24612	1.01039	27539	55	
40	1	1.00078	83803	1.00317	47551	1.00722	44718	1.01305	21815	50	
45	1	1.00095	40492	1.00384	18928	1.00874	26104	1.01579	49474	45	
50	1	1.00111	97181	1.00450	90305	1.01026	07491	1.01853	77143	40	
55	1	1.00128	03532	1.00515	58975	1.01173	27599	1.02119	71444	35	
60	1	1.00143	10738	1.00576	28392	1.01311	39167	1.02369	24323	30	
65	1	1.00156	73002	1.00631	14139	1.01436	22536	1.02594	77596	25	
70	1	1.00168	48932	1.00678	49535	1.01543	98405	1.02789	45992	20	
75	1	1.00178	02800	1.00716	90696	1.01631	39354	1.02947	37972	15	
80	1	1.00185	05621	1.00745	20912	1.01695	79795	1.03063	73701	10	
85	1	1.00189	36042	1.00762	54187	1.01735	24037	1.03134	99632	5	
90	1	1.00190	80984	1.00768	37857	1.01748	52237	1.03158	99246	0	
$\epsilon \backslash \alpha$		30°	35°	40°	45°	50°	55°	α / ϵ_1			
0°	1.00000	00000	1.00000	00000	1.00000	00000	1.00000	00000	90°		
5	1.00056	64294	1.00079	66833	1.00108	26253	1.00143	67802	1.00187	71775	85
10	1.00224	85079	1.00316	25308	1.00429	76203	1.00570	35065	1.00745	17850	80
15	1.00499	51300	1.00702	56701	1.00954	73402	1.01267	06562	1.01655	47635	75
20	1.00872	28461	1.01226	87413	1.01667	23379	1.02212	67193	1.02891	00179	70
25	1.01331	83978	1.01873	24599	1.02545	62012	1.03378	46028	1.04414	27466	65
30	1.01864	21583	1.02622	04548	1.03563	21191	1.04729	03271	1.06179	07561	60
35	1.02453	23743	1.03450	52308	1.04689	09786	1.06223	37524	1.08131	84270	55
40	1.03081	00797	1.04333	50787	1.05889	07481	1.07816	10137	1.10213	29153	50
45	1.03728	45330	1.05244	17208	1.07126	68617	1.09458	82886	1.12360	21058	45
50	1.04375	90125	1.06154	84606	1.08364	32917	1.11101	64844	1.14507	37802	40
55	1.05003	67930	1.07037	85902	1.09564	39724	1.12694	63970	1.16589	54205	35
60	1.05592	71242	1.07866	37978	1.10690	42279	1.14189	38846	1.18543	40490	30
65	1.06125	10260	1.08615	23221	1.11708	18582	1.15540	45920	1.20309	54999	25
70	1.06584	67280	1.09261	66042	1.12586	75438	1.16706	77783	1.21834	25328	20
75	1.06957	45853	1.09786	02047	1.13299	42539	1.17652	88244	1.23071	12287	15
80	1.07232	13226	1.10172	37756	1.13824	53698	1.18350	00363	1.23982	51648	10
85	1.07400	34764	1.10408	99048	1.14146	12760	1.18776	94140	1.24540	69243	5
90	1.07456	99318	1.10488	66859	1.14254	42177	1.18920	71150	1.24728	65857	0
$\epsilon \backslash \alpha$		60°	65°	70°	75°	80°	85°	α / ϵ_1			
0°	1.00000	00000	1.00000	00000	1.00000	00000	1.00000	00000	90°		
5	1.00313	85295	1.00406	92257	1.00534	44028	1.00720	88997	1.01026	06485	85
10	1.01245	94672	1.01615	50083	1.02121	95717	1.02862	79374	1.04076	43440	80
15	1.02768	16504	1.03589	51569	1.04715	56657	1.06363	90673	1.09068	07598	75
20	1.04834	57003	1.06269	75825	1.08236	38086	1.11122	86903	1.15864	11101	70
25	1.07382	76019	1.09575	73598	1.12585	71388	1.17001	24008	1.24276	19421	65
30	1.10335	71989	1.13408	00433	1.17627	97795	1.23826	96285	1.34068	05139	60
35	1.13604	11010	1.17651	06705	1.23214	31946	1.31398	80140	1.44960	33094	55
40	1.17088	93642	1.22176	77148	1.29176	91861	1.39491	71251	1.56636	90138	50
45	1.20684	51910	1.26848	10938	1.35335	85717	1.47863	07744	1.68752	66770	45
50	1.24281	67937	1.31523	31927	1.41504	43413	1.56259	67789	1.80942	88493	40
55	1.27771	04815	1.36060	17261	1.47494	78592	1.64425	25175	1.92833	82823	35
60	1.31046	39783	1.40320	31647	1.53123	64694	1.72108	41609	2.04054	54606	30
65	1.34007	89457	1.44173	53793	1.58218	06891	1.79070	70015	2.14249	29245	25
70	1.36565	16965	1.47501	81348	1.62620	90720	1.85094	39670	2.23090	12139	20
75	1.38640	11169	1.50203	00916	1.66195	87940	1.89989	92030	2.30289	04563	15
80	1.40169	28947	1.52194	10514	1.68832	00831	1.93602	35909	2.35609	12550	10
85	1.41105	92570	1.53413	83232	1.70447	27784	1.95816	92561	2.38873	86793	5
90	1.41421	35624	1.53824	62687	1.70991	35651	1.96563	05108	2.39974	38370	0

$$\sqrt{\sec \alpha} \vartheta'_d(\epsilon \backslash \alpha) \quad \epsilon = \frac{u}{K} 90^\circ \quad \epsilon_1 = 90^\circ - \epsilon \quad \alpha = \arcsin \sqrt{m} \quad \vartheta'_n(u|m) = \vartheta'_n(\epsilon \backslash \alpha)$$

In calculating elliptic functions from theta functions, when the modular angle exceeds about 60°, use the descending Landen transformation 16.12 to induce dependence on a smaller modular angle.

Table 16.2 LOGARITHMIC DERIVATIVES OF THETA FUNCTIONS

$$\frac{d}{du} \ln \vartheta_8(u) = f(\epsilon \backslash \alpha)$$

$\epsilon \backslash \alpha$	0°	5°	10°	15°	20°	25°	α/ϵ_1
0°	∞	∞	∞	∞	∞	∞	90°
5	11.40829	11.40829	11.34306	11.23449	11.08275	10.88811	85
10	5.67128	5.66049	5.62812	5.57427	5.49902	5.40253	80
15	3.73205	3.72495	3.70365	3.66823	3.61876	3.55536	75
20	2.74748	2.74225	2.72658	2.70051	2.66414	2.61756	70
25	2.14451	2.14043	2.12820	2.10787	2.07952	2.04325	65
30	1.73205	1.72875	1.71888	1.70248	1.67962	1.65041	60
35	1.42815	1.42543	1.41729	1.40378	1.38497	1.36096	55
40	1.19175	1.18949	1.18270	1.17143	1.15577	1.13581	50
45	1.00000	0.99810	0.99240	0.98296	0.96985	0.95315	45
50	0.83910	0.83750	0.83273	0.82481	0.81383	0.79987	40
55	0.70021	0.69888	0.69489	0.68830	0.67915	0.66754	35
60	0.57735	0.57625	0.57297	0.56754	0.56001	0.55047	30
65	0.46631	0.46542	0.46277	0.45839	0.45232	0.44464	25
70	0.36397	0.36328	0.36121	0.35779	0.35306	0.34708	20
75	0.26795	0.26744	0.26592	0.26340	0.25992	0.25553	15
80	0.17633	0.17599	0.17499	0.17334	0.17105	0.16816	10
85	0.08749	0.08732	0.08683	0.08600	0.08487	0.08344	5
90	0.00000	0.00000	0.00000	0.00000	0.00000	0.00000	0

$\epsilon \backslash \alpha$	30°	35°	40°	45°	50°	55°	α/ϵ_1
0°	∞	∞	∞	∞	∞	∞	90°
5	10.65083	10.37113	10.04914	9.68479	9.27764	8.82657	85
10	5.28496	5.14645	4.98711	4.80696	4.60585	4.38332	80
15	3.47816	3.38730	3.28290	3.16502	3.03365	2.88859	75
20	2.56090	2.49430	2.41789	2.33179	2.23605	2.13062	70
25	1.99919	1.94749	1.88828	1.82172	1.74793	1.66695	65
30	1.61498	1.57348	1.52607	1.47292	1.41419	1.35001	60
35	1.33189	1.29791	1.25919	1.21591	1.16828	1.11647	55
40	1.11167	1.08352	1.05154	1.01592	0.97687	0.93462	50
45	0.93301	0.90958	0.88302	0.85355	0.82139	0.78679	45
50	0.78307	0.76355	0.74151	0.71714	0.69066	0.66232	40
55	0.65359	0.63743	0.61923	0.59918	0.57749	0.55441	35
60	0.53902	0.52579	0.51093	0.49462	0.47705	0.45846	30
65	0.43543	0.42482	0.41292	0.39991	0.38595	0.37125	25
70	0.33992	0.33169	0.32248	0.31242	0.30168	0.29042	20
75	0.25028	0.24424	0.23751	0.23017	0.22235	0.21419	15
80	0.16471	0.16076	0.15634	0.15155	0.14645	0.14114	10
85	0.08173	0.07977	0.07759	0.07522	0.07270	0.07009	5
90	0.00000	0.00000	0.00000	0.00000	0.00000	0.00000	0

$\epsilon \backslash \alpha$	60°	65°	70°	75°	80°	85°	α/ϵ_1
0°	∞	∞	∞	∞	∞	∞	90°
5	8.32941	7.78200	7.17654	6.49756	5.71041	4.71263	85
10	4.13843	3.86930	3.57238	3.24056	2.85790	2.37760	80
15	2.72935	2.55490	2.36323	2.15026	1.90678	1.60605	75
20	2.01530	1.88950	1.75208	1.60057	1.42943	1.22261	70
25	1.57876	1.48308	1.37931	1.26603	1.13996	0.99169	65
30	1.28047	1.20552	1.12492	1.03795	0.94288	0.83453	60
35	1.06066	1.00096	0.93737	0.86969	0.79715	0.71737	55
40	0.88940	0.84142	0.79086	0.73784	0.68225	0.62344	50
45	0.75000	0.71131	0.67101	0.62941	0.58682	0.54358	45
50	0.63242	0.60125	0.56918	0.53662	0.50411	0.47247	40
55	0.53023	0.50526	0.47987	0.45454	0.42988	0.40690	35
60	0.43911	0.41932	0.39943	0.37992	0.36140	0.34488	30
65	0.35605	0.34063	0.32532	0.31054	0.29684	0.28513	25
70	0.27885	0.26719	0.25574	0.24484	0.23497	0.22685	20
75	0.20584	0.19749	0.18935	0.18170	0.17490	0.16949	15
80	0.13572	0.13034	0.12512	0.12026	0.11601	0.11272	10
85	0.06742	0.06478	0.06224	0.05988	0.05784	0.05628	5
90	0.00000	0.00000	0.00000	0.00000	0.00000	0.00000	0

$$\frac{d}{du} \ln \vartheta_c(u) = -f(\epsilon_1 \backslash \alpha)$$

In calculating elliptic functions from theta functions, when the modular angle exceeds about 60°, use the descending Landen transformation 16.12 to induce dependence on a smaller modular angle.

LOGARITHMIC DERIVATIVES OF THETA FUNCTIONS Table 16.2

$$\frac{d}{du} \ln \vartheta_n(u) = g(\epsilon; \alpha)$$

$\epsilon; \alpha$	0°	5°	10°	15°	20°	25°	α/ϵ_1
0°	0	0.000000	0.000000	0.000000	0.000000	0.000000	90°
5	0	0.000331	0.001324	0.002984	0.005318	0.008337	85
10	0	0.000651	0.002607	0.005875	0.010466	0.016401	80
15	0	0.000952	0.003811	0.008583	0.015283	0.023933	75
20	0	0.001224	0.004897	0.011024	0.019616	0.030690	70
25	0	0.001458	0.005833	0.013124	0.023332	0.036462	65
30	0	0.001649	0.006591	0.014819	0.026318	0.041075	60
35	0	0.001788	0.007147	0.016057	0.028487	0.044394	55
40	0	0.001874	0.007486	0.016804	0.029776	0.046332	50
45	0	0.001903	0.007596	0.017037	0.030154	0.046846	45
50	0	0.001873	0.007476	0.016753	0.029616	0.045938	40
55	0	0.001787	0.007129	0.015962	0.028185	0.043654	35
60	0	0.001647	0.006566	0.014691	0.025912	0.040077	30
65	0	0.001457	0.005805	0.012979	0.022871	0.035328	25
70	0	0.001222	0.004868	0.010879	0.019154	0.029556	20
75	0	0.000951	0.003786	0.008455	0.014877	0.022935	15
80	0	0.000650	0.002589	0.005780	0.010165	0.015661	10
85	0	0.000330	0.001314	0.002933	0.005157	0.007942	5
90	0	0.000000	0.000000	0.000000	0.000000	0.000000	0

$\epsilon; \alpha$	30°	35°	40°	45°	50°	55°	α/ϵ_1
0°	0.000000	0.000000	0.000000	0.000000	0.000000	0.000000	90°
5	0.012059	0.016511	0.021734	0.027787	0.034760	0.042791	85
10	0.023711	0.032444	0.042671	0.054498	0.068087	0.083685	80
15	0.034569	0.047248	0.062057	0.079124	0.098650	0.120939	75
20	0.044277	0.060427	0.079221	0.100783	0.125308	0.153099	70
25	0.052528	0.071558	0.093605	0.118758	0.147169	0.179081	65
30	0.059074	0.080308	0.104784	0.132533	0.163627	0.198206	60
35	0.063730	0.086442	0.112477	0.141791	0.174358	0.210188	55
40	0.066384	0.089827	0.116544	0.146411	0.179298	0.215082	50
45	0.066987	0.090424	0.116978	0.146447	0.178606	0.213212	45
50	0.065561	0.088287	0.113888	0.142097	0.172615	0.205102	40
55	0.062183	0.083549	0.107483	0.133678	0.161784	0.191402	35
60	0.056989	0.076408	0.098051	0.121592	0.146658	0.172831	30
65	0.050157	0.067122	0.085943	0.106302	0.127835	0.150136	25
70	0.041905	0.055989	0.071553	0.088310	0.105932	0.124058	20
75	0.032483	0.043344	0.055309	0.068143	0.081578	0.095321	15
80	0.022163	0.029545	0.037660	0.046339	0.055395	0.064622	10
85	0.011235	0.014968	0.019067	0.023443	0.028000	0.032631	5
90	0.000000	0.000000	0.000000	0.000000	0.000000	0.000000	0

$\epsilon; \alpha$	60°	65°	70°	75°	80°	85°	α/ϵ_1
0°	0.000000	0.000000	0.000000	0.000000	0.000000	0.000000	90°
5	0.052098	0.063034	0.076222	0.092860	0.115687	0.153481	85
10	0.101680	0.122704	0.147856	0.179233	0.221544	0.289421	80
15	0.146471	0.176024	0.210938	0.253725	0.309882	0.395712	75
20	0.184635	0.220691	0.262588	0.312762	0.376371	0.467893	70
25	0.214885	0.255225	0.301193	0.354775	0.420046	0.507818	65
30	0.236514	0.278976	0.326329	0.379918	0.442452	0.520777	60
35	0.249349	0.292010	0.338517	0.389553	0.446532	0.512966	55
40	0.253651	0.294931	0.338908	0.385698	0.435687	0.490013	50
45	0.250000	0.288691	0.323990	0.370590	0.413176	0.456422	45
50	0.239181	0.274426	0.310353	0.346389	0.381811	0.415539	40
55	0.222085	0.253326	0.284538	0.315020	0.343874	0.369741	35
60	0.199639	0.226549	0.252950	0.278119	0.301140	0.320668	30
65	0.172751	0.195171	0.215820	0.237026	0.254956	0.269431	25
70	0.142285	0.160167	0.177204	0.192823	0.206331	0.216780	20
75	0.109049	0.122405	0.134996	0.146375	0.156015	0.163217	15
80	0.073794	0.082664	0.090960	0.098382	0.104574	0.109083	10
85	0.037222	0.041645	0.045763	0.049423	0.052449	0.054618	5
90	0.000000	0.000000	0.000000	0.000000	0.000000	0.000000	0

$$\frac{d}{du} \ln \vartheta_d(u) = -g(\epsilon_1 | \alpha)$$

In calculating elliptic functions from theta functions, when the modular angle exceeds about 60°, use the descending Landen transformation 16.12 to induce dependence on a smaller modular angle.

17. Elliptic Integrals

L. M. MILNE-THOMSON¹

Contents

	Page
Mathematical Properties	589
17.1. Definition of Elliptic Integrals	589
17.2. Canonical Forms	589
17.3. Complete Elliptic Integrals of the First and Second Kinds	590
17.4. Incomplete Elliptic Integrals of the First and Second Kinds	592
17.5. Landen's Transformation	597
17.6. The Process of the Arithmetic-Geometric Mean	598
17.7. Elliptic Integrals of the Third Kind	599
Numerical Methods	600
17.8. Use and Extension of the Tables	600
References	606
Table 17.1. Complete Elliptic Integrals of the First and Second Kinds and the Nome q With Argument the Parameter m	608
$K(m), K'(m), 15D; q(m), q_1(m), 15D; E(m), E'(m), 9D$ $m=0(.01)1$	
Table 17.2. Complete Elliptic Integrals of the First and Second Kinds and the Nome q With Argument the Modular Angle α	610
$K(\alpha), K'(\alpha), q(\alpha), q_1(\alpha), E(\alpha), E'(\alpha), 15D$ $\alpha=0^\circ(1^\circ)90^\circ$	
Table 17.3. Parameter m With Argument $K'(m)/K(m)$	612
$K'(m)/K(m)=.3(.02)3, 10D$	
Table 17.4. Auxiliary Functions for Computation of the Nome q and the Parameter m	612
$Q(m)=q_1(m)/m_1, 15D$ $L(m)=-K(m)+\frac{K'(m)}{\pi} \ln\left(\frac{16}{m_1}\right), 10D$ $m_1=0(.01).15$	
Table 17.5. Elliptic Integral of the First Kind $F(\varphi\backslash\alpha)$	613
$\alpha=0^\circ(2^\circ)90^\circ, 5^\circ(10^\circ)85^\circ, \varphi=0^\circ(5^\circ)90^\circ, 8D$	
Table 17.6. Elliptic Integral of the Second Kind $E(\varphi\backslash\alpha)$	616
$\alpha=0^\circ(2^\circ)90^\circ, 5^\circ(10^\circ)85^\circ, \varphi=0^\circ(5^\circ)90^\circ, 8D$	

¹ University of Arizona. (Prepared under contract with the National Bureau of Standards.)

	Page
Table 17.7. Jacobian Zeta Function $Z(\varphi \backslash \alpha)$	619
Values of $K(\alpha)Z(\varphi \backslash \alpha)$	
$\alpha=0^\circ(2^\circ)90^\circ, 5^\circ(10^\circ)85^\circ, \varphi=0^\circ(5^\circ)90^\circ, 6D$	
Table 17.8. Heuman's Lambda Function $\Lambda_0(\varphi \backslash \alpha)$	622
$\Lambda_0(\varphi \backslash \alpha) = \frac{F(\varphi \backslash 90^\circ - \alpha)}{K'(\alpha)} + \frac{2}{\pi} K(\alpha) Z(\varphi \backslash 90^\circ - \alpha), 6D$	
$\alpha=0^\circ(2^\circ)90^\circ, 5^\circ(10^\circ)85^\circ, \varphi=0^\circ(5^\circ)90^\circ$	
Table 17.9. Elliptic Integral of the Third Kind $\Pi(n; \varphi \backslash \alpha)$	625
$n=0(.1)1, \varphi, \alpha=0^\circ(15^\circ)90^\circ, 5D$	

The author acknowledges with thanks the assistance of Ruth Zucker in the computation of the examples, Ruth E. Capuano for **Table 17.3**, David S. Liepman for **Table 17.4**, and Andreas Schopf for **Table 17.9**.

17. Elliptic Integrals

Mathematical Properties

17.1. Definition of Elliptic Integrals

If $R(x, y)$ is a rational function of x and y , where y^2 is equal to a cubic or quartic polynomial in x , the integral

$$17.1.1 \quad \int R(x, y) dx$$

is called an *elliptic integral*.

The elliptic integral just defined can not, in general, be expressed in terms of elementary functions.

Exceptions to this are

- (i) when $R(x, y)$ contains no odd powers of y .
- (ii) when the polynomial y^2 has a repeated factor.

We therefore exclude these cases.

By substituting for y^2 and denoting by $p_s(x)$ a polynomial in x we get ²

$$R(x, y) = \frac{p_1(x) + yp_2(x)}{p_3(x) + yp_4(x)} \\ = \frac{[p_1(x) + yp_2(x)][p_3(x) - yp_4(x)]y}{\{[p_3(x)]^2 - y^2[p_4(x)]^2\}y} \\ = \frac{p_5(x) + yp_6(x)}{yp_7(x)} = R_1(x) + \frac{R_2(x)}{y}$$

where $R_1(x)$ and $R_2(x)$ are rational functions of x . Hence, by expressing $R_2(x)$ as the sum of a polynomial and partial fractions

$$\int R(x, y) dx = \int R_1(x) dx + \sum A_s \int x^s y^{-1} dx \\ + \sum B_s \int [(x-c)^s y]^{-1} dx$$

Reduction Formulae

Let

17.1.2

$$y^2 = a_0x^4 + a_1x^3 + a_2x^2 + a_3x + a_4 \quad (|a_0| + |a_1| \neq 0) \\ = b_0(x-c)^4 + b_1(x-c)^3 + b_2(x-c)^2 + b_3(x-c) + b_4 \\ (|b_0| + |b_1| \neq 0)$$

$$17.1.3 \quad I_s = \int x^s y^{-1} dx, \quad J_s = \int [y(x-c)^s]^{-1} dx$$

By integrating the derivatives of yx^s and $y(x-c)^{-s}$ we get the reduction formulae

17.1.4

$$(s+2)a_0I_{s+3} + \frac{1}{2}a_1(2s+3)I_{s+2} + a_2(s+1)I_{s+1} \\ + \frac{1}{2}a_3(2s+1)I_s + sa_4I_{s-1} = x^s y \quad (s=0, 1, 2, \dots)$$

² See [17.7] 22.72.

17.1.5

$$(2-s)b_0J_{s-3} + \frac{1}{2}b_1(3-2s)J_{s-2} + b_2(1-s)J_{s-1} \\ + \frac{1}{2}b_3(1-2s)J_s - sb_4J_{s+1} = y(x-c)^{-s} \\ (s=1, 2, 3, \dots)$$

By means of these reduction formulae and certain transformations (see **Examples 1** and **2**) every elliptic integral can be brought to depend on the integral of a rational function and on three canonical forms for elliptic integrals.

17.2. Canonical Forms

Definitions

17.2.1

$m = \sin^2 \alpha$; m is the parameter,
 α is the modular angle

17.2.2

$$x = \sin \varphi = \operatorname{sn} u$$

17.2.3

$$\cos \varphi = \operatorname{cn} u$$

17.2.4

$(1-m \sin^2 \varphi)^{\frac{1}{2}} = \operatorname{dn} u = \Delta(\varphi)$, the delta amplitude

17.2.5

$\varphi = \arcsin(\operatorname{sn} u) = \operatorname{am} u$, the amplitude

Elliptic Integral of the First Kind

17.2.6

$$F(\varphi \backslash \alpha) = F(\varphi | m) = \int_0^\varphi (1 - \sin^2 \alpha \sin^2 \theta)^{-\frac{1}{2}} d\theta$$

17.2.7

$$= \int_0^x [(1-t^2)(1-mt^2)]^{-\frac{1}{2}} dt \\ = \int_0^u dw = u$$

Elliptic Integral of the Second Kind

17.2.8

$$E(\varphi \backslash \alpha) = E(u | m) = \int_0^x (1-t^2)^{-\frac{1}{2}} (1-mt^2)^{\frac{1}{2}} dt$$

17.2.9

$$= \int_0^\varphi (1 - \sin^2 \alpha \sin^2 \theta)^{\frac{1}{2}} d\theta$$

17.2.10

$$= \int_0^u \operatorname{dn}^2 w dw$$

17.2.11

$$= m_1 u + m \int_0^u \operatorname{cn}^2 w dw$$

$$17.2.12 \quad E(\varphi \setminus \alpha) = u - m \int_0^u \operatorname{sn}^2 w \, dw$$

$$17.2.13 \quad = \frac{\pi}{2K(m)} \frac{\partial'_4(\pi u/2K)}{\partial_4(\pi u/2K)} + \frac{E(m)u}{K(m)}$$

(For theta functions, see chapter 16.)

Elliptic Integral of the Third Kind

17.2.14

$$\Pi(n; \varphi \setminus \alpha) = \int_0^\varphi (1 - n \sin^2 \theta)^{-1} [1 - \sin^2 \alpha \sin^2 \theta]^{-1/2} d\theta$$

If $x = \operatorname{sn}(u|m)$,

17.2.15

$$\Pi(n; u|m) = \int_0^x (1 - nt^2)^{-1} [(1 - t^2)(1 - mt^2)]^{-1/2} dt$$

$$17.2.16 \quad = \int_0^u (1 - n \operatorname{sn}^2(w|m))^{-1} dw$$

The Amplitude φ

$$17.2.17 \quad \varphi = \operatorname{am} u = \arcsin(\operatorname{sn} u) = \arcsin x$$

can be calculated from Tables 17.5 and 4.14.

The Parameter m

Dependence on the *parameter* m is denoted by a vertical stroke preceding the parameter, e.g., $F(\varphi|m)$.

Together with the parameter we define the *complementary parameter* m_1 by

$$17.2.18 \quad m + m_1 = 1$$

When the parameter is real, it can always be arranged, see 17.4, that $0 \leq m \leq 1$.

The Modular Angle α

Dependence on the modular angle α , defined in terms of the parameter by 17.2.1, is denoted by a backward stroke \setminus preceding the modular angle, thus $E(\varphi \setminus \alpha)$. The *complementary modular angle* is $\pi/2 - \alpha$ or $90^\circ - \alpha$ according to the unit and thus $m_1 = \sin^2(90^\circ - \alpha) = \cos^2 \alpha$.

The Modulus k

In terms of Jacobian elliptic functions (chapter 16), the modulus k and the complementary modulus are defined by

$$17.2.19 \quad k = \operatorname{ns}(K + iK'), \quad k' = \operatorname{dn} K.$$

They are related to the parameter by $k^2 = m$, $k'^2 = m_1$.

Dependence on the modulus is denoted by a comma preceding it, thus $\Pi(n; u, k)$.

In computation the modulus is of minimal importance, since it is the parameter and its complement which arise naturally. The parameter and the modular angle will be employed in this chapter to the exclusion of the modulus.

The Characteristic n

The elliptic integral of the third kind depends on three variables namely (i) the parameter, (ii) the amplitude, (iii) the characteristic n . When real, the characteristic may be any number in the interval $(-\infty, \infty)$. The properties of the integral depend upon the location of the characteristic in this interval, see 17.7.

17.3. Complete Elliptic Integrals of the First and Second Kinds

Referred to the canonical forms of 17.2, the elliptic integrals are said to be *complete* when the amplitude is $\frac{1}{2}\pi$ and so $x=1$. These complete integrals are designated as follows

17.3.1

$$[K(m)] = K = \int_0^1 [(1-t^2)(1-mt^2)]^{-1/2} dt \\ = \int_0^{\pi/2} (1-m \sin^2 \theta)^{-1/2} d\theta$$

$$17.3.2 \quad K = F(\frac{1}{2}\pi|m) = F(\frac{1}{2}\pi \setminus \alpha)$$

17.3.3

$$E[K(m)] = E = \int_0^1 (1-t^2)^{-1/2} (1-mt^2)^{1/2} dt \\ = \int_0^{\pi/2} (1-m \sin^2 \theta)^{1/2} d\theta$$

$$17.3.4 \quad E = E[K(m)] = E(m) = E(\frac{1}{2}\pi \setminus \alpha)$$

We also define

17.3.5

$$K' = K(m_1) = K(1-m) = \int_0^{\pi/2} (1-m_1 \sin^2 \theta)^{-1/2} d\theta$$

$$17.3.6 \quad K' = F(\frac{1}{2}\pi|m_1) = F(\frac{1}{2}\pi \setminus \frac{1}{2}\pi - \alpha)$$

17.3.7

$$E' = E(m_1) = E(1-m) = \int_0^{\pi/2} (1-m_1 \sin^2 \theta)^{1/2} d\theta$$

$$17.3.8 \quad E' = E[K(m_1)] = E(m_1) = E(\frac{1}{2}\pi \setminus \frac{1}{2}\pi - \alpha)$$

K and iK' are the "real" and "imaginary" *quarter-periods* of the corresponding Jacobian elliptic functions (see chapter 16).

*Summary de 1
22/01/50*

Relation to the Hypergeometric Function
(see chapter 15)

17.3.9 $K = \frac{1}{2} \pi F(\frac{1}{2}, \frac{1}{2}; 1; m)$

17.3.10 $E = \frac{1}{2} \pi F(-\frac{1}{2}, \frac{1}{2}; 1; m)$

Infinite Series

17.3.11

$$K(m) = \frac{1}{2} \pi \left[1 + \left(\frac{1}{2}\right)^2 m + \left(\frac{1 \cdot 3}{2 \cdot 4}\right)^2 m^2 + \left(\frac{1 \cdot 3 \cdot 5}{2 \cdot 4 \cdot 6}\right)^2 m^3 + \dots \right] \quad (|m| < 1)$$

17.3.12

$$E(m) = \frac{1}{2} \pi \left[1 - \frac{\left(\frac{1}{2}\right)^2 m}{1} - \frac{\left(\frac{1 \cdot 3}{2 \cdot 4}\right)^2 m^2}{3} - \frac{\left(\frac{1 \cdot 3 \cdot 5}{2 \cdot 4 \cdot 6}\right)^2 m^3}{5} - \dots \right] \quad (|m| < 1)$$

Legendre's Relation

17.3.13 $EK' + E'K - KK' = \frac{1}{2} \pi$

Auxiliary Function

17.3.14 $L(m) = \frac{K'(m)}{\pi} \ln \frac{16}{m_1} - K(m)$

17.3.15 $m = 1 - 16 \exp [-\pi(K(m) + L(m))/K'(m)]$

17.3.16 $m = 16 \exp [-\pi(K'(m) + L(m_1))/K(m)]$

The function $L(m)$ is tabulated in Table 17.4.

q-Series

The Nome q and the Complementary Nome q_1

17.3.17 $q = q(m) = \exp [-\pi K'/K]$

17.3.18 $q_1 = q(m_1) = \exp [-\pi K/K']$

17.3.19 $\ln \frac{1}{q'} \ln \frac{1}{q_1} = \pi^2$

17.3.20

$$\log_{10} \frac{1}{q} \log_{10} \frac{1}{q_1} = (\pi \log_{10} e)^2 = 1.86152 \ 28349 \text{ to } 10D$$

17.3.21

$$q = \exp [-\pi K'/K] = \frac{m}{16} + 8 \left(\frac{m}{16}\right)^2 + 84 \left(\frac{m}{16}\right)^3 + 992 \left(\frac{m}{16}\right)^4 + \dots \quad (|m| < 1)$$

17.3.22 $K = \frac{1}{2} \pi + 2\pi \sum_{s=1}^{\infty} \frac{q^s}{1+q^{2s}}$

17.3.23

$$\frac{E}{K} = \frac{1}{3} (1 + m_1) + (\pi/K)^2 \left[1/12 - 2 \sum_{s=1}^{\infty} q^{2s} (1 - q^{2s})^{-2} \right]$$

17.3.24 $\text{am } u = v + \sum_{s=1}^{\infty} \frac{2q^s \sin 2sv}{s(1+q^{2s})}$ where $v = \pi u / (2K)$

Limiting Values

17.3.25 $\lim_{m \rightarrow 0} K'(E - K) = 0$

17.3.26 $\lim_{m \rightarrow 1} [K - \frac{1}{2} \ln (16/m_1)] = 0$

17.3.27 $\lim_{m \rightarrow 0} m^{-1}(K - E) = \lim_{m \rightarrow 0} m^{-1}(E - m_1 K) = \pi/4$

17.3.28 $\lim_{m \rightarrow 0} q/m = \lim_{m \rightarrow 1} q_1/m_1 = 1/16$

Alternative Evaluations of K and E (see also 17.5)

17.3.29

$$K(m) = 2[1 + m_1^{1/2}]^{-1} K[(1 - m_1^{1/2}) / (1 + m_1^{1/2})]^2$$

17.3.30

$$E(m) = (1 + m_1^{1/2}) E[(1 - m_1^{1/2}) / (1 + m_1^{1/2})]^2 - 2m_1^{1/2} (1 + m_1^{1/2})^{-1} K[(1 - m_1^{1/2}) / (1 + m_1^{1/2})]^2$$

17.3.31 $K(\alpha) = 2F(\arctan (\sec^{1/2} \alpha) \setminus \alpha)$

17.3.32 $E(\alpha) = 2E(\arctan (\sec^{1/2} \alpha) \setminus \alpha) - 1 + \cos \alpha$

Polynomial Approximations³ ($0 \leq m < 1$)

17.3.33

$$K(m) = [a_0 + a_1 m_1 + a_2 m_1^2] + [b_0 + b_1 m_1 + b_2 m_1^2] \ln (1/m_1) + \epsilon(m)$$

$$|\epsilon(m)| \leq 3 \times 10^{-5}$$

$a_0 = 1.38629 \ 44$	$b_0 = .5$
$a_1 = .11197 \ 23$	$b_1 = .12134 \ 78$
$a_2 = .07252 \ 96$	$b_2 = .02887 \ 29$

17.3.34

$$K(m) = [a_0 + a_1 m_1 + \dots + a_4 m_1^4] + [b_0 + b_1 m_1 + \dots + b_4 m_1^4] \ln (1/m_1) + \epsilon(m)$$

$$|\epsilon(m)| \leq 2 \times 10^{-8}$$

$a_0 = 1.38629 \ 436112$	$b_0 = .5$
$a_1 = .09666 \ 344259$	$b_1 = .12498 \ 593597$
$a_2 = .03590 \ 092383$	$b_2 = .06880 \ 248576$
$a_3 = .03742 \ 563713$	$b_3 = .03328 \ 355346$
$a_4 = .01451 \ 196212$	$b_4 = .00441 \ 787012$

³ The approximations 17.3.33-17.3.36 are from C. Hastings, Jr., Approximations for Digital Computers, Princeton Univ. Press, Princeton, N. J. (with permission).

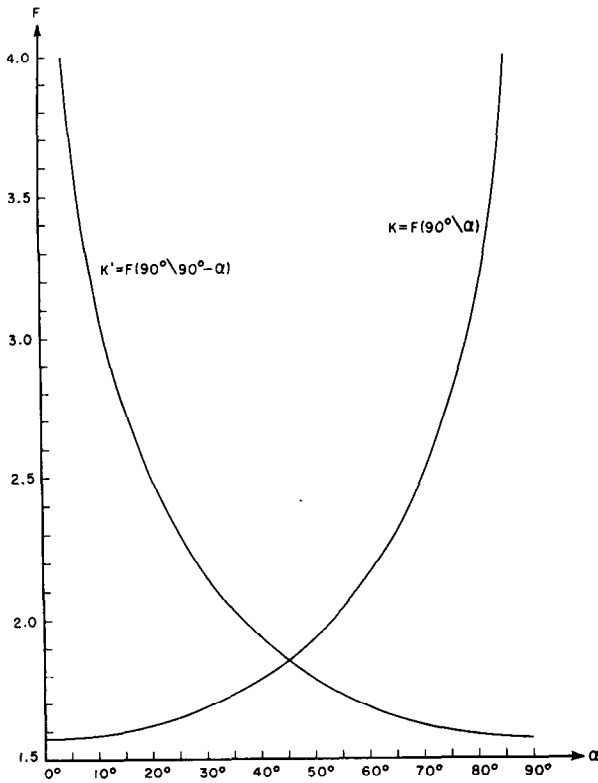

FIGURE 17.1. Complete elliptic integral of the first kind.

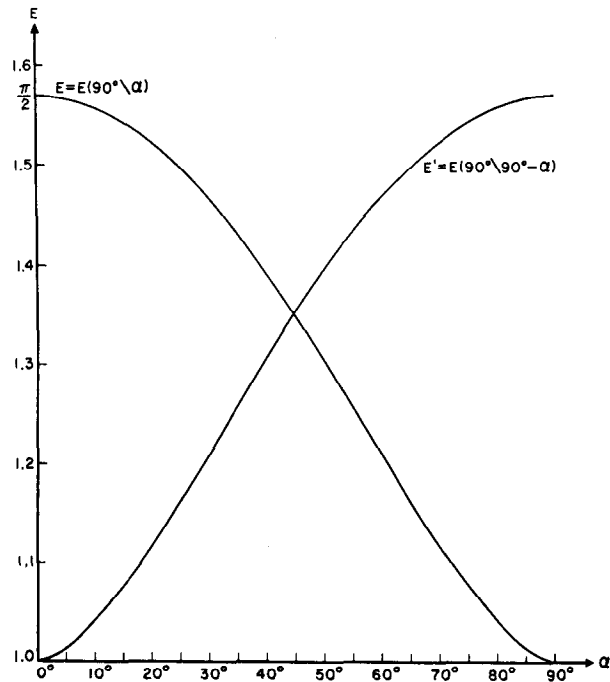

FIGURE 17.2. Complete elliptic integral of the second kind.

17.3.35

$$E(m) = [1 + a_1 m_1 + a_2 m_1^2] + [b_1 m_1 + b_2 m_1^2] \ln(1/m_1) + \epsilon(m)$$

$$|\epsilon(m)| < 4 \times 10^{-8}$$

$$\begin{matrix} a_1 = .46301 & 51 & b_1 = .24527 & 27 \\ a_2 = .10778 & 12 & b_2 = .04124 & 96 \end{matrix}$$

17.3.36

$$E(m) = [1 + a_1 m_1 + \dots + a_n m_1^n] + [b_1 m_1 + \dots + b_n m_1^n] \ln(1/m_1) + \epsilon(m)$$

$$|\epsilon(m)| < 2 \times 10^{-8}$$

$$\begin{matrix} a_1 = .44325 & 141463 & b_1 = .24998 & 368310 \\ a_2 = .06260 & 601220 & b_2 = .09200 & 180037 \\ a_3 = .04757 & 383546 & b_3 = .04069 & 697526 \\ a_4 = .01736 & 506451 & b_4 = .00526 & 449639 \end{matrix}$$

17.4. Incomplete Elliptic Integrals of the First and Second Kinds

Extension of the Tables

Negative Amplitude

17.4.1 $F(-\varphi|m) = -F(\varphi|m)$

17.4.2 $E(-\varphi|m) = -E(\varphi|m)$

Amplitude of Any Magnitude

17.4.3 $F(s\pi \pm \varphi|m) = 2sK \pm F(\varphi|m)$

17.4.4 $E(u + 2K) = E(u) + 2E$

17.4.5 $E(u + 2iK') = E(u) + 2i(K' - E')$

17.4.6

$$E(u + 2mK + 2niK') = E(u) + 2mE + 2ni(K' - E')$$

17.4.7 $E(K - u) = E' - E(u) + msn u \operatorname{cd} u$

Imaginary Amplitude

If $\tan \theta = \sinh \varphi$

17.4.8 $F(i\varphi|\alpha) = iF(\theta|\frac{1}{2}\pi - \alpha)$

17.4.9

$$E(i\varphi|\alpha) = -iE(\theta|\frac{1}{2}\pi - \alpha) + iF(\theta|\frac{1}{2}\pi - \alpha) + i \tan \theta (1 - \cos^2 \alpha \sin^2 \theta)^{\frac{1}{2}}$$

Jacobi's Imaginary Transformation

17.4.10

$$E(iu|m) = i[u + \operatorname{dn}(u|m_1)\operatorname{sc}(u|m_1) - E(u|m_1)]$$

Complex Amplitude

17.4.11 $F(\varphi + i\psi|m) = F(\lambda|m) + iF(\mu|m_1)$

where $\cot^2 \lambda$ is the positive root of the equation $x^2 - [\cot^2 \varphi + m \sinh^2 \psi \csc^2 \varphi - m_1]x - m_1 \cot^2 \varphi = 0$ and $m \tan^2 \mu = \tan^2 \varphi \cot^2 \lambda - 1$.

17.4.12

$$E(\varphi + i\psi \backslash \alpha) = E(\lambda \backslash \alpha) - iE(\mu \backslash 90^\circ - \alpha) + iF(\mu \backslash 90^\circ - \alpha) + \frac{b_1 + ib_2}{b_3}$$

where

$$b_1 = \sin^2 \alpha \sin \lambda \cos \lambda \sin^2 \mu (1 - \sin^2 \alpha \sin^2 \lambda)^{\frac{1}{2}}$$

$$b_2 = (1 - \sin^2 \alpha \sin^2 \lambda) (1 - \cos^2 \alpha \sin^2 \mu)^{\frac{1}{2}} \sin \mu \cos \mu$$

$$b_3 = \cos^2 \mu + \sin^2 \alpha \sin^2 \lambda \sin^2 \mu$$

Amplitude Near to $\pi/2$ (see also 17.5)

$$\text{If } \cos \alpha \tan \varphi \tan \psi = 1$$

17.4.13 $F(\varphi \backslash \alpha) + F(\psi \backslash \alpha) = F(\pi/2 \backslash \alpha) = K$

17.4.14

$$E(\varphi \backslash \alpha) + E(\psi \backslash \alpha) = E(\pi/2 \backslash \alpha) + \sin^2 \alpha \sin \varphi \sin \psi$$

Values when φ is near to $\pi/2$ and m is near to unity can be calculated by these formulae.

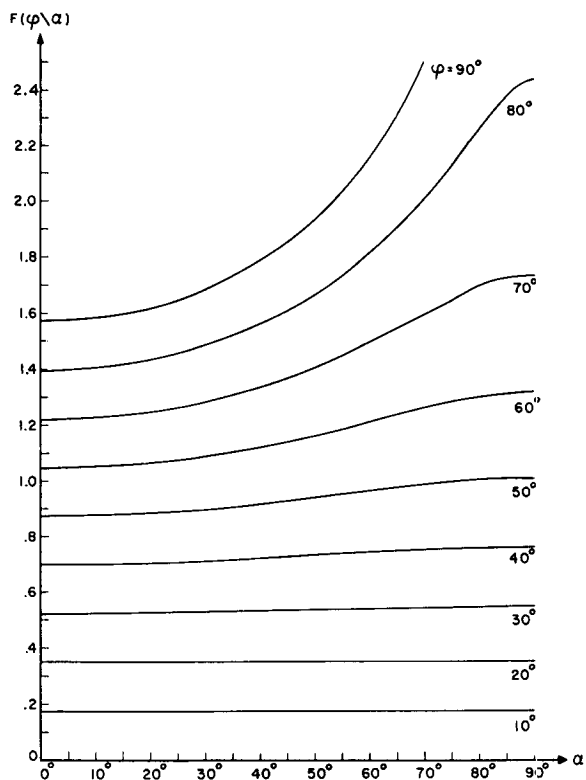

FIGURE 17.3. Incomplete elliptic integral of the first kind.

$F(\varphi \backslash \alpha)$, φ constant

Parameter Greater Than Unity

17.4.15 $F(\varphi | m) = m^{-\frac{1}{2}} F(\theta | m^{-1})$, $\sin \theta = m^{\frac{1}{2}} \sin \varphi$

17.4.16 $E(u | m) = m^{\frac{1}{2}} E(um^{\frac{1}{2}} | m^{-1}) - (m-1)u$

by which a parameter greater than unity can be replaced by a parameter less than unity.

Negative Parameter

17.4.17

$$F(\varphi | -m) = (1+m)^{-\frac{1}{2}} K(m(1+m)^{-1}) - (1+m)^{-\frac{1}{2}} F\left(\frac{\pi}{2} - \varphi | m(1+m)^{-1}\right)$$

17.4.18

$$E(u | -m) = (1+m)^{\frac{1}{2}} \{ E(u(1+m)^{\frac{1}{2}} | m(1+m)^{-1}) - m(1+m)^{-\frac{1}{2}} \text{sn}(u(1+m)^{\frac{1}{2}} | m(1+m)^{-1}) \text{cd}(u(1+m)^{\frac{1}{2}} | m(1+m)^{-1}) \}$$

whereby computations can be made for negative parameters, and therefore for pure imaginary modulus.

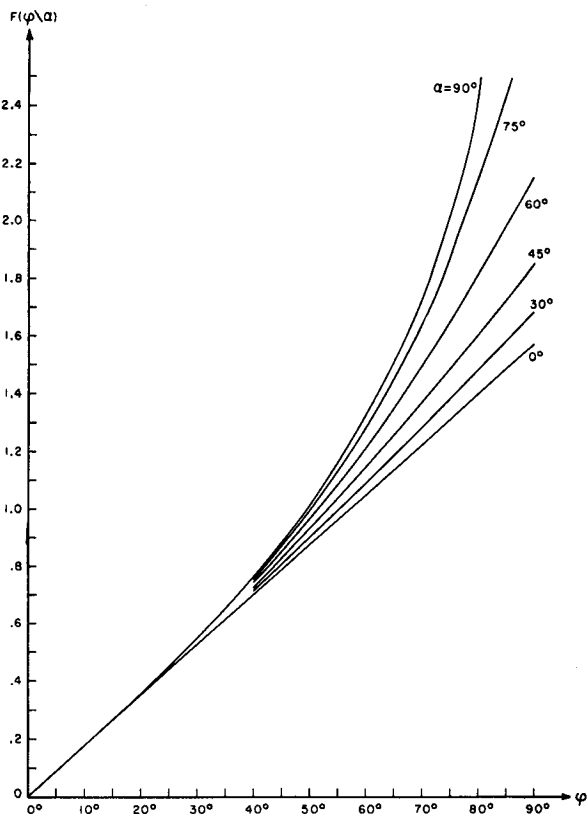

FIGURE 17.4. Incomplete elliptic integral of the first kind.

$F(\varphi \backslash \alpha)$, α constant

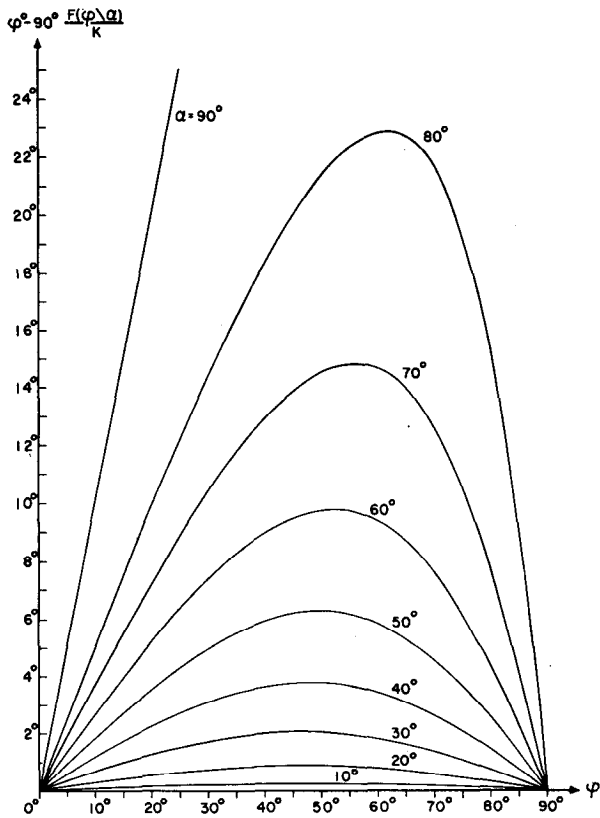

FIGURE 17.5. $\varphi - 90^\circ \frac{F(\varphi \setminus \alpha)}{K}$, α constant.

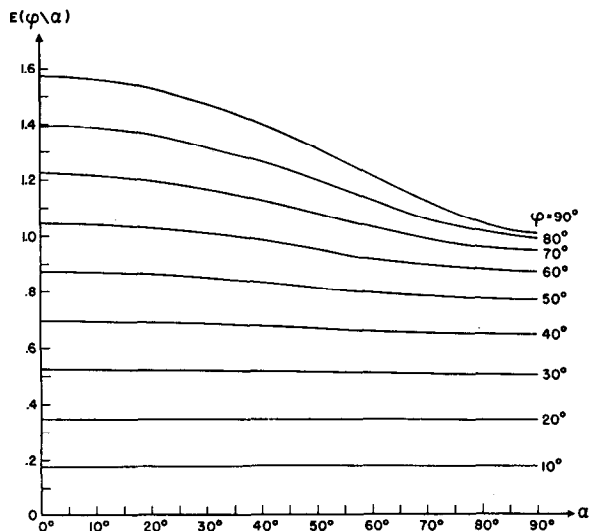

FIGURE 17.6. *Incomplete elliptic integral of the second kind.*

$E(\varphi \setminus \alpha)$, φ constant

Special Cases

17.4.19 $F(\varphi \setminus 0) = \varphi$

17.4.20 $F(i\varphi \setminus 0) = i\varphi$

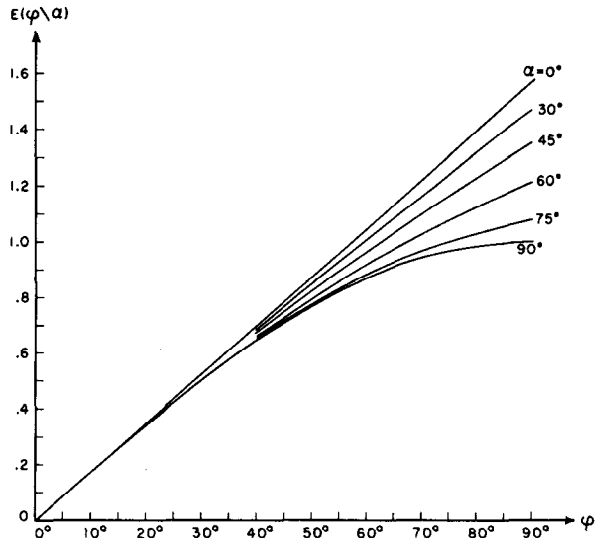

FIGURE 17.7. *Incomplete elliptic integral of the second kind.*

$E(\varphi \setminus \alpha)$, α constant

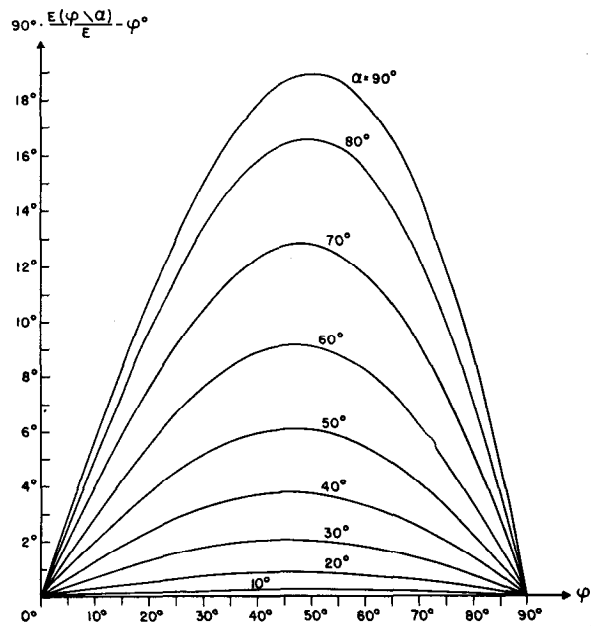

FIGURE 17.8. $90^\circ \frac{E(\varphi \setminus \alpha)}{E} - \varphi$, α constant.

17.4.21

$F(\varphi \setminus 90^\circ) = \ln(\sec \varphi + \tan \varphi) = \ln \tan \left(\frac{\pi}{4} + \frac{\varphi}{2} \right)$

17.4.22 $F(i\varphi \setminus 90^\circ) = i \arctan(\sinh \varphi)$

17.4.23 $E(\varphi \setminus 0) = \varphi$

17.4.24 $E(i\varphi \setminus 0) = i\varphi$

17.4.25 $E(\varphi \setminus 90^\circ) = \sin \varphi$

17.4.26 $E(i\varphi \setminus 90^\circ) = i \sinh \varphi$

Jacobi's Zeta Function

- 17.4.27 $Z(\varphi \backslash \alpha) = E(\varphi \backslash \alpha) - E(\alpha)F(\varphi \backslash \alpha)/K(\alpha)$
- 17.4.28 $Z(u|m) = Z(u) = E(u) - uE(m)/K(m)$
- 17.4.29 $Z(-u) = -Z(u)$
- 17.4.30 $Z(u + 2K) = Z(u)$
- 17.4.31 $Z(K - u) = -Z(K + u)$
- 17.4.32 $Z(u) = Z(u - K) - m \operatorname{sn}(u - K) \operatorname{cd}(u - K)$

Special Values

- 17.4.33 $Z(u|0) = 0$
- 17.4.34 $Z(u|1) = \tanh u$

Addition Theorem

- 17.4.35 $Z(u + v) = Z(u) + Z(v) - m \operatorname{sn} u \operatorname{sn} v \operatorname{sn}(u + v)$

Jacobi's Imaginary Transformation

- 17.4.36 $iZ(iu|m) = Z(u|m_1) + \frac{\pi u}{2KK'} - \operatorname{dn}(u|m_1) \operatorname{sc}(u|m_1)$

Relation to Jacobi's Theta Function

- 17.4.37 $Z(u) = \Theta'(u)/\Theta(u) = \frac{d}{du} \ln \Theta(u)$

q-Series

- 17.4.38 $Z(u) = \frac{2\pi}{K} \sum_{s=1}^{\infty} q^s (1 - q^{2s})^{-1} \sin(\pi s u / K)$

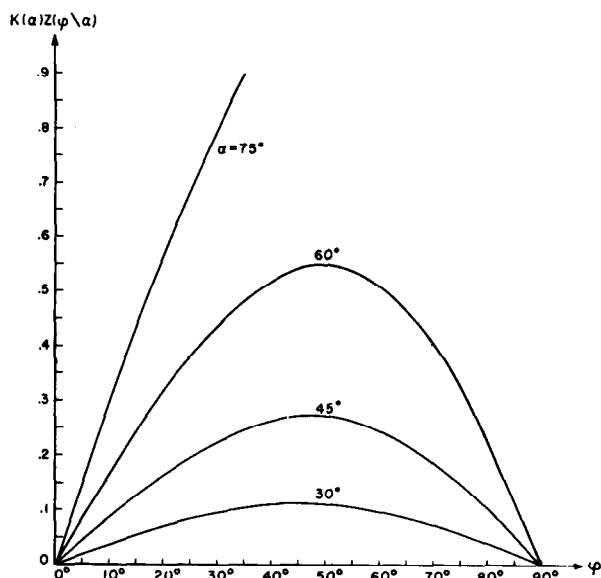

FIGURE 17.9. *Jacobian zeta function* $K(\alpha)Z(\varphi \backslash \alpha)$.

*See page II.

Heuman's Lambda Function

17.4.39

$$\Lambda_0(\varphi \backslash \alpha) = \frac{F(\varphi \backslash 90^\circ - \alpha)}{K'(\alpha)} + \frac{2}{\pi} K(\alpha) Z(\varphi \backslash 90^\circ - \alpha)$$

17.4.40

$$= \frac{2}{\pi} \{ K(\alpha) E(\varphi \backslash 90^\circ - \alpha) - [K(\alpha) - E(\alpha)] F(\varphi \backslash 90^\circ - \alpha) \}$$

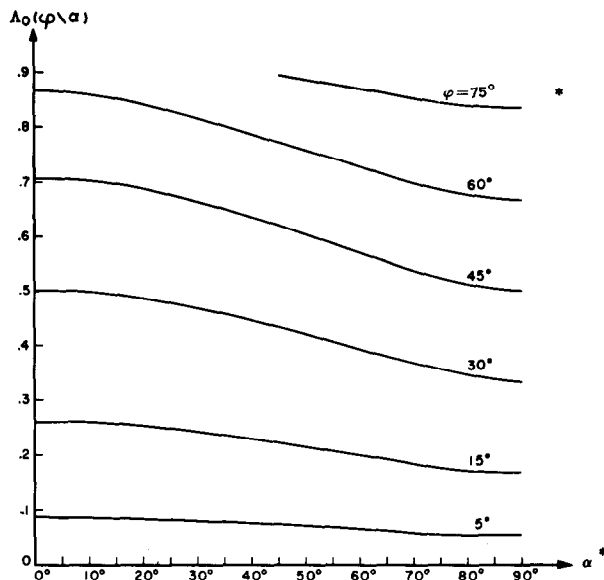

FIGURE 17.10. *Heuman's lambda function* $\Lambda_0(\varphi \backslash \alpha)$.

Numerical Evaluation of Incomplete Integrals of the First and Second Kinds

For the numerical evaluation of an elliptic integral the quartic (or cubic⁴) under the radical should first be expressed in terms of t^2 , see **Examples 1 and 2**. In the resulting quartic there are only six possible sign patterns or combinations of the factors namely

$$(t^2 + a^2)(t^2 + b^2), (a^2 - t^2)(t^2 - b^2), (a^2 - t^2)(b^2 - t^2), (t^2 - a^2)(t^2 - b^2), (t^2 + a^2)(t^2 - b^2), (t^2 + a^2)(b^2 - t^2).$$

The list which follows is then exhaustive for integrals which reduce to $F(\varphi \backslash \alpha)$ or $E(\varphi \backslash \alpha)$.

The value of the elliptic integral of the first kind is also expressed as an *inverse* Jacobian elliptic function. Here, for example, the notation $u = \operatorname{sn}^{-1} x$ means that $x = \operatorname{sn} u$.

The column headed "*t* substitution" gives the Jacobian elliptic function substitution which is appropriate to reduce every elliptic integral which contains the given quartic.

⁴ For an alternate treatment of cubics see 17.4.61 and 17.4.70.

	$F(\varphi \setminus \alpha)$	Equivalent Inverse Jacobian Elliptic Function	φ	t Substitution	$E(\varphi \setminus \alpha)$
$\cos \alpha = b/a$ $a > b$ $m = (a^2 - b^2)/a^2$	17.4.41 $a \int_0^x \frac{dt}{[(t^2 + a^2)(t^2 + b^2)]^{1/2}}$	$\operatorname{sc}^{-1} \left(\frac{x}{b} \middle \frac{a^2 - b^2}{a^2} \right)$	$\tan \varphi = \frac{x}{b}$	$t = b \operatorname{sc} v$	$\frac{b^2}{a} \int_0^x \frac{(t^2 + a^2)}{(t^2 + b^2)} \frac{dt}{[(t^2 + a^2)(t^2 + b^2)]^{1/2}}$
	17.4.42 $a \int_x^\infty \frac{dt}{[(t^2 + a^2)(t^2 + b^2)]^{1/2}}$	$\operatorname{cs}^{-1} \left(\frac{x}{a} \middle \frac{a^2 - b^2}{a^2} \right)$	$\tan \varphi = \frac{a}{x}$	$t = a \operatorname{cs} v$	$a \int_x^\infty \frac{(t^2 + b^2)}{(t^2 + a^2)} \frac{dt}{[(t^2 + a^2)(t^2 + b^2)]^{1/2}}$
	17.4.43 $a \int_b^x \frac{dt}{[(a^2 - t^2)(t^2 - b^2)]^{1/2}}$	$\operatorname{nd}^{-1} \left(\frac{x}{b} \middle \frac{a^2 - b^2}{a^2} \right)$	$\sin^2 \varphi = \frac{a^2(x^2 - b^2)}{x^2(a^2 - b^2)}$	$t = b \operatorname{nd} v$	$ab^2 \int_b^x \frac{1}{t^2} \frac{dt}{[(a^2 - t^2)(t^2 - b^2)]^{1/2}}$
	17.4.44 $a \int_x^a \frac{dt}{[(a^2 - t^2)(t^2 - b^2)]^{1/2}}$	$\operatorname{dn}^{-1} \left(\frac{x}{a} \middle \frac{a^2 - b^2}{a^2} \right)$	$\sin^2 \varphi = \frac{a^2 - x^2}{a^2 - b^2}$	$t = a \operatorname{dn} v$	$\frac{1}{a} \int_x^a \frac{t dt}{[(a^2 - t^2)(t^2 - b^2)]^{1/2}}$
	17.4.45 $a \int_0^x \frac{dt}{[(a^2 - t^2)(b^2 - t^2)]^{1/2}}$	$\operatorname{sn}^{-1} \left(\frac{x}{b} \middle \frac{b^2}{a^2} \right)$	$\sin \varphi = \frac{x}{b}$	$t = b \operatorname{sn} v$	$\frac{1}{a} \int_0^x \frac{(a^2 - t^2) dt}{[(a^2 - t^2)(b^2 - t^2)]^{1/2}}$
$\sin \alpha = b/a$ $a > b$ $m = b^2/a^2$	17.4.46 $a \int_x^b \frac{dt}{[(a^2 - t^2)(b^2 - t^2)]^{1/2}}$	$\operatorname{cd}^{-1} \left(\frac{x}{b} \middle \frac{b^2}{a^2} \right)$	$\sin^2 \varphi = \frac{a^2(b^2 - x^2)}{b^2(a^2 - x^2)}$	$t = b \operatorname{cd} v$	$a(a^2 - b^2) \int_x^b \frac{1}{(a^2 - t^2)} \frac{dt}{[(a^2 - t^2)(b^2 - t^2)]^{1/2}}$
	17.4.47 $a \int_a^x \frac{dt}{[(t^2 - a^2)(t^2 - b^2)]^{1/2}}$	$\operatorname{dc}^{-1} \left(\frac{x}{a} \middle \frac{b^2}{a^2} \right)$	$\sin^2 \varphi = \frac{x^2 - a^2}{x^2 - b^2}$	$t = a \operatorname{dc} v$	$\frac{a^2 - b^2}{a} \int_a^x \frac{t^2}{(t^2 - b^2)} \frac{dt}{[(t^2 - a^2)(t^2 - b^2)]^{1/2}}$
	17.4.48 $a \int_x^\infty \frac{dt}{[(t^2 - a^2)(t^2 - b^2)]^{1/2}}$	$\operatorname{ns}^{-1} \left(\frac{x}{a} \middle \frac{b^2}{a^2} \right)$	$\sin \varphi = \frac{a}{x}$	$t = a \operatorname{ns} v$	$a \int_x^\infty \frac{(t^2 - b^2)}{t^2} \frac{dt}{[(t^2 - a^2)(t^2 - b^2)]^{1/2}}$
$\cot \alpha = \frac{b}{a}$ $m = a^2/(a^2 + b^2)$	17.4.49 $(a^2 + b^2)^{1/2} \int_b^x \frac{dt}{[(t^2 + a^2)(t^2 - b^2)]^{1/2}}$	$\operatorname{nc}^{-1} \left(\frac{x}{b} \middle \frac{a^2}{a^2 + b^2} \right)$	$\cos \varphi = \frac{b}{x}$	$t = b \operatorname{nc} v$	$\frac{b^3}{(a^2 + b^2)^{1/2}} \int_b^x \frac{t^2 + a^2}{t^2} \frac{dt}{[(t^2 + a^2)(t^2 - b^2)]^{1/2}}$
	17.4.50 $(a^2 + b^2)^{1/2} \int_x^\infty \frac{dt}{[(t^2 + a^2)(t^2 - b^2)]^{1/2}}$	$\operatorname{ds}^{-1} \left(\frac{x}{(a^2 + b^2)^{1/2}} \middle \frac{a^2}{a^2 + b^2} \right)$	$\sin^2 \varphi = \frac{a^2 + b^2}{a^2 + x^2}$	$t = (a^2 + b^2)^{1/2} \operatorname{ds} v$	$(a^2 + b^2)^{1/2} \int_x^\infty \frac{t^2}{(t^2 + a^2)} \frac{dt}{[(t^2 + a^2)(t^2 - b^2)]^{1/2}}$
$\tan \alpha = \frac{b}{a}$ $m = b^2/(a^2 + b^2)$	17.4.51 $(a^2 + b^2)^{1/2} \int_0^x \frac{dt}{[(t^2 + a^2)(b^2 - t^2)]^{1/2}}$	$\operatorname{sd}^{-1} \left(\frac{x(a^2 + b^2)^{1/2}}{ab} \middle \frac{b^2}{a^2 + b^2} \right)$	$\sin^2 \varphi = \frac{x^2(a^2 + b^2)}{b^2(a^2 + x^2)}$	$t = \frac{ab}{(a^2 + b^2)^{1/2}} \operatorname{sd} v$	$a^2(a^2 + b^2)^{1/2} \int_0^x \frac{1}{(t^2 + a^2)} \frac{dt}{[(t^2 + a^2)(b^2 - t^2)]^{1/2}}$
	17.4.52 $(a^2 + b^2)^{1/2} \int_x^b \frac{dt}{[(t^2 + a^2)(b^2 - t^2)]^{1/2}}$	$\operatorname{cn}^{-1} \left(\frac{x}{b} \middle \frac{b^2}{a^2 + b^2} \right)$	$\cos \varphi = \frac{x}{b}$	$t = b \operatorname{cn} v$	$\frac{1}{(a^2 + b^2)^{1/2}} \int_x^b \frac{(t^2 + a^2) dt}{[(t^2 + a^2)(b^2 - t^2)]^{1/2}}$

Some Important Special Cases

$\frac{1}{2}F(\varphi \setminus \alpha)$	$\cos \varphi$	α	$\frac{1}{3^{1/4}}F(\varphi \setminus \alpha)$	$\cos \varphi$	α
17.4.53 $\int_x^\infty \frac{dt}{(1+t^2)^{3/2}}$	$\frac{x^2-1}{x^2+1}$	45°	17.4.57 $\int_x^\infty \frac{dt}{(\beta^2-1)^{3/2}}$	$\frac{x-1-\sqrt{3}}{x-1+\sqrt{3}}$	15°
17.4.54 $\int_0^x \frac{dt}{(1+t^2)^{3/2}}$	$\frac{1-x^2}{1+x^2}$	45°	17.4.58 $\int_1^x \frac{dt}{(\beta^2-1)^{3/2}}$	$\frac{\sqrt{3}+1-x}{\sqrt{3}-1+x}$	15°
17.4.55 $\frac{1}{2}^{1/2} \int_1^x \frac{dt}{(t^2-1)^{3/2}}$	$\frac{1}{x}$	45°	17.4.59 $\int_x^1 \frac{dt}{(1-\beta^2)^{3/2}}$	$\frac{\sqrt{3}-1+x}{\sqrt{3}+1-x}$	75°
17.4.56 $\frac{1}{2}^{1/2} \int_x^1 \frac{dt}{(1-t^2)^{3/2}}$	x	45°	17.4.60 $\int_{-\infty}^x \frac{dt}{(1-\beta^2)^{3/2}}$	$\frac{1-\sqrt{3}-x}{1+\sqrt{3}-x}$	75°

Reduction of $\int dt/\sqrt{P}$ where $P=P(t)$ is a cubic polynomial with three real factors $P=(t-\beta_1)(t-\beta_2)(t-\beta_3)$ where $\beta_1 > \beta_2 > \beta_3$. Write

17.4.61

$$\lambda = \frac{1}{2}(\beta_1 - \beta_3)^{1/2}, \quad m = \sin^2 \alpha = \frac{\beta_2 - \beta_3}{\beta_1 - \beta_3},$$

$$m_1 = \cos^2 \alpha = \frac{\beta_1 - \beta_2}{\beta_1 - \beta_3}$$

17.4.62

$$\lambda \int_{\beta_3}^x \frac{dt}{\sqrt{P}} \quad F(\varphi \setminus \alpha) \quad \sin^2 \varphi = \frac{x - \beta_3}{\beta_2 - \beta_3}$$

17.4.63

$$\lambda \int_x^{\beta_2} \frac{dt}{\sqrt{P}} \quad F(\varphi \setminus \alpha) \quad \cos^2 \varphi = \frac{(\beta_1 - \beta_2)(x - \beta_3)}{(\beta_2 - \beta_3)(\beta_1 - x)}$$

17.4.64

$$\lambda \int_{\beta_1}^x \frac{dt}{\sqrt{P}} \quad F(\varphi \setminus \alpha) \quad \sin^2 \varphi = \frac{x - \beta_1}{x - \beta_2}$$

17.4.65

$$\lambda \int_x^\infty \frac{dt}{\sqrt{P}} \quad F(\varphi \setminus \alpha) \quad \cos^2 \varphi = \frac{x - \beta_1}{x - \beta_3}$$

17.4.66

$$\lambda \int_{-\infty}^x \frac{dt}{\sqrt{-P}} \quad F(\varphi \setminus (90^\circ - \alpha^\circ)) \quad \sin^2 \varphi = \frac{\beta_1 - \beta_3}{\beta_1 - x}$$

17.4.67

$$\lambda \int_x^{\beta_3} \frac{dt}{\sqrt{-P}} \quad F(\varphi \setminus (90^\circ - \alpha^\circ)) \quad \cos^2 \varphi = \frac{\beta_2 - \beta_3}{\beta_2 - x}$$

17.4.68

$$\lambda \int_{\beta_2}^x \frac{dt}{\sqrt{-P}} \quad F(\varphi \setminus (90^\circ - \alpha^\circ)) \quad \sin^2 \varphi = \frac{(\beta_1 - \beta_3)(x - \beta_2)}{(\beta_1 - \beta_2)(x - \beta_3)}$$

17.4.69

$$\lambda \int_x^{\beta_1} \frac{dt}{\sqrt{-P}} \quad F(\varphi \setminus (90^\circ - \alpha^\circ)) \quad \cos^2 \varphi = \frac{x - \beta_2}{\beta_1 - \beta_2}$$

Reduction of $\int dt/\sqrt{P}$ when $P=P(t)=t^3+a_2t^2+a_1t+a_0$ is a cubic polynomial with only one real root $t=\beta$. We form the first and second derivatives $P'(t), P''(t)$ with respect to t and then write

17.4.70 $\lambda^2 = [P'(\beta)]^{1/2}, \quad m = \sin^2 \alpha = \frac{1}{2} \frac{1}{8} \frac{P''(\beta)}{[P'(\beta)]^{1/2}}$

17.4.71

$$\lambda \int_{\beta}^x \frac{dt}{\sqrt{P}} \quad F(\varphi \setminus \alpha) \quad \cos \varphi = \frac{\lambda^2 - (x - \beta)}{\lambda^2 + (x - \beta)}$$

17.4.72

$$\lambda \int_x^\infty \frac{dt}{\sqrt{P}} \quad F(\varphi \setminus \alpha) \quad \cos \varphi = \frac{(x - \beta) - \lambda^2}{(x - \beta) + \lambda^2}$$

17.4.73

$$\lambda \int_{-\infty}^x \frac{dt}{\sqrt{(-P)}} \quad F(\varphi \setminus (90^\circ - \alpha^\circ)) \quad \cos \varphi = \frac{(\beta - x) - \lambda^2}{(\beta - x) + \lambda^2}$$

17.4.74

$$\lambda \int_x^{\beta} \frac{dt}{\sqrt{(-P)}} \quad F(\varphi \setminus (90^\circ - \alpha^\circ)) \quad \cos \varphi = \frac{\lambda^2 - (\beta - x)}{\lambda^2 + (\beta - x)}$$

17.5. Landen's Transformation

Descending Landen Transformation ⁵

Let α_n, α_{n+1} be two modular angles such that

17.5.1 $(1 + \sin \alpha_{n+1})(1 + \cos \alpha_n) = 2 \quad (\alpha_{n+1} < \alpha_n)$

and let φ_n, φ_{n+1} be two corresponding amplitudes such that

17.5.2 $\tan(\varphi_{n+1} - \varphi_n) = \cos \alpha_n \tan \varphi_n \quad (\varphi_{n+1} > \varphi_n)$

⁵ The emphasis here is on the modular angle since this is an argument of the Tables. All formulae concerning Landen's transformation may also be expressed in terms of the modulus $k = m^{\frac{1}{2}} = \sin \alpha$ and its complement $k' = m^{\frac{1}{2}} = \cos \alpha$.

Thus the step from n to $n+1$ decreases the modular angle but increases the amplitude. By iterating the process we can descend from a given modular angle to one whose magnitude is negligible, when 17.4.19 becomes applicable.

With $\alpha_0 = \alpha$ we have

17.5.3

$$F(\varphi \setminus \alpha) = (1 + \cos \alpha)^{-1} F(\varphi_1 \setminus \alpha_1) \\ = \frac{1}{2} (1 + \sin \alpha_1) F(\varphi_1 \setminus \alpha_1)$$

17.5.4 $F(\varphi \setminus \alpha) = 2^{-n} \prod_{s=1}^n (1 + \sin \alpha_s) F(\varphi_n \setminus \alpha_n)$

17.5.5 $F(\varphi \setminus \alpha) = \Phi \prod_{s=1}^{\infty} (1 + \sin \alpha_s)$

17.5.6 $\Phi = \lim_{n \rightarrow \infty} \frac{1}{2^n} F(\varphi_n \setminus \alpha_n) = \lim_{n \rightarrow \infty} \frac{\varphi_n}{2^n}$

17.5.7 $K = F(\frac{1}{2}\pi \setminus \alpha) = \frac{1}{2}\pi \prod_{s=1}^{\infty} (1 + \sin \alpha_s)$

17.5.8 $F(\varphi \setminus \alpha) = 2\pi^{-1} K \Phi$

17.5.9

$$E(\varphi \setminus \alpha) = F(\varphi \setminus \alpha) \left[1 - \frac{1}{2} \sin^2 \alpha \left(1 + \frac{1}{2} \sin \alpha_1 \right. \right. \\ \left. \left. + \frac{1}{2^2} \sin \alpha_1 \sin \alpha_2 + \dots \right) \right] + \sin \alpha \left[\frac{1}{2} (\sin \alpha_1)^{1/2} \sin \varphi_1 \right. \\ \left. + \frac{1}{2^2} (\sin \alpha_1 \sin \alpha_2)^{1/2} \sin \varphi_2 + \dots \right]$$

17.5.10

$$E = K \left[1 - \frac{1}{2} \sin^2 \alpha \left(1 + \frac{1}{2} \sin \alpha_1 + \frac{1}{2^2} \sin \alpha_1 \sin \alpha_2 \right. \right. \\ \left. \left. + \frac{1}{2^3} \sin \alpha_1 \sin \alpha_2 \sin \alpha_3 + \dots \right) \right]$$

Ascending Landen Transformation

Let α_n, α_{n+1} be two modular angles such that

17.5.11 $(1 + \sin \alpha_n)(1 + \cos \alpha_{n+1}) = 2 \quad (\alpha_{n+1} > \alpha_n)$

and let φ_n, φ_{n+1} be two corresponding amplitudes such that

17.5.12 $\sin(2\varphi_{n+1} - \varphi_n) = \sin \alpha_n \sin \varphi_n \quad (\varphi_{n+1} < \varphi_n)$

Thus the step from n to $n+1$ increases the modular angle but decreases the amplitude. By iterating the process we can ascend from a given modular angle to one whose difference from a right angle is so small that 17.4.21 becomes applicable.

With $\alpha_0 = \alpha$ we have

17.5.13 $F(\varphi \setminus \alpha) = 2(1 + \sin \alpha)^{-1} F(\varphi_1 \setminus \alpha_1)$

17.5.14 $F(\varphi \setminus \alpha) = 2^n \prod_{s=0}^{n-1} (1 + \sin \alpha_s)^{-1} F(\varphi_n \setminus \alpha_n)$

17.5.15 $F(\varphi \setminus \alpha) = \prod_{s=1}^n (1 + \cos \alpha_s) F(\varphi_n \setminus \alpha_n)$

17.5.16 $F(\varphi \setminus \alpha) = [\csc \alpha \prod_{s=1}^{\infty} \sin \alpha_s]^{\frac{1}{2}} \ln \tan \left(\frac{1}{4} \pi + \frac{1}{2} \Phi \right)$

17.5.17 $\Phi = \lim_{n \rightarrow \infty} \varphi_n$

Neighborhood of a Right Angle (see also 17.4.13)

When both φ and α are near to a right angle, interpolation in the table $F(\varphi \setminus \alpha)$ is difficult. Either Landen's transformation can then be used with advantage to increase the modular angle and decrease the amplitude or vice-versa.

17.6. The Process of the Arithmetic-Geometric Mean

Starting with a given number triple (a_0, b_0, c_0) we proceed to determine number triples $(a_1, b_1, c_1), (a_2, b_2, c_2), \dots, (a_N, b_N, c_N)$ according to the following scheme of arithmetic and geometric means

17.6.1

a_0	b_0	
$a_1 = \frac{1}{2}(a_0 + b_0)$	$b_1 = (a_0 b_0)^{\frac{1}{2}}$	
$a_2 = \frac{1}{2}(a_1 + b_1)$	$b_2 = (a_1 b_1)^{\frac{1}{2}}$	
⋮	⋮	
$a_N = \frac{1}{2}(a_{N-1} + b_{N-1})$	$b_N = (a_{N-1} b_{N-1})^{\frac{1}{2}}$	
		c_0
		$c_1 = \frac{1}{2}(a_0 - b_0)$
		$c_2 = \frac{1}{2}(a_1 - b_1)$
		⋮
		$c_N = \frac{1}{2}(a_{N-1} - b_{N-1})$

We stop at the N th step when $a_N = b_N$, i.e., when $c_N = 0$ to the degree of accuracy to which the numbers are required.

To determine the complete elliptic integrals $K(\alpha), E(\alpha)$ we start with

17.6.2 $a_0 = 1, b_0 = \cos \alpha, c_0 = \sin \alpha$

whence

17.6.3 $K(\alpha) = \frac{\pi}{2a_N}$

17.6.4 $\frac{K(\hat{\alpha}) - E(\alpha)}{K(\alpha)} = \frac{1}{2} [c_0^2 + 2c_1^2 + 2^2c_2^2 + \dots + 2^N c_N^2]$

To determine $K'(\alpha)$, $E'(\alpha)$ we start with

17.6.5 $a'_0 = 1, b'_0 = \sin \alpha, c'_0 = \cos \alpha$

whence

17.6.6 $K'(\alpha) = \frac{\pi}{2a'_N}$

17.6.7

$\frac{K'(\alpha) - E'(\alpha)}{K'(\alpha)} = \frac{1}{2} [c_0'^2 + 2c_1'^2 + 2^2c_2'^2 + \dots + 2^N c_N'^2]$

To calculate $F(\varphi \setminus \alpha)$, $E(\varphi \setminus \alpha)$ start from 17.5.2 which corresponds to the descending Landen transformation and determine $\varphi_1, \varphi_2, \dots, \varphi_N$ successively from the relation

17.6.8 $\tan(\varphi_{n+1} - \varphi_n) = (b_n/a_n) \tan \varphi_n, \varphi_0 = \varphi$

Then to the prescribed accuracy

17.6.9 $F(\varphi \setminus \alpha) = \varphi_N / (2^N a_N) \quad *$

17.6.10

$Z(\varphi \setminus \alpha) = E(\varphi \setminus \alpha) - (E/K)F(\varphi \setminus \alpha)$

* $= c_1 \sin \varphi_1 + c_2 \sin \varphi_2 + \dots + c_N \sin \varphi_N$

17.7. Elliptic Integrals of the Third Kind

17.7.1

$\Pi(n; \varphi \setminus \alpha) = \int_0^\varphi (1 - n \sin^2 \theta)^{-1} (1 - \sin^2 \alpha \sin^2 \theta)^{-1/2} d\theta$

17.7.2 $\Pi(n; \frac{1}{2}\pi \setminus \alpha) = \Pi(n \setminus \alpha)$

Case (i) Hyperbolic Case $0 < n < \sin^2 \alpha$

$\epsilon = \arcsin(n/\sin^2 \alpha)^{1/2}, \quad 0 \leq \epsilon \leq \frac{1}{2}\pi$

$\beta = \frac{1}{2}\pi F(\epsilon \setminus \alpha) / K(\alpha)$

$q = q(\alpha)$

$v = \frac{1}{2}\pi F(\varphi \setminus \alpha) / K(\alpha),$

$\delta_1 = [n(1-n)^{-1}(\sin^2 \alpha - n)^{-1}]^{1/2}$

17.7.3

$\Pi(n; \varphi \setminus \alpha) = \delta_1 [-\frac{1}{2} \ln \{\vartheta_4(v+\beta)/\vartheta_4(v-\beta)\} + v\vartheta_1'(\beta)/\vartheta_1(\beta)]$

17.7.4

$\frac{1}{2} \ln \frac{\vartheta_4(v+\beta)}{\vartheta_4(v-\beta)} = 2 \sum_{s=1}^{\infty} s^{-1} q^s (1 - q^{2s})^{-1} \sin 2sv \sin 2s\beta$

17.7.5

$\frac{\vartheta_1'(\beta)}{\vartheta_1(\beta)} = \cot \beta + 4 \sum_{s=1}^{\infty} q^{2s} (1 - 2q^{2s} \cos 2\beta + q^{4s})^{-1} \sin 2\beta$

In the above we can also use Neville's theta functions 16.36.

17.7.6 $\Pi(n \setminus \alpha) = K(\alpha) + \delta_1 K(\alpha) Z(\epsilon \setminus \alpha)$

Case (ii) Hyperbolic Case $n > 1$

The case $n > 1$ can be reduced to the case $0 < N < \sin^2 \alpha$ by writing

17.7.7 $N = n^{-1} \sin^2 \alpha, p_1 = [(n-1)(1 - n^{-1} \sin^2 \alpha)]^{1/2}$

17.7.8

$\Pi(n; \varphi \setminus \alpha) = -\Pi(N; \varphi \setminus \alpha) + F(\varphi \setminus \alpha) + \frac{1}{2p_1} \ln [(\Delta(\varphi) + p_1 \tan \varphi)(\Delta(\varphi) - p_1 \tan \varphi)^{-1}]$

where $\Delta(\varphi)$ is the delta amplitude, 17.2.4.

17.7.9 $\Pi(n \setminus \alpha) = K(\alpha) - \Pi(N \setminus \alpha)$

Case (iii) Circular Case $\sin^2 \alpha < n < 1$

$\epsilon = \arcsin[(1-n)/\cos^2 \alpha]^{1/2} \quad 0 \leq \epsilon \leq \frac{1}{2}\pi$

$\beta = \frac{1}{2}\pi F(\epsilon \setminus 90^\circ - \alpha) / K(\alpha)$

$q = q(\alpha)$

17.7.10

$v = \frac{1}{2}\pi F(\varphi \setminus \alpha) / K(\alpha), \delta_2 = [n(1-n)^{-1}(n - \sin^2 \alpha)^{-1}]^{1/2}$

17.7.11 $\Pi(n; \varphi \setminus \alpha) = \delta_2 (\lambda - 4\mu v)$

17.7.12

$\lambda = \arctan(\tanh \beta \tan v) + 2 \sum_{s=1}^{\infty} (-1)^{s-1} s^{-1} q^{2s} (1 - q^{2s})^{-1} \sin 2sv \sinh 2s\beta$

17.7.13

$\mu = \left[\sum_{s=1}^{\infty} s q^{2s} \sinh 2s\beta \right] \left[1 + 2 \sum_{s=1}^{\infty} q^{2s} \cosh 2s\beta \right]^{-1}$

17.7.14 $\Pi(n \setminus \alpha) = K(\alpha) + \frac{1}{2}\pi \delta_2 [1 - \Lambda_0(\epsilon \setminus \alpha)]$

where Λ_0 is Heuman's Lambda function, 17.4.39.

*See page 11.

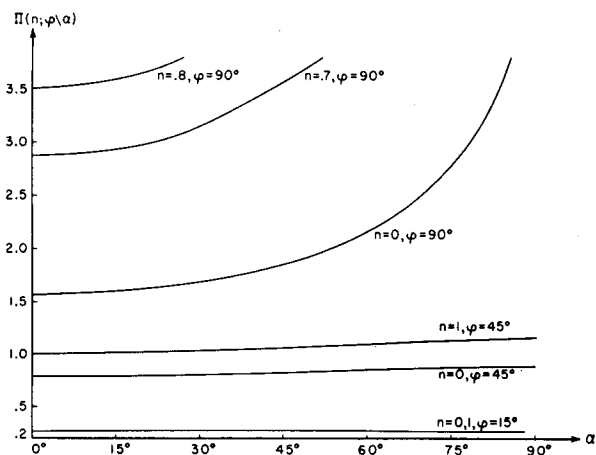

FIGURE 17.11. *Elliptic integral of the third kind*
 $\Pi(n; \varphi \setminus \alpha)$.

Case (iv) Circular Case $n < 0$

The case $n < 0$ can be reduced to the case $\sin^2 \alpha < N < 1$ by writing

17.7.15

$$N = (\sin^2 \alpha - n)(1 - n)^{-1}$$

$$p_2 = [-n(1 - n)^{-1}(\sin^2 \alpha - n)]^{\frac{1}{2}}$$

17.7.16

$$\begin{aligned} & [(1 - n)(1 - n^{-1} \sin^2 \alpha)]^{\frac{1}{2}} \Pi(n; \varphi \setminus \alpha) \\ &= [(1 - N)(1 - N^{-1} \sin^2 \alpha)]^{\frac{1}{2}} \Pi(N; \varphi \setminus \alpha) \\ &+ p_2^{-1} \sin^2 \alpha F(\varphi \setminus \alpha) + \arctan \left[\frac{1}{2} p_2 \sin 2\varphi / \Delta(\varphi) \right] \end{aligned}$$

17.7.17

$$\begin{aligned} \Pi(n \setminus \alpha) &= (-n \cos^2 \alpha)(1 - n)^{-1}(\sin^2 \alpha - n)^{-1} \Pi(N \setminus \alpha) \\ &+ \sin^2 \alpha (\sin^2 \alpha - n)^{-1} K(\alpha) \end{aligned}$$

Special Cases

17.7.18

$$n = 0$$

$$\Pi(0; \varphi \setminus \alpha) = F(\varphi \setminus \alpha)$$

17.7.19

$$n = 0, \alpha = 0$$

$$\Pi(0; \varphi \setminus 0) = \varphi$$

17.7.20

$$\alpha = 0$$

$$\begin{aligned} \Pi(n; \varphi \setminus 0) &= (1 - n)^{-\frac{1}{2}} \arctan [(1 - n)^{\frac{1}{2}} \tan \varphi], & n < 1 \\ &= (n - 1)^{-\frac{1}{2}} \operatorname{arctanh} [(n - 1)^{\frac{1}{2}} \tan \varphi], & n > 1 \\ &= \tan \varphi & n = 1 \end{aligned}$$

17.7.21

$$\alpha = \pi/2$$

$$\begin{aligned} \Pi(n; \varphi \setminus \pi/2) &= (1 - n)^{-1} [\ln (\tan \varphi + \sec \varphi) \\ &- \frac{1}{2} n^{\frac{1}{2}} \ln (1 + n^{\frac{1}{2}} \sin \varphi)(1 - n^{\frac{1}{2}} \sin \varphi)^{-1}] \quad n \neq 1 \end{aligned}$$

17.7.22

$$n = \pm \sin \alpha$$

$$\begin{aligned} (1 \mp \sin \alpha) \{ 2\Pi(\pm \sin \alpha; \varphi \setminus \alpha) - F(\varphi \setminus \alpha) \} \\ = \arctan [(1 \mp \sin \alpha) \tan \varphi / \Delta(\varphi)] \end{aligned}$$

17.7.23

$$n = 1 \pm \cos \alpha$$

$$\begin{aligned} 2 \cos \alpha \Pi(1 \pm \cos \alpha; \varphi \setminus \alpha) &= \pm \frac{1}{2} \ln [(1 + \tan \varphi \\ &\cdot \Delta(\varphi))(1 - \tan \varphi \cdot \Delta(\varphi))^{-1}] + \frac{1}{2} \ln [(\Delta(\varphi) \\ &+ \cos \alpha \cdot \tan \varphi)(\Delta(\varphi) - \cos \alpha \tan \varphi)^{-1}] \\ &\mp (1 \mp \cos \alpha) F(\varphi \setminus \alpha) \end{aligned}$$

17.7.24

$$n = \sin^2 \alpha$$

$$\Pi(\sin^2 \alpha; \varphi \setminus \alpha) = \sec^2 \alpha E(\varphi \setminus \alpha) - (\tan^2 \alpha \sin 2\varphi) / (2\Delta(\varphi))$$

17.7.25

$$n = 1$$

$$\Pi(1; \varphi \setminus \alpha) = F(\varphi \setminus \alpha) - \sec^2 \alpha E(\varphi \setminus \alpha) + \sec^2 \alpha \tan \varphi \Delta(\varphi)$$

Numerical Methods

17.8. Use and Extension of the Tables

Example 1. Reduce to canonical form $\int y^{-1} dx$, where

$$y^2 = -3x^4 + 34x^3 - 119x^2 + 172x - 90$$

By inspection or by solving an equation of the fourth degree we find that

$$y^2 = Q_1 Q_2 \text{ where } Q_1 = 3x^2 - 10x + 9, Q_2 = -x^2 + 8x - 10$$

First Method

$Q_1 - \lambda Q_2 = (3 + \lambda)x^2 - (10 + 8\lambda)x + 9 + 10\lambda$ is a perfect square if the discriminant

$$(10 + 8\lambda)^2 - 4(3 + \lambda)(9 + 10\lambda) = 0; \text{ i.e., if } \lambda = -\frac{2}{3} \text{ or } \frac{1}{2}$$

and then

$$Q_1 + \frac{2}{3} Q_2 = \frac{7}{3} (x - 1)^2, Q_1 - \frac{1}{2} Q_2 = \frac{7}{2} (x - 2)^2$$

Solving for Q_1 and Q_2 we get

$$Q_1 = (x - 1)^2 + 2(x - 2)^2, Q_2 = 2(x - 1)^2 - 3(x - 2)^2$$

The substitution $t = (x - 1)/(x - 2)$ then gives

$$\int y^{-1} dx = \pm \int [(t^2 + 2)(2t^2 - 3)]^{-\frac{1}{2}} dt$$

*See page II.

If the quartic $y^2=0$ has four real roots in x (or in the case of a cubic all three roots are real), we must so combine the factors that no root of $Q_1=0$ lies between the roots of $Q_2=0$ and no root of $Q_2=0$ lies between the roots of $Q_1=0$. Provided this condition is observed the method just described will always lead to real values of λ . These values may, however, be irrational.

Second Method

Write

$$t^2 = \frac{Q_1}{Q_2} = \frac{3x^2 - 10x + 9}{-x^2 + 8x - 10}$$

and let the discriminant of $Q_2t^2 - Q_1$ be

$$4T^2 = (8t^2 + 10)^2 - 4(t^2 + 3)(10t^2 + 9) \\ = 4(3t^2 + 2)(2t^2 - 1)$$

Then

$$\int y^{-1} dx = \pm \int T^{-1} dt = \pm \int [(3t^2 + 2)(2t^2 - 1)]^{-1/2} dt$$

This method will succeed if, as here, T^2 as a function of t^2 has real factors. If the coefficients of the given quartic are rational numbers, the factors of T^2 will likewise be rational.

Third Method

Write

$$w = \frac{Q_1}{Q_2} = \frac{3x^2 - 10x + 9}{-x^2 + 8x - 10}$$

and let the discriminant of $Q_2w - Q_1$ be

$$4W = 4(3w + 2)(2w - 1) = 4(Aw^2 + Bw + C)$$

Then if

$$z^2 = W/w \text{ and } Z^2 = (B - z^2)^2 - 4AC = (z^2 - 1)^2 + 48$$

$$\int y^{-1} dx = \pm \int Z^{-1} dz$$

However, in this case the factors of Z are complex and the method fails.

Of the second and third methods one will always succeed where the other fails, and if the coefficients of the given quartic are rational numbers, the factors of T^2 or Z^2 , as the case may be, will be rational.

Example 2. Reduce to canonical form $\int y^{-1} dx$ where $y^2 = x(x-1)(x-2)$.

We use the third method of **Example 1** taking $Q_1 = (x-1)$, $Q_2 = x(x-2)$ and writing

$$w = \frac{Q_1}{Q_2} = \frac{x-1}{x^2-2x}$$

The discriminant of $Q_2w - Q_1 = x^2w - (2w+1)x + 1$ is

$$4W = (2w+1)^2 - 4w = 4w^2 + 1$$

so that

$$W = Aw^2 + Bw + C \text{ where } A=1, B=0, C=\frac{1}{4}$$

and if we write $z^2 = W/w$ and

$$Z^2 = (B - z^2)^2 - 4AC = (z^2)^2 - 1 = (z^2 - 1)(z^2 + 1),$$

$$\int y^{-1} dx = \pm \int [(z^2 - 1)(z^2 + 1)]^{-1/2} dz$$

The first method of **Example 1** fails with the above values of Q_1 and Q_2 since the root of $Q_1=0$ lies between the roots of $Q_2=0$, and we get imaginary values of λ . The method succeeds, however, if we take $Q_1 = x$, $Q_2 = (x-1)(x-2)$, for then the roots of $Q_1=0$ do not lie between those of $Q_2=0$.

Example 3. Find $K(80/81)$.

First Method

Use **17.3.29** with $m=80/81$, $m_1=1/81$, $m_1^{1/2}=1/9$. Since $[(1 - m_1^{1/2})(1 + m_1^{1/2})^{-1}]^2 = .64$, $K(80/81) = 1.8 K(.64) = 3.59154 500$ to 8D, taking $K(.64)$ from **Table 17.1**.

Second Method

Table 17.4 giving $L(m)$ is useful for computing $K(m)$ when m is near unity or $K'(m)$ when m is near zero.

$$K(80/81) = \frac{1}{\pi} K'(80/81) \ln(16 \times 81) - L(80/81).$$

By interpolation in **Tables 17.1** and **17.4**, since $80/81 = .98765 43210$,

$$K'(80/81) = 1.57567 8423$$

$$L(80/81) = .00311 16543$$

$$K(80/81) = \pi^{-1}(1.57567 8423)(7.16703 7877)$$

$$= .00311 16543$$

$$= 3.59154 5000 \text{ to } 9D.$$

Third Method

The polynomial approximation **17.3.34** gives to 8D

$$K(80/81) = 3.59154 501$$

Fourth Method, Arithmetic-Geometric Mean

Here $\sin^2 \alpha = 80/81$ and we start with

$$a_0 = 1, b_0 = \frac{1}{9}, c_0 = \sqrt{80/81} = .99380 79900$$

giving

n	a_n	b_n	c_n
0	1.00000 00000	.11111 11111	.99380 79900
1	.55555 55555	.33333 33333	.44444 44444
2	.44444 44444	.43033 14829	.11111 11111
3	.43738 79636	.43733 10380	.00705 64808
4	.43735 95008	.43735 94999	.00002 84628
5	.43735 95003	.43735 95003	0

Thus $K(80/81) = \frac{1}{2} \pi a_5^{-1} = 3.59154 5001$.

Example 4. Find $E(80/81)$.

First Method

Use 17.3.30 which gives, with $m=80/81$

$$E(80/81) = \frac{10}{9} E(.64) - \frac{1}{5} K(.64) = 1.01910 6047$$

taking $E(.64)$ and $K(.64)$ from Table 17.1.

Second Method

Polynomial approximation, 17.3.36 gives $E(80/81) = 1.01910 6060$. The last two figures must be dropped to keep within the limit of accuracy of the method.

Third Method

Arithmetic-geometric mean, 17.6. The numbers were calculated in Example 3, fourth method, and we have

$$\frac{K(80/81) - E(80/81)}{K(80/81)} = \frac{1}{2} [c_0^2 + 2c_1^2 + 2^2c_2^2 + \dots + 2^5c_5^2] = \frac{1}{2} [1.43249 71298] = .71624 85649.$$

Using the value of $K(80/81)$ found in Example 3, fourth method, we have

$$E(80/81) = 1.01910 6048 \text{ to } 9D.$$

Example 5. Find q when $m = .9995$.

Here $m_1 = .0005$ and so from Table 17.4

$$Q(m) = .06251 563013$$

$$q_1 = m_1 Q(m) = .00003 12578 15.$$

From 17.3.19

$$\ln\left(\frac{1}{q}\right) = \pi^2 / \ln\left(\frac{1}{q_1}\right) = \pi^2 / 10.37324 1132 = .95144 84701$$

$$q = .38618 125.$$

The computation could also be made using common logarithms with the aid of 17.3.20. The point of this procedure is that it enables us to calculate q_1 without the loss of significant figures which would result from direct interpolation in Table 17.1. By this means $\ln(1/q_1)$ can be found without loss of accuracy.

Example 6. Find m to 10D when $K'/K = .25$ and when $K'/K = 3.5$.

From 17.3.15 with $K'/K = .25$ we can write the iteration formula

$$m^{(n+1)} = 1 - 16e^{-4\pi} \exp[-\pi L(m^{(n)})/K'(m^{(n)})].$$

Then by iteration using Tables 17.1 and 17.4

n	$m^{(n)}$
0	1.
1	.99994 42025
2	.99994 42041
3	.99994 42041

Thus $m = .99994 42041$.

From 17.3.16 with $K'/K = 3.5$ we can write the iteration formula,

$$m^{(n+1)} = 16e^{-3.5\pi} \exp[-\pi L(m_1^{(n)})/K(m^{(n)})]$$

n	$m^{(n)}$
0	0
1	.(3)26841 25043
2	.(3)26837 65
3	.(3)26837 65

Thus $m = .00026 83765$.

The above methods in conjunction with the auxiliary Table 17.4 of $L(m)$ enable us to extend Table 17.3 for $K'/K > 3$, and for $K'/K < .3$.

Example 7. Calculate to 5D the Jacobian elliptic function $\text{sn}(.75342|.7)$ using Table 17.5.

Here

$$m = \sin^2 \alpha = .7, \alpha = 56.789089^\circ.$$

Thus, $\text{sn}(.75342|.7) = \sin \varphi$ where φ is determined from

$$F(\varphi \setminus 56.789089^\circ) = .75342.$$

Inspection of Table 17.5 shows that φ lies between 40° and 45° . We have from the table of $F(\varphi \setminus \alpha)$

$\alpha \backslash \varphi$	56°	58°	60°
35°	.63803	.63945	.64085
40°	.73914	.74138	.74358
45°	.84450	.84788	.85122
50°	.95479	.95974	.96465

From this we form the table of $F(\varphi \setminus 56.789089^\circ)$

φ	F	Δ	Δ_2	Δ_3
35°	.63859	10144		
40°	.74003	10581	437	
45°	.84584	11090	509	72
50°	.95674			

A rough estimate now shows that φ lies between 40° and 41°. We therefore form the following table of $F(\varphi \setminus 56.789089^\circ)$ by direct interpolation in the foregoing table

φ	F
40.0°	.74003
40.5°	.75040
41.0°	.76082

whence by linear inverse interpolation

$$\varphi = 40.5^\circ + .5^\circ \left[\frac{.75342 - .75040}{.76082 - .75040} \right] = 40.6449^\circ$$

and so $\sin \varphi = .65137 = \text{sn}(.75342 | .7)$.

This method of bivariate interpolation is given merely as an illustration. Other more direct methods such as that of the arithmetic-geometric mean described in 17.6 and illustrated for the Jacobian functions in chapter 16 are less laborious.

Example 8. Evaluate

$$\int_2^3 [(2t^2+1)(t^2-2)]^{-1/2} dt.$$

First Method, Bivariate Interpolation

From 17.4.50 we have

$$\sqrt{5} \int_2^3 [(2t^2+1)(t^2-2)]^{-1/2} dt = F(\varphi_1 \setminus \alpha) - F(\varphi_2 \setminus \alpha),$$

where

$$\sin^2 \alpha = \frac{1}{5}, \cos \varphi_1 = \frac{\sqrt{2}}{3}, \cos \varphi_2 = \frac{\sqrt{2}}{2}$$

Thus $\alpha = 26.56505 12^\circ$, $\varphi_1 = 61.87449 43^\circ$, $\varphi_2 = 45^\circ$, $F(\varphi_1 \setminus \alpha) = 1.115921$ and $F(\varphi_2 \setminus \alpha) = .800380$ and therefore the integral is equal to .141114.

Second Method, Numerical Quadrature

Simpson's formula with 11 ordinates and interval .1 gives .141117.

Example 9. Evaluate

$$\int_2^4 [(t^2-2)(t^2-4)]^{-1/2} dt.$$

First Method, Reduction to Standard Form and Bivariate Interpolation

Here we can use 17.4.48 noting that $a^2=4$, $b^2=2$, and that

$$\begin{aligned} \int_2^4 [(t^2-2)(t^2-4)]^{-1/2} dt &= \int_2^\infty - \int_4^\infty \\ &= \frac{1}{2} [F(\varphi_1 \setminus 45^\circ) - F(\varphi_2 \setminus 45^\circ)] \\ &= \frac{1}{2} [1.854075 - .535623] = .659226 \end{aligned}$$

where

$$\sin \varphi_1 = \frac{2}{2}, \sin \varphi_2 = \frac{2}{4}, \sin^2 \alpha = \frac{2}{4}$$

Thus

$$\alpha = 45^\circ, \varphi_1 = 90^\circ, \varphi_2 = 30^\circ.$$

Second Method, Numerical Integration

If we wish to use numerical integration we must observe that the integrand has a singularity at $t=2$ where it behaves like $[8(t-2)]^{-1/2}$.

We remove the singularity at $t=2$, by writing

$$\int_2^4 [(t^2-2)(t^2-4)]^{-1/2} dt = \int_2^4 f(t) dt + \int_2^4 [8(t-2)]^{-1/2} dt$$

where

$$f(t) = [(t^2-2)(t^2-4)]^{-1/2} - [8(t-2)]^{-1/2}.$$

If we define $f(2) = 0$,

$$\int_2^4 f(t) dt$$

can be calculated by numerical quadrature. Also

$$\int_2^4 [8(t-2)]^{-1/2} dt = \left[\frac{1}{\sqrt{2}} (t-2)^{1/2} \right]_2^4 = 1$$

and thus we calculate the integral as

$$1 + \int_2^4 f(t) dt = 1 - .340773 = .659227.$$

Example 10. Evaluate

$$u = \int_{17}^\infty (x^3 - 7x + 6)^{-1/2} dx.$$

$x^3 - 7x + 6 = (x-1)(x-2)(x+3)$ and we use 17.4.65 with $\beta_1=2$, $\beta_2=1$, $\beta_3=-3$,

$$m = \sin^2 \alpha = 4/5, \lambda = \sqrt{5}/2, \cos^2 \varphi = 3/4.$$

Thus $\alpha = 63.434949^\circ$, $\varphi = 30^\circ$ and

$$u = 2(5)^{-1/2} F(30^\circ \backslash 63.434949^\circ) = 2(5)^{-1/2} (.543604) = .486214 \text{ from Table 17.5.}$$

The above integral is of the Weierstrass type and in fact $17 = \mathcal{P}(\frac{1}{2}u; 28, -24)$ (see chapter 18).

Example 11. Evaluate

$$\int_0^{2/3} (24 - 12t + 2t^2 - t^3)^{-1/2} dt.$$

We have

$$24 - 12t + 2t^2 - t^3 = -(t-2)(t^2 + 12) = -P(t).$$

There is only one real zero and we therefore use 17.4.74 with $P(t) = t^3 - 2t^2 + 12t - 24$, $\beta = 2$ so that $P'(2) = 16$, $P''(2) = 8$, $\lambda = 2$ and therefore

$$m = \sin^2 \alpha = \frac{1}{4}, \quad \alpha = 30^\circ$$

Therefore the given integral is

$$\int_0^2 - \int_{2/3}^2 = \frac{1}{2} [F(\varphi_1 \backslash 60^\circ) - F(\varphi_2 \backslash 60^\circ)]$$

where

$$\cos \varphi_1 = \frac{1}{3}, \quad \varphi_1 = 70.52877 \ 93^\circ$$

$$\cos \varphi_2 = \frac{1}{2}, \quad \varphi_2 = 60^\circ$$

and the integral $= \frac{1}{2} [1.510344 - 1.212597] = .148874$.

Example 12. Use Landen's transformation to evaluate

$$\int_0^{\pi/2} \left(1 - \frac{1}{4} \sin^2 \theta\right)^{-1/2} d\theta \text{ to 5D.}$$

First Method, Descending Transformation

We use 17.5.1 to give

$$1 + \sin \alpha_1 = \frac{2}{1 + \cos 30^\circ} = 1.071797$$

$$\cos \alpha_1 = [(1 - \sin \alpha_1)(1 + \sin \alpha_1)]^{1/2} = .997419$$

$$1 + \sin \alpha_2 = \frac{2}{1 + \cos \alpha_1} = 1.001292; \cos \alpha_2 = .999999$$

$$1 + \sin \alpha_3 = \frac{2}{1 + \cos \alpha_2} = 1.000000$$

Thus from 17.5.7,

$$\begin{aligned} \text{the integral} &= F(90^\circ \backslash 30^\circ) = \frac{\pi}{2} (1.071797)(1.001292) \\ &= 1.68575 \text{ to 5D.} \end{aligned}$$

Second Method, Ascending Transformation

We use 17.5.11 to give

$$1 + \cos \alpha_{n+1} = 2/(1 + \sin \alpha_n)$$

n	$\cos \alpha_n$	$\sin \alpha_n$
1	.33333 333	.94280 904
2	.02943 725	.99956 663
3	.00021 673	.99999 998

$$\begin{aligned} \sin (2\varphi_1 - 90^\circ) &= \sin 30^\circ, & \varphi_1 &= 60^\circ \\ \sin (2\varphi_2 - \varphi_1) &= \sin \alpha_1 \sin \varphi_1, & \varphi_2 &= 57.367805^\circ \\ \sin (2\varphi_3 - \varphi_2) &= \sin \alpha_2 \sin \varphi_2, & \varphi_3 &= 57.348426^\circ \\ \sin (2\varphi_4 - \varphi_3) &= \sin \alpha_3 \sin \varphi_3, & \varphi_4 &= 57.348425^\circ = \Phi. \end{aligned}$$

From 17.5.16

$$\begin{aligned} F(90^\circ \backslash 30^\circ) &= \frac{2}{1.5} \frac{2}{1.94280 \ 904} \frac{2}{1.99956 \ 663} \\ &= \frac{2}{1.99999 \ 998} \ln \tan \left(45^\circ + \frac{1}{2} \Phi\right) \\ &= 1.37288 \ 050 \ln \tan 73.674213^\circ \\ &= 1.37288 \ 050 (1.22789 \ 30) \end{aligned}$$

$$F(90^\circ \backslash 30^\circ) = 1.68575 \text{ to 5D.}$$

Example 13. Find the value of $F(89.5^\circ \backslash 89.5^\circ)$.

First Method

This is a case where interpolation in Table 17.5 is not possible. We use 17.4.13 which gives

$$F(89.5^\circ \backslash 89.5^\circ) = F(90^\circ \backslash 89.5^\circ) - F(\psi \backslash 89.5^\circ)$$

where

$$\cot \psi = \sin (.5^\circ) \cot (.5^\circ) = \cos (.5^\circ)$$

$$\psi = 45.00109 \ 084^\circ$$

and $F(\psi \backslash 89.5^\circ) = .881390$ from Table 17.5.

$$\begin{aligned} F(90^\circ \backslash 89.5^\circ) &= K(\sin^2 89.5^\circ) = K(.99992 \ 38476) \\ &= 6.12777 \ 88 \end{aligned}$$

$$\text{Thus } F(89.5^\circ \backslash 89.5^\circ) = 5.246389.$$

Second Method

Landen's ascending transformation, 17.5.11, gives

$$\begin{aligned} \cos \alpha_1 &= (1 - \sin 89.5^\circ) / (1 + \sin 89.5^\circ) \\ \sin \alpha_1 &= [(1 - \cos \alpha_1)(1 + \cos \alpha_1)]^{\frac{1}{2}} = .99999 \ 99997 \\ \cos \alpha_2 &= 0 \\ \sin \alpha_2 &= 1. \end{aligned}$$

17.5.12 then gives

$$\begin{aligned} \sin (2\varphi_1 - 89.5^\circ) &= \sin 89.5^\circ \sin 89.5^\circ \\ &= .99992 \ 38476 \end{aligned}$$

$$2\varphi_1 - 89.5^\circ = 89.2929049^\circ, \varphi_1 = 89.39645 \ 245^\circ$$

$$\begin{aligned} \sin (2\varphi_2 - \varphi_1) &= \sin \alpha_1 \sin \varphi_1, \quad \varphi_2 = 89.39645 \ 602^\circ \\ \sin (2\varphi_3 - \varphi_2) &= \sin \varphi_2, \quad \varphi_3 = \varphi_2 = \Phi. \end{aligned}$$

Thus 17.5.16 gives

$$F(89.5^\circ \setminus 89.5^\circ) =$$

$$\left(\frac{1}{.99996 \ 19231} \right)^{\frac{1}{2}} \ln (\tan 89.69822 \ 801^\circ) = 5.24640.$$

Example 14. Evaluate

$$\int_1^2 [(9-t^2)(16+t^2)^3]^{-\frac{1}{2}} dt \text{ to 5D.}$$

From 17.4.51 the given integral

$$= \int_0^2 - \int_0^1 = \frac{1}{80} [E(\varphi_1 \setminus \alpha) - E(\varphi_2 \setminus \alpha)]$$

where

$$\sin \alpha = \frac{3}{5}, \quad \alpha = 36.86990^\circ$$

$$\sin \varphi_1 = \frac{1}{3} \sqrt{5}, \quad \varphi_1 = 48.18968^\circ$$

$$\sin \varphi_2 = \frac{5}{3\sqrt{17}}, \quad \varphi_2 = 23.84264^\circ.$$

By bivariate interpolation in Table 17.6 we find that the given integral

$$= \frac{1}{80} [.80904 - .41192] = .00496.$$

Simpson's rule with 3 ordinates gives

$$\frac{1}{8} [.00504 + .01975 + .005] = .00496.$$

Example 15. Evaluate

$$\Pi \left(\frac{1}{16}; 45^\circ \setminus 30^\circ \right) =$$

$$\int_0^{\pi/4} (1 - \frac{1}{16} \sin^2 \theta)^{-1} (1 - \frac{1}{4} \sin^2 \theta)^{-\frac{1}{2}} d\theta \text{ to 6D.}$$

This is case (i) of integrals of the third kind, $0 < n < \sin^2 \alpha$, 17.7.3

$$n = \frac{1}{16}, \varphi = 45^\circ, \alpha = 30^\circ,$$

$$\epsilon = \arcsin (n / \sin^2 \alpha)^{\frac{1}{2}} = 30^\circ,$$

$$\beta = \frac{1}{2} \pi F(30^\circ \setminus 30^\circ) / K(30^\circ) = .49332 \ 60$$

$$v = \frac{1}{2} \pi F(45^\circ \setminus 30^\circ) / K(30^\circ) = .74951 \ 51,$$

$$\delta_1 = (16/45)^{\frac{1}{2}}$$

and so from 17.7.3

$$\Pi \left(\frac{1}{16}; 45^\circ \setminus 30^\circ \right) =$$

$$(16/45)^{\frac{1}{2}} \left\{ -\frac{1}{2} \ln \frac{\vartheta_4(v+\beta)}{\vartheta_4(v-\beta)} + \frac{\vartheta_1'(\beta)}{\vartheta_1(\beta)} v \right\}$$

$$q = .01797 \ 24.$$

Using the q -series, 16.27, for the ϑ functions we get

$$\begin{aligned} \Pi \left(\frac{1}{16}; 45^\circ \setminus 30^\circ \right) &= (16/45)^{\frac{1}{2}} \{ -.02995 \ 89 \\ &\quad + (1.86096 \ 21)(.74951 \ 51) \} = .813845. \end{aligned}$$

Table 17.9 gives .81385 with 4 point Lagrangian interpolation.

Example 16. Evaluate the complete elliptic integral

$$\Pi \left(\frac{1}{8} \setminus 30^\circ \right) \text{ to 6D.}$$

From 17.7.6 we have

$$\Pi \left(\frac{1}{8} \setminus 30^\circ \right) = K(30^\circ) + (16/45)^{1/2} K(\alpha) Z(\epsilon \setminus 30^\circ)$$

where $\epsilon = \arcsin (n / \sin^2 \alpha)^{\frac{1}{2}} = 30^\circ$. Thus using Table 17.7

$$\Pi \left(\frac{1}{8} \setminus 30^\circ \right) = 1.743055.$$

Table 17.9 gives 1.74302 with 5 point Lagrangian interpolation.

Example 17. Evaluate

$$\Pi \left(\frac{5}{8}; 45^\circ \setminus 30^\circ \right)$$

$$= \int_0^{\pi/4} (1 - \frac{5}{8} \sin^2 \theta)^{-1} (1 - \frac{1}{4} \sin^2 \theta)^{-1/2} d\theta$$

to 6D.

This is case (iii) of integrals of the third kind, $\sin^2 \alpha < n < 1$,

$$n = \frac{5}{8}, \varphi = 45^\circ, \alpha = 30^\circ$$

$$\epsilon = \arcsin [(1-n)/\cos^2 \alpha]^{1/2} = 45^\circ$$

$$\beta = \frac{1}{2}\pi F(45^\circ \setminus 60^\circ)/K(30^\circ) = .79317\ 74$$

$$v = \frac{1}{2}\pi F(45^\circ \setminus 30^\circ)/K(30^\circ) = .74951\ 51$$

$$\delta_2 = (40/9)^{1/2}$$

$$q = .01797\ 24$$

and so from 17.7.11

$$\begin{aligned} \Pi\left(\frac{5}{8}; 45^\circ \setminus 30^\circ\right) &= (40/9)^{1/2}(\lambda - 4\mu v) \\ &= 2.10818\ 51\{.55248\ 32 - 4(.03854\ 26) \\ &\quad (.74951\ 51)\} = .921129. \end{aligned}$$

Table 17.9 gives .92113 with 4 point Lagrangian interpolation.

Example 18. Evaluate the complete elliptic integral

$$\Pi\left(\frac{5}{8} \setminus 30^\circ\right) \text{ to } 5D.$$

From 17.7.14 we have

$$\Pi\left(\frac{5}{8} \setminus 30^\circ\right) = K(30^\circ) + \frac{\pi}{2} \sqrt{\frac{40}{9}} [1 - \Lambda_0(\epsilon \setminus 30^\circ)]$$

where $\epsilon = \arcsin [(1-n)/\cos^2 \alpha]^{1/2} = 45^\circ$. Thus using **Table 17.8**

$$\Pi\left(\frac{5}{8} \setminus 30^\circ\right) = 2.80099.$$

Table 17.9 gives 2.80126 by 6 point Lagrangian interpolation. The discrepancy results from interpolation with respect to n for $\varphi = 90^\circ$ in **Table 17.9**.

Example 19. Evaluate

$$\begin{aligned} \Pi\left(\frac{5}{4}; 45^\circ \setminus 30^\circ\right) \\ = \int_0^{\pi/4} (1 - \frac{5}{4} \sin^2 \theta)^{-1} (1 - \frac{1}{4} \sin^2 \theta)^{-1/2} d\theta \end{aligned}$$

to 5D.

Here $n = \frac{5}{4}$, $\varphi = 45^\circ$, $\alpha = 30^\circ$ and since the characteristic is greater than unity we use 17.7.7

$$N = n^{-1} \sin^2 \alpha = .2, \quad p_1 = (1/5)^{1/2}$$

$$\begin{aligned} \Pi\left(\frac{5}{4}; 45^\circ \setminus 30^\circ\right) &= -\Pi(2; 45^\circ \setminus 30^\circ) + F(45^\circ \setminus 30^\circ) \\ &\quad + (\frac{1}{2}\sqrt{5}) \ln \frac{(7/8)^{1/2} + (1/5)^{1/2}}{(7/8)^{1/2} - (1/5)^{1/2}} \end{aligned}$$

$$= -.83612 + .80437$$

$$+ \frac{1}{2}\sqrt{5} \ln \frac{\sqrt{35} + \sqrt{8}}{\sqrt{35} - \sqrt{8}}$$

$$= 1.13214.$$

Numerical quadrature gives the same result.

Example 20. Evaluate

$$\begin{aligned} \Pi\left(-\frac{1}{4}; 45^\circ \setminus 30^\circ\right) \\ = \int_0^{\pi/4} (1 + \frac{1}{4} \sin^2 \theta)^{-1} (1 - \frac{1}{4} \sin^2 \theta)^{-1/2} d\theta \end{aligned}$$

to 5D.

Here the characteristic is negative and we therefore use 17.7.15 with $n = -\frac{1}{4}$, $\sin^2 \alpha = \frac{1}{4}$

$$N = (1-n)^{-1}(\sin^2 \alpha - n) = .4, \quad p_2 = \sqrt{.1}$$

and therefore

$$\begin{aligned} (5/2)^{1/2} \Pi\left(-\frac{1}{4}; 45^\circ \setminus 30^\circ\right) &= (9/40)^{1/2} \Pi\left(\frac{5}{8}; 45^\circ \setminus 30^\circ\right) \\ &\quad + \frac{1}{2}(5/2)^{1/2} F(45^\circ \setminus 30^\circ) + \arctan (35)^{-1/2} \end{aligned}$$

Using **Tables 4.14, 17.5, and 17.9** we get

$$\Pi\left(-\frac{1}{4}; 45^\circ \setminus 30^\circ\right) = .76987$$

References

Texts

- [17.1] A. Cayley, An elementary treatise on elliptic functions (Dover Publications, Inc., New York, N.Y., 1956).
- [17.2] A. Erdélyi et al., Higher transcendental functions, vol. 2, ch. 23 (McGraw-Hill Book Co., Inc., New York, N.Y., 1953).
- [17.3] L. V. King, On the direct numerical calculation of elliptic functions and integrals (Cambridge Univ. Press, Cambridge, England, 1924).
- [17.4] E. H. Neville, Jacobian elliptic functions, 2d ed. (Oxford Univ. Press, London, England, 1951).
- [17.5] F. Oberhettinger and W. Magnus, Anwendung der elliptischen Funktionen in Physik und Technik (Springer-Verlag, Berlin, Germany, 1949).

- [17.6] F. Tricomi, Elliptische Funktionen (Akademische Verlagsgesellschaft, Leipzig, Germany, 1948).
- [17.7] E. T. Whittaker and G. N. Watson, A course of modern analysis, chs. 20, 21, 22, 4th ed. (Cambridge Univ. Press, Cambridge, England, 1952).

Tables

- [17.8] P. F. Byrd and M. D. Friedman, Handbook of elliptic integrals for engineers and physicists (Springer-Verlag, Berlin, Germany, 1954).
- [17.9] C. Heuman, Tables of complete elliptic integrals, J. Math. Phys. 20, 127-206 (1941).
- [17.10] J. Hoüel, Recueil de formules et de tables numériques (Gauthier-Villars, Paris, France, 1901).

- [17.11] E. Jahnke and F. Emde, *Tables of functions*, 4th ed. (Dover Publications, Inc., New York, N.Y., 1945).
- [17.12] L. M. Milne-Thomson, *Jacobian elliptic function tables* (Dover Publications, Inc., New York, N.Y., 1956).
- [17.13] L. M. Milne-Thomson, Ten-figure table of the complete elliptic integrals K , K' , E , E' and a table of $\frac{1}{\vartheta_2^2(0|\tau)}$, $\frac{1}{\vartheta_3^{2n}(0|\tau)}$, *Proc. London Math. Soc.* **2**, 33 (1931).
- [17.14] L. M. Milne-Thomson, The Zeta function of Jacobi, *Proc. Roy. Soc. Edinburgh* **52** (1931).
- [17.15] L. M. Milne-Thomson, *Die elliptischen Funktionen von Jacobi* (Julius Springer, Berlin, Germany, 1931).
- [17.16] K. Pearson, *Tables of the complete and incomplete elliptic integrals* (Cambridge Univ. Press, Cambridge, England, 1934).
- [17.17] G. W. and R. M. Spenceley, *Smithsonian elliptic function tables*, *Smithsonian Miscellaneous Collection*, vol. 109 (Washington, D.C., 1947).

Table 17.1 COMPLETE ELLIPTIC INTEGRALS OF THE FIRST AND SECOND KINDS AND THE NOME q WITH ARGUMENT THE PARAMETER m

$$K(m) = \int_0^{\frac{\pi}{2}} (1 - m \sin^2 \theta)^{-\frac{1}{2}} d\theta \quad K'(m) = K(m_1)$$

$$E(m) = \int_0^{\frac{\pi}{2}} (1 - m \sin^2 \theta)^{\frac{1}{2}} d\theta \quad E'(m) = E(m_1)$$

$$q(m) = \exp[-\pi K'(m)/K(m)] \quad q_1(m) = q(m_1)$$

m	$K(m)$	$K'(m)$	$q(m)$	m_1
0.00	1.57079 63267 94897	∞	0.00000 00000 00000	1.00
0.01	1.57474 55615 17356	3.69563 73629 89875	0.00062 81456 60383	0.99
0.02	1.57873 99120 07773	3.35414 14456 99160	0.00126 26665 23204	0.98
0.03	1.58278 03424 06373	3.15587 49478 91841	0.00190 36912 69025	0.97
0.04	1.58686 78474 54166	3.01611 24924 77648	0.00255 13525 13689	0.96
0.05	1.59100 34537 90792	2.90833 72484 44552	0.00320 57869 70686	0.95
0.06	1.59518 82213 21610	2.82075 24967 55872	0.00386 71356 22010	0.94
0.07	1.59942 32446 58510	2.74707 30040 24667	0.00453 55438 98018	0.93
0.08	1.60370 96546 39253	2.68355 14063 15229	0.00521 11618 66885	0.92
0.09	1.60804 86199 30513	2.62777 33320 84344	0.00589 41444 34269	0.91
0.10	1.61244 13487 20219	2.57809 21133 48173	0.00658 46515 53858	0.90
0.11	1.61688 90905 05203	2.53333 45460 02200	0.00728 28484 49518	0.89
0.12	1.62139 31379 80658	2.49263 53232 39716	0.00798 89058 49815	0.88
0.13	1.62595 48290 38433	2.45533 80283 21380	0.00870 30002 35762	0.87
0.14	1.63057 55488 81754	2.42093 29603 44303	0.00942 53141 02678	0.86
0.15	1.63525 67322 64580	2.38901 64863 25580	0.01015 60362 37153	0.85
0.16	1.63999 98658 64511	2.35926 35547 45007	0.01089 53620 10173	0.84
0.17	1.64480 64907 98881	2.33140 85677 50251	0.01164 34936 87540	0.83
0.18	1.64967 82052 94514	2.30523 17368 77189	0.01240 06407 58856	0.82
0.19	1.65461 66675 22527	2.28054 91384 22770	0.01316 70202 86392	0.81
0.20	1.65962 35986 10528	2.25720 53268 20854	0.01394 28572 75318	0.80
0.21	1.66470 07858 45692	2.23506 77552 60349	0.01472 83850 66891	0.79
0.22	1.66985 00860 83368	2.21402 24978 46332	0.01552 38457 56320	0.78
0.23	1.67507 34293 77219	2.19397 09253 19189	0.01632 94906 37206	0.77
0.24	1.68037 28228 48361	2.17482 70902 46414	0.01714 55806 74605	0.76
0.25	1.68575 03548 12596	2.15651 56474 99643	0.01797 23870 08967	0.75
0.26	1.69120 81991 86631	2.13897 01837 52114	0.01881 01914 93399	0.74
0.27	1.69674 86201 96168	2.12213 18631 57396	0.01965 92872 66940	0.73
0.28	1.70237 39774 10990	2.10594 83200 52758	0.02051 99793 66788	0.72
0.29	1.70808 67311 34606	2.09037 27465 52360	0.02139 25853 82708	0.71
0.30	1.71388 94481 78791	2.07536 31352 92469	0.02227 74361 57154	0.70
0.31	1.71978 48080 56405	2.06088 16467 30131	0.02317 48765 35013	0.69
0.32	1.72577 56096 29320	2.04689 40772 10577	0.02408 52661 67250	0.68
0.33	1.73186 47782 52098	2.03336 94091 52233	0.02500 89803 73177	0.67
0.34	1.73805 53734 56358	2.02027 94286 03592	0.02594 64110 66576	0.66
0.35	1.74435 05972 25613	2.00759 83984 24376	0.02689 79677 51443	0.65
0.36	1.75075 38029 15753	1.99530 27776 64729	0.02786 40785 93729	0.64
0.37	1.75726 85048 82456	1.98337 09795 27821	0.02884 51915 76181	0.63
0.38	1.76389 83888 83731	1.97178 31617 25656	0.02984 17757 44138	0.62
0.39	1.77064 73233 33534	1.96052 10441 65830	0.03085 43225 51033	0.61
0.40	1.77751 93714 91253	1.94956 77498 06026	0.03188 33473 13363	0.60
0.41	1.78451 88046 81873	1.93890 76652 34220	0.03292 93907 86003	0.59
0.42	1.79165 01166 52966	1.92852 63181 14418	0.03399 30208 70043	0.58
0.43	1.79891 80391 87685	1.91841 02691 09912	0.03507 48344 66773	0.57
0.44	1.80632 75591 07699	1.90854 70162 81211	0.03617 54594 93133	0.56
0.45	1.81388 39368 16983	1.89892 49102 71554	0.03729 55570 75822	0.55
0.46	1.82159 27265 56821	1.88953 30788 53096	0.03843 58239 43468	0.54
0.47	1.82945 97985 64730	1.88036 13596 22178	0.03959 69950 38753	0.53
0.48	1.83749 13633 55796	1.87140 02398 11034	0.04077 98463 75263	0.52
0.49	1.84569 39983 74724	1.86264 08023 32739	0.04198 51981 67183	0.51
0.50	1.85407 46773 01372	1.85407 46773 01372	0.04321 39182 63772	0.50
m_1	$K'(m)$	$K(m)$	$q_1(m)$	m
	$\left[\begin{smallmatrix} (-5)2 \\ 11 \end{smallmatrix} \right]$		$\left[\begin{smallmatrix} (-6)3 \\ 9 \end{smallmatrix} \right]$	

See Examples 3-4.

$E(m)$ and $E'(m)$ from L. M. Milne-Thomson, Ten-figure table of the complete elliptic integrals

K, K', E, E' and a table of $\frac{1}{\vartheta_3^2(0|\tau)}, \frac{1}{\vartheta_3^{2'}(0|\tau)}$, Proc. London Math. Soc.(2)33, 1931(with permission).

COMPLETE ELLIPTIC INTEGRALS OF THE FIRST AND SECOND KINDS AND THE NOME q WITH ARGUMENT THE PARAMETER m Table 17.1

$$K(m) = \int_0^{\frac{\pi}{2}} (1 - m \sin^2 \theta)^{-\frac{1}{2}} d\theta \quad K'(m) = K(m_1)$$

$$E(m) = \int_0^{\frac{\pi}{2}} (1 - m \sin^2 \theta)^{\frac{1}{2}} d\theta \quad E'(m) = E(m_1)$$

$$q(m) = \exp \left[-\pi K'(m) / K(m) \right] \quad q_1(m) = q(m_1)$$

m	$q_1(m)$			$E(m)$		$E'(m)$		m_1
0.00	1.00000	00000	00000	1.57079	6327	1.00000	0000	1.00
0.01	0.26219	62679	17709	1.56686	1942	1.01599	3546	0.99
0.02	0.22793	45740	67492	1.56291	2645	1.02859	4520	0.98
0.03	0.20687	98108	47842	1.55894	8244	1.03994	6861	0.97
0.04	0.19149	63082	09940	1.55496	8546	1.05050	2227	0.96
0.05	0.17931	60069	55723	1.55097	3352	1.06047	3728	0.95
0.06	0.16920	75311	46133	1.54696	2456	1.06998	6130	0.94
0.07	0.16055	42010	73011	1.54293	5653	1.07912	1407	0.93
0.08	0.15298	14810	09741	1.53889	2730	1.08793	7503	0.92
0.09	0.14624	42694	73236	1.53483	3465	1.09647	7517	0.91
0.10	0.14017	31269	54262	1.53075	7637	1.10477	4733	0.90
0.11	0.13464	58847	92091	1.52666	5017	1.11285	5607	0.89
0.12	0.12957	14695	20553	1.52255	5369	1.12074	1661	0.88
0.13	0.12488	01223	52049	1.51842	8454	1.12845	0735	0.87
0.14	0.12051	71957	28729	1.51428	4027	1.13599	7843	0.86
0.15	0.11643	90607	17472	1.51012	1831	1.14339	5792	0.85
0.16	0.11261	03164	23363	1.50594	1612	1.15065	5629	0.84
0.17	0.10900	18330	23834	1.50174	3101	1.15778	6979	0.83
0.18	0.10558	93457	98477	1.49752	6026	1.16479	8293	0.82
0.19	0.10235	24235	13544	1.49329	0109	1.17169	7053	0.81
0.20	0.09927	36973	38825	1.48903	5058	1.17848	9924	0.80
0.21	0.09633	82749	65990	1.48476	0581	1.18518	2883	0.79
0.22	0.09353	32888	80648	1.48046	6375	1.19178	1311	0.78
0.23	0.09084	75434	60707	1.47615	2126	1.19829	0087	0.77
0.24	0.08827	12359	87862	1.47181	7514	1.20471	3641	0.76
0.25	0.08579	57337	02195	1.46746	2209	1.21105	6028	0.75
0.26	0.08341	33938	83117	1.46308	5873	1.21732	0955	0.74
0.27	0.08111	74173	41165	1.45868	8155	1.22351	1839	0.73
0.28	0.07890	17281	26084	1.45426	8698	1.22963	1828	0.72
0.29	0.07676	08740	04317	1.44982	7128	1.23568	3836	0.71
0.30	0.07468	99435	37179	1.44536	3064	1.24167	0567	0.70
0.31	0.07268	44965	37110	1.44087	6115	1.24759	4538	0.69
0.32	0.07074	05053	87511	1.43636	5871	1.25345	8093	0.68
0.33	0.06885	43052	47167	1.43183	1919	1.25926	3421	0.67
0.34	0.06702	25515	69108	1.42727	3821	1.26501	2576	0.66
0.35	0.06524	21836	78738	1.42269	1133	1.27070	7480	0.65
0.36	0.06351	03934	00746	1.41808	3394	1.27634	9943	0.64
0.37	0.06182	45979	15898	1.41345	0127	1.28194	1668	0.63
0.38	0.06018	24161	79938	1.40879	0839	1.28748	4262	0.62
0.39	0.05858	16483	56838	1.40410	5019	1.29297	9239	0.61
0.40	0.05702	02578	14610	1.39939	2139	1.29842	8034	0.60
0.41	0.05549	63553	09081	1.39465	1652	1.30383	2008	0.59
0.42	0.05400	81850	43499	1.38988	2992	1.30919	2448	0.58
0.43	0.05255	41123	42653	1.38508	5568	1.31451	0576	0.57
0.44	0.05113	26127	21764	1.38025	8774	1.31978	7557	0.56
0.45	0.04974	22621	64574	1.37540	1972	1.32502	4498	0.55
0.46	0.04838	17284	53289	1.37051	4505	1.33022	2453	0.54
0.47	0.04704	97634	16424	1.36559	5691	1.33538	2430	0.53
0.48	0.04574	51959	80149	1.36064	4814	1.34050	5388	0.52
0.49	0.04446	69259	25028	1.35566	1135	1.34559	2245	0.51
0.50	0.04321	39182	63772	1.35064	3881	1.35064	3881	0.50
m_1	$q(m)$			$E'(m)$		$E(m)$		m

$\left[\begin{matrix} (-6)4 \\ 6 \end{matrix} \right]$

Table 17.2 COMPLETE ELLIPTIC INTEGRALS OF THE FIRST AND SECOND KINDS AND THE NOME q WITH ARGUMENT THE MODULAR ANGLE α

$$K(\alpha) = \int_0^{\frac{\pi}{2}} (1 - \sin^2 \alpha \sin^2 \theta)^{-\frac{1}{2}} d\theta \quad K'(\alpha) = K(90^\circ - \alpha)$$

$$E(\alpha) = \int_0^{\frac{\pi}{2}} (1 - \sin^2 \alpha \sin^2 \theta)^{\frac{1}{2}} d\theta \quad E'(\alpha) = E(90^\circ - \alpha)$$

$$q(\alpha) = \exp [-\pi K'(\alpha) / K(\alpha)] \quad q_1(\alpha) = q(90^\circ - \alpha)$$

α	$K(\alpha)$			$K'(\alpha)$			$q(\alpha)$			$90^\circ - \alpha$
0°	1.57079	63267	94897	∞			0.00000	00000	00000	90°
1	1.57091	59581	27243	5.43490	98296	25564	0.00001	90395	55387	89
2	1.57127	49523	72225	4.74271	72652	78886	0.00007	61698	24680	88
3	1.57187	36105	14009	4.33865	39759	99725	0.00017	14256	42257	87
4	1.57271	24349	95227	4.05275	81695	49437	0.00030	48651	48814	86
5	1.57379	21309	24768	3.83174	19997	84146	0.00047	65699	16867	85
6	1.57511	36077	77251	3.65185	59694	78752	0.00068	66451	27305	84
7	1.57667	79815	92838	3.50042	24991	71838	0.00093	52197	97816	83
8	1.57848	65776	88648	3.36986	80266	68445	0.00122	24470	64294	82
9	1.58054	09338	95721	3.25530	29421	43555	0.00154	85045	16579	81
10	1.58284	28043	38351	3.15338	52518	87839	0.00191	35945	90170	80
11	1.58539	41637	75538	3.06172	86120	38789	0.00231	79450	15821	79
12	1.58819	72125	27520	2.97856	89511	81384	0.00276	18093	29252	78
13	1.59125	43820	13687	2.90256	49406	70027	0.00324	54674	43525	77
14	1.59456	83409	31825	2.83267	25829	18100	0.00376	92262	86978	76
15	1.59814	20021	12540	2.76806	31453	68768	0.00433	34205	09983	75
16	1.60197	85300	86952	2.70806	76145	90486	0.00493	84132	64213	74
17	1.60608	13494	10364	2.65213	80046	30204	0.00558	45970	58517	73
18	1.61045	41537	89663	2.59981	97300	61099	0.00627	23946	95994	72
19	1.61510	09160	67722	2.55073	14496	27254	0.00700	22602	97383	71
20	1.62002	58991	24204	2.50455	00790	01634	0.00777	46804	16442	70
21	1.62523	36677	58843	2.46099	94583	04126	0.00859	01752	53626	69
22	1.63072	91016	30788	2.41984	16537	39137	0.00944	92999	75082	68
23	1.63651	74093	35819	2.38087	01906	04429	0.01035	26461	44729	67
24	1.64260	41437	12491	2.34390	47244	46913	0.01130	08432	78049	66
25	1.64899	52184	78530	2.30878	67981	67196	0.01229	45605	27181	65
26	1.65569	69263	10344	2.27537	64296	11676	0.01333	45085	07947	64
27	1.66271	59584	91370	2.24354	93416	98626	0.01442	14412	80638	63
28	1.67005	94262	69580	2.21319	46949	79374	0.01555	61584	97708	62
29	1.67773	48840	80745	2.18421	32169	49248	0.01673	95077	33023	61
30	1.68575	03548	12596	2.15651	56474	99643	0.01797	23870	08967	60
31	1.69411	43573	05914	2.13002	14383	99325	0.01925	57475	39635	59
32	1.70283	59363	12341	2.10465	76584	91159	0.02059	05967	10437	58
33	1.71192	46951	55678	2.08035	80666	91578	0.02197	80013	16901	57
34	1.72139	08313	74249	2.05706	23227	97365	0.02341	90910	88188	56
35	1.73124	51756	57058	2.03471	53121	85791	0.02491	50625	23981	55
36	1.74149	92344	26774	2.01326	65652	05468	0.02646	71830	76961	54
37	1.75216	52364	68845	1.99266	97557	34209	0.02807	67957	17219	53
38	1.76325	61840	59342	1.97288	22662	74650	0.02974	53239	19583	52
39	1.77478	59091	05608	1.95386	48092	51663	0.03147	42771	20286	51
40	1.78676	91348	85021	1.93558	10960	04722	0.03326	52566	95577	50
41	1.79922	15440	49811	1.91799	75464	36423	0.03511	99625	22096	49
42	1.81215	98536	62126	1.90108	30334	63664	0.03704	02001	87133	48
43	1.82560	18981	35889	1.88480	86573	80404	0.03902	78889	26607	47
44	1.83956	67210	93652	1.86914	75460	26462	0.04108	50703	79885	46
45	1.85407	46773	01372	1.85407	46773	01372	0.04321	39182	63772	45
90°- α	$K'(\alpha)$			$K(\alpha)$			$q_1(\alpha)$			α
	[(-5)7]						[(-6)9]			
	11						9			

Compiled from G. W. and R. M. Spenceley, Smithsonian elliptic function tables, Smithsonian Miscellaneous Collection, vol. 109, Washington, D.C., 1947 (with permission).

COMPLETE ELLIPTIC INTEGRALS OF THE FIRST AND SECOND KINDS Table 17.2
AND THE NOME q WITH ARGUMENT THE MODULAR ANGLE α

$$K(\alpha) = \int_0^{\frac{\pi}{2}} (1 - \sin^2 \alpha \sin^2 \theta)^{-\frac{1}{2}} d\theta \quad K'(\alpha) = K(90^\circ - \alpha)$$

$$E(\alpha) = \int_0^{\frac{\pi}{2}} (1 - \sin^2 \alpha \sin^2 \theta)^{\frac{1}{2}} d\theta \quad E'(\alpha) = E(90^\circ - \alpha)$$

$$q(\alpha) = \exp[-\pi K'(\alpha)/K(\alpha)] \quad q_1(\alpha) = q(90^\circ - \alpha)$$

α	$q_1(\alpha)$			$E(\alpha)$			$E'(\alpha)$			$90^\circ - \alpha$
0°	1.00000	00000	00000	1.57079	63267	94897	1.00000	00000	00000	90°
1	0.40330	93063	38378	1.57067	67091	27960	1.00075	15777	01834	89
2	0.35316	56482	96037	1.57031	79198	97448	1.00258	40855	27552	88
3	0.32040	03371	34866	1.56972	01504	23979	1.00525	85872	09152	87
4	0.29548	83855	58691	1.56888	37196	07763	1.00864	79569	07096	86
5	0.27517	98048	73563	1.56780	90739	77622	1.01266	35062	34396	85
6	0.25794	01957	66337	1.56649	67877	60132	1.01723	69183	41019	84
7	0.24291	29743	06665	1.56494	75629	69419	1.02231	25881	67584	83
8	0.22956	71598	81194	1.56316	22295	18261	1.02784	36197	40833	82
9	0.21754	89496	99726	1.56114	17453	51334	1.03378	94623	90754	81
10	0.20660	97552	00965	1.55888	71966	01596	1.04011	43957	06010	80
11	0.19656	76611	43642	1.55639	97977	70947	1.04678	64993	44049	79
12	0.18728	51836	10217	1.55368	08919	36509	1.05377	69204	07046	78
13	0.17865	56628	04653	1.55073	19509	84013	1.06105	93337	53857	77
14	0.17059	45383	49477	1.54755	45758	69993	1.06860	95329	78401	76
15	0.16303	35348	21581	1.54415	04969	14673	1.07640	51130	76403	75
16	0.15591	66592	65792	1.54052	15741	27631	1.08442	52193	72543	74
17	0.14919	73690	67429	1.53666	97975	68556	1.09265	03455	37715	73
18	0.14283	65198	36280	1.53259	72877	45636	1.10106	21687	57941	72
19	0.13680	08474	28619	1.52830	62960	54359	1.10964	34135	42761	71
20	0.13106	18244	99858	1.52379	92052	59774	1.11837	77379	69864	70
21	0.12559	47852	09819	1.51907	85300	25531	1.12724	96377	57702	69
22	0.12037	82455	07894	1.51414	69174	93342	1.13624	43646	84239	68
23	0.11539	33684	49987	1.50900	71479	16775	1.14534	78566	80849	67
24	0.11062	35386	78854	1.50366	21353	53715	1.15454	66775	24465	66
25	0.10605	40201	85996	1.49811	49284	22116	1.16382	79644	93139	65
26	0.10167	16783	93444	1.49236	87111	24151	1.17317	93826	83722	64
27	0.09746	47524	70352	1.48642	68037	44253	1.18258	90849	45384	63
28	0.09342	26672	88483	1.48029	26638	27039	1.19204	56765	79886	62
29	0.08953	58769	52553	1.47396	98872	41625	1.20153	81841	13662	61
30	0.08579	57337	02195	1.46746	22093	39427	1.21105	60275	68459	60
31	0.08219	43773	66408	1.46077	35062	13127	1.22058	89957	54247	59
32	0.07872	46415	92073	1.45390	77960	65210	1.23012	72241	85949	58
33	0.07537	99738	58803	1.44686	92406	95183	1.23966	11752	88672	57
34	0.07215	43668	98737	1.43966	21471	15459	1.24918	16206	07472	56
35	0.06904	22996	09032	1.43229	09693	06756	1.25867	96247	79997	55
36	0.06603	86859	10861	1.42476	03101	24890	1.26814	65310	65206	54
37	0.06313	88302	96461	1.41707	49233	71952	1.27757	39482	50391	53
38	0.06033	83890	33716	1.40923	97160	46096	1.28695	37387	83001	52
39	0.05763	33361	79494	1.40125	97507	85523	1.29627	80079	94134	51
40	0.05501	99336	98829	1.39314	02485	23812	1.30553	90942	97794	50
41	0.05249	47051	04844	1.38488	65913	75413	1.31472	95602	64623	49
42	0.05005	44121	29953	1.37650	43257	72082	1.32384	21844	81263	48
43	0.04769	60340	17056	1.36799	91658	73159	1.33286	99541	17179	47
44	0.04541	67490	83529	1.35937	69972	75008	1.34180	60581	29911	46
45	0.04321	39182	63772	1.35064	38810	47676	1.35064	38810	47676	45
90°- α	$q(\alpha)$			$E'(\alpha)$			$E(\alpha)$			α

$\left[\begin{smallmatrix} (-5)3 \\ 9 \end{smallmatrix} \right]$

Table 17.3 PARAMETER m WITH ARGUMENT $K'(m)/K(m)$

K' K	m	K' K	m	K' K	m
0.30	0.99954 69976	1.20	0.30866 25998	2.10	0.02158 74007
0.32	0.99912 85258	1.22	0.29292 52811	2.12	0.02028 61803
0.34	0.99844 79307	1.24	0.27782 39170	2.14	0.01906 26278
0.36	0.99740 80762	1.26	0.26335 17107	2.16	0.01791 21974
0.38	0.99590 01861	1.28	0.24949 94512	2.18	0.01683 05990
0.40	0.99380 79974	1.30	0.23625 58558	2.20	0.01581 37845
0.42	0.99101 23521	1.32	0.22360 78874	2.22	0.01485 79356
0.44	0.98739 58502	1.34	0.21154 10467	2.24	0.01395 94517
0.46	0.98284 72586	1.36	0.20003 96393	2.26	0.01311 49385
0.48	0.97726 54540	1.38	0.18908 70181	2.28	0.01232 11967
0.50	0.97056 27485	1.40	0.17866 58032	2.30	0.01157 52117
0.52	0.96266 75125	1.42	0.16875 80773	2.32	0.01087 41433
0.54	0.95352 60602	1.44	0.15934 55603	2.34	0.01021 53165
0.56	0.94310 38029	1.46	0.15040 97635	2.36	0.00959 62118
0.58	0.93138 57063	1.48	0.14193 21249	2.38	0.00901 44574
0.60	0.91837 61134	1.50	0.13389 41273	2.40	0.00846 78199
0.62	0.90409 80105	1.52	0.12627 73987	2.42	0.00795 41974
0.64	0.88859 18214	1.54	0.11906 38004	2.44	0.00747 16117
0.66	0.87191 38254	1.56	0.11223 54993	2.46	0.00701 82011
0.68	0.85413 42916	1.58	0.10577 50300	2.48	0.00659 22140
0.70	0.83533 54217	1.60	0.09966 53447	2.50	0.00619 20026
0.72	0.81560 91841	1.62	0.09388 98538	2.52	0.00581 60167
0.74	0.79505 51193	1.64	0.08843 24583	2.54	0.00546 27984
0.76	0.77377 81814	1.66	0.08327 75739	2.56	0.00513 09763
0.78	0.75188 66711	1.68	0.07841 01486	2.58	0.00481 92610
0.80	0.72949 03078	1.70	0.07381 56747	2.60	0.00452 64398
0.82	0.70669 84707	1.72	0.06948 01950	2.62	0.00425 13725
0.84	0.68361 86358	1.74	0.06539 03054	2.64	0.00399 29873
0.86	0.66035 50204	1.76	0.06153 31533	2.66	0.00375 02764
0.88	0.63700 74395	1.78	0.05789 64327	2.68	0.00352 22924
0.90	0.61367 03730	1.80	0.05446 83767	2.70	0.00330 81448
0.92	0.59043 22404	1.82	0.05123 77481	2.72	0.00310 69966
0.94	0.56737 48621	1.84	0.04819 38272	2.74	0.00291 80610
0.96	0.54457 30994	1.86	0.04532 63995	2.76	0.00274 05988
0.98	0.52209 46531	1.88	0.04262 57408	2.78	0.00257 39151
1.00	0.50000 00000	1.90	0.04008 26022	2.80	0.00241 73568
1.02	0.47834 24497	1.92	0.03768 81947	2.82	0.00227 03103
1.04	0.45716 83054	1.94	0.03543 41720	2.84	0.00213 21990
1.06	0.43651 71048	1.96	0.03331 26147	2.86	0.00200 24811
1.08	0.41642 19278	1.98	0.03131 60134	2.88	0.00188 06475
1.10	0.39690 97552	2.00	0.02943 72515	2.90	0.00176 62198
1.12	0.37800 18621	2.02	0.02766 95892	2.92	0.00165 87487
1.14	0.35971 42366	2.04	0.02600 66464	2.94	0.00155 78119
1.16	0.34205 80100	2.06	0.02444 23873	2.96	0.00146 30127
1.18	0.32503 98919	2.08	0.02297 11038	2.98	0.00137 39785
1.20	0.30866 25998	2.10	0.02158 74007	3.00	0.00129 03591

For $\frac{K'}{K} > 3.0$, $\frac{K'}{K} < 0.3$, see Example 6.

Table 17.4

AUXILIARY FUNCTIONS FOR COMPUTATION OF THE NOME q AND THE PARAMETER m

m_1	$Q(m) = \frac{q_1(m)}{m_1}$	$L(m)$	m_1	$Q(m) = -K(m) + \frac{K'(m)}{\pi} \ln \frac{16}{m_1}$	$L(m)$
0.00	0.06250 00000 00000	0.00000 00000	0.08	0.06513 95233 36060	0.02111 58281
0.01	0.06281 45660 38302	0.00251 65276	0.09	0.06549 04937 14101	0.02392 34345
0.02	0.06313 33261 60188	0.00506 66040	0.10	0.06584 65155 38584	0.02677 14110
0.03	0.06345 63756 34180	0.00765 09870	0.11	0.06620 77131 77434	0.02966 07472
0.04	0.06378 38128 42217	0.01027 04595	0.12	0.06657 42154 15123	0.03259 24678
0.05	0.06411 57394 13714	0.01292 58301	0.13	0.06694 61556 59704	0.03556 76342
0.06	0.06445 22603 66828	0.01561 79344	0.14	0.06732 36721 61983	0.03858 73466
0.07	0.06479 34842 57396	0.01834 76360	0.15	0.06770 69082 47689	0.04165 27452

See Examples 3, 5 and 6.

ELLIPTIC INTEGRAL OF THE FIRST KIND $F(\varphi|\alpha)$

Table 17.5

$$F(\varphi|\alpha) = \int_0^\varphi (1 - \sin^2 \alpha \sin^2 \theta)^{-\frac{1}{2}} d\theta$$

$\alpha \setminus \varphi$	0°	5°	10°	15°	20°	25°	30°
0	0	0.08726 646	0.17453 293	0.26179 939	0.34906 585	0.43633 231	0.52359 878
2	0	0.08726 660	0.17453 400	0.26180 298	0.34907 428	0.43634 855	0.52362 636
4	0	0.08726 700	0.17453 721	0.26181 374	0.34909 952	0.43639 719	0.52370 903
6	0	0.08726 767	0.17454 255	0.26183 163	0.34914 148	0.43647 806	0.52384 653
8	0	0.08726 860	0.17454 999	0.26185 656	0.34919 998	0.43659 086	0.52403 839
10	0	0.08726 980	0.17455 949	0.26188 842	0.34927 479	0.43673 518	0.52428 402
12	0	0.08727 124	0.17457 102	0.26192 707	0.34936 558	0.43691 046	0.52458 259
14	0	0.08727 294	0.17458 451	0.26197 234	0.34947 200	0.43711 606	0.52493 314
16	0	0.08727 487	0.17459 991	0.26202 402	0.34959 358	0.43735 119	0.52533 449
18	0	0.08727 703	0.17461 714	0.26208 189	0.34972 983	0.43761 496	0.52578 529
20	0	0.08727 940	0.17463 611	0.26214 568	0.34988 016	0.43790 635	0.52628 399
22	0	0.08728 199	0.17465 675	0.26221 511	0.35004 395	0.43822 422	0.52682 887
24	0	0.08728 477	0.17467 895	0.26228 985	0.35022 048	0.43856 733	0.52741 799
26	0	0.08728 773	0.17470 261	0.26236 958	0.35040 901	0.43893 430	0.52804 924
28	0	0.08729 086	0.17472 762	0.26245 392	0.35060 870	0.43932 365	0.52872 029
30	0	0.08729 413	0.17475 386	0.26254 249	0.35081 868	0.43973 377	0.52942 863
32	0	0.08729 755	0.17478 119	0.26263 487	0.35103 803	0.44016 296	0.53017 153
34	0	0.08730 108	0.17480 950	0.26273 064	0.35126 576	0.44060 939	0.53094 608
36	0	0.08730 472	0.17483 864	0.26282 934	0.35150 083	0.44107 115	0.53174 916
38	0	0.08730 844	0.17486 848	0.26293 052	0.35174 218	0.44154 622	0.53257 745
40	0	0.08731 222	0.17489 887	0.26303 369	0.35198 869	0.44203 247	0.53342 745
42	0	0.08731 606	0.17492 967	0.26313 836	0.35223 920	0.44252 769	0.53429 546
44	0	0.08731 992	0.17496 073	0.26324 404	0.35249 254	0.44302 960	0.53517 761
46	0	0.08732 379	0.17499 189	0.26335 019	0.35274 748	0.44353 584	0.53606 986
48	0	0.08732 765	0.17502 300	0.26345 633	0.35300 280	0.44404 397	0.53696 798
50	0	0.08733 149	0.17505 392	0.26356 191	0.35325 724	0.44455 151	0.53786 765
52	0	0.08733 528	0.17508 448	0.26366 643	0.35350 955	0.44505 593	0.53876 438
54	0	0.08733 901	0.17511 455	0.26376 936	0.35375 845	0.44555 469	0.53965 358
56	0	0.08734 265	0.17514 397	0.26387 020	0.35400 269	0.44604 519	0.54053 059
58	0	0.08734 620	0.17517 260	0.26396 842	0.35424 101	0.44652 487	0.54139 069
60	0	0.08734 962	0.17520 029	0.26406 355	0.35447 217	0.44699 117	0.54222 911
62	0	0.08735 291	0.17522 690	0.26415 509	0.35469 497	0.44744 153	0.54304 111
64	0	0.08735 605	0.17525 232	0.26424 258	0.35490 823	0.44787 348	0.54382 197
66	0	0.08735 902	0.17527 640	0.26432 556	0.35511 081	0.44828 459	0.54456 704
68	0	0.08736 182	0.17529 903	0.26440 362	0.35530 160	0.44867 252	0.54527 182
70	0	0.08736 442	0.17532 010	0.26447 634	0.35547 959	0.44903 502	0.54593 192
72	0	0.08736 681	0.17533 949	0.26454 334	0.35564 377	0.44936 997	0.54654 316
74	0	0.08736 898	0.17535 712	0.26460 428	0.35579 326	0.44967 538	0.54710 162
76	0	0.08737 092	0.17537 289	0.26465 883	0.35592 721	0.44994 944	0.54760 364
78	0	0.08737 262	0.17538 672	0.26470 671	0.35604 488	0.45019 046	0.54804 587
80	0	0.08737 408	0.17539 854	0.26474 766	0.35614 560	0.45039 699	0.54842 535
82	0	0.08737 528	0.17540 830	0.26478 147	0.35622 881	0.45056 775	0.54873 947
84	0	0.08737 622	0.17541 594	0.26480 795	0.35629 402	0.45070 168	0.54898 608
86	0	0.08737 689	0.17542 143	0.26482 697	0.35634 086	0.45079 795	0.54916 348
88	0	0.08737 730	0.17542 473	0.26483 842	0.35636 908	0.45085 596	0.54927 042
90	0	0.08737 744	0.17542 583	0.26484 225	0.35637 851	0.45087 533	0.54930 614
		$\left[\begin{smallmatrix} (-8)3 \\ 3 \end{smallmatrix} \right]$	$\left[\begin{smallmatrix} (-7)3 \\ 4 \end{smallmatrix} \right]$	$\left[\begin{smallmatrix} (-6)1 \\ 4 \end{smallmatrix} \right]$	$\left[\begin{smallmatrix} (-6)2 \\ 5 \end{smallmatrix} \right]$	$\left[\begin{smallmatrix} (-6)5 \\ 5 \end{smallmatrix} \right]$	$\left[\begin{smallmatrix} (-6)9 \\ 5 \end{smallmatrix} \right]$
5	0	0.08726 730	0.17453 962	0.26182 180	0.34911 842	0.43643 361	0.52377 095
15	0	0.08727 387	0.17459 198	0.26199 739	0.34953 092	0.43722 998	0.52512 754
25	0	0.08728 623	0.17469 061	0.26232 912	0.35031 330	0.43874 792	0.52772 849
35	0	0.08730 289	0.17482 397	0.26277 965	0.35138 244	0.44083 848	0.53134 425
45	0	0.08732 185	0.17497 630	0.26329 709	0.35261 989	0.44328 233	0.53562 273
55	0	0.08734 084	0.17512 935	0.26382 007	0.35388 123	0.44580 113	0.54009 391
65	0	0.08735 756	0.17526 454	0.26428 466	0.35501 092	0.44808 179	0.54419 926
75	0	0.08736 998	0.17536 525	0.26463 238	0.35586 223	0.44981 645	0.54735 991
85	0	0.08737 659	0.17541 895	0.26481 840	0.35631 976	0.45075 457	0.54908 352

The table can also be used inversely to find $\varphi = \text{am } u$ where $u = F(\varphi|\alpha)$ and so the Jacobian elliptic functions, for example $\text{sn } u = \sin \varphi$, $\text{cn } u = \cos \varphi$, $\text{dn } u = (1 - \sin^2 \alpha \sin^2 \varphi)^{1/2}$. See Examples 7-11. Compiled from K. Pearson, Tables of the complete and incomplete elliptic integrals, Cambridge Univ. Press, Cambridge, England, 1934 (with permission). Known errors have been corrected.

Table 17.5

ELLIPTIC INTEGRAL OF THE FIRST KIND $F(\varphi|\alpha)$

$$F(\varphi|\alpha) = \int_0^\varphi (1 - \sin^2 \alpha \sin^2 \theta)^{-\frac{1}{2}} d\theta$$

$\alpha \backslash \varphi$	35°	40°	45°	50°	55°	60°
0°	0.61086 524	0.69813 170	0.78539 816	0.87266 463	0.95993 109	1.04719 755
2	0.61090 819	0.69819 436	0.78548 509	0.87278 045	0.96008 037	1.04738 465
4	0.61103 691	0.69838 220	0.78574 574	0.87312 784	0.96052 821	1.04794 603
6	0.61125 108	0.69869 484	0.78617 974	0.87370 649	0.96127 450	1.04888 194
8	0.61155 010	0.69913 161	0.78678 644	0.87451 593	0.96231 911	1.05019 278
10	0.61193 318	0.69969 159	0.78756 494	0.87555 545	0.96366 180	1.05187 911
12	0.61239 927	0.70037 358	0.78851 403	0.87682 412	0.96530 224	1.05394 160
14	0.61294 707	0.70117 608	0.78963 221	0.87832 076	0.96723 998	1.05638 099
16	0.61357 504	0.70209 730	0.79091 768	0.88004 389	0.96947 438	1.05919 813
18	0.61428 140	0.70313 511	0.79236 827	0.88199 174	0.97200 462	1.06239 384
20	0.61506 406	0.70428 706	0.79398 143	0.88416 214	0.97482 960	1.06596 891
22	0.61592 071	0.70555 037	0.79575 422	0.88655 254	0.97794 790	1.06992 405
24	0.61684 871	0.70692 183	0.79768 324	0.88915 992	0.98135 773	1.07425 976
26	0.61784 515	0.70839 788	0.79976 461	0.89198 071	0.98505 681	1.07897 628
28	0.61890 682	0.70997 451	0.80199 389	0.89501 076	0.98904 227	1.08407 347
30	0.62003 018	0.71164 728	0.80436 610	0.89824 524	0.99331 059	1.08955 067
32	0.62121 138	0.71341 124	0.80687 558	0.90167 852	0.99785 743	1.09540 656
34	0.62244 622	0.71526 098	0.80951 599	0.90530 415	1.00267 749	1.10163 899
36	0.62373 019	0.71719 052	0.81228 024	0.90911 465	1.00776 438	1.10824 474
38	0.62505 840	0.71919 335	0.81516 039	0.91310 148	1.01311 039	1.11521 933
40	0.62642 563	0.72126 235	0.81814 765	0.91725 487	1.01870 633	1.12255 667
42	0.62782 630	0.72338 982	0.82123 227	0.92156 370	1.02454 127	1.13024 880
44	0.62925 446	0.72556 741	0.82440 346	0.92601 535	1.03060 230	1.13828 546
46	0.63070 385	0.72778 615	0.82764 941	0.93059 558	1.03687 427	1.14665 369
48	0.63216 783	0.73003 640	0.83095 712	0.93528 835	1.04333 948	1.15533 731
50	0.63363 947	0.73230 789	0.83431 247	0.94007 568	1.04997 735	1.16431 637
52	0.63511 150	0.73458 970	0.83770 010	0.94493 756	1.05676 412	1.17356 652
54	0.63657 639	0.73687 028	0.84110 344	0.94985 177	1.06367 248	1.18305 833
56	0.63802 636	0.73913 751	0.84450 468	0.95479 381	1.07067 128	1.19275 650
58	0.63945 343	0.74137 870	0.84788 483	0.95973 682	1.07772 516	1.20261 907
60	0.64084 944	0.74358 071	0.85122 375	0.96465 156	1.08479 434	1.21259 661
62	0.64220 613	0.74572 998	0.85450 024	0.96950 647	1.09183 436	1.22263 139
64	0.64351 521	0.74781 266	0.85769 220	0.97426 773	1.09879 601	1.23265 660
66	0.64476 839	0.74981 471	0.86077 677	0.97889 946	1.10562 535	1.24259 576
68	0.64595 751	0.75172 208	0.86373 057	0.98336 406	1.11226 392	1.25236 238
70	0.64707 458	0.75352 078	0.86652 996	0.98762 253	1.11864 920	1.26185 988
72	0.64811 189	0.75519 716	0.86915 135	0.99163 507	1.12471 530	1.27098 218
74	0.64906 209	0.75673 800	0.87157 159	0.99536 166	1.13039 401	1.27961 482
76	0.64991 829	0.75813 076	0.87376 830	0.99876 287	1.13561 610	1.28763 696
78	0.65067 415	0.75936 376	0.87572 037	1.00180 067	1.14031 304	1.29492 436
80	0.65132 394	0.76042 640	0.87740 833	1.00443 942	1.14441 892	1.30135 321
82	0.65186 270	0.76130 931	0.87881 481	1.00664 678	1.14787 262	1.30680 495
84	0.65228 622	0.76200 457	0.87992 495	1.00839 470	1.15062 010	1.31117 166
86	0.65259 116	0.76250 582	0.88072 675	1.00966 028	1.15261 652	1.31436 170
88	0.65277 510	0.76280 846	0.88121 143	1.01042 658	1.15382 828	1.31630 510
90	0.65283 658	0.76290 965	0.88137 359	1.01068 319	1.15423 455	1.31695 790
	$\left[\begin{smallmatrix} (-5)2 \\ 5 \end{smallmatrix} \right]$	$\left[\begin{smallmatrix} (-5)3 \\ 6 \end{smallmatrix} \right]$	$\left[\begin{smallmatrix} (-5)4 \\ 6 \end{smallmatrix} \right]$	$\left[\begin{smallmatrix} (-5)6 \\ 6 \end{smallmatrix} \right]$	$\left[\begin{smallmatrix} (-4)1 \\ 7 \end{smallmatrix} \right]$	$\left[\begin{smallmatrix} (-4)2 \\ 7 \end{smallmatrix} \right]$
5	0.61113 335	0.69852 295	0.78594 111	0.87338 828	0.96086 405	1.04836 715
15	0.61325 114	0.70162 198	0.79025 416	0.87915 412	0.96832 014	1.05774 229
25	0.61733 857	0.70764 702	0.79870 514	0.89054 388	0.98317 128	1.07657 042
35	0.62308 236	0.71621 617	0.81088 311	0.90718 679	1.00518 803	1.10489 545
45	0.62997 691	0.72667 222	0.82601 788	0.92829 036	1.03371 296	1.14242 906
55	0.63730 374	0.73800 634	0.84280 548	0.95232 094	1.06716 268	1.18788 407
65	0.64414 930	0.74882 464	0.85924 936	0.97660 210	1.10223 077	1.23764 210
75	0.64950 235	0.75745 364	0.87269 924	0.99710 535	1.13306 645	1.28370 993
85	0.65245 368	0.76227 978	0.88036 502	1.00908 899	1.15171 457	1.31291 870

ELLIPTIC INTEGRAL OF THE FIRST KIND $F(\phi|\alpha)$

Table 17.5

$$F(\phi|\alpha) = \int_0^\phi (1 - \sin^2 \alpha \sin^2 \theta)^{-\frac{1}{2}} d\theta$$

$\alpha \setminus \phi$	65°	70°	75°	80°	85°	90°
0°	1.13446 401	1.22173 048	1.30899 694	1.39626 340	1.48352 986	1.57079 633
2	1.13469 294	1.22200 477	1.30931 959	1.39663 672	1.48395 543	1.57127 495
4	1.13537 994	1.22282 810	1.31028 822	1.39775 763	1.48523 342	1.57271 244
6	1.13652 576	1.22420 180	1.31190 491	1.39962 909	1.48736 769	1.57511 361
8	1.13813 158	1.22612 810	1.31417 314	1.40225 598	1.49036 470	1.57848 658
10	1.14019 906	1.22861 010	1.31709 778	1.40564 522	1.49423 361	1.58284 280
12	1.14273 032	1.23165 180	1.32068 514	1.40980 577	1.49898 627	1.58819 721
14	1.14572 789	1.23525 808	1.32494 296	1.41474 871	1.50463 742	1.59456 834
16	1.14919 471	1.23943 470	1.32988 047	1.42048 728	1.51120 474	1.60197 853
18	1.15313 409	1.24418 827	1.33550 840	1.42703 700	1.51870 904	1.61045 415
20	1.15754 967	1.24952 627	1.34183 901	1.43441 578	1.52717 445	1.62002 590
22	1.16244 535	1.25545 700	1.34888 616	1.44264 399	1.53662 865	1.63072 910
24	1.16782 525	1.26198 957	1.35666 531	1.45174 466	1.54710 309	1.64260 414
26	1.17369 362	1.26913 385	1.36519 359	1.46174 360	1.55863 334	1.65569 693
28	1.18005 472	1.27690 045	1.37448 981	1.47266 958	1.57125 942	1.67005 943
30	1.18691 274	1.28530 059	1.38457 455	1.48455 455	1.58502 624	1.68575 035
32	1.19427 162	1.29434 605	1.39547 013	1.49743 384	1.59998 406	1.70283 594
34	1.20213 489	1.30404 906	1.40720 064	1.51134 644	1.61618 906	1.72139 083
36	1.21050 542	1.31442 210	1.41979 198	1.52633 523	1.63370 398	1.74149 923
38	1.21938 520	1.32547 772	1.43327 179	1.54244 734	1.65259 894	1.76325 618
40	1.22877 499	1.33722 824	1.44766 938	1.55973 441	1.67295 226	1.78676 913
42	1.23867 392	1.34968 545	1.46301 565	1.57825 301	1.69485 156	1.81215 985
44	1.24907 904	1.36286 013	1.47934 287	1.59806 493	1.71839 498	1.83956 672
46	1.25998 475	1.37676 148	1.49668 437	1.61923 762	1.74369 264	1.86914 755
48	1.27138 210	1.39139 640	1.51507 416	1.64184 453	1.77086 836	1.90108 303
50	1.28325 798	1.40676 855	1.53454 619	1.66596 542	1.80006 176	1.93558 110
52	1.29559 414	1.42287 717	1.55513 354	1.69168 665	1.83143 068	1.97288 227
54	1.30836 604	1.43971 560	1.57686 709	1.71910 125	1.86515 414	2.01326 657
56	1.32154 149	1.45726 935	1.59977 378	1.74830 880	1.90143 591	2.05706 232
58	1.33507 910	1.47551 372	1.62387 409	1.77941 482	1.94050 873	2.10465 766
60	1.34892 643	1.49441 087	1.64917 867	1.81252 953	1.98263 957	2.15651 565
62	1.36301 803	1.51390 609	1.67568 359	1.84776 547	2.02813 570	2.21319 470
64	1.37727 323	1.53392 332	1.70336 398	1.88523 335	2.07735 219	2.27537 643
66	1.39159 384	1.55435 972	1.73216 516	1.92503 509	2.13070 052	2.34390 472
68	1.40586 195	1.57507 940	1.76199 085	1.96725 237	2.18865 839	2.41984 165
70	1.41993 796	1.59590 624	1.79268 736	2.01192 798	2.25177 995	2.50455 008
72	1.43365 925	1.61661 644	1.82402 292	2.05903 582	2.32070 416	2.59981 973
74	1.44684 001	1.63693 134	1.85566 175	2.10843 282	2.39615 610	2.70806 762
76	1.45927 266	1.65651 218	1.88713 308	2.15978 295	2.47892 739	2.83267 258
78	1.47073 163	1.67495 873	1.91779 814	2.21243 977	2.56980 281	2.97856 895
80	1.48098 006	1.69181 489	1.94682 231	2.26527 326	2.66935 045	3.15338 525
82	1.48977 975	1.70658 456	1.97316 666	2.31643 897	2.77736 748	3.36986 803
84	1.49690 410	1.71876 033	1.99562 118	2.36313 736	2.89146 664	3.65185 597
86	1.50215 336	1.72786 543	2.01290 452	2.40153 358	3.00370 926	4.05275 817
88	1.50537 033	1.73350 464	2.02384 126	2.42718 003	3.09448 898	4.74271 727
90	1.50645 424 $\left[\begin{smallmatrix} (-4)3 \\ 8 \end{smallmatrix} \right]$	1.73541 516 $\left[\begin{smallmatrix} (-4)5 \\ 8 \end{smallmatrix} \right]$	2.02758 942 $\left[\begin{smallmatrix} (-4)9 \\ 10 \end{smallmatrix} \right]$	2.43624 605 $\left[\begin{smallmatrix} (-3)2 \\ 10 \end{smallmatrix} \right]$	3.13130 133 $\left[\begin{smallmatrix} (-3)7 \end{smallmatrix} \right]$	∞
5	1.13589 544	1.22344 604	1.31101 537	1.39859 928	1.48619 317	1.57379 213
15	1.14740 244	1.23727 471	1.32732 612	1.41751 762	1.50780 533	1.59814 200
25	1.17069 811	1.26548 460	1.36083 467	1.45663 012	1.55273 384	1.64899 522
35	1.20625 660	1.30915 104	1.41338 702	1.51870 347	1.62477 858	1.73124 518
45	1.25446 980	1.36971 948	1.48788 472	1.60847 673	1.73081 713	1.85407 468
55	1.31490 567	1.44840 433	1.58817 233	1.73347 444	1.88296 142	2.03471 531
65	1.38443 225	1.54409 676	1.71762 935	1.90483 674	2.10348 169	2.30878 680
75	1.45316 359	1.64683 711	1.87145 396	2.13389 514	2.43657 614	2.76806 315
85	1.49977 412	1.72372 395	2.00498 776	2.38364 709	2.94868 876	3.83174 200

Table 17.6 ELLIPTIC INTEGRAL OF THE SECOND KIND $E(\varphi|\alpha)$

$$E(\varphi|\alpha) = \int_0^\varphi (1 - \sin^2 \alpha \sin^2 \theta)^{\frac{1}{2}} d\theta$$

$\alpha \setminus \varphi$	0°	5°	10°	15°	20°	25°	30°
0°	0	0.08726 646	0.17453 293	0.26179 939	0.34906 585	0.43633 231	0.52359 878
2	0	0.08726 633	0.17453 185	0.26179 579	0.34905 742	0.43631 608	0.52357 119
4	0	0.08726 592	0.17452 864	0.26178 503	0.34903 218	0.43626 745	0.52348 856
6	0	0.08726 525	0.17452 330	0.26176 715	0.34899 025	0.43618 665	0.52335 123
8	0	0.08726 432	0.17451 587	0.26174 224	0.34893 181	0.43607 403	0.52315 981
10	0	0.08726 313	0.17450 636	0.26171 041	0.34885 714	0.43593 011	0.52291 511
12	0	0.08726 168	0.17449 485	0.26167 182	0.34876 657	0.43575 552	0.52261 821
14	0	0.08725 999	0.17448 137	0.26162 664	0.34866 055	0.43555 106	0.52227 039
16	0	0.08725 806	0.17446 599	0.26157 510	0.34853 954	0.43531 765	0.52187 317
18	0	0.08725 590	0.17444 879	0.26151 743	0.34840 412	0.43505 633	0.52142 828
20	0	0.08725 352	0.17442 985	0.26145 391	0.34825 492	0.43476 831	0.52093 770
22	0	0.08725 094	0.17440 926	0.26138 485	0.34809 262	0.43445 488	0.52040 357
24	0	0.08724 816	0.17438 712	0.26131 056	0.34791 800	0.43411 749	0.51982 827
26	0	0.08724 521	0.17436 353	0.26123 141	0.34773 187	0.43375 767	0.51921 436
28	0	0.08724 208	0.17433 862	0.26114 778	0.34753 510	0.43337 709	0.51856 461
30	0	0.08723 881	0.17431 250	0.26106 005	0.34732 863	0.43297 749	0.51788 193
32	0	0.08723 540	0.17428 529	0.26096 867	0.34711 342	0.43256 075	0.51716 944
34	0	0.08723 187	0.17425 714	0.26087 405	0.34689 050	0.43212 880	0.51643 040
36	0	0.08722 824	0.17422 817	0.26077 666	0.34666 093	0.43168 368	0.51566 820
38	0	0.08722 453	0.17419 852	0.26067 697	0.34642 580	0.43122 748	0.51488 638
40	0	0.08722 075	0.17416 835	0.26057 545	0.34618 625	0.43076 236	0.51408 862
42	0	0.08721 692	0.17413 779	0.26047 261	0.34594 343	0.43029 055	0.51327 866
44	0	0.08721 307	0.17410 700	0.26036 893	0.34569 850	0.42981 431	0.51246 037
46	0	0.08720 920	0.17407 613	0.26026 492	0.34545 266	0.42933 594	0.51163 767
48	0	0.08720 535	0.17404 531	0.26016 110	0.34520 710	0.42885 776	0.51081 454
50	0	0.08720 152	0.17401 472	0.26005 795	0.34496 302	0.42838 212	0.50999 501
52	0	0.08719 774	0.17398 449	0.25995 600	0.34472 162	0.42791 134	0.50918 310
54	0	0.08719 402	0.17395 477	0.25985 574	0.34448 409	0.42744 775	0.50838 287
56	0	0.08719 039	0.17392 571	0.25975 765	0.34425 159	0.42699 368	0.50759 831
58	0	0.08718 686	0.17389 745	0.25966 224	0.34402 529	0.42655 138	0.50683 341
60	0	0.08718 345	0.17387 013	0.25956 996	0.34380 631	0.42612 308	0.50609 207
62	0	0.08718 017	0.17384 388	0.25948 126	0.34359 575	0.42571 097	0.50537 811
64	0	0.08717 704	0.17381 883	0.25939 660	0.34339 465	0.42531 712	0.50469 523
66	0	0.08717 408	0.17379 511	0.25931 640	0.34320 404	0.42494 358	0.50404 700
68	0	0.08717 130	0.17377 283	0.25924 104	0.34302 487	0.42459 224	0.50343 686
70	0	0.08716 871	0.17375 210	0.25917 090	0.34285 805	0.42426 495	0.50286 804
72	0	0.08716 633	0.17373 302	0.25910 634	0.34270 443	0.42396 339	0.50234 359
74	0	0.08716 416	0.17371 568	0.25904 767	0.34256 478	0.42368 913	0.50186 633
76	0	0.08716 223	0.17370 018	0.25899 519	0.34243 984	0.42344 363	0.50143 886
78	0	0.08716 053	0.17368 659	0.25894 917	0.34233 022	0.42322 817	0.50106 351
80	0	0.08715 909	0.17367 498	0.25890 983	0.34223 650	0.42304 389	0.50074 232
82	0	0.08715 789	0.17366 539	0.25887 737	0.34215 915	0.42289 175	0.50047 707
84	0	0.08715 695	0.17365 789	0.25885 195	0.34209 857	0.42277 258	0.50026 923
86	0	0.08715 628	0.17365 250	0.25883 370	0.34205 507	0.42268 700	0.50011 993
88	0	0.08715 588	0.17364 926	0.25882 271	0.34202 889	0.42263 547	0.50003 003
90	0	0.08715 574	0.17364 818	0.25881 905	0.34202 014	0.42261 826	0.50000 000
		$\left[\begin{smallmatrix} (-8)4 \\ 3 \end{smallmatrix} \right]$	$\left[\begin{smallmatrix} (-7)3 \\ 4 \end{smallmatrix} \right]$	$\left[\begin{smallmatrix} (-7)9 \\ 4 \end{smallmatrix} \right]$	$\left[\begin{smallmatrix} (-6)2 \\ 5 \end{smallmatrix} \right]$	$\left[\begin{smallmatrix} (-6)4 \\ 5 \end{smallmatrix} \right]$	$\left[\begin{smallmatrix} (-6)7 \\ 5 \end{smallmatrix} \right]$
5	0	0.08726 562	0.17452 624	0.26177 698	0.34901 329	0.43623 105	0.52342 670
15	0	0.08725 905	0.17447 391	0.26160 165	0.34860 188	0.43543 791	0.52207 785
25	0	0.08724 671	0.17437 550	0.26127 157	0.34782 632	0.43394 028	0.51952 597
35	0	0.08723 006	0.17424 275	0.26082 567	0.34677 648	0.43190 776	0.51605 197
45	0	0.08721 113	0.17409 157	0.26031 693	0.34557 562	0.42957 525	0.51204 932
55	0	0.08719 220	0.17394 015	0.25980 639	0.34436 714	0.42721 938	0.50798 838
65	0	0.08717 554	0.17380 680	0.25935 592	0.34329 797	0.42512 769	0.50436 656
75	0	0.08716 317	0.17370 770	0.25902 064	0.34250 043	0.42356 271	0.50164 622
85	0	0.08715 659	0.17365 493	0.25884 192	0.34207 467	0.42272 556	0.50018 720

See Example 14.

Compiled from K. Pearson, Tables of the complete and incomplete elliptic integrals, Cambridge Univ. Press, Cambridge, England, 1934 (with permission). Known errors have been corrected.

ELLIPTIC INTEGRALS

ELLIPTIC INTEGRAL OF THE SECOND KIND $E(\varphi|\alpha)$ Table 17.6
$$E(\varphi|\alpha) = \int_0^\varphi (1 - \sin^2 \alpha \sin^2 \theta)^{\frac{1}{2}} d\theta$$

$\alpha \backslash \varphi$	35°		40°		45°		50°		55°		60°	
0°	0.61086	524	0.69813	170	0.78539	816	0.87266	463	0.95993	109	1.04719	755
2	0.61082	230	0.69806	905	0.78531	125	0.87254	883	0.95978	184	1.04701	051
4	0.61069	365	0.69788	136	0.78505	085	0.87220	183	0.95933	459	1.04644	996
6	0.61047	983	0.69756	935	0.78461	792	0.87162	487	0.95859	083	1.04551	764
8	0.61018	171	0.69713	427	0.78401	409	0.87081	998	0.95755	301	1.04421	646
10	0.60980	055	0.69657	784	0.78324	162	0.86979	001	0.95622	460	1.04255	047
12	0.60933	793	0.69590	226	0.78230	343	0.86853	863	0.95461	005	1.04052	491
14	0.60879	577	0.69511	023	0.78120	398	0.86707	031	0.95271	478	1.03814	615
16	0.60817	636	0.69420	492	0.77994	473	0.86539	034	0.95054	522	1.03542	177
18	0.60748	229	0.69318	999	0.77853	323	0.86350	481	0.94810	878	1.03236	049
20	0.60671	652	0.69206	954	0.77697	402	0.86142	062	0.94541	386	1.02897	221
22	0.60588	229	0.69084	814	0.77527	316	0.85914	545	0.94246	984	1.02526	804
24	0.60498	319	0.68953	083	0.77343	735	0.85668	781	0.93928	709	1.02126	023
26	0.60402	308	0.68812	308	0.77147	387	0.85405	695	0.93587	699	1.01696	224
28	0.60300	616	0.68663	077	0.76939	059	0.85126	295	0.93225	186	1.01238	873
30	0.60193	687	0.68506	023	0.76719	599	0.84831	663	0.92842	504	1.00755	556
32	0.60081	994	0.68341	817	0.76489	908	0.84522	958	0.92441	083	1.00247	977
34	0.59966	035	0.68171	170	0.76250	947	0.84201	414	0.92022	452	0.99717	966
36	0.59846	332	0.67994	830	0.76003	726	0.83868	340	0.91588	234	0.99167	469
38	0.59723	431	0.67813	578	0.75749	309	0.83525	115	0.91140	150	0.98598	560
40	0.59597	897	0.67628	229	0.75488	809	0.83173	189	0.90680	017	0.98013	430
42	0.59470	312	0.67439	630	0.75223	383	0.82814	080	0.90209	742	0.97414	397
44	0.59341	278	0.67248	651	0.74954	234	0.82449	369	0.89731	325	0.96803	899
46	0.59211	406	0.67056	191	0.74682	605	0.82080	700	0.89246	858	0.96184	497
48	0.59081	324	0.66863	167	0.74409	773	0.81709	775	0.88758	513	0.95558	873
50	0.58951	664	0.66670	515	0.74137	047	0.81338	346	0.88268	551	0.94929	830
52	0.58823	065	0.66479	183	0.73865	766	0.80968	217	0.87779	305	0.94300	285
54	0.58696	171	0.66290	130	0.73597	286	0.80601	230	0.87293	184	0.93673	272
56	0.58571	622	0.66104	317	0.73332	979	0.80239	262	0.86812	660	0.93051	931
58	0.58450	056	0.65922	707	0.73074	229	0.79884	217	0.86340	261	0.92439	505
60	0.58332	103	0.65746	255	0.72822	416	0.79538	015	0.85878	561	0.91839	329
62	0.58218	382	0.65575	905	0.72578	915	0.79202	582	0.85430	169	0.91254	821
64	0.58109	497	0.65412	585	0.72345	085	0.78879	839	0.84997	709	0.90689	460
66	0.58006	032	0.65257	197	0.72122	260	0.78571	685	0.84583	811	0.90146	778
68	0.57908	549	0.65110	612	0.71911	737	0.78279	987	0.84191	082	0.89630	323
70	0.57817	584	0.64973	667	0.71714	767	0.78006	562	0.83822	090	0.89143	642
72	0.57733	641	0.64847	154	0.71532	545	0.77753	157	0.83479	335	0.88690	237
74	0.57657	189	0.64731	812	0.71366	196	0.77521	434	0.83165	223	0.88273	530
76	0.57588	663	0.64628	328	0.71216	766	0.77312	952	0.82882	031	0.87896	810
78	0.57528	450	0.64537	322	0.71085	210	0.77129	143	0.82631	879	0.87563	185
80	0.57476	897	0.64459	347	0.70972	381	0.76971	298	0.82416	694	0.87275	520
82	0.57434	302	0.64394	879	0.70879	019	0.76840	544	0.82238	177	0.87036	381
84	0.57400	912	0.64344	316	0.70805	745	0.76737	830	0.82097	770	0.86847	970
86	0.57376	921	0.64307	973	0.70753	050	0.76663	912	0.81996	631	0.86712	068
88	0.57362	470	0.64286	075	0.70721	289	0.76619	339	0.81935	604	0.86629	990
90	0.57357	644	0.64278	761	0.70710	678	0.76604	444	0.81915	204	0.86602	540
	$\left[\begin{smallmatrix} (-5)1 \\ 5 \end{smallmatrix} \right]$	$\left[\begin{smallmatrix} (-5)2 \\ 5 \end{smallmatrix} \right]$	$\left[\begin{smallmatrix} (-5)3 \\ 5 \end{smallmatrix} \right]$	$\left[\begin{smallmatrix} (-5)4 \\ 6 \end{smallmatrix} \right]$	$\left[\begin{smallmatrix} (-5)5 \\ 6 \end{smallmatrix} \right]$	$\left[\begin{smallmatrix} (-5)7 \\ 6 \end{smallmatrix} \right]$						
5	0.61059	734	0.69774	083	0.78485	586	0.87194	199	0.95899	964	1.04603	012
15	0.60849	557	0.69467	152	0.78059	337	0.86625	642	0.95166	385	1.03682	664
25	0.60451	051	0.68883	790	0.77247	109	0.85539	342	0.93760	971	1.01914	662
35	0.59906	618	0.68083	664	0.76128	304	0.84036	234	0.91807	186	0.99445	152
45	0.59276	408	0.67152	549	0.74818	650	0.82265	424	0.89489	714	0.96495	146
55	0.58633	563	0.66196	758	0.73464	525	0.80419	500	0.87052	066	0.93361	692
65	0.58057	051	0.65333	844	0.72232	215	0.78723	820	0.84788	276	0.90415	063
75	0.57621	910	0.64678	548	0.71289	304	0.77414	195	0.83019	625	0.88079	972
85	0.57387	732	0.64324	351	0.70776	799	0.76697	232	0.82042	232	0.86773	361

Table 17.6

ELLIPTIC INTEGRAL OF THE SECOND KIND $E(\varphi|\alpha)$

$$E(\varphi|\alpha) = \int_0^\varphi (1 - \sin^2 \alpha \sin^2 \theta)^{\frac{1}{2}} d\theta$$

$\alpha \setminus \varphi$	65°	70°	75°	80°	85°	90°
0°	1.13446 401	1.22173 048	1.30899 694	1.39626 340	1.48352 986	1.57079 633
2	1.13423 517	1.22145 628	1.30867 442	1.39589 024	1.48310 448	1.57031 792
4	1.13354 929	1.22063 443	1.30770 767	1.39477 165	1.48182 929	1.56888 372
6	1.13240 837	1.21926 717	1.30609 916	1.39291 030	1.47970 717	1.56649 679
8	1.13081 573	1.21735 820	1.30385 297	1.39031 062	1.47674 288	1.56316 223
10	1.12877 602	1.21491 274	1.30097 484	1.38697 886	1.47294 312	1.55888 720
12	1.12629 522	1.21193 748	1.29747 215	1.38292 302	1.46831 652	1.55368 089
14	1.12338 066	1.20844 065	1.29335 393	1.37815 292	1.46287 363	1.54755 458
16	1.12004 099	1.20443 195	1.28863 089	1.37268 017	1.45662 693	1.54052 157
18	1.11628 624	1.19992 262	1.28331 541	1.36651 823	1.44959 085	1.53259 729
20	1.11212 778	1.19492 542	1.27742 153	1.35968 233	1.44178 179	1.52379 921
22	1.10757 834	1.18945 465	1.27096 502	1.35218 961	1.43321 813	1.51414 692
24	1.10265 204	1.18352 618	1.26396 337	1.34405 903	1.42392 023	1.50366 214
26	1.09736 439	1.17715 743	1.25643 578	1.33531 146	1.41391 049	1.49236 871
28	1.09173 228	1.17036 745	1.24840 326	1.32596 967	1.40321 335	1.48029 266
30	1.08577 404	1.16317 686	1.23988 858	1.31605 841	1.39185 532	1.46746 221
32	1.07950 942	1.15560 796	1.23091 635	1.30560 436	1.37986 503	1.45390 780
34	1.07295 961	1.14768 469	1.22151 305	1.29463 629	1.36727 328	1.43966 215
36	1.06614 728	1.13943 273	1.21170 705	1.28318 499	1.35411 306	1.42476 031
38	1.05909 660	1.13087 946	1.20152 870	1.27128 343	1.34041 965	1.40923 972
40	1.05183 322	1.12205 408	1.19101 036	1.25896 675	1.32623 066	1.39314 025
42	1.04438 435	1.11298 760	1.18018 648	1.24627 240	1.31158 614	1.37650 433
44	1.03677 875	1.10371 291	1.16909 366	1.23324 019	1.29652 865	1.35937 700
46	1.02904 677	1.09426 484	1.15777 077	1.21991 241	1.28110 340	1.34180 606
48	1.02122 034	1.08468 023	1.14625 899	1.20633 398	1.26535 837	1.32384 218
50	1.01333 305	1.07499 796	1.13460 200	1.19255 255	1.24934 449	1.30553 909
52	1.00542 010	1.06525 908	1.12284 604	1.17861 873	1.23311 580	1.28695 374
54	0.99751 835	1.05550 682	1.11104 010	1.16458 621	1.21672 971	1.26814 653
56	0.98966 632	1.04578 671	1.09923 604	1.15051 210	1.20024 724	1.24918 162
58	0.98190 414	1.03614 663	1.08748 883	1.13645 710	1.18373 339	1.23012 722
60	0.97427 354	1.02663 689	1.07585 669	1.12248 590	1.16725 747	1.21105 603
62	0.96681 780	1.01731 023	1.06440 132	1.10866 752	1.15089 364	1.19204 568
64	0.95958 158	1.00822 192	1.05318 814	1.09507 580	1.13472 145	1.17317 938
66	0.95261 084	0.99942 966	1.04228 653	1.08178 986	1.11882 658	1.15454 668
68	0.94595 256	0.99099 354	1.03176 998	1.06889 476	1.10330 172	1.13624 437
70	0.93965 447	0.98297 583	1.02171 634	1.05648 221	1.08824 773	1.11837 774
72	0.93376 462	0.97544 068	1.01220 781	1.04465 133	1.07377 505	1.10106 217
74	0.92833 088	0.96845 360	1.00333 091	1.03350 951	1.06000 556	1.08442 522
76	0.92340 024	0.96208 074	0.99517 606	1.02317 331	1.04707 504	1.06860 953
78	0.91901 802	0.95638 776	0.98783 670	1.01376 904	1.03513 640	1.05377 692
80	0.91522 691	0.95143 847	0.98140 781	1.00543 295	1.02436 393	1.04011 440
82	0.91206 588	0.94729 297	0.97598 331	0.99831 000	1.01495 896	1.02784 362
84	0.90956 905	0.94400 544	0.97165 228	0.99255 019	1.00715 650	1.01723 692
86	0.90776 445	0.94162 171	0.96849 392	0.98830 025	1.00123 026	1.00864 796
88	0.90667 305	0.94017 677	0.96657 142	0.98568 915	0.99748 392	1.00258 409
90	0.90630 779	0.93969 262	0.96592 583	0.98480 775	0.99619 470	1.00000 000
	$\left[\begin{smallmatrix} (-5)9 \\ 6 \end{smallmatrix} \right]$	$\left[\begin{smallmatrix} (-4)1 \\ 7 \end{smallmatrix} \right]$	$\left[\begin{smallmatrix} (-4)2 \\ 7 \end{smallmatrix} \right]$	$\left[\begin{smallmatrix} (-4)2 \\ 9 \end{smallmatrix} \right]$	$\left[\begin{smallmatrix} (-4)3 \\ 9 \end{smallmatrix} \right]$	$\left[\begin{smallmatrix} (-4)4 \\ 10 \end{smallmatrix} \right]$
5	1.13303 553	1.22001 878	1.30698 342	1.39393 358	1.48087 384	1.56780 907
15	1.12176 337	1.20649 962	1.29106 728	1.37550 358	1.45984 990	1.54415 050
25	1.10005 236	1.18039 569	1.26026 405	1.33976 099	1.41900 286	1.49811 493
35	1.06958 479	1.14359 813	1.21665 853	1.28896 903	1.36076 208	1.43229 097
45	1.03292 660	1.09900 829	1.16345 846	1.22661 050	1.28885 906	1.35064 388
55	0.99358 365	1.05063 981	1.10513 448	1.15755 065	1.20849 656	1.25867 963
65	0.95606 011	1.00378 508	1.04769 389	1.08838 943	1.12673 373	1.16382 796
75	0.92579 978	0.96518 626	0.99915 744	1.02823 305	1.05342 632	1.07640 511
85	0.90857 873	0.94269 813	0.96992 212	0.99022 779	1.00394 027	1.01266 351

JACOBIAN ZETA FUNCTION $Z(\varphi|\alpha)$

Table 17.7

$K(\alpha)Z(\varphi|\alpha) = K(\alpha)E(\varphi|\alpha) - E(\alpha)F(\varphi|\alpha)$
 $K(90^\circ)Z(\varphi|\alpha) = K(90^\circ)Z(u|1) = K(90^\circ) \tanh u = \infty$ for all u

$\alpha \setminus \varphi$	0°	5°	10°	15°	20°	25°	30°
0°	0	0.000000	0.000000	0.000000	0.000000	0.000000	0.000000
2	0	0.000083	0.000164	0.000239	0.000308	0.000367	0.000414
4	0	0.000332	0.000655	0.000957	0.001231	0.001467	0.001658
6	0	0.000748	0.001474	0.002155	0.002770	0.003302	0.003734
8	0	0.001331	0.002621	0.003832	0.004928	0.005875	0.006644
10	0	0.002080	0.004098	0.005992	0.007706	0.009188	0.010393
12	0	0.002997	0.005905	0.008635	0.011107	0.013246	0.014987
14	0	0.004082	0.008043	0.011765	0.015136	0.018055	0.020433
16	0	0.005337	0.010516	0.015384	0.019796	0.023621	0.026740
18	0	0.006761	0.013324	0.019496	0.025094	0.029951	0.033919
20	0	0.008357	0.016470	0.024105	0.031035	0.037055	0.041981
22	0	0.010125	0.019958	0.029216	0.037627	0.044942	0.050941
24	0	0.012067	0.023791	0.034834	0.044878	0.053626	0.060814
26	0	0.014186	0.027972	0.040968	0.052799	0.063119	0.071617
28	0	0.016483	0.032508	0.047624	0.061401	0.073438	0.083373
30	0	0.018962	0.037403	0.054811	0.070696	0.084599	0.096103
32	0	0.021625	0.042664	0.062540	0.080700	0.096624	0.109834
34	0	0.024476	0.048298	0.070823	0.091430	0.109534	0.124596
36	0	0.027520	0.054315	0.079674	0.102905	0.123356	0.140421
38	0	0.030761	0.060725	0.089108	0.115148	0.138120	0.157347
40	0	0.034205	0.067540	0.099145	0.128185	0.153860	0.175418
42	0	0.037860	0.074774	0.109807	0.142046	0.170614	0.194683
44	0	0.041734	0.082444	0.121118	0.156765	0.188428	0.215197
46	0	0.045835	0.090569	0.133109	0.172383	0.207353	0.237025
48	0	0.050177	0.099172	0.145813	0.188947	0.227450	0.260240
50	0	0.054771	0.108280	0.159273	0.206513	0.248789	0.284929
52	0	0.059634	0.117925	0.173536	0.225145	0.271452	0.311193
54	0	0.064786	0.128146	0.188661	0.244921	0.295538	0.339150
56	0	0.070249	0.138989	0.204716	0.265933	0.321161	0.368940
58	0	0.076052	0.150510	0.221785	0.288294	0.348462	0.400731
60	0	0.082227	0.162776	0.239971	0.312138	0.377610	0.434726
62	0	0.088818	0.175872	0.259398	0.337632	0.408811	0.471170
64	0	0.095876	0.189901	0.280221	0.364981	0.442321	0.510371
66	0	0.103468	0.204994	0.302637	0.394446	0.478462	0.552710
68	0	0.111676	0.221320	0.326895	0.426356	0.517644	0.598675
70	0	0.120612	0.239097	0.353322	0.461145	0.560402	0.648900
72	0	0.130420	0.258615	0.382351	0.499384	0.607444	0.704225
74	0	0.141301	0.280272	0.414575	0.541857	0.659739	0.765797
76	0	0.153537	0.304631	0.450832	0.589673	0.718657	0.835238
78	0	0.167542	0.332519	0.492356	0.644462	0.786214	0.914934
80	0	0.183967	0.365230	0.541075	0.708771	0.865556	1.008608
82	0	0.203902	0.404937	0.600229	0.786884	0.961976	1.122523
84	0	0.229402	0.455734	0.675918	0.886859	1.085434	1.268462
86	0	0.265091	0.526833	0.781873	1.026844	1.258352	1.472953
88	0	0.325753	0.647691	0.962000	1.264856	1.552420	1.820811
90	∞	∞	∞	∞	∞	∞	∞
5	0	0.000519	0.001023	0.001496	0.001923	0.002292	0.002592
15	0	0.004688	0.009238	0.013513	0.017387	0.020743	0.023479
25	0	0.013105	0.025838	0.037836	0.048754	0.058271	0.066098
35	0	0.025973	0.051258	0.075176	0.097073	0.116329	0.132373
45	0	0.043755	0.086448	0.127026	0.164459	0.197748	0.225942
55	0	0.067477	0.133487	0.196567	0.255266	0.308149	0.353807
65	0	0.099601	0.197305	0.291216	0.379430	0.460039	0.531121
75	0	0.147228	0.292070	0.432134	0.565011	0.688264	0.799407
85	0	0.245478	0.487761	0.723644	0.949910	1.163313	1.360551

See Example 16.

Compiled from P.F. Byrd and M.D. Friedman, Handbook of elliptic integrals for engineers and physicists, Springer-Verlag, Berlin, Germany, 1954 (with permission).

Table 17.7

JACOBIAN ZETA FUNCTION $Z(\phi|\alpha)$

$$K(\alpha)Z(\phi|\alpha) = K(\alpha)E(\phi|\alpha) - E(\alpha)F(\phi|\alpha)$$

$$K(90^\circ)Z(\phi|\alpha) = K(90^\circ)Z(u|1) = K(90^\circ) \tanh u = \infty \text{ for all } u$$

$\alpha \setminus \phi$	35°	40°	45°	50°	55°	60°
0°	0.000000	0.000000	0.000000	0.000000	0.000000	0.000000
2	0.000450	0.000471	0.000479	0.000471	0.000450	0.000415
4	0.001800	0.001886	0.001916	0.001887	0.001800	0.001659
6	0.004052	0.004248	0.004314	0.004250	0.004056	0.003739
8	0.007212	0.007561	0.007681	0.007567	0.007224	0.006660
10	0.011284	0.011833	0.012023	0.011849	0.011313	0.010433
12	0.016276	0.017073	0.017353	0.017106	0.016337	0.015070
14	0.022197	0.023293	0.023683	0.023354	0.022312	0.020588
16	0.029060	0.030505	0.031029	0.030610	0.029257	0.027006
18	0.036876	0.038728	0.039411	0.038897	0.037194	0.034347
20	0.045662	0.047979	0.048850	0.048238	0.046150	0.042639
22	0.055435	0.058279	0.059372	0.058663	0.056156	0.051912
24	0.066216	0.069655	0.071005	0.070203	0.067246	0.062203
26	0.078026	0.082132	0.083783	0.082895	0.079461	0.073551
28	0.090893	0.095744	0.097742	0.096782	0.092844	0.086003
30	0.104844	0.110525	0.112924	0.111909	0.107447	0.099613
32	0.119914	0.126515	0.129375	0.128330	0.123327	0.114438
34	0.136138	0.143758	0.147147	0.146103	0.140549	0.130548
36	0.153557	0.162305	0.166300	0.165296	0.159186	0.148018
38	0.172220	0.182211	0.186898	0.185983	0.179319	0.166934
40	0.192178	0.203541	0.209016	0.208248	0.201042	0.187395
42	0.213492	0.226365	0.232738	0.232187	0.224459	0.209512
44	0.236228	0.250764	0.258158	0.257907	0.249691	0.233413
46	0.260466	0.276831	0.285383	0.285531	0.276871	0.259243
48	0.286295	0.304671	0.314535	0.315196	0.306156	0.287169
50	0.313816	0.334405	0.345755	0.347064	0.337723	0.317383
52	0.343151	0.366173	0.379203	0.381317	0.371776	0.350108
54	0.374438	0.400138	0.415067	0.418166	0.408552	0.385601
56	0.407844	0.436490	0.453565	0.457861	0.448328	0.424167
58	0.443565	0.475457	0.494956	0.500691	0.491428	0.466161
60	0.481836	0.517310	0.539547	0.547003	0.538238	0.512007
62	0.522947	0.562378	0.587709	0.597211	0.589220	0.562214
64	0.567251	0.611064	0.639896	0.651822	0.644933	0.617399
66	0.615191	0.663870	0.696670	0.711460	0.706068	0.678320
68	0.667330	0.721434	0.758741	0.776910	0.773487	0.745922
70	0.724397	0.784577	0.827024	0.849178	0.848294	0.821411
72	0.787359	0.854390	0.902728	0.929590	0.931931	0.906356
74	0.857536	0.932355	0.987491	1.019938	1.026343	1.002860
76	0.936789	1.020563	1.083621	1.122735	1.134246	1.113848
78	1.027859	1.122089	1.194508	1.241670	1.259612	1.243568
80	1.135017	1.241721	1.325428	1.382470	1.408589	1.398577
82	1.265447	1.387516	1.485245	1.554749	1.591484	1.589820
84	1.432669	1.574623	1.690632	1.776579	1.827639	1.837791
86	1.667113	1.837147	1.979107	2.088611	2.160541	2.188502
88	2.066078	2.284127	2.470622	2.620801	2.729164	2.788909
90	∞	∞	∞	∞	∞	∞
5	0.002813	0.002948	0.002994	0.002949	0.002815	0.002594
15	0.025510	0.026774	0.027228	0.026855	0.025662	0.023683
25	0.071991	0.075754	0.077249	0.076403	0.073210	0.067742
35	0.144695	0.152865	0.156547	0.155518	0.149686	0.139108
45	0.248154	0.263583	0.271538	0.271473	0.263028	0.246077
55	0.390865	0.418002	0.433972	0.437641	0.428046	0.404479
65	0.590735	0.636916	0.667669	0.680968	0.674774	0.647089
75	0.895883	0.975016	1.033955	1.069585	1.078397	1.056317
85	1.538234	1.692810	1.820471	1.916972	1.977347	1.995386

JACOBIAN ZETA FUNCTION $Z(\varphi|\alpha)$

Table 17.7

$$K(\alpha)Z(\varphi|\alpha) = K(\alpha)E(\varphi|\alpha) - E(\alpha)F(\varphi|\alpha)$$

$$K(90^\circ)Z(\varphi|\alpha) = K(90^\circ)Z(u|1) = K(90^\circ) \tanh u = \infty \text{ for all } u$$

$\alpha \setminus \varphi$	65°	70°	75°	80°	85°	90°
0°	0.000000	0.000000	0.000000	0.000000	0.000000	0
2	0.000367	0.000308	0.000239	0.000164	0.000083	0
4	0.001468	0.001232	0.000958	0.000656	0.000333	0
6	0.003308	0.002776	0.002160	0.001477	0.000750	0
8	0.005893	0.004946	0.003849	0.002633	0.001337	0
10	0.009233	0.007751	0.006032	0.004127	0.002096	0
12	0.013341	0.011202	0.008718	0.005966	0.003030	0
14	0.018231	0.015312	0.011920	0.008158	0.004143	0
16	0.023922	0.020098	0.015649	0.010713	0.005442	0
18	0.030438	0.025581	0.019924	0.013642	0.006930	0
20	0.037803	0.031783	0.024763	0.016959	0.008617	0
22	0.046047	0.038732	0.030188	0.020680	0.010509	0
24	0.055206	0.046459	0.036225	0.024823	0.012617	0
26	0.065319	0.055000	0.042905	0.029411	0.014952	0
28	0.076431	0.064397	0.050260	0.034466	0.017526	0
30	0.088594	0.074696	0.058332	0.040018	0.020354	0
32	0.101867	0.085951	0.067164	0.046099	0.023454	0
34	0.116315	0.098224	0.076808	0.052747	0.026845	0
36	0.132015	0.111585	0.087324	0.060004	0.030550	0
38	0.149053	0.126114	0.098779	0.067920	0.034595	0
40	0.167527	0.141905	0.111254	0.076554	0.039011	0
42	0.187551	0.159064	0.124839	0.085973	0.043833	0
44	0.209254	0.177713	0.139641	0.096255	0.049104	0
46	0.232785	0.197996	0.155784	0.107493	0.054874	0
48	0.258315	0.220078	0.173414	0.119798	0.061201	0
50	0.286045	0.244154	0.192704	0.133299	0.068157	0
52	0.316206	0.270454	0.213858	0.148154	0.075826	0
54	0.349070	0.299246	0.237121	0.164550	0.084312	0
56	0.384960	0.330854	0.262789	0.182720	0.093745	0
58	0.424255	0.365664	0.291220	0.202947	0.104281	0
60	0.467411	0.404143	0.322854	0.225584	0.116121	0
62	0.514976	0.446860	0.358236	0.251076	0.129521	0
64	0.567621	0.494517	0.398048	0.279993	0.144812	0
66	0.626169	0.547987	0.443155	0.313069	0.162430	0
68	0.691653	0.608372	0.494668	0.351277	0.182965	0
70	0.765385	0.677086	0.554038	0.395917	0.207230	0
72	0.849072	0.755975	0.623195	0.448779	0.236382	0
74	0.944993	0.847508	0.704762	0.512376	0.272114	0
76	1.056298	0.955095	0.802400	0.590350	0.317015	0
78	1.187535	1.083634	0.921408	0.688163	0.375226	0
80	1.345674	1.240571	1.069839	0.814374	0.453784	0
82	1.542281	1.438150	1.260828	0.983236	0.565578	0
84	1.798909	1.698985	1.518315	1.220780	0.736684	0
86	2.163806	2.073357	1.894760	1.583040	1.028059	0
88	2.790834	2.721008	2.555104	2.241393	1.628299	0
90	∞	∞	∞	∞	∞	∞
5	0.002295	0.001926	0.001498	0.001025	0.000520	0
15	0.020975	0.017619	0.013718	0.009390	0.004769	0
25	0.060141	0.050625	0.039483	0.027060	0.013755	0
35	0.124003	0.104764	0.081953	0.056296	0.028657	0
45	0.220781	0.187640	0.147536	0.101748	0.051923	0
55	0.366615	0.314676	0.249634	0.173397	0.088901	0
65	0.596098	0.520463	0.419877	0.295957	0.153297	0
75	0.998480	0.899033	0.751288	0.549278	0.293208	0
85	1.962673	1.866624	1.686113	1.380465	0.860811	0

Table 17.8 HEUMAN'S LAMBDA FUNCTION $\Lambda_0(\varphi|\alpha)$

$$\Lambda_0(\varphi|\alpha) = \frac{F(\varphi|90^\circ - \alpha)}{K'(\alpha)} + \frac{2}{\pi} K(\alpha) Z(\varphi|90^\circ - \alpha) = \frac{2}{\pi} \{ K(\alpha) E(\varphi|90^\circ - \alpha) - [K(\alpha) - E(\alpha)] F(\varphi|90^\circ - \alpha) \}$$

$\alpha \setminus \varphi$	0°	5°	10°	15°	20°	25°	30°
0°	0	0.087156	0.173648	0.258819	0.342020	0.422618	0.500000
2	0	0.087129	0.173595	0.258740	0.341916	0.422490	0.499848
4	0	0.087050	0.173437	0.258504	0.341604	0.422104	0.499391
6	0	0.086917	0.173173	0.258111	0.341084	0.421462	0.498633
8	0	0.086732	0.172804	0.257562	0.340359	0.420566	0.497574
10	0	0.086495	0.172332	0.256858	0.339430	0.419419	0.496219
12	0	0.086206	0.171757	0.256001	0.338299	0.418024	0.494572
14	0	0.085866	0.171080	0.254994	0.336969	0.416385	0.492638
16	0	0.085476	0.170303	0.253838	0.335445	0.414506	0.490424
18	0	0.085037	0.169429	0.252536	0.333729	0.412394	0.487937
20	0	0.084549	0.168458	0.251092	0.331827	0.410054	0.485184
22	0	0.084013	0.167393	0.249509	0.329743	0.407492	0.482176
24	0	0.083432	0.166236	0.247790	0.327483	0.404717	0.478920
26	0	0.082806	0.164991	0.245941	0.325052	0.401736	0.475428
28	0	0.082136	0.163661	0.243966	0.322458	0.398558	0.471710
30	0	0.081425	0.162247	0.241870	0.319707	0.395191	0.467777
32	0	0.080674	0.160755	0.239657	0.316806	0.391645	0.463642
34	0	0.079884	0.159187	0.237335	0.313764	0.387930	0.459316
36	0	0.079058	0.157548	0.234908	0.310587	0.384057	0.454813
38	0	0.078198	0.155842	0.232383	0.307286	0.380037	0.450147
40	0	0.077307	0.154073	0.229767	0.303869	0.375880	0.445330
42	0	0.076385	0.152246	0.227068	0.300346	0.371600	0.440378
44	0	0.075436	0.150367	0.224292	0.296727	0.367209	0.435306
46	0	0.074463	0.148439	0.221447	0.293022	0.362720	0.430127
48	0	0.073469	0.146470	0.218543	0.289242	0.358145	0.424860
50	0	0.072455	0.144464	0.215587	0.285399	0.353500	0.419519
52	0	0.071426	0.142428	0.212589	0.281505	0.348799	0.414121
54	0	0.070385	0.140370	0.209558	0.277573	0.344057	0.408685
56	0	0.069336	0.138295	0.206506	0.273616	0.339290	0.403228
58	0	0.068281	0.136211	0.203443	0.269648	0.334516	0.397769
60	0	0.067226	0.134126	0.200380	0.265684	0.329751	0.392328
62	0	0.066175	0.132049	0.197331	0.261739	0.325015	0.386926
64	0	0.065131	0.129989	0.194307	0.257832	0.320328	0.381586
66	0	0.064100	0.127955	0.191324	0.253979	0.315710	0.376331
68	0	0.063088	0.125958	0.188396	0.250200	0.311185	0.371186
70	0	0.062100	0.124009	0.185540	0.246517	0.306778	0.366180
72	0	0.061143	0.122121	0.182774	0.242952	0.302515	0.361342
74	0	0.060223	0.120307	0.180119	0.239531	0.298427	0.356706
76	0	0.059348	0.118583	0.177596	0.236282	0.294547	0.352309
78	0	0.058528	0.116967	0.175231	0.233238	0.290914	0.348194
80	0	0.057773	0.115479	0.173054	0.230436	0.287571	0.344410
82	0	0.057095	0.114143	0.171099	0.227922	0.284573	0.341017
84	0	0.056508	0.112988	0.169410	0.225750	0.281983	0.338088
86	0	0.056034	0.112053	0.168043	0.223992	0.279887	0.335718
88	0	0.055698	0.111392	0.167078	0.222751	0.278408	0.334046
90	0	0.055556	0.111111	0.166667	0.222222	0.277778	0.333333
		$\begin{bmatrix} (-5)2 \\ 5 \end{bmatrix}$	$\begin{bmatrix} (-5)5 \\ 5 \end{bmatrix}$	$\begin{bmatrix} (-5)7 \\ 6 \end{bmatrix}$	$\begin{bmatrix} (-5)9 \\ 6 \end{bmatrix}$	$\begin{bmatrix} (-4)1 \\ 6 \end{bmatrix}$	$\begin{bmatrix} (-4)1 \\ 6 \end{bmatrix}$
5	0	0.086990	0.173318	0.258327	0.341370	0.421815	0.499050
15	0	0.085677	0.170704	0.254434	0.336231	0.415475	0.491565
25	0	0.083124	0.165625	0.246882	0.326288	0.403252	0.477203
35	0	0.079476	0.158377	0.236134	0.312192	0.386013	0.457086
45	0	0.074953	0.149408	0.222878	0.294884	0.364976	0.432729
55	0	0.069861	0.139334	0.208034	0.275597	0.341676	0.405958
65	0	0.064614	0.128968	0.192809	0.255897	0.318009	0.378946
75	0	0.059779	0.119433	0.178839	0.237883	0.296459	0.354475
85	0	0.056256	0.112490	0.168682	0.224814	0.280867	0.336826

Compiled from C. Heuman, Tables of complete elliptic integrals, J. Math. Phys. 20, 127-206, 1941 (with permission).

HEUMAN'S LAMBDA FUNCTION $\Lambda_0(\varphi|\alpha)$

Table 17.8

$$\Lambda_0(\varphi|\alpha) = \frac{F(\varphi|90^\circ - \alpha)}{K'(\alpha)} + \frac{2}{\pi} K(\alpha) Z(\varphi|90^\circ - \alpha) = \frac{2}{\pi} \{K(\alpha) E(\varphi|90^\circ - \alpha) - [K(\alpha) - E(\alpha)] F(\varphi|90^\circ - \alpha)\};$$

$\alpha \setminus \varphi$	35°	40°	45°	50°	55°	60°
0°	0.573576	0.642788	0.707107	0.766044	0.819152	0.866025
2	0.573402	0.642592	0.706891	0.765811	0.818903	0.865762
4	0.572878	0.642006	0.706247	0.765113	0.818157	0.864975
6	0.572009	0.641032	0.705177	0.763956	0.816922	0.863674
8	0.570795	0.639674	0.703687	0.762347	0.815210	0.861876
10	0.569244	0.637940	0.701786	0.760298	0.813034	0.859602
12	0.567360	0.635836	0.699484	0.757822	0.810416	0.856877
14	0.565150	0.633373	0.696794	0.754937	0.807375	0.853731
16	0.562623	0.630561	0.693729	0.751660	0.803935	0.850194
18	0.559789	0.627412	0.690306	0.748011	0.800123	0.846297
20	0.556657	0.623939	0.686540	0.744012	0.795963	0.842073
22	0.553238	0.620157	0.682450	0.739683	0.791483	0.837553
24	0.549546	0.616080	0.678054	0.735049	0.786709	0.832766
26	0.545591	0.611725	0.673372	0.730130	0.781667	0.827743
28	0.541389	0.607107	0.668422	0.724951	0.776384	0.822510
30	0.536953	0.602244	0.663225	0.719533	0.770883	0.817093
32	0.532297	0.597153	0.657801	0.713900	0.765190	0.811517
34	0.527437	0.591851	0.652170	0.708073	0.759326	0.805804
36	0.522388	0.586356	0.646351	0.702074	0.753314	0.799976
38	0.517165	0.580687	0.640365	0.695923	0.747177	0.794052
40	0.511786	0.574862	0.634231	0.689642	0.740932	0.788051
42	0.506266	0.568898	0.627970	0.683251	0.734602	0.781992
44	0.500622	0.562815	0.621600	0.676769	0.728203	0.775891
46	0.494873	0.556632	0.615142	0.670217	0.721756	0.769764
48	0.489034	0.550366	0.608615	0.663613	0.715277	0.763627
50	0.483125	0.544038	0.602038	0.656976	0.708785	0.757496
52	0.477164	0.537668	0.595432	0.650326	0.702298	0.751385
54	0.471170	0.531275	0.588817	0.643682	0.695832	0.745310
56	0.465163	0.524879	0.582212	0.637064	0.689405	0.739286
58	0.459163	0.518502	0.575640	0.630491	0.683037	0.733329
60	0.453192	0.512167	0.569122	0.623985	0.676745	0.727455
62	0.447272	0.505895	0.562680	0.617567	0.670549	0.721680
64	0.441428	0.499711	0.556339	0.611258	0.664469	0.716024
66	0.435683	0.493642	0.550124	0.605085	0.658528	0.710504
68	0.430065	0.487715	0.544062	0.599072	0.652749	0.705142
70	0.424604	0.481959	0.538183	0.593247	0.647159	0.699961
72	0.419332	0.476408	0.532519	0.587641	0.641784	0.694985
74	0.414284	0.471098	0.527106	0.582290	0.636659	0.690244
76	0.409500	0.466070	0.521985	0.577231	0.631818	0.685770
78	0.405026	0.461371	0.517202	0.572511	0.627303	0.681601
80	0.400915	0.457055	0.512813	0.568181	0.623166	0.677782
82	0.397229	0.453189	0.508883	0.564307	0.619464	0.674368
84	0.394049	0.449853	0.505494	0.560967	0.616276	0.671427
86	0.391477	0.447157	0.502754	0.558268	0.613700	0.669053
88	0.389662	0.445255	0.500823	0.556366	0.611884	0.667379
90	0.388889	0.444444	0.500000	0.555556	0.611111	0.666667
	$\left[\begin{smallmatrix} (-4)1 \\ 6 \end{smallmatrix} \right]$	$\left[\begin{smallmatrix} (-4)1 \\ 6 \end{smallmatrix} \right]$	$\left[\begin{smallmatrix} (-4)1 \\ 6 \end{smallmatrix} \right]$	$\left[\begin{smallmatrix} (-4)1 \\ 6 \end{smallmatrix} \right]$	$\left[\begin{smallmatrix} (-4)1 \\ 6 \end{smallmatrix} \right]$	$\left[\begin{smallmatrix} (-4)1 \\ 6 \end{smallmatrix} \right]$
5	0.572487	0.641567	0.705765	0.764592	0.817600	0.864388
15	0.563926	0.632010	0.695307	0.753346	0.805703	0.852010
25	0.547600	0.613936	0.675748	0.732623	0.784220	0.830282
35	0.524935	0.589127	0.649283	0.705094	0.756337	0.802903
45	0.497760	0.559735	0.618381	0.673501	0.724985	0.772830
55	0.468167	0.528076	0.585512	0.640369	0.692612	0.742291
65	0.438541	0.496661	0.553214	0.608153	0.661480	0.713246
75	0.411857	0.468546	0.524506	0.579721	0.634200	0.687972
85	0.392679	0.448417	0.504034	0.559529	0.614903	0.670162

Table 17.8

HEUMAN'S LAMBDA FUNCTION $\Lambda_0(\varphi|\alpha)$

$$\Lambda_0(\varphi|\alpha) = \frac{F(\varphi|90^\circ - \alpha)}{K'(\alpha)} + \frac{2}{\pi} K(\alpha) Z(\varphi|90^\circ - \alpha)$$

$$= \frac{2}{\pi} \{K(\alpha) E(\varphi|90^\circ - \alpha) - [K(\alpha) - E(\alpha)] F(\varphi|90^\circ - \alpha)\}$$

$\alpha \backslash \varphi$	65°	70°	75°	80°	85°	90°
0°	0.906308	0.939693	0.965926	0.984808	0.996195	1
2	0.906032	0.939407	0.965633	0.984511	0.995903	1
4	0.905210	0.938559	0.964769	0.983652	0.995130	1
6	0.903857	0.937172	0.963376	0.982315	0.994063	1
8	0.901997	0.935282	0.961512	0.980599	0.992833	1
10	0.899660	0.932934	0.959244	0.978597	0.991511	1
12	0.896881	0.930177	0.956638	0.976384	0.990135	1
14	0.893699	0.927061	0.953755	0.974016	0.988727	1
16	0.890152	0.923634	0.950646	0.971534	0.987299	1
18	0.886280	0.919940	0.947355	0.968969	0.985858	1
20	0.882119	0.916018	0.943918	0.966343	0.984410	1
22	0.877704	0.911904	0.940364	0.963671	0.982958	1
24	0.873068	0.907630	0.936718	0.960968	0.981506	1
26	0.868240	0.903221	0.933000	0.958241	0.980054	1
28	0.863249	0.898703	0.929226	0.955500	0.978604	1
30	0.858117	0.894095	0.925409	0.952751	0.977159	1
32	0.852869	0.889416	0.921563	0.949998	0.975719	1
34	0.847523	0.884681	0.917695	0.947247	0.974286	1
36	0.842100	0.879904	0.913817	0.944502	0.972861	1
38	0.836615	0.875099	0.909935	0.941766	0.971445	1
40	0.831085	0.870277	0.906056	0.939042	0.970039	1
42	0.825524	0.865449	0.902188	0.936335	0.968644	1
44	0.819946	0.860625	0.898337	0.933647	0.967262	1
46	0.814365	0.855814	0.894508	0.930981	0.965894	1
48	0.808792	0.851026	0.890708	0.928341	0.964540	1
50	0.803241	0.846269	0.886942	0.925731	0.963204	1
52	0.797724	0.841553	0.883216	0.923152	0.961885	1
54	0.792252	0.836887	0.879537	0.920610	0.960586	1
56	0.786839	0.832280	0.875911	0.918108	0.959309	1
58	0.781496	0.827742	0.872345	0.915649	0.958055	1
60	0.776237	0.823283	0.868846	0.913240	0.956826	1
62	0.771077	0.818913	0.865421	0.910884	0.955626	1
64	0.766029	0.814645	0.862080	0.908588	0.954457	1
66	0.761110	0.810490	0.858831	0.906357	0.953321	1
68	0.756338	0.806464	0.855685	0.904198	0.952223	1
70	0.751731	0.802581	0.852654	0.902119	0.951166	1
72	0.747312	0.798860	0.849751	0.900129	0.950154	1
74	0.743104	0.795319	0.846990	0.898237	0.949193	1
76	0.739137	0.791983	0.844390	0.896456	0.948288	1
78	0.735442	0.788877	0.841972	0.894800	0.947446	1
80	0.732059	0.786036	0.839759	0.893286	0.946677	1
82	0.729036	0.783497	0.837783	0.891933	0.945990	1
84	0.726434	0.781312	0.836083	0.890770	0.945400	1
86	0.724333	0.779549	0.834711	0.889831	0.944923	1
88	0.722852	0.778307	0.833745	0.889170	0.944587	1
90	0.722222 $\left[\begin{smallmatrix} (-4)1 \\ 6 \end{smallmatrix} \right]$	0.777778 $\left[\begin{smallmatrix} (-5)9 \\ 6 \end{smallmatrix} \right]$	0.833333 $\left[\begin{smallmatrix} (-5)7 \\ 6 \end{smallmatrix} \right]$	0.888889 $\left[\begin{smallmatrix} (-5)5 \\ 5 \end{smallmatrix} \right]$	0.944444 $\left[\begin{smallmatrix} (-5)2 \\ 5 \end{smallmatrix} \right]$	1
5	0.904599	0.937930	0.964135	0.983037	0.994624	1
15	0.891969	0.925384	0.952226	0.972787	0.988015	1
25	0.870676	0.905441	0.934867	0.959607	0.980779	1
35	0.844820	0.882297	0.915757	0.945873	0.973573	1
45	0.817155	0.858217	0.896419	0.932311	0.966576	1
55	0.789537	0.834576	0.877717	0.919353	0.959944	1
65	0.763552	0.812552	0.860443	0.907464	0.953885	1
75	0.741089	0.793624	0.845669	0.897332	0.948733	1
85	0.725315	0.780373	0.835352	0.890270	0.945145	1

ELLIPTIC INTEGRAL OF THE THIRD KIND $\Pi(n; \phi|\alpha)$

Table 17.9

$$\Pi(n; \phi|\alpha) = \int_0^\phi (1 - n \sin^2 \theta)^{-1} [1 - \sin^2 \alpha \sin^2 \theta]^{-\frac{1}{2}} d\theta$$

n	$\alpha \setminus \phi$	0°	15°	30°	45°	60°	75°	90°
0.0	0°	0	0.26180	0.52360	0.78540	1.04720	1.30900	1.57080
0.0	15	0	0.26200	0.52513	0.79025	1.05774	1.32733	1.59814
0.0	30	0	0.26254	0.52943	0.80437	1.08955	1.38457	1.68575
0.0	45	0	0.26330	0.53562	0.82602	1.14243	1.48788	1.85407
0.0	60	0	0.26406	0.54223	0.85122	1.21260	1.64918	2.15651
0.0	75	0	0.26463	0.54736	0.87270	1.28371	1.87145	2.76806
0.0	90	0	0.26484	0.54931	0.88137	1.31696	2.02759	∞
0.1	0	0	0.26239	0.52820	0.80013	1.07949	1.36560	1.65576
0.1	15	0	0.26259	0.52975	0.80514	1.09058	1.38520	1.68536
0.1	30	0	0.26314	0.53412	0.81972	1.12405	1.44649	1.78030
0.1	45	0	0.26390	0.54041	0.84210	1.17980	1.55739	1.96326
0.1	60	0	0.26467	0.54712	0.86817	1.25393	1.73121	2.29355
0.1	75	0	0.26524	0.55234	0.89040	1.32926	1.97204	2.96601
0.1	90	0	0.26545	0.55431	0.89939	1.36454	2.14201	∞
0.2	0	0	0.26299	0.53294	0.81586	1.11534	1.43078	1.75620
0.2	15	0	0.26319	0.53452	0.82104	1.12705	1.45187	1.78850
0.2	30	0	0.26374	0.53896	0.83612	1.16241	1.51792	1.89229
0.2	45	0	0.26450	0.54535	0.85928	1.22139	1.63775	2.09296
0.2	60	0	0.26527	0.55217	0.88629	1.30003	1.82643	2.45715
0.2	75	0	0.26585	0.55747	0.90934	1.38016	2.08942	3.20448
0.2	90	0	0.26606	0.55948	0.91867	1.41777	2.27604	∞
0.3	0	0	0.26359	0.53784	0.83271	1.15551	1.50701	1.87746
0.3	15	0	0.26379	0.53945	0.83808	1.16791	1.52988	1.91309
0.3	30	0	0.26434	0.54396	0.85370	1.20543	1.60161	2.02779
0.3	45	0	0.26511	0.55046	0.87771	1.26812	1.73217	2.25038
0.3	60	0	0.26588	0.55739	0.90574	1.35193	1.93879	2.65684
0.3	75	0	0.26646	0.56278	0.92969	1.43759	2.22876	3.49853
0.3	90	0	0.26667	0.56483	0.93938	1.47789	2.43581	∞
0.4	0	0	0.26420	0.54291	0.85084	1.20098	1.59794	2.02789
0.4	15	0	0.26440	0.54454	0.85641	1.21419	1.62298	2.06774
0.4	30	0	0.26495	0.54912	0.87262	1.25419	1.70165	2.19629
0.4	45	0	0.26572	0.55573	0.89756	1.32117	1.84537	2.44683
0.4	60	0	0.26650	0.56278	0.92670	1.41098	2.07413	2.90761
0.4	75	0	0.26708	0.56827	0.95162	1.50309	2.39775	3.87214
0.4	90	0	0.26729	0.57035	0.96171	1.54653	2.63052	∞
0.5	0	0	0.26481	0.54814	0.87042	1.25310	1.70919	2.22144
0.5	15	0	0.26501	0.54980	0.87621	1.26726	1.73695	2.26685
0.5	30	0	0.26557	0.55447	0.89307	1.31017	1.82433	2.41367
0.5	45	0	0.26634	0.56119	0.91902	1.38218	1.98464	2.70129
0.5	60	0	0.26712	0.56837	0.94939	1.47906	2.24155	3.23477
0.5	75	0	0.26770	0.57394	0.97538	1.57881	2.60846	4.36620
0.5	90	0	0.26792	0.57606	0.98591	1.62599	2.87468	∞
0.6	0	0	0.26543	0.55357	0.89167	1.31379	1.85002	2.48365
0.6	15	0	0.26563	0.55525	0.89770	1.32907	1.88131	2.53677
0.6	30	0	0.26619	0.56000	0.91527	1.37544	1.98005	2.70905
0.6	45	0	0.26696	0.56684	0.94235	1.45347	2.16210	3.04862
0.6	60	0	0.26775	0.57414	0.97406	1.55884	2.45623	3.68509
0.6	75	0	0.26833	0.57982	1.00123	1.66780	2.88113	5.05734
0.6	90	0	0.26855	0.58198	1.01225	1.71951	3.19278	∞
			$\left[\begin{smallmatrix} (-5)5 \\ 4 \end{smallmatrix} \right]$	$\left[\begin{smallmatrix} (-4)4 \\ 6 \end{smallmatrix} \right]$	$\left[\begin{smallmatrix} (-3)2 \\ 7 \end{smallmatrix} \right]$	$\left[\begin{smallmatrix} (-3)7 \\ 7 \end{smallmatrix} \right]$		

See Examples 15-20.

Table 17.9

ELLIPTIC INTEGRAL OF THE THIRD KIND $\Pi(n; \varphi \backslash \alpha)$

$$\Pi(n; \varphi \backslash \alpha) = \int_0^\varphi (1 - n \sin^2 \theta)^{-1} [1 - \sin^2 \alpha \sin^2 \theta]^{-\frac{1}{2}} d\theta$$

n	$\alpha \backslash \varphi$	0°	15°	30°	45°	60°	75°	90°
0.7	0°	0	0.26605	0.55918	0.91487	1.38587	2.03720	2.86787
0.7	15	0	0.26625	0.56090	0.92116	1.40251	2.07333	2.93263
0.7	30	0	0.26681	0.56573	0.93952	1.45309	2.18765	3.14339
0.7	45	0	0.26759	0.57270	0.96784	1.53846	2.39973	3.56210
0.7	60	0	0.26838	0.58014	1.00104	1.65425	2.74586	4.35751
0.7	75	0	0.26897	0.58592	1.02954	1.77459	3.25315	6.11030
0.7	90	0	0.26918	0.58812	1.04110	1.83192	3.63042	∞
0.8	0	0	0.26668	0.56501	0.94034	1.47370	2.30538	3.51240
0.8	15	0	0.26688	0.56676	0.94694	1.49205	2.34868	3.59733
0.8	30	0	0.26745	0.57168	0.96618	1.54790	2.48618	3.87507
0.8	45	0	0.26823	0.57877	0.99588	1.64250	2.74328	4.43274
0.8	60	0	0.26902	0.58635	1.03076	1.77145	3.16844	5.51206
0.8	75	0	0.26961	0.59225	1.06073	1.90629	3.80370	7.96669
0.8	90	0	0.26982	0.59449	1.07290	1.97080	4.28518	∞
0.9	0	0	0.26731	0.57106	0.96853	1.58459	2.74439	4.96729
0.9	15	0	0.26752	0.57284	0.97547	1.60515	2.79990	5.09958
0.9	30	0	0.26808	0.57785	0.99569	1.66788	2.97710	5.53551
0.9	45	0	0.26887	0.58508	1.02695	1.77453	3.31210	6.42557
0.9	60	0	0.26966	0.59281	1.06372	1.92081	3.87661	8.20086
0.9	75	0	0.27025	0.59882	1.09535	2.07487	4.74432	12.46407
0.9	90	0	0.27047	0.60110	1.10821	2.14899	5.42125	∞
1.0	0	0	0.26795	0.57735	1.00000	1.73205	3.73205	∞
1.0	15	0	0.26816	0.57916	1.00731	1.75565	3.81655	∞
1.0	30	0	0.26872	0.58428	1.02866	1.82781	4.08864	∞
1.0	45	0	0.26951	0.59165	1.06170	1.95114	4.61280	∞
1.0	60	0	0.27031	0.59953	1.10060	2.12160	5.52554	∞
1.0	75	0	0.27090	0.60566	1.13414	2.30276	7.00372	∞
1.0	90	0	0.27112	0.60799	1.14779	2.39053	8.22356	∞
			$\left[\begin{smallmatrix} (-5)5 \\ 4 \end{smallmatrix} \right]$	$\left[\begin{smallmatrix} (-4)5 \\ 6 \end{smallmatrix} \right]$	$\left[\begin{smallmatrix} (-3)2 \\ 7 \end{smallmatrix} \right]$	$\left[\begin{smallmatrix} (-2)1 \\ 7 \end{smallmatrix} \right]$		

18. Weierstrass Elliptic and Related Functions

THOMAS H. SOUTHARD¹

Contents

	Page
Mathematical Properties	629
18.1. Definitions, Symbolism, Restrictions and Conventions . .	629
18.2. Homogeneity Relations, Reduction Formulas and Processes .	631
18.3. Special Values and Relations	633
18.4. Addition and Multiplication Formulas	635
18.5. Series Expansions	635
18.6. Derivatives and Differential Equations	640
18.7. Integrals	641
18.8. Conformal Mapping	642
18.9. Relations with Complete Elliptic Integrals K and K' and Their Parameter m and with Jacobi's Elliptic Functions .	649
18.10. Relations with Theta Functions	650
18.11. Expressing any Elliptic Function in Terms of \mathcal{P} and \mathcal{P}' . .	651
18.12. Case $\Delta=0$	651
18.13. Equianharmonic Case ($g_2=0, g_3=1$)	652
18.14. Lemniscatic Case ($g_2=1, g_3=0$)	658
18.15. Pseudo-Lemniscatic Case ($g_2=-1, g_3=0$)	662
Numerical Methods	663
18.16. Use and Extension of the Tables	663
References	670

¹ University of California, National Bureau of Standards, and California State College at Hayward.

Table 18.1. Table for Obtaining Periods for Invariants g_2 and g_3 Page
 $(\bar{g}_2 = g_2 g_3^{-2/3})$ 673

Non-Negative Discriminant ($3 \leq \bar{g}_2 \leq \infty$)

$$\omega g_3^{1/6}, \frac{\omega' g_3^{1/6}}{i} + \frac{\sqrt{6}}{12} \ln(\bar{g}_2 - 3); \bar{g}_2 = 3(.05)3.4, 7D$$

$$\omega g_3^{1/6}, \omega' g_3^{1/6}/i; \bar{g}_2 = 3.4(.1)5(.2)10, 7D$$

$$\omega g_3^{1/6} \bar{g}_2^{1/4}, \omega' g_3^{1/6} \bar{g}_2^{1/4}/i; \bar{g}_2^{-1} = .1(-.01)0, 7D$$

Non-Positive Discriminant ($-\infty \leq \bar{g}_2 \leq 3$)

$$\omega_2 g_3^{1/6} |\bar{g}_2|^{1/4}, \omega_2' g_3^{1/6} |\bar{g}_2|^{1/4}/i; \bar{g}_2^{-1} = 0(-.01)-.2, 7D$$

$$\omega_2 g_3^{1/6}, \omega_2' g_3^{1/6}/i; \bar{g}_2^{-1} = -.2(-.05)-1, 7D$$

$$\omega_2 g_3^{1/6}, \frac{\omega_2'}{i} g_3^{1/6} + \frac{\sqrt{6}}{6} \ln(3 - \bar{g}_2); \bar{g}_2 = -1(.2)3, 7D$$

Table 18.2. Table for Obtaining \mathcal{P} , \mathcal{P}' and ζ on $0x$ and $0y$ (Unit
 Real Half-Period—Period Ratio a). 674

Positive Discriminant ($0 \leq x \leq 1, 0 \leq y \leq a$)

$$z^2 \mathcal{P}(z), z^3 \mathcal{P}'(z), z\zeta(z), a = 1, 1.05, 1.1, 1.2, 1.4, 2, 4$$

$$x = 0(.05)1, y = 0(.05) 1.1, 1.2 (.2) a, 6-8D$$

Negative Discriminant ($0 \leq x \leq 1, 0 \leq y \leq a/2$)

$$z^2 \mathcal{P}(z), z^3 \mathcal{P}'(z), z\zeta(z), a = 1, 1.05, 1.15, 1.3, 1.5, 2, 4$$

$$x = 0(.05)1, y = 0(.05)1 (.1)b(b \geq a/2), 7D$$

Table 18.3. Invariants and Values at Half-Periods ($1 \leq a \leq \infty$) (Unit
 Real Half-Period). 680

$$a = 1(.02)1.6(.05)2.3(.1) 4, \infty, 6-8D$$

Non-Negative Discriminant

$$g_2, g_3, e_1 = \mathcal{P}(1), e_3 = \mathcal{P}(\omega'), \eta = \zeta(1), \eta'/i = \zeta(\omega')/i, \sigma(1), \sigma(\omega')/i, \sigma(\omega_2)$$

Non-Positive Discriminant

$$g_2, g_3, e_1, \eta_2 = \zeta(1), \eta_2'/i = \zeta(\omega_2')/i, \sigma(1), \sigma(\omega_2')/i, \sigma(\omega')$$

The author gratefully acknowledges the assistance and encouragement of the personnel of Numerical Analysis Research, UCLA (especially Dr. C. B. Tompkins for generating the author's interest in the project, and Mrs. H. O. Rosay for programming and computing, hand calculation and formula checking) and the personnel of the Computation Laboratory (especially R. Capuano, E. Godefroy, D. Liepman, B. Walter and R. Zucker for the preparation and checking of the tables and maps).

18. Weierstrass Elliptic and Related Functions

Mathematical Properties

18.1. Definitions, Symbolism, Restrictions and Conventions

An elliptic function is a single-valued doubly periodic function of a single complex variable which is analytic except at poles and whose only singularities in the finite plane are poles. If ω and ω' are a pair of (primitive) half-periods of such a function $f(z)$, then $f(z+2M\omega+2N\omega')=f(z)$, M and N being integers. Thus the study of any such function can be reduced to consideration of its behavior in a *fundamental period parallelogram* (FPP). An elliptic function has a finite number of poles (and the same number of zeros) in a FPP; the number of such poles (zeros) (an irreducible set) is the *order* of the function (poles and zeros are counted according to their multiplicity). All other poles (zeros) are called *congruent* to the irreducible set. The simplest (non-trivial) elliptic functions are of order two. One may choose as the standard function of order two either a function with two simple poles (Jacobi's choice) or one double pole (Weierstrass' choice) in a FPP.

Weierstrass' \mathcal{P} -Function. Let ω, ω' denote a pair of complex numbers with $\mathcal{S}(\omega'/\omega) > 0$. Then $\mathcal{P}(z) = \mathcal{P}(z|\omega, \omega')$ is an elliptic function of order two with periods $2\omega, 2\omega'$ and having a double pole at $z=0$, whose principal part is z^{-2} ; $\mathcal{P}(z) - z^{-2}$ is analytic in a neighborhood of the origin and vanishes at $z=0$.

Weierstrass' ζ -Function $\zeta(z) = \zeta(z|\omega, \omega')$ satisfies the condition $\zeta'(z) = -\mathcal{P}(z)$; further, $\zeta(z)$ has a simple pole at $z=0$ whose principal part is z^{-1} ; $\zeta(z) - z^{-1}$ vanishes at $z=0$ and is analytic in a neighborhood of the origin. $\zeta(z)$ is *NOT* an elliptic function, since it is not periodic. However, it is quasi-periodic (see "period" relations), so reduction to FPP is possible.

Weierstrass' σ -Function $\sigma(z) = \sigma(z|\omega, \omega')$ satisfies the condition $\sigma'(z)/\sigma(z) = \zeta(z)$; further, $\sigma(z)$ is an entire function which vanishes at the origin. Like ζ , it is *NOT* an elliptic function, since it is not periodic. However, it is quasi-periodic (see "period" relations), so reduction to FPP is possible.

Invariants g_2 and g_3

Let $W = 2M\omega + 2N\omega'$, M and N being integers. Then

$$18.1.1 \quad g_2 = 60\Sigma'W^{-4} \text{ and } g_3 = 140\Sigma'W^{-6}$$

are the INVARIANTS, summation being over all pairs M, N except $M=N=0$.

Alternate Symbolism Emphasizing Invariants

$$18.1.2 \quad \mathcal{P}(z) = \mathcal{P}(z; g_2, g_3)$$

$$18.1.3 \quad \mathcal{P}'(z) = \mathcal{P}'(z; g_2, g_3)$$

$$18.1.4 \quad \zeta(z) = \zeta(z; g_2, g_3)$$

$$18.1.5 \quad \sigma(z) = \sigma(z; g_2, g_3)$$

Fundamental Differential Equation, Discriminant and Related Quantities

$$18.1.6 \quad \mathcal{P}'^2(z) = 4\mathcal{P}^3(z) - g_2\mathcal{P}(z) - g_3$$

$$18.1.7$$

$$= 4(\mathcal{P}(z) - e_1)(\mathcal{P}(z) - e_2)(\mathcal{P}(z) - e_3)$$

$$18.1.8$$

$$\Delta = g_2^3 - 27g_3^2 = 16(e_2 - e_3)^2(e_3 - e_1)^2(e_1 - e_2)^2$$

$$18.1.9$$

$$g_2 = -4(e_1e_2 + e_1e_3 + e_2e_3) = 2(e_1^2 + e_2^2 + e_3^2)$$

$$18.1.10 \quad g_3 = 4e_1e_2e_3 = \frac{4}{3}(e_1^3 + e_2^3 + e_3^3)$$

$$18.1.11 \quad e_1 + e_2 + e_3 = 0$$

$$18.1.12 \quad e_1^4 + e_2^4 + e_3^4 = g_2^2/8$$

$$18.1.13 \quad 4e_i^3 - g_2e_i - g_3 = 0 (i=1, 2, 3)$$

Agreement about Values of Invariants (and Discriminant)

We shall consider, in this chapter, only *real* g_2 and g_3 (this seems to cover most applications)—hence Δ is real. We shall dichotomize most of what follows (either $\Delta > 0$ or $\Delta < 0$). Homogeneity relations 18.2.1–18.2.15 enable a further restriction to non-negative g_3 (except for one case when $\Delta = 0$).

Note on Symbolism for Roots of Complex Numbers and for Conjugate Complex Numbers

In this chapter, $z^{1/n}$ (n a positive integer) is used to denote the principal n th root of z , as in chapter 3; \bar{z} is used to denote the complex conjugate of z .

FPP's, Symbols for Periods, etc.

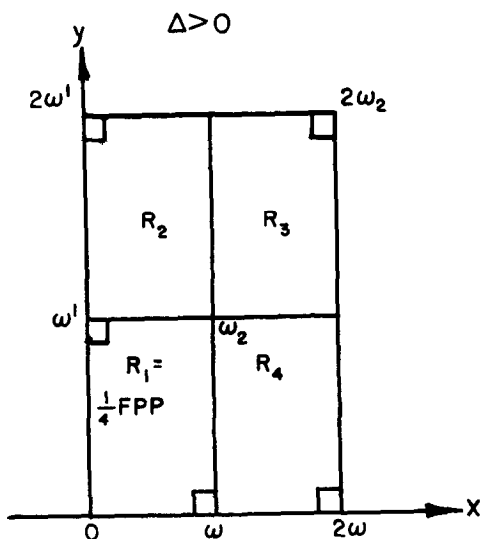

RECTANGLE

ω REAL
 ω' PURE IMAG.
 $|\omega'| \geq \omega$, since $g_3 \geq 0$

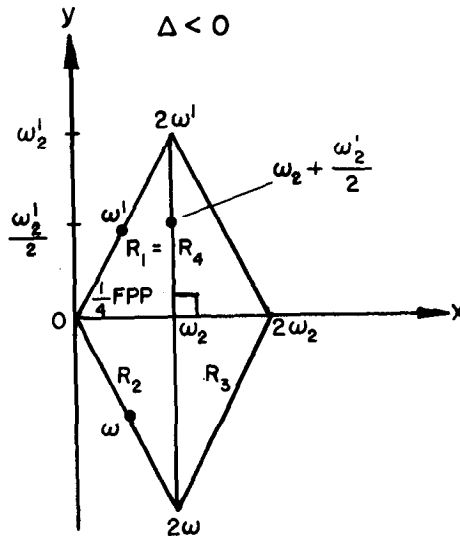

RHOMBUS

ω_2 REAL
 ω'_2 PURE IMAG.
 $|\omega'_2| \geq \omega_2$, since $g_3 \geq 0$

FIGURE 18.1

$$\begin{aligned} \omega_1 &= \omega \\ \omega_3 &= \omega + \omega' & \omega'_2 &= \omega' - \omega \\ \omega_3 &= \omega' \end{aligned}$$

Fundamental Rectangles

Study of all four functions (\wp, \wp', ζ, σ) can be reduced to consideration of their values in a Fundamental Rectangle including the origin (see 18.2 on homogeneity relations, reduction formulas and processes).

$\Delta > 0$

$\Delta < 0$

Fundamental Rectangle is $\frac{1}{4}$ FPP, which has vertices $0, \omega, \omega_2$ and ω'

Fundamental Rectangle has vertices $0, \omega_2, \omega_2 + \frac{\omega'_2}{2}, \frac{\omega'_2}{2}$

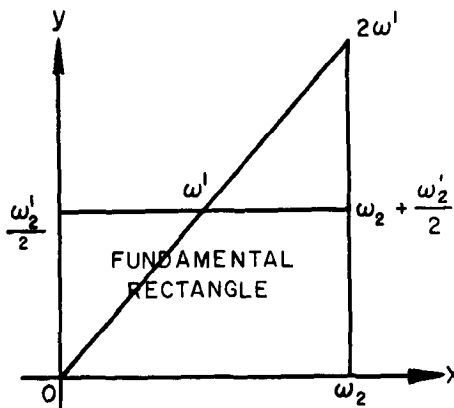
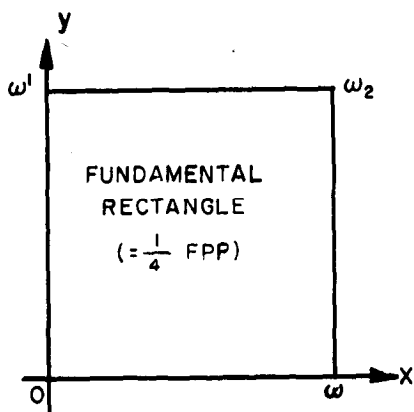

FIGURE 18.2

There is a point on the right boundary of Fundamental Rectangle where $\wp = 0$. Denote it by z_0 .

18.2. Homogeneity Relations, Reduction Formulas and Processes

Homogeneity Relations (Suppose $t \neq 0$)

Note that Period Ratio is preserved.

- 18.2.1 $\mathcal{P}'(tz|t\omega, t\omega') = t^{-3}\mathcal{P}'(z|\omega, \omega')$
- 18.2.2 $\mathcal{P}(tz|t\omega, t\omega') = t^{-2}\mathcal{P}(z|\omega, \omega')$
- 18.2.3 $\zeta(tz|t\omega, t\omega') = t^{-1}\zeta(z|\omega, \omega')$
- 18.2.4 $\sigma(tz|t\omega, t\omega') = t\sigma(z|\omega, \omega')$
- 18.2.5 $g_2(t\omega, t\omega') = t^{-4}g_2(\omega, \omega')$
- 18.2.6 $g_3(t\omega, t\omega') = t^{-6}g_3(\omega, \omega')$
- 18.2.7 $e_i(t\omega, t\omega') = t^{-2}e_i(\omega, \omega'), i=1, 2, 3$
- 18.2.8 $\Delta(t\omega, t\omega') = t^{-12}\Delta(\omega, \omega')$
- 18.2.9 $H_i(t\omega, t\omega') = t^{-2}H_i(\omega, \omega'), i=1, 2, 3$
(See 18.3)
- 18.2.10 $q(t\omega, t\omega') = q(\omega, \omega')$ (See 18.10)
- 18.2.11 $m(t\omega, t\omega') = m(\omega, \omega')$ (See 18.9)
- 18.2.12 $\mathcal{P}'(tz; t^{-4}g_2, t^{-6}g_3) = t^{-3}\mathcal{P}'(z; g_2, g_3)$
- 18.2.13 $\mathcal{P}(tz; t^{-4}g_2, t^{-6}g_3) = t^{-2}\mathcal{P}(z; g_2, g_3)$
- 18.2.14 $\zeta(tz; t^{-4}g_2, t^{-6}g_3) = t^{-1}\zeta(z; g_2, g_3)$
- 18.2.15 $\sigma(tz; t^{-4}g_2, t^{-6}g_3) = t\sigma(z; g_2, g_3)$

The Case $g_3 < 0$

Put $t=i$ and obtain, e.g.,

18.2.16 $\mathcal{P}(z; g_2, g_3) = -\mathcal{P}(iz; g_2, -g_3)$

Thus the case $g_3 < 0$ can be reduced to one where $g_3 > 0$.

“Period” Relations and Reduction to the FPP (M, N integers)

18.2.17 $\mathcal{P}'(z+2M\omega+2N\omega') = \mathcal{P}'(z)$

18.2.18 $\mathcal{P}(z+2M\omega+2N\omega') = \mathcal{P}(z)$

18.2.19

$\zeta(z+2M\omega+2N\omega') = \zeta(z) + 2M\eta + 2N\eta'$

18.2.20

$\sigma(z+2M\omega+2N\omega')$
 $= (-1)^{M+N+MN} \sigma(z) \exp [(z+M\omega+N\omega')(2M\eta + 2N\eta')]$

18.2.21 where $\eta = \zeta(\omega), \eta' = \zeta(\omega')$

“Conjugate” Values

$f(\bar{z}) = \bar{f}(z)$, where f is any one of the functions $\mathcal{P}, \mathcal{P}', \zeta, \sigma$.

Reduction to $\frac{1}{4}$ FPP (See Figure 18.1)

$\Delta > 0$

$\Delta < 0$

(\bar{s} denotes conjugate of s)

Point z_4 in R_4

- 18.2.22 $\mathcal{P}'(z_4) = -\overline{\mathcal{P}'(2\omega - z_4)}$ $\mathcal{P}'(\bar{z}_4) = -\overline{\mathcal{P}'(2\omega_2 - z_4)}$
- 18.2.23 $\mathcal{P}(z_4) = \overline{\mathcal{P}(2\omega - z_4)}$ $\mathcal{P}(z_4) = \overline{\mathcal{P}(2\omega_2 - z_4)}$
- 18.2.24 $\zeta(z_4) = -\overline{\zeta(2\omega - z_4)} + 2\eta$ $\zeta(z_4) = -\overline{\zeta(2\omega_2 - z_4)} + 2(\eta + \eta')$
- 18.2.25 $\sigma(z_4) = \overline{\sigma(2\omega - z_4)} \exp [2\eta(z_4 - \omega)]$ $\sigma(z_4) = \overline{\sigma(2\omega_2 - z_4)} \exp [2(\eta + \eta')(z_4 - \omega_2)]$

Point z_3 in R_3

- 18.2.26 $\mathcal{P}'(z_3) = -\mathcal{P}'(2\omega_2 - z_3)$ $\mathcal{P}'(z_3) = -\mathcal{P}'(2\omega_2 - z_3)$
- 18.2.27 $\mathcal{P}(z_3) = \mathcal{P}(2\omega_2 - z_3)$ $\mathcal{P}(z_3) = \mathcal{P}(2\omega_2 - z_3)$
- 18.2.28 $\zeta(z_3) = -\zeta(2\omega_2 - z_3) + 2(\eta + \eta')$ $\zeta(z_3) = -\zeta(2\omega_2 - z_3) + 2(\eta + \eta')$
- 18.2.29 $\sigma(z_3) = \sigma(2\omega_2 - z_3) \exp [2(\eta + \eta')(z_3 - \omega_2)]$ $\sigma(z_3) = \sigma(2\omega_2 - z_3) \exp [2(\eta + \eta')(z_3 - \omega_2)]$

Point z_2 in R_2

- 18.2.30 $\mathcal{P}'(z_2) = \overline{\mathcal{P}'(z_2 - 2\omega')}$ $\mathcal{P}'(z_2) = \overline{\mathcal{P}'(\bar{z}_2)}$
- 18.2.31 $\mathcal{P}(z_2) = \overline{\mathcal{P}(z_2 - 2\omega')}$ $\mathcal{P}(z_2) = \overline{\mathcal{P}(\bar{z}_2)}$
- 18.2.32 $\zeta(z_2) = \overline{\zeta(z_2 - 2\omega')} + 2\eta'$ $\zeta(z_2) = \overline{\zeta(\bar{z}_2)}$
- 18.2.33 $\sigma(z_2) = -\overline{\sigma(z_2 - 2\omega')} \exp [2\eta'(z_2 - \omega')]$ $\sigma(z_2) = \overline{\sigma(\bar{z}_2)}$

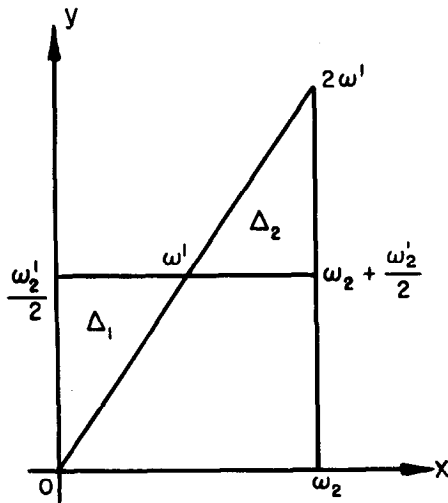

FIGURE 18.3

Reduction from $\frac{1}{4}$ FPP to Fundamental Rectangle in Case $\Delta < 0$

We need only be concerned with the case when z is in triangle Δ_2 (therefore $2\omega' - z$ is in triangle Δ_1).

- 18.2.34 $\mathcal{P}(z) = \mathcal{P}(2\omega' - z)$
- 18.2.35 $\mathcal{P}'(z) = -\mathcal{P}'(2\omega' - z)$
- 18.2.36 $\zeta(z) = 2\eta' - \zeta(2\omega' - z)$
- 18.2.37 $\sigma(z) = \sigma(2\omega' - z) \exp [2\eta'(z - \omega')]$

**Reduction to Case where Real Half-Period is Unity
(preserving period ratio)**

$\Delta > 0$

$\Delta < 0$

$(\omega_2 = \omega + \omega')$

- | | | |
|---------|---|--|
| 18.2.38 | $\mathcal{P}'(z \omega, \omega') = \omega^{-3} \mathcal{P}'\left(z\omega^{-1} 1, \frac{\omega'}{\omega}\right)$ | $\mathcal{P}'(z \omega, \omega') = \omega_2^{-3} \mathcal{P}'\left(z\omega_2^{-1} \left \frac{\omega}{\omega_2}, \frac{\omega'}{\omega_2} \right.\right)$ |
| 18.2.39 | $\mathcal{P}(z \omega, \omega') = \omega^{-2} \mathcal{P}\left(z\omega^{-1} 1, \frac{\omega'}{\omega}\right)$ | $\mathcal{P}(z \omega, \omega') = \omega_2^{-2} \mathcal{P}\left(z\omega_2^{-1} \left \frac{\omega}{\omega_2}, \frac{\omega'}{\omega_2} \right.\right)$ |
| 18.2.40 | $\zeta(z \omega, \omega') = \omega^{-1} \zeta\left(z\omega^{-1} 1, \frac{\omega'}{\omega}\right)$ | $\zeta(z \omega, \omega') = \omega_2^{-1} \zeta\left(z\omega_2^{-1} \left \frac{\omega}{\omega_2}, \frac{\omega'}{\omega_2} \right.\right)$ |
| 18.2.41 | $\sigma(z \omega, \omega') = \omega \sigma\left(z\omega^{-1} 1, \frac{\omega'}{\omega}\right)$ | $\sigma(z \omega, \omega') = \omega_2 \sigma\left(z\omega_2^{-1} \left \frac{\omega}{\omega_2}, \frac{\omega'}{\omega_2} \right.\right)$ |
| 18.2.42 | $g_2(\omega, \omega') = \omega^{-4} g_2\left(1, \frac{\omega'}{\omega}\right)$ | $g_2(\omega, \omega') = \omega_2^{-4} g_2\left(\frac{\omega}{\omega_2}, \frac{\omega'}{\omega_2}\right)$ |
| 18.2.43 | $g_3(\omega, \omega') = \omega^{-6} g_3\left(1, \frac{\omega'}{\omega}\right)$ | $g_3(\omega, \omega') = \omega_2^{-6} g_3\left(\frac{\omega}{\omega_2}, \frac{\omega'}{\omega_2}\right)$ |
| 18.2.44 | $e_i(\omega, \omega') = \omega^{-2} e_i\left(1, \frac{\omega'}{\omega}\right)$ | $e_i(\omega, \omega') = \omega_2^{-2} e_i\left(\frac{\omega}{\omega_2}, \frac{\omega'}{\omega_2}\right)$ |
| | $(i=1, 2, 3)$ | $(i=1, 2, 3)$ |
| 18.2.45 | $\Delta(\omega, \omega') = \omega^{-12} \Delta\left(1, \frac{\omega'}{\omega}\right)$ | $\Delta(\omega, \omega') = \omega_2^{-12} \Delta\left(\frac{\omega}{\omega_2}, \frac{\omega'}{\omega_2}\right)$ |

NOTE: New real half-period is

$$\frac{\omega}{\omega_2} + \frac{\omega'}{\omega_2} = \frac{\omega + \omega'}{\omega_2} = 1$$

18.3. Special Values and Relations

Values at Periods

\mathcal{P} , \mathcal{P}' , and ζ are infinite, σ is zero at $z=2\omega_i$, $i=1, 2, 3$ and at $2\omega_2' (\Delta < 0)$.

 $\Delta > 0$ $\Delta < 0$

Half-Periods

- 18.3.1 $\mathcal{P}(\omega_i) = e_i (i=1, 2, 3)$
- 18.3.2 $\mathcal{P}'(\omega_i) = 0 (i=1, 2, 3)$
- 18.3.3 $\eta_i = \zeta(\omega_i) (i=1, 2, 3)$
- 18.3.4 $\eta_1 = \eta, \eta_2 = \eta + \eta', \eta_3 = \eta'$
- 18.3.5 $H_i^2 = 2e_i^2 + e_j e_k (i, j, k=1, 2, 3; i \neq j, i \neq k, j \neq k)$
- 18.3.6 $= (e_i - e_j)(e_i - e_k) = 2e_i^2 + \frac{g_3}{4e_i} = 3e_i^2 - \frac{g_2}{4}$
- 18.3.7 e_i real e_2 real and non-negative
- 18.3.8 $e_1 > 0 \geq e_2 > e_3$ $(e_2 = 0 \text{ when } g_3 = 0)$
 (equality when $g_3 = 0$) $e_1 = -\alpha + i\beta, e_3 = \bar{e}_1$
where $\alpha \geq 0, \beta > 0$
(equality when $g_3 = 0$)
- 18.3.9 $\eta > 0$ $\eta_2' = \zeta(\omega_2) = \eta' - \eta$
- 18.3.10 $\eta'/i \leq 0$ if $\eta_2 > 0$
- 18.3.11 $|\omega'|/\omega \leq 1.91014\ 050$ (approx.) $\eta_2'/i \leq 0$ if $|\omega_2|/\omega_2 \leq 3.81915\ 447$ (approx.)
- 18.3.12 $H_1 > 0, H_3 > 0$ $H_2 > 0$
- 18.3.13 $H_2 = i\sqrt{-H_3^2}$ $\pi/4 < \arg(H_3) \leq \pi/2$ (equality if $g_3 = 0$); $H_1 = \bar{H}_3$
- 18.3.14 $\sigma(\omega) = e^{\eta\omega/2}/H_1^{1/2}$ $\sigma(\omega_2) = e^{\eta_2\omega_2/2}/H_2^{1/2}$
- 18.3.15 $\sigma(\omega') = ie^{\eta'\omega'/2}/H_3^{1/2}$ $\sigma(\omega_2') = ie^{\eta_2'\omega_2'/2}/H_3^{1/2}$
- 18.3.16 $\sigma^2(\omega_2) = e^{\eta_2\omega_2}/(-H_2)$ $\sigma^2(\omega') = e^{\eta'\omega'}/(-H_3)$
- 18.3.17 $\arg[\sigma(\omega_2)] = \frac{\eta'\omega}{i} + \frac{\pi}{2}$ $\arg[\sigma(\omega')] = \frac{\eta_2'\omega_2}{4i} + \frac{\pi}{2} - \frac{1}{2} \arg(e_2 + H_2 - e_i)$

Quarter Periods

- 18.3.18 $\mathcal{P}(\omega/2) = e_1 + H_1 > e_1$ $\mathcal{P}(\omega_2/2) = e_2 + H_2 > e_2$
- 18.3.19 $\mathcal{P}'(\omega/2) = -2H_1\sqrt{2H_1+3e_1}$ $\mathcal{P}'(\omega_2/2) = -2H_2\sqrt{2H_2+3e_2}$
- 18.3.20 $\zeta(\omega/2) = \frac{1}{2}[\eta + \sqrt{2H_1+3e_1}]$ $\zeta(\omega_2/2) = \frac{1}{2}[\eta_2 + \sqrt{2H_2+3e_2}]$

$\Delta > 0$ $\Delta < 0$

$$18.3.21 \quad \sigma(\omega/2) = \frac{e^{\eta\omega/8}}{2^{1/4}H_1^{3/8}(2H_1+3e_1)^{1/8}}$$

$$\sigma(\omega_2/2) = \frac{e^{\eta_2\omega_2/8}}{2^{1/4}H_2^{3/8}(2H_2+3e_2)^{1/8}}$$

$$18.3.22 \quad \mathcal{P}'(\omega'/2) = e_3 - H_3 < e_3 < 0$$

$$\mathcal{P}'(\omega_2'/2) = e_2 - H_2 = \mathcal{P}(\omega_2 + \omega_2'/2) < e_2 < 0$$

$$18.3.23 \quad \mathcal{P}'(\omega'/2) = -2H_3i\sqrt{2H_3-3e_3}$$

$$\mathcal{P}'(\omega_2'/2) = -2H_2i\sqrt{2H_2-3e_2} = \overline{\mathcal{P}'}(\omega_2 + \omega_2'/2)$$

$$18.3.24 \quad \zeta(\omega'/2) = \frac{1}{2}[\eta' - i\sqrt{2H_3-3e_3}]$$

$$\zeta(\omega_2'/2) = \frac{1}{2}[\eta_2' - i\sqrt{2H_2-3e_2}] = -\zeta(\omega_2 + \omega_2'/2) + 2\eta'$$

$$18.3.25 \quad \sigma(\omega'/2) = \frac{ie^{\eta'\omega'/8}}{2^{1/4}H_3^{3/8}(2H_3-3e_3)^{1/8}}$$

$$\sigma(\omega_2'/2) = \frac{ie^{\eta_2'\omega_2'/8}}{2^{1/4}H_2^{3/8}(2H_2-3e_2)^{1/8}}$$

$$= \sigma(\omega_2 + \omega_2'/2) \exp[-\eta'\omega_2]$$

$$18.3.26 \quad \mathcal{P}(\omega_2/2) = e_2 - H_2$$

$$\mathcal{P}(\omega'/2) = e_3 - H_3$$

$$18.3.27 \quad \mathcal{P}'(\omega_2/2) = -2H_2i(2H_2-3e_2)^{\frac{1}{2}}$$

$$\mathcal{P}'(\omega'/2) = -2iH_3(2H_3-3e_3)^{\frac{1}{2}}$$

$$18.3.28 \quad \zeta(\omega_2/2) = \frac{1}{2}[\eta_2 - i(2H_2-3e_2)^{\frac{1}{2}}]$$

$$\zeta(\omega'/2) = \frac{1}{2}[\eta' - i(2H_3-3e_3)^{\frac{1}{2}}]$$

$$18.3.29 \quad \sigma(\omega_2/2) = \frac{e^{\eta_2\omega_2/8}e^{i\pi/4}}{[4H_2^3(2H_2-3e_2)]^{1/8}}$$

$$\sigma(\omega'/2) = \frac{e^{\eta'\omega'/8}e^{i\pi/4}}{[4H_3^3(2H_3-3e_3)]^{1/8}}$$

One-Third Period Relations

At $z=2\omega_i/3$ ($i=1, 2, 3$) or $2\omega_2'/3$, $\mathcal{P}''^2=12\mathcal{P}\mathcal{P}'^2$;

equivalently:

$$18.3.30 \quad 48\mathcal{P}^4 - 24g_2\mathcal{P}^2 - 48g_3\mathcal{P} - g_2^2 = 0$$

 $\Delta > 0$ $\Delta < 0$

$$18.3.31 \quad \zeta(2\omega/3) = \frac{2\eta}{3} + \left[\frac{\mathcal{P}(2\omega/3)}{3} \right]^{\frac{1}{2}}$$

$$\zeta(2\omega_2/3) = \frac{2\eta_2}{3} + \left[\frac{\mathcal{P}(2\omega_2/3)}{3} \right]^{\frac{1}{2}}$$

$$18.3.32 \quad \zeta(2\omega'/3) = \frac{2\eta'}{3} - \left[\frac{\mathcal{P}(2\omega'/3)}{3} \right]^{\frac{1}{2}}$$

$$\zeta(2\omega_2'/3) = \frac{2\eta_2'}{3} - \left[\frac{\mathcal{P}(2\omega_2'/3)}{3} \right]^{\frac{1}{2}}$$

$$18.3.33 \quad \zeta(2\omega_2/3) = \frac{2\eta_2}{3} + \left[\frac{\mathcal{P}(2\omega_2/3)}{3} \right]^{\frac{1}{2}}$$

$$\zeta(2\omega'/3) = \frac{2\eta'}{3} + \left[\frac{\mathcal{P}(2\omega'/3)}{3} \right]^{\frac{1}{2}}$$

$$18.3.34 \quad \sigma(2\omega/3) = \frac{-\exp[2\eta\omega/9]}{\sqrt[3]{\mathcal{P}'(2\omega/3)}}$$

$$\sigma(2\omega_2/3) = \frac{-\exp[2\eta_2\omega_2/9]}{\sqrt[3]{\mathcal{P}'(2\omega_2/3)}}$$

$$18.3.35 \quad \sigma(2\omega'/3) = \frac{-\exp[2\eta'\omega'/9]}{[\mathcal{P}'(2\omega'/3)]^{1/3}e^{2\pi i/3}}$$

$$\sigma(2\omega_2'/3) = \frac{-\exp[2\eta_2'\omega_2'/9]}{[\mathcal{P}'(2\omega_2'/3)]^{1/3}e^{2\pi i/3}}$$

$$18.3.36 \quad \sigma(2\omega_2/3) = \frac{-\exp[2\eta_2\omega_2/9]}{[\mathcal{P}'(2\omega_2/3)]^{1/3}e^{2\pi i/3}}$$

$$\sigma(2\omega'/3) = \frac{-\exp[2\eta'\omega'/9]}{[\mathcal{P}'(2\omega'/3)]^{1/3}e^{2\pi i/3}}$$

Legendre's Relation

$$18.3.37 \quad \eta\omega' - \eta'\omega = \pi i/2$$

$$\eta_2\omega_2' - \eta_2'\omega_2 = \pi i$$

(also valid for $\Delta < 0$)

Relations Among the H_i

$$18.3.38$$

$$H_1^2 + H_2^2 + H_3^2 = 3g_2/4$$

$$18.3.39$$

$$H_1^3H_2^2 + H_2^3H_3^2 + H_3^3H_1^2 = 0$$

$$18.3.40 \quad H_1^2 H_2^2 H_3^2 = -\Delta/16$$

$$18.3.41 \quad 16H_i^3 - 12g_2 H_i^4 + \Delta = 0 (i=1, 2, 3)$$

18.4. Addition and Multiplication Formulas

Addition Formulas² ($z_1 \neq z_2$)

$$18.4.1 \quad \mathcal{P}(z_1 + z_2) = \frac{1}{4} \left[\frac{\mathcal{P}'(z_1) - \mathcal{P}'(z_2)}{\mathcal{P}(z_1) - \mathcal{P}(z_2)} \right]^2 - \mathcal{P}(z_1) - \mathcal{P}(z_2)$$

$$18.4.2 \quad \mathcal{P}'(z_1 + z_2) = \frac{\mathcal{P}(z_1 + z_2)[\mathcal{P}'(z_1) - \mathcal{P}'(z_2)] + \mathcal{P}(z_1)\mathcal{P}'(z_2) - \mathcal{P}'(z_1)\mathcal{P}(z_2)}{\mathcal{P}(z_2) - \mathcal{P}(z_1)}$$

$$18.4.3 \quad \zeta(z_1 + z_2) = \zeta(z_1) + \zeta(z_2) + \frac{1}{2} \frac{\mathcal{P}'(z_1) - \mathcal{P}'(z_2)}{\mathcal{P}(z_1) - \mathcal{P}(z_2)}$$

$$18.4.4 \quad \sigma(z_1 + z_2)\sigma(z_1 - z_2) = -\sigma^2(z_1)\sigma^2(z_2)[\mathcal{P}(z_1) - \mathcal{P}(z_2)]$$

Duplication and Triplication Formulas

$$\left[\text{Note that } \mathcal{P}'' = 6\mathcal{P}^2(z) - \frac{g_2}{2}, \mathcal{P}'^2(z) = 4\mathcal{P}^3(z) - g_2\mathcal{P}(z) - g_3 \text{ and } \mathcal{P}'''(z) = 12\mathcal{P}(z)\mathcal{P}'(z) \right]$$

$$18.4.5 \quad \mathcal{P}(2z) = -2\mathcal{P}(z) + \left[\frac{\mathcal{P}''(z)}{2\mathcal{P}'(z)} \right]^2$$

$$18.4.6 \quad \mathcal{P}'(2z) = \frac{-4\mathcal{P}'^4(z) + 12\mathcal{P}(z)\mathcal{P}'^2(z)\mathcal{P}''(z) - \mathcal{P}'''^2(z)}{4\mathcal{P}'^3(z)}$$

$$18.4.7 \quad \zeta(2z) = 2\zeta(z) + \mathcal{P}''(z)/2\mathcal{P}'(z)$$

$$18.4.8 \quad \sigma(2z) = -\mathcal{P}'(z)\sigma^4(z)$$

$$18.4.9 \quad \zeta(3z) = 3\zeta(z) + \frac{4\mathcal{P}'^3(z)}{\mathcal{P}'(z)\mathcal{P}'''(z) - \mathcal{P}''^2(z)}$$

$$18.4.10 \quad \sigma(3z) = -\mathcal{P}'^2(z)\sigma^9(z)[\mathcal{P}(2z) - \mathcal{P}(z)]$$

18.5. Series Expansions

Laurent Series

$$18.5.1 \quad \mathcal{P}(z) = z^{-2} + \sum_{k=2}^{\infty} c_k z^{2k-2}$$

$$18.5.2 \quad \text{where } c_2 = g_2/20, c_3 = g_3/28$$

and

$$18.5.3 \quad c_k = \frac{3}{(2k+1)(k-3)} \sum_{m=2}^{k-2} c_m c_{k-m}, k \geq 4$$

$$18.5.4 \quad \mathcal{P}'(z) = -2z^{-3} + \sum_{k=2}^{\infty} (2k-2)c_k z^{2k-3}$$

$$18.5.5 \quad \zeta(z) = z^{-1} - \sum_{k=2}^{\infty} c_k z^{2k-1}/(2k-1)$$

$$18.5.6 \quad \sigma(z) = \sum_{m,n=0}^{\infty} a_{m,n} \left(\frac{1}{2}g_2\right)^m (2g_3)^n \cdot \frac{z^{4m+6n+1}}{(4m+6n+1)!}$$

² Formulas for ζ and σ are not true algebraic addition formulas.

18.5.7

where $a_{0,0}=1$ and

18.5.8

$$a_{m,n}=3(m+1)a_{m+1,n-1}+\frac{16}{3}(n+1)a_{m-2,n+1}-\frac{1}{3}(2m+3n-1)(4m+6n-1)a_{m-1,n},$$

it being understood that $a_{m,n}=0$ if either subscript is negative.

(The radius of convergence of the above series for $\mathcal{P}-z^{-2}$, $\mathcal{P}'+2z^{-3}$ and $\zeta-z^{-1}$ is equal to the smallest of $|2\omega|$, $|2\omega'|$ and $|2\omega\pm 2\omega'|$; series for σ converges for all z .)

Values of Coefficients³ c_k in Terms of c_2 and c_3

18.5.9

$$c_4=c_2^2/3$$

18.5.10

$$c_5=3c_2c_3/11$$

18.5.11

$$c_6=[2c_2^3+3c_3^2]/39$$

18.5.12

$$c_7=2c_2^2c_3/33$$

18.5.13

$$c_8=5c_2(11c_2^3+36c_3^2)/7293$$

18.5.14

$$c_9=c_3(29c_2^3+11c_3^2)/2717$$

18.5.15

$$c_{10}=(242c_2^5+1455c_2^2c_3^2)/240669$$

18.5.16

$$c_{11}=14c_2c_3(389c_2^3+369c_3^2)/3187041$$

18.5.17

$$c_{12}=(114950c_2^6+1080000c_2^3c_3^2+166617c_3^4)/891678645$$

18.5.18

$$c_{13}=10c_2^2c_3(297c_2^3+530c_3^2)/11685817$$

18.5.19

$$c_{14}=\frac{2c_2(528770c_2^5+7164675c_2^2c_3^2+2989602c_3^4)}{(306735)(215441)}$$

18.5.20

$$c_{15}=\frac{4c_3(62921815c_2^6+179865450c_2^3c_3^2+14051367c_3^4)}{(179685)(38920531)}$$

18.5.21

$$c_{16}=\frac{c_2^2(58957855c_2^6+1086511320c_2^3c_3^2+875341836c_3^4)}{(5909761)(5132565)}$$

18.5.22

$$c_{17}=\frac{c_2c_3(30171955c_2^6+126138075c_2^3c_3^2+28151739c_3^4)}{(920205)(6678671)}$$

18.5.23

$$c_{18}=\frac{1541470\cdot 949003c_2^6+30458088737\cdot 1155c_2^3c_3^2+122378650673\cdot 378c_2^2c_3^4+2348703\cdot 887777c_3^6}{(1342211013)(4695105713)}$$

18.5.24

$$c_{19}=\frac{2c_2^2c_3(3365544215c_2^6+429852433\cdot 45c_2^3c_3^2+8527743477c_3^4)}{(91100295)(113537407)}$$

³ NOTES:

1. c_4 - c_{16} were computed and checked independently by D. H. Lehmer; these were double-checked by substituting $g_2=20$ c_2 , $g_3=28$ c_3 in values given in [18.10].

2. c_{17} - c_{18} were derived from values in [18.10] by the same substitution. These were checked (numerically) for particular values of g_2 , g_3 .

3. c_{19} is given incorrectly in [18.12] (factor 13 is missing in denominator of third term of bracket); this value was computed independently.

4. No factors of any of the above integers with more than ten digits are known to the author. This is not necessarily true of smaller integers, which have, in many instances, been arranged for convenient use with a desk calculator.

Value⁴ of Coefficients $a_{m,n}$

8	^{7 12} -2-3-5-59 .107895773												
7	^{7 10} -2-3-5-23 .257-18049	^{7 11} -2-3-5-59 .107895773											
6	^{6 9} -2-3-5 .229-2683	^{7 9} -2-3-5-23 .257 .18049	^{6 11} -2-3-5-7 .181-1699 .2803	^{6 10} -2-3-5-7 .41-6047 .4922497									
5	^{5 8} 2-3-5 .0163	^{6 8} -2-3-5-229 .2683	^{5 10} -2-3-5 .40570423	^{5 9} -2-3-5-7 .59-179 .142231	^{4 10} -2-3-5-7 .1321 .1415535763								
4	^{4 8 3} 2-3-5 ³ .31	^{3 7} 2-3-5-9103	^{5 8} -2-3-5-7 .13-37-41	^{5 8} -2-3-5-691 .83609	^{4 8 3} -2-3-5-11-31 .313-190387	^{4 10 3} -2-3-5-7-23 .263-4848953	^{5 9} -2-3-5-7-19 .1752686144977						
3	^{3 4} 2-3-23	^{3 4 3} 2-3-5-31	^{3 7} 2-3-5-17 .109	^{3 8} -2-3-5-83 .3911	^{4 8} -2-3-5-503 .156217	^{4 8} -2-3-31 .315989669	^{4 7} -2-3-5-7-11-29 .83-1129-9551	^{4 8} -2-3-5-7-613 .17605225081					
2	-2-3 ³	^{3 3} 2-3-23	^{3 5} 2-3-5-53	^{3 4} 2-3-5-37 .167	^{3 5} -2-3-5-17 .3037	^{4 7} -2-3-61-151 .653	^{3 7} -2-3 ³ .2387260103	^{4 7} -2-3-5-17-53 .2957-41189	^{0 3} -2-3-5-7-17 .67-195651059	^{3 7 3} 2-3-5-7 ³ .35866647631901			
1	-3	-2-3 ²	³ 3-19	^{3 3} 2-3-311	³ 3-5-20807	³ -2-3-11 .2609	³ -3-17 .1578257	^{3 5} -2-3-7-13 .2742587	⁷ -3 ⁷ .248882935409	^{5 3} -2-3-5-7-193 .13679-274973	⁶ 3-7 .89555603641079		
0	1	-1	-3 ³	3-23	3-107	³ 3-7-23-37	³ 3-313-503	-3-7	⁵ 3-11-37	⁴ -3-7-23-14387	-3-71	⁴ -3-7-11-23 ³	^{4 3} 3-7-24733
0	1	1	9	68	321	160759	1416951	.685973	.257981	.40763	.176302760639	.383-739-18539	.198922785511
		1	2	3	4	5	6	7	8	9	10	11	12

156500
14924
54
3
1
0
1

→ m 38894681

⁴ Values of $a_{m,n}$ in unfactored form for $4m+6n+1 \leq 35$ are given in [18.25], p. 7; of $(a_{m,n})^{3-n}$ in factored form in [18.15], Vol. 4, p. 89 for $4m+6n+1 \leq 25$. Additional values were computed and checked on desk calculators; primality of large factors was established with the aid of SWAC (National Bureau of Standards Western Automatic Computer).

Reversed Series⁵ for Large $|\mathcal{P}|$

18.5.25

$$\begin{aligned}
z = & \frac{1}{2} \left[2u + c_2 u^5 + c_3 u^7 + \frac{\alpha_2^2}{3} u^9 + \frac{6\alpha_2 \alpha_3}{11} u^{11} \right. \\
& + \frac{1}{13} (3\alpha_2^3 + 5\alpha_3^3) u^{13} + \alpha_2^2 \alpha_3 u^{15} + \frac{5\alpha_2}{68} (12\alpha_2^2 + 7\alpha_3^2) u^{17} \\
& + \frac{5\alpha_3}{19} (\alpha_2^3 + 7\alpha_3^3) u^{19} + \frac{\alpha_2^2}{4} (3\alpha_2^3 + 10\alpha_3^3) u^{21} \\
& + \frac{35\alpha_2 \alpha_3}{92} (9\alpha_2^3 + 4\alpha_3^3) u^{23} \\
& + \frac{7}{200} (33\alpha_2^5 + 180\alpha_2^3 \alpha_3^2 + 10\alpha_3^4) u^{25} \\
& + \frac{7\alpha_2^2 \alpha_3}{12} (11\alpha_2^3 + 10\alpha_3^3) u^{27} \\
& + \frac{3\alpha_2}{2^3 \cdot 29} (143\alpha_2^6 + 1155\alpha_2^3 \alpha_3^2 + 210\alpha_3^4) u^{29} \\
& + \frac{21\alpha_3}{2^3 \cdot 31} (143\alpha_2^6 + 220\alpha_2^3 \alpha_3^2 + 6\alpha_3^4) u^{31} \\
& + \frac{3\alpha_2^2}{2^6} (65\alpha_2^6 + 728\alpha_2^3 \alpha_3^2 + 280\alpha_3^4) u^{33} \\
& + \frac{33\alpha_2 \alpha_3}{2^3 \cdot 5 \cdot 7} (195\alpha_2^6 + 455\alpha_2^3 \alpha_3^2 + 42\alpha_3^4) u^{35} \\
& + \frac{11}{2^6 \cdot 37} (1105\alpha_2^9 + 16380\alpha_2^6 \alpha_3^2 + 10920\alpha_2^3 \alpha_3^4 \\
& + 168\alpha_3^6) u^{37} + \frac{33\alpha_2^2 \alpha_3}{2^6} (85\alpha_2^6 + 280\alpha_2^3 \alpha_3^2 + 56\alpha_3^4) u^{39} \\
& + \frac{143\alpha_2}{2^7 \cdot 41} (323\alpha_2^9 + 6120\alpha_2^6 \alpha_3^2 + 6300\alpha_2^3 \alpha_3^4 + 336\alpha_3^6) u^{41} \\
& + \frac{143\alpha_3}{2^6 \cdot 43} (1615\alpha_2^9 + 7140\alpha_2^6 \alpha_3^2 + 2520\alpha_2^3 \alpha_3^4 + 24\alpha_3^6) u^{43} \\
& \left. + O(u^{45}) \right],
\end{aligned}$$

18.5.26 where $\alpha_2 = g_2/8$ 18.5.27 $\alpha_3 = g_3/8$ 18.5.28 $u = (\mathcal{P}^{-1})^{\frac{1}{2}}$ Reversed Series for Large $|\mathcal{P}'|$ 18.5.29 $z = A_1 u + A_5 u^5 + A_7 u^7 + A_9 u^9 + \dots$ 18.5.30 where $u = (\mathcal{P}'^{1/3})^{-1} e^{i\tau/3}$ 18.5.31 $A_1 = 2^{1/3}$ 18.5.32 $A_5 = -\frac{a_2}{5} A_1^2$ 18.5.33 $A_7 = \frac{-4a_3 A_1}{7}$ 18.5.34 $A_9 = 0$ 18.5.35 $A_{11} = 8a_2 a_3 A_1^2/11$ 18.5.36 $A_{13} = \frac{10A_1}{39} (a_2^3 + 6a_3^2)$ 18.5.37 $A_{15} = -96a_2^2 a_3/175$ 18.5.38 $A_{17} = -\frac{14a_2 A_1^2}{51} (a_2^3 + 12a_3^2)$ 18.5.39 where $a_2 = g_2/6$, $a_3 = g_3/6$ Reversed Series for Large $|\zeta|$ 18.5.40 $z = u + A_5 u^5 + A_7 u^7 + A_9 u^9 + \dots$ 18.5.41 where $u = \zeta^{-1}$ 18.5.42 $A_5 = -\delta_2/5$ 18.5.43 $A_7 = -\delta_3/7$ 18.5.44 $A_9 = \delta_2^2/7$ 18.5.45 $A_{11} = 3\delta_2 \delta_3/11$ 18.5.46 $A_{13} = \frac{17}{1001} (-8\delta_2^3 + 7\delta_3^2)$ 18.5.47 $A_{15} = -41\delta_2^2 \delta_3/91$ 18.5.48 $A_{17} = \frac{\delta_2}{9163} (1349\delta_2^3 - 4116\delta_3^2)$ 18.5.49 $A_{19} = \frac{2\delta_3}{323323} (115431\delta_2^3 - 22568\delta_3^2)$ 18.5.50 where $\delta_2 = g_2/12$ 18.5.51 $\delta_3 = g_3/20$

⁵ In this and other series a choice of the value of the root has been made so that z will be in the Fundamental Rectangle (Figure 18.2), whenever the value of the given function is appropriate.

Other Series Involving \mathcal{P}

Series near z_0 [$\mathcal{P}(z_0)=0$]

18.5.52

$$\begin{aligned} \mathcal{P} = \mathcal{P}'_0 u & \left[1 - 3c_2 u^4 - 4c_3 u^6 + \frac{10c_2^2}{3} u^8 + \frac{114c_2 c_3}{11} u^{10} \right. \\ & + \frac{7(12c_3^2 - 5c_2^2)}{13} u^{12} - \frac{488c_2^2 c_3}{33} u^{14} \left. \right] + u^2 \left[-5c_2 - 14c_3 u^2 \right. \\ & + 5c_2^2 u^4 + 33c_2 c_3 u^6 + \frac{84c_3^2 - 10c_2^3}{3} u^8 - \frac{1363c_2^2 c_3}{33} u^{10} \\ & \left. + \frac{5c_2(55c_3^2 - 2316c_2^2)u^{12}}{143} \right] + \dots \end{aligned}$$

18.5.53

where $u=(z-z_0)$, $\mathcal{P}'_0 \equiv \mathcal{P}'(z_0) = i\sqrt{g_3}$

18.5.54

$$\begin{aligned} u = \mathcal{P}'_0 [v + av^2 + 2a^2 v^3 + \left(\frac{g_3 \mathcal{P}'_0{}^2}{2} + 5a^3 \right) v^4 + \frac{a}{5} (3 \mathcal{P}'_0{}^4 \\ + 15g_3 \mathcal{P}'_0{}^2 + 70a^3) v^5 + 2a^2 (2 \mathcal{P}'_0{}^4 + 7g_3 \mathcal{P}'_0{}^2 + 21a^3) v^6 \\ + \left(\frac{g_3 \mathcal{P}'_0{}^6}{7} + \{g_3^2 + 20a^3\} \mathcal{P}'_0{}^4 + 15a^2 g_3 \mathcal{P}'_0{}^2 + 132a^6 \right) v^7 \\ + 15a \left(\frac{g_3 \mathcal{P}'_0{}^6}{4} + \left\{ \frac{3g_3^2}{4} + 6a^3 \right\} \mathcal{P}'_0{}^4 + \frac{33ag_3}{2} \mathcal{P}'_0{}^2 \right. \\ \left. + \frac{143a^6}{5} \right) v^8 + \frac{5a^2}{2} \left(\frac{2}{3} \mathcal{P}'_0{}^8 + 15g_3 \mathcal{P}'_0{}^6 \right. \\ \left. + \{154a^3 + 33g_3^2\} \mathcal{P}'_0{}^4 + \frac{2002a^3 g_3 \mathcal{P}'_0{}^2}{5} + 572a^6 \right) v^9 \\ + \frac{1}{4} \left(3 \{28a^3 + g_3^2\} \mathcal{P}'_0{}^8 + 11g_3 \{98a^3 + g_3^2\} \mathcal{P}'_0{}^6 \right. \\ \left. + 2002a^3 \left\{ \frac{16}{5} a^3 + g_3^2 \right\} \mathcal{P}'_0{}^4 \right. \\ \left. + 16016 a^6 g_3 \mathcal{P}'_0{}^2 + 19448 a^9 \right) v^{10}] + \dots \end{aligned}$$

18.5.55 where $v = \mathcal{P} / (\mathcal{P}'_0)^2$ and $a = g_2/4$

Series near ω_1

18.5.56

$$\begin{aligned} (\mathcal{P} - e_1) = (3e_1^2 - 5c_2)u + (10c_2 e_1 + 21c_3)u^2 + (7c_2 e_1^2 \\ + 21c_3 e_1 + 5c_2^2)u^3 + (18c_3 e_1^2 + 30c_2^2 e_1 \\ + 33c_2 c_3)u^4 + (22c_2^2 e_1^2 + 92c_2 c_3 e_1 + 105c_2^3 \\ - \frac{10c_2^2}{3})u^5 + \left(\frac{728}{11} c_2 c_3 e_1^2 + \frac{220}{3} c_2^2 e_1 + 84c_3^2 e_1 \right. \\ \left. + \frac{1214}{11} c_2^2 c_3 \right) u^6 + \left(\frac{635}{13} c_2^2 e_1^2 + \frac{855}{13} c_2^2 e_1^2 \right. \\ \left. + \frac{3405}{11} c_2^2 c_3 e_1 + \frac{45750}{143} c_2 c_3^2 + \frac{25}{13} c_2^2 \right) u^7 + \dots \end{aligned}$$

18.5.57

where $u = (z - \omega_1)^2$

Other Series Involving \mathcal{P}'

Series near z_0

18.5.58

$$\begin{aligned} (\mathcal{P}' - \mathcal{P}'_0) = & \left[-10c_2 u - 56c_3 u^3 + 30c_2^2 u^5 + 264c_2 c_3 u^7 \right. \\ & + \frac{(840c_3^2 - 100c_2^2)}{3} u^9 - \frac{5452c_2^2 c_3}{11} u^{11} \\ & \left. + \frac{70c_2(55c_3^2 - 2316c_2^2)}{143} u^{13} \right] \\ & + \mathcal{P}'_0 \left[-15c_2 u^4 - 28c_3 u^6 + 30c_2^2 u^8 + 114c_2 c_3 u^{10} \right. \\ & \left. + 7(12c_3^2 - 5c_2^2)u^{12} - \frac{2440c_2^2 c_3}{11} u^{14} \right] + \dots \end{aligned}$$

18.5.59

where $u = (z - z_0)$

18.5.60

$$\begin{aligned} (z - z_0) = & A - bA^3 - \frac{3\mathcal{P}'_0}{2} A^4 + 3(c_2 + b^2)A^5 \\ & + 10b \mathcal{P}'_0 A^6 - 3[36c_3 - 3\mathcal{P}'_0 + 4b^3]A^7 \\ & - 3\mathcal{P}'_0 \left(\frac{25}{2} c_2 + 21b^2 \right) A^8 + \frac{5}{12} (285b^2 c_2 \\ & + 100c_2^2 - 279\mathcal{P}'_0{}^2 b + 132b^4) A^9 + \dots \end{aligned}$$

18.5.61

where $A = (\mathcal{P}' - \mathcal{P}'_0) / (-10c_2)$

18.5.62

and $b = 4g_3/g_2$

Series near ω_1

18.5.63

$$\begin{aligned} \mathcal{P}' = & 2(3e_1^2 - 5c_2)\alpha + 4(10c_2 e_1 + 21c_3)\alpha^3 + 6(7c_2 e_1^2 \\ & + 21c_3 e_1 + 5c_2^2)\alpha^5 + 24(6c_3 e_1^2 + 10c_2^2 e_1 \\ & + 11c_2 c_3)\alpha^7 + 10 \left(22c_2^2 e_1^2 + 92c_2 c_3 e_1 + 105c_2^3 \right. \\ & \left. - \frac{10c_2^2}{3} \right) \alpha^9 + 24 \left(\frac{364}{11} c_2 c_3 e_1^2 + \frac{110}{3} c_2^2 e_1 \right. \\ & \left. + 42c_3^2 e_1 + \frac{607}{11} c_2^2 c_3 \right) \alpha^{11} + 70 \left(\frac{127}{13} c_2^2 e_1^2 \right. \\ & \left. + \frac{171}{13} c_2^2 e_1^2 + \frac{681}{11} c_2^2 c_3 e_1 + \frac{9150}{143} c_2 c_3^2 + \frac{5}{13} c_2^2 \right) \alpha^{13} \\ & + \dots \end{aligned}$$

18.5.64

where $\alpha = (z - \omega_1)$.

Other Series Involving ζ

Series near z_0 [$\mathcal{P}(z_0)=0$]

18.5.65

$$\zeta - \zeta_0 = \mathcal{P}'_0 \left[-\frac{u^2}{2} + \frac{c_2 u^6}{2} + \frac{c_3 u^8}{2} - \frac{c_2^2 u^{10}}{3} - \frac{19c_2 c_3 u^{12}}{22} \right. \\ \left. + \frac{(5c_2^3 - 12c_3^2)}{26} u^{14} + \frac{61c_2^2 c_3 u^{16}}{66} \right] + \left[\frac{5c_2 u^3}{3} \right. \\ \left. + \frac{7c_3 u^5}{2} - \frac{5c_2^2 u^7}{7} - \frac{11c_2 c_3 u^9}{3} + \frac{(10c_2^3 - 84c_3^2)}{33} u^{11} \right. \\ \left. + \frac{1363c_2^2 c_3}{429} u^{13} + \frac{c_2(2316c_2^2 - 55c_3^2)}{429} u^{15} \right] + \dots,$$

18.5.66 where $u = (z - z_0)$,

18.5.67 $\zeta_0 \equiv \zeta(z_0)$

Series near ω_i

18.5.68

$$(\zeta - \eta_i) = -e_i \alpha - \frac{(3e_i^2 - 5c_2)}{3} \alpha^3 - \frac{(10c_2 e_i + 21c_3) \alpha^5}{5} \\ - \frac{(7c_2 e_i^2 + 21c_3 e_i + 5c_2^2) \alpha^7}{7} \\ - \frac{(6c_3 e_i^2 + 10c_2^2 e_i + 11c_2 c_3) \alpha^9}{3} \\ - \frac{(22c_2^2 e_i^2 + 92c_2 c_3 e_i + 105c_3^2 - \frac{10}{3} c_2^3) \alpha^{11}}{11} \\ - \frac{2}{13} \left(\frac{364}{11} c_2 c_3 e_i^2 + \frac{110}{3} c_2^2 e_i + 42c_3^2 e_i \right. \\ \left. + \frac{607}{11} c_2^2 c_3 \right) \alpha^{13} - \frac{1}{3} \left(\frac{127}{13} c_2^3 e_i^2 + \frac{171}{13} c_2^2 c_3 e_i \right. \\ \left. + \frac{681}{11} c_2^2 c_3 e_i + \frac{9150}{143} c_2 c_3^2 + \frac{5}{13} c_2^4 \right) \alpha^{15} - \dots,$$

18.5.69

where $\alpha = (z - \omega_i)$

Reversed Series for Small $|\sigma|$

18.5.70

$$z = \sigma + \frac{\gamma_2}{5} \sigma^5 + \frac{\gamma_3}{7} \sigma^7 + \frac{3\gamma_2^2}{14} \sigma^9 \\ + \frac{19\gamma_2\gamma_3}{55} \sigma^{11} + \frac{3842\gamma_2^2 + 861\gamma_3^2}{6006} \sigma^{13} + \dots,$$

18.5.71

where $\gamma_2 = g_2/48$

18.5.72

$\gamma_3 = g_3/120$

For reversion of Maclaurin series, see 3.6.25 and [18.18].

18.6. Derivatives and Differential Equations

Ordinary ($c_2 = g_2/20, c_3 = g_3/28$)

18.6.1

$$\zeta'(z) = -\mathcal{P}(z)$$

18.6.2

$$\sigma'(z)/\sigma(z) = \zeta(z)$$

18.6.3

$$\mathcal{P}''(z) = 4\mathcal{P}^3(z) - g_2\mathcal{P}(z) - g_3 = 4(\mathcal{P}^3 - 5c_2\mathcal{P} - 7c_3)$$

18.6.4

$$\mathcal{P}''(z) = 6\mathcal{P}^2(z) - \frac{1}{2}g_2 = 6\mathcal{P}^2 - 10c_2$$

18.6.5

$$\mathcal{P}'''(z) = 12\mathcal{P}\mathcal{P}'$$

18.6.6

$$\mathcal{P}^{(4)}(z) = 12(\mathcal{P}\mathcal{P}'' + \mathcal{P}'\mathcal{P}') \\ = 5! \left[\mathcal{P}^3 - 3c_2\mathcal{P} - \frac{14c_3}{5} \right]$$

18.6.7

$$\mathcal{P}^{(5)}(z) = 12(\mathcal{P}\mathcal{P}''' + 2\mathcal{P}'\mathcal{P}'' + \mathcal{P}''\mathcal{P}') \\ = 3 \cdot 5! \mathcal{P}'[\mathcal{P}^2 - c_2]$$

18.6.8

$$\mathcal{P}^{(6)}(z) = 12(\mathcal{P}\mathcal{P}^{(4)} + 3\mathcal{P}'\mathcal{P}''' + 3\mathcal{P}''\mathcal{P}'' \\ + \mathcal{P}'''\mathcal{P}')$$

18.6.9

$$= 7! [\mathcal{P}^4 - 4c_2\mathcal{P}^2 - 4c_3\mathcal{P} + 5c_2^2/7]$$

18.6.10

$$\mathcal{P}^{(7)}(z) = 4 \cdot 7! \mathcal{P}'[\mathcal{P}^3 - 2c_2\mathcal{P} - c_3]$$

18.6.11

$$\mathcal{P}^{(8)}(z) = 9! [\mathcal{P}^5 - 5c_2\mathcal{P}^3 - 5c_3\mathcal{P}^2 \\ + (10c_2^2\mathcal{P} + 11c_2c_3)/3]$$

18.6.12

$$\mathcal{P}^{(9)}(z) = 5 \cdot 9! \mathcal{P}'[\mathcal{P}^4 - 3c_2\mathcal{P}^2 - 2c_3\mathcal{P} + 2c_2^2/3]$$

18.6.13

$$\mathcal{P}^{(10)}(z) = 11! [\mathcal{P}^6 - 6c_2\mathcal{P}^4 - 6c_3\mathcal{P}^3 + 7c_2^2\mathcal{P}^2 \\ + (342c_2c_3\mathcal{P} + 84c_2^2 - 10c_3^2)/33]$$

18.6.14

$$\mathcal{P}^{(11)}(z) = 6 \cdot 11! \mathcal{P}'[\mathcal{P}^5 - 4c_2\mathcal{P}^3 - 3c_3\mathcal{P}^2 \\ + (77c_2^2\mathcal{P} + 57c_2c_3)/33]$$

18.6.15

$$\mathcal{P}^{(12)}(z) = 13! [\mathcal{P}^7 - 7c_2\mathcal{P}^5 - 7c_3\mathcal{P}^4 + 35c_2^2\mathcal{P}^3/3 \\ + 210c_2c_3\mathcal{P}^2/11 + (84c_2^3 - 35c_3^2)\mathcal{P}/13 - 1363c_2^2c_3/429]$$

18.6.16

$$\mathcal{P}^{(13)}(z) = 7 \cdot 13! \mathcal{P}'[\mathcal{P}^6 - 5c_2\mathcal{P}^4 - 4c_3\mathcal{P}^3 \\ + 5c_2^2\mathcal{P}^2 + 60c_2c_3\mathcal{P}/11 + (12c_2^3 - 5c_3^2)/13]$$

18.6.17

$$\mathcal{P}^{(14)}(z) = 15! [\mathcal{P}^8 - 8c_2\mathcal{P}^6 - 8c_3\mathcal{P}^5 + 52c_2^2\mathcal{P}^4/3 \\ + 328c_2c_3\mathcal{P}^3/11 + (444c_2^3 - 328c_3^2)\mathcal{P}^2/39 \\ - 488c_2^2c_3\mathcal{P}/33 + c_2(55c_2^3 - 2316c_2^2)/429]$$

18.6.18

$$\mathcal{P}^{(15)}(z) = 8 \cdot 15! \mathcal{P}'[\mathcal{P}^7 - 6c_2\mathcal{P}^5 - 5c_3\mathcal{P}^4 + 26c_2^2\mathcal{P}^3/3 \\ + 123c_2c_3\mathcal{P}^2/11 + (111c_2^3 - 82c_3^2)\mathcal{P}/39 - 61c_2^2c_3/33]$$

Partial Derivatives with Respect to Invariants

18.6.19

$$\Delta \frac{\partial \mathcal{P}}{\partial g_3} = \mathcal{P}' \left(3g_2 \zeta - \frac{9}{2} g_3 z \right) + 6g_2 \mathcal{P}^2 - 9g_3 \mathcal{P} - g_2^2$$

18.6.20

$$\Delta \frac{\partial \mathcal{P}}{\partial g_2} = \mathcal{P}' \left(-\frac{9}{2} g_3 \zeta + \frac{g_2^2 z}{4} \right) - 9g_3 \mathcal{P}^2 + \frac{g_2^2}{2} \mathcal{P} + \frac{3}{2} g_2 g_3$$

18.6.21

$$\Delta \frac{\partial \zeta}{\partial g_3} = -3\zeta \left(g_2 \mathcal{P} + \frac{3}{2} g_3 \right) + \frac{1}{2} z \left(9g_3 \mathcal{P} + \frac{1}{2} g_2^2 \right) - \frac{3}{2} g_2 \mathcal{P}'$$

18.6.22

$$\Delta \frac{\partial \zeta}{\partial g_2} = \frac{1}{2} \zeta \left(9g_3 \mathcal{P} + \frac{1}{2} g_2^2 \right) - \frac{1}{2} g_2 z \left(\frac{1}{2} g_2 \mathcal{P} + \frac{3}{4} g_3 \right) + \frac{9}{4} g_3 \mathcal{P}'$$

$$18.6.23 \quad \Delta \frac{\partial \sigma}{\partial g_3} = \frac{3}{2} g_2 \sigma'' + \frac{9}{2} g_3 \sigma + \frac{1}{8} g_2^2 z^2 \sigma - \frac{9}{2} g_2 z \sigma'$$

18.6.24

$$\Delta \frac{\partial \sigma}{\partial g_2} = -\frac{9}{4} g_3 \sigma'' - \frac{1}{4} g_2^2 \sigma - \frac{3}{16} g_2 g_3 z^2 \sigma + \frac{1}{4} g_2^2 z \sigma'$$

(here ' denotes $\frac{\partial}{\partial z}$)

Differential Equations

18.6.25

Equation

Solution

$$y'^3 = y^2(y-a)^2 \quad y = \frac{a}{2} + \frac{27}{16} \mathcal{P}' \left(\frac{z}{2}; 0, -\frac{64a^2}{729} \right)$$

18.6.26

$$y'^3 = (y^3 - 3ay^2 + 3y)^2 \quad y = \frac{2}{a-3} \mathcal{P}'(z; 0, g_3),$$

$$g_3 = \frac{4-3a^2}{27}$$

18.6.27

$$y'^4 = \frac{128}{3} (y+a)^2 (y+b)^3 \quad y = 6 \mathcal{P}^2(z; g_2, 0) - b,$$

$$g_2 = -\frac{2}{3} (a-b)$$

$y'' = [a \mathcal{P}(z) + b]y$ (Lamé's equation)—see [18.8], 2.26

For other (more specialized) equations (of orders 1-3) involving $\mathcal{P}(z)$, see [18.8], nos. 1.49, 2.28, 2.72-3, 2.439-440, 3.9-12.

For the use of $\mathcal{P}(z)$ in solving differential equations of the form $y'^m + A(z,y) = 0$, where $A(z,y)$ is a polynomial in y of degree $2m$, with coefficients which are analytic functions of z , see [18.7], p. 312ff.

18.7. Integrals

Indefinite

$$18.7.1 \quad \int \mathcal{P}^2(z) dz = \frac{1}{6} \mathcal{P}'(z) + \frac{1}{12} g_2 z$$

$$18.7.2 \quad \int \mathcal{P}^3(z) dz = \frac{1}{120} \mathcal{P}'''(z) - \frac{3}{20} g_2 \zeta(z) + \frac{1}{10} g_3 z$$

(formulas for higher powers may be derived by integration of formulas for $\mathcal{P}^{(2k)}(z)$)

For $\int \mathcal{P}^n(z) dz$, n any positive integer, see [18.15] vol. 4, pp. 108-9.

If $\mathcal{P}'(a) \neq 0$

18.7.3

$$\mathcal{P}'(a) \int \frac{dz}{\mathcal{P}(z) - \mathcal{P}(a)} = 2z\zeta(a) + \ln \sigma(z-a) - \ln \sigma(z+a)$$

For $\int dz / [\mathcal{P}(z) - \mathcal{P}(a)]^n$, ($\mathcal{P}'(a) \neq 0$) n any positive integer, see [18.15], vol. 4, pp. 109-110.

Definite

 $\Delta > 0$ $\Delta < 0$

18.7.4

$$\omega = \int_{a_1}^{\infty} \frac{dt}{\sqrt{s(t)}} \quad \omega_2 = \int_{a_2}^{\infty} \frac{dt}{\sqrt{s(t)}}$$

18.7.5

$$\omega' = i \int_{-\infty}^{a_3} \frac{dt}{\sqrt{|s(t)|}} \quad \omega'_2 = i \int_{-\infty}^{a_2} \frac{dt}{\sqrt{|s(t)|}}$$

18.7.6

where t is real and

18.7.7

$$s(t) = 4t^3 - g_2 t - g_3$$

18.8 Conformal Mapping

$$w = u + iv$$

$$\Delta > 0$$

$w = \mathcal{P}(z)$ maps the Fundamental Rectangle onto the half-plane $v \leq 0$; if $|\omega'| = \omega(g_3 = 0)$, the isosceles triangle $0\omega\omega_2$ is mapped onto $u \geq 0, v \leq 0$.

$w = \mathcal{P}'(z)$ maps the Fundamental Rectangle onto the w -plane less quadrant III; if $|\omega'| = \omega$, the triangle $0\omega\omega_2$ is mapped onto $v \geq 0, v \geq u$.

(a = period ratio)

$w = \zeta(z)$ maps the Fundamental Rectangle onto the half-plane $u \geq 0$. If $a \leq 1.9$ (approx.), $v \leq 0$; otherwise the image extends into quadrant I. For very large a , the image has a large area in quadrant I.

$w = \sigma(z)$ maps the Fundamental Rectangle onto quadrant I if $a < 1.9$ (approx.), onto quadrants I and II if $1.9 \leq a < 3.8$ (approx.). For large a , $\arg[\sigma(\omega_2)] \approx \frac{\pi^2 a}{12}$; consequently the image winds around the origin for large a .

Other maps are described in [18.23] arts. 13.7 (square on circle), 13.11 (ring on plane with 2 slits in line) and in [18.24], p. 35 (double half equilateral triangle on half-plane).

$$\Delta < 0$$

$w = \mathcal{P}(z)$ maps the Fundamental Rectangle onto the half-plane $v \leq 0$; if $|\omega'_2| = \omega_2(g_3 = 0)$, the isosceles triangle $0\omega_2\omega'$ is mapped onto $u \geq 0, v \leq 0$.

$w = \mathcal{P}'(z)$ maps the Fundamental Rectangle onto most of the w -plane less quadrant III; if $|\omega'_2| = \omega_2$, the triangle $0\omega_2\omega'$ is mapped onto $v \geq 0, v \geq u$.

$w = \zeta(z)$ maps the Fundamental Rectangle onto the half-plane $u \geq 0$. The image is mostly in quadrant IV for small a , entirely so for (approx.) $1.3 \leq a \leq 3.8$. For very large a , the image has a large area in quadrant I.

$w = \sigma(z)$ maps the Fundamental Rectangle onto quadrant I if $a < 3.8$ (approx.), onto quadrants I and II if $3.8 \leq a < 7.6$ (approx.). For large a , $\arg\left[\sigma\left(\omega_2 + \frac{\omega'_2}{2}\right)\right] \approx \frac{\pi^2 a}{24}$; consequently the image winds around the origin for large a .

Other maps are described in [18.23] arts. 13.8 (equilateral triangle on half-plane) and 13.9 (isosceles triangle on half-plane).

Obtaining \mathcal{P}' from \mathcal{P}'^2

Fundamental Rectangle

$$\Delta > 0$$

FUNDAMENTAL RECTANGLE

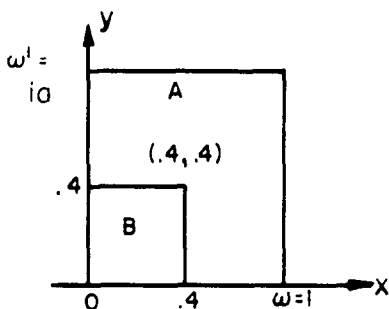

In region A

$\Re(\mathcal{P}') \geq 0$ if $y \geq .4$ and $x \leq .5$; $\Im(\mathcal{P}') \geq 0$ elsewhere

Fundamental Rectangle

$$\Delta < 0$$

FUNDAMENTAL RECTANGLE

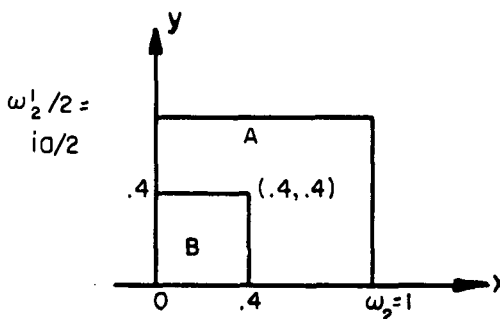

In region A

(1) If $a \geq 1.05$, use criterion for region A for $\Delta > 0$.

(2) If $1 \leq a < 1.05$: $\Re(\mathcal{P}') \geq 0$ if $y \geq .4$ and $x \leq .4$, $-\pi/4 < \arg(\mathcal{P}') < 3\pi/4$ if $.4 < y \leq .5$ and $.4 < x \leq .5$. $\Im(\mathcal{P}') \geq 0$ elsewhere

FIGURE 18.4

In region B

The sign (indeed, perhaps one or more significant digits) of \mathcal{P}' is obtainable from the first term, $-2/z^3$, of the Laurent series for \mathcal{P}' .

(Precisely similar criteria apply when the real half-period $\neq 1$)

In region B

Use the criterion for region B for $\Delta > 0$.

$\Delta > 0 \quad \omega = 1$
 Map: $\mathcal{P}(z) = u + iv$
 Near zero: $\mathcal{P}(z) = \frac{1}{z^2} + \epsilon_1$
 $\mathcal{P}(z) = \frac{1}{z^2} + c_2 z^2 + \epsilon_2$
 $\omega' = i$

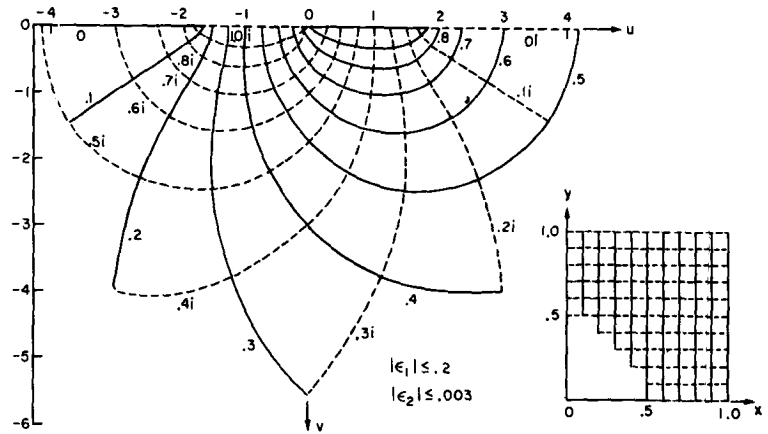

$\omega' = 1.4i$

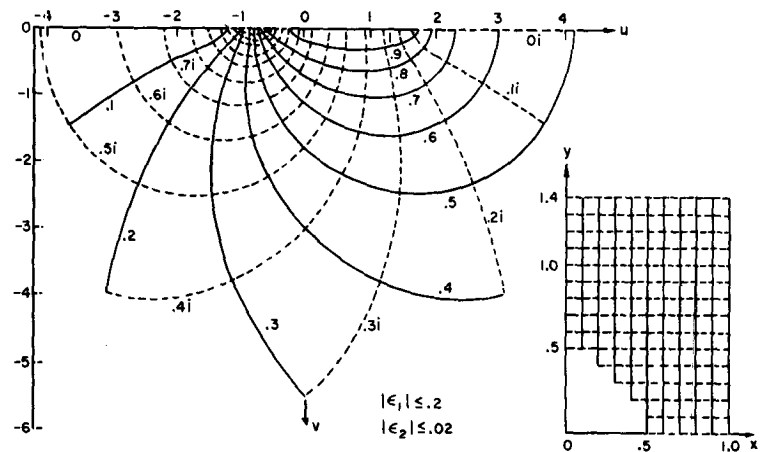

$\omega' = 2.0i$

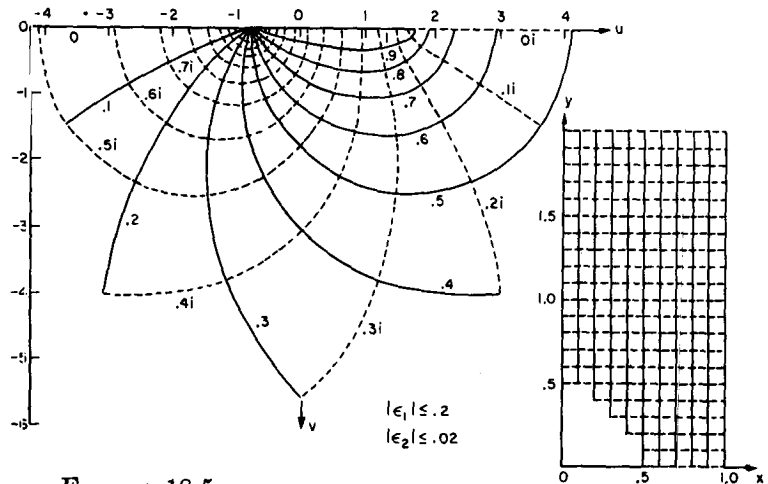

FIGURE 18.5

$$\Delta < 0 \quad \omega_2 = 1$$

Map: $\mathcal{P}(z) = u + iv$

Near zero: $\mathcal{P}(z) = \frac{1}{z^2} + \epsilon_1$

$$\mathcal{P}(z) = \frac{1}{z^2} + c_2 z^2 + \epsilon_2$$

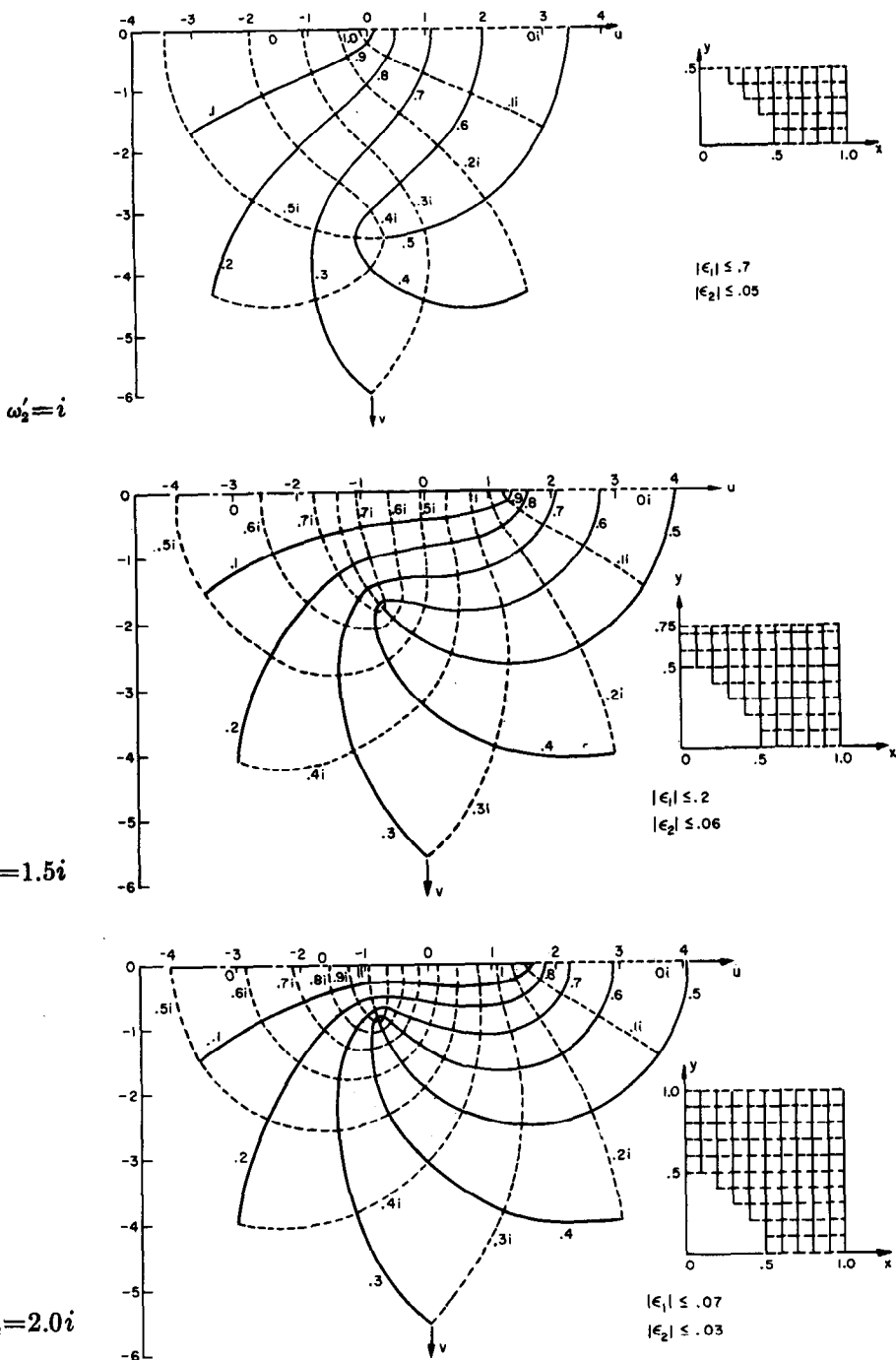

FIGURE 18.6

$$\Delta > 0 \quad \omega = 1$$

$$\text{Map: } \zeta(z) = u + iv$$

$$\text{Near zero: } \zeta(z) = \frac{1}{z} + \epsilon_1$$

$$\zeta(z) = \frac{1}{z} - \frac{c_2 z^3}{3} + \epsilon_2$$

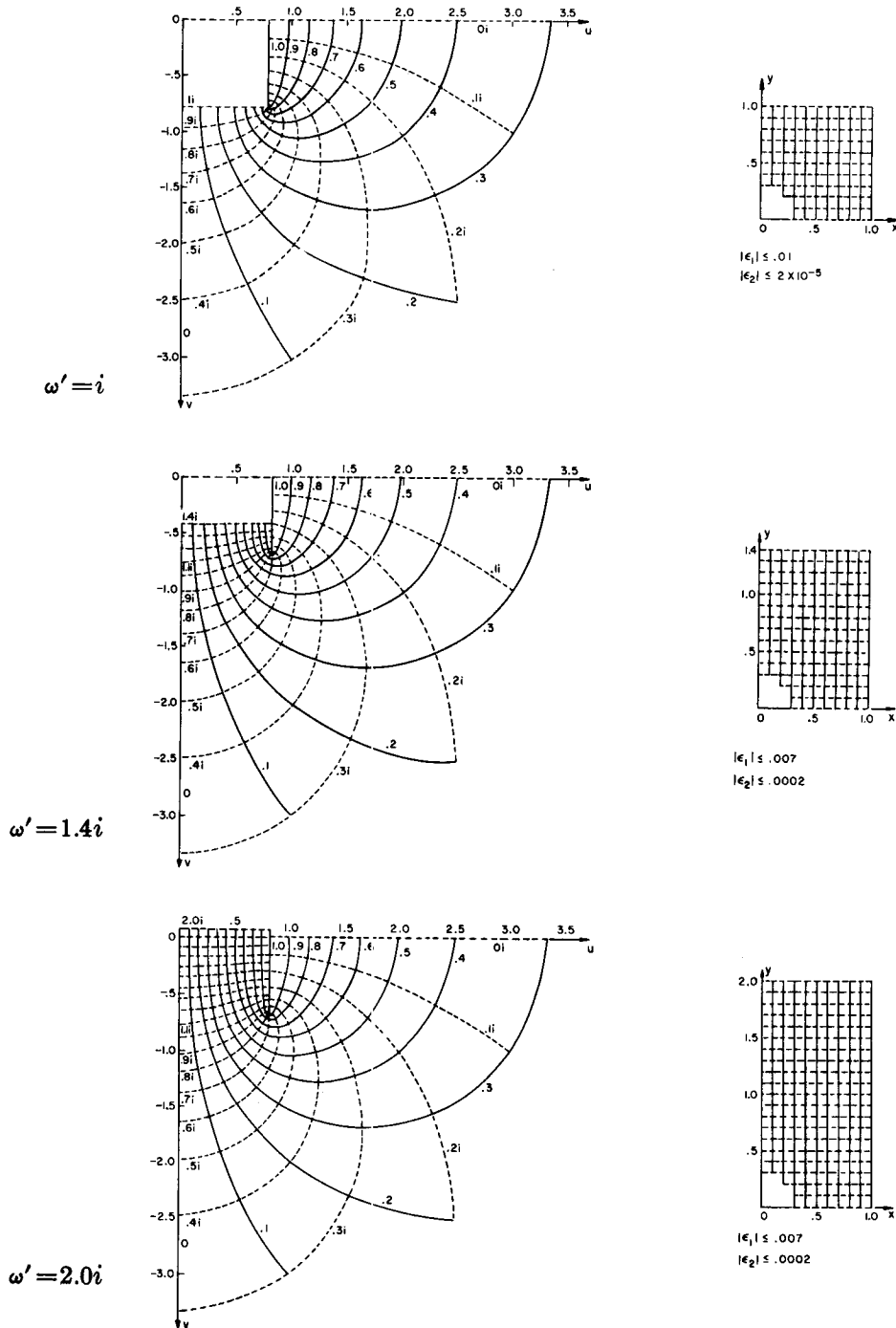

FIGURE 18.7

$$\Delta < 0 \quad \omega_2 = 1$$

Map: $\zeta(z) = u + iv$

Near zero: $\zeta(z) = \frac{1}{z} + \epsilon_1$

$$\zeta(z) = \frac{1}{z} - \frac{c_2 z^3}{3} + \epsilon_2$$

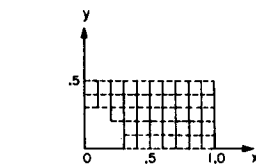
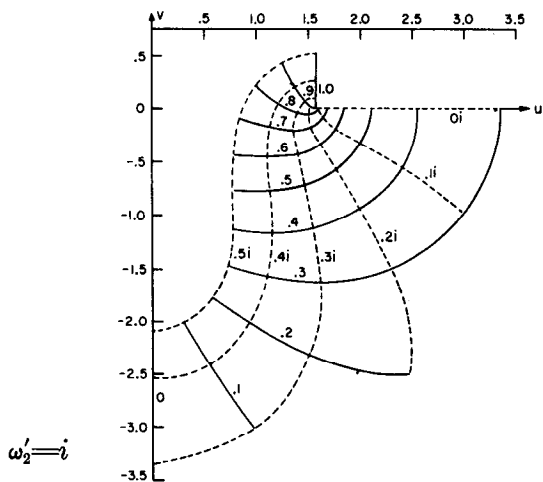

$$|\epsilon_1| \leq .04$$

$$|\epsilon_2| \leq .0002$$

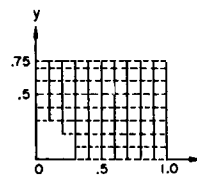
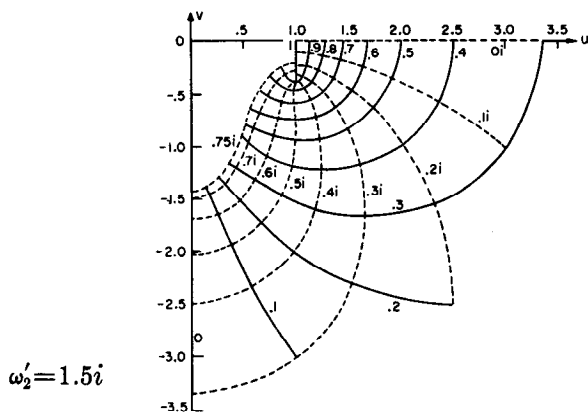

$$|\epsilon_1| \leq .007$$

$$|\epsilon_2| \leq .0009$$

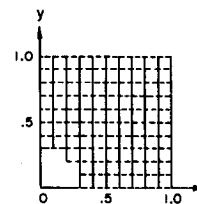
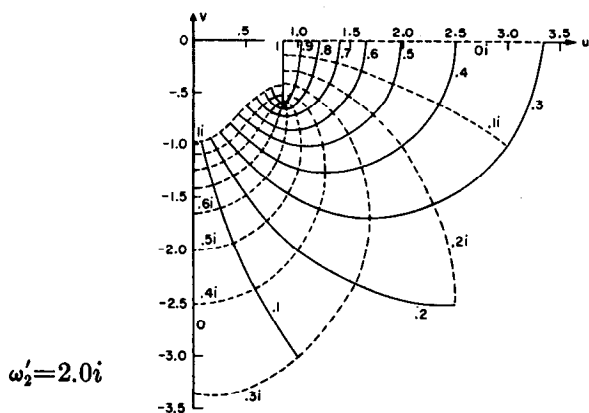

$$|\epsilon_1| \leq .004$$

$$|\epsilon_2| \leq .0004$$

FIGURE 18.8

$\Delta > 0 \quad \omega = 1$

Map: $\sigma(z) = u + iv$

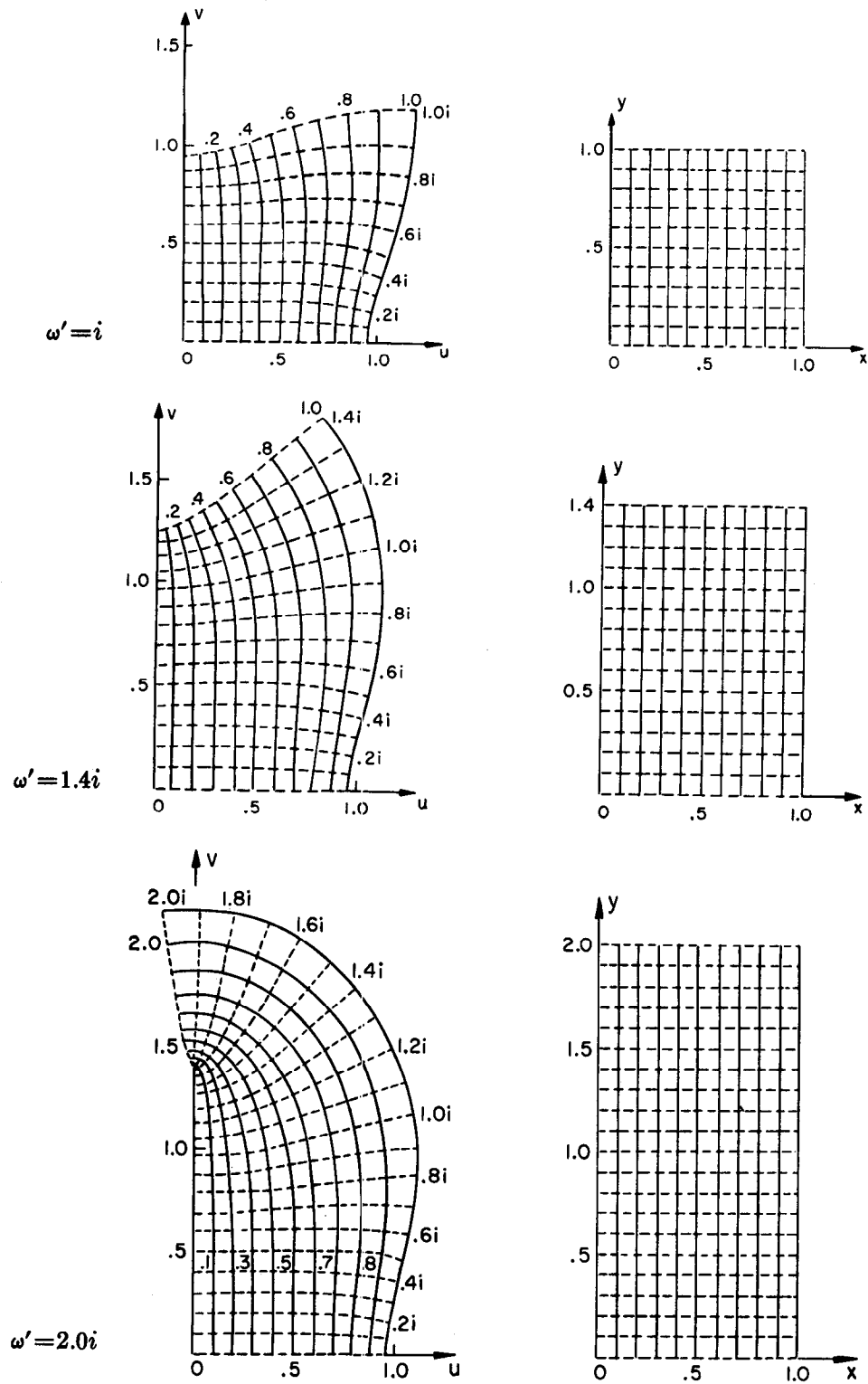

FIGURE 18.9

$\Delta < 0 \quad \omega_2 = 1$

Map: $\sigma(z) = u + iv$

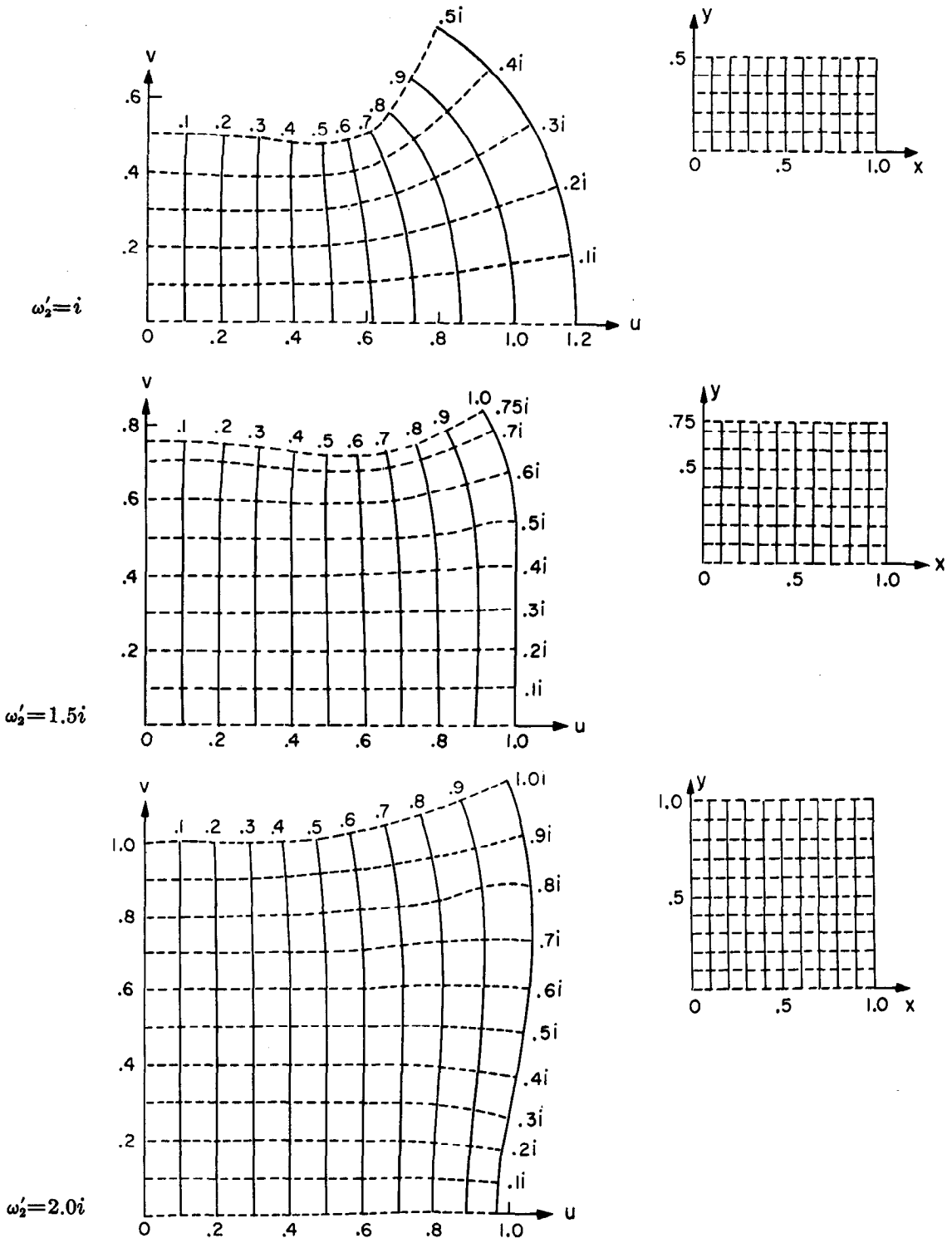

FIGURE 18.10

**18.9. Relations with Complete Elliptic Integrals K and K' and Their Parameter m
and with Jacobi's Elliptic Functions (see chapter 16)**

(Here $K(m)$ and $K'(m)=K(1-m)$ are complete elliptic integrals of the 1st kind; see chapter 17.)

$$\Delta > 0$$

$$\Delta < 0$$

18.9.1

$$e_1 = \frac{(2-m)K^2(m)}{3\omega^2}$$

$$e_1 = \frac{(2m-1)+6i\sqrt{m-m^2}}{3\omega_2^2} \cdot K^2(m)$$

18.9.2

$$e_2 = \frac{(2m-1)K^2(m)}{3\omega^2}$$

$$e_2 = \frac{2(1-2m)K^2(m)}{3\omega_2^2}$$

18.9.3

$$e_3 = \frac{-(m+1)K^2(m)}{3\omega^2}$$

$$e_3 = \frac{(2m-1)-6i\sqrt{m-m^2}}{3\omega_2^2} \cdot K^2(m)$$

18.9.4

$$g_2 = \frac{4(m^2-m+1)K^4(m)}{3\omega^4}$$

$$g_2 = \frac{4(16m^2-16m+1)K^4(m)}{3\omega_2^4}$$

18.9.5

$$g_3 = \frac{4(m-2)(2m-1)(m+1)K^6(m)}{27\omega^6}$$

$$g_3 = \frac{8(2m-1)(32m^2-32m-1)K^6(m)}{27\omega_2^6}$$

18.9.6

$$\Delta = \frac{16m^2(m-1)^2K^{12}(m)}{\omega^{12}}$$

$$\Delta = \frac{-256(m-m^2)K^{12}(m)}{\omega_2^{12}}$$

18.9.7

$$\omega' = \frac{iK'(m)\omega}{K(m)}$$

$$\omega_2' = \frac{iK'(m)\omega_2}{K(m)}$$

18.9.8

$$\omega = K(m)/(e_1 - e_3)^{1/2}$$

$$\omega_2 = K(m)/H_2^{1/2}$$

18.9.9

$$m = (e_2 - e_3)/(e_1 - e_3)$$

$$m = \frac{1}{2} \frac{3e_2}{4H_2}$$

18.9.10

$$[0 < m \leq \frac{1}{2}, \text{ since } g_3 \geq 0]$$

18.9.11

$$\mathcal{P}(z) = e_3 + (e_1 - e_3)/\text{sn}^2(z^*|m)$$

$$\mathcal{P}(z) = e_2 + H_2 \frac{1 + \text{cn}(z'|m)}{1 - \text{cn}(z'|m)}$$

18.9.12

$$\mathcal{P}'(z) = -2(e_1 - e_3)^{3/2} \cdot \text{cn}(z^*|m) \text{dn}(z^*|m) / \text{sn}^3(z^*|m)$$

$$\mathcal{P}'(z) = \frac{-4H_2^{3/2} \text{sn}(z'|m) \text{dn}(z'|m)}{[1 - \text{cn}(z'|m)]^2}$$

where

$$z^* = (e_1 - e_3)^{1/2} z$$

where

$$z' = 2zH_2^{1/2}$$

18.9.13

$$\eta = \zeta(\omega) = \frac{K(m)}{3\omega} [3E(m) + (m-2)K(m)]$$

$$\eta_2 = \zeta(\omega_2) = \frac{K(m)}{3\omega_2} [6E(m) + (4m-5)K(m)]$$

18.9.14

$$\eta' = \zeta(\omega') = \frac{\eta\omega' - \frac{1}{2}\pi i}{\omega}$$

$$\eta_2' = \zeta(\omega_2') = \frac{\eta_2\omega_2' - \pi i}{\omega_2}$$

[$E(m)$ is a complete elliptic integral of the 2d kind (see chapter 17).]

18.10. Relations with Theta Functions (chapter 16)

The formal definitions of the four ϑ functions are given by the series 16.27.1–16.27.4 which converge for all complex z and all q defined below. (Some authors use πz , instead of z , as the independent variable.) These functions depend on z and on a parameter q , which is usually suppressed. Note that

$$\vartheta_1'(0) = \vartheta_2(0)\vartheta_3(0)\vartheta_4(0), \text{ where } \vartheta_i(0) = \vartheta_i(0, q).$$

$$\Delta > 0$$

$$\Delta < 0$$

18.10.1

$$\tau = \omega'/\omega$$

$$\tau_2 = \omega_2'/2\omega_2$$

18.10.2

$$q = e^{i\pi\tau} = e^{-\pi K'/K}$$

$$q = iq_2 = ie^{i\pi\tau_2} = ie^{-\pi|\omega_2'|/2\omega_2}$$

18.10.3

q is real and since $g_3 \geq 0$ ($|\omega'| \geq \omega$), $0 < q \leq e^{-\pi}$

q is pure imaginary and since $g_3 \geq 0$ ($|\omega_2'| \geq \omega_2$), $0 < |q| \leq e^{-\pi/2}$

18.10.4

$$(v = \pi z/2\omega)$$

$$(v = \pi z/2\omega_2)$$

18.10.5

$$\mathcal{P}(z) = e_j + \frac{\pi^2}{4\omega^2} \left[\frac{\vartheta_1'(0)\vartheta_{j+1}(v)}{\vartheta_{j+1}(0)\vartheta_1(v)} \right]^2$$

$$\mathcal{P}(z) = e_2 + \frac{\pi^2}{4\omega_2^2} \left[\frac{\vartheta_1'(0)\vartheta_2(v)}{\vartheta_2(0)\vartheta_1(v)} \right]^2$$

$$j = 1, 2, 3$$

18.10.6

$$\mathcal{P}'(z) = -\frac{\pi^3}{4\omega^3} \frac{\vartheta_2(v)\vartheta_3(v)\vartheta_4(v)\vartheta_1'^3(0)}{\vartheta_2(0)\vartheta_3(0)\vartheta_4(0)\vartheta_1^3(v)}$$

$$\mathcal{P}'(z) = -\frac{\pi^3}{4\omega_2^3} \frac{\vartheta_2(v)\vartheta_3(v)\vartheta_4(v)\vartheta_1'^3(0)}{\vartheta_2(0)\vartheta_3(0)\vartheta_4(0)\vartheta_1^3(v)}$$

18.10.7

$$\zeta(z) = \frac{\eta z}{\omega} + \frac{\pi\vartheta_1'(v)}{2\omega\vartheta_1(v)}$$

$$\zeta(z) = \frac{\eta_2 z}{\omega_2} + \frac{\pi\vartheta_1'(v)}{2\omega_2\vartheta_1(v)}$$

18.10.8

$$\sigma(z) = \frac{2\omega}{\pi} \exp\left(\frac{\eta z^2}{2\omega}\right) \frac{\vartheta_1(v)}{\vartheta_1'(0)}$$

$$\sigma(z) = \frac{2\omega_2}{\pi} \exp\left(\frac{\eta_2 z^2}{2\omega_2}\right) \frac{\vartheta_1(v)}{\vartheta_1'(0)}$$

18.10.9

$$12\omega^2 e_1 = \pi^2[\vartheta_3^4(0) + \vartheta_4^4(0)]$$

$$12\omega_2^2 e_1 = \pi^2[\vartheta_2^4(0) - \vartheta_4^4(0)]$$

18.10.10

$$12\omega^2 e_2 = \pi^2[\vartheta_2^4(0) - \vartheta_4^4(0)]$$

$$12\omega_2^2 e_2 = \pi^2[\vartheta_3^4(0) + \vartheta_4^4(0)]$$

18.10.11

$$12\omega^2 e_3 = -\pi^2[\vartheta_2^4(0) + \vartheta_3^4(0)]$$

$$12\omega_2^2 e_3 = -\pi^2[\vartheta_2^4(0) + \vartheta_3^4(0)]$$

18.10.12

$$(e_2 - e_3)^{\frac{1}{2}} = -i(e_3 - e_2)^{\frac{1}{2}} = \frac{\pi}{2\omega} \vartheta_2^2(0)$$

$$(e_2 - e_3)^{\frac{1}{2}} = i(e_3 - e_2)^{\frac{1}{2}} = \frac{\pi}{2\omega_2} \vartheta_3^2(0)$$

18.10.13

$$(e_1 - e_3)^{\frac{1}{2}} = -i(e_3 - e_1)^{\frac{1}{2}} = \frac{\pi}{2\omega} \vartheta_3^2(0)$$

$$(e_1 - e_3)^{\frac{1}{2}} = i(e_3 - e_1)^{\frac{1}{2}} = \frac{\pi}{2\omega_2} \vartheta_2^2(0)$$

18.10.14

$$(e_1 - e_2)^{\frac{1}{2}} = -i(e_2 - e_1)^{\frac{1}{2}} = \frac{\pi}{2\omega} \vartheta_4^2(0)$$

$$(e_2 - e_1)^{\frac{1}{2}} = -i(e_1 - e_2)^{\frac{1}{2}} = \frac{\pi}{2\omega_2} \vartheta_4^2(0)$$

18.10.15

$$g_2 = \frac{2}{3} \left(\frac{\pi}{2\omega}\right)^4 [\vartheta_2^8(0) + \vartheta_3^8(0) + \vartheta_4^8(0)]$$

$$g_2 = \frac{2}{3} \left(\frac{\pi}{2\omega_2}\right)^4 [\vartheta_2^8(0) + \vartheta_3^8(0) + \vartheta_4^8(0)]$$

18.10.16

$$g_3 = 4e_1 e_2 e_3$$

$$g_3 = 4e_1 e_2 e_3$$

18.10.17

$$\Delta^{\frac{1}{2}} = \frac{\pi^3}{4\omega^3} \vartheta_1'^2(0)$$

$$(-\Delta)^{\frac{1}{2}} = \frac{\pi^3}{4\omega_2^3} \vartheta_1'^2(0) e^{-i\pi/4}$$

18.10.18

$$\eta \equiv \zeta(\omega) = -\frac{\pi^2 \vartheta_1'''(0)}{12\omega \vartheta_1'(0)}$$

$$\eta_2 \equiv \zeta(\omega_2) = -\frac{\pi^2 \vartheta_1'''(0)}{12\omega_2 \vartheta_1'(0)}$$

18.10.19

$$\eta' \equiv \zeta(\omega') = \frac{\eta\omega' - \frac{1}{2}\pi i}{\omega}$$

$$\eta_2' \equiv \zeta(\omega_2') = \frac{\eta_2\omega_2' - \pi i}{\omega_2}$$

Series

18.10.20

$$\vartheta_1(0) = 0$$

18.10.21

$$\vartheta_2(0) = 2q^{\frac{1}{2}}[1 + q^{1 \cdot 2} + q^{2 \cdot 3} + q^{3 \cdot 4} + \dots + q^{n(n+1)} + \dots]$$

18.10.22

$$\vartheta_3(0) = 1 + 2[q + q^4 + q^9 + \dots + q^{n^2} + \dots]$$

18.10.23

$$\vartheta_4(0) = 1 + 2[-q + q^4 - q^9 + \dots + (-1)^n q^{n^2} + \dots]$$

Attainable Accuracy

$$\Delta > 0$$

$$\Delta < 0$$

Note: $\vartheta_j(0) > 0, j=2, 3, 4$

Note: $\vartheta_2(0) = Ae^{i\pi/8}, A > 0;$

$$\Re \vartheta_3(0) > 0; \vartheta_4(0) = \overline{\vartheta_3(0)}$$

$\vartheta_j(0):$ 2 terms give at least 5S

2 terms give at least 3S

$j=2, 3, 4$ 3 terms give at least 11S

3 terms give at least 5S

4 terms give at least 21S

4 terms give at least 10S

18.11 Expressing any Elliptic Function in Terms of \mathcal{P} and \mathcal{P}'

If $f(z)$ is any elliptic function and $\mathcal{P}(z)$ has same periods, write

18.11.1

$$f(z) = \frac{1}{2}[f(z) + f(-z)] + \frac{1}{2}\{[f(z) - f(-z)]\{\mathcal{P}'(z)\}^{-1}\}\mathcal{P}'(z).$$

Since both brackets represent even elliptic functions, we ask how to express an even elliptic function $g(z)$ (of order $2k$) in terms of $\mathcal{P}(z)$. Because of the evenness, an irreducible set of zeros can be denoted by a_i ($i=1, 2, \dots, k$) and the set of points congruent to $-a_i$ ($i=1, 2, \dots, k$); correspondingly in connection with the poles we consider the points $\pm b_i, i=1, 2, \dots, k$. Then

18.11.2

$$g(z) = A \prod_{i=1}^k \left\{ \frac{\mathcal{P}(z) - \mathcal{P}(a_i)}{\mathcal{P}(z) - \mathcal{P}(b_i)} \right\}, \text{ where } A \text{ is}$$

a constant. If any a_i or b_i is congruent to the origin, the corresponding factor is omitted from the product. Factors corresponding to multiple poles (zeros) are repeated according to the multiplicity.

18.12. Case $\Delta=0(c>0)$

Subcase I

18.12.1 $g_2 > 0, g_3 < 0: (e_1=e_2=c, e_3=-2c)$

18.12.2 $H_1=H_2=0, H_3=3c$

18.12.3

$$\mathcal{P}(z; 12c^2, -8c^3) = c + 3c\{\sinh[(3c)^{\frac{1}{2}}z]\}^{-2}$$

18.12.4

$$\zeta(z; 12c^2, -8c^3) = -cz + (3c)^{\frac{1}{2}} \coth[(3c)^{\frac{1}{2}}z]$$

18.12.5

$$\sigma(z; 12c^2, -8c^3) = (3c)^{-\frac{1}{2}} \sinh[(3c)^{\frac{1}{2}}z]e^{-cz/2}$$

18.12.6

$$\omega = \infty, \omega' = (12c)^{-\frac{1}{2}}\pi i$$

18.12.7

$$\eta = \zeta(\omega) = -\infty$$

18.12.8

$$\eta' = \zeta(\omega') = -c\omega'$$

18.12.9

$$q=1, m=1$$

18.12.10

$$\sigma(\omega) = 0$$

18.12.11

$$\sigma(\omega') = \frac{2\omega' e^{\pi^2/24}}{\pi}$$

18.12.12

$$\sigma(\omega_2) = 0$$

18.12.13

$$\mathcal{P}(\omega/2) = c$$

18.12.14

$$\mathcal{P}'(\omega/2) = 0$$

18.12.15

$$\zeta(\omega/2) = -\infty$$

18.12.16

$$\sigma(\omega/2) = 0$$

18.12.17

$$\mathcal{P}(\omega'/2) = -5c$$

18.12.18

$$\mathcal{P}'(\omega'/2) = \frac{-\pi^3}{2\omega'^3}$$

18.12.19

$$\zeta(\omega'/2) = \frac{1}{2}(-c\omega' + \pi/\omega')$$

18.12.20 $\sigma(\omega'/2) = \frac{\omega' e^{\pi^2/96} \sqrt{2}}{\pi}$

18.12.21 $\mathcal{P}(\omega_2/2) = c$

18.12.22 $\mathcal{P}'(\omega_2/2) = 0$

18.12.23 $\zeta(\omega_2/2) = -\infty - \frac{c\omega'}{2}$

18.12.24 $\sigma(\omega_2/2) = 0$

Subcase II

18.12.25

$g_2 > 0, g_3 > 0: (e_1 = 2c, e_2 = e_3 = -c)$

18.12.26 $H_1 = 3c, H_2 = H_3 = 0$

18.12.27 $\mathcal{P}(z; 12c^2, 8c^3) = -c + 3c \{ \sin [(3c)^{1/2} z] \}^{-2}$

18.12.28

$\zeta(z; 12c^2, 8c^3) = cz + (3c)^{1/2} \cot [(3c)^{1/2} z]$

18.12.29

$\sigma(z; 12c^2, 8c^3) = (3c)^{-1/2} \sin [(3c)^{1/2} z] e^{cz^2/2}$

18.12.30 $\omega = (12c)^{-1/2} \pi, \omega' = i\infty$

18.12.31 $\eta = \zeta(\omega) = c\omega$

18.12.32 $\eta' = \zeta(\omega') = i\infty$

18.12.33 $q = 0, m = 0$

18.12.34 $\sigma(\omega) = \frac{2\omega e^{\pi^2/24}}{\pi}$

18.12.35 $\sigma(\omega') = 0$

18.12.36 $\sigma(\omega_2) = 0$

18.12.37 $\mathcal{P}(\omega/2) = 5c$

18.12.38 $\mathcal{P}'(\omega/2) = \frac{-\pi^3}{2\omega^3}$

18.12.39 $\zeta(\omega/2) = \frac{1}{2}(c\omega + \pi/\omega)$

18.12.40 $\sigma(\omega/2) = \frac{e^{\pi^2/96} \omega \sqrt{2}}{\pi}$

18.12.41 $\mathcal{P}(\omega'/2) = -c$

18.12.42 $\mathcal{P}'(\omega'/2) = 0$

18.12.43 $\zeta(\omega'/2) = +i\infty$

18.12.44 $\sigma(\omega'/2) = 0$

18.12.45 $\mathcal{P}(\omega_2/2) = -c$

18.12.46 $\mathcal{P}'(\omega_2/2) = 0$

18.12.47 $\zeta(\omega_2/2) = \frac{c\omega}{2} + i\infty$

18.12.48 $\sigma(\omega_2/2) = 0$

Subcase III

18.12.49 $g_2 = 0, g_3 = 0 (e_1 = e_2 = e_3 = 0)$

18.12.50 $\mathcal{P}(z; 0, 0) = z^{-2}$

18.12.51 $\zeta(z; 0, 0) = z^{-1}$

18.12.52 $\sigma(z; 0, 0) = z$

18.12.53 $\omega = -i\omega' = \infty$

18.13. Equianharmonic Case ($g_2 = 0, g_3 = 1$)

If $g_2 = 0$ and $g_3 > 0$, homogeneity relations allow us to reduce our considerations of \mathcal{P} to $\mathcal{P}(z; 0, 1)$ (\mathcal{P}', ζ and σ are handled similarly). Thus $\mathcal{P}(z; 0, g_3) = g_3^{1/3} \mathcal{P}(zg_3^{1/3}; 0, 1)$. The case $g_2 = 0, g_3 = 1$ is called the EQUIANHARMONIC case.

$\frac{1}{4}$ FPP; Reduction to Fundamental Triangle

$\Delta_1 \equiv \Delta_0 \omega_2 z_0$ is the Fundamental Triangle

Let ϵ denote $e^{i\pi/3}$ throughout 18.13.

$\omega_2 \approx 1.5299\ 54037\ 05719\ 28749\ 13194\ 17231^6$

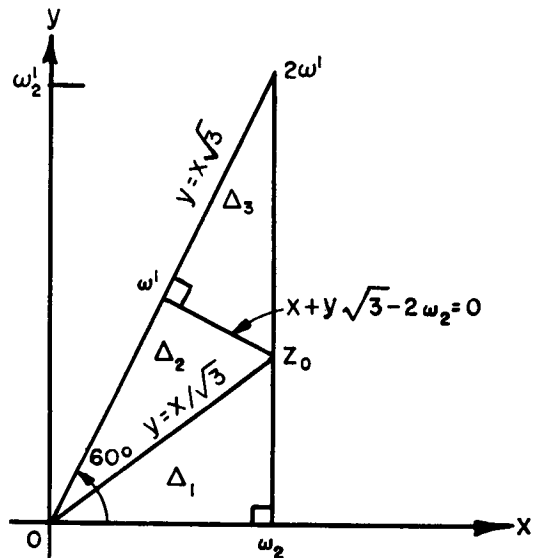

FIGURE 18.11

⁶ This value was computed and checked by multiple precision on a desk calculator and is believed correct to 30S.

Reduction for z_2 in Δ_2 : $z_1 = \epsilon \bar{z}_2$ is in Δ_1 .

18.13.1 $\mathcal{P}(z_2) = \epsilon^{-2} \bar{\mathcal{P}}(z_1)$

18.13.2 $\mathcal{P}'(z_2) = -\bar{\mathcal{P}}'(z_1)$

18.13.3 $\zeta(z_2) = \epsilon^{-1} \bar{\zeta}(z_1)$

18.13.4 $\sigma(z_2) = \epsilon \bar{\sigma}(z_1)$

Reduction for z_3 in Δ_3 : $z_1 = \epsilon^{-1}(2\omega' - z_3)$ is in Δ_1

18.13.5 $\mathcal{P}(z_3) = \epsilon^{-2} \mathcal{P}(z_1)$

18.13.6 $\mathcal{P}'(z_3) = \mathcal{P}'(z_1)$

18.13.7 $\zeta(z_3) = -\epsilon^{-1} \zeta(z_1) + 2\eta'$, $\eta' = \zeta(\omega')$

18.13.8 $\sigma(z_3) = \epsilon \sigma(z_1) \exp [(z_3 - \omega')(2\eta')]$

Special Values and Formulas

18.13.9

$\Delta = -27$, $H_1 = \sqrt{3}(4^{-1/3})\bar{\epsilon}$,

$H_2 = \sqrt{3}(4^{-1/3})$, $H_3 = \sqrt{3}(4^{-1/3})\epsilon$

18.13.10 $m = \sin^2 15^\circ = \frac{2 - \sqrt{3}}{4}$, $q = ie^{-\pi\sqrt{3}/2}$

18.13.11 $\vartheta_2(0) = Ae^{4\pi/8}$

18.13.12 $\vartheta_3(0) = Ae^{4\pi/24}$

18.13.13 $\vartheta_4(0) = Ae^{-4\pi/24}$

18.13.14

where $A = (\omega_2/\pi)^{1/2} 2^{1/3} 3^{1/3} \approx 1.0086 67$

18.13.15 $\omega_2 = \frac{K(m)2^{1/3}}{3^{1/4}} = \frac{\Gamma^3(1/3)}{4\pi}$

Values at Half-periods

	\mathcal{P}	\mathcal{P}'	ζ	σ
18.13.16 $\omega \equiv \omega_1$	$e_1 = 4^{-1/3}\epsilon^2$	0	$\eta = \epsilon\pi/2\omega_2\sqrt{3}$	$\epsilon^{-1}\sigma(\omega_2)$
18.13.17 ω_2	$e_2 = 4^{-1/3}$	0	$\eta_2 = \eta + \eta' = \pi/2\omega_2\sqrt{3}$	$\frac{e^{\pi/4\sqrt{3}}(2^{1/3})}{3^{3/4}}$
18.13.18 $\omega' \equiv \omega_3$	$e_3 = 4^{-1/3}\epsilon^{-2}$	0	$\eta' = \epsilon^{-1}\pi/2\omega_2\sqrt{3}$	$\epsilon\sigma(\omega_2)$
18.13.19 ω_2'	$e_2 = 4^{-1/3}$	0	$\eta_2' = -\pi i/2\omega_2 = \eta' - \eta$	$\frac{ie^{3\pi/4\sqrt{3}}(2^{1/3})}{3^{3/4}}$

Values ⁷ along $(0, \omega_2)$

	\mathcal{P}	\mathcal{P}'	ζ	σ
18.13.20 $2\omega_2/9$	$\frac{\sqrt[3]{\cos 80^\circ}}{\sqrt[3]{\cos 20^\circ} - \sqrt[3]{\cos 40^\circ}}$	$-\sqrt{3}[\frac{\sqrt[3]{\cos 20^\circ} + \sqrt[3]{\cos 40^\circ}}{\sqrt[3]{\cos 20^\circ} - \sqrt[3]{\cos 40^\circ}}]$		
18.13.21 $\omega_2/3$	$1/(2^{1/3} - 1)$	$-\sqrt{3}(2^{1/3} + 1)/(2^{1/3} - 1)$	$\frac{\eta_2 + \sqrt{3}(2^{2/3} + 2 + 2^{1/3})}{6}$	$\frac{e^{\pi/36\sqrt{3}}}{3^{1/6}} \sqrt{\frac{2^{1/3} - 1}{2^{1/3} + 1}}$
18.13.22 $4\omega_2/9$	$\frac{\sqrt[3]{\cos 40^\circ}}{\sqrt[3]{\cos 20^\circ} - \sqrt[3]{\cos 80^\circ}}$	$-\sqrt{3}[\frac{\sqrt[3]{\cos 20^\circ} + \sqrt[3]{\cos 80^\circ}}{\sqrt[3]{\cos 20^\circ} - \sqrt[3]{\cos 80^\circ}}]$		
18.13.23 $\omega_2/2$	$e_2 + H_2$	$-3^{3/4}\sqrt{2 + \sqrt{3}}$	$(\pi/4\omega_2\sqrt{3}) + (3^{1/4}\sqrt{2 + \sqrt{3}})/2^{4/3}$	$\frac{e^{\pi/18\sqrt{3}}(2^{1/12})}{3^{1/4}\sqrt{2 + \sqrt{3}}}$
18.13.24 $2\omega_2/3$	1	$-\sqrt{3}$	$\frac{2}{3}(\eta_2) + 3^{-1/2}$	$e^{\pi/9\sqrt{3}}/3^{1/6}$
18.13.25 $8\omega_2/9$	$\frac{\sqrt[3]{\cos 20^\circ}}{\sqrt[3]{\cos 40^\circ} + \sqrt[3]{\cos 80^\circ}}$	$-\sqrt{3}[\frac{\sqrt[3]{\cos 40^\circ} - \sqrt[3]{\cos 80^\circ}}{\sqrt[3]{\cos 40^\circ} + \sqrt[3]{\cos 80^\circ}}]$		

⁷ Values at $2\omega_2/9$, $4\omega_2/9$ and $8\omega_2/9$ from [18.14].

Values along $(0, z_0)$

	\mathcal{P}	\mathcal{P}'	ζ	σ
18.13.26 $z_0/2$	$-2^{1/3}e^2$	$3i$	$\left[\frac{\eta_2}{\sqrt{3}} + 2^{-1/3}\right] e^{-i\pi/6}$	$\frac{e^{\pi/12} \sqrt{3} e^{i\pi/6}}{3^{1/4}}$
18.13.27 $3z_0/4$	$e^2(e_2 - H_2)$	$i(3^{3/4})\sqrt{2-\sqrt{3}}$	$\left[\frac{\pi}{4\omega_2} + \frac{3^{1/4}\sqrt{2-\sqrt{3}}}{2^{1/3}}\right] e^{-i\pi/6}$	$\frac{e^{3\pi/16} \sqrt{3} (2^{1/12}) e^{i\pi/6}}{3^{1/4} \sqrt{2-\sqrt{3}}}$
18.13.28 z_0	0	i	$\frac{2\eta_2}{\sqrt{3}} e^{-i\pi/6}$	$e^{\pi/3} \sqrt{3} \cdot e^{i\pi/6}$

Duplication Formulas

18.13.29 $\mathcal{P}(2z) = \frac{\mathcal{P}(z)[\mathcal{P}^3(z) + 2]}{4\mathcal{P}^3(z) - 1}$

18.13.30 $\mathcal{P}'(2z) = \frac{2\mathcal{P}'(z) - 10\mathcal{P}^2(z) - 1}{[\mathcal{P}'(z)]^3}$

18.13.31 $\zeta(2z) = 2\zeta(z) + \frac{3\mathcal{P}^2(z)}{\mathcal{P}'(z)}$

18.13.32 $\sigma(2z) = -\mathcal{P}'(z)\sigma^4(z)$

Trisection Formulas (x real)

18.13.33 $\mathcal{P}\left(\frac{x}{3}\right) = \frac{\sqrt[3]{\cos \frac{\phi - \pi}{3}}}{\sqrt[3]{\cos \frac{\phi}{3}} - \sqrt[3]{\cos \frac{\phi + \pi}{3}}}$

18.13.34 $\mathcal{P}'\left(\frac{x}{3}\right) = -\sqrt{3} \frac{\sqrt[3]{\cos \frac{\phi}{3}} + \sqrt[3]{\cos \frac{\phi + \pi}{3}}}{\sqrt[3]{\cos \frac{\phi}{3}} - \sqrt[3]{\cos \frac{\phi + \pi}{3}}}$

where $\tan \phi = \mathcal{P}'(x)$, $0 < x < 2\omega_2$ and we must choose ϕ in intervals

$\left(-\frac{\pi}{2}, \frac{\pi}{2}\right), \left(\frac{\pi}{2}, \frac{3\pi}{2}\right), \left(\frac{3\pi}{2}, \frac{5\pi}{2}\right)$ to get

$\mathcal{P}\left(\frac{x}{3}\right), \mathcal{P}\left(\frac{x}{3} + \frac{2\omega_2}{3}\right), \mathcal{P}\left(\frac{x}{3} + \frac{4\omega_2}{3}\right)$, respectively.

Complex Multiplication

18.13.35 $\mathcal{P}(\epsilon z) = \epsilon^{-2} \mathcal{P}(z)$

18.13.36 $\mathcal{P}'(\epsilon z) = -\mathcal{P}'(z)$

18.13.37 $\zeta(\epsilon z) = \epsilon^{-1} \zeta(z)$

18.13.38 $\sigma(\epsilon z) = \epsilon \sigma(z)$

In the above, ϵ denotes (as it does throughout section 18.13), $e^{i\pi/\beta}$. The above equations are useful as follows, e.g.:

If z is real, ϵz is on $0\omega'$ (Figure 18.11); if ϵz were purely imaginary, z would be on $0z_0$ (Figure 18.11).

Conformal Maps

Equianharmonic Case

Map: $f(z) = u + iv$

$\mathcal{P}(z)$

Near zero: $\mathcal{P}(z) = \frac{1}{z^2} + \epsilon_1$

$\mathcal{P}(z) = \frac{1}{z^2} + \frac{z^4}{28} + \epsilon_2$

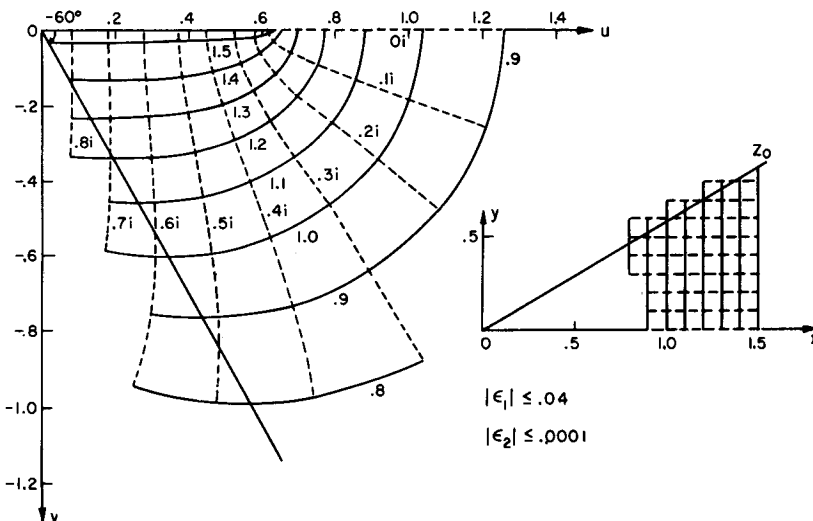

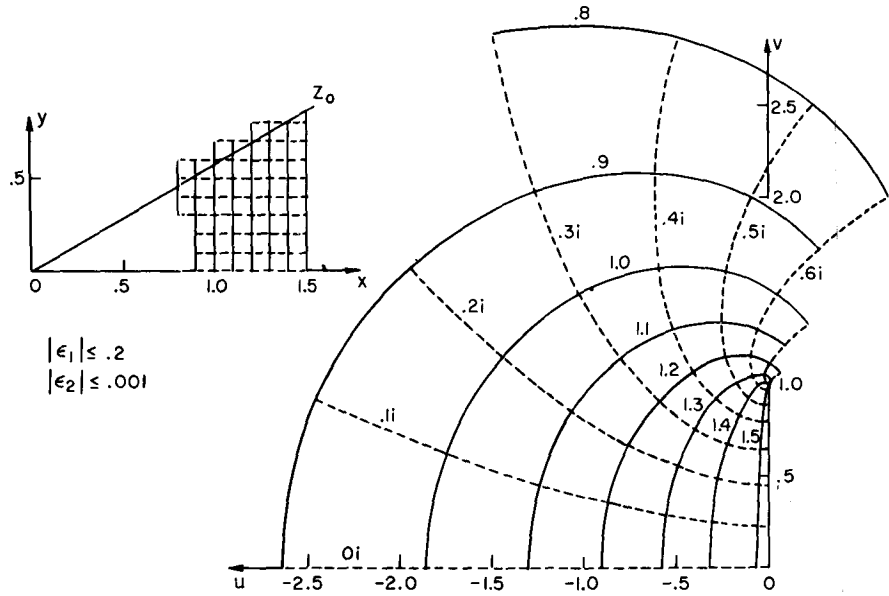

$$|\epsilon_1| \leq .2$$

$$|\epsilon_2| \leq .001$$

$\mathcal{P}'(z)$

Near zero: $\mathcal{P}'(z) = \frac{-2}{z^3} + \epsilon_1$

$$\mathcal{P}'(z) = \frac{-2}{z^3} + \frac{z^3}{7} + \epsilon_2$$

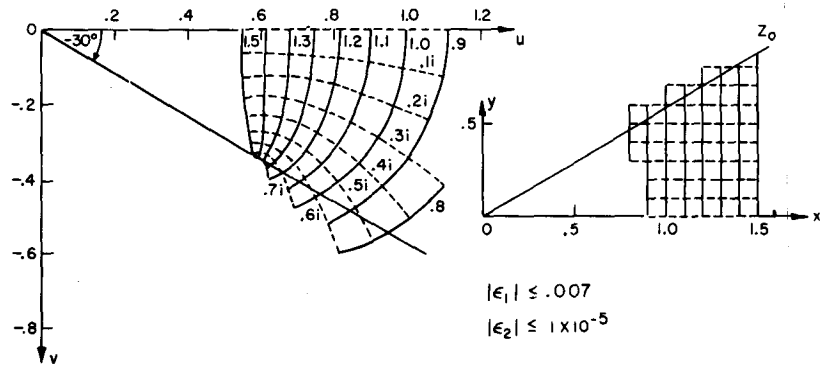

$$|\epsilon_1| \leq .007$$

$$|\epsilon_2| \leq 1 \times 10^{-5}$$

$\zeta(z)$

Near zero: $\zeta(z) = \frac{1}{z} + \epsilon_1$

$$\zeta(z) = \frac{1}{z} - \frac{z^5}{140} + \epsilon_2$$

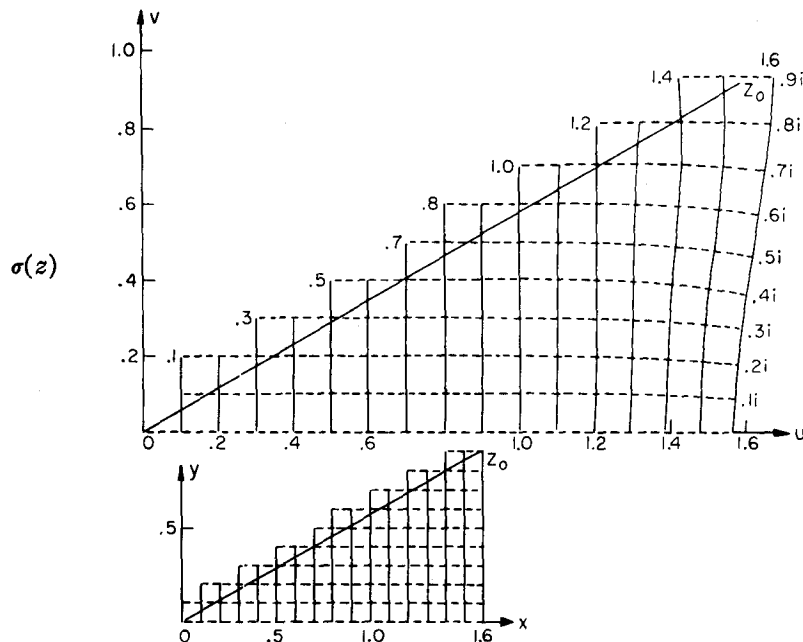

$\sigma(z)$

FIGURE 18.12

Coefficients for Laurent Series for \mathcal{P} , \mathcal{P}' and ζ

($c_m = 0$ for $m \neq 3k$)

k	EXACT c_{3k}	APPROXIMATE c_{3k}
1	1/28	3. 5714 28571 42857 . . . $\times 10^{-2}$
2	1/(13·28 ²) = 1/10192	9. 8116 16954 47409 73312 40188 $\times 10^{-5}$
3	1/(13·19·28 ³) = 1/5422144	1. 8442 88901 21693 55885 78983 $\times 10^{-7}$
4	3/(5·13 ² ·19·28 ⁴) = 234375/(7709611 $\times 10^8$)	3. 0400 36650 35758 61350 20301 $\times 10^{-10}$
5	4/(5·13 ² ·19·31·28 ⁵) = 78125/(16729 85587 $\times 10^9$)	4. 6697 95161 83961 00384 33643 $\times 10^{-13}$
6	(7·43)/(13 ³ ·19 ² ·31·37·28 ⁶)	6. 8662 18676 79393 36788 98 $\times 10^{-16}$
7	(6·431)/(5·13 ³ ·19 ² ·31·37·43·28 ⁷)	9. 7990 31742 57961 41839 66 $\times 10^{-19}$
8	(3·7·313)/(5 ² ·13 ⁴ ·19 ² ·31·37·43·28 ⁸)	1. 3685 06574 79360 13026 87 $\times 10^{-21}$
9	(4·1201)/(5 ² ·13 ⁴ ·19 ² ·31·37·43·28 ⁹)	1. 8800 72610 01329 79236 40 $\times 10^{-24}$
10	(2 ² ·3·41·1823)/(5·13 ⁴ ·19 ² ·31 ² ·37·43·61·28 ¹⁰)	2. 5497 66946 68202 63683 $\times 10^{-27}$
11	(3·79·733)/(5·13 ⁴ ·19 ² ·31 ² ·37·43·61·67·28 ¹¹)	3. 4222 48599 51463 05316 $\times 10^{-30}$
12	3·1153·13963·29059	4. 5541 38864 99184 30391 $\times 10^{-33}$
	$\frac{5^3 \cdot 13^4 \cdot 19^4 \cdot 31^2 \cdot 37^2 \cdot 43 \cdot 61 \cdot 67 \cdot 73 \cdot 28^{12}}{2^2 \cdot 3^2 \cdot 7 \cdot 11 \cdot 2647111}$	
13	$\frac{5^3 \cdot 13^4 \cdot 19^4 \cdot 31^2 \cdot 37^2 \cdot 61 \cdot 67 \cdot 73 \cdot 79 \cdot 28^{13}}{}$	6. 0171 15776 98241 99591 $\times 10^{-36}$

First 5 approximate values determined from exact values of c_{3k} ; subsequent values determined by using exact ratios c_{3k}/c_{3k-3} , using at least double precision arithmetic with a desk calculator. All approximate c 's were checked with the use of the recursion relation; $c_3 - c_{27}$ are believed correct to at least 21S; $c_{30} - c_{39}$ are believed correct to 20S.

$$c_{3k} \leq \frac{c_3}{13^{k-1} \cdot 28^{k-1}}, \quad k=2, 3, 4, \dots$$

Other Series Involving \mathcal{P}

Reversed Series for Large $|\mathcal{P}|$

18.13.39

$$z = (\mathcal{P}^{-1})^{1/2} \left[1 + \frac{u}{7} + \frac{3u^2}{26} + \frac{5u^3}{38} + \frac{7u^4}{40} + \frac{63u^5}{248} + \frac{231u^6}{592} + \frac{429u^7}{688} + O(u^8) \right],$$

18.13.40 where $u = \mathcal{P}^{-3}/8$ and z is in the Fundamental Triangle (Figure 18.11) if \mathcal{P} has an appropriate value.

Series near ω_0

18.13.41

$$\mathcal{P} = iu \left[1 - \frac{u^6}{7} + \frac{3u^{12}}{364} \right] + u^4 \left[-\frac{1}{2} + \frac{u^6}{28} \right] + O(u^{16})$$

18.13.42

$$u = -i\mathcal{P} \left[1 + \frac{\mathcal{P}^3}{2} + \frac{6\mathcal{P}^6}{7} + 2\mathcal{P}^9 + \frac{70\mathcal{P}^{12}}{13} + O(\mathcal{P}^{15}) \right],$$

18.13.43 where $u = (z - z_0)$

Series near ω_2

18.13.44

$$(\mathcal{P} - e_2) = 3e_2^2 u \left[1 + x + x^2 + \frac{6}{7} x^3 + \frac{5}{7} x^4 + \frac{4}{7} x^5 + \frac{285}{637} x^6 + O(x^7) \right],$$

18.13.45 where $u = (z - \omega_2)^2$, $x = e_2 u$

18.13.46

$$u = e_2^{-1} \left[w - w^2 + w^3 - \frac{6}{7} w^4 + \frac{3}{7} w^5 + \frac{3}{7} w^6 - \frac{1143}{637} w^7 + O(w^8) \right],$$

18.13.47 where $w = (\mathcal{P} - e_2)/3e_2$

Other Series Involving \mathcal{P}'

Reversed Series for Large $|\mathcal{P}'|$

18.13.48

$$z = 2^{1/3} (\mathcal{P}'^{1/3})^{-1} e^{i\pi/3} \left[1 - \frac{2}{21} (\mathcal{P}')^{-2} + \frac{5}{117} (\mathcal{P}')^{-4} + O(\mathcal{P}'^{-6}) \right],$$

z being in the Fundamental Triangle (Figure 18.11) if \mathcal{P}' has an appropriate value.

Series near ω_0

18.13.49

$$(\mathcal{P}' - i) = x \left[-2 - ix + \frac{5}{14} x^2 + \frac{3i}{28} x^3 + O(x^4) \right]$$

18.13.50 where $x = (z - z_0)^3$

18.13.51 $x = 2\alpha \left[1 - i\alpha - \frac{9}{7} \alpha^2 + \frac{13i\alpha^3}{7} + O(\alpha^4) \right],$

18.13.52 where $\alpha = (\mathcal{P}' - i)/(-4)$

Series near ω_2

18.13.53

$$\mathcal{P}' = 6e_2^2(z - \omega_2) \left[1 + 2v + 3v^2 + \frac{24}{7}v^3 + \frac{25}{7}v^4 + \frac{24}{7}v^5 + \frac{285}{91}v^6 + O(v^7) \right],$$

18.13.54 where $v = e_2(z - \omega_2)^2$

18.13.55

$$(z - \omega_2) = (\mathcal{P}'/6e_2^2) \left[1 - 2w + 9w^2 - \frac{360}{7}w^3 + 330w^4 - 2268w^5 + \frac{212058}{13}w^6 + O(w^7) \right],$$

18.13.56 where $w = \mathcal{P}'^2/9$

Other Series Involving ζ

Reversed Series for Large $|\zeta|$

18.13.57

$$z = \zeta^{-1} \left[1 - \frac{\gamma}{7} + \frac{17\gamma^2}{143} - \frac{496\gamma^3}{3553} + O(\gamma^4) \right],$$

18.13.58

$$\gamma = \zeta^{-6}/20$$

Series near z_0

18.13.59

$$(\zeta - \zeta_0) = i \left[-\frac{u^2}{2} + \frac{u^8}{56} - \frac{3u^{14}}{5096} \right] + \left[\frac{u^5}{8} - \frac{u^{11}}{308} \right] + O(u^{17}),$$

18.13.60 where $u = (z - z_0)$

Series near ω_2

18.13.61

$$(\zeta - \eta_2) = -e_2(z - \omega_2) \left[1 + v + \frac{3}{5}v^2 + \frac{3}{7}v^3 + \frac{2}{7}v^4 + \frac{15}{77}v^5 + \frac{12}{91}v^6 + \frac{57}{637}v^7 + O(v^8) \right],$$

18.13.62

$$v = e_2(z - \omega_2)^2$$

18.13.63

$$(z - \omega_2) = \frac{(\zeta - \eta_2)}{-e_2} \left[1 - w + \frac{12w^2}{5} - \frac{267w^3}{35} + \frac{139w^4}{5} - \frac{30192w^5}{275} + \frac{1634208}{3575}w^6 + O(w^7) \right],$$

18.13.64

$$w = (\zeta - \eta_2)^2/e_2$$

Series Involving σ

18.13.65

$$\sigma = z - \frac{2 \cdot 3}{7!} z^7 - \frac{2^3 \cdot 3^3}{13!} z^{13} + \frac{2^6 \cdot 3^4 \cdot 23}{19!} z^{19}$$

$$+ \frac{2^7 \cdot 3^5 \cdot 5^2 \cdot 31}{25!} z^{25} + \frac{2^8 \cdot 3^8 \cdot 5 \cdot 9103}{31!} z^{31} - \frac{2^{12} \cdot 3^9 \cdot 5 \cdot 229 \cdot 2683}{37!} z^{37} - \frac{2^{14} \cdot 3^{10} \cdot 5 \cdot 23 \cdot 257 \cdot 18049}{43!} z^{43} - \frac{2^{15} \cdot 3^{12} \cdot 5 \cdot 59 \cdot 107895773}{49!} z^{49} + O(z^{55})$$

18.13.66

$$z = \sigma + \frac{\sigma^7}{2^3 \cdot 3 \cdot 5 \cdot 7} + \frac{41\sigma^{13}}{2^7 \cdot 3^2 \cdot 5^2 \cdot 11 \cdot 13} + \frac{13 \cdot 337\sigma^{19}}{2^{10} \cdot 3^4 \cdot 5^3 \cdot 11 \cdot 17 \cdot 19} + \frac{31 \cdot 101\sigma^{25}}{2^{15} \cdot 3^5 \cdot 5 \cdot 11^2 \cdot 17 \cdot 23} + O(\sigma^{31})$$

Economized Polynomials ($0 \leq x \leq 1.53$)

18.13.67 $x^2 \mathcal{P}(x) = \sum_0^6 a_n x^{6n} + \epsilon(x)$
 $|\epsilon(x)| < 2 \times 10^{-7}$

- | | | | |
|---------------------|----|-----------------------|----|
| $a_0 = (-1)9.99999$ | 96 | $a_4 = -(-9)2.20892$ | 47 |
| $a_1 = (-2)3.57143$ | 20 | $a_5 = (-10)1.74915$ | 35 |
| $a_2 = (-5)9.80689$ | 93 | $a_6 = -(-12)4.46863$ | 93 |
| $a_3 = (-7)2.00835$ | 02 | | |

18.13.68 $x^3 \mathcal{P}'(x) = \sum_0^6 a_n x^{6n} + \epsilon(x)$
 $|\epsilon(x)| < 4 \times 10^{-7}$

- | | | | |
|---------------------|----|-----------------------|----|
| $a_0 = -2.00000$ | 00 | $a_4 = -(-9)2.12719$ | 66 |
| $a_1 = (-1)1.42857$ | 22 | $a_5 = (-10)6.53654$ | 67 |
| $a_2 = (-4)9.81018$ | 03 | $a_6 = -(-11)1.70510$ | 78 |
| $a_3 = (-6)3.00511$ | 93 | | |

18.13.69 $x\zeta(x) = \sum_0^6 a_n x^{6n} + \epsilon(x)$
 $|\epsilon(x)| < 3 \times 10^{-8}$

- | | | | |
|----------------------|----|----------------------|----|
| $a_0 = (-1)9.99999$ | 98 | $a_4 = (-10)6.12486$ | 14 |
| $a_1 = -(-3)7.14285$ | 86 | $a_5 = (-11)4.66919$ | 85 |
| $a_2 = -(-6)8.91165$ | 65 | $a_6 = (-12)1.25014$ | 65 |
| $a_3 = -(-8)1.44381$ | 84 | | |

18.14. Lemniscatic Case

$(g_2=1, g_3=0)$

If $g_2 > 0$ and $g_3 = 0$, homogeneity relations allow us to reduce our consideration of \mathcal{P} to $\mathcal{P}(z; 1, 0)$ (\mathcal{P}' , ζ and σ are handled similarly). Thus $\mathcal{P}(z; g_2, 0) = g_2^{\frac{1}{2}} \mathcal{P}(zg_2^{\frac{1}{2}}; 1, 0)$. The case $g_2=1, g_3=0$ is called the LEMNISCATIC case.

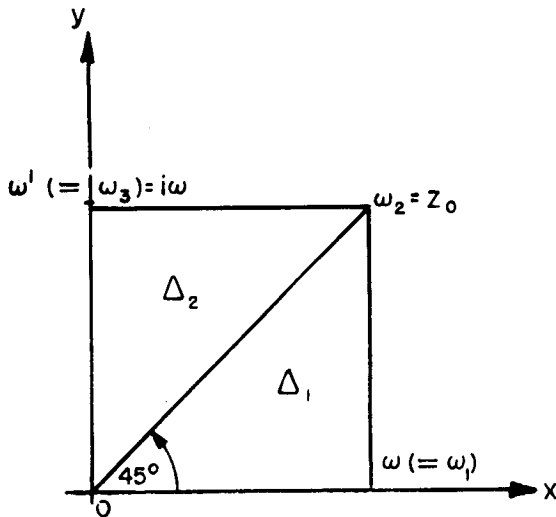

FIGURE 18.13

$\frac{1}{2}$ FPP; Reduction to Fundamental Triangle

$\Delta_1 \equiv \Delta 0\omega\omega_2$ is the Fundamental Triangle

$\omega \approx 1.8540\ 74677\ 30137\ 192^{\frac{1}{8}}$

Reduction for z_2 in Δ_2 : $z_1 = i\bar{z}_2$ is in Δ_1

18.14.1 $\mathcal{P}(z_2) = -\overline{\mathcal{P}}(z_1)$

18.14.2 $\mathcal{P}'(z_2) = i\overline{\mathcal{P}}'(z_1)$

18.14.3 $\zeta(z_2) = -i\overline{\zeta}(z_1)$

18.14.4 $\sigma(z_2) = i\overline{\sigma}(z_1)$

Special Values and Formulas

18.14.5

$\Delta=1, H_1=H_3=2^{-\frac{1}{2}}, H_2=i/2,$

$m = \sin^2 45^\circ = \frac{1}{2}, q = e^{-\pi}$

18.14.6 $\vartheta_2(0) = \vartheta_4(0) = (\omega\sqrt{2}/\pi)^{\frac{1}{2}}; \vartheta_3(0) = (2\omega/\pi)^{\frac{1}{2}}$

18.14.7 $\omega = K(\sin^2 45^\circ) = \frac{\Gamma^2(\frac{1}{4})}{4\sqrt{\pi}} = \frac{\tilde{\omega}}{\sqrt{2}}$ where

$\tilde{\omega} \approx 2.62205\ 75542\ 92119\ 81046\ 48395\ 89891\ 11941\ 36827\ 54951\ 43162$ is the Lemniscate constant [18.9]

^s This value was computed and checked by double precision methods on a desk calculator and is believed correct to 188.

Values at Half-periods

	\mathcal{P}	\mathcal{P}'	ζ	σ
18.14.8 $\omega = \omega_1$	$e_1 = \frac{1}{2}$	0	$\eta = \pi/4\omega$	$e^{\pi/8}(2^{1/4})$
18.14.9 $\omega_2 = z_0$	$e_2 = 0$	0	$\eta + \eta'$	$e^{\pi/4}(\sqrt{2})e^{i\pi/4}$
18.14.10 $\omega' = \omega_3$	$e_3 = -\frac{1}{2}$	0	$\eta' = -\pi i/4\omega$	$i e^{\pi/8}(2^{1/4})$

Lehmer
MPLG 1947

Values along $(0, \omega)$

	\mathcal{P}	\mathcal{P}'	ζ	σ
18.14.11 $\omega/4$	$\frac{\sqrt{\alpha}}{2}(\sqrt{\alpha+2^{1/4}})(1+2^{1/4})$			
18.14.12 $\omega/2$	$\alpha/2$	$-\alpha$	$\frac{\pi + \alpha}{8\omega + 2\sqrt{2}}$	$\frac{e^{\pi/32}(2^{1/16})}{\alpha^{\frac{1}{2}}}$
18.14.13 $2\omega/3$	$\frac{1}{2}\sqrt{1+\sec 30^\circ}$	$-\frac{\sqrt{2\sqrt{3}+3}}{\sqrt{3}}$	$\frac{2\eta}{3} + \sqrt{\frac{\mathcal{P}(2\omega/3)}{3}}$	$\frac{e^{\pi/18}(3^{1/8})}{(2+\sqrt{3})^{1/18}}$
18.14.14 $3\omega/4$	$\frac{\sqrt{\alpha}}{2}(\sqrt{\alpha-2^{1/4}})(1+2^{1/4})$			

$\alpha = 1 + \sqrt{2}$

Values along $(0, z_0)$

	\mathcal{P}	\mathcal{P}'	ζ	σ
18.14.15 $z_0/4$	$-\frac{i}{2}(\alpha + \sqrt{2\alpha})$	$\alpha(\sqrt{\alpha} + \sqrt{2})e^{i\pi/4}$		$\frac{e^{\pi/64}(21/32)}{\alpha^{1/4}(\sqrt{\alpha} + \sqrt{2})^{1/4}} e^{i\pi/4}$
18.14.16 $z_0/2$	$-i/2$	$e^{i\pi/4}$	$\left[\frac{\pi}{4\omega\sqrt{2}} + \frac{1}{2}\right] e^{-i\pi/4}$	$e^{\pi/16}(21/8)e^{i\pi/4}$
18.14.17 $2z_0/3$	$-\frac{i}{2}\sqrt{\sec 30^\circ - 1}$	$\frac{e^{i\pi/4}\sqrt{2\sqrt{3}-3}}{\sqrt{3}}$	$\frac{2\eta_2}{3} + \left[\frac{\mathcal{P}(2z_0/3)}{3}\right]^{1/2}$	$\frac{e^{\pi/9}e^{i\pi/4}(31/6)}{\sqrt[3]{2\sqrt{3}-3}}$
18.14.18 $3z_0/4$	$-\frac{i}{2}(\alpha - \sqrt{2\alpha})$	$\alpha(\sqrt{\alpha} - \sqrt{2})e^{i\pi/4}$		$\frac{e^{9\pi/64}(21/32)}{\alpha^{1/4}(\sqrt{\alpha} - \sqrt{2})^{1/4}} e^{i\pi/4}$

$\alpha = 1 + \sqrt{2}$

Duplication Formulas

18.14.19 $\mathcal{P}(2z) = [\mathcal{P}^2(z) + \frac{1}{4}]^2 / \{\mathcal{P}(z)[4\mathcal{P}^2(z) - 1]\}$

18.14.20 $\mathcal{P}'(2z) = (\beta + 1)(\beta^2 - 6\beta + 1) / [32\mathcal{P}'^3(z)]$, $\beta = 4\mathcal{P}^2(z)$

18.14.21 $\zeta(2z) = 2\zeta(z) + \frac{6\mathcal{P}^2(z) - \frac{1}{2}}{2\mathcal{P}'(z)}$

18.14.22 $\sigma(2z) = -\mathcal{P}'(z)\sigma^4(z)$

Bisection Formulas ($0 < x < 2\omega$)

18.14.23 $\mathcal{P}\left(\frac{x}{2}\right) = [\mathcal{P}^{\frac{1}{2}}(x) + \{\mathcal{P}(x) + \frac{1}{2}\}^{\frac{1}{2}}][\mathcal{P}^{\frac{1}{2}}(x) \pm \{\mathcal{P}(x) - \frac{1}{2}\}^{\frac{1}{2}}]$
 [Use + on $0 < x \leq \omega$, - on $\omega \leq x < 2\omega$]

18.14.24

$\frac{1}{2}\mathcal{P}'\left(\frac{x}{2}\right) = \mathcal{P}'(x) \mp [2\mathcal{P}(x) + \frac{1}{2}]\sqrt{\mathcal{P}(x) - \frac{1}{2}}$
 $- [2\mathcal{P}(x) - \frac{1}{2}]\sqrt{\mathcal{P}(x) + \frac{1}{2}}$
 $- 2\mathcal{P}^{3/2}(x)$ (See [18.13].)

[Use - on $0 < x \leq \omega$, + on $\omega \leq x < 2\omega$]

Complex Multiplication

18.14.25 $\mathcal{P}(iz) = -\mathcal{P}(z)$

18.14.26 $\mathcal{P}'(iz) = i\mathcal{P}'(z)$

18.14.27 $\zeta(iz) = -i\zeta(z)$

18.14.28 $\sigma(iz) = i\sigma(z)$

The above equations could be used as follows, e.g.: If z were real, iz would be purely imaginary.

Conformal Maps

Lemniscatic Case

Map: $f(z) = u + iv$

$\mathcal{P}(z)$

Near zero: $\mathcal{P}(z) = \frac{1}{z^2} + \epsilon_1$

$\mathcal{P}(z) = \frac{1}{z^2} + \frac{z^2}{20} + \epsilon_2$, $|z| < 1$

Near z_0 : $\mathcal{P}(z) = \frac{-(z-z_0)^2}{4} + \epsilon_3$, $|z-z_0| < \sqrt{2}$

$\mathcal{P}(z) = \frac{-(z-z_0)^2}{4} + \frac{(z-z_0)^8}{80} + \epsilon_4$

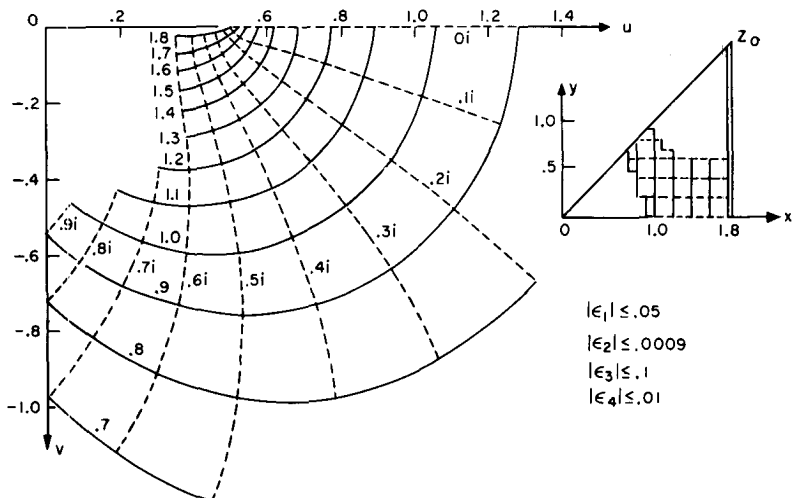

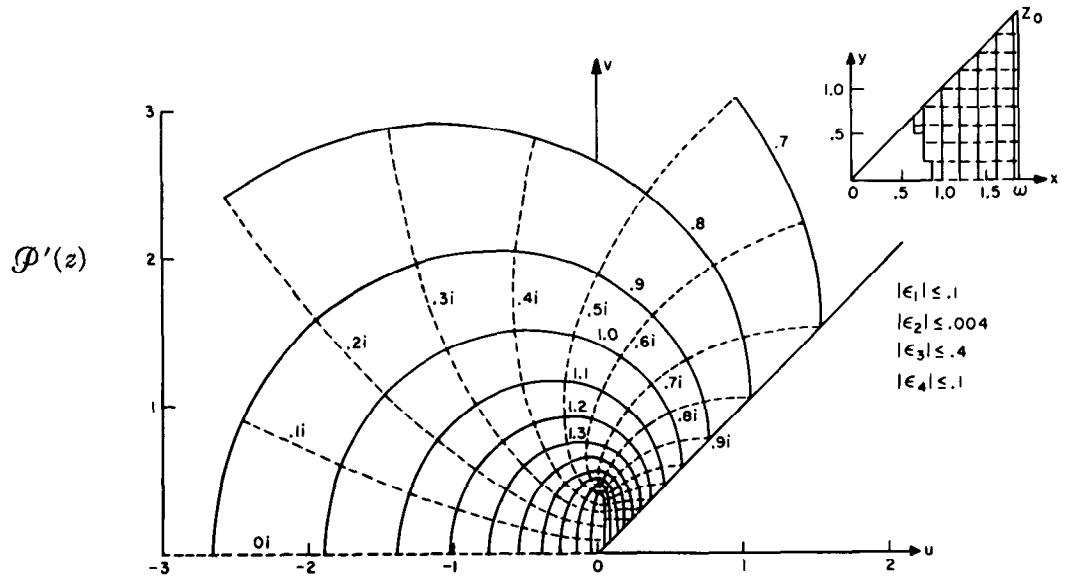

Near zero: $\mathcal{P}'(z) = \frac{-2}{z^3} + \epsilon_1$

Near z_0 : $\mathcal{P}'(z) = \frac{-(z-z_0)}{2} + \epsilon_3$

$\mathcal{P}'(z) = \frac{-2}{z^3} + \frac{z}{10} + \epsilon_2$

$\mathcal{P}'(z) = \frac{-(z-z_0)}{2} + \frac{3(z-z_0)^5}{40} + \epsilon_4$

Near zero: $\zeta(z) = \frac{1}{z} + \epsilon_1$

$\zeta(z) = \frac{1}{z} - \frac{z^3}{60} + \epsilon_2, |z| < 1$

Near z_0 : $\zeta(z) = \zeta_0 + \frac{(z-z_0)^3}{12} + \epsilon_3,$

$|z-z_0| < \sqrt{2}$

$\zeta(z) = \zeta_0 + \frac{(z-z_0)^3}{12} - \frac{(z-z_0)^7}{560} + \epsilon_4$

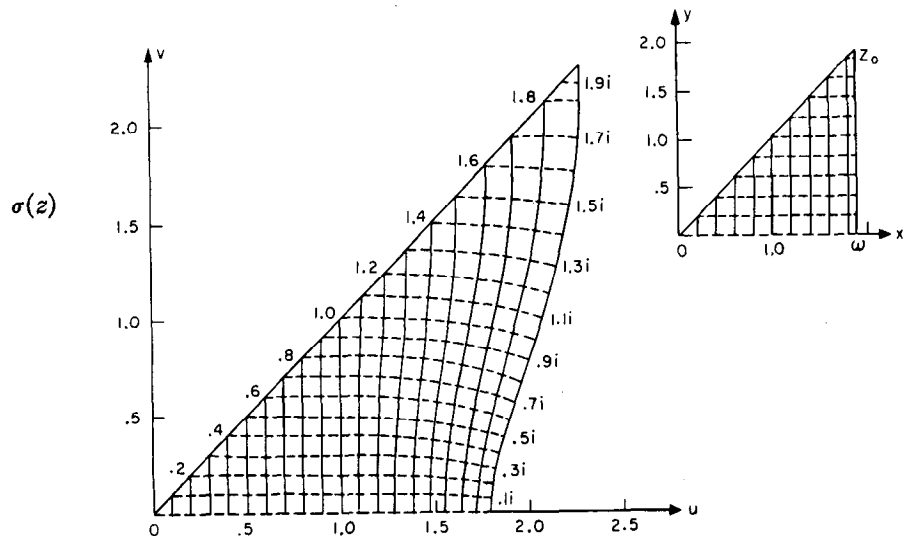
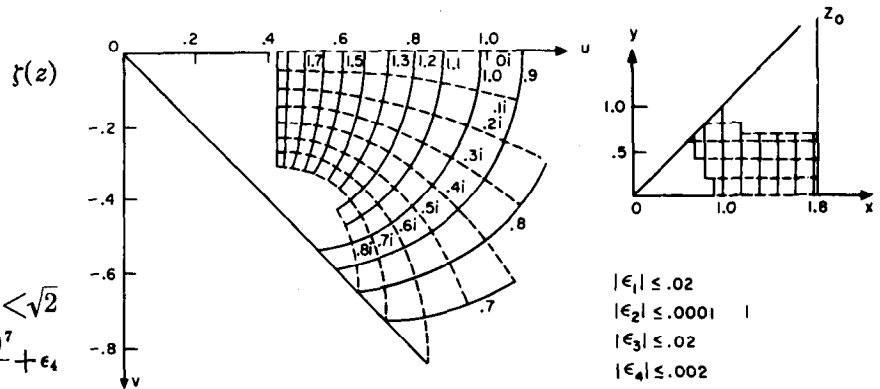

FIGURE 18.14

Coefficients for Laurent Series for \mathcal{P} , \mathcal{P}' , and ζ

($c_n=0$ for m odd)

k	EXACT c_{2k}	APPROXIMATE c_{2k}
1	1/20	.05
2	$1/(3 \cdot 20^2) = 1/1200$.8333 . . . $\times 10^{-3}$
3	$2/(3 \cdot 13 \cdot 20^3) = 1/156000$.641025 641025 . . . $\times 10^{-5}$
4	$5/(3 \cdot 13 \cdot 17 \cdot 20^4) = 1/21216000$.47134 23831 07088 98944 $\times 10^{-7}$
5	$2/(3^2 \cdot 13 \cdot 17 \cdot 20^5) = 1/(31824 \times 10^5)$.31422 82554 04725 99296 $\times 10^{-9}$
6	$10/(3^3 \cdot 13^2 \cdot 17 \cdot 20^6) = 1/(4964544 \times 10^5)$.20142 83688 49183 32882 $\times 10^{-11}$
7	$4/(3 \cdot 13^2 \cdot 17 \cdot 29 \cdot 20^7) = 1/(7998432 \times 10^7)$.12502 45048 02941 37651 $\times 10^{-13}$
8	$2453/(3^4 \cdot 11 \cdot 13^2 \cdot 17^2 \cdot 29 \cdot 20^8) = 958203125/(1262002599 \times 10^{10})$.75927 19109 76468 59917 $\times 10^{-16}$
9	$2 \cdot 5 \cdot 7 \cdot 61/(3^3 \cdot 13^3 \cdot 17^2 \cdot 29 \cdot 37 \cdot 20^9) = 833984375/(18394643943 \times 10^{17})$.45338 43533 93461 06092 $\times 10^{-18}$

$$c_{2k} \leq \frac{c_2^k}{3^{k-1}}, \quad k=1, 2, \dots$$

Other Series Involving \mathcal{P}

Reversed Series for Large $|\mathcal{P}|$

18.14.29

$$z = (\mathcal{P}^{-1})^{1/2} \left[1 + \frac{w}{5} + \frac{w^2}{6} + \frac{5w^3}{26} + \frac{35w^4}{136} + \frac{3w^5}{8} + \frac{231w^6}{400} + \frac{429w^7}{464} + \frac{195w^8}{128} + \frac{12155w^9}{4736} + \frac{46189w^{10}}{10496} + O(w^{11}) \right]$$

18.14.30 $w = \mathcal{P}^{-2}/8$, and z is in the Fundamental Triangle (Figure 18.13) if \mathcal{P} has an appropriate value.

Series near z_0

18.14.31 $2\mathcal{P} = -x + \frac{x^3}{5} - \frac{2x^5}{75} + \frac{x^7}{325} + O(x^9)$

18.14.32 $x = (z - z_0)^2/2$

18.14.33 $x = -\left[w + \frac{w^3}{5} + \frac{7w^5}{75} + \frac{11w^7}{195} + O(w^9) \right]$
 $w = 2\mathcal{P}$

Series near ω

18.14.34

$$(\mathcal{P} - e_1) = v + v^2 + \frac{4v^3}{5} + \frac{3v^4}{5} + \frac{32v^5}{75} + \frac{22v^6}{75} + \frac{64v^7}{325} + O(v^8)$$

18.14.35 $v = (z - \omega)^2/2$

18.14.36

$$v = y \left[1 - y + \frac{6y^2}{5} - \frac{8y^3}{5} + \frac{172y^4}{75} - \frac{52y^5}{15} + \frac{1064y^6}{195} + O(y^7) \right]$$

18.14.37 $y = (\mathcal{P} - e_1)$

Other Series Involving \mathcal{P}'

Reversed Series for Large $|\mathcal{P}'|$

18.14.38

$$z = Au \left[1 - \frac{v}{5} + \frac{5v^3}{39} - \frac{7v^4}{51} + O(v^5) \right], \quad u = (\mathcal{P}'^{1/3})^{-1} e^{i\pi/3}$$

18.14.39 $A = 2^{1/3}$, $v = Au^4/6$, and z is in the Fundamental Triangle (Figure 18.13) if \mathcal{P}' has an appropriate value.

Series near z_0

18.14.40

$$\mathcal{P}' = \frac{1}{2}(z - z_0) \left[-1 + 3w - \frac{10w^2}{3} + \frac{35w^3}{13} + O(w^4) \right]$$

18.14.41

$$w = (z - z_0)^4/20$$

18.14.42

$$(z - z_0) = 2\mathcal{P}' \left[1 + \frac{3u}{5} + \frac{5u^2}{3} + \frac{84u^3}{13} + O(u^4) \right]$$

18.14.43

$$u = 4\mathcal{P}'^4$$

Series near ω

18.14.44

$$\mathcal{P}' = x \left[1 + x^2 + \frac{3}{5}x^4 + \frac{3}{10}x^6 + \frac{2}{15}x^8 + \frac{11}{200}x^{10} + O(x^{12}) \right]$$

18.14.45

$$x = (z - \omega)$$

18.14.46

$$x = \mathcal{P}' - \mathcal{P}'^3 + \frac{12\mathcal{P}'^5}{5} - \frac{15\mathcal{P}'^7}{2} + \frac{80\mathcal{P}'^9}{3} - \frac{819\mathcal{P}'^{11}}{8} + O(\mathcal{P}'^{13})$$

Other Series Involving ζ

Reversed Series for Large $|\zeta|$

18.14.47 $z = \zeta^{-1} \left[1 - \frac{v}{5} + \frac{v^2}{7} - \frac{136v^3}{1001} + \frac{1349v^4}{9163} + O(v^5) \right]$

18.14.48

$$v = \zeta^{-4}/12$$

*tsuit
12/16
Voin
5992+
de Sloane?*

Pal de Legendre?

Series near z_0

18.14.49

$$(\zeta - \zeta_0) = \frac{1}{4}(z - z_0)^3 \left[\frac{1}{3} - \frac{v}{7} + \frac{2v^2}{33} - \frac{v^3}{39} + O(v^4) \right],$$

18.14.50

$$v = (z - z_0)^4 / 20$$

Series near ω

18.14.51

$$(\zeta - \eta) = -\frac{x}{2} - \frac{x^3}{6} - \frac{x^5}{20} - \frac{x^7}{70} - \frac{x^9}{240} - \frac{x^{11}}{825} - \frac{11x^{13}}{31200} - \frac{x^{15}}{9750} + O(x^{17}),$$

18.14.52

$$x = (z - \omega)$$

18.14.53

$$x = w - \frac{w^3}{3} + \frac{7w^5}{30} - \frac{13w^7}{63} + \frac{929w^9}{4536} - \frac{194w^{11}}{891} + \frac{942883w^{13}}{3891888} + O(w^{15})$$

18.14.54 $w = -2(\zeta - \eta)$

Series Involving σ

18.14.55

$$\sigma = z - \frac{z^5}{2 \cdot 5!} + \frac{3^2 z^9}{2^2 \cdot 9!} + \frac{3 \cdot 23 z^{13}}{2^3 \cdot 13!} + \frac{3 \cdot 107 z^{17}}{2^4 \cdot 17!} + \frac{3^3 \cdot 7 \cdot 23 \cdot 37 z^{21}}{2^5 \cdot 21!} + \frac{3^2 \cdot 313 \cdot 503 z^{25}}{2^6 \cdot 25!} - \frac{3^4 \cdot 7 \cdot 685973 z^{29}}{2^7 \cdot 29!} + O(z^{33})$$

18.14.56

$$z = \sigma + \frac{\sigma^5}{2^4 \cdot 3 \cdot 5} + \frac{\sigma^9}{2^9 \cdot 3 \cdot 7} + \frac{17 \cdot 113 \sigma^{13}}{2^{13} \cdot 3^4 \cdot 7 \cdot 11 \cdot 13} + \frac{122051 \sigma^{17}}{2^{19} \cdot 3^5 \cdot 7^2 \cdot 11 \cdot 17} + \frac{5 \cdot 13 \sigma^{21}}{2^{23} \cdot 3^2 \cdot 11 \cdot 19} + O(\sigma^{25})$$

Economized Polynomials ($0 \leq x \leq 1.86$)

18.14.57 $x^2 \mathcal{P}(x) = \sum_0^6 a_n x^{4n} + \epsilon(x)$

$$|\epsilon(x)| < 2 \times 10^{-7}$$

- $a_0 = (-1)9.99999 \ 98$ $a_4 = (-8)4.81438 \ 20$
- $a_1 = (-2)4.99999 \ 62$ $a_5 = (-10)2.29729 \ 21$
- $a_2 = (-4)8.33352 \ 77$ $a_6 = (-12)4.94511 \ 45$
- $a_3 = (-6)6.40412 \ 86$

18.14.58 $x^3 \mathcal{P}'(x) = \sum_0^6 a_n x^{4n} + \epsilon(x)$

$$|\epsilon(x)| < 4 \times 10^{-7}$$

- $a_0 = -2.00000 \ 00$ $a_4 = (-7)6.58947 \ 52$
- $a_1 = (-1)1.00000 \ 02$ $a_5 = (-9)5.59262 \ 49$
- $a_2 = (-3)4.99995 \ 38$ $a_6 = (-11)5.54177 \ 69$
- $a_3 = (-5)6.41145 \ 59$

18.14.59 $x\zeta(x) = \sum_0^6 a_n x^{4n} + \epsilon(x)$

$$|\epsilon(x)| < 3 \times 10^{-8}$$

- $a_0 = (-1)9.99999 \ 99$ $a_4 = -(-9)2.57492 \ 62$
- $a_1 = -(-2)1.66666 \ 74$ $a_5 = -(-11)5.67008 \ 00$
- $a_2 = -(-4)1.19036 \ 70$ $a_6 = (-13)9.70015 \ 80$
- $a_3 = -(-7)5.86451 \ 63$

18.15. Pseudo-Lemniscatic Case

$$(g_2 = -1, g_3 = 0)$$

If $g_2 < 0$ and $g_3 = 0$, homogeneity relations allow us to reduce our consideration of \mathcal{P} to $\mathcal{P}(z; -1, 0)$. Thus

18.15.1 $\mathcal{P}(z; g_2, 0) = |g_2|^{1/2} \mathcal{P}(z|g_2|^{1/4}; -1, 0)$

[\mathcal{P}' , ζ and σ are handled similarly]. Because of its similarity to the lemniscatic case, we refer to the case $g_2 = -1, g_3 = 0$ as the pseudo-lemniscatic case. It plays the same role (period ratio unity) for $\Delta < 0$ as does the lemniscatic case for $\Delta > 0$.

$$\omega_2 = \sqrt{2} \times (\text{real half-period for lemniscatic case}) = \tilde{\omega} \text{ (the Lemniscate Constant—see 18.14.7)}$$

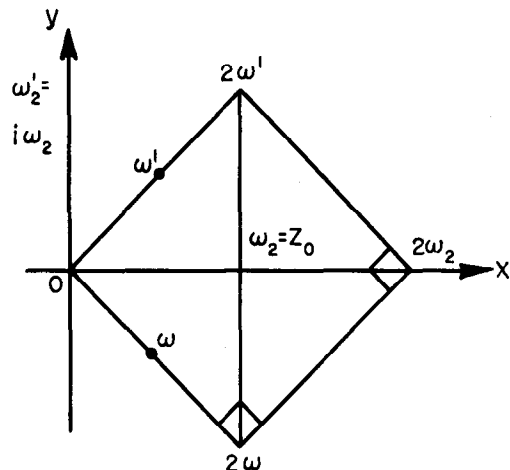

FIGURE 18.15

Special Values and Relations

18.15.2 $\Delta = -1, g_2 = -1, g_3 = 0$

18.15.3

$H_1 = -i/\sqrt{2}, H_2 = \frac{1}{2}, H_3 = i/\sqrt{2}, m = \frac{1}{2}, q = ie^{-\tau/2}$

18.15.4

$\vartheta_2(0) = R2^{1/4}e^{i\pi/8}, \vartheta_3(0) = Re^{i\pi/8}, \vartheta_4(0) = Re^{-i\pi/8},$

18.15.5

where $R = \sqrt{\omega_2\sqrt{2}/\pi}$

Values at Half-Periods

	\mathcal{P}	\mathcal{P}'	ζ	σ
18.15.6 $\omega = \omega_1$	$i/2$	0	$\frac{1}{2}(\eta_2 - \eta_2')$	$e^{-i\pi/4}e^{\pi/8}(2^{1/4})$
18.15.7 ω_2	0	0	$\eta_2 = \pi/2\omega_2$	$e^{\pi/4}\sqrt{2}$
18.15.8 $\omega' = \omega_3$	$-i/2$	0	$\frac{1}{2}(\eta_2 + \eta_2')$	$e^{i\pi/4}e^{\pi/8}(2^{1/4})$
18.15.9 ω_2'	0	0	$\eta_2' = -i\eta_2$	$2\sigma(\omega_2)$

Relations with Lemniscatic Values

18.15.10 $\mathcal{P}(z; -1, 0) = i\mathcal{P}(ze^{i\pi/4}; 1, 0)$

18.15.12 $\zeta(z; -1, 0) = e^{i\pi/4}\zeta(ze^{i\pi/4}; 1, 0)$

18.15.11 $\mathcal{P}'(z; -1, 0) = e^{3\pi i/4}\mathcal{P}'(ze^{i\pi/4}; 1, 0)$

18.15.13 $\sigma(z; -1, 0) = e^{-i\pi/4}\sigma(ze^{i\pi/4}; 1, 0)$

Numerical Methods

18.16. Use and Extension of the Tables

Example 1. Lemniscatic Case

(a) Given $z = x + iy$ in the Fundamental Triangle, find $\mathcal{P}(\mathcal{P}', \zeta, \sigma)$ more accurately than can be done with the maps.

σ —Use Maclaurin series throughout the Fundamental Triangle. Five terms give at least six significant figures, six terms at least ten. \mathcal{P}, ζ —Use Laurent's series directly "near" 0, (if $|z| < 1$, four terms give at least eight significant figures for \mathcal{P} , nine for ζ ; five terms at least ten significant figures for \mathcal{P} , eleven for ζ). Use Taylor's series directly "near" z_0 . Elsewhere (unless approximately seven or eight significant figures are insufficient) use economized polynomials to obtain $\mathcal{P}(x), \mathcal{P}'(x)$ and/or $\zeta(x)$ as appropriate. To get $\mathcal{P}(iy), \mathcal{P}'(iy)$ and/or $\zeta(iy)$, use Laurent's series for "small" y , otherwise use economized polynomials to compute $\mathcal{P}(y), \mathcal{P}'(y)$ and/or $\zeta(y)$, then use complex multiplication to obtain $\mathcal{P}(iy), \mathcal{P}'(iy)$ and/or $\zeta(iy)$. Finally, use appropriate addition formula to get $\mathcal{P}(z)$ and/or $\zeta(z)$.

\mathcal{P}' —Use Laurent's series directly "near" 0 (if $|z| < 1$, four terms give at least six significant figures, five terms at least eight significant figures). Elsewhere, either use economized polynomials and addition formula as for \mathcal{P} and ζ , or get $\mathcal{P}'^2 = 4\mathcal{P}^3 - \mathcal{P}$ and extract appropriate square root ($\mathcal{P}' \geq 0$).

(b) Given $\mathcal{P}(\mathcal{P}', \zeta, \sigma)$ corresponding to a point in the Fundamental Triangle, compute z more accurately than can be done with the maps. Only a few significant figures are obtainable from the use of any of the given (truncated) reversed series, except in a small neighborhood of the center of the series. For greater accuracy, use inverse interpolation procedures.

Example 2. Equianharmonic Case

(a) Given $z = x + iy$ in the Fundamental Triangle, find $\mathcal{P}(\mathcal{P}', \zeta, \sigma)$ more accurately than can be done with the maps.

σ —Use Maclaurin series throughout the Fundamental Triangle. Four terms give at least eleven significant figures, five terms at least twenty one.

\mathcal{P}, ζ —Use Laurent's series directly "near" 0 (if $|z| < 1$, four terms give at least 10S for \mathcal{P} , 11S for ζ ; five terms at least 13S for \mathcal{P} , 14S for ζ). Elsewhere (unless approximately seven or eight significant figures are insufficient) use economized polynomials to obtain $\mathcal{P}(x), \mathcal{P}'(x)$ and/or $\zeta(x)$, as appropriate. To get $\mathcal{P}(iy), \mathcal{P}'(iy)$ and/or $\zeta(iy)$, use Laurent's series. Then use appropriate addition formula to get $\mathcal{P}(z)$ and/or $\zeta(z)$.

\mathcal{P}' —Use Laurent's series directly "near" 0 (if $|z| < 1$, four terms give at least 8S, five terms at least 11S). Elsewhere, either proceed as for \mathcal{P} and ζ , or get $\mathcal{P}'^2 = 4\mathcal{P}^3 - 1$ and extract appropriate square root ($\mathcal{G}\mathcal{P}' \geq 0$).

(b) Given $\mathcal{P}(\mathcal{P}', \zeta, \sigma)$ corresponding to a point in the Fundamental Triangle, compute z more accurately than can be done with the maps. Only a few significant figures are obtainable from the use of any of the given (truncated) reversed series, except in a small neighborhood of the center of the series. For greater accuracy, use inverse interpolation procedures.

Example 3. Given period ratio a , find parameters m (of elliptic integrals and Jacobi's functions of chapter 16) and q (of ϑ functions).

m —In both the cases $\Delta > 0$ and $\Delta < 0$, the period ratio is equal to $K'(m)/K(m)$ (see 18.9). Knowing K'/K , if $1 < K'/K \leq 3$, use **Table 17.3** to find m ; if $K'/K > 3$, use the method of **Example 6** in chapter 17. An alternative method is to use **Table 18.3** to obtain the necessary entries, thence use

$$m = (e_2 - e_3)/(e_1 - e_3) \text{ in case } \Delta > 0,$$

$$m = \frac{1}{2} - 3e_2/4H_2 \text{ in case } \Delta < 0.$$

q —In both the cases $\Delta > 0$ and $\Delta < 0$, the period ratio determines the exponent for q [$q = e^{-\pi a}$ if $\Delta > 0$, $q = ie^{-\pi a/2}$ if $\Delta < 0$]. Hence enter **Table 4.16** [$e^{-\pi x}$, $x = 0.(01)1$] and multiply the results as appropriate [e.g., $e^{-4.72\pi} = (e^{-\pi})^4 (e^{-.72\pi})$].

Determination of Values at Half-Periods, Invariants and Related Quantities from Given Periods (Table 18.3)

$\Delta > 0$

Given ω and ω' , form $\omega'/i\omega$ and enter **Table 18.3**. Multiply the results obtained by the appropriate power of ω (see footnotes of **Table 18.3**) to obtain value desired.

Example 4.

Given $\omega = 10$, $\omega' = 11i$, find e_i , g_i , and Δ .

Here $\omega'/i\omega = 1.1$, so that direct reading of **Table 18.3** gives

$$e_1(1) = 1.6843 \ 041$$

$$e_2(1) = -.2166 \ 258 \ (= -e_1 - e_3)$$

$$e_3(1) = -1.4676 \ 783$$

$$g_2(1) = 10.0757 \ 7364$$

$$g_3(1) = 2.1420 \ 1000.$$

Multiplying by appropriate powers of $\omega = 10$ we obtain

$$e_1 = .01684 \ 3041$$

$$e_2 = -.00216 \ 6258$$

$$e_3 = -.01467 \ 6783$$

$$g_2 = 1.0075 \ 77364 \times 10^{-3}$$

$$g_3 = 2.1420 \ 1000 \times 10^{-6}$$

whence

$$\Delta = 8.9902 \ 3191 \times 10^{-10}$$

$\Delta < 0$

Given ω_2 and ω_2' , form $\omega_2'/i\omega_2$ and enter **Table 18.3**. Multiply the results obtained by the appropriate power of ω_2 (see footnotes of **Table 18.3**) to obtain value desired.

Example 4.

Given $\omega_2 = 10$, $\omega_2' = 11i$, find e_i , g_i , and Δ .

Here $\omega_2'/i\omega_2 = 1.1$, so that direct reading of **Table 18.3** gives

$$e_1(1) = -.2166 \ 2576 + 3.0842 \ 589i$$

$$e_2(1) = .4332 \ 5152 = -2\mathcal{R}(e_1)$$

$$e_3(1) = \bar{e}_1(1)$$

$$g_2(1) = -37.4874 \ 912$$

$$g_3(1) = 16.5668 \ 099.$$

Multiplying by appropriate powers of $\omega_2 = 10$ we obtain

$$e_1 = -.00216 \ 62576 + .03084 \ 2589i$$

$$e_2 = .00433 \ 25152$$

$$e_3 = \bar{e}_1$$

$$g_2 = -3.7487 \ 4912 \times 10^{-3}$$

$$g_3 = 1.6566 \ 8099 \times 10^{-6}$$

whence

$$\Delta = -6.0092 \ 019 \times 10^{-8}$$

Example 5. ($\Delta > 0$)

Given $\omega=10$, $\omega'=55i$, find η , η' , $\sigma(\omega)$, $\sigma(\omega')$ and $\sigma(\omega_2)$.

Forming $\omega'/i\omega=5.5$ and entering **Table 18.3** we obtain $\eta=.82246704$, $\sigma(\omega)=.96045\ 40$. Using Legendre's relation we find $\eta'=\eta\omega'-\pi i/2=2.9527\ 723i$. Since interpolation for $\sigma(\omega')$ and $\sigma(\omega+\omega')$ is difficult, use is made of **18.3.15-18.3.17** together with **18.3.4** and **18.3.6**. Values of g_2, g_3 and e_1 can be read directly to eight significant figures and e_3 to about five significant figures giving $g_2=8.1174\ 243$, $g_3=4.4508\ 759$, $e_1=1.6449\ 341$, and $e_3=-.82247$. Use of **18.3.6** yields $H_3=.00174\ 69$ and $H_2=.00174\ 69i$. Application of **18.3.15-18.3.17** yields $\sigma(\omega')/i=.0071177$ and $\sigma(\omega_2)=-.002016-.01055i$. Multiplying the results obtained by the appropriate powers of ω we obtain $\eta=.08224\ 6704$, $\eta'=.29527\ 723i$, $\sigma(\omega)=9.6045\ 40$, $\sigma(\omega')=.071177i$ and $\sigma(\omega_2)=-.02016-.1055i$.

Example 5. ($\Delta < 0$)

Given $\omega_2=1000$, $\omega_2'=1004i$, find η_2 , η_2' , $\sigma(\omega_2)$, $\sigma(\omega_2')$ and $\sigma(\omega')$.

With $\omega_2'/i\omega_2=1.004$, four point interpolation in **Table 18.3** gives $\eta_2=1.5626\ 756$, $\eta_2'=-1.5726\ 664i$, $\sigma(\omega_2)=1.1805\ 028$, $\sigma(\omega_2')=1.1901\ 52i$ and $\sigma(\omega')=.475084+.476717i$.

Multiplying the results obtained by the appropriate powers of ω_2 gives $\eta_2=.00156\ 26756$, $\eta_2'=-.00157\ 26664i$, $\sigma(\omega_2)=1180.5028$, $\sigma(\omega_2')=1190.152i$ and $\sigma(\omega')=475.084+476.717i$.

Determination of Periods from Given Invariants (Table 18.1.)

$\Delta > 0$

Given $g_2 > 0$ and $g_3 > 0$ such that $\Delta = g_2^3 - 27g_3^2 > 0$ (if $g_3 = 0$, $|\omega'| = \omega$; see lemniscatic case), compute $\bar{g}_2 = g_2g_3^{-2/3}$. From **Table 18.1**, determine $\omega g_3^{1/6}$ and $\omega' g_3^{1/6}$, thence ω and ω' .

Example 6.

Given $g_2=10$, $g_3=2$, find ω and ω' . With $\bar{g}_2 = g_2g_3^{-2/3} = 6.2996\ 05249$, from **Table 18.1** $\omega g_3^{1/6} = 1.1267\ 806$ and $\omega' g_3^{1/6} = 1.2324\ 295i$ whence $\omega = 1.003847$ and $\omega' = 1.097970i$.

Example 7.

Given $g_2=8$, $g_3=4$, find ω and ω' . With $\bar{g}_2 = g_2g_3^{-2/3} = 3.1748\ 02104$, from **Table 18.1** $\omega g_3^{1/6} = 1.2718\ 310$ and $\omega' g_3^{1/6} = 1.8702\ 425i$ whence $\omega = 1.009453$ and $\omega' = 1.484413i$.

$\Delta < 0$

Given g_2 and $g_3 > 0$ such that $\Delta = g_2^3 - 27g_3^2 < 0$ (if $g_3 = 0$, $|\omega_2'| = \omega_2$; see pseudo-lemniscatic case), compute $\bar{g}_2 = g_2g_3^{-2/3}$. From **Table 18.1**, determine $\omega_2 g_3^{1/6}$ and $\omega_2' g_3^{1/6}$, thence ω_2 and ω_2' .

Example 6.

Given $g_2=-10$, $g_3=2$, find ω_2 and ω_2' . With $\bar{g}_2 = g_2g_3^{-2/3} = -10/1.5874\ 0105 = -6.2996\ 053$, from **Table 18.1** $\omega_2 g_3^{1/6} = 1.5741\ 349$ and $\omega_2' g_3^{1/6} = 1.7124\ 396i$ whence $\omega_2 = 1.40239\ 48$ and $\omega_2' = 1.52561\ 02i$.

Example 7.

Given $g_2=7$, $g_3=6$, find ω_2 and ω_2' . With $\bar{g}_2 = g_2g_3^{-2/3} = 7/3.3019\ 2725 = 2.119974$, from **Table 18.1** $\omega_2 g_3^{1/6} = 1.3423\ 442$ and $\omega_2' g_3^{1/6} = 3.1441\ 141i$ whence $\omega_2 = .99579\ 976$ and $\omega_2' = 2.33241\ 83i$.

Computation of \mathcal{P} , \mathcal{P}' , or ζ for Given z and Arbitrary g_2, g_3

(or arbitrary periods from which g_2 and g_3 can be computed— in any case, periods must be known, at least approximately)

First reduce the problem (if necessary) to computation for a point z in the Fundamental Rectangle by use of appropriate results from **18.2**.

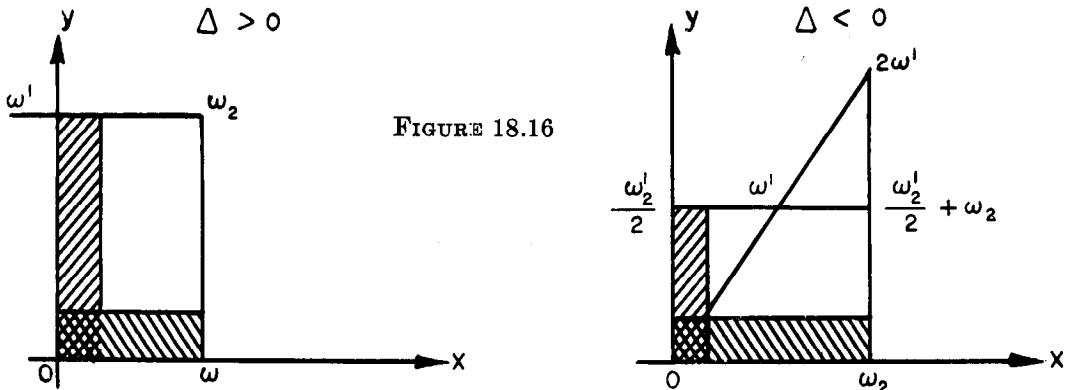

FIGURE 18.16

Method 1 (as accurate as desired)

If both x and y are "small," (point in double-cross hatched region) use Laurent's series in z directly. If either x or y is "large," use Laurent's series on $0x$, then on $0y$ and finally use an addition formula. (For \mathcal{P}' an alternative is to get \mathcal{P} , then compute the appropriate root of $\mathcal{P}'^2=4\mathcal{P}^3-g_2\mathcal{P}-g_3$; see 18.8.)

$$\Delta > 0$$

Method 2 (for \mathcal{P} or \mathcal{P}' only)

Compute $e_i (i=1,2,3)$ (if only g_2, g_3 are given use Table 18.1 to get the periods, then get e_i in Table 18.3; if periods are also given, use Table 18.3 directly). In any case, obtain $m (= [e_2 - e_3] / [e_1 - e_3])$, thence Jacobi's functions $\text{sn}(z^*|m)$, $\text{cn}(z^*|m)$, $\text{dn}(z^*|m)$, from 16.4 and 16.21 and \mathcal{P} or \mathcal{P}' from 18.9.11-18.9.12.

Method 3 (accuracy limited by Table 4.16 of $e^{-\pi x}$ and by the method of getting periods).

Obtain periods, their ratio a , then $q = e^{-\pi a}$ from Table 4.16. Hence get $\vartheta_i(0)$, $i=2,3,4$ from truncated series 18.10.21-23. Compute appropriate ϑ functions for $z=x$ and for $z=iy$, whence get $\mathcal{P}(x)$, $\mathcal{P}'(x)$ and/or $\zeta(x)$, $\mathcal{P}(iy)$, $\mathcal{P}'(iy)$ and/or $\zeta(iy)$, then use an addition formula (if either x or y is "small", it is probably easier to use Laurent's series).

Example 8. Given $z = .07 + .1i$, $g_2 = 10$, $g_3 = 2$, find \mathcal{P} .

Using Laurent's series directly with

$$\begin{aligned} c_2 &= .5 \\ c_3 &= .07142\ 85714 \\ c_4 &= .08333\ 33333 \\ c_5 &= .00974\ 02597 \\ z^{-2} &= -22.97193\ 820 - 63.06022\ 25i \\ +c_2z^2 &= - .00255\ 000 + .00700\ 00i \\ +c_3z^4 &= - .00001\ 214 - .00001\ 02i \\ +c_4z^6 &= + .00000\ 024 - .00000\ 01i \end{aligned}$$

$$\mathcal{P}(z) = -22.97450\ 010 - 63.05323\ 28i.$$

Example 9. Given $z = 15 + 73i$, $g_2 = 8$, $g_3 = 4$, find \mathcal{P} . From Example 7, $\omega = 1.009453$, $\omega' = 1.484413i$. From Table 18.3, $e_1 = 1.61803\ 37$, $e_3 = -.99999\ 96$, whence $m = .14589\ 79$. From 18.2.18 with $M=7$ and $N=24$, $\mathcal{P}(.867658 + 1.748176i) = \mathcal{P}(15 + 73i)$. Since z lies in R_2 , by 18.2.31 $\mathcal{P}(15 + 73i) = \overline{\mathcal{P}}(.867658 + 1.22065i)$. From 16.4 with $z^* = 1.40390 + 1.97505i$, $\text{sn}(z^*|m) = 2.46550 + 1.96527i$. Using 18.9.11, $\mathcal{P}(15 + 73i) = -.57743 + .067797i$.

$$\Delta < 0$$

Method 2 (for \mathcal{P} or \mathcal{P}' only)

Compute e_2 and H_2 (if only g_2, g_3 are given, use Table 18.1 to get the periods, then get e_i in Table 18.3; if periods are also given use Table 18.3 directly). In any case, obtain $m (= \frac{1}{2} - 3e_2/4H_2)$, thence Jacobi's functions $\text{sn}(z'|m)$, $\text{cn}(z'|m)$, $\text{dn}(z'|m)$, from 16.4 and 16.21 and \mathcal{P} or \mathcal{P}' from 18.9.11-18.9.12.

Method 3 (accuracy limited as in the case $\Delta > 0$).

Obtain periods, their ratio a , thence $q_2 = e^{-\pi a/2}$ from Table 4.16. Then proceed as in the case $\Delta > 0$, using corresponding formulas.

Example 8. Given $z = .1 + .03i$, $g_2 = -10$, $g_3 = 2$, find \mathcal{P} .

Using Laurent's series directly with

$$\begin{aligned} c_2 &= -.5 \\ c_3 &= .07142\ 85714 \\ c_4 &= .80333\ 33333 \\ z^{-2} &= 76.59287\ 938 - 50.50079\ 960i \\ c_2z^2 &= -.00455\ 000 - .00300\ 000i \\ c_3z^4 &= +.00000\ 334 + .00000\ 780i \\ c_4z^6 &= -.00000\ 002 + .00000\ 011i \end{aligned}$$

$$\mathcal{P}(z) = 76.58833\ 270 - 50.50379\ 169i.$$

Example 9. Given $z = 1.75 + 3.6i$, $g_2 = 7$, $g_3 = 6$, find \mathcal{P} . From Example 7, $\omega_2 = .99579\ 98$, $\omega'_2 = 2.33241\ 83i$. Using 18.2.18 with $M=1$, $N=1$, $\mathcal{P}(1.75 + 3.6i) = \mathcal{P}(-.24159\ 96 - 1.064836i) = \mathcal{P}(.24159\ 96 + 1.0648\ 36i)$. With $\Delta < 0$ from Table 18.3, $e_1 = -.81674\ 362 + .50120\ 90i$, $e_2 = 1.63348\ 724$, $e_3 = -.81674\ 362 - .50120\ 90i$ whence $m = .01014\ 3566$, $H_2 = 1.58144\ 50$, so that $z' = 2zH_2 = .76415\ 29 + 3.367959i$. From 16.4, $\text{cn}(z'|m) = 4.00543\ 66 - 12.32465\ 69i$. Applying 18.9.11, $\mathcal{P}(1.75 + 3.6i) = -.960894 - .383068i$.

$\Delta > 0$

Example 10. Given $\omega=10$, $\omega'=20i$, find $\zeta(9+19i)$ by use of theta functions, 18.10 and addition formulas.

For the period ratio $a=\omega'/\omega i=2$ with the aid of **Table 4.16**, $q=e^{-2\pi}=0.0186\ 74427$.

Using the truncated approximations 18.10.21–18.10.23 we compute the theta functions for argument zero. Using 16.27.1–16.27.4 we compute the theta functions for arguments v where $z=x$ and $z=iy$. Then, with 18.10.5–18.10.7 together with 18.10.9 and 18.10.18 we obtain $\zeta(9)=.09889\ 5484$, $\zeta(19i)=-.00120\ 0155i$, $\mathcal{P}(9)=.01706\ 9647$, $\mathcal{P}'(9)=-.00125\ 8460$, $\mathcal{P}(19i)=-.00861\ 2615$, $\mathcal{P}'(19i)=-.00003\ 757i$. Using the addition formula 18.4.3, we obtain $\zeta(9+19i)=.07439\ 49-.00046\ 88i$.

Use of Table 18.2 in Computing \mathcal{P} , \mathcal{P}' , ζ for Special Period Ratios

If the problem is reduced to computing \mathcal{P} , \mathcal{P}' , ζ in the Fundamental Rectangle for the case when the real half-period is unity and pure imaginary half-period is ia , for certain values of a **Table 18.2** may be used. Consider \mathcal{P} as an example. If $|z|$ is "small", then use Laurent's series directly for $\mathcal{P}(z)$ [invariants for use in the series are given in **Table 18.3**].

If x is "large" and y "small" use **Table 18.2** to obtain $x^2\mathcal{P}(x)$ and $x^3\mathcal{P}'(x)$, thence $\mathcal{P}(x)$ and $\mathcal{P}'(x)$; use Laurent's series to obtain $\mathcal{P}(iy)$ and $\mathcal{P}'(iy)$; finally, use addition formula 18.4.1.

For x "small" and y "large", reverse the procedure. For both x and y "large," use **Table 18.2** to obtain $\mathcal{P}(x)$, $\mathcal{P}'(x)$, $\mathcal{P}(iy)$ and $\mathcal{P}'(iy)$, thence use addition formula 18.4.1.

Similar procedures apply to \mathcal{P}' or ζ . For \mathcal{P}' , one can also first obtain \mathcal{P} , then compute $\mathcal{P}''=4\mathcal{P}^3-g_2\mathcal{P}-g_3$ and extract the appropriate square root (see 18.8 re choice of sign for \mathcal{P}').

 $\Delta > 0$

Example 11. Compute $\mathcal{P}(.8+i)$ when $a=1.2$. Using **Table 18.2** or Laurent's series 18.5.1–4 with $g_2=9.15782\ 851$ and

$g_3=3.23761\ 717$ from **Table 18.3**,

$$\mathcal{P}(.8)=1.92442\ 11,$$

$$\mathcal{P}'(.8)=-2.76522\ 05,$$

$$\mathcal{P}(i)=-1.40258\ 06$$
 and

$\mathcal{P}'(i)=-1.19575\ 58i$. Using the addition formula 18.4.1

$$\mathcal{P}(.8+i)=-.381433-.149361i.$$

Example 12. Compute $\zeta(.02+3i)$ for $a=4$. Using **Table 18.2** or Laurent's series 18.5.1–5 with

$$g_2=8.11742\ 426$$

$$g_3=4.45087\ 587$$

from **Table 18.3**,

$$\zeta(.02)=49.99999\ 89,$$

$$\mathcal{P}(.02)=2500.00016,$$

$$\mathcal{P}'(.02)=-249999.98376,$$

$$\zeta(3i)=.89635\ 173i,$$

$$\mathcal{P}(3i)=-.82326\ 511,$$

$$\mathcal{P}'(3i)=-.00249\ 829i.$$

Applying the addition formula 18.4.3,
 $\zeta(.02+3i)=.016465+.89635i$.

 $\Delta < 0$

Example 10. Given $\omega_2=5$, $\omega'_2=7i$ find $\mathcal{P}'(3+2i)$ by use of theta functions, 18.10 and addition formulas.

With the use of **Table 4.16** and 18.10.2, $q=ie^{-.7\pi}=.11090\ 12784i$.

The theta functions are computed for argument zero using 18.10.21–18.10.23 and the theta functions for arguments v_1 and v_2 corresponding to $z=z_1+z_2$ using 16.27.1–16.27.4. Using 18.10.5–18.10.6 together with 18.10.10, we find $\mathcal{P}(3)=.10576\ 946$, $\mathcal{P}(2i)=-.24497\ 773$, $\mathcal{P}'(3)=-.07474140$, $\mathcal{P}'(2i)=-.25576\ 007i$. The addition formula 18.4.1 yields $\mathcal{P}(3+2i)=.01763\ 210-.07769\ 187i$, and 18.4.2 yields $\mathcal{P}'(3+2i)=-.00069\ 182+.04771\ 305i$.

 $\Delta < 0$

Example 11. Compute $\mathcal{P}(.9+.1i)$ for $a=1.05$. Using **Table 18.2** or Laurent's series 18.5.1–4 with $g_2=-42.41653\ 54$ and

$g_3=9.92766\ 62$ from **Table 18.3**,

$$\mathcal{P}(.9)=.34080\ 33,$$

$$\mathcal{P}'(.9)=-2.164801,$$

$$\mathcal{P}(.1i)=-99.97876,$$

$\mathcal{P}'(.1i)=-2000.4255i$. With the addition formula 18.4.1

$$\mathcal{P}(.9+.1i)=.231859-.215149i.$$

Example 12. Compute $\mathcal{P}'(.4+.9i)$ for $a=2$. Using **Table 18.2** or Laurent's series 18.5.1–4, with

$$g_2=4.54009\ 85,$$

$$g_3=8.38537\ 94$$

from **Table 18.3**,

$$\mathcal{P}(.4)=6.29407\ 07,$$

$$\mathcal{P}'(.4)=-30.99041,$$

$$\mathcal{P}(.9i)=-1.225548,$$

$$\mathcal{P}'(.9i)=-3.19127\ 03i.$$

Using the addition formulas 18.4.1–2,

$$\mathcal{P}'(.4+.9i)=1.10519\ 76-.56489\ 00i.$$

Computation of σ for Given z and Arbitrary g_2 and g_3

(or periods from which g_2 and g_3 can be computed—in any case, periods must be known, at least approximately)

First reduce the problem (if necessary) to computation for a point z in the Fundamental Rectangle (see 18.2). After final reduction let z denote the point obtained.

$$\Delta > 0$$

If $\Re z > \omega/2$ or,

$\Im z > \omega'/2$, use duplication formula

$$\sigma(z) = -\mathcal{P}'(z/2)\sigma^4(z/2),$$

obtaining $\sigma(z/2)$ by use of Maclaurin series for σ and $\mathcal{P}'(z/2)$ by method explained above. Otherwise, simply use Maclaurin series for σ directly.

An alternate method is to use theta functions 18.10 first computing q and $\vartheta_i(0)$, $i=2, 3, 4$.

$$\Delta > 0$$

Example 13. Compute $\sigma(.4+1.3i)$ for $g_2=8$, $g_3=4$. From **Example 7**, $\omega=1.009453$ and $\omega'=1.484413i$. Since $\Im z > \omega'/2$, the Maclaurin series 18.5.6 is used to obtain $\sigma(z/2)=\sigma(.2+.65i)=.19543\ 86+.64947\ 28i$, the Laurent series 18.5.4 to obtain $\mathcal{P}'(.2+.65i)=5.02253\ 80-3.56066\ 93i$. The duplication formula 18.4.8 gives $\sigma(.4+1.3i)=.278080+1.272785i$.

$$\Delta < 0$$

If $\Re z > \omega_2/2$ or

$\Im z > \omega'_2/4$, use duplication formula as in case $\Delta > 0$. Otherwise, use Maclaurin series for σ directly.

$$\Delta < 0$$

Example 13. Compute $\sigma(.8+.4i)$ for $g_2=7$, $g_3=6$. From **Example 7**, $\omega_2=.99579\ 976$, $\omega'_2=2.33241\ 83i$. Since $\Re z > \omega_2/2$, the Maclaurin series 18.5.6 is used to obtain $\sigma(z/2)=\sigma(.4+.2i)=.40038\ 019+.19962\ 017i$, the Laurent series 18.5.4 to obtain $\mathcal{P}'(.4+.2i)=-3.70986\ 70+22.218544i$. The duplication formula 18.4.8 gives $\sigma(.8+.4i)=.81465\ 765+.38819\ 473i$.

Given $\sigma(\mathcal{P}, \mathcal{P}', \xi)$ corresponding to a point in the Fundamental Rectangle, as well as g_2 and g_3 or the equivalent, find z .

Only a few significant figures are obtainable from the use of any of the given (truncated) reversed series, except in a small neighborhood of the center of the series. For greater accuracy, use inverse interpolation procedures.

If the given function does not correspond to a value of z in the Fundamental Rectangle (see Conformal Maps) the problem can always be reduced to this case by the use of appropriate reduction formulas in 18.2. This process is relatively simple for $\mathcal{P}(z)$, more difficult for the other functions (e.g. if $\Delta > 0$ and $\mathcal{P}=a+ib$, where $b > 0$, simply consider $\overline{\mathcal{P}}=a-ib$ and find z_1 in R_1 [Figure 18.1]; then compute $z_2=\overline{z_1}+2\omega'$, the point in R_2 corresponding to the given \mathcal{P}).

$$\Delta > 0$$

Example 14. Given $\mathcal{P}=1-i$, $g_2=10$, $g_3=2$, find z . Using the first three terms of the reversed series 18.5.25 $z_1 \approx .727+.423i$. The Laurent series 18.5.1 gives

$$\mathcal{P}(z_1) = \mathcal{P}(.727+.423i) = .825-.895i$$

and

$$\mathcal{P}(z_2) = \mathcal{P}(.697+.393i) = .938-1.038i.$$

Inverse interpolation gives $z_1^{(1)} = .707+.380i$. Repeated applications of the above procedure yield $z = .706231+.379893i$.

$$\Delta < 0$$

Example 14. Given $\mathcal{P}=1+i$, $g_2=-10$, $g_3=2$, find z . From **Example 6**, $\omega_2=1.40239\ 48$ and $\omega'_2=1.52561\ 02i$. Since $b > 0$, z exists in R_2 and z is computed with $\overline{\mathcal{P}}$. Using 18.5.25 with $\alpha_2=-1.25$, $\alpha_3=.25$, $u=[(\overline{\mathcal{P}})^{-1}]^{1/2}$ and the coefficients c_n from **Example 8**

$$2u = 1.55377\ 3973+.64359\ 42493i$$

$$c_2u^5 = .08044\ 9281-.19422\ 17466i$$

$$c_3u^7 = -.01961\ 9359+.00812\ 66047i$$

$$\frac{\alpha_2^2 u^9}{3} = -.10115\ 7160-.04190\ 06673i$$

$\Delta > 0$

Example 15. Given $\zeta = 10 - 15i$, $g_2 = 8$, $g_3 = 4$, find z . Using the reversed series 18.5.40 with

$$A_5 = -.13333\ 333,$$

$$A_7 = -.02857\ 14286,$$

$$u = .03076\ 923076 + .04615\ 384615i$$

$$A_5 u^5 = -.00000\ 001402 + .00000\ 006860i$$

$$A_7 u^7 = -.00000\ 000004 - .00000\ 000003i$$

$$z = .03076\ 921670 + .04615\ 391472i.$$

 $\Delta < 0$

Stopping with the term in u^7 , $z_1 \approx .81 + .23i$. Assuming $\Delta z = -.03 - .01i$, using 18.5.1, $\mathcal{P}(.81 + .23i) = .91410\ 95 - .86824\ 37i$, $\mathcal{P}(.78 + .22i) = 1.03191\ 60 - .91795\ 22i$; with inverse interpolation $z_1^{(1)} = .7725 + .2404i$. Repeated applications of inverse interpolation yield $z = .772247 - .239258i$.

Example 15. Given $\sigma = .4 + .1i$, $g_2 = 7$, $g_3 = 6$, find z . Using the reversed series 18.5.70 with $\gamma_2 = .14583$, $\gamma_3 = .05$

$$\sigma = +.40000\ 000 + .10000\ 000i$$

$$\frac{\gamma_2 \sigma^5}{5} = +.00011\ 783 + .00032\ 696i$$

$$\frac{\gamma_3 \sigma^7}{7} = -.00000\ 208 + .00001\ 432i$$

$$\frac{3\gamma_2^2 \sigma^9}{14} = -.00000\ 093 + .00000\ 126i$$

$$\frac{19\gamma_2\gamma_3\sigma^{11}}{55} = -.00000\ 013 + .00000\ 006i$$

$$z = .40011\ 469 + .10034\ 260i$$

Methods of Computation of \mathcal{P} (\mathcal{P}' , ζ or σ) for Given z and Given g_2, g_3 (or the equivalent), with the Use of Automatic Digital Computing Machinery

(a) Integration of Differential Equation

\mathcal{P} and \mathcal{P}' may be generated for any z close enough to a "known point" z^* ($\mathcal{P}(z^*)$ and $\mathcal{P}'(z^*)$ being given) by integrating $\mathcal{P}'' = 6\mathcal{P}^2 - g_2/2$. A program to do this on SWAC, via a modification of the Hammer-Hollingsworth method (MTAC, July 1955, pp. 92-96) due to Dr. P. Henrici, exists at Numerical Analysis Research, UCLA (code number 00600, written by W. L. Wilson, Jr.). The program has been tested numerically in the equianharmonic case, using integration steps of various sizes. For example, if one starts with $z^* = \omega_2$, using an "integration step" (h, k) , where h and k are respectively the horizontal and vertical components of a step, with (h, k) having one of the six values $(\pm 2h_0, 0)$, $(\pm h_0, \pm k_0)$, $h_0 = \omega_2/2000$, $k_0 = |\omega_2'|/2000$, one can expect almost 8S in \mathcal{P} and 7S in \mathcal{P}' after 1000 steps, unless z is too near a pole.

(b) Use of Series

The process of reducing the computation problem to one in which z is in the Fundamental Rectangle can obviously be mechanized. Inside the Fundamental Rectangle the direct use of Laurent's series is appropriate when the period

ratio a is not too large. However, if $a \geq \sqrt{3}(\Delta > 0)$ or $a \geq 2\sqrt{3}(\Delta < 0)$, the series will diverge at the far corner of the Fundamental Rectangle, so that use may be made of an appropriate duplication formula. Alternatively, one may compute the functions on $0x$ and $0y$, then use an addition formula. Even so, the series will diverge at $z = ia$ if $a \geq 2(\Delta > 0)$ and at $z = ia/2$ if $a \geq 4(\Delta < 0)$.

For great accuracy, multiple precision operations might be necessary. Double precision floating point mode has been used in a program, written for SWAC, to compute \mathcal{P} , \mathcal{P}' and ζ .

For computation of σ , use of the Maclaurin series throughout the Fundamental Rectangle is probably simplest (series converges for all z).

Mention should be made of the possible use of the series defining the \wp functions. These series converge for all complex v , and the computation of \mathcal{P} , \mathcal{P}' , ζ and σ by 18.10.5-18.10.8 could easily be mechanized. The series involved have the advantage of converging very fast, even in case $\Delta < 0$, where $|q| \leq e^{-\pi^2/2}$ ($q \leq e^{-\pi}$ if $\Delta > 0$).

Use of Maps

If the problem (of computing \mathcal{P} , \mathcal{P}' , ζ or σ for given z) is reduced to the case where the real half-period is unity and imaginary half-period is one of those used in the maps in 18.8 inspection of the

appropriate figure will give the value of $\mathcal{P}(z)$ [$\zeta(z)$ or $\sigma(z)$] to 2–3S. If \mathcal{P}' is wanted instead, get \mathcal{P} , use 18.6.3 to obtain \mathcal{P}'^2 and select sign (s) of \mathcal{P}' appropriately. (See Conformal Mapping (18.8) for choice of sign of square root of \mathcal{P}'^2).

Computation of z_0

Given g_2, g_3 (or equivalent)

Since $z_0^2 \mathcal{P}(z_0) = 0$, the Laurent's series gives

$$0 = 1 + c_2 u^2 + c_3 u^3 + c_4 u^4 + \dots$$

where $u = z_0^2$. We may solve this equation [by Graeffe's (root-squaring) process or otherwise] for its absolutely smallest root [having found an

approximation to $|z_0|$ by Graeffe's process, we may use the fact that $z_0 = \omega + iy_0 (\Delta > 0)$, $z_0 = \omega_2 + iy_0 (\Delta < 0)$ to obtain an approximation to z_0].

It is noted that y_0/ω is a monotonic decreasing function of (period ratio) $a \geq 1$ for $\Delta > 0$ and

$$[1 \geq y_0/\omega > \frac{2}{\pi} \operatorname{arccosh} \sqrt{3} (\approx .7297)].$$

y_0/ω_2 is a monotonic increasing function of a for $\Delta < 0$ and

$$[0 \leq y_0/\omega_2 < \frac{2}{\pi} \operatorname{arccosh} \sqrt{3}]$$

Further data is available from Table 18.2 or from Conformal Maps defined by $\mathcal{P}(z)$.

References

Texts and Articles

- [18.1] P. Appell and E. Lacour, *Principes de la théorie des fonctions elliptiques et applications* (Gauthier-Villars, Paris, France, 1897).
- [18.2] A. Erdélyi et al., *Higher transcendental functions*, vol. 2, ch. 13 (McGraw-Hill Book Co., Inc., New York, N.Y., 1953).
- [18.3] E. Graeser, *Einführung in die Theorie der elliptischen Funktionen und deren Anwendungen* (R. Oldenbourg, Munich, Germany, 1950).
- [18.4] G. H. Halphen, *Traité des fonctions elliptiques et de leurs applications*, 1 (Gauthier-Villars, Paris, France, 1886).
- [18.5] H. Hancock, *Lectures on the theory of elliptic functions*, vol. 1 (John Wiley & Sons, Inc., New York, N.Y., 1910, reprinted, Dover Publications, Inc., New York, N.Y., 1958).
- [18.6] A. Hurwitz and R. Courant, *Vorlesungen über allgemeine Funktionentheorie und elliptische Funktionen*, 3d ed. (Springer, Berlin, Germany, 1929).
- [18.7] E. L. Ince, *Ordinary differential equations* (Dover Publications, Inc., New York, N.Y., 1944).
- [18.8] E. Kamke, *Differentialgleichungen, Lösungsmethoden und Lösungen*, vol. 1, 2d ed. (Akademische Verlagsgesellschaft, Leipzig, Germany, 1943).
- [18.9] D. H. Lehmer, The lemniscate constant, *Math. Tables Aids Comp.* **3**, 550–551 (1948–49).
- [18.10] S. C. Mitra, On the expansion of the Weierstrassian and Jacobian elliptic functions in powers of the argument, *Bull. Calcutta Math. Soc.* **17**, 159–172 (1926).
- [18.11] F. Oberhettinger and W. Magnus, *Anwendung der elliptischen Funktionen in Physik und Technik* (Springer, Berlin, Germany, 1949).
- [18.12] G. Prasad, *An introduction to the theory of elliptic functions and higher transcendentals* (Univ. of Calcutta, India, 1928).
- [18.13] U. Richard, Osservazioni sulla bisezione delle funzioni ellittiche di Weierstrass, *Boll. Un. Mat. Ital.* **3**, 4, 395–397 (1949).

- [18.14] E. S. Selmer, A simple trisection formula for the elliptic function of Weierstrass in the equianharmonic case, *Norske Vid. Selsk. Forh. Trondheim* **19**, 29, 116–119 (1947).
- [18.15] J. Tannery and J. Molk, *Éléments de la théorie des fonctions elliptiques*, 4 vols. (Gauthier-Villars, Paris, France, 1893–1902).
- [18.16] F. Tricomi, *Elliptische Funktionen* (Akademische Verlagsgesellschaft, Leipzig, Germany, 1948).
- [18.17] F. Tricomi, *Funzioni ellittiche*, 2d ed. (Bologna, Italy, 1951).
- [18.18] C. E. Van Orstrand, Reversion of power series, *Phil. Mag.* (6) **19**, 366–376 (Jan.–June 1910).
- [18.19] E. T. Whittaker and G. N. Watson, *A course of modern analysis*, ch. 20, 4th ed. (Cambridge Univ. Press, Cambridge, England, 1952).

Guides, Collections of Formulas, etc.

- [18.20] P. F. Byrd and M. D. Friedman, *Handbook of elliptic integrals for engineers and physicists*, Appendix, sec. 1030 (Springer-Verlag, Berlin, Germany, 1954).
- [18.21] A. Fletcher, Guide to tables of elliptic functions, *Math. Tables Aids Comp.* **3**, 247–249 (1948–49).
- [18.22] S. Flügge, *Handbuch der Physik*, vol. 1, pp. 120–146 (Springer-Verlag, Berlin, Germany, 1956).
- [18.23] H. Kober, *Dictionary of conformal representations* (Dover Publications, Inc., New York, N.Y., 1952).
- [18.24] L. M. Milne-Thomson, *Jacobian elliptic function tables* (Dover Publications, Inc., New York, N.Y., 1950).
- [18.25] K. Weierstrass and H. A. Schwarz, *Formeln und Lehrsätze zum Gebrauche der elliptischen Funktionen. Nach Vorlesungen und Aufzeichnungen des Herrn K. Weierstrass bearbeitet und herausgegeben von H. A. Schwarz*, 2d ed. (Springer, Berlin, Germany, 1893).

Tables

- [18.26] Chih-Bing Ling, Evaluation at half-periods of Weierstrass' elliptic function with rectangular primitive period-parallelogram, *Math. Comp.* **14**, 69, 67-70 (1960). Values of e_i ($i=1, 2, 3$) to 15D for various period ratios in case $\Delta > 0$.
- [18.27] E. Jahnke and F. Emde, *Tables of functions*, 4th ed., pp. 100-106 (Dover Publications, Inc., New York, N.Y., 1945). Equianharmonic case, real argument, $\mathcal{P}(u), \mathcal{P}'(u), \zeta(u), \sigma(u), u=0\left(\frac{\omega_2}{180}\right)$ $\frac{4\omega_2}{3}$, mostly 4D.
- [18.28] T. H. Southard, Approximation and table of the Weierstrass \mathcal{P} function in the equianharmonic case for real argument, *Math. Tables Aids Comp.* **11**, 58, 99-100 (Apr. 1957). $f(u) = \mathcal{P}(u) - \frac{1}{u^2}$ to 7D, with modified central differences, $u=0(.1).8(.05)1.55$.
- [18.29] D. A. Strayhorne, A study of an elliptic function (Thesis, Chicago, Ill., 1946). Air Documents Division T-2, AMC, Wright Field, Microfilm No. Rc-734F15000. $\mathcal{P}(z; 37, -42)$, 4D, $z=.04i(.04i)1.36i$.

Table 18.2 **TABLE FOR OBTAINING \mathcal{P} , \mathcal{P}' AND ζ ON $0x$ AND $0y$**
(Positive Discriminant—Unit Real Half-Period)

		$z^2\mathcal{P}(z)$						
$z=x\backslash u$	1.00	1.05	1.1	1.2	1.4	2.0	4.0	
0.00	1.00000 00	1.00000 00	1.00000 00	1.00000 00	1.00000 00	1.00000 00	1.00000 00	
0.05	1.00000 37	1.00000 34	1.00000 32	1.00000 29	1.00000 26	1.00000 25	1.00000 25	
0.10	1.00005 91	1.00005 41	1.00005 05	1.00004 59	1.00004 22	1.00004 08	1.00004 07	
0.15	1.00029 91	1.00027 41	1.00025 59	1.00023 31	1.00021 46	1.00020 75	1.00020 73	
0.20	1.00094 57	1.00086 77	1.00081 12	1.00074 02	1.00068 25	1.00066 02	1.00065 97	
0.25	1.00230 98	1.00212 32	1.00198 79	1.00181 79	1.00167 98	1.00162 64	1.00162 51	
0.30	1.00479 35	1.00441 61	1.00414 21	1.00379 79	1.00351 80	1.00340 97	1.00340 71	
0.35	1.00889 27	1.00821 33	1.00772 00	1.00709 99	1.00659 56	1.00640 03	1.00639 57	
0.40	1.01520 23	1.01408 14	1.01326 70	1.01224 31	1.01140 98	1.01108 69	1.01107 93	
0.45	1.02442 50	1.02269 65	1.02144 00	1.01985 94	1.01857 24	1.01807 36	1.01806 19	
0.50	1.03738 54	1.03486 08	1.03302 47	1.03071 36	1.02883 08	1.02810 10	1.02808 38	
0.55	1.05504 92	1.05152 36	1.04895 81	1.04572 73	1.04309 40	1.04207 28	1.04204 87	
0.60	1.07855 23	1.07381 21	1.07036 11	1.06601 29	1.06246 70	1.06109 15	1.06105 91	
0.65	1.10923 99	1.10307 22	1.09857 95	1.09291 64	1.08829 58	1.08650 29	1.08646 07	
0.70	1.14872 15	1.14092 35	1.13524 09	1.12807 45	1.12222 46	1.11995 41	1.11990 05	
0.75	1.19894 38	1.18933 40	1.18232 81	1.17348 94	1.16627 18	1.16346 98	1.16340 37	
0.80	1.26229 01	1.25071 86	1.24227 98	1.23162 95	1.22292 96	1.21955 14	1.21947 17	
0.85	1.34171 37	1.32807 28	1.31812 18	1.30556 03	1.29529 60	1.29130 97	1.29121 57	
0.90	1.44091 81	1.42515 17	1.41364 80	1.39912 31	1.38725 23	1.38264 14	1.38253 27	
0.95	1.56460 22	1.54671 40	1.53366 04	1.51717 65	1.50370 31	1.49846 94	1.49834 59	
1.00	1.71879 62	1.69885 59	1.68430 41	1.66592 77	1.65090 68	1.64507 17	1.64493 41	
	$\left[\begin{smallmatrix} (-3)4 \\ 8 \end{smallmatrix}\right]$	$\left[\begin{smallmatrix} (-3)4 \\ 8 \end{smallmatrix}\right]$	$\left[\begin{smallmatrix} (-3)4 \\ 8 \end{smallmatrix}\right]$	$\left[\begin{smallmatrix} (-3)4 \\ 8 \end{smallmatrix}\right]$	$\left[\begin{smallmatrix} (-3)4 \\ 8 \end{smallmatrix}\right]$	$\left[\begin{smallmatrix} (-3)4 \\ 8 \end{smallmatrix}\right]$	$\left[\begin{smallmatrix} (-3)4 \\ 8 \end{smallmatrix}\right]$	
$z/i=y\backslash u$	1.00	1.05	1.1	1.2	1.4	2.0	4.0	
0.00	1.00000 00	1.00000 00	1.00000 00	1.00000 00	1.00000 00	1.00000 00	1.00000 00	
0.05	1.00000 37	1.00000 34	1.00000 31	1.00000 29	1.00000 26	1.00000 25	1.00000 25	
0.10	1.00005 91	1.00005 40	1.00005 03	1.00004 57	1.00004 19	1.00004 05	1.00004 04	
0.15	1.00029 91	1.00027 31	1.00025 42	1.00023 05	1.00021 13	1.00020 39	1.00020 37	
0.20	1.00094 57	1.00086 20	1.00080 14	1.00072 54	1.00066 38	1.00063 99	1.00063 94	
0.25	1.00230 98	1.00210 14	1.00195 05	1.00176 15	1.00160 81	1.00154 88	1.00154 75	
0.30	1.00479 35	1.00435 08	1.00403 04	1.00362 91	1.00330 38	1.00317 81	1.00317 52	
0.35	1.00889 27	1.00804 86	1.00743 81	1.00667 40	1.00605 50	1.00581 59	1.00581 03	
0.40	1.01520 23	1.01371 37	1.01263 81	1.01129 28	1.01020 38	1.00978 33	1.00977 34	
0.45	1.02442 50	1.02194 93	1.02016 25	1.01792 92	1.01612 33	1.01542 64	1.01540 99	
0.50	1.03738 54	1.03345 04	1.03061 34	1.02707 18	1.02421 09	1.02310 77	1.02308 17	
0.55	1.05504 92	1.04901 44	1.04466 92	1.03925 21	1.03488 20	1.03319 83	1.03315 85	
0.60	1.07855 23	1.06955 87	1.06309 37	1.05504 64	1.04856 45	1.04606 96	1.04601 09	
0.65	1.10923 99	1.09614 60	1.08675 16	1.07507 92	1.06569 47	1.06208 70	1.06200 18	
0.70	1.14872 15	1.13001 89	1.11663 04	1.10003 09	1.08671 44	1.08160 18	1.08148 16	
0.75	1.19894 38	1.17264 63	1.15387 03	1.13065 03	1.11207 03	1.10494 84	1.10478 09	
0.80	1.26229 01	1.22578 78	1.19980 68	1.16777 18	1.14221 52	1.13243 76	1.13220 79	
0.85	1.34171 37	1.29157 86	1.25602 53	1.21233 97	1.17761 18	1.16435 46	1.16404 34	
0.90	1.44091 81	1.37264 39	1.32443 52	1.26544 15	1.21873 89	1.20095 66	1.20053 95	
0.95	1.56460 22	1.47224 79	1.40736 61	1.32835 02	1.26610 10	1.24247 14	1.24191 74	
1.00	1.71879 62	1.59449 89	1.50769 66	1.40258 06	1.32024 17	1.28909 73	1.28836 81	
1.05		1.74462 36	1.62902 39					
1.10			1.77589 10					
	$\left[\begin{smallmatrix} (-3)4 \\ 8 \end{smallmatrix}\right]$	$\left[\begin{smallmatrix} (-3)3 \\ 8 \end{smallmatrix}\right]$	$\left[\begin{smallmatrix} (-3)3 \\ 7 \end{smallmatrix}\right]$	$\left[\begin{smallmatrix} (-3)1 \\ 7 \end{smallmatrix}\right]$	$\left[\begin{smallmatrix} (-4)8 \\ 6 \end{smallmatrix}\right]$	$\left[\begin{smallmatrix} (-4)6 \\ 6 \end{smallmatrix}\right]$	$\left[\begin{smallmatrix} (-4)6 \\ 6 \end{smallmatrix}\right]$	
$z/i=y\backslash u$	1.00	1.05	1.1	1.2	1.4	2.0	4.0	
1.0	1.71879 62	1.59449 89	1.50769 66	1.40258 06	1.32024 17	1.28909 73	1.288368	
1.2				1.85616 29	1.61789 95	1.52970 17	1.527649	
1.4					2.09401 44	1.86127 05	1.855916	
1.6						2.28676 23	2.273495	
1.8						2.80921 52	2.777516	
2.0						3.43759 29	3.363868	
2.2							4.028426	
2.4							4.767658	
2.6							5.578809	
2.8							6.459856	
3.0							7.409386	
3.2							8.426442	
3.4							9.510400	
3.6							10.660867	
3.8							11.877621	
4.0							13.160574	

If the real half-period $\neq 1$, see 18.2 Homogeneity Relations. Interpolation with respect to u will, in general, be difficult because of the non-uniform subintervals involved. Aitken's interpolation may be used in this case. As few as 3S may be obtained. For the computation of \mathcal{P} , \mathcal{P}' or ζ at $z=r+iy$, an addition formula may be used (18.4 and Examples 11–12).

Table 18.2

TABLE FOR OBTAINING \wp , \wp' AND ζ ON $0x$ AND $0y$
(Positive Discriminant—Unit Real Half-Period)

$z=x \backslash a$	1.00	1.05	1.1	1.2	1.4	2.0	4.0
0.00	1.00000 000	1.00000 000	1.00000 000	1.00000 000	1.00000 000	1.00000 000	1.00000 000
0.05	0.99999 876	0.99999 887	0.99999 895	0.99999 905	0.99999 912	0.99999 915	0.99999 915
0.10	0.99998 031	0.99998 198	0.99998 319	0.99998 471	0.99998 595	0.99998 643	0.99998 644
0.15	0.99990 029	0.99990 871	0.99991 481	0.99992 246	0.99992 868	0.99993 109	0.99993 115
0.20	0.99968 483	0.99971 119	0.99973 030	0.99975 429	0.99977 377	0.99978 130	0.99978 148
0.25	0.99923 041	0.99929 399	0.99934 010	0.99939 799	0.99944 501	0.99946 321	0.99946 364
0.30	0.99840 360	0.99853 355	0.99862 782	0.99874 617	0.99884 235	0.99887 957	0.99888 045
0.35	0.99704 076	0.99727 741	0.99744 912	0.99766 478	0.99784 008	0.99790 793	0.99790 954
0.40	0.99494 715	0.99534 298	0.99563 028	0.99599 122	0.99628 469	0.99639 831	0.99640 099
0.45	0.99189 577	0.99251 583	0.99296 602	0.99353 179	0.99399 196	0.99417 016	0.99417 438
0.50	0.98762 541	0.98854 726	0.98921 683	0.99005 855	0.99074 340	0.99100 867	0.99101 490
0.55	0.98183 783	0.98315 105	0.98410 521	0.98530 511	0.98628 174	0.98666 012	0.98666 904
0.60	0.97419 386	0.97599 894	0.97731 096	0.97896 146	0.98030 531	0.98082 605	0.98083 833
0.65	0.96430 782	0.96671 478	0.96846 489	0.97066 726	0.97246 106	0.97315 633	0.97317 272
0.70	0.95174 028	0.95486 674	0.95714 079	0.96000 343	0.96233 582	0.96324 002	0.96326 132
0.75	0.93598 819	0.93995 720	0.94284 503	0.94648 146	0.94944 525	0.95059 446	0.95062 155
0.80	0.91647 208	0.92140 960	0.92500 321	0.92952 973	0.93322 007	0.93465 128	0.93468 503
0.85	0.89251 910	0.89855 136	0.90294 299	0.90847 617	0.91298 848	0.91473 876	0.91478 003
0.90	0.86334 108	0.87059 177	0.87587 177	0.88252 588	0.88795 364	0.89005 936	0.89010 902
0.95	0.82800 562	0.83659 307	0.84284 790	0.85073 222	0.85716 486	0.85966 076	0.85971 964
1.00	0.78539 822	0.79543 267	0.80274 283	0.81195 906	0.81947 977	0.82239 820	0.82246 703
	$\left[\begin{smallmatrix} (-4)9 \\ 7 \end{smallmatrix} \right]$	$\left[\begin{smallmatrix} (-4)9 \\ 8 \end{smallmatrix} \right]$	$\left[\begin{smallmatrix} (-4)9 \\ 8 \end{smallmatrix} \right]$	$\left[\begin{smallmatrix} (-4)9 \\ 8 \end{smallmatrix} \right]$	$\left[\begin{smallmatrix} (-4)9 \\ 8 \end{smallmatrix} \right]$	$\left[\begin{smallmatrix} (-4)9 \\ 8 \end{smallmatrix} \right]$	$\left[\begin{smallmatrix} (-4)9 \\ 8 \end{smallmatrix} \right]$
$z/i=y \backslash a$	1.00	1.05	1.1	1.2	1.4	2.0	4.0
0.00	1.00000 000	1.00000 000	1.00000 000	1.00000 000	1.00000 000	1.00000 000	1.00000 000
0.05	0.99999 876	0.99999 887	0.99999 895	0.99999 905	0.99999 912	0.99999 915	0.99999 915
0.10	0.99998 031	0.99998 200	0.99998 322	0.99998 476	0.99998 601	0.99998 649	0.99998 650
0.15	0.99990 029	0.99990 891	0.99991 516	0.99992 299	0.99992 935	0.99993 181	0.99993 187
0.20	0.99968 483	0.99971 234	0.99973 226	0.99975 725	0.99977 752	0.99978 537	0.99978 555
0.25	0.99923 041	0.99929 836	0.99934 758	0.99940 928	0.99945 935	0.99947 871	0.99947 917
0.30	0.99840 360	0.99854 660	0.99865 014	0.99877 991	0.99888 517	0.99892 586	0.99892 682
0.35	0.99704 076	0.99731 033	0.99750 544	0.99774 989	0.99794 811	0.99802 472	0.99802 653
0.40	0.99494 715	0.99541 639	0.99575 586	0.99618 100	0.99652 557	0.99665 871	0.99666 184
0.45	0.99189 577	0.99266 485	0.99322 092	0.99391 695	0.99448 077	0.99469 855	0.99470 368
0.50	0.98762 541	0.98882 817	0.98969 725	0.99078 438	0.99166 445	0.99200 425	0.99201 225
0.55	0.98183 783	0.98364 988	0.98495 820	0.98659 357	0.98791 646	0.98842 700	0.98843 902
0.60	0.97419 386	0.97684 238	0.97875 291	0.98113 896	0.98306 740	0.98381 123	0.98382 874
0.65	0.96430 782	0.96808 373	0.97080 464	0.97419 926	0.97694 003	0.97799 651	0.97802 138
0.70	0.95174 028	0.95701 320	0.96080 810	0.96553 710	0.96935 061	0.97081 949	0.97085 406
0.75	0.93598 819	0.94322 518	0.94842 600	0.95489 807	0.96010 986	0.96211 557	0.96216 276
0.80	0.91647 208	0.92626 102	0.93328 385	0.94200 908	0.94902 381	0.95172 061	0.95178 405
0.85	0.89251 910	0.90559 833	0.91496 295	0.92657 574	0.93589 412	0.93947 230	0.93955 644
0.90	0.86334 108	0.88063 688	0.89299 175	0.90827 878	0.92051 815	0.92521 144	0.92532 176
0.95	0.82800 562	0.85068 069	0.86683 386	0.88676 908	0.90268 849	0.90878 307	0.90892 628
1.00	0.78539 822	0.81491 420	0.83587 315	0.86166 128	0.88219 209	0.89003 731	0.89022 154
1.05		0.77237 164	0.79939 419				
1.10			0.75655 714				
	$\left[\begin{smallmatrix} (-4)9 \\ 7 \end{smallmatrix} \right]$	$\left[\begin{smallmatrix} (-4)8 \\ 8 \end{smallmatrix} \right]$	$\left[\begin{smallmatrix} (-4)8 \\ 7 \end{smallmatrix} \right]$	$\left[\begin{smallmatrix} (-4)4 \\ 7 \end{smallmatrix} \right]$	$\left[\begin{smallmatrix} (-4)3 \\ 6 \end{smallmatrix} \right]$	$\left[\begin{smallmatrix} (-4)3 \\ 6 \end{smallmatrix} \right]$	$\left[\begin{smallmatrix} (-4)3 \\ 6 \end{smallmatrix} \right]$
$z/i=y \backslash a$	1.00	1.05	1.1	1.2	1.4	2.0	4.0
1.0	0.78539 822	0.81491 420	0.83587 315	0.86166 128	0.88219 209	0.89003 731	0.89022 15
1.2				0.71573 454	0.76897 769	0.78909 505	0.78956 60
1.4					0.59293 450	0.64073 496	0.64184 73
1.6						0.43846 099	0.44095 77
1.8						+0.17708 802	+0.18250 43
2.0						-0.14800 012	-0.13652 01
2.2							-0.51809 61
2.4							-0.96348 97
2.6							-1.47349 03
2.8							-2.04858 16
3.0							-2.68905 52
3.2							-3.39508 38
3.4							-4.16677 17
3.6							-5.00417 86
3.8							-5.90734 21
4.0							-6.87630 32
						$\left[\begin{smallmatrix} (-3)8 \\ 7 \end{smallmatrix} \right]$	$\left[\begin{smallmatrix} (-3)8 \\ 10 \end{smallmatrix} \right]$

TABLE FOR OBTAINING \mathcal{P} , \mathcal{P}' AND ζ ON $0x$ AND $0y$ (Negative Discriminant—Unit Real Half-Period)

Table 18.2

$z=x\backslash a$	1.00	1.05	1.15	1.3	1.5	2.0	4.0
0.00	1.00000 00	1.00000 00	1.00000 00	1.00000 00	1.00000 00	1.00000 00	1.00000 00
0.05	0.99998 52	0.99998 68	0.99998 98	0.99999 38	0.99999 75	1.00000 14	1.00000 25
0.10	0.99976 37	0.99978 83	0.99983 74	0.99990 10	0.99996 06	1.00002 30	1.00004 07
0.15	0.99880 40	0.99893 08	0.99918 15	0.99950 43	0.99980 51	1.00011 83	1.00020 71
0.20	0.99622 33	0.99663 32	0.99743 55	0.99845 77	0.99940 30	1.00038 24	1.00065 92
0.25	0.99079 63	0.99182 47	0.99381 16	0.99631 17	0.99860 26	1.00096 01	1.00162 38
0.30	0.98097 82	0.98317 67	0.98736 11	0.99255 06	0.99725 51	1.00205 83	1.00340 46
0.35	0.96495 11	0.96915 65	0.97703 14	0.98664 20	0.99525 02	1.00396 14	1.00639 11
0.40	0.94070 57	0.94811 25	0.96174 61	0.97810 01	0.99255 94	1.00705 13	1.01107 17
0.45	0.90617 03	0.91839 70	0.94051 05	0.96656 45	0.98928 71	1.01183 11	1.01805 02
0.50	0.85939 83	0.87853 56	0.91254 55	0.95189 16	0.98573 01	1.01895 45	1.02806 66
0.55	0.79882 11	0.82744 45	0.87744 80	0.93426 12	0.98244 30	1.02925 89	1.04202 47
0.60	0.72356 52	0.76469 39	0.83537 63	0.91429 23	0.98031 24	1.04381 01	1.06102 67
0.65	0.63382 07	0.69080 48	0.78725 05	0.89316 80	0.98063 64	1.06395 05	1.08641 83
0.70	0.53123 69	0.60756 14	0.73495 90	0.87276 38	0.98521 20	1.09136 32	1.11984 70
0.75	0.41930 23	0.51830 84	0.68155 50	0.85577 68	0.99643 13	1.12815 05	1.16333 76
0.80	0.30366 33	0.42820 16	0.63143 16	0.84585 35	1.01739 07	1.17693 44	1.21939 20
0.85	0.19233 10	0.34438 12	0.59046 32	0.84771 96	1.05201 81	1.24098 76	1.29112 16
0.90	0.09574 08	0.27605 07	0.56611 51	0.86731 78	1.10523 21	1.32440 72	1.38242 38
0.95	0.02666 27	0.23446 42	0.56753 12	0.91197 25	1.18314 77	1.43234 85	1.49822 24
1.00	0.00000 00	0.23286 11	0.60563 48	0.99060 83	1.29335 96	1.57134 70	1.64479 64
	$\left[\begin{smallmatrix} (-3)5 \\ 8 \end{smallmatrix} \right]$	$\left[\begin{smallmatrix} (-3)5 \\ 8 \end{smallmatrix} \right]$	$\left[\begin{smallmatrix} (-3)5 \\ 8 \end{smallmatrix} \right]$	$\left[\begin{smallmatrix} (-3)4 \\ 8 \end{smallmatrix} \right]$	$\left[\begin{smallmatrix} (-3)4 \\ 8 \end{smallmatrix} \right]$	$\left[\begin{smallmatrix} (-3)4 \\ 8 \end{smallmatrix} \right]$	$\left[\begin{smallmatrix} (-3)4 \\ 8 \end{smallmatrix} \right]$

$z/i=y\backslash a$	1.00	1.05	1.15	1.3	1.5	2.0	4.0
0.00	1.00000 00	1.00000 00	1.00000 00	1.00000 00	1.00000 00	1.00000 00	1.00000 00
0.05	0.99998 52	0.99998 67	0.99998 98	0.99999 37	0.99999 75	1.00000 14	1.00000 32
0.10	0.99976 37	0.99978 76	0.99983 59	0.99989 93	0.99995 93	1.00002 24	1.00004 04
0.15	0.99880 40	0.99892 27	0.99916 47	0.99948 51	0.99978 96	1.00011 15	1.00020 35
0.20	0.99622 33	0.99658 78	0.99754 10	0.99834 96	0.99931 61	1.00034 41	1.00063 88
0.25	0.99079 63	0.99165 20	0.99345 16	0.99589 95	0.99827 12	1.00081 39	1.00154 61
0.30	0.98097 82	0.98266 22	0.98628 83	0.99132 10	0.99626 60	1.00162 14	1.00317 22
0.35	0.96495 11	0.96786 42	0.97433 43	0.98354 71	0.99275 81	1.00285 94	1.00580 47
0.40	0.94070 57	0.94525 04	0.95576 47	0.97122 41	0.98701 30	1.00459 41	1.00976 35
0.45	0.90617 03	0.91264 56	0.92846 67	0.95268 27	0.97806 19	1.00684 49	1.01539 36
0.50	0.85939 83	0.86784 46	0.89009 57	0.92592 17	0.96465 71	1.00955 92	1.02305 58
0.55		0.80881 13	0.83817 66	0.88861 10	0.94522 83	1.01258 51	1.03311 90
0.60			0.77024 24	0.83812 71	0.91784 50	1.01563 95	1.04595 22
0.65				0.77163 28	0.88019 00	1.01827 41	1.06191 71
0.70					0.82955 45	1.01983 61	1.08136 14
0.75					0.76286 31	1.01942 61	1.10461 36
0.80						1.01585 25	1.13197 83
0.85						1.00758 28	1.16373 23
0.90						0.99269 39	1.20012 24
0.95						0.96882 29	1.24136 39
1.00						0.93312 29	1.28763 91
	$\left[\begin{smallmatrix} (-3)2 \\ 7 \end{smallmatrix} \right]$	$\left[\begin{smallmatrix} (-3)2 \\ 7 \end{smallmatrix} \right]$	$\left[\begin{smallmatrix} (-3)2 \\ 8 \end{smallmatrix} \right]$	$\left[\begin{smallmatrix} (-3)2 \\ 7 \end{smallmatrix} \right]$	$\left[\begin{smallmatrix} (-3)2 \\ 7 \end{smallmatrix} \right]$	$\left[\begin{smallmatrix} (-3)1 \\ 6 \end{smallmatrix} \right]$	$\left[\begin{smallmatrix} (-4)6 \\ 6 \end{smallmatrix} \right]$

$z/i=y\backslash a$	4.0
1.1	1.39585 80
1.2	1.52559 80
1.3	1.67719 97
1.4	1.85056 87
1.5	2.04521 26
1.6	2.26025 62
1.7	2.49441 96
1.8	2.74594 50
1.9	3.01245 16
2.0	3.29069 52
	$\left[\begin{smallmatrix} (-3)3 \\ 7 \end{smallmatrix} \right]$

If the real half-period $\neq 1$, see 18.2 Homogeneity Relations. Interpolation with respect to a will, in general, be difficult because of the non-uniform subintervals involved. Aitken's interpolation may be used in this case. As few as 3S may be obtained. For the computation of \mathcal{P} , \mathcal{P}' or ζ at $z=r+iy$, an addition formula may be used (18.4 and Examples 11-12).

Table 18.2 TABLE FOR OBTAINING \wp , \wp' AND ζ ON $0x$ AND $0y$
(Negative Discriminant—Unit Real Half-Period)

$z = x\sqrt{a}$	$-\wp'(z)$							
	1.00	1.05	1.15	1.3	1.5	2.0	4.0	
0.00	-2.00000 00	-2.00000 00	-2.00000 00	-2.00000 00	-2.00000 00	-2.00000 00	-2.00000 00	-2.00000 00
0.05	-2.00002 95	-2.00002 65	-2.00002 04	-2.00001 24	-2.00000 50	-1.99999 71	-1.99999 49	-1.99999 49
0.10	-2.00047 25	-2.00042 27	-2.00032 37	-2.00019 63	-2.00007 74	-1.99995 34	-1.99991 83	-1.99991 83
0.15	-2.00239 01	-2.00212 89	-2.00161 92	-2.00097 17	-2.00037 44	-1.99975 65	-1.99958 21	-1.99958 21
0.20	-2.00753 43	-2.00667 30	-2.00502 56	-2.00297 32	-2.00110 66	-1.99919 66	-1.99866 07	-1.99866 07
0.25	-2.01829 41	-2.01608 73	-2.01196 38	-2.00694 49	-2.00246 05	-1.99793 23	-1.99667 11	-1.99667 11
0.30	-2.03755 78	-2.03274 55	-2.02397 99	-2.01358 73	-2.00448 84	-1.99544 16	-1.99294 36	-1.99294 36
0.35	-2.06843 88	-2.05907 94	-2.04247 95	-2.02334 71	-2.00696 68	-1.99095 74	-1.98657 99	-1.98657 99
0.40	-2.11379 74	-2.09713 03	-2.06835 37	-2.03614 78	-2.00922 15	-1.98338 63	-1.97639 65	-1.97639 65
0.45	-2.17550 18	-2.14789 87	-2.10148 48	-2.05106 10	-2.00992 37	-1.97120 64	-1.96084 72	-1.96084 72
0.50	-2.25339 16	-2.21047 72	-2.14013 46	-2.06592 49	-2.00685 64	-1.95234 05	-1.93791 93	-1.93791 93
0.55	-2.34395 53	-2.28098 85	-2.18023 97	-2.07692 41	-1.99665 49	-1.92399 70	-1.90499 42	-1.90499 42
0.60	-2.43881 27	-2.35140 73	-2.21466 43	-2.07815 03	-1.97452 31	-1.88246 83	-1.85865 81	-1.85865 81
0.65	-2.52318 49	-2.40840 49	-2.23248 50	-2.06116 83	-1.93392 01	-1.82286 83	-1.79444 54	-1.79444 54
0.70	-2.57463 40	-2.43241 27	-2.21839 89	-2.01460 73	-1.86620 81	-1.73878 53	-1.70648 76	-1.70648 76
0.75	-2.56240 86	-2.39712 18	-2.15233 79	-1.92378 08	-1.76023 25	-1.62181 13	-1.58702 84	-1.58702 84
0.80	-2.44770 16	-2.26959 69	-2.00933 39	-1.77031 11	-1.60178 75	-1.46089 21	-1.42574 81	-1.42574 81
0.85	-2.18496 84	-2.01105 50	-1.75959 77	-1.53168 32	-1.37288 13	-1.24141 08	-1.20881 20	-1.20881 20
0.90	-1.72414 78	-1.57813 99	-1.36864 82	-1.18057 88	-1.05066 42	-0.94387 76	-0.91751 44	-0.91751 44
0.95	-1.01321 01	-0.92423 16	-0.79716 03	-0.68374 39	-0.60580 78	-0.54202 52	-0.52632 04	-0.52632 04
1.00	0.00000 00	0.00000 00	0.00000 00	0.00000 00	0.00000 00	0.00000 00	0.00000 00	0.00000 00
	$\left[\begin{smallmatrix} (-2)4 \\ 10 \end{smallmatrix} \right]$	$\left[\begin{smallmatrix} (-2)3 \\ 9 \end{smallmatrix} \right]$	$\left[\begin{smallmatrix} (-2)3 \\ 9 \end{smallmatrix} \right]$	$\left[\begin{smallmatrix} (-2)2 \\ 9 \end{smallmatrix} \right]$	$\left[\begin{smallmatrix} (-2)2 \\ 9 \end{smallmatrix} \right]$	$\left[\begin{smallmatrix} (-2)2 \\ 9 \end{smallmatrix} \right]$	$\left[\begin{smallmatrix} (-2)2 \\ 9 \end{smallmatrix} \right]$	$\left[\begin{smallmatrix} (-2)2 \\ 9 \end{smallmatrix} \right]$
$z/i = y\sqrt{a}$	1.00	1.05	1.15	1.3	1.5	2.0	4.0	
0.00	-2.00000 00	-2.00000 00	-2.00000 00	-2.00000 00	-2.00000 00	-2.00000 00	-2.00000 00	-2.00000 00
0.05	-2.00002 95	-2.00002 65	-2.00002 05	-2.00001 25	-2.00000 50	-1.99999 72	-1.99999 49	-1.99999 49
0.10	-2.00047 25	-2.00042 55	-2.00032 97	-2.00020 30	-2.00008 28	-1.99995 58	-1.99991 95	-1.99991 95
0.15	-2.00239 01	-2.00216 12	-2.00168 65	-2.00104 87	-2.00043 62	-1.99978 38	-1.99959 66	-1.99959 66
0.20	-2.00753 43	-2.00685 42	-2.00540 32	-2.00340 55	-2.00145 41	-1.99935 00	-1.99874 22	-1.99874 22
0.25	-2.01829 41	-2.01677 67	-2.01340 12	-2.00859 22	-2.00378 54	-1.99851 75	-1.99698 24	-1.99698 24
0.30	-2.03755 78	-2.03479 40	-2.02825 59	-2.01849 50	-2.00844 10	-1.99718 99	-1.99387 40	-1.99387 40
0.35	-2.06843 88	-2.06420 40	-2.05319 59	-2.03567 60	-2.01691 87	-1.99536 97	-1.98892 95	-1.98892 95
0.40	-2.11379 74	-2.10841 06	-2.09200 85	-2.06346 12	-2.03134 51	-1.99323 08	-1.98164 41	-1.98164 41
0.45	-2.17550 18	-2.17036 66	-2.14879 02	-2.10597 25	-2.05462 43	-1.99120 21	-1.97152 19	-1.97152 19
0.50	-2.25339 16	-2.25173 01	-2.22747 67	-2.16805 61	-2.09057 56	-1.99006 63	-1.95810 18	-1.95810 18
0.55		-2.35170 68	-2.33108 42	-2.25504 79	-2.14403 61	-1.99107 16	-1.94097 97	-1.94097 97
0.60			-2.46061 76	-2.37230 39	-2.22089 13	-1.99605 96	-1.91982 80	-1.91982 80
0.65				-2.52442 19	-2.32798 29	-2.00760 83	-1.89440 95	-1.89440 95
0.70					-2.47283 02	-2.02919 12	-1.86458 73	-1.86458 73
0.75					-2.66308 69	-2.06534 90	-1.83032 90	-1.83032 90
0.80						-2.12187 04	-1.79170 68	-1.79170 68
0.85						-2.20596 83	-1.74889 39	-1.74889 39
0.90						-2.32643 60	-1.70215 68	-1.70215 68
0.95						-2.49375 12	-1.65184 57	-1.65184 57
1.00						-2.72008 43	-1.59838 35	-1.59838 35
	$\left[\begin{smallmatrix} (-3)2 \\ 8 \end{smallmatrix} \right]$	$\left[\begin{smallmatrix} (-3)2 \\ 8 \end{smallmatrix} \right]$	$\left[\begin{smallmatrix} (-3)3 \\ 8 \end{smallmatrix} \right]$	$\left[\begin{smallmatrix} (-3)4 \\ 8 \end{smallmatrix} \right]$	$\left[\begin{smallmatrix} (-3)6 \\ 8 \end{smallmatrix} \right]$	$\left[\begin{smallmatrix} (-3)7 \\ 8 \end{smallmatrix} \right]$	$\left[\begin{smallmatrix} (-4)6 \\ 6 \end{smallmatrix} \right]$	
$z/i = y\sqrt{a}$	4.0							
1.1							-1.48398 95	-1.48398 95
1.2							-1.36337 47	-1.36337 47
1.3							-1.24144 17	-1.24144 17
1.4							-1.12345 13	-1.12345 13
1.5							-1.01509 75	-1.01509 75
1.6							-0.92286 21	-0.92286 21
1.7							-0.85472 55	-0.85472 55
1.8							-0.82134 27	-0.82134 27
1.9							-0.83783 54	-0.83783 54
2.0							-0.92645 86	-0.92645 86
							$\left[\begin{smallmatrix} (-3)9 \\ 9 \end{smallmatrix} \right]$	

TABLE FOR OBTAINING \wp , \wp' AND ζ ON $0x$ AND $0y$
(Negative Discriminant—Unit Real Half-Period)

Table 18.2

$z=x\backslash a$	1.00	1.05	1.15	1.3	1.5	2.0	4.0
0.00	1.00000 00	1.00000 00	1.00000 00	1.00000 00	1.00000 00	1.00000 00	1.00000 00
0.05	1.00000 49	1.00000 44	1.00000 34	1.00000 21	1.00000 08	0.99999 95	0.99999 92
0.10	1.00007 88	1.00007 06	1.00005 43	1.00003 31	1.00001 32	0.99999 24	0.99998 65
0.15	1.00039 88	1.00035 70	1.00027 40	1.00016 65	1.00006 60	0.99996 10	0.99993 12
0.20	1.00125 98	1.00112 60	1.00086 16	1.00052 15	1.00020 48	0.99987 51	0.99978 17
0.25	1.00307 33	1.00274 09	1.00208 94	1.00125 79	1.00048 81	0.99968 98	0.99946 41
0.30	1.00636 38	1.00566 06	1.00429 54	1.00256 91	1.00098 15	0.99934 32	0.99888 13
0.35	1.01176 23	1.01043 07	1.00787 32	1.00467 27	1.00175 16	0.99875 38	0.99791 11
0.40	1.01999 45	1.01767 00	1.01325 74	1.00779 77	1.00285 61	0.99781 57	0.99640 37
0.45	1.03186 18	1.02805 07	1.02090 50	1.01217 02	1.00433 47	0.99639 49	0.99417 86
0.50	1.04821 35	1.04227 15	1.03127 19	1.01799 52	1.00619 68	0.99432 31	0.99102 12
0.55	1.06990 78	1.06102 21	1.04478 39	1.02543 63	1.00840 79	0.99139 16	0.98667 79
0.60	1.09776 14	1.08493 81	1.06180 26	1.03459 22	1.01087 54	0.98734 37	0.98085 06
0.65	1.13248 70	1.11454 88	1.08258 64	1.04547 13	1.01343 17	0.98186 55	0.97318 91
0.70	1.17462 06	1.15021 58	1.10724 76	1.05796 45	1.01581 69	0.97457 57	0.96328 27
0.75	1.22444 09	1.19206 86	1.13570 79	1.07181 59	1.01765 94	0.96501 30	0.95064 87
0.80	1.28188 76	1.23993 78	1.16765 25	1.08659 33	1.01845 50	0.95262 09	0.93471 88
0.85	1.34648 26	1.29329 24	1.20248 62	1.10165 80	1.01754 41	0.93672 94	0.91482 13
0.90	1.41726 20	1.35118 37	1.23929 22	1.11613 35	1.01408 58	0.91653 15	0.89015 86
0.95	1.49272 42	1.41220 03	1.27679 52	1.12887 36	1.00702 73	0.89105 46	0.85977 85
1.00	1.57079 62	1.47443 48	1.31332 66	1.13842 65	0.99506 76	0.85912 29	0.82253 59
	$\left[\begin{smallmatrix} (-3)1 \\ 7 \end{smallmatrix} \right]$	$\left[\begin{smallmatrix} (-4)8 \\ 7 \end{smallmatrix} \right]$	$\left[\begin{smallmatrix} (-4)5 \\ 6 \end{smallmatrix} \right]$	$\left[\begin{smallmatrix} (-4)4 \\ 6 \end{smallmatrix} \right]$	$\left[\begin{smallmatrix} (-4)6 \\ 6 \end{smallmatrix} \right]$	$\left[\begin{smallmatrix} (-4)8 \\ 6 \end{smallmatrix} \right]$	$\left[\begin{smallmatrix} (-4)9 \\ 6 \end{smallmatrix} \right]$
$z/i=y\backslash a$	1.00	1.05	1.15	1.3	1.5	2.0	4.0
0.00	1.00000 00	1.00000 00	1.00000 00	1.00000 00	1.00000 00	1.00000 00	1.00000 00
0.05	1.00000 49	1.00000 44	1.00000 34	1.00000 21	1.00000 08	0.99999 95	0.99999 92
0.10	1.00007 88	1.00007 08	1.00005 46	1.00003 34	1.00001 35	0.99999 25	0.99998 65
0.15	1.00039 88	1.00035 86	1.00027 73	1.00017 04	1.00006 91	0.99996 24	0.99993 19
0.20	1.00125 98	1.00113 51	1.00088 05	1.00054 31	1.00022 22	0.99988 28	0.99978 57
0.25	1.00307 33	1.00277 55	1.00216 14	1.00134 04	1.00055 43	0.99971 90	0.99947 96
0.30	1.00636 38	1.00576 38	1.00451 03	1.00281 53	1.00117 94	0.99943 06	0.99892 78
0.35	1.01176 23	1.01069 02	1.00841 42	1.00529 28	1.00225 03	0.99897 41	0.99802 83
0.40	1.01999 45	1.01824 62	1.01445 97	1.00917 72	1.00396 67	0.99830 68	0.99666 50
0.45	1.03186 18	1.02921 31	1.02333 32	1.01496 03	1.00658 42	0.99739 10	0.99470 88
0.50	1.04821 35	1.04444 39	1.03581 72	1.02322 84	1.01042 41	0.99619 89	0.99202 03
0.55		1.06483 58	1.05277 97	1.03466 71	1.01588 39	0.99471 80	0.98845 10
0.60			1.07515 67	1.05006 29	1.02344 73	0.99295 77	0.98384 63
0.65				1.07029 97	1.03369 45	0.99095 58	0.97804 63
0.70					1.04730 93	0.98878 64	0.97088 86
0.75					1.06508 51	0.98656 79	0.96221 00
0.80						0.98447 25	0.95184 75
0.85						0.98273 54	0.93964 06
0.90						0.98166 56	0.92543 21
0.95						0.98165 63	0.90906 94
1.00						0.98319 64	0.89040 57
	$\left[\begin{smallmatrix} (-4)6 \\ 6 \end{smallmatrix} \right]$	$\left[\begin{smallmatrix} (-4)6 \\ 6 \end{smallmatrix} \right]$	$\left[\begin{smallmatrix} (-4)7 \\ 6 \end{smallmatrix} \right]$	$\left[\begin{smallmatrix} (-4)6 \\ 6 \end{smallmatrix} \right]$	$\left[\begin{smallmatrix} (-4)5 \\ 6 \end{smallmatrix} \right]$	$\left[\begin{smallmatrix} (-4)2 \\ 6 \end{smallmatrix} \right]$	$\left[\begin{smallmatrix} (-4)3 \\ 5 \end{smallmatrix} \right]$
$z/i=y\backslash a$						4.0	
1.1						0.84561 98	
1.2						0.79003 67	
1.3						0.72274 36	
1.4						0.64295 89	
1.5						0.55003 38	
1.6						0.44345 14	
1.7						0.32282 70	
1.8						0.18790 92	
1.9						+0.03858 90	
2.0						-0.12508 40	
						$\left[\begin{smallmatrix} (-3)2 \\ 6 \end{smallmatrix} \right]$	

Table 18.3 INVARIANTS AND VALUES AT HALF-PERIODS (Non-Negative Discriminant—Unit Real Half-Period)

$n = \omega'/i$	g_2	g_3	$e_1 = \mathcal{P}(1)$	$e_3 = \mathcal{P}(\omega')$	$\eta = \zeta(1)$	$\eta'/i = \zeta(\omega')/i$
1.00	11.81704 500	0.00000 000	1.71879 64	-1.71879 64	0.78539 816	-0.78539 82
1.02	11.37372 384	0.55318 992	1.71005 96	-1.66138 15	0.78979 718	-0.76520 32
1.04	10.98419 107	1.03485 699	1.70235 77	-1.60783 69	0.79367 192	-0.74537 75
1.06	10.64177 347	1.45484 521	1.69556 79	-1.55787 59	0.79708 535	-0.72588 58
1.08	10.34065 794	1.82151 890	1.68958 18	-1.51123 63	0.80009 279	-0.70669 61
1.10	10.07577 364	2.14201 000	1.68430 41	-1.46767 83	0.80274 283	-0.68777 92
1.12	9.84269 185	2.42241 937	1.67965 08	-1.42698 19	0.80507 817	-0.66910 88
1.14	9.63754 049	2.66798 153	1.67554 80	-1.38894 48	0.80713 637	-0.65066 09
1.16	9.45693 072	2.88320 000	1.67193 04	-1.35338 12	0.80895 045	-0.63241 38
1.18	9.29789 413	3.07195 918	1.66874 05	-1.32011 96	0.81054 949	-0.61434 79
1.20	9.15782 851	3.23761 717	1.66592 77	-1.28900 20	0.81195 906	-0.59644 54
1.22	9.03445 117	3.38308 317	1.66344 74	-1.25988 23	0.81320 168	-0.57869 03
1.24	8.92575 843	3.51088 223	1.66126 03	-1.23262 55	0.81429 717	-0.56106 78
1.26	8.82999 055	3.62320 977	1.65933 17	-1.20710 65	0.81526 299	-0.54356 50
1.28	8.74560 138	3.72197 756	1.65763 09	-1.18320 95	0.81611 453	-0.52616 97
1.30	8.67123 169	3.80885 265	1.65613 11	-1.16082 70	0.81686 533	-0.50887 14
1.32	8.60568 628	3.88529 056	1.65480 86	-1.13985 91	0.81752 732	-0.49166 03
1.34	8.54791 374	3.95256 351	1.65364 22	-1.12021 33	0.81811 103	-0.47452 75
1.36	8.49698 890	4.01178 462	1.65261 37	-1.10180 31	0.81862 572	-0.45746 53
1.38	8.45209 746	4.06392 870	1.65170 67	-1.08454 85	0.81907 958	-0.44046 65
1.40	8.41252 263	4.10985 014	1.65090 68	-1.06837 47	0.81947 977	-0.42352 46
1.42	8.37763 305	4.15029 819	1.65020 13	-1.05321 20	0.81983 269	-0.40663 39
1.44	8.34687 283	4.18593 045	1.64957 92	-1.03899 58	0.82014 389	-0.38978 91
1.46	8.31975 228	4.21732 438	1.64903 06	-1.02566 55	0.82041 831	-0.37298 56
1.48	8.29583 997	4.24498 728	1.64854 68	-1.01316 45	0.82066 031	-0.35621 91
1.50	8.27475 580	4.26936 502	1.64812 02	-1.00144 04	0.82087 370	-0.33948 58
1.52	8.25616 484	4.29084 965	1.64774 39	-0.99044 37	0.82106 191	-0.32278 22
1.54	8.23977 191	4.30978 602	1.64741 20	-0.98012 84	0.82122 787	-0.30610 54
1.56	8.22531 684	4.32647 752	1.64711 94	-0.97045 19	0.82137 423	-0.28945 25
1.58	8.21257 036	4.34119 120	1.64686 13	-0.96137 37	0.82150 329	-0.27282 11
1.60	8.20133 033	4.35416 210	1.64663 38	-0.95285 64	0.82161 711	-0.25620 90
1.65	8.17870 308	4.38026 291	1.64617 54	-0.93379 17	0.82184 628	-0.21475 00
1.70	8.16217 907	4.39931 441	1.64584 08	-0.91752 88	0.82201 364	-0.17337 32
1.75	8.15011 147	4.41322 294	1.64559 63	-0.90365 18	0.82213 589	-0.13205 85
1.80	8.14129 812	4.42337 818	1.64541 78	-0.89180 82	0.82222 516	-0.09079 10
1.85	8.13486 127	4.43079 368	1.64528 73	-0.88169 76	0.82229 038	-0.04955 91
1.90	8.13016 001	4.43620 896	1.64519 21	-0.87306 52	0.82233 800	-0.00835 41
1.95	8.12672 634	4.44016 375	1.64512 25	-0.86569 37	0.82237 281	+0.03283 07
2.00	8.12421 844	4.44305 205	1.64507 17	-0.85939 82	0.82239 820	0.07400 01
2.05	8.12238 671	4.44516 152	1.64503 45	-0.85402 10	0.82241 676	0.11515 80
2.10	8.12104 883	4.44670 219	1.64500 74	-0.84942 78	0.82243 032	0.15630 73
2.15	8.12007 164	4.44782 746	1.64498 76	-0.84550 41	0.82244 022	0.19745 01
2.20	8.11935 791	4.44864 934	1.64497 32	-0.84215 20	0.82244 745	0.23858 81
2.25	8.11883 660	4.44924 963	1.64496 26	-0.83928 80	0.82245 274	0.27972 23
2.30	8.11845 583	4.44968 808	1.64495 49	-0.83684 11	0.82245 659	0.32085 38
2.4	8.11797 459	4.45024 222	1.64494 51	-0.83296 37	0.82246 146	0.40311 12
2.5	8.11771 785	4.45053 785	1.64494 00	-0.83013 28	0.82246 406	0.48536 38
2.6	8.11758 087	4.45069 555	1.64493 71	-0.82806 54	0.82246 546	0.56761 39
2.7	8.11750 782	4.45077 969	1.64493 57	-0.82655 58	0.82246 619	0.64986 24
2.8	8.11746 884	4.45082 457	1.64493 49	-0.82545 33	0.82246 659	0.73211 01
2.9	8.11744 804	4.45084 852	1.64493 45	-0.82464 81	0.82246 680	0.81435 74
3.0	8.11743 694	4.45086 130	1.64493 43	-0.82406 01	0.82246 691	0.89660 44
3.1	8.11743 103	4.45086 811	1.64493 42	-0.82363 06	0.82246 698	0.97885 13
3.2	8.11742 787	4.45087 174	1.64493 41	-0.82331 68	0.82246 701	1.06109 81
3.3	8.11742 619	4.45087 368	1.64493 41	-0.82308 78	0.82246 702	1.14334 48
3.4	8.11742 529	4.45087 472	1.64493 41	-0.82292 04	0.82246 703	1.22559 16
3.5	8.11742 481	4.45087 528	1.64493 41	-0.82279 82	0.82246 703	1.30783 83
3.6	8.11742 455	4.45087 556	1.64493 41	-0.82270 89	0.82246 703	1.39008 50
3.7	8.11742 441	4.45087 572	1.64493 41	-0.82264 37	0.82246 704	1.47233 17
3.8	8.11742 434	4.45087 581	1.64493 41	-0.82259 61	0.82246 704	1.55457 84
3.9	8.11742 430	4.45087 585	1.64493 41	-0.82256 13	0.82246 704	1.63682 51
4.0	8.11742 426	4.45087 587	1.64493 41	-0.82253 59	0.82246 704	1.71907 18
∞	8.11742 426	4.45087 590	1.64493 41	-0.82246 70	0.82246 704	
$\Delta=0$	$\begin{bmatrix} (-3)7 \\ 8 \end{bmatrix}$	$\begin{bmatrix} (-3)9 \\ 8 \end{bmatrix}$	$\begin{bmatrix} (-4)1 \\ 5 \end{bmatrix}$	$\begin{bmatrix} (-4)5 \\ 6 \end{bmatrix}$	$\begin{bmatrix} (-5)7 \\ 6 \end{bmatrix}$	$\begin{bmatrix} (-5)5 \\ 5 \end{bmatrix}$

For $n=1: g_2=\omega^4, g_3=0, e_1=\omega^2/2, e_3=-\omega^2/2, \eta=\pi^i/4, \eta'/i=-\pi/4.$

For $n=\infty: g_2=\pi^4/12, g_3=\pi^6/216, e_1=\pi^2/6, e_3=-\pi^2/12, \eta=\pi^2/12, \eta'/i=\infty.$

($\omega=1.85407 4677$ is the real half-period in the Lemniscatic case 18.14.)

For $4 < a < \infty$, to obtain η' use Legendre's relation $\eta' = \omega' - \pi i/2.$

To obtain the corresponding values of tabulated quantities when the real half-period $\omega \neq 1$, multiply g_2 by ω^{-4} , g_3 by ω^{-6} , e_i by ω^{-2} and η by $\omega^{-1}.$

INVARIANTS AND VALUES AT HALF-PERIODS Table 18.3

(Non-Negative Discriminant—Unit Real Half-Period)

$u = \omega'/i$	$\sigma(1)$	$\sigma(\omega)/i$	$R\sigma(\omega_2)$	$\mathcal{G}\sigma(\omega_2)$
1.00	0.94989 88	0.949899	1.182951	1.182951
1.02	0.95114 80	0.967481	1.170397	1.218650
1.04	0.95224 92	0.984884	1.157316	1.253864
1.06	0.95321 98	1.002097	1.143695	1.288619
1.08	0.95407 54	1.019107	1.129522	1.322935
1.10	0.95482 97	1.035904	1.114782	1.356827
1.12	0.95549 47	1.052476	1.099457	1.390301
1.14	0.95608 10	1.068811	1.083531	1.423362
1.16	0.95659 79	1.084899	1.066989	1.456007
1.18	0.95705 36	1.100727	1.049814	1.488231
1.20	0.95745 55	1.116285	1.031991	1.520022
1.22	0.95780 98	1.131562	1.013507	1.551369
1.24	0.95812 22	1.146546	0.994349	1.582254
1.26	0.95839 77	1.161227	0.974506	1.612657
1.28	0.95864 07	1.175594	0.953970	1.642557
1.30	0.95885 49	1.189636	0.932733	1.671930
1.32	0.95904 38	1.203344	0.910790	1.700750
1.34	0.95921 04	1.216707	0.888138	1.728989
1.36	0.95935 73	1.229716	0.864776	1.756618
1.38	0.95948 68	1.242361	0.840704	1.783607
1.40	0.95960 10	1.254633	0.815927	1.809925
1.42	0.95970 18	1.266522	0.790449	1.835542
1.44	0.95979 06	1.278021	0.764278	1.860425
1.46	0.95986 89	1.289120	0.737425	1.884541
1.48	0.95993 80	1.299811	0.709900	1.907860
1.50	0.95999 90	1.310087	0.681719	1.930348
1.52	0.96005 27	1.319941	0.652896	1.951974
1.54	0.96010 01	1.329364	0.623452	1.972707
1.56	0.96014 19	1.338351	0.593404	1.992515
1.58	0.96017 87	1.346895	0.562777	2.011370
1.60	0.96021 13	1.354990	0.531593	2.029242
1.65	0.96027 67	1.373224	0.451372	2.069439
1.70	0.96032 45	1.388539	0.368286	2.102914
1.75	0.96035 94	1.400869	0.282840	2.129313
1.80	0.96038 49	1.410170	0.195588	2.148344
1.85	0.96040 35	1.416408	0.107125	2.159783
1.90	0.96041 71	1.419573	+0.018074	2.163478
1.95	0.96042 70	1.419665	-0.070918	2.159353
2.00	0.96043 43	1.416707	-0.159199	2.147412
2.05	0.96043 96	1.410733	-0.246114	2.127732
2.10	0.96044 35	1.401800	-0.331019	2.100473
2.15	0.96044 63	1.389977	-0.413290	2.065864
2.20	0.96044 84	1.375349	-0.492330	2.024211
2.25	0.96044 99	1.358018	-0.567579	1.975882
2.30	0.96045 10	1.338098	-0.638522	1.921308
2.4	0.96045 24	1.291016	-0.765682	1.795415
2.5	0.96045 31	1.235264	-0.870782	1.650936
2.6	0.96045 35	1.172151	-0.951807	1.492779
2.7	0.96045 37	1.103091	-1.007808	1.326086
2.8	0.96045 38	1.029557	-1.038896	1.155967
2.9	0.96045 39	0.953025	-1.046157	0.987255
3.0	0.96045 40	0.874937	-1.031530	0.824296
3.1	0.96045 40	0.796655	-0.997636	0.670787
3.2	0.96045 40	0.719428	-0.947586	0.529666
3.3	0.96045 40	0.644360	-0.884775	0.403050
3.4	0.96045 40	0.572395	-0.812687	0.292246
3.5	0.96045 40	0.504299	-0.734720	0.197780
3.6	0.96045 40	0.440663	-0.654024	0.119493
3.7	0.96045 40	0.381903	-0.573398	0.056643
3.8	0.96045 40	0.328268	-0.495196	+0.008033
3.9	0.96045 40	0.279851	-0.421291	-0.027857
4.0	0.96045 40	0.236623	-0.353075	-0.052740
∞	0.96045 40	0.000000	0.000000	0.000000
$\Delta=0$	$\begin{bmatrix} (-5)2 \\ 4 \end{bmatrix}$	$\begin{bmatrix} (-4)9 \\ 5 \end{bmatrix}$	$\begin{bmatrix} (-3)3 \\ 6 \end{bmatrix}$	$\begin{bmatrix} (-3)2 \\ 6 \end{bmatrix}$

$$\omega_2 = 1 + \omega', \quad e_2 = \mathcal{P}(1 + \omega') = -(e_1 + e_3), \quad \eta_2 = \zeta(1 + \omega') = \eta + \eta'.$$

$$\text{For } a=1: \sigma(1) = e^{\pi^2/4}/\omega, \quad \sigma(\omega') = ic(1), \quad \sigma(\omega_2) = \sqrt{2}e^{\pi^2/4}e^{i\pi/4}/\omega.$$

$$\text{For } a=\infty: \sigma(1) = 2e^{\pi^2/24}/\pi, \quad \sigma(\omega') = 0, \quad \sigma(\omega_2) = 0.$$

($\omega=1.854074677$ is the real half-period in the Lemniscatic case 18.14.)

To obtain the corresponding values of tabulated quantities when the real half-period $\omega \neq 1$, multiply σ by ω .

Table 18.3 INVARIANTS AND VALUES AT HALF-PERIODS
(Non-Positive Discriminant—Unit Real Half-Period)

$a = \omega_2'/i$	g_2	g_3	$R_{e_1} = \mathcal{R} \mathcal{P} \left(\frac{1}{2} - \frac{\omega_2'}{2} \right)$	$\mathcal{G}_{e_1} = \mathcal{G} \mathcal{P} \left(\frac{1}{2} - \frac{\omega_2'}{2} \right)$	$\eta_2 = \zeta(1)$	$\eta_2'/i = \zeta(\omega_2')/i$
1.00	-47.26818 00	0.00000 00	0.00000 000	3.43759 29	1.57079 63	-1.57079 63
1.02	-45.35272 19	4.41906 00	-0.04867 810	3.36827 69	1.53091 63	-1.58005 81
1.04	-43.40071 30	8.23156 58	-0.09452 083	3.29802 68	1.49282 30	-1.58905 67
1.06	-41.42954 84	11.49257 28	-0.13769 202	3.22711 39	1.45647 87	-1.59772 52
1.08	-39.45420 53	14.25448 26	-0.17834 547	3.15578 40	1.42184 01	-1.60600 53
1.10	-37.48749 12	16.56680 99	-0.21662 576	3.08425 89	1.38885 99	-1.61384 68
1.12	-35.54027 17	18.47603 08	-0.25266 894	3.01273 84	1.35748 74	-1.62120 68
1.14	-33.62168 02	20.02550 17	-0.28660 315	2.94140 17	1.32766 96	-1.62804 93
1.16	-31.73930 91	21.25543 82	-0.31854 915	2.87040 90	1.29935 18	-1.63434 96
1.18	-29.89938 64	22.20294 45	-0.34862 086	2.79990 29	1.27247 81	-1.64006 85
1.20	-28.10693 45	22.90208 34	-0.37692 571	2.73000 96	1.24699 24	-1.64520 18
1.22	-26.36591 62	23.38397 82	-0.40356 512	2.66084 07	1.22283 82	-1.64973 00
1.24	-24.67936 58	23.67693 85	-0.42863 481	2.59249 39	1.19995 95	-1.65364 28
1.26	-23.04950 83	23.80660 45	-0.45222 513	2.52505 44	1.17830 09	-1.65693 36
1.28	-21.47786 60	23.79610 09	-0.47442 139	2.45859 58	1.15780 77	-1.65959 88
1.30	-19.96535 52	23.66620 08	-0.49530 414	2.39318 14	1.13842 65	-1.66163 82
1.32	-18.51237 16	23.43548 95	-0.51494 941	2.32886 49	1.12010 52	-1.66305 38
1.34	-17.11886 71	23.12052 98	-0.53342 897	2.26569 11	1.10279 31	-1.66384 99
1.36	-15.78441 82	22.73602 29	-0.55081 058	2.20369 72	1.08644 09	-1.66403 91
1.38	-14.50828 67	22.29496 60	-0.56715 817	2.14291 32	1.07100 10	-1.66361 13
1.40	-13.28947 27	21.80880 22	-0.58253 209	2.08336 24	1.05642 75	-1.66259 42
1.42	-12.12676 19	21.28756 31	-0.59698 926	2.02506 27	1.04267 61	-1.66099 26
1.44	-11.01876 70	20.74000 36	-0.61058 339	1.96802 64	1.02970 43	-1.65881 85
1.46	-9.96396 40	20.17372 81	-0.62336 513	1.91226 13	1.01747 14	-1.65608 44
1.48	-8.96072 32	19.59530 70	-0.63538 226	1.85777 09	1.00593 83	-1.65280 40
1.50	-8.00733 71	19.01038 59	-0.64667 980	1.80455 50	0.99506 76	-1.64899 13
1.52	-7.10204 36	18.42378 52	-0.65730 023	1.75261 00	0.98482 36	-1.64466 08
1.54	-6.24304 63	17.83959 12	-0.66728 357	1.70192 94	0.97517 21	-1.63982 76
1.56	-5.42853 20	17.26123 98	-0.67666 751	1.65250 41	0.96608 09	-1.63450 65
1.58	-4.65668 53	16.69159 27	-0.68548 761	1.60432 26	0.95751 90	-1.62871 26
1.60	-3.92570 12	16.13300 57	-0.69377 734	1.55737 16	0.94945 69	-1.62246 17
1.65	-2.26537 64	14.79653 23	-0.71238 375	1.44527 36	0.93130 88	-1.60493 31
1.70	-0.82241 58	13.56033 77	-0.72831 198	1.34049 21	0.91571 53	-1.58487 67
1.75	+ 0.42844 48	12.43388 94	-0.74194 441	1.24271 21	0.90232 74	-1.56251 97
1.80	1.51045 44	11.41927 28	-0.75360 961	1.15159 40	0.89084 07	-1.53807 94
1.85	2.44471 18	10.51370 92	-0.76358 973	1.06678 48	0.88099 10	-1.51175 93
1.90	3.25015 81	9.71138 21	-0.77212 691	0.98792 73	0.87254 91	-1.48374 94
1.95	3.94365 25	9.00473 54	-0.77942 883	0.91466 65	0.86531 67	-1.45422 51
2.00	4.54009 85	8.38537 94	-0.78567 351	0.84665 46	0.85912 29	-1.42334 69
2.05	5.05259 79	7.84470 38	-0.79101 353	0.78355 46	0.85382 00	-1.39126 17
2.10	5.49261 57	7.37428 09	-0.79557 957	0.72504 25	0.84928 11	-1.35810 23
2.15	5.87014 76	6.96611 56	-0.79948 352	0.67080 91	0.84539 69	-1.32398 93
2.20	6.19388 05	6.61278 90	-0.80282 119	0.62056 06	0.84207 37	-1.28903 05
2.25	6.47134 49	6.30752 86	-0.80567 458	0.57401 95	0.83923 09	-1.25332 31
2.30	6.70905 42	6.04422 78	-0.80811 383	0.53092 40	0.83679 93	-1.21695 43
2.4	7.08692 59	5.62231 14	-0.81198 137	0.45410 32	0.83294 16	-1.14253 28
2.5	7.36377 30	5.31058 54	-0.81480 718	0.38831 56	0.83012 09	-1.06629 03
2.6	7.56643 61	5.08099 59	-0.81687 167	0.33200 75	0.82805 92	-0.98863 87
2.7	7.71470 39	4.91228 49	-0.81837 985	0.28383 23	0.82655 25	-0.90990 09
2.8	7.82312 83	4.78851 39	-0.81948 158	0.24262 75	0.82545 16	-0.83032 82
2.9	7.90239 07	4.69782 05	-0.82028 636	0.20739 21	0.82464 72	-0.75011 58
3.0	7.96032 11	4.63142 26	-0.82087 422	0.17726 58	0.82405 96	-0.66941 39
3.1	8.00265 32	4.58284 25	-0.82130 361	0.15151 09	0.82363 03	-0.58833 87
3.2	8.03358 32	4.54731 53	-0.82161 725	0.12949 50	0.82331 67	-0.50697 92
3.3	8.05618 01	4.52134 25	-0.82184 634	0.11067 62	0.82308 77	-0.42540 32
3.4	8.07268 80	4.50235 93	-0.82201 368	0.09459 10	0.82292 04	-0.34366 33
3.5	8.08474 69	4.48848 72	-0.82213 590	0.08084 29	0.82279 82	-0.26179 91
3.6	8.09355 57	4.47835 14	-0.82222 517	0.06909 25	0.82270 89	-0.17984 06
3.7	8.09999 01	4.47094 62	-0.82229 038	0.05904 97	0.82264 37	-0.09781 10
3.8	8.10469 00	4.46553 65	-0.82233 800	0.05046 65	0.82259 61	-0.01572 75
3.9	8.10812 30	4.46158 47	-0.82237 279	0.04313 08	0.82256 13	+0.06639 64
4.0	8.11063 05	4.45869 80	-0.82239 820	0.03686 13	0.82253 59	+0.14855 08
∞	8.11742 43	4.45087 59	-0.82246 703	0.00000 00	0.82246 70	∞
$\Delta=0$	$\begin{bmatrix} (-2)3 \\ 9 \end{bmatrix}$	$\begin{bmatrix} (-2)8 \\ 8 \end{bmatrix}$	$\begin{bmatrix} (-4)4 \\ 7 \end{bmatrix}$	$\begin{bmatrix} (-3)1 \\ 6 \end{bmatrix}$	$\begin{bmatrix} (-4)3 \\ 6 \end{bmatrix}$	$\begin{bmatrix} (-4)3 \\ 6 \end{bmatrix}$

For $a=1$: $g_2 = -4\omega^4$, $g_3 = 0$, $R_{e_1} = 0$, $\mathcal{G}_{e_1} = \omega^2$, $\eta_2 = \pi/2$, $\eta_2'/i = -\pi/2$.

For $a=\infty$: $g_2 = \pi^4/12$, $g_3 = \pi^6/216$, $R_{e_1} = -\pi^2/12$, $\mathcal{G}_{e_1} = 0$, $\eta_2 = \pi^2/12$, $\eta_2'/i = \infty$.

($\omega = 1.85407\ 4677$ is the real half-period in the Lemniscatic case 18.14.)

For $4 < a < \infty$, to obtain η_2' use Legendre's relation $\eta_2' = \eta_2 \omega_2' - \pi i$.

To obtain the corresponding values of tabulated quantities when the real half-period $\omega_2 \neq 1$, multiply g_2 by ω_2^{-4} , g_3 by ω_2^{-6} , e_i by ω_2^{-2} and η by ω_2^{-1} .

INVARIANTS AND VALUES AT HALF-PERIODS Table 18.3

(Non-Positive Discriminant—Unit Real Half-Period)

$a=\omega_2^2/i$	$\sigma(1)$	$\sigma(\omega_2^2)/i$	$\Re\sigma(\omega')$	$\Im\sigma(\omega')$
1.00	1.18295 13	1.182951	0.474949	0.474949
1.02	1.17091 79	1.219157	0.475654	0.483826
1.04	1.15940 62	1.255842	0.476433	0.492792
1.06	1.14841 45	1.292964	0.477275	0.501851
1.08	1.13793 68	1.330480	0.478169	0.511006
1.10	1.12796 39	1.368342	0.479107	0.520259
1.12	1.11848 38	1.406502	0.480078	0.529611
1.14	1.10948 26	1.444910	0.481074	0.539064
1.16	1.10094 49	1.483513	0.482085	0.548616
1.18	1.09285 44	1.522257	0.483104	0.558268
1.20	1.08519 40	1.561089	0.484122	0.568019
1.22	1.07794 61	1.599952	0.485132	0.577866
1.24	1.07109 31	1.638790	0.486126	0.587809
1.26	1.06461 72	1.677548	0.487098	0.597843
1.28	1.05850 11	1.716167	0.488041	0.607968
1.30	1.05272 75	1.754591	0.488949	0.618179
1.32	1.04727 97	1.792765	0.489817	0.628474
1.34	1.04214 12	1.830630	0.490639	0.638850
1.36	1.03729 63	1.868133	0.491410	0.649302
1.38	1.03272 96	1.905218	0.492126	0.659828
1.40	1.02842 64	1.941832	0.492783	0.670422
1.42	1.02437 26	1.977922	0.493376	0.681082
1.44	1.02055 48	2.013437	0.493902	0.691804
1.46	1.01696 00	2.048327	0.494357	0.702582
1.48	1.01357 57	2.082544	0.494739	0.713414
1.50	1.01039 05	2.116040	0.495045	0.724295
1.52	1.00739 28	2.148771	0.495272	0.735221
1.54	1.00457 23	2.180693	0.495418	0.746189
1.56	1.00191 88	2.211766	0.495480	0.757192
1.58	0.99942 27	2.241950	0.495458	0.768229
1.60	0.99707 51	2.271208	0.495348	0.779295
1.65	0.99179 98	2.340071	0.494687	0.807059
1.70	0.98727 79	2.402437	0.493456	0.834917
1.75	0.98340 36	2.457895	0.491645	0.862812
1.80	0.98008 56	2.506120	0.489246	0.890687
1.85	0.97724 49	2.546866	0.486255	0.918490
1.90	0.97481 36	2.579972	0.482673	0.946170
1.95	0.97273 30	2.605345	0.478503	0.973680
2.00	0.97095 31	2.622973	0.473748	1.000975
2.05	0.96943 05	2.632902	0.468417	1.028011
2.10	0.96812 82	2.635245	0.462516	1.054750
2.15	0.96701 46	2.630169	0.456054	1.081151
2.20	0.96606 23	2.617892	0.449041	1.107179
2.25	0.96524 80	2.598678	0.441488	1.132799
2.30	0.96455 19	2.572828	0.433405	1.157978
2.4	0.96344 79	2.502604	0.415693	1.206881
2.5	0.96264 13	2.410244	0.395997	1.253647
2.6	0.96205 18	2.299090	0.374417	1.298044
2.7	0.96162 12	2.172666	0.351055	1.339858
2.8	0.96130 65	2.034544	0.326022	1.378884
2.9	0.96107 67	1.888235	0.299435	1.414929
3.0	0.96090 89	1.737097	0.271420	1.447812
3.1	0.96078 62	1.584242	0.242114	1.477367
3.2	0.96069 67	1.432486	0.211664	1.503441
3.3	0.96063 12	1.284291	0.180224	1.525899
3.4	0.96058 34	1.141740	0.147962	1.544621
3.5	0.96054 86	1.006520	0.115052	1.559512
3.6	0.96052 31	0.879924	0.081678	1.570495
3.7	0.96050 44	0.762869	0.048028	1.577518
3.8	0.96049 08	0.655914	+0.014297	1.580552
3.9	0.96048 09	0.559298	-0.019318	1.579595
4.0	0.96047 37	0.472982	-0.052618	1.574671
∞	0.96045 40	0.000000	0.000000	0.000000
$\Delta=0$	$\begin{bmatrix} (-5)9 \\ 6 \end{bmatrix}$	$\begin{bmatrix} (-3)3 \\ 6 \end{bmatrix}$	$\begin{bmatrix} (-4)2 \\ 4 \end{bmatrix}$	$\begin{bmatrix} (-4)5 \\ 5 \end{bmatrix}$

$$\omega' = \frac{1}{2} + \frac{\omega_2^2}{2}, \quad \eta_3 = \mathcal{P}\left(\frac{1}{2} + \frac{\omega_2^2}{2}\right) = \bar{\eta}_1, \quad \eta_2 = \mathcal{P}(1) = -2\Re e_1, \quad \eta' = \mathcal{P}\left(\frac{1}{2} + \frac{\omega_2^2}{2}\right) = \frac{1}{2}(\eta_2 + \eta_3).$$

For $a=1$: $\sigma(1) = e^{\pi^4/\omega}$, $\sigma(\omega_2^2) = i\sigma(1)$, $\sigma(\omega') = e^{\pi^8 e^{i\pi/4}/2^{1/4}\omega}$.

For $a=\infty$: $\sigma(1) = 2e^{\pi^2/24}/\pi$, $\sigma(\omega_2^2) = 0$, $\sigma(\omega') = 0$.

($\omega = 1.854074677$ is the real half-period in the Lemniscatic case 18.14.)

To obtain the corresponding values of tabulated quantities when the real half-period $\omega_2 \neq 1$, multiply σ by ω_2 .

19. Parabolic Cylinder Functions

J. C. P. MILLER¹

Contents

	Page
Mathematical Properties	686
19.1. The Parabolic Cylinder Functions, Introductory	686
The Equation $\frac{d^2y}{dx^2} - (\frac{1}{4}x^2 + a)y = 0$	
19.2 to 19.6. Power Series, Standard Solutions, Wronskian and Other Relations, Integral Representations, Recurrence Relations	686
19.7 to 19.11. Asymptotic Expansions	689
19.12 to 19.15. Connections With Other Functions	691
The Equation $\frac{d^2y}{dx^2} + (\frac{1}{4}x^2 - a)y = 0$	
19.16 to 19.19. Power Series, Standard Solutions, Wronskian and Other Relations, Integral Representations	692
19.20 to 19.24. Asymptotic Expansions	693
19.25. Connections With Other Functions	695
19.26. Zeros	696
19.27. Bessel Functions of Order $\pm\frac{1}{4}$, $\pm\frac{3}{4}$ as Parabolic Cylinder Functions	697
Numerical Methods	697
19.28. Use and Extension of the Tables	697
References	700
Table 19.1. $U(a, x)$ and $V(a, x)$ $(0 \leq x \leq 5)$	702
$\pm a = 0(.1)1(.5)5; x = 0(.1)5, \quad 5S$	
Table 19.2. $W(a, \pm x)$ $(0 \leq x \leq 5)$	712
$\pm a = 0(.1)1(1)5; x = 0(.1)5, \quad 4-5D$ or S	
Table 19.3. Auxiliary Functions	720

The author acknowledges permission from H.M. Stationery Office to draw freely from [19.11] the material in the introduction, and the tabular values of $W(a, x)$ for $a = -5(1)5$, $\pm x = 0(.1)5$. Other tables of $W(a, x)$ and the tables of $U(a, x)$ and $V(a, x)$ were prepared on EDSAC 2 at the University Mathematical Laboratory, Cambridge, England, using a program prepared by Miss Joan Walsh for solution of general second order linear homogeneous differential equations with quadratic polynomial coefficients. The auxiliary tables were prepared at the Computation Laboratory of the National Bureau of Standards.

¹ The University Mathematical Laboratory, Cambridge, England. (Prepared under contract with the National Bureau of Standards.)

19. Parabolic Cylinder Functions

Mathematical Properties

19.1. The Parabolic Cylinder Functions

Introductory

These are solutions of the differential equation

$$19.1.1 \quad \frac{d^2y}{dx^2} + (ax^2 + bx + c)y = 0$$

with two real and distinct standard forms

$$19.1.2 \quad \frac{d^2y}{dx^2} - (\frac{1}{4}x^2 + a)y = 0$$

$$19.1.3 \quad \frac{d^2y}{dx^2} + (\frac{1}{4}x^2 - a)y = 0$$

The functions

19.1.4

$$y(a, x) \quad y(a, -x) \quad y(-a, ix) \quad y(-a, -ix)$$

are all solutions either of 19.1.2 or of 19.1.3 if any one is such a solution.

Replacement of a by $-ia$ and x by $xe^{i\pi}$ converts 19.1.2 into 19.1.3. If $y(a, x)$ is a solution of 19.1.2, then 19.1.3 has solutions:

19.1.5

$$y(-ia, xe^{i\pi}) \quad y(-ia, -xe^{i\pi}) \\ y(ia, -xe^{-i\pi}) \quad y(ia, xe^{-i\pi})$$

Both variable x and the parameter a may take on general complex values in this section and in many subsequent sections. Practical applications appear to be confined to real solutions of real equations; therefore attention is confined to such solutions, and, in general, formulas are given for the two equations 19.1.2 and 19.1.3 independently. The principal computational consequence of the remarks above is that reflection in the y -axis produces an independent solution in almost all cases (Hermite functions provide an exception), so that tables may be confined either to positive x or to a single solution of 19.1.2 or 19.1.3.

The Equation $\frac{d^2y}{dx^2} - (\frac{1}{4}x^2 + a)y = 0$

19.2. Power Series in x

Even and odd solutions of 19.1.2 are given by

19.2.1

$$y_1 = e^{-\frac{1}{2}x^2} M(\frac{1}{2}a + \frac{1}{4}, \frac{1}{2}, \frac{1}{2}x^2) \\ = e^{-\frac{1}{2}x^2} \left\{ 1 + (a + \frac{1}{2}) \frac{x^2}{2!} + (a + \frac{1}{2})(a + \frac{5}{2}) \frac{x^4}{4!} + \dots \right\} \\ = e^{-\frac{1}{2}x^2} {}_1F_1(\frac{1}{2}a + \frac{1}{4}; \frac{1}{2}; \frac{1}{2}x^2)$$

19.2.2

$$y_2 = e^{\frac{1}{2}x^2} M(-\frac{1}{2}a + \frac{1}{4}, \frac{1}{2}, -\frac{1}{2}x^2) \\ = e^{\frac{1}{2}x^2} \left\{ 1 + (a - \frac{1}{2}) \frac{x^2}{2!} + (a - \frac{1}{2})(a - \frac{5}{2}) \frac{x^4}{4!} + \dots \right\}$$

19.2.3

$$y_2 = xe^{-\frac{1}{2}x^2} M(\frac{1}{2}a + \frac{3}{4}, \frac{3}{2}, \frac{1}{2}x^2) \\ = e^{-\frac{1}{2}x^2} \left\{ x + (a + \frac{3}{2}) \frac{x^3}{3!} + (a + \frac{3}{2})(a + \frac{7}{2}) \frac{x^5}{5!} + \dots \right\}$$

19.2.4

$$y_2 = xe^{\frac{1}{2}x^2} M(-\frac{1}{2}a + \frac{3}{4}, \frac{3}{2}, -\frac{1}{2}x^2) \\ = e^{\frac{1}{2}x^2} \left\{ x + (a - \frac{3}{2}) \frac{x^3}{3!} + (a - \frac{3}{2})(a - \frac{7}{2}) \frac{x^5}{5!} + \dots \right\}$$

these series being convergent for all values of x (see chapter 13 for $M(a, c, z)$).

Alternatively,

19.2.5

$$y_1 = 1 + a \frac{x^2}{2!} + \left(a^2 + \frac{1}{2}\right) \frac{x^4}{4!} + \left(a^3 + \frac{7}{2}a\right) \frac{x^6}{6!} \\ + \left(a^4 + 11a^2 + \frac{15}{4}\right) \frac{x^8}{8!} + \left(a^5 + 25a^3 + \frac{211}{4}a\right) \frac{x^{10}}{10!} + \dots$$

19.2.6

$$y_2 = x + a \frac{x^3}{3!} + \left(a^2 + \frac{3}{2}\right) \frac{x^5}{5!} + \left(a^3 + \frac{13}{2}a\right) \frac{x^7}{7!} \\ + \left(a^4 + 17a^2 + \frac{63}{4}\right) \frac{x^9}{9!} + \left(a^5 + 35a^3 + \frac{531}{4}a\right) \frac{x^{11}}{11!} + \dots$$

in which non-zero coefficients a_n of $x^n/n!$ are connected by

$$19.2.7 \quad a_{n+2} = a \cdot a_n + \frac{1}{4}n(n-1)a_{n-2}$$

19.3. Standard Solutions

These have been chosen to have the asymptotic behavior exhibited in 19.8. The first is Whittaker's function [19.8, 19.9] in a more symmetrical notation.

19.3.1

$$U(a, x) = D_{-a-\frac{1}{2}}(x) = \cos \pi(\frac{1}{4} + \frac{1}{2}a) \cdot Y_1 - \sin \pi(\frac{1}{4} + \frac{1}{2}a) \cdot Y_2$$

19.3.2

$$V(a, x) = \frac{1}{\Gamma(\frac{1}{2}-a)} \{ \sin \pi(\frac{1}{4} + \frac{1}{2}a) \cdot Y_1 + \cos \pi(\frac{1}{4} + \frac{1}{2}a) \cdot Y_2 \}$$

in which

19.3.3 $Y_1 = \frac{1}{\sqrt{\pi}} \frac{\Gamma(\frac{1}{4}-\frac{1}{2}a)}{2^{1/2+a}} y_1 = \sqrt{\pi} \frac{\sec \pi(\frac{1}{4} + \frac{1}{2}a)}{2^{1/2+a} \Gamma(\frac{3}{4} + \frac{1}{2}a)} y_1$

19.3.4 $Y_2 = \frac{1}{\sqrt{\pi}} \frac{\Gamma(\frac{3}{4}-\frac{1}{2}a)}{2^{1/2-a}} y_2 = \sqrt{\pi} \frac{\csc \pi(\frac{1}{4} + \frac{1}{2}a)}{2^{1/2-a} \Gamma(\frac{1}{4} + \frac{1}{2}a)} y_2$

19.3.5

$$U(a, 0) = \frac{\sqrt{\pi}}{2^{1/2+a} \Gamma(\frac{3}{4} + \frac{1}{2}a)}$$

$$U'(a, 0) = -\frac{\sqrt{\pi}}{2^{1/2-a} \Gamma(\frac{1}{4} + \frac{1}{2}a)}$$

19.3.6

$$V(a, 0) = \frac{2^{1/2+a} \sin \pi(\frac{3}{4} - \frac{1}{2}a)}{\Gamma(\frac{3}{4} - \frac{1}{2}a)}$$

$$V'(a, 0) = \frac{2^{1/2+a} \sin \pi(\frac{1}{4} - \frac{1}{2}a)}{\Gamma(\frac{1}{4} - \frac{1}{2}a)}$$

In terms of the more familiar $D_n(x)$ of Whittaker,

19.3.7 $U(a, x) = D_{-a-\frac{1}{2}}(x)$

19.3.8

$$V(a, x) = \frac{1}{\pi} \Gamma(\frac{1}{2}+a) \{ \sin \pi a \cdot D_{-a-\frac{1}{2}}(x) + D_{-a-\frac{1}{2}}(-x) \}$$

19.4. Wronskian and Other Relations

19.4.1 $W\{U, V\} = \sqrt{2/\pi}$

19.4.2

$$\pi V(a, x) = \Gamma(\frac{1}{2}+a) \{ \sin \pi a \cdot U(a, x) + U(a, -x) \}$$

19.4.3

$$\Gamma(\frac{1}{2}+a)U(a, x) = \pi \sec^2 \pi a \{ V(a, -x) - \sin \pi a \cdot V(a, x) \}$$

19.4.4

$$\frac{\Gamma(\frac{1}{4}-\frac{1}{2}a) \cos \pi(\frac{1}{4} + \frac{1}{2}a)}{\sqrt{\pi} 2^{1/2-a}} y_1 = 2 \sin \pi(\frac{3}{4} + \frac{1}{2}a) \cdot Y_1 = U(a, x) + U(a, -x)$$

19.4.5

$$-\frac{\Gamma(\frac{3}{4}-\frac{1}{2}a) \sin \pi(\frac{1}{4} + \frac{1}{2}a)}{\sqrt{\pi} 2^{1/2-a}} y_2 = 2 \cos \pi(\frac{3}{4} + \frac{1}{2}a) \cdot Y_2 = U(a, x) - U(a, -x)$$

19.4.6

$$\sqrt{2\pi}U(-a, \pm ix) = \Gamma(\frac{1}{2}+a) \{ e^{-i\pi(3/2-a)} U(a, \pm x) + e^{i\pi(3/2-a)} U(a, \mp x) \}$$

19.4.7

$$\sqrt{2\pi}U(a, \pm x) = \Gamma(\frac{1}{2}-a) \{ e^{-i\pi(3/2+a)} U(-a, \pm ix) + e^{i\pi(3/2+a)} U(-a, \mp ix) \}$$

19.5. Integral Representations

A full treatment is given in [19.11] section 4. Representations are given here for $U(a, z)$ only; others may be derived by use of the relations given in 19.4.

19.5.1 $U(a, z) = \frac{\Gamma(\frac{1}{2}-a)}{2\pi i} e^{-z^2} \int_{\alpha} e^{zs-\frac{1}{2}s^2} s^{a-\frac{1}{2}} ds$

19.5.2 $= \frac{\Gamma(\frac{1}{2}-a)}{2\pi i} e^{z^2} \int_{\beta} e^{-zt^2} (z+t)^{a-\frac{1}{2}} dt$

where α and β are the contours shown in Figures 19.1 and 19.2.

When $a + \frac{1}{2}$ is a positive integer these integrals become indeterminate; in this case

19.5.3 $U(a, z) = \frac{1}{\Gamma(\frac{1}{2}+a)} e^{-z^2} \int_0^{\infty} e^{-zs-\frac{1}{2}s^2} s^{a-\frac{1}{2}} ds$

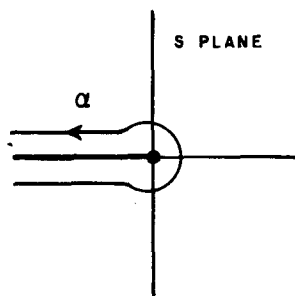

FIGURE 19.1
-π < arg s < π

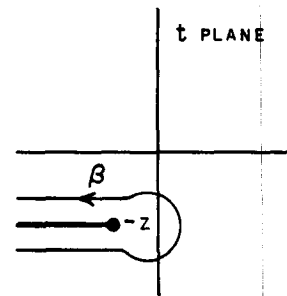

FIGURE 19.2
-π < arg(z+t) < π

19.5.4 $U(a, z) = \frac{1}{\sqrt{2\pi i}} e^{iz^2} \int_{\epsilon} e^{-zs + \frac{1}{2}s^2} s^{-a-\frac{1}{2}} ds$

19.5.5 $= \frac{e^{(a-\frac{1}{2})\pi i}}{\sqrt{2\pi i}} e^{iz^2} \int_{\epsilon_3} e^{zs + \frac{1}{2}s^2} s^{-a-\frac{1}{2}} ds$

19.5.6 $= \frac{e^{-(a-\frac{1}{2})\pi i}}{\sqrt{2\pi i}} e^{iz^2} \int_{\epsilon_4} e^{zs + \frac{1}{2}s^2} s^{-a-\frac{1}{2}} ds$

where ϵ , ϵ_3 and ϵ_4 are shown in Figures 19.3 and 19.4.

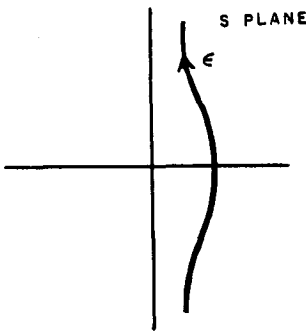

FIGURE 19.3
 $-\frac{1}{2}\pi < \arg s < \frac{1}{2}\pi$

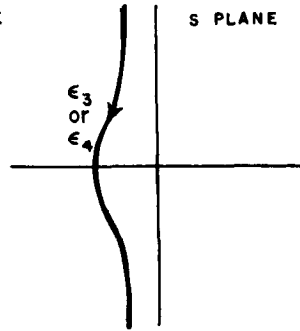

FIGURE 19.4
On ϵ_3 $\frac{1}{2}\pi < \arg s < \frac{3}{2}\pi$
On ϵ_4 $-\frac{3}{2}\pi < \arg s < -\frac{1}{2}\pi$

19.5.7

$\mathcal{U}(a, z) = \frac{\Gamma(\frac{3}{4} - \frac{1}{2}a)}{2^{1+a+\frac{1}{2}}\pi i} \int_{\zeta_1} e^{iz^2 t} (1+t)^{1-a-\frac{1}{2}} (1-t)^{-1-a-\frac{1}{2}} dt$

19.5.8

$= \frac{\Gamma(\frac{3}{4} - \frac{1}{2}a)}{2^{1+a+\frac{1}{2}}\pi i} \int_{\zeta_1} \frac{1}{2} z e^{v(\frac{1}{4}z^2+v)} t^{1-a-\frac{1}{2}} (\frac{1}{4}z^2-v)^{-1-a-\frac{1}{2}} dv$

19.5.9

$U(a, z) = \frac{i\Gamma(\frac{1}{4} - \frac{1}{2}a)}{2^{1+a+\frac{1}{2}}\pi} \int_{\eta_1} \frac{1}{2} z e^{-iz^2 t} (1+t)^{-1-a-\frac{1}{2}} (1-t)^{1-a-\frac{1}{2}} dt$

19.5.10

$= \frac{i\Gamma(\frac{1}{4} - \frac{1}{2}a)}{2^{1+a+\frac{1}{2}}\pi} \int_{\eta_1} e^{-v(\frac{1}{4}z^2+v)} t^{-1-a-\frac{1}{2}} (\frac{1}{4}z^2-v)^{1-a-\frac{1}{2}} dv$

The contour ζ_1 is such that $(\frac{1}{4}z^2+v)$ goes from $\infty e^{-i\pi}$ to $\infty e^{i\pi}$ while $v = \frac{1}{4}z^2$ is not encircled; $(\frac{1}{4}z^2-v)^{-1-a-\frac{1}{2}}$ has its principal value except possibly in the immediate neighborhood of the branch-point when encirclement is being avoided. Likewise η_1 is such that $(\frac{1}{4}z^2-v)$ goes from $\infty e^{i\pi}$ to $\infty e^{-i\pi}$ while encirclement of $v = -\frac{1}{4}z^2$ is similarly avoided. The contours (ζ_1) and (η_1) may be obtained from ζ_1 and η_1 by use of the substitution $v = \frac{1}{4}z^2 t$.

The expressions 19.5.7 and 19.5.8 become indeterminate when $a = \frac{3}{2}, \frac{7}{2}, \frac{11}{2}, \dots$; for these values

19.5.11

$U(a, z) = \frac{1}{\Gamma(\frac{1}{4} + \frac{1}{2}a)} z e^{-iz^2} \int_0^\infty e^{-s} s^{1-a-\frac{1}{2}} (z^2+2s)^{-1-a-\frac{1}{2}} ds$

Again 19.5.9 and 19.5.10 become indeterminate when $a = \frac{1}{2}, \frac{5}{2}, \frac{9}{2}, \dots$; for these values

19.5.12

$U(a, z) = \frac{1}{\Gamma(\frac{3}{4} + \frac{1}{2}a)} e^{-iz^2} \int_0^\infty e^{-s} s^{1-a-\frac{1}{2}} (z^2+2s)^{-1-a-\frac{1}{2}} ds$

Barnes-Type Integrals

19.5.13 $U(a, z) = \frac{e^{-iz^2}}{2\pi i} z^{-a-\frac{1}{2}} \int_{-\infty-i}^{+\infty+i} \frac{\Gamma(s)\Gamma(\frac{1}{2}+a-2s)}{\Gamma(\frac{1}{2}+a)} (\sqrt{2}z)^{2s} ds$ ($|\arg z| < \frac{3}{4}\pi$)

where the contour separates the zeros of $\Gamma(s)$ from those of $\Gamma(a+\frac{1}{2}-2s)$. Similarly

19.5.14 $V(a, z) = \sqrt{\frac{2}{\pi}} \frac{e^{iz^2}}{2\pi i} z^{a-\frac{1}{2}} \int_{-\infty-i}^{+\infty+i} \frac{\Gamma(s)\Gamma(\frac{1}{2}-a-2s)}{\Gamma(\frac{1}{2}-a)} (\sqrt{2}z)^{2s} \cos s\pi ds$ ($|\arg z| < \frac{1}{2}\pi$)

19.6. Recurrence Relations

19.6.1 $U'(a, x) + \frac{1}{2}xU(a, x) + (a+\frac{1}{2})U(a+1, x) = 0$

19.6.2 $U'(a, x) - \frac{1}{2}xU(a, x) + U(a-1, x) = 0$

19.6.3 $2U'(a, x) + U(a-1, x) + (a+\frac{1}{2})U(a+1, x) = 0$

19.6.4 $xU(a, x) - U(a-1, x) + (a+\frac{1}{2})U(a+1, x) = 0$

These are also satisfied by $\Gamma(\frac{1}{2}-a)V(a, x)$.

19.6.5 $V'(a, x) - \frac{1}{2}xV(a, x) - (a-\frac{1}{2})V(a-1, x) = 0$

19.6.6 $V'(a, x) + \frac{1}{2}xV(a, x) - V(a+1, x) = 0$

19.6.7

$2V'(a, x) - V(a+1, x) - (a-\frac{1}{2})V(a-1, x) = 0$

19.6.8

$xV(a, x) - V(a+1, x) + (a-\frac{1}{2})V(a-1, x) = 0$

These are also satisfied by $U(a, x)/\Gamma(\frac{1}{2}-a)$

19.6.9 $y'_1(a, x) + \frac{1}{2}xy_1(a, x) = (a+\frac{1}{2})y_2(a+1, x)$

19.6.10 $y'_1(a, x) - \frac{1}{2}xy_1(a, x) = (a-\frac{1}{2})y_2(a-1, x)$

19.6.11 $y_2'(a, x) + \frac{1}{2}xy_2(a, x) = y_1(a+1, x)$

19.6.12 $y_2'(a, x) - \frac{1}{2}xy_2(a, x) = y_1(a-1, x)$

Asymptotic Expansions

19.7. Expressions in Terms of Airy Functions

When a is large and negative, write, for $0 \leq x < \infty$

$$x = 2\sqrt{|a|}\xi \quad t = (4|a|)^{2/3}\tau$$

19.7.1

$$\tau = -(\frac{2}{3}\vartheta_3)^{3/2}$$

$$\vartheta_3 = \frac{1}{2} \int_{\xi}^1 \sqrt{1-s^2} ds = \frac{1}{4} \arccos \xi - \frac{1}{4}\xi\sqrt{1-\xi^2} \quad (\xi \leq 1)$$

19.7.2

$$\tau = +(\frac{2}{3}\vartheta_2)^{3/2}$$

$$\vartheta_2 = \frac{1}{2} \int_1^{\xi} \sqrt{s^2-1} ds = \frac{1}{4}\xi\sqrt{\xi^2-1} - \frac{1}{4} \operatorname{arccosh} \xi \quad (\xi \geq 1)$$

Then for $x \geq 0, a \rightarrow -\infty$

19.7.3

$$U(a, x) \sim 2^{-1-i} \Gamma(\frac{1}{4}-\frac{1}{2}a) \left(\frac{t}{\xi^2-1}\right)^{1/4} \operatorname{Ai}(t)$$

19.7.4

$$\Gamma(\frac{1}{2}-a) V(a, x) \sim 2^{-1-i} \Gamma(\frac{1}{4}-\frac{1}{2}a) \left(\frac{t}{\xi^2-1}\right)^{1/4} \operatorname{Bi}(t)$$

Table 19.3 gives τ as a function of ξ .

See [19.5] for further developments.

19.8. Expansions for x Large and a Moderate

When $x \gg |a|$

19.8.1

$$U(a, x) \sim e^{-1/2x^2} x^{-a-1/2} \left\{ 1 - \frac{(a+\frac{1}{2})(a+\frac{3}{2})}{2x^2} + \frac{(a+\frac{1}{2})(a+\frac{3}{2})(a+\frac{5}{2})(a+\frac{7}{2})}{2 \cdot 4x^4} - \dots \right\} \quad (x \rightarrow +\infty)$$

19.8.2

$$V(a, x) \sim \sqrt{\frac{2}{\pi}} e^{1/2x^2} x^{a-1/2} \left\{ 1 + \frac{(a-\frac{1}{2})(a-\frac{3}{2})}{2x^2} + \frac{(a-\frac{1}{2})(a-\frac{3}{2})(a-\frac{5}{2})(a-\frac{7}{2})}{2 \cdot 4x^4} + \dots \right\} \quad (x \rightarrow +\infty)$$

These expansions form the basis for the choice of standard solutions in 19.3. The former is valid for complex x , with $|\arg x| < \frac{1}{2}\pi$, in the complete

sense of Watson [19.6], although valid for a wider range of $|\arg x|$ in Poincaré's sense; the second series is completely valid *only for x real and positive*.

19.9. Expansions for a Large With x Moderate

(i) a positive

When $a \gg x^2$, with $p = \sqrt{a}$, then

19.9.1 $U(a, x) = \frac{\sqrt{\pi}}{2^{1/2} a^{1/4} \Gamma(\frac{3}{4} + \frac{1}{2}a)} \exp(-px + v_1)$

19.9.2 $U(a, -x) = \frac{\sqrt{\pi}}{2^{1/2} a^{1/4} \Gamma(\frac{3}{4} + \frac{1}{2}a)} \exp(px + v_2)$

where

19.9.3
$$v_1, v_2 \sim \mp \frac{\frac{2}{3}(\frac{1}{2}x)^3}{2p} - \frac{(\frac{1}{2}x)^2}{(2p)^2} \mp \frac{\frac{1}{2}x - \frac{2}{3}(\frac{1}{2}x)^5}{(2p)^3} + \frac{2(\frac{1}{2}x)^4}{(2p)^4} \pm \frac{(\frac{1}{3}\frac{1}{2}x)^3 - 4(\frac{1}{2}x)^7}{(2p)^5} + \dots$$

 $(a \rightarrow +\infty)$

The upper sign gives the first function, and the lower sign the second function.

(ii) a negative

When $-a \gg x^2$, with $p = \sqrt{-a}$, then

19.9.4

$$U(a, x) + i\Gamma(\frac{1}{2}-a) \cdot V(a, x)$$

$$= \frac{e^{i\pi(\frac{1}{4}+\frac{1}{2}a)} \Gamma(\frac{1}{4}-\frac{1}{2}a)}{2^{1/2} a^{1/4} \sqrt{\pi}} e^{ipx} \exp(v_r + iv_i)$$

where

19.9.5

$$v_r \sim + \frac{(\frac{1}{2}x)^2}{(2p)^2} + \frac{2(\frac{1}{2}x)^4}{(2p)^4} - \frac{9(\frac{1}{2}x)^2 - \frac{1}{3}(\frac{1}{2}x)^6}{(2p)^6} - \dots$$

$$v_i \sim - \frac{\frac{2}{3}(\frac{1}{2}x)^3}{2p} + \frac{\frac{1}{2}x + \frac{2}{3}(\frac{1}{2}x)^5}{(2p)^3} + \frac{\frac{1}{3}(\frac{1}{2}x)^3 - 4(\frac{1}{2}x)^7}{(2p)^5} - \dots$$

 $(a \rightarrow -\infty)$

Further expansions of a similar type will be found in [19.11].

19.10. Darwin's Expansions

(i) a positive, $x^2 + 4a$ large. Write

19.10.1

$$X = \sqrt{x^2 + 4a}$$

$$\theta = 4a\vartheta_1(x/2\sqrt{a}) = \frac{1}{2} \int_0^x X dx = \frac{1}{4}xX + a \ln \frac{x+X}{2\sqrt{a}}$$

$$= \frac{x}{4} \sqrt{x^2 + 4a} + a \operatorname{arcsinh} \frac{x}{2\sqrt{a}}$$

(see Table 19.3 for ϑ_1), then

$$19.10.2 \quad U(a, x) = \frac{(2\pi)^{1/4}}{\sqrt{\Gamma(\frac{1}{2}+a)}} \exp \{-\theta + v(a, x)\}$$

$$19.10.3 \quad U(a, -x) = \frac{(2\pi)^{1/4}}{\sqrt{\Gamma(\frac{1}{2}+a)}} \exp \{\theta + v(a, -x)\}$$

where

19.10.4

$$v(a, x) \sim -\frac{1}{2} \ln X + \sum_{s=1}^{\infty} (-1)^s d_{3s} / X^{3s} \quad (a > 0, x^2 + 4a \rightarrow +\infty)$$

and d_{3s} is given by 19.10.13.

(ii) a negative, $x^2 + 4a$ large and positive. Write

$$19.10.5 \quad X = \sqrt{x^2 - 4|a|}$$

$$\begin{aligned} \theta &= 4|a|\vartheta_2(x/2\sqrt{|a|}) = \frac{1}{2} \int_{2\sqrt{|a|}}^x X dx = \frac{1}{4} xX + a \ln \frac{x+X}{2\sqrt{|a|}} \\ &= \frac{1}{4} x\sqrt{x^2 - 4|a|} + a \operatorname{arccosh} \frac{x}{2\sqrt{|a|}} \end{aligned}$$

(see Table 19.3 for ϑ_2), then

$$19.10.6 \quad U(a, x) = \frac{\sqrt{\Gamma(\frac{1}{2}-a)}}{(2\pi)^{1/4}} \exp \{-\theta + v(a, x)\}$$

19.10.7

$$V(a, x) = \frac{2}{(2\pi)^{1/4} \sqrt{\Gamma(\frac{1}{2}-a)}} \exp \{\theta + v(a, -x)\}$$

where again

19.10.8

$$v(a, x) \sim -\frac{1}{2} \ln X + \sum_{s=1}^{\infty} (-1)^s d_{3s} / X^{3s} \quad (a < 0, x^2 + 4a \rightarrow +\infty)$$

and d_{3s} is given by 19.10.13.

(iii) a large and negative and x moderate. Write

$$19.10.9 \quad Y = \sqrt{4|a| - x^2}$$

$$\begin{aligned} \theta &= 4|a|\vartheta_4(x/2\sqrt{|a|}) \\ &= \frac{1}{2} \int_0^x Y dx = \frac{1}{4} xY + |a| \arcsin \frac{x}{2\sqrt{|a|}} \end{aligned}$$

(see Table 19.3 for $\vartheta_4 = \frac{1}{8}\pi - \vartheta_3$), then

19.10.10

$$U(a, x) = \frac{2\sqrt{\Gamma(\frac{1}{2}-a)}}{(2\pi)^{1/4}} e^{v_r} \cos \left\{ \frac{1}{4}\pi + \frac{1}{2}\pi a + \theta + v_i \right\}$$

19.10.11

$$V(a, x) = \frac{2}{(2\pi)^{1/4} \sqrt{\Gamma(\frac{1}{2}-a)}} e^{v_r} \sin \left\{ \frac{1}{4}\pi + \frac{1}{2}\pi a + \theta + v_i \right\}$$

where

$$19.10.12 \quad v_r \sim -\frac{1}{2} \ln Y - \frac{d_6}{Y^6} + \frac{d_{12}}{Y^{12}} - \dots$$

$$v_i \sim \frac{d_3}{Y^3} - \frac{d_9}{Y^9} + \dots \quad (x^2 + 4a \rightarrow -\infty)$$

In each case the coefficients d_{3r} are given by

19.10.13

$$d_3 = \frac{1}{a} \left(\frac{x^3}{48} + \frac{1}{2} ax \right)$$

$$d_6 = \frac{3}{4} x^2 - 2a$$

$$\begin{aligned} d_9 &= \frac{1}{a^3} \left(-\frac{7}{5760} x^9 - \frac{7}{320} ax^7 - \frac{49}{320} a^2 x^5 \right. \\ &\quad \left. + \frac{31}{12} a^3 x^3 - 19a^4 x \right) \end{aligned}$$

$$d_{12} = \frac{153}{8} x^4 - 186ax^2 + 80a^2$$

See [19.11] for d_{15}, \dots, d_{24} , and [19.5] for an alternative form.

19.11. Modulus and Phase

When a is negative and $|x| < 2\sqrt{|a|}$, the functions U and V are oscillatory and it is sometimes convenient to write

$$19.11.1 \quad U(a, x) + i\Gamma(\frac{1}{2}-a)V(a, x) = F(a, x)e^{i\chi(a, x)}$$

$$19.11.2 \quad U'(a, x) + i\Gamma(\frac{1}{2}-a)V'(a, x) = -G(a, x)e^{i\psi(a, x)}$$

Then, when $a < 0$ and $|a| \gg x^2$,

19.11.3

$$F = \frac{\Gamma(\frac{1}{4}-\frac{1}{2}a)}{2^{1/2} \sqrt{\pi}} e^{v_r}, \quad \chi = (\frac{1}{2}a + \frac{1}{4})\pi + px + v_i$$

where v_r, v_i are given by 19.9.5 and $p = \sqrt{-a}$.

Alternatively, with $p = \sqrt{|a|}$, and again $-a \gg x^2$,

19.11.4

$$F \sim \frac{\Gamma(\frac{1}{4}-\frac{1}{2}a)}{2^{1/2} \sqrt{\pi}} \left\{ 1 + \frac{x^2}{(4p)^2} + \frac{\frac{5}{2}x^4}{(4p)^4} + \frac{\frac{1}{2}x^6 - 144x^2}{(4p)^6} + \dots \right\}$$

$$19.11.5 \quad \chi \sim (\frac{1}{2}a + \frac{1}{4})\pi + px \left\{ 1 - \frac{\frac{2}{3}x^2}{(4p)^2} - \frac{\frac{2}{5}x^4 - 16}{(4p)^4} - \frac{\frac{4}{7}x^6 - \frac{2 \cdot 5 \cdot 6 x^2}{(4p)^6} - \dots \right\}$$

$$19.11.6 \quad G \sim \frac{\Gamma(\frac{3}{4} - \frac{1}{2}a)}{2^{\frac{1}{2}a - \frac{1}{2}} \sqrt{\pi}} \left\{ 1 - \frac{x^2}{(4p)^2} - \frac{\frac{3}{2}x^4}{(4p)^4} - \frac{\frac{7}{2}x^6 - 176x^2}{(4p)^6} - \dots \right\}$$

$$19.11.7 \quad \psi \sim (\frac{1}{2}a - \frac{1}{4})\pi + px \left\{ 1 - \frac{\frac{2}{3}x^2}{(4p)^2} - \frac{\frac{2}{5}x^4 + 16}{(4p)^4} - \frac{\frac{4}{7}x^6 + \frac{3 \cdot 2 \cdot 0 x^2}{(4p)^6} - \dots \right\}$$

Again, when $x^2 + 4a$ is large and negative, with $Y = \sqrt{4|a| - x^2}$, then

$$19.11.8 \quad F = \frac{2\sqrt{\Gamma(\frac{1}{2} - a)}}{(2\pi)^{\frac{1}{2}}} e^{v_r} \quad \chi = \frac{1}{4}\pi + \frac{1}{2}\pi a + \theta + v_i$$

where θ , v_r and v_i are given by 19.10.9 and 19.10.12.

Another form is

$$19.11.9 \quad F \sim \frac{2\sqrt{\Gamma(\frac{1}{2} - a)}}{(2\pi)^{\frac{1}{2}} \sqrt{Y}} \left(1 + \frac{3}{4Y^4} + \frac{5a}{Y^6} + \frac{621}{32Y^8} + \dots \right) \quad (x^2 + 4a \rightarrow -\infty)$$

$$19.11.10 \quad G \sim \frac{\sqrt{Y} \sqrt{\Gamma(\frac{1}{2} - a)}}{(2\pi)^{\frac{1}{2}}} \left(1 - \frac{5}{4Y^4} - \frac{7a}{Y^6} - \frac{835}{32Y^8} - \dots \right) \quad (x^2 + 4a \rightarrow -\infty)$$

while ψ and χ are connected by

$$19.11.11 \quad \psi - \chi \sim -\frac{1}{2}\pi - \frac{x}{Y^3} \left(1 + \frac{47}{6Y^4} + \frac{214a}{3Y^6} + \frac{14483}{40Y^8} + \dots \right) \quad (x^2 + 4a \rightarrow -\infty)$$

Connections With Other Functions

19.12. Connection With Confluent Hypergeometric Functions (see chapter 13)

$$19.12.1 \quad U(a, \pm x) = \frac{\sqrt{\pi} 2^{-\frac{1}{2}a} x^{-\frac{1}{2}}}{\Gamma(\frac{3}{4} + \frac{1}{2}a)} M_{-\frac{1}{2}a, -\frac{1}{2}}(\frac{1}{2}x^2) \mp \frac{\sqrt{\pi} 2^{1-\frac{1}{2}a} x^{-\frac{1}{2}}}{\Gamma(\frac{1}{4} + \frac{1}{2}a)} M_{-\frac{1}{2}a, \frac{1}{2}}(\frac{1}{2}x^2)$$

$$19.12.2 \quad U(a, x) = 2^{-\frac{1}{2}a} x^{-\frac{1}{2}} W_{-\frac{1}{2}a, -\frac{1}{2}}(\frac{1}{2}x^2)$$

19.12.3

$$U(a, \pm x) = \frac{\sqrt{\pi} 2^{-\frac{1}{2}a} e^{-\frac{1}{2}x^2}}{\Gamma(\frac{3}{4} + \frac{1}{2}a)} M(\frac{1}{2}a + \frac{1}{4}, \frac{1}{2}, \frac{1}{2}x^2) \mp \frac{\sqrt{\pi} 2^{1-\frac{1}{2}a} x e^{-\frac{1}{2}x^2}}{\Gamma(\frac{1}{4} + \frac{1}{2}a)} M(\frac{1}{2}a + \frac{3}{4}, \frac{3}{4}, \frac{1}{2}x^2)$$

19.12.4

$$U(a, x) = 2^{-\frac{1}{2}a} e^{-\frac{1}{2}x^2} U(\frac{1}{2}a + \frac{1}{4}, \frac{1}{2}, \frac{1}{2}x^2) = 2^{-\frac{1}{2}a} x e^{-\frac{1}{2}x^2} U(\frac{1}{2}a + \frac{3}{4}, \frac{3}{4}, \frac{1}{2}x^2)$$

Expressions for $V(a, x)$ may be obtained from these by use of 19.4.2.

19.13. Connection With Hermite Polynomials and Functions

When n is a non-negative integer

19.13.1

$$U(-n - \frac{1}{2}, x) = e^{-\frac{1}{2}x^2} He_n(x) = 2^{-\frac{1}{2}n} e^{-\frac{1}{2}x^2} H_n(x/\sqrt{2})$$

19.13.2

$$V(n + \frac{1}{2}, x) = \sqrt{2/\pi} e^{\frac{1}{2}x^2} He_n^*(x) = 2^{-\frac{1}{2}n} e^{\frac{1}{2}x^2} H_n^*(x/\sqrt{2})$$

in which $H_n(x)$ and $He_n(x)$ are Hermite polynomials (see chapter 22) while

$$19.13.3 \quad He_n^*(x) = e^{-\frac{1}{2}x^2} \frac{d^n}{dx^n} e^{\frac{1}{2}x^2} = (-i)^n He_n(ix)$$

$$19.13.4 \quad H_n^*(x) = e^{-x^2} \frac{d^n}{dx^n} e^{x^2} = (-i)^n H_n(ix)$$

This gives one elementary solution to 19.1.2 whenever $2a$ is an odd integer, positive or negative.

19.14. Connection With Probability Integrals and Dawson's Integral (see chapter 7)

If, as in [19.10]

$$19.14.1 \quad Hh_{-1}(x) = e^{-\frac{1}{2}x^2}$$

19.14.2

$$Hh_n(x) = \int_x^\infty Hh_{n-1}(t) dt = (1/n!) \int_x^\infty (t-x)^n e^{-\frac{1}{2}t^2} dt \quad (n \geq 0)$$

then

$$19.14.3 \quad U(n + \frac{1}{2}, x) = e^{\frac{1}{2}x^2} Hh_n(x) \quad (n \geq -1)$$

Correspondingly

$$19.14.4 \quad V\left(\frac{1}{2}, x\right) = \sqrt{2/\pi} e^{ix^2}$$

and

19.14.5

$$V\left(-n - \frac{1}{2}, x\right) = e^{-ix^2} \left\{ \int_0^x e^{-it^2} V\left(-n + \frac{1}{2}, t\right) dt - \frac{\sin \frac{1}{2}n\pi}{2^{1/2} \Gamma(\frac{1}{2}n + 1)} \right\} \quad (n \geq 0)$$

Here $V(-\frac{1}{2}, x)$ is closely related to Dawson's integral

$$\int_0^x e^{t^2} dt$$

These relations give a second solution of 19.1.2 whenever $2a$ is an odd integer, and a second solution is unobtainable from $U(a, x)$ by reflection in the y -axis.

19.15. Explicit Formula in Terms of Bessel Functions When $2a$ Is an Integer

Write

$$19.15.1 \quad I_{-n} - I_n = (2/\pi) \sin n\pi \cdot K_n$$

$$19.15.2 \quad I_{-n} + I_n = \cos n\pi \cdot J_n$$

where the argument of all modified Bessel functions is $\frac{1}{2}x^2$. Then

$$19.15.3 \quad U(1, x) = 2\pi^{-1/2} (\frac{1}{2}x)^{1/2} (-K_{1/2} + K_{3/2})$$

$$19.15.4 \quad U(2, x) = 2 \cdot \frac{2}{3} \pi^{-1/2} (\frac{1}{2}x)^{3/2} (2K_{3/2} - 3K_{5/2} + K_{7/2})$$

19.15.5

$$U(3, x) = 2 \cdot \frac{2}{3} \cdot \frac{2}{5} \pi^{-1/2} (\frac{1}{2}x)^{5/2} (-5K_{5/2} + 9K_{7/2} - 5K_{9/2} + K_{11/2})$$

$$19.15.6 \quad V(1, x) = \frac{1}{2} (\frac{1}{2}x)^{1/2} (\mathcal{J}_{1/2} - \mathcal{J}_{3/2})$$

$$19.15.7 \quad V(2, x) = \frac{1}{2} (\frac{1}{2}x)^{3/2} (2\mathcal{J}_{3/2} - 3\mathcal{J}_{5/2} + \mathcal{J}_{7/2})$$

$$19.15.8 \quad V(3, x) = \frac{1}{2} (\frac{1}{2}x)^{5/2} (5\mathcal{J}_{5/2} - 9\mathcal{J}_{7/2} + 5\mathcal{J}_{9/2} - \mathcal{J}_{11/2})$$

$$19.15.9 \quad U(0, x) = \pi^{-1/2} (\frac{1}{2}x)^{1/2} K_{1/2}$$

$$19.15.10 \quad U(-1, x) = \pi^{-1/2} (\frac{1}{2}x)^{1/2} (K_{1/2} + K_{3/2})$$

19.15.11

$$\dot{U}(-2, x) = \pi^{-1/2} (\frac{1}{2}x)^{3/2} (2K_{3/2} + 3K_{5/2} - K_{7/2})$$

19.15.12

$$U(-3, x) = \pi^{-1/2} (\frac{1}{2}x)^{5/2} (5K_{5/2} + 9K_{7/2} - 5K_{9/2} - K_{11/2})$$

$$19.15.13 \quad V(0, x) = \frac{1}{2} (\frac{1}{2}x)^{1/2} \mathcal{J}_{1/2}$$

$$19.15.14 \quad V(-1, x) = (\frac{1}{2}x)^{3/2} (\mathcal{J}_{1/2} + \mathcal{J}_{3/2})$$

$$19.15.15 \quad V(-2, x) = \frac{2}{3} (\frac{1}{2}x)^{5/2} (2\mathcal{J}_{3/2} + 3\mathcal{J}_{5/2} - \mathcal{J}_{7/2})$$

19.15.16

$$V(-3, x) = \frac{2}{3} \cdot \frac{2}{5} (\frac{1}{2}x)^{7/2} (5\mathcal{J}_{5/2} + 9\mathcal{J}_{7/2} - 5\mathcal{J}_{9/2} - \mathcal{J}_{11/2})$$

$$19.15.17 \quad U(-\frac{1}{2}, x) = \sqrt{2/\pi} (\frac{1}{2}x) K_{1/2}$$

$$19.15.18 \quad U(-\frac{3}{2}, x) = \sqrt{2/\pi} (\frac{1}{2}x)^2 2K_{3/2}$$

$$19.15.19 \quad U(-\frac{5}{2}, x) = \sqrt{2/\pi} (\frac{1}{2}x)^3 (5K_{5/2} - K_{7/2})$$

$$19.15.20 \quad V(\frac{1}{2}, x) = (\frac{1}{2}x) (I_{1/2} + I_{-1/2})$$

$$19.15.21 \quad V(\frac{3}{2}, x) = (\frac{1}{2}x)^2 (2I_{3/2} + 2I_{-3/2})$$

$$19.15.22 \quad V(\frac{5}{2}, x) = (\frac{1}{2}x)^3 (5I_{5/2} + 5I_{-5/2} - I_{-3/2} - I_{-1/2})$$

The Equation $\frac{d^2y}{dx^2} + \left(\frac{1}{4}x^2 - a\right)y = 0$

19.16. Power Series in x

Even and odd solutions are given by 19.2.1 to 19.2.4 with $-ia$ written for a and $xe^{i\pi}$ for x ; the series involves complex quantities in which the imaginary part of the sum vanishes identically.

Alternatively,

19.16.1

$$y_1 = 1 + a \frac{x^2}{2!} + (a^2 - \frac{1}{2}) \frac{x^4}{4!} + (a^3 - \frac{7}{2}a) \frac{x^6}{6!} + (a^4 - 11a^2 + \frac{15}{4}) \frac{x^8}{8!} + (a^5 - 25a^3 + \frac{21}{4}a) \frac{x^{10}}{10!} + \dots$$

19.16.2

$$y_2 = x + a \frac{x^3}{3!} + (a^2 - \frac{3}{2}) \frac{x^5}{5!} + (a^3 - \frac{1}{2}a) \frac{x^7}{7!} + (a^4 - 17a^2 + \frac{9}{4}) \frac{x^9}{9!} + (a^5 - 35a^3 + \frac{53}{4}a) \frac{x^{11}}{11!} + \dots$$

in which non-zero coefficients a_n of $x^n/n!$ are connected by

$$19.16.3 \quad a_{n+2} = a \cdot a_n - \frac{1}{4}n(n-1)a_{n-2}$$

19.17. Standard Solutions (see [19.4])

$$19.17.1 \quad W(a, \pm x) = \frac{(\cosh \pi a)^{1/2}}{2\sqrt{\pi}} (G_1 y_1 \mp \sqrt{2} G_3 y_2)$$

$$19.17.2 \quad = 2^{-3/4} \left(\sqrt{\frac{G_1}{G_3}} y_1 \mp \sqrt{\frac{2G_3}{G_1}} y_2 \right)$$

where

$$19.17.3 \quad G_1 = |\Gamma(\frac{1}{4} + \frac{1}{2}ia)| \quad G_3 = |\Gamma(\frac{3}{4} + \frac{1}{2}ia)|$$

At $x=0$,

19.17.4 $W(a, 0) = \frac{1}{2^{\frac{1}{2}} i} \left| \frac{\Gamma(\frac{1}{4} + \frac{1}{2}ia)}{\Gamma(\frac{3}{4} + \frac{1}{2}ia)} \right|^{\frac{1}{2}} = \frac{1}{2^{\frac{1}{2}} i} \sqrt{\frac{G_1}{G_3}}$

19.17.5

$$W'(a, 0) = -\frac{1}{2^{\frac{1}{2}} i} \left| \frac{\Gamma(\frac{3}{4} + \frac{1}{2}ia)}{\Gamma(\frac{1}{4} + \frac{1}{2}ia)} \right|^{\frac{1}{2}} = -\frac{1}{2^{\frac{1}{2}} i} \sqrt{\frac{G_3}{G_1}}$$

Complex Solutions

19.17.6 $E(a, x) = k^{-1}W(a, x) + ik^{\frac{1}{2}}W(a, -x)$

19.17.7 $E^*(a, x) = k^{-1}W(a, x) - ik^{\frac{1}{2}}W(a, -x)$

where

19.17.8 $k = \sqrt{1 + e^{2\pi a}} - e^{\pi a} \quad 1/k = \sqrt{1 + e^{2\pi a}} + e^{\pi a}$

In terms of $U(a, x)$ of 19.3,

19.17.9 $E(a, x) = \sqrt{2}e^{i\pi a + \frac{1}{2}i\pi} U(ia, xe^{-i\pi})$

with

19.17.10 $\phi_2 = \arg \Gamma(\frac{1}{2} + ia)$

where the branch is defined by $\phi_2=0$ when $a=0$ and by continuity elsewhere.

Also

19.17.11

$$\sqrt{2\pi}U(ia, xe^{-i\pi}) = \Gamma(\frac{1}{2} - ia) \{ e^{i\pi a - \frac{1}{2}i\pi} U(-ia, xe^{i\pi}) + e^{-i\pi a + \frac{1}{2}i\pi} U(-ia, -xe^{i\pi}) \}$$

19.18. Wronskian and Other Relations

19.18.1 $W\{W(a, x), W(a, -x)\} = 1$

19.18.2 $W\{E(a, x), E^*(a, x)\} = -2i$

19.18.3 $\sqrt{1 + e^{2\pi a}}E(a, x) = e^{\pi a}E^*(a, x) + iE^*(a, -x)$

19.18.4 $E^*(a, x) = e^{-i(\phi_2 + \frac{1}{2}\pi)}E(-a, ix)$

19.18.5

$$\sqrt{\Gamma(\frac{1}{2} + ia)}E^*(a, x) = e^{-i\pi} \sqrt{\Gamma(\frac{1}{2} - ia)}E(-a, ix)$$

19.19. Integral Representations

These are covered for 19.1.3 as well as for 19.1.2 in 19.5 (general complex argument).

Asymptotic Expansions

19.20. Expressions in Terms of Airy Functions

When a is large and positive, write, for $0 \leq x < \infty$

$$x = 2\sqrt{a}\xi \quad t = (4a)^{\frac{1}{3}}\tau$$

19.20.1

$$\tau = -(\frac{3}{2}\vartheta_3)^{\frac{2}{3}}$$

$$\vartheta_3 = \frac{1}{2} \int_{\xi}^1 \sqrt{1-s^2} ds = \frac{1}{4} \arccos \xi - \frac{1}{4}\xi \sqrt{1-\xi^2} \quad (\xi \leq 1)$$

19.20.2

$$\tau = +(\frac{3}{2}\vartheta_2)^{\frac{2}{3}}$$

$$\vartheta_2 = \frac{1}{2} \int_1^{\xi} \sqrt{s^2-1} ds = \frac{1}{4}\xi \sqrt{\xi^2-1} - \frac{1}{4} \operatorname{arccosh} \xi \quad (\xi \geq 1)$$

Then for $x > 0$, $a \rightarrow +\infty$

19.20.3

$$W(a, x) \sim \sqrt{\pi}(4a)^{-\frac{1}{2}} e^{-\frac{1}{2}\pi a} \left(\frac{t}{\xi^2-1}\right)^{\frac{1}{2}} \operatorname{Bi}(-t)$$

19.20.4

$$W(a, -x) \sim 2\sqrt{\pi}(4a)^{-\frac{1}{2}} e^{\frac{1}{2}\pi a} \left(\frac{t}{\xi^2-1}\right)^{\frac{1}{2}} \operatorname{Ai}(-t)$$

Table 19.3 gives τ as a function of ξ . See [19.5] for further developments.

19.21. Expansions for x Large and a Moderate

When $x \gg |a|$,

19.21.1

$$E(a, x) = \sqrt{2/x} \exp \{ i(\frac{1}{4}x^2 - a \ln x + \frac{1}{2}\phi_2 + \frac{1}{4}\pi) \} s(a, x)$$

19.21.2

$$W(a, x) = \sqrt{2k/x} \{ s_1(a, x) \cos(\frac{1}{4}x^2 - a \ln x + \frac{1}{4}\pi + \frac{1}{2}\phi_2) - s_2(a, x) \sin(\frac{1}{4}x^2 - a \ln x + \frac{1}{4}\pi + \frac{1}{2}\phi_2) \}$$

19.21.3

$$W(a, -x) = \sqrt{2/kx} \{ s_1(a, x) \sin(\frac{1}{4}x^2 - a \ln x + \frac{1}{4}\pi + \frac{1}{2}\phi_2) + s_2(a, x) \cos(\frac{1}{4}x^2 - a \ln x + \frac{1}{4}\pi + \frac{1}{2}\phi_2) \}$$

where ϕ_2 is defined by 19.17.10 and

19.21.4 $s(a, x) = s_1(a, x) + is_2(a, x)$

19.21.5

$$s_1(a, x) \sim 1 + \frac{v_2}{1!2x^2} - \frac{u_4}{2!2^2x^4} - \frac{v_6}{3!2^3x^6} + \frac{u_8}{4!2^4x^8} + \dots$$

19.21.6

$$s_2(a, x) \sim -\frac{u_2}{1!2x^2} - \frac{v_4}{2!2^2x^4} + \frac{u_6}{3!2^3x^6} + \frac{v_8}{4!2^4x^8} + \dots$$

with

$$(x \rightarrow +\infty)$$

$$19.21.7 \quad u_r + iv_r = \Gamma(r + \frac{1}{2} + ia) / \Gamma(\frac{1}{2} + ia)$$

or

$$19.21.8 \quad s(a, x) \sim \sum_{r=0}^{\infty} (-i)^r \frac{\Gamma(2r + \frac{1}{2} + ia)}{\Gamma(\frac{1}{2} + ia)} \frac{1}{2^r r! x^{2r}}$$

19.22. Expansions for a Large With x Moderate

(i) a positiveWhen $a \gg x^2$, with $p = \sqrt{a}$, then

$$19.22.1 \quad W(a, x) = W(a, 0) \exp(-px + v_1)$$

$$19.22.2 \quad W(a, -x) = W(a, 0) \exp(px + v_2)$$

where $W(a, 0)$ is given by 19.17.4, and

19.22.3

$$v_1, v_2 \sim \pm \frac{\frac{2}{3}(\frac{1}{2}x)^3}{2p} + \frac{(\frac{1}{2}x)^2}{(2p)^2} \pm \frac{\frac{1}{2}x + \frac{2}{3}(\frac{1}{2}x)^5}{(2p)^3} \\ + \frac{2(\frac{1}{2}x)^4}{(2p)^4} \pm \frac{\frac{1}{8}(\frac{1}{2}x)^3 + \frac{4}{7}(\frac{1}{2}x)^7}{(2p)^5} + \dots \\ (a \rightarrow +\infty)$$

The upper sign gives the first function, and the lower sign the second function.

(ii) a negativeWhen $-a \gg x^2$, with $p = \sqrt{-a}$, then

19.22.4

$$W(a, x) + iW(a, -x) \\ = \sqrt{2}W(a, 0) \exp\{v_r + i(px + \frac{1}{4}\pi + v_i)\}$$

where $W(a, 0)$ is given by 19.17.4, and

19.22.5

$$v_r \sim -\frac{(\frac{1}{2}x)^2}{(2p)^2} + \frac{2(\frac{1}{2}x)^4}{(2p)^4} - \frac{9(\frac{1}{2}x)^2 + \frac{1}{3}(\frac{1}{2}x)^6}{(2p)^6} + \dots \\ v_i \sim \frac{\frac{2}{3}(\frac{1}{2}x)^3}{2p} - \frac{\frac{1}{2}x + \frac{2}{3}(\frac{1}{2}x)^5}{(2p)^3} + \frac{\frac{1}{8}(\frac{1}{2}x)^3 + \frac{4}{7}(\frac{1}{2}x)^7}{(2p)^5} - \dots \\ (a \rightarrow -\infty)$$

Further expansions of a similar type will be found in [19.3].

19.23. Darwin's Expansions

(i) a positive, $x^2 - 4a \gg 0$

Write

19.23.1

$$X = \sqrt{x^2 - 4a} \quad \theta = 4a\vartheta_2(x/2\sqrt{a}) = \frac{1}{2} \int_{2\sqrt{a}}^x X dx \\ = \frac{1}{2} xX - a \ln \frac{x+X}{2\sqrt{a}} \\ = \frac{1}{2} x\sqrt{x^2 - 4a} - a \operatorname{arccosh} \frac{x}{2\sqrt{a}}$$

(see Table 19.3 for ϑ_2), then

$$19.23.2 \quad W(a, x) = \sqrt{2ke^{\theta}} \cos(\frac{1}{4}\pi + \theta + v_i)$$

$$19.23.3 \quad W(a, -x) = \sqrt{2/ke^{\theta}} \sin(\frac{1}{4}\pi + \theta + v_i)$$

where

$$19.23.4 \quad v_r \sim -\frac{1}{2} \ln X - \frac{d_6}{X^6} + \frac{d_{12}}{X^{12}} - \dots$$

$$v_i \sim -\frac{d_3}{X^3} + \frac{d_9}{X^9} - \frac{d_{15}}{X^{15}} + \dots$$

 $(x^2 - 4a \rightarrow \infty)$ and d_3 , is given by 19.23.12.(ii) a positive, $4a - x^2 \gg 0$

Write

19.23.5

$$Y = \sqrt{4a - x^2} \quad \theta = 4a\vartheta_4(x/2\sqrt{a}) \\ = \frac{1}{2} \int_0^x Y dx = \frac{1}{2} xY + a \arcsin \frac{x}{2\sqrt{a}}$$

(see Table 19.3 for $\vartheta_4 = \frac{1}{3}\pi - \vartheta_3$), then

$$19.23.6 \quad W(a, x) = \exp\{-\theta + v(a, x)\}$$

$$19.23.7 \quad W(a, -x) = \exp\{\theta + v(a, -x)\}$$

where

19.23.8

$$v(a, x) \sim -\frac{1}{2} \ln Y + \frac{d_3}{Y^3} + \frac{d_6}{Y^6} + \frac{d_9}{Y^9} + \dots \\ (x^2 - 4a \rightarrow -\infty)$$

and d_3 , is again given by 19.23.12.(iii) a negative, $x^2 - 4a \gg 0$

Write

19.23.9

$$X = \sqrt{x^2 + 4|a|} \quad \theta = 4|a|\vartheta_1(x/2\sqrt{|a|}) = \frac{1}{2} \int_0^x X dx \\ = \frac{1}{2} xX - a \ln \frac{x+X}{2\sqrt{|a|}} \\ = \frac{1}{2} x\sqrt{x^2 + 4|a|} - a \operatorname{arcsinh} \frac{x}{2\sqrt{|a|}}$$

(see Table 19.3 for ϑ_1) then

$$19.23.10 \quad W(a, x) = \sqrt{2ke^{\theta}} \cos(\frac{1}{4}\pi + \theta + v_i)$$

$$19.23.11 \quad W(a, -x) = \sqrt{2/ke^{\theta}} \sin(\frac{1}{4}\pi + \theta + v_i)$$

where v_r and v_i are again given by 19.23.4. In each case the coefficients d_3 , are given by

19.23.12

$$d_3 = -\frac{1}{a} \left(\frac{x^3}{48} - \frac{1}{2}ax \right)$$

$$d_6 = \frac{3}{4}x^2 + 2a$$

$$d_9 = \frac{1}{a^3} \left(\frac{7}{5760}x^9 - \frac{7}{320}ax^7 + \frac{49}{320}a^2x^5 + \frac{31}{12}a^3x^3 + 19a^4x \right)$$

$$d_{12} = \frac{153}{8}x^4 + 186ax^2 + 80a^2$$

See [19.11] for d_{15}, \dots, d_{24} , and [19.5] for an alternative form.

19.24. Modulus and Phase

When a is positive, the function $W(a, x)$ is oscillatory when $x < -2\sqrt{a}$ and when $x > 2\sqrt{a}$; when a is negative, the function is oscillatory for all x . In such cases it is sometimes convenient to write

19.24.1

$$k^{-1}W(a, x) + ik^1W(a, -x) = E(a, x) = Fe^{ix} \quad (x > 0)$$

19.24.2

$$k^{-1} \frac{dW(a, x)}{dx} + ik^1 \frac{dW(a, -x)}{dx} = E'(a, x) = -Ge^{i\psi} \quad (x > 0)$$

Then, when $x^2 \gg |a|$,

19.24.3

$$F \sim \sqrt{\frac{2}{x}} \left(1 + \frac{a}{x^2} + \frac{10a^2 - 3}{4x^4} + \frac{30a^3 - 47a}{4x^6} + \dots \right)$$

19.24.4

$$\chi \sim \frac{1}{4}x^2 - a \ln x + \frac{1}{2}\phi_2 + \frac{1}{4}\pi + \frac{4a^2 - 3}{8x^2} + \frac{4a^3 - 19a}{8x^4} + \dots$$

19.24.5

$$G \sim \sqrt{\frac{x}{2}} \left(1 - \frac{a}{x^2} - \frac{6a^2 - 5}{4x^4} - \frac{14a^3 - 63a}{4x^6} - \dots \right)$$

19.24.6

$$\psi \sim \frac{1}{4}x^2 - a \ln x + \frac{1}{2}\phi_2 - \frac{1}{4}\pi + \frac{4a^2 + 5}{8x^2} + \frac{4a^3 + 29a}{8x^4} + \dots$$

where ϕ_2 is defined by 19.17.10.

When $a < 0$, $|a| \gg x^2$

19.24.7

$$F \sim \sqrt{2}W(a, 0)e^{v_i}$$

where v_i is given by 19.22.5 with $p = \sqrt{-a}$. Also

19.24.8

$$F \sim \frac{1}{\sqrt{p}} \left(1 - \frac{x^2}{(4p)^2} + \frac{\frac{5}{2}x^4 + 8}{(4p)^4} - \frac{\frac{1}{2}x^6 + 152x^2}{(4p)^6} + \dots \right)$$

19.24.9

$$\chi \sim \frac{1}{4}\pi + px \left(1 + \frac{\frac{2}{3}x^2}{(4p)^2} - \frac{\frac{2}{3}x^4 + 16}{(4p)^4} + \frac{\frac{1}{7}x^6 + \frac{256}{3}x^2}{(4p)^6} - \dots \right)$$

19.24.10

$$G \sim \sqrt{p} \left(1 + \frac{x^2}{(4p)^2} - \frac{\frac{3}{2}x^4 + 8}{(4p)^4} + \frac{\frac{1}{2}x^6 + 168x^2}{(4p)^6} - \dots \right)$$

19.24.11

$$\psi \sim -\frac{1}{4}\pi + px \left(1 + \frac{\frac{2}{3}x^2}{(4p)^2} - \frac{\frac{2}{5}x^4 - 16}{(4p)^4} + \frac{\frac{1}{7}x^6 - \frac{320}{3}x^2}{(4p)^6} - \dots \right)$$

Again, when $a < 0$, $x^2 - 4a \gg 0$, with $X = \sqrt{x^2 + 4|a|}$, then

19.24.12

$$F \sim \sqrt{2}e^{v_i}, \quad \chi = \frac{1}{4}\pi + \theta + v_i$$

where θ , v , and v_i are given by 19.23.4 and 19.23.9.

Another form also when $a > 0$, $x^2 - 4a \rightarrow \infty$ is

19.24.13

$$F \sim \sqrt{\frac{2}{X}} \left(1 - \frac{3}{4X^4} - \frac{5a}{X^6} + \frac{621}{32X^8} + \frac{1371a}{4X^{10}} - \dots \right)$$

19.24.14

$$G \sim \sqrt{\frac{X}{2}} \left(1 + \frac{5}{4X^4} + \frac{7a}{X^6} - \frac{835}{32X^8} - \frac{1729a}{4X^{10}} + \dots \right)$$

while ψ and χ are connected by

19.24.15

$$\psi - \chi \sim -\frac{1}{2}\pi + \frac{x}{X^3} \left(1 - \frac{47}{6X^4} - \frac{214a}{3X^6} + \frac{14483}{40X^8} + \dots \right)$$

19.25. Connections With Other Functions

Connection With Confluent Hypergeometric and Bessel Functions

19.25.1

$$W(a, \pm x) = 2^{-\frac{1}{2}} \left\{ \sqrt{\frac{G_1}{G_3}} H\left(-\frac{3}{4}, \frac{1}{2}a, \frac{1}{4}x^2\right) \pm \sqrt{\frac{2G_3}{G_1}} xH\left(-\frac{1}{4}, \frac{1}{2}a, \frac{1}{4}x^2\right) \right\}$$

where

19.25.2

$$H(m, n, x) = e^{-ix} {}_1F_1(m+1-in; 2m+2; 2ix)$$

19.25.3

$$= e^{-ix} M(m+1-in, 2m+2, 2ix)$$

19.25.4

$$W(0, \pm x) = 2^{-\frac{1}{2}} \sqrt{\pi x} \{ J_{-\frac{1}{2}}(\frac{1}{2}x^2) \pm J_{\frac{1}{2}}(\frac{1}{2}x^2) \} \quad (x \geq 0)$$

19.25.5

$$\frac{d}{dx} W(0, \pm x) = -2^{-\frac{1}{2}} x \sqrt{\pi x} \{ J_{\frac{1}{2}}(\frac{1}{2}x^2) \pm J_{-\frac{1}{2}}(\frac{1}{2}x^2) \} \quad (x \geq 0)$$

19.26. Zeros

Zeros of solutions $U(a, x)$, $V(a, x)$ of 19.1.2 occur only for $|x| < 2\sqrt{-a}$ when a is negative. A single exceptional zero is possible, for any a , in the general solution; neither $U(a, x)$ nor $V(a, x)$ has such a zero for $x > 0$.

Approximations may be obtained by reverting the series for ψ (or χ for zeros of derivatives) in 19.11, giving ψ (or χ) values that are multiples of $\frac{1}{2}\pi$, odd multiples for $U(a, x)$, even multiples for $V(a, x)$. Writing

$$\alpha = (\frac{1}{2}r - \frac{1}{2}a - \frac{1}{2})\pi$$

as an approximation to a zero of the function, or

$$\beta = (\frac{1}{2}r - \frac{1}{2}a + \frac{1}{2})\pi$$

as an approximation to a zero of the derivative, we obtain for the corresponding zero c or c' , with $-a = p^2$ the expressions

$$19.26.1 \quad c \approx \frac{\alpha}{p} + \frac{2\alpha^3 - 3\alpha}{48p^5} + \frac{52\alpha^5 - 240\alpha^3 + 315\alpha}{7680p^9} + \dots$$

$$19.26.2 \quad c' \approx \frac{\beta}{p} + \frac{2\beta^3 + 3\beta}{48p^5} + \frac{52\beta^5 + 280\beta^3 - 285\beta}{7680p^9} + \dots$$

These expansions, however, are of little value in the neighborhood of the turning point $x = 2\sqrt{-a}$. Here first approximations may be obtained by use of the formulas of 19.7. If a_n (negative) is a zero of $\text{Ai}(t)$, the corresponding zero c of $U(a, x)$ is obtained approximately by solving

19.26.3

$$\vartheta_3 = \frac{1}{4} \{ \arccos \xi - \xi \sqrt{1 - \xi^2} \} = \frac{(-a_n)^{\frac{3}{2}}}{6|a|} \quad c = 2\sqrt{|a|}\xi \quad (a \ll 0)$$

This may be done by inverse use of Table 19.3. For a zero of $V(a, x)$, a_n must be replaced by b_n , a zero of $\text{Bi}(t)$. For further developments see [19.5].

Zeros of solutions $W(a, x)$, $W(a, -x)$ of 19.1.3 occur for $|x| > 2\sqrt{a}$ when a is positive; the general solution may, however, have a single zero between $-2\sqrt{a}$ and $+2\sqrt{a}$. If a is negative, zeros are unrestricted in range.

Approximations may be obtained by reverting the series for ψ (or χ) in 19.24. With $-a = p^2$, $\alpha = (\frac{1}{2}r - \frac{1}{2})\pi$, $\beta = (\frac{1}{2}r + \frac{1}{2})\pi$, $r \geq 0$ being an odd

integer for $W(a, x)$ or its derivative, or an even integer for $W(a, -x)$ or its derivative, the zeros $\pm c$, $\pm c'$ have expansions

$$19.26.4 \quad c \approx \frac{\alpha}{p} - \frac{2\alpha^3 - 3\alpha}{48p^5} + \frac{52\alpha^5 - 240\alpha^3 + 315\alpha}{7680p^9} + \dots$$

$$19.26.5 \quad c' \approx \frac{\beta}{p} - \frac{2\beta^3 + 3\beta}{48p^5} + \frac{52\beta^5 + 280\beta^3 - 285\beta}{7680p^9} + \dots$$

When x is large and a moderate, we may solve inversely the series 19.24.4 or 19.24.6 with $\alpha = \frac{1}{2}(r\pi - \frac{1}{2}\pi - \phi_2)$, $\beta = \frac{1}{2}(r\pi + \frac{1}{2}\pi - \phi_2)$, r odd or even as above; the presence of the logarithm makes it inconvenient to revert formally.

The expansions 19.26.4 and 19.26.5 fail when x is in the neighborhood of $2\sqrt{|a|}$. When a is positive, a zero c of $W(a, -x)$ is obtained approximately by solving

19.26.6

$$\vartheta_2 = \frac{1}{4} \{ \xi \sqrt{\xi^2 - 1} - \text{arccosh } \xi \} = \frac{(-a_n)^{\frac{3}{2}}}{6a} \quad c = 2\sqrt{a}\xi \quad (a \gg 0)$$

with the aid of Table 19.3. For a zero of $W(a, x)$ we replace a_n by b_n . When a is negative we solve, again with the aid of Table 19.3,

19.26.7

$$\vartheta_1 = \frac{1}{4} \{ \xi \sqrt{\xi^2 + 1} + \text{arcsinh } \xi \} = \frac{(n - \frac{1}{2})\pi}{4|a|} \quad c = 2\sqrt{|a|}\xi \quad (-a \gg 0)$$

where $n = 1, 2, 3, \dots$ for an approximate zero of $W(a, -x)$, and $n = \frac{1}{2}, \frac{3}{2}, \frac{5}{2}, \dots$ for an approximate zero of $W(a, x)$. Further developments are given in [19.5].

Any of the approximations to zeros obtained above may readily be improved as follows:

Let c be a zero of y , and c' a zero of y' , where y is a solution of

$$19.26.8 \quad y'' - Iy = 0$$

Here $I = a \pm \frac{1}{2}x^2$, $I' = \pm \frac{1}{2}x$, $I'' = \pm \frac{1}{2}$; the method is general and the following formulae may be used whenever $I''' = 0$. Then if γ, γ' are approximations to the zeros c, c' and

$$19.26.9 \quad u = y(\gamma)/y'(\gamma) \quad v = y'(\gamma')/I^2y(\gamma')$$

with $I \equiv I(\gamma)$ or $I \equiv I(\gamma')$ respectively, then

19.26.10

$$c \sim \gamma - u - \frac{1}{8} I u^3 + \frac{1}{12} I' u^4 - (\frac{1}{80} I'' + \frac{1}{8} I^2) u^5 + \frac{1}{80} I I' u^6 + \dots$$

19.26.11

$$y'(c) \sim y'(\gamma) \{ 1 - \frac{1}{2} I u^2 + \frac{1}{8} I' u^3 - (\frac{1}{24} I'' + \frac{1}{8} I^2) u^4 + \frac{7}{80} I I' u^5 + \dots \}$$

19.26.12

$$c' \sim \gamma' - I v - \frac{1}{2} I I' v^2 + (\frac{1}{8} I^2 I'' - \frac{1}{2} I I'^2 - \frac{1}{8} I^4) v^3 + (\frac{5}{12} I^2 I' I'' - \frac{5}{8} I I'^3 - \frac{5}{12} I^4 I') v^4 + \dots$$

19.26.13

$$y(c') \sim y(\gamma') \{ 1 - \frac{1}{2} I^3 v^2 - \frac{1}{8} I^3 I' v^3 - (\frac{1}{8} I^3 I'^2 - \frac{1}{24} I^4 I'' + \frac{1}{8} I^6) v^4 + \dots \}$$

The process can be repeated, if necessary, using as many terms at any stage as seems convenient.

Note the relations, holding at zeros,

19.26.14 $U'(a, c) = -\sqrt{2/\pi} V(a, c)$

19.26.15 $V'(a, c') = \sqrt{2/\pi} U(a, c')$

19.26.16 $W'(a, c) = -1/W(a, -c)$

19.26.17

$$W(a, c') = 1 / \left\{ \frac{d}{dx} W(a, -x) \right\}_{x=c'} = -1/W'(a, -c')$$

19.27. Bessel Functions of Order $\pm \frac{1}{4}, \pm \frac{3}{4}$ as Parabolic Cylinder Functions

Most applications of these functions refer to cases where parabolic cylinder functions would be more appropriate. We have

19.27.1 $J_{\pm \frac{1}{4}}(\frac{1}{4}x^2) = \frac{2^{\frac{1}{2}}}{\sqrt{\pi x}} \{ W(0, -x) \mp W(0, x) \}$

19.27.2 $J_{\pm \frac{3}{4}}(\frac{1}{4}x^2) = \frac{-2^{\frac{3}{2}}}{x\sqrt{\pi x}} \{ W(0, x) \pm W(0, -x) \}$

Functions of other orders may be obtained by use of the recurrence relation 10.1.22, which here becomes

19.27.3 $\frac{1}{4}x^2 J_{\nu+1}(\frac{1}{4}x^2) - 2\nu J_{\nu}(\frac{1}{4}x^2) + \frac{1}{4}x^2 J_{\nu-1}(\frac{1}{4}x^2) = 0$

Again

19.27.4 $I_{-\frac{1}{4}}(\frac{1}{4}x^2) + I_{\frac{1}{4}}(\frac{1}{4}x^2) = \frac{2}{\sqrt{x}} V(0, x)$

19.27.5

$$\frac{\sqrt{2}}{\pi} K_{\frac{1}{4}}(\frac{1}{4}x^2) = I_{-\frac{1}{4}}(\frac{1}{4}x^2) - I_{\frac{1}{4}}(\frac{1}{4}x^2) = \frac{2}{\sqrt{\pi x}} U(0, x)$$

19.27.6 $I_{-\frac{3}{4}}(\frac{1}{4}x^2) + I_{\frac{3}{4}}(\frac{1}{4}x^2) = -\frac{4}{x\sqrt{x}} \frac{d}{dx} V(0, x)$

19.27.7

$$\frac{\sqrt{2}}{\pi} K_{\frac{3}{4}}(\frac{1}{4}x^2) = I_{-\frac{3}{4}}(\frac{1}{4}x^2) - I_{\frac{3}{4}}(\frac{1}{4}x^2) = -\frac{4}{x\sqrt{\pi x}} \frac{d}{dx} U(0, x)$$

As before, Bessel functions of other orders may be obtained by use of the recurrence relation 10.2.23, which here becomes

19.27.8 $\frac{1}{4}x^2 I_{\nu+1}(\frac{1}{4}x^2) + 2\nu I_{\nu}(\frac{1}{4}x^2) - \frac{1}{4}x^2 I_{\nu-1}(\frac{1}{4}x^2) = 0$

19.27.9 $\frac{1}{4}x^2 K_{\nu+1}(\frac{1}{4}x^2) - 2\nu K_{\nu}(\frac{1}{4}x^2) - \frac{1}{4}x^2 K_{\nu-1}(\frac{1}{4}x^2) = 0$

Numerical Methods

19.28. Use and Extension of the Tables

For $U(a, x), V(a, x)$ and $W(a, x)$, interpolation x -wise may be carried out to 5-figure accuracy almost everywhere by using 5-point or 6-point Lagrangian interpolation. For $|a| \leq 1$, comparable accuracy a -wise may be obtained with 5- or 6-point interpolation.

For $|a| > 1$, $U(a, x)$ and $V(a, x)$ may be obtained by use of recurrence relations from two values, possibly obtained by interpolation, with $|a| \leq 1$; such a procedure is not available for $W(a, \pm x)$, $|a| > 1$.

In cases where straightforward use of the a -wise recurrence relation results in loss of accuracy by cancellation of leading digits, it may be worth while to remark that greater accuracy is usually attainable by use of the recurrence relation in the

reverse direction, from arbitrary starting values (often 1 and 0) for two values of a somewhat beyond the last value desired. This is because the recurrence relation is a second order homogeneous linear difference equation, and has two independent solutions. Loss of accuracy by cancellation occurs when the solution desired is diminishing as a varies, while the companion solution is increasing. By reversing the direction of progress in a , the roles of the two solutions are interchanged, and the contribution of the desired solution now increases, while the unwanted solution diminishes to the point of negligibility. By starting sufficiently beyond the last value of a for which the function is desired, we can ensure that the unwanted solution is negligible but, because the starting values were arbitrary, we have an un-

known multiple of the solution desired. The computation is then carried back until a value of a with $|a| \leq 1$ is reached, when the precise multiple that we have of the desired solution may be determined and hence removed throughout. Compare also 9.12, Example 1.

Example 1. Evaluate $U(a, 5)$ for $a=5, 6, 7, \dots$, using 19.6.4.

$$(a + \frac{1}{2})U(a + 1, x) + xU(a, x) - U(a - 1, x) = 0$$

a	Forward Recurrence	Backward Recurrence	Final Values
3	(-6) 5.2847*	(12) 1.59035	(-6) 5.2847**
4	(-7) 9.172*	(11) 2.76028	(-7) 9.1724
5	(-7) 1.5527	(10) 4.67131	(-7) 1.55227
6	(-8) 2.5609	(9) 7.72041	(-8) 2.5655
7	(-9) 4.1885	(9) 1.24785	(-9) 4.1466
8	(-10) 6.2220	(8) 1.97488	(-10) 6.5625
9	(-10) + 1.2676	(7) 3.06369	(-10) 1.01806
10	(-11) - 0.1221	(6) 4.66352	(-11) 1.5497
11	(-11) + 1.2654	(0) 697082	(-12) 2.3164
12	(-12) - 5.6079	102444	(-13) 3.404
13	(-12) + 3.2555	14789	(-14) 4.91
14		2111	(-15) 7.01
15		292	(-16) 9.7
16		42	
17		5	
18		1+	
19		0+	

*From tables. +Starting values.

**This value was used to obtain the constant multiplier $d \frac{(-6)5.2847}{k^*} = (-18)3.32298$ for converting the previous column into this one.

The second column shows forward recurrence starting with values at $a=3, 4$ from Table 19.1. Backward recurrence starts with values 0 and 1 at $a=19$ and 18, containing a multiple $kU(a, 5)$ and a subsequently negligible multiple of the other solution $\Gamma(\frac{1}{2}-a)V(a, 5)$. Rounding errors convert $kU(a, x)$ into $k^*U(a, x)$ without affecting the values in the last column. The value of $1/k^*$ is identified from the known value of $U(3, 5)$, and used to obtain the final column by multiplying throughout by $1/k^*$. The improvement in $U(5, 5)$ is evident by comparison with Table 19.1.

Derivatives. These are not tabulated here. Since the functions $U(a, x)$, $V(a, x)$ and $W(a, x)$ satisfy differential equations, values of derivatives are often required.

For all these functions the equation is second order with first derivative absent, so that *second derivatives* may be readily obtained from function values by use of the differential equation.

First derivatives can be obtained for $U(a, x)$ and $V(a, x)$ by applying the appropriate recurrence

relations 19.6.1-2. If less accuracy is needed they can be found by use of mean central differences of $U(a, x)$, $V(a, x)$ and also of $W(a, x)$ with the formula

$$hu' = h \frac{du}{dx} = \mu\delta u - \frac{1}{6}\mu\delta^3 u + \frac{1}{30}\mu\delta^5 u - \dots$$

using $h=.1$; this usually gives a 3- or 4-figure value of du/dx .

If greater accuracy is needed for $dW(a, x)/dx$ it may be obtained by evaluating d^2W/dx^2 with the help of the differential equation satisfied by W and integrating this second derivative numerically. This requires one accurate value of dW/dx to start off the integration; we describe two methods for obtaining this, both making use of the difference between two fairly widely separated values of W , for example, separated by 5 or 10 tabular intervals.

(i) Write f_r, f'_r, f''_r for $W(a, x_0 + rh)$ and its first two derivatives, then f'_0 may be found from

$$hf'_0 = \frac{1}{2n} (f_n - f_{-n}) - \frac{h^2}{2n} \sum_1^{n-1} (n-r)(f''_r - f''_{-r}) - \frac{h^2}{2n} \{ \frac{1}{12} - \frac{1}{24}\delta^2 + \frac{3}{80}\frac{1}{48}\delta^4 - \dots \} (f''_n - f''_{-n}) - h^2 \{ \frac{1}{12}\mu\delta - \frac{1}{720}\mu\delta^3 + \frac{1}{80}\frac{9}{480}\mu\delta^5 - \dots \} f''_0$$

(ii) Consider a solution y of the differential equation for $W(a, x)$, namely $y'' = (-\frac{1}{2}x^2 + a)y$. If we are given values y and y' at a particular $x=x_0$ and write $T_n = H^n y^{(n)}/n!$, $T_{-1} = T_{-2} = 0$, then we may compute T_2, T_3, T_4, \dots in succession by use of the recurrence relation obtained from the differential equation,

$$T_{n+2} = \frac{H^2}{(n+1)(n+2)} [(-\frac{1}{2}x_0^2 + a)T_n - \frac{1}{2}Hx_0T_{n-1} - \frac{1}{4}H^2T_{n-2}]$$

These are computed, to a fixed number of decimals until they become negligible, thus giving

$$y(x_0 \pm H) = T_0 \pm T_1 + T_2 \pm T_3 + \dots$$

This may be applied, with $H=rh$, h being the tabular interval, and r a small integer, say $r=5$, to the solutions $y=y_1, y=y_2$ having

$$\begin{aligned} y_1(x_0) &= W(a, x_0) & y'_1(x_0) &= W^{*'}(a, x_0) \\ y_2(x_0) &= 0 & y'_2(x_0) &= 1 \end{aligned}$$

in which $W^{*'}(a, x_0)$ is an approximation to $W'(a, x_0)$, not necessarily a good one; it may be

obtained from differences, for example. We thus obtain $y_1(x_0 \pm H)$ and $y_2(x_0 \pm H)$.

Now suppose

$$W'(a, x_0) = W''(a, x_0) + \lambda$$

then, for all x

$$W(a, x) = y_1(x) + \lambda y_2(x)$$

and in particular

$$W(a, x_0 \pm H) = y_1(x_0 \pm H) + \lambda y_2(x_0 \pm H)$$

The values of $W(a, x_0 \pm H)$ may be read from the tables and two independent estimates of λ obtained, whence

$$W'(a, x_0) = W''(a, x_0) + \lambda$$

to a suitable accuracy.

Example 2. Evaluate $W'(-3, 1)$ using $r=5$. From **Table 19.2**

$$W(-3, .5) = -.05857 \quad W(-3, 1) = -.61113$$

$$W(-3, 1.5) = -.69502$$

(i) Using the first method

x	$W(-3, x)$	$W''(-3, x)$	δ	δ^2	δ^3
0.4	+0.07298	-0.22186			
0.5	-.05857	+ .17937		+131	
0.6	-.18832	.58191			
0.7	-.31226	.97503			
0.8	-.42646	1.34761	34081		
0.9	-.52722	1.68842	29775		-1095
1.0	-.61113	1.98617	24374		-1032
1.1	-.67522	2.22991	17941		
1.2	-.71706	2.40932			
1.3	-.73488	2.51513			
1.4	-.72761	2.53936			
1.5	-.69502	2.47601		-9129	
1.6	-.63774	2.32137			

The fifth decimal in $W''(-3, x)$ is only a guard figure which is hardly needed. Only the differences needed have been computed.

Then

$$\frac{1}{10}W'(-3, 1)$$

$$= \frac{1}{10}(-.69502 + .05857) - \frac{1}{1000}(10.38874)$$

$$- \frac{1}{1000} \left\{ \frac{1}{1^2}(2.29664) - \frac{1}{240}(-.09260) \right\}$$

$$- \frac{1}{100} \left\{ \frac{1}{24}(.54149) - \frac{11}{1440}(-.02127) \right\}$$

$$= -.0636450 - .0103887 - .0001918 - .0002272$$

$$= -.0744527$$

Thus $W'(-3, 1) = -.74453$. This might have an error up to about $1\frac{1}{2}$ units in the last figure but is, in fact, correct to 5 decimals.

(ii) Using the second method, with

$$y_1(1) = W(-3, 1) = -.61113 \quad \text{to 5 decimals}$$

$$y_1'(1) = -.745 \quad \text{to about 3 decimals}$$

the following values result, with $H=.5$,

	y_1	y_2	$W(-3, x) = y_1 + \lambda y_2$
T_0	-.61113	.0000	At $x=1.5$
T_1	-.37250	+ .5000	$x-.695223 + .4323\lambda$
			$= -.69502$
T_2	+ .24827 2	.0000	$\lambda = .000203/.4323$
T_3	+ 5680 9	- 677	$= .000470$
T_4	- 1407 4	- 26	So $W'(-3, 1)$
			$= -.745 + \lambda$
			$= -.744530$
T_5	- 279 3	+ 24	At $x=.5$
T_6	+ 13 4	+ 2	$-.058363 - .4371\lambda$
			$= -.05857$
T_7	+ 5 4		$\lambda = .000207/.4371$
T_8	+ 5		$= .000474$
$y(1.5)$	-.695223	+ .4323	So $W'(-3, 1)$
$y(.5)$	-.058363	- .4371	$= -.745 + \lambda$
			$= -.744526$

Thus $W'(-3, 1) = -.74453$ which is correct to 5 decimals.

Example 3. Evaluate the positive zero of $U(-3, x)$.

We use **19.7.3** to obtain a first approximation, see **19.26.3**. The appropriate zero of $Ai(t)$ is at

$$t = (4|a|)^{1/2} \tau = -2.338$$

whence

$$\tau = -(2.338) \times (12)^{-1/2} = -.4461$$

Hence, from **Table 19.3**, $\xi = .3990$ and the approximate zero is $x = 2\sqrt{|a|}\xi = 1.382$.

We improve this by using **19.26.10**, but take, for convenience, $x=1.4$ as an approximation, so that the value of U can be read directly from the tables. U' can be obtained as in the section following

Example 1.

We find

$$U(-3, 1.4) = .02627 \quad U'(-3, 1.4) = 2.0637$$

Then **19.26.9** gives

$$u = U/U' = .012730 \quad I = -2.51$$

$$I' = .7 \quad I'' = .5$$

and

$$c = 1.4 - .012730 + .000002 = 1.38727$$

which is correct to 5 decimals, while 19.26.11 gives

$$y'(c) = 2.0637(1 + .000203) = 2.0641$$

compared with the correct value 2.06416.

References

Texts

- [19.1] H. Buchholz, Die konfluente hypergeometrische Funktion (Springer-Verlag, Berlin, Germany, 1953).
- [19.2] C. G. Darwin, On Weber's function, *Quart. J. Mech. Appl. Math.* **2**, 311-320 (1949).
- [19.3] A. Erdélyi et al., Higher transcendental functions, vol. 2 (McGraw-Hill Book Co., Inc., New York, N.Y., 1953).
- [19.4] J. C. P. Miller, On the choice of standard solutions to Weber's equation, *Proc. Cambridge Philos. Soc.* **48**, 428-435 (1952).
- [19.5] F. W. J. Olver, Uniform asymptotic expansions for Weber parabolic cylinder functions of large order, *J. Research NBS* **63B**, 2, 131-169 (1959), RP63B2-14.
- [19.6] G. N. Watson, A theory of asymptotic series, *Philos. Trans. Roy. Soc. London*, **A 211**, 279-313 (1911).
- [19.7] H. F. Weber, Ueber die Integration der partiellen Differential-gleichung: $\partial^2 u / \partial x^2 + \partial^2 u / \partial y^2 + k^2 u = 0$, *Math. Ann.* **1**, 1-36 (1869).
- [19.8] E. T. Whittaker, On the functions associated with the parabolic cylinder in harmonic analysis, *Proc. London Math. Soc.* **35**, 417-427 (1903).

- [19.9] E. T. Whittaker and G. N. Watson, A course of modern analysis, 4th ed. (Cambridge Univ. Press, Cambridge, England, 1952).

Tables

- [19.10] British Association for the Advancement of Science, *Mathematical Tables*, vol. I, Circular and hyperbolic functions, exponential, sine and cosine integrals, factorial (gamma) and derived functions, integrals of probability integral, 1st ed. (British Association, London, England, 1931; Cambridge Univ. Press, Cambridge, England, 2d ed., 1946, 3d ed., 1951).
- [19.11] National Physical Laboratory, *Tables of Weber parabolic cylinder functions*. Computed by Scientific Computing Service Ltd. *Mathematical Introduction* by J. C. P. Miller. (Her Majesty's Stationery Office, London, England, 1955).
- [19.12] National Physical Laboratory *Mathematical Tables*, vol. 4, *Tables of Weber parabolic cylinder functions and other functions for large arguments*, by L. Fox (Her Majesty's Stationery Office, London, England, 1960).



Table 19.1

x	$U(-5.0, x)$	$U(-4.5, x)$	$U(-4.0, x)$	$U(-3.5, x)$	$U(-3.0, x)$	$U(-2.5, x)$	$U(-2.0, x)$	$U(-1.5, x)$
0.0	(0) 3.0522	(0) 3.0000	(0) 1.5204	0.0000	(0) -0.8721	(0) -1.0000	(-1) -6.0814	0.0000
0.1	(0) 3.6547	(0) 2.9328	(0) 1.1869	(-1) -2.9825	(0) -1.0103	(-1) -9.8753	(-1) -5.1516	(-1) 0.9975
0.2	(0) 4.0753	(0) 2.7341	(-1) 8.0608	(-1) -5.8611	(0) -1.1183	(-1) -9.5045	(-1) -4.1190	(-1) 1.9801
0.3	(0) 4.2934	(0) 2.4132	(-1) +3.9325	(-1) -8.5358	(0) -1.1930	(-1) -8.8975	(-1) -3.0046	(-1) 2.9333
0.4	(0) 4.2988	(0) 1.9846	(-1) -0.3518	(0) -1.0915	(0) -1.2322	(-1) -8.0706	(-1) -1.8308	(-1) 3.8432
0.5	(0) 4.0918	(0) 1.4678	(-1) -4.6224	(0) -1.2917	(0) -1.2351	(-1) -7.0456	(-1) -0.6213	(-1) 4.6971
0.6	(0) 3.6836	(-1) 8.8615	(-1) -8.7118	(0) -1.4477	(0) -1.2018	(-1) -5.8492	(-1) +0.6004	(-1) 5.4836
0.7	(0) 3.0953	(-1) +2.6550	(0) -1.2462	(0) -1.5544	(0) -1.1336	(-1) -4.5120	(-1) 1.8107	(-1) 6.1929
0.8	(0) 2.3566	(-1) -3.6676	(0) -1.5731	(0) -1.6088	(0) -1.0329	(-1) -3.0677	(-1) 2.9871	(-1) 6.8172
0.9	(0) 1.5042	(-1) -9.8321	(0) -1.8397	(0) -1.6097	(-1) -9.0285	(-1) -1.5517	(-1) 4.1087	(-1) 7.3502
1.0	(0) +0.5799	(0) -1.5576	(0) -2.0368	(0) -1.5576	(-1) -7.4764	0.0000	(-1) 5.1567	(-1) 7.7880
1.1	(0) -0.3719	(0) -2.0661	(0) -2.1578	(0) -1.4550	(-1) -5.7190	(-1) 1.5518	(-1) 6.1146	(-1) 8.1287
1.2	(0) -1.3064	(0) -2.4882	(0) -2.1992	(0) -1.3061	(-1) -3.8076	(-1) 3.0698	(-1) 6.9691	(-1) 8.3721
1.3	(0) -2.1806	(0) -2.8077	(0) -2.1608	(0) -1.1162	(-1) -1.7956	(-1) 4.5223	(-1) 7.7095	(-1) 8.5203
1.4	(0) -2.9554	(0) -3.0131	(0) -2.0454	(-1) -8.9198	(-1) +0.2627	(-1) 5.8812	(-1) 8.3285	(-1) 8.5768
1.5	(0) -3.5976	(0) -3.0982	(0) -1.8583	(-1) -6.4101	(-1) 2.3147	(-1) 7.1223	(-1) 8.8221	(-1) 8.5467
1.6	(0) -4.0808	(0) -3.0617	(0) -1.6076	(-1) -3.7121	(-1) 4.3106	(-1) 8.2258	(-1) 9.1890	(-1) 8.4367
1.7	(0) -4.3868	(0) -2.9073	(0) -1.3029	(-1) -0.9080	(-1) 6.2053	(-1) 9.1766	(-1) 9.4313	(-1) 8.2541
1.8	(0) -4.5059	(0) -2.6435	(-1) -9.5564	(-1) +1.9218	(-1) 7.9592	(-1) 9.9648	(-1) 9.5532	(-1) 8.0074
1.9	(0) -4.4368	(0) -2.2824	(-1) -5.7791	(-1) 4.7004	(-1) 9.5394	(0) 1.0585	(-1) 9.5616	(-1) 7.7055
2.0	(0) -4.1866	(0) -1.8394	(-1) -1.8226	(-1) 7.3576	(0) 1.0920	(0) 1.1036	(-1) 9.4652	(-1) 7.3576
2.1	(0) -3.7694	(0) -1.3321	(-1) +2.1890	(-1) 9.8317	(0) 1.2083	(0) 1.1323	(-1) 9.2742	(-1) 6.1288
2.2	(0) -3.2057	(-1) -7.7961	(-1) 6.1381	(0) 1.2071	(0) 1.3017	(0) 1.1451	(-1) 9.0001	(-1) 6.5603
2.3	(0) -2.5208	(-1) -2.0142	(-1) 9.9170	(0) 1.4035	(0) 1.3719	(0) 1.1431	(-1) 8.6549	(-1) 6.1288
2.4	(0) -1.7434	(-1) +3.8325	(0) 1.3432	(0) 1.5694	(0) 1.4191	(0) 1.1278	(-1) 8.2510	(-1) 5.6863
2.5	(0) -0.9039	(-1) 9.5635	(0) 1.6604	(0) 1.7031	(0) 1.4443	(0) 1.1005	(-1) 7.8009	(-1) 5.2403
2.6	(0) -0.0332	(0) 1.5015	(0) 1.9373	(0) 1.8039	(0) 1.4487	(0) 1.0628	(-1) 7.3167	(-1) 4.7975
2.7	(0) +0.8387	(0) 2.0048	(0) 2.1696	(0) 1.8721	(0) 1.4341	(0) 1.0166	(-1) 6.8097	(-1) 4.3638
2.8	(0) 1.6842	(0) 2.4545	(0) 2.3548	(0) 1.9089	(0) 1.4027	(-1) 9.6347	(-1) 6.2905	(-1) 3.9440
2.9	(0) 2.4789	(0) 2.8422	(0) 2.4921	(0) 1.9164	(0) 1.3567	(-1) 9.0514	(-1) 5.7687	(-1) 3.5424
3.0	(0) 3.2021	(0) 3.1620	(0) 2.5823	(0) 1.8972	(0) 1.2985	(-1) 8.4319	(-1) 5.2527	(-1) 3.1620
3.1	(0) 3.8377	(0) 3.4108	(0) 2.6273	(0) 1.8543	(0) 1.2306	(-1) 7.7913	(-1) 4.7497	(-1) 2.8052
3.2	(0) 4.3739	(0) 3.5883	(0) 2.6304	(0) 1.7910	(0) 1.1553	(-1) 7.1430	(-1) 4.2658	(-1) 2.4738
3.3	(0) 4.8038	(0) 3.6963	(0) 2.5957	(0) 1.7109	(0) 1.0749	(-1) 6.4987	(-1) 3.8056	(-1) 2.1684
3.4	(0) 5.1246	(0) 3.7388	(0) 2.5279	(0) 1.6175	(-1) 9.9150	(-1) 5.8688	(-1) 3.3729	(-1) 1.8896
3.5	(0) 5.3376	(0) 3.7212	(0) 2.4320	(0) 1.5142	(-1) 9.0701	(-1) 5.2617	(-1) 2.9700	(-1) 1.6370
3.6	(0) 5.4473	(0) 3.6501	(0) 2.3134	(0) 1.4043	(-1) 8.2306	(-1) 4.6840	(-1) 2.5987	(-1) 1.4099
3.7	(0) 5.4614	(0) 3.5331	(0) 2.1771	(0) 1.2906	(-1) 7.4107	(-1) 4.1408	(-1) 2.2595	(-1) 1.2073
3.8	(0) 5.3895	(0) 3.3781	(0) 2.0282	(0) 1.1760	(-1) 6.6219	(-1) 3.6358	(-1) 1.9525	(-1) 1.0280
3.9	(0) 5.2427	(0) 3.1929	(0) 1.8714	(0) 1.0626	(-1) 5.8733	(-1) 3.1709	(-1) 1.6768	(-2) 8.7028
4.0	(0) 5.0332	(0) 2.9854	(0) 1.7108	(-1) 9.5241	(-1) 5.1716	(-1) 2.7473	(-1) 1.4313	(-2) 7.3263
4.1	(0) 4.7733	(0) 2.7630	(0) 1.5502	(-1) 8.4694	(-1) 4.5215	(-1) 2.3649	(-1) 1.2144	(-2) 6.1328
4.2	(0) 4.4753	(0) 2.5323	(0) 1.3927	(-1) 7.4740	(-1) 3.9256	(-1) 2.0226	(-1) 1.0242	(-2) 5.1052
4.3	(0) 4.1508	(0) 2.2992	(0) 1.2408	(-1) 6.5463	(-1) 3.3849	(-1) 1.7190	(-2) 8.5874	(-2) 4.2261
4.4	(0) 3.8106	(0) 2.0689	(0) 1.0967	(-1) 5.6918	(-1) 2.8991	(-1) 1.4517	(-2) 7.1578	(-2) 3.4791
4.5	(0) 3.4641	(0) 1.8455	(-1) 9.6165	(-1) 4.9134	(-1) 2.4665	(-1) 1.2185	(-2) 5.9314	(-2) 2.8484
4.6	(0) 3.1197	(0) 1.6324	(-1) 8.3683	(-1) 4.2117	(-1) 2.0848	(-1) 1.0164	(-2) 4.8867	(-2) 2.3192
4.7	(0) 2.7843	(0) 1.4322	(-1) 7.2277	(-1) 3.5852	(-1) 1.7507	(-2) 8.4272	(-2) 4.0029	(-2) 1.8780
4.8	(0) 2.4632	(0) 1.2466	(-1) 6.1969	(-1) 3.0311	(-1) 1.4608	(-2) 6.9451	(-2) 3.2603	(-2) 1.5125
4.9	(0) 2.1608	(0) 1.0766	(-1) 5.2750	(-1) 2.5455	(-1) 1.2112	(-2) 5.6894	(-2) 2.6403	(-2) 1.2116
5.0	(0) 1.8800	(-1) 9.2276	(-1) 4.4586	(-1) 2.1235	(-2) 9.9802	(-2) 4.6331	(-2) 2.1262	(-3) 9.6523

For interpolation, see 19.28.

Table 19.1

x	$V(-5.0, x)$	$V(-4.5, x)$	$V(-4.0, x)$	$V(-3.5, x)$	$V(-3.0, x)$	$V(-2.5, x)$	$V(-2.0, x)$	$V(-1.5, x)$
0.0	(-2) -5.8311	0.0000	(-1) 1.3071	(-1) 2.6596	(-1) 2.6240	0.0000	(-1) -4.5748	(-1) -7.9788
0.1	(-2) -4.3898	(-2) 2.6397	(-1) 1.5417	(-1) 2.6132	(-1) 2.1296	(-1) -0.7946	(-1) -5.1829	(-1) -7.9191
0.2	(-2) -2.7299	(-2) 5.1612	(-1) 1.7149	(-1) 2.4757	(-1) 1.5714	(-1) -1.5693	(-1) -5.6877	(-1) -7.7409
0.3	(-2) -0.9344	(-2) 7.4519	(-1) 1.8199	(-1) 2.2520	(-2) 9.6646	(-1) -2.3051	(-1) -6.0796	(-1) -7.4476
0.4	(-2) +0.9074	(-2) 9.4102	(-1) 1.8527	(-1) 1.9503	(-2) +3.3275	(-1) -2.9840	(-1) -6.3515	(-1) -7.0444
0.5	(-2) 2.7045	(-1) 1.0950	(-1) 1.8125	(-1) 1.5812	(-2) -3.1080	(-1) -3.5896	(-1) -6.4991	(-1) -6.5385
0.6	(-2) 4.3687	(-1) 1.2007	(-1) 1.7011	(-1) 1.1580	(-2) -9.4527	(-1) -4.1079	(-1) -6.5210	(-1) -5.9387
0.7	(-2) 5.8194	(-1) 1.2536	(-1) 1.5234	(-2) 6.9534	(-1) -1.5523	(-1) -4.5275	(-1) -6.4186	(-1) -5.2553
0.8	(-2) 6.9875	(-1) 1.2518	(-1) 1.2869	(-2) +2.0926	(-1) -2.1149	(-1) -4.8397	(-1) -6.1959	(-1) -4.4995
0.9	(-2) 7.8188	(-1) 1.1958	(-1) 1.0010	(-2) -2.8383	(-1) -2.6176	(-1) -5.0388	(-1) -5.8594	(-1) -3.6835
1.0	(-2) 8.2767	(-1) 1.0887	(-2) 6.7728	(-2) -7.6762	(-1) -3.0472	(-1) -5.1225	(-1) -5.4177	(-1) -2.8197
1.1	(-2) 8.3429	(-2) 9.3549	(-2) +3.2819	(-1) -1.2266	(-1) -3.3933	(-1) -5.0912	(-1) -4.8813	(-1) -1.9206
1.2	(-2) 8.0189	(-2) 7.4311	(-2) -0.3303	(-1) -1.6465	(-1) -3.6481	(-1) -4.9482	(-1) -4.2621	(-1) -0.9984
1.3	(-2) 7.3241	(-2) 5.2005	(-2) -3.9309	(-1) -2.0148	(-1) -3.8069	(-1) -4.6995	(-1) -3.5731	(-1) -0.0648
1.4	(-2) 6.2954	(-2) 2.7584	(-2) -7.3916	(-1) -2.3214	(-1) -3.8677	(-1) -4.3533	(-1) -2.8278	(-1) +0.8696
1.5	(-2) 4.9836	(-2) +0.2057	(-1) -1.0594	(-1) -2.5583	(-1) -3.8317	(-1) -3.9197	(-1) -2.0397	(-1) 1.7953
1.6	(-2) 3.4514	(-2) -2.3553	(-1) -1.3434	(-1) -2.7203	(-1) -3.7025	(-1) -3.4103	(-1) -1.2222	(-1) 2.7043
1.7	(-2) 1.7690	(-2) -4.8261	(-1) -1.5824	(-1) -2.8047	(-1) -3.4861	(-1) -2.8375	(-1) -0.3880	(-1) 3.5902
1.8	(-2) +0.0110	(-2) -7.1155	(-1) -1.7697	(-1) -2.8113	(-1) -3.1904	(-1) -2.2142	(-1) +0.4512	(-1) 4.4484
1.9	(-2) -1.7477	(-2) -9.1435	(-1) -1.9008	(-1) -2.7426	(-1) -2.8250	(-1) -1.5535	(-1) 1.2852	(-1) 5.2761
2.0	(-2) -3.4354	(-1) -1.0844	(-1) -1.9731	(-1) -2.6027	(-1) -2.4003	(-1) -0.8679	(-1) 2.1053	(-1) 6.0723
2.1	(-2) -4.9863	(-1) -1.2166	(-1) -1.9864	(-1) -2.3979	(-1) -1.9277	(-1) -0.1692	(-1) 2.9044	(-1) 6.8384
2.2	(-2) -6.3439	(-1) -1.3076	(-1) -1.9423	(-1) -2.1357	(-1) -1.4184	(-1) +0.5320	(-1) 3.6777	(-1) 7.5775
2.3	(-2) -7.4620	(-1) -1.3558	(-1) -1.8442	(-1) -1.8247	(-2) -8.8371	(-1) 1.2264	(-1) 4.4221	(-1) 8.2948
2.4	(-2) -8.3067	(-1) -1.3610	(-1) -1.6967	(-1) -1.4739	(-2) -3.3411	(-1) 1.9066	(-1) 5.1367	(-1) 8.9975
2.5	(-2) -8.8568	(-1) -1.3246	(-1) -1.5059	(-1) -1.0927	(-2) +2.2080	(-1) 2.5667	(-1) 5.8227	(-1) 9.6950
2.6	(-2) -9.1035	(-1) -1.2495	(-1) -1.2784	(-2) -6.9034	(-2) 7.7266	(-1) 3.2030	(-1) 6.4834	(0) 1.0399
2.7	(-2) -9.0496	(-1) -1.1392	(-1) -1.0214	(-2) -2.7540	(-1) 1.3145	(-1) 3.8134	(-1) 7.1242	(0) 1.1122
2.8	(-2) -8.7090	(-2) -9.9858	(-2) -7.4214	(-2) +1.4424	(-1) 1.8411	(-1) 4.3982	(-1) 7.7525	(0) 1.1882
2.9	(-2) -8.1043	(-2) -8.3257	(-2) -4.4770	(-2) 5.6176	(-1) 2.3486	(-1) 4.9594	(-1) 8.3779	(0) 1.2697
3.0	(-2) -7.2651	(-2) -6.4659	(-2) -1.4470	(-2) 9.7155	(-1) 2.8352	(-1) 5.5010	(-1) 9.0120	(0) 1.3588
3.1	(-2) -6.2264	(-2) -4.4605	(-2) +1.6090	(-1) 1.3693	(-1) 3.3007	(-1) 6.0291	(-1) 9.6689	(0) 1.4582
3.2	(-2) -5.0260	(-2) -2.3612	(-2) 4.6402	(-1) 1.7522	(-1) 3.7466	(-1) 6.5514	(0) 1.0365	(0) 1.5708
3.3	(-2) -3.7030	(-2) -0.2157	(-2) 7.6054	(-1) 2.1187	(-1) 4.1761	(-1) 7.0778	(0) 1.1119	(0) 1.7001
3.4	(-2) -2.2954	(-2) +1.9344	(-1) 1.0474	(-1) 2.4688	(-1) 4.5942	(-1) 7.6202	(0) 1.1954	(0) 1.8502
3.5	(-2) -0.8391	(-2) 4.0539	(-1) 1.3228	(-1) 2.8040	(-1) 5.0074	(-1) 8.1924	(0) 1.2896	(0) 2.0262
3.6	(-2) +0.6339	(-2) 6.1158	(-1) 1.5859	(-1) 3.1270	(-1) 5.4239	(-1) 8.8110	(0) 1.3975	(0) 2.2339
3.7	(-2) 2.0962	(-2) 8.1014	(-1) 1.8370	(-1) 3.4421	(-1) 5.8535	(-1) 9.4951	(0) 1.5228	(0) 2.4806
3.8	(-2) 3.5259	(-1) 1.0000	(-1) 2.0775	(-1) 3.7545	(-1) 6.3080	(0) 1.0267	(0) 1.6699	(0) 2.7751
3.9	(-2) 4.9072	(-1) 1.1811	(-1) 2.3101	(-1) 4.0712	(-1) 6.8012	(0) 1.1153	(0) 1.8439	(0) 3.1285
4.0	(-2) 6.2301	(-1) 1.3540	(-1) 2.5382	(-1) 4.4004	(-1) 7.3492	(0) 1.2186	(0) 2.0513	(0) 3.5541
4.1	(-2) 7.4913	(-1) 1.5202	(-1) 2.7664	(-1) 4.7517	(-1) 7.9710	(0) 1.3401	(0) 2.2999	(0) 4.0690
4.2	(-2) 8.6933	(-1) 1.6819	(-1) 3.0002	(-1) 5.1365	(-1) 8.6890	(0) 1.4846	(0) 2.5993	(0) 4.6942
4.3	(-2) 9.8444	(-1) 1.8422	(-1) 3.2465	(-1) 5.5683	(-1) 9.5300	(0) 1.6575	(0) 2.9616	(0) 5.4567
4.4	(-1) 1.0959	(-1) 2.0048	(-1) 3.5131	(-1) 6.0629	(0) 1.0526	(0) 1.8657	(0) 3.4019	(0) 6.3903
4.5	(-1) 1.2056	(-1) 2.1743	(-1) 3.8093	(-1) 6.6389	(0) 1.1717	(0) 2.1178	(0) 3.9393	(0) 7.5384
4.6	(-1) 1.3161	(-1) 2.3561	(-1) 4.1462	(-1) 7.3192	(0) 1.3150	(0) 2.4244	(0) 4.5978	(0) 8.9563
4.7	(-1) 1.4305	(-1) 2.5567	(-1) 4.5368	(-1) 8.1309	(0) 1.4885	(0) 2.7989	(0) 5.4083	(1) 1.0715
4.8	(-1) 1.5525	(-1) 2.7834	(-1) 4.9967	(-1) 9.1078	(0) 1.6998	(0) 3.2584	(0) 6.4102	(1) 1.2908
4.9	(-1) 1.6863	(-1) 3.0454	(-1) 5.5449	(0) 1.0291	(0) 1.9582	(0) 3.8246	(0) 7.6545	(1) 1.5653
5.0	(-1) 1.8370	(-1) 3.3533	(-1) 6.2047	(0) 1.1734	(0) 2.2757	(0) 4.5254	(0) 9.2067	(1) 1.9107

Table 19.1

x	$U(-1.0, x)$	$U(-0.9, x)$	$U(-0.8, x)$	$U(-0.7, x)$	$U(-0.6, x)$	$U(-0.5, x)$	$U(-0.4, x)$
0.0	(-1) 5.8137	(-1) 6.8058	(-1) 7.7241	(-1) 8.5642	(-1) 9.3233	(0) 1.0000	(0) 1.0594
0.1	(-1) 6.3918	(-1) 7.2692	(-1) 8.0677	(-1) 8.7853	(-1) 9.4211	(-1) 9.9750	(0) 1.0448
0.2	(-1) 6.9062	(-1) 7.6673	(-1) 8.3471	(-1) 8.9453	(-1) 9.4626	(-1) 9.9005	(0) 1.0261
0.3	(-1) 7.3523	(-1) 7.9973	(-1) 8.5606	(-1) 9.0436	(-1) 9.4483	(-1) 9.7775	(0) 1.0035
0.4	(-1) 7.7267	(-1) 8.2572	(-1) 8.7077	(-1) 9.0807	(-1) 9.3796	(-1) 9.6079	(-1) 9.7698
0.5	(-1) 8.0270	(-1) 8.4462	(-1) 8.7886	(-1) 9.0580	(-1) 9.2584	(-1) 9.3941	(-1) 9.4700
0.6	(-1) 8.2522	(-1) 8.5646	(-1) 8.8049	(-1) 8.9776	(-1) 9.0874	(-1) 9.1393	(-1) 9.1382
0.7	(-1) 8.4023	(-1) 8.6136	(-1) 8.7586	(-1) 8.8425	(-1) 8.8702	(-1) 8.8471	(-1) 8.7781
0.8	(-1) 8.4788	(-1) 8.5958	(-1) 8.6531	(-1) 8.6563	(-1) 8.6107	(-1) 8.5214	(-1) 8.3937
0.9	(-1) 8.4842	(-1) 8.5144	(-1) 8.4923	(-1) 8.4235	(-1) 8.3133	(-1) 8.1669	(-1) 7.9892
1.0	(-1) 8.4220	(-1) 8.3737	(-1) 8.2808	(-1) 8.1488	(-1) 7.9828	(-1) 7.7880	(-1) 7.5689
1.1	(-1) 8.2967	(-1) 8.1787	(-1) 8.0238	(-1) 7.8374	(-1) 7.6245	(-1) 7.3897	(-1) 7.1372
1.2	(-1) 8.1136	(-1) 7.9348	(-1) 7.7269	(-1) 7.4949	(-1) 7.2435	(-1) 6.9768	(-1) 6.6986
1.3	(-1) 7.8786	(-1) 7.6480	(-1) 7.3960	(-1) 7.1269	(-1) 6.8451	(-1) 6.5541	(-1) 6.2573
1.4	(-1) 7.5982	(-1) 7.3248	(-1) 7.0371	(-1) 6.7392	(-1) 6.4345	(-1) 6.1263	(-1) 5.8173
1.5	(-1) 7.2789	(-1) 6.9716	(-1) 6.6565	(-1) 6.3372	(-1) 6.0168	(-1) 5.6978	(-1) 5.3826
1.6	(-1) 6.9279	(-1) 6.5948	(-1) 6.2600	(-1) 5.9266	(-1) 5.5968	(-1) 5.2729	(-1) 4.9566
1.7	(-1) 6.5519	(-1) 6.2008	(-1) 5.8535	(-1) 5.5123	(-1) 5.1791	(-1) 4.8554	(-1) 4.5424
1.8	(-1) 6.1577	(-1) 5.7958	(-1) 5.4424	(-1) 5.0993	(-1) 4.7676	(-1) 4.4486	(-1) 4.1429
1.9	(-1) 5.7517	(-1) 5.3855	(-1) 5.0319	(-1) 4.6918	(-1) 4.3662	(-1) 4.0555	(-1) 3.7603
2.0	(-1) 5.3401	(-1) 4.9754	(-1) 4.6264	(-1) 4.2938	(-1) 3.9779	(-1) 3.6788	(-1) 3.3965
2.1	(-1) 4.9285	(-1) 4.5701	(-1) 4.2301	(-1) 3.9086	(-1) 3.6054	(-1) 3.3204	(-1) 3.0532
2.2	(-1) 4.5219	(-1) 4.1741	(-1) 3.8466	(-1) 3.5391	(-1) 3.2511	(-1) 2.9820	(-1) 2.7312
2.3	(-1) 4.1247	(-1) 3.7910	(-1) 3.4788	(-1) 3.1876	(-1) 2.9165	(-1) 2.6647	(-1) 2.4313
2.4	(-1) 3.7407	(-1) 3.4238	(-1) 3.1292	(-1) 2.8559	(-1) 2.6029	(-1) 2.3693	(-1) 2.1538
2.5	(-1) 3.3732	(-1) 3.0751	(-1) 2.7995	(-1) 2.5453	(-1) 2.3112	(-1) 2.0961	(-1) 1.8987
2.6	(-1) 3.0246	(-1) 2.7467	(-1) 2.4912	(-1) 2.2566	(-1) 2.0418	(-1) 1.8452	(-1) 1.6657
2.7	(-1) 2.6968	(-1) 2.4399	(-1) 2.2049	(-1) 1.9903	(-1) 1.7945	(-1) 1.6162	(-1) 1.4541
2.8	(-1) 2.3911	(-1) 2.1556	(-1) 1.9412	(-1) 1.7462	(-1) 1.5691	(-1) 1.4086	(-1) 1.2632
2.9	(-1) 2.1084	(-1) 1.8942	(-1) 1.7000	(-1) 1.5241	(-1) 1.3651	(-1) 1.2215	(-1) 1.0920
3.0	(-1) 1.8488	(-1) 1.6555	(-1) 1.4809	(-1) 1.3234	(-1) 1.1816	(-1) 1.0540	(-2) 9.3934
3.1	(-1) 1.6124	(-1) 1.4391	(-1) 1.2832	(-1) 1.1432	(-1) 1.0175	(-2) 9.0491	(-2) 8.0408
3.2	(-1) 1.3985	(-1) 1.2443	(-1) 1.1061	(-2) 9.8240	(-2) 8.7182	(-2) 7.7305	(-2) 6.8492
3.3	(-1) 1.2064	(-1) 1.0701	(-2) 9.4842	(-2) 8.3989	(-2) 7.4318	(-2) 6.5710	(-2) 5.8055
3.4	(-1) 1.0351	(-2) 9.1545	(-2) 8.0899	(-2) 7.1436	(-2) 6.3032	(-2) 5.5576	(-2) 4.8967
3.5	(-2) 8.8335	(-2) 7.7900	(-2) 6.8646	(-2) 6.0447	(-2) 5.3190	(-2) 4.6771	(-2) 4.1098
3.6	(-2) 7.4981	(-2) 6.5939	(-2) 5.7946	(-2) 5.0887	(-2) 4.4657	(-2) 3.9164	(-2) 3.4324
3.7	(-2) 6.3306	(-2) 5.5521	(-2) 4.8660	(-2) 4.2619	(-2) 3.7304	(-2) 3.2631	(-2) 2.8525
3.8	(-2) 5.3165	(-2) 4.6503	(-2) 4.0651	(-2) 3.5512	(-2) 3.1004	(-2) 2.7052	(-2) 2.3589
3.9	(-2) 4.4411	(-2) 3.8747	(-2) 3.3784	(-2) 2.9439	(-2) 2.5638	(-2) 2.2315	(-2) 1.9411
4.0	(-2) 3.6903	(-2) 3.2115	(-2) 2.7932	(-2) 2.4280	(-2) 2.1094	(-2) 1.8316	(-2) 1.5895
4.1	(-2) 3.0502	(-2) 2.6480	(-2) 2.2975	(-2) 1.9923	(-2) 1.7268	(-2) 1.4958	(-2) 1.2951
4.2	(-2) 2.5079	(-2) 2.1720	(-2) 1.8800	(-2) 1.6265	(-2) 1.4064	(-2) 1.2155	(-2) 1.0500
4.3	(-2) 2.0512	(-2) 1.7723	(-2) 1.5305	(-2) 1.3211	(-2) 1.1397	(-3) 9.8282	(-3) 8.4709
4.4	(-2) 1.6688	(-2) 1.4386	(-2) 1.2396	(-2) 1.0676	(-3) 9.1898	(-3) 7.9071	(-3) 6.8002
4.5	(-2) 1.3507	(-2) 1.1618	(-3) 9.9881	(-3) 8.5831	(-3) 7.3725	(-3) 6.3297	(-3) 5.4320
4.6	(-2) 1.0875	(-3) 9.3333	(-3) 8.0067	(-3) 6.8657	(-3) 5.8847	(-3) 5.0418	(-3) 4.3177
4.7	(-3) 8.7099	(-3) 7.4594	(-3) 6.3856	(-3) 5.4641	(-3) 4.6736	(-3) 3.9958	(-3) 3.4150
4.8	(-3) 6.9398	(-3) 5.9310	(-3) 5.0667	(-3) 4.3266	(-3) 3.6931	(-3) 3.1511	(-3) 2.6876
4.9	(-3) 5.5007	(-3) 4.6914	(-3) 3.9996	(-3) 3.4085	(-3) 2.9036	(-3) 2.4726	(-3) 2.1047
5.0	(-3) 4.3375	(-3) 3.6919	(-3) 3.1412	(-3) 2.6716	(-3) 2.2714	(-3) 1.9305	(-3) 1.6401

Table 19.1

x	$V(-1.0, x)$	$V(-0.9, x)$	$V(-0.8, x)$	$V(-0.7, x)$	$V(-0.6, x)$	$V(-0.5, x)$	$V(-0.4, x)$
0.0	(-1) -6.5600	(-1) -5.5730	(-1) -4.3852	(-1) -3.0307	(-1) -1.5522	0.0000	(-1) 1.5701
0.1	(-1) -5.8422	(-1) -4.7818	(-1) -3.5487	(-1) -2.1784	(-1) -0.7135	(-1) 0.7972	(-1) 2.3012
0.2	(-1) -5.0662	(-1) -3.9477	(-1) -2.6839	(-1) -1.3109	(-1) +0.1294	(-1) 1.5905	(-1) 3.0232
0.3	(-1) -4.2400	(-1) -3.0785	(-1) -1.7980	(-1) -0.4343	(-1) 0.9716	(-1) 2.3760	(-1) 3.7334
0.4	(-1) -3.3725	(-1) -2.1823	(-1) -0.8980	(-1) +0.4451	(-1) 1.8082	(-1) 3.1502	(-1) 4.4296
0.5	(-1) -2.4725	(-1) -1.2674	(-1) +0.0088	(-1) 1.3217	(-1) 2.6347	(-1) 3.9099	(-1) 5.1099
0.6	(-1) -1.5494	(-1) -0.3418	(-1) 0.9156	(-1) 2.1900	(-1) 3.4471	(-1) 4.6526	(-1) 5.7729
0.7	(-1) -0.6122	(-1) +0.5867	(-1) 1.8159	(-1) 3.0449	(-1) 4.2420	(-1) 5.3763	(-1) 6.4182
0.8	(-1) +0.3305	(-1) 1.5106	(-1) 2.7040	(-1) 3.8823	(-1) 5.0167	(-1) 6.0797	(-1) 7.0457
0.9	(-1) 1.2704	(-1) 2.4234	(-1) 3.5749	(-1) 4.6988	(-1) 5.7694	(-1) 6.7626	(-1) 7.6563
1.0	(-1) 2.2004	(-1) 3.3194	(-1) 4.4245	(-1) 5.4920	(-1) 6.4993	(-1) 7.4254	(-1) 8.2519
1.1	(-1) 3.1139	(-1) 4.1939	(-1) 5.2498	(-1) 6.2606	(-1) 7.2065	(-1) 8.0697	(-1) 8.8353
1.2	(-1) 4.0057	(-1) 5.0435	(-1) 6.0492	(-1) 7.0044	(-1) 7.8924	(-1) 8.6982	(-1) 9.4101
1.3	(-1) 4.8721	(-1) 5.8660	(-1) 6.8220	(-1) 7.7246	(-1) 8.5594	(-1) 9.3147	(-1) 9.9812
1.4	(-1) 5.7105	(-1) 6.6605	(-1) 7.5693	(-1) 8.4234	(-1) 9.2113	(-1) 9.9240	(0) 1.0555
1.5	(-1) 6.5198	(-1) 7.4279	(-1) 8.2931	(-1) 9.1046	(-1) 9.8533	(0) 1.0532	(0) 1.1138
1.6	(-1) 7.3008	(-1) 8.1704	(-1) 8.9974	(-1) 9.7734	(0) 1.0492	(0) 1.1148	(0) 1.1739
1.7	(-1) 8.0557	(-1) 8.8917	(-1) 9.6875	(0) 1.0437	(0) 1.1134	(0) 1.1778	(0) 1.2369
1.8	(-1) 8.7883	(-1) 9.5974	(0) 1.0370	(0) 1.1102	(0) 1.1791	(0) 1.2436	(0) 1.3038
1.9	(-1) 9.5044	(0) 1.0295	(0) 1.1054	(0) 1.1780	(0) 1.2472	(0) 1.3132	(0) 1.3762
2.0	(0) 1.0211	(0) 1.0992	(0) 1.1749	(0) 1.2482	(0) 1.3191	(0) 1.3881	(0) 1.4554
2.1	(0) 1.0918	(0) 1.1701	(0) 1.2468	(0) 1.3222	(0) 1.3964	(0) 1.4699	(0) 1.5435
2.2	(0) 1.1637	(0) 1.2434	(0) 1.3225	(0) 1.4015	(0) 1.4806	(0) 1.5607	(0) 1.6424
2.3	(0) 1.2380	(0) 1.3205	(0) 1.4037	(0) 1.4879	(0) 1.5740	(0) 1.6625	(0) 1.7546
2.4	(0) 1.3163	(0) 1.4032	(0) 1.4922	(0) 1.5837	(0) 1.6787	(0) 1.7781	(0) 1.8830
2.5	(0) 1.4005	(0) 1.4936	(0) 1.5902	(0) 1.6912	(0) 1.7975	(0) 1.9104	(0) 2.0311
2.6	(0) 1.4925	(0) 1.5939	(0) 1.7005	(0) 1.8134	(0) 1.9338	(0) 2.0631	(0) 2.2029
2.7	(0) 1.5949	(0) 1.7068	(0) 1.8259	(0) 1.9535	(0) 2.0911	(0) 2.2404	(0) 2.4032
2.8	(0) 1.7104	(0) 1.8355	(0) 1.9700	(0) 2.1157	(0) 2.2741	(0) 2.4474	(0) 2.6378
2.9	(0) 1.8424	(0) 1.9837	(0) 2.1371	(0) 2.3045	(0) 2.4881	(0) 2.6902	(0) 2.9136
3.0	(0) 1.9948	(0) 2.1558	(0) 2.3321	(0) 2.5258	(0) 2.7396	(0) 2.9763	(0) 3.2392
3.1	(0) 2.1722	(0) 2.3571	(0) 2.5609	(0) 2.7864	(0) 3.0365	(0) 3.3147	(0) 3.6249
3.2	(0) 2.3801	(0) 2.5940	(0) 2.8310	(0) 3.0945	(0) 3.3882	(0) 3.7163	(0) 4.0834
3.3	(0) 2.6253	(0) 2.8740	(0) 3.1511	(0) 3.4604	(0) 3.8066	(0) 4.1947	(0) 4.6305
3.4	(0) 2.9159	(0) 3.2066	(0) 3.5319	(0) 3.8966	(0) 4.3061	(0) 4.7667	(0) 5.2855
3.5	(0) 3.2618	(0) 3.6032	(0) 3.9868	(0) 4.4183	(0) 4.9045	(0) 5.4531	(0) 6.0726
3.6	(0) 3.6752	(0) 4.0781	(0) 4.5323	(0) 5.0449	(0) 5.6242	(0) 6.2797	(0) 7.0220
3.7	(0) 4.1712	(0) 4.6487	(0) 5.1887	(0) 5.8001	(0) 6.4930	(0) 7.2790	(0) 8.1716
3.8	(0) 4.7686	(0) 5.3371	(0) 5.9818	(0) 6.7138	(0) 7.5458	(0) 8.4920	(0) 9.5693
3.9	(0) 5.4910	(0) 6.1706	(0) 6.9437	(0) 7.8238	(0) 8.8266	(0) 9.9703	(1) 1.1276
4.0	(0) 6.3680	(0) 7.1841	(0) 8.1149	(0) 9.1775	(1) 1.0391	(1) 1.1779	(1) 1.3367
4.1	(0) 7.4368	(0) 8.4212	(0) 9.5470	(1) 1.0835	(1) 1.2311	(1) 1.4002	(1) 1.5942
4.2	(0) 8.7448	(0) 9.9377	(1) 1.1305	(1) 1.2875	(1) 1.4676	(1) 1.6747	(1) 1.9127
4.3	(1) 1.0352	(1) 1.1805	(1) 1.3474	(1) 1.5394	(1) 1.7604	(1) 2.0149	(1) 2.3082
4.4	(1) 1.2337	(1) 1.4113	(1) 1.6160	(1) 1.8520	(1) 2.1243	(1) 2.4386	(1) 2.8017
4.5	(1) 1.4797	(1) 1.6981	(1) 1.9502	(1) 2.2417	(1) 2.5787	(1) 2.9687	(1) 3.4202
4.6	(1) 1.7862	(1) 2.0559	(1) 2.3680	(1) 2.7297	(1) 3.1489	(1) 3.6350	(1) 4.1991
4.7	(1) 2.1698	(1) 2.5044	(1) 2.8928	(1) 3.3437	(1) 3.8676	(1) 4.4765	(1) 5.1846
4.8	(1) 2.6520	(1) 3.0694	(1) 3.5549	(1) 4.1199	(1) 4.7777	(1) 5.5441	(1) 6.4372
4.9	(1) 3.2611	(1) 3.7844	(1) 4.3944	(1) 5.1058	(1) 5.9359	(1) 6.9051	(1) 8.0370
5.0	(1) 4.0344	(1) 4.6937	(1) 5.4639	(1) 6.3641	(1) 7.4168	(1) 8.6484	(2) 1.0090

Table 19.1

x	$U(-0.3, x)$	$U(-0.2, x)$	$U(-0.1, x)$	$U(0, x)$	$U(0.1, x)$	$U(0.2, x)$	$U(0.3, x)$
0.0	(0) 1.1105	(0) 1.1535	(0) 1.1887	(0) 1.2163	(0) 1.2366	(0) 1.2500	(0) 1.2570
0.1	(0) 1.0843	(0) 1.1161	(0) 1.1406	(0) 1.1581	(0) 1.1691	(0) 1.1740	(0) 1.1732
0.2	(0) 1.0548	(0) 1.0764	(0) 1.0914	(0) 1.1000	(0) 1.1029	(0) 1.1004	(0) 1.0930
0.3	(0) 1.0223	(0) 1.0347	(0) 1.0412	(0) 1.0421	(0) 1.0379	(0) 1.0291	(0) 1.0161
0.4	(-1) 9.8697	(-1) 9.9120	(-1) 9.9016	(-1) 9.8431	(-1) 9.7411	(-1) 9.6004	(-1) 9.4255
0.5	(-1) 9.4906	(-1) 9.4609	(-1) 9.3856	(-1) 9.2695	(-1) 9.1173	(-1) 8.9333	(-1) 8.7218
0.6	(-1) 9.0890	(-1) 8.9968	(-1) 8.8661	(-1) 8.7018	(-1) 8.5082	(-1) 8.2895	(-1) 8.0498
0.7	(-1) 8.6684	(-1) 8.5228	(-1) 8.3458	(-1) 8.1419	(-1) 7.9153	(-1) 7.6699	(-1) 7.4093
0.8	(-1) 8.2324	(-1) 8.0421	(-1) 7.8273	(-1) 7.5920	(-1) 7.3400	(-1) 7.0750	(-1) 6.8000
0.9	(-1) 7.7849	(-1) 7.5583	(-1) 7.3135	(-1) 7.0542	(-1) 6.7838	(-1) 6.5055	(-1) 6.2220
1.0	(-1) 7.3298	(-1) 7.0747	(-1) 6.8072	(-1) 6.5307	(-1) 6.2482	(-1) 5.9622	(-1) 5.6753
1.1	(-1) 6.8710	(-1) 6.5946	(-1) 6.3111	(-1) 6.0235	(-1) 5.7343	(-1) 5.4457	(-1) 5.1597
1.2	(-1) 6.4124	(-1) 6.1212	(-1) 5.8278	(-1) 5.5346	(-1) 5.2436	(-1) 4.9566	(-1) 4.6753
1.3	(-1) 5.9576	(-1) 5.6576	(-1) 5.3596	(-1) 5.0655	(-1) 4.7769	(-1) 4.4953	(-1) 4.2217
1.4	(-1) 5.5101	(-1) 5.2066	(-1) 4.9087	(-1) 4.6178	(-1) 4.3352	(-1) 4.0619	(-1) 3.7986
1.5	(-1) 5.0730	(-1) 4.7706	(-1) 4.4769	(-1) 4.1927	(-1) 3.9191	(-1) 3.6565	(-1) 3.4055
1.6	(-1) 4.6492	(-1) 4.3519	(-1) 4.0657	(-1) 3.7912	(-1) 3.5288	(-1) 3.2790	(-1) 3.0417
1.7	(-1) 4.2412	(-1) 3.9524	(-1) 3.6765	(-1) 3.4139	(-1) 3.1647	(-1) 2.9290	(-1) 2.7065
1.8	(-1) 3.8510	(-1) 3.5734	(-1) 3.3102	(-1) 3.0613	(-1) 2.8266	(-1) 2.6060	(-1) 2.3990
1.9	(-1) 3.4805	(-1) 3.2162	(-1) 2.9673	(-1) 2.7334	(-1) 2.5142	(-1) 2.3093	(-1) 2.1181
2.0	(-1) 3.1309	(-1) 2.8816	(-1) 2.6482	(-1) 2.4302	(-1) 2.2270	(-1) 2.0381	(-1) 1.8627
2.1	(-1) 2.8032	(-1) 2.5700	(-1) 2.3529	(-1) 2.1513	(-1) 1.9643	(-1) 1.7913	(-1) 1.6315
2.2	(-1) 2.4980	(-1) 2.2816	(-1) 2.0812	(-1) 1.8960	(-1) 1.7252	(-1) 1.5678	(-1) 1.4232
2.3	(-1) 2.2155	(-1) 2.0162	(-1) 1.8326	(-1) 1.6637	(-1) 1.5086	(-1) 1.3665	(-1) 1.2363
2.4	(-1) 1.9556	(-1) 1.7734	(-1) 1.6064	(-1) 1.4534	(-1) 1.3136	(-1) 1.1859	(-1) 1.0695
2.5	(-1) 1.7179	(-1) 1.5526	(-1) 1.4017	(-1) 1.2640	(-1) 1.1387	(-1) 1.0248	(-2) 9.2134
2.6	(-1) 1.5020	(-1) 1.3529	(-1) 1.2174	(-1) 1.0944	(-2) 9.8278	(-2) 8.8173	(-2) 7.9031
2.7	(-1) 1.3069	(-1) 1.1734	(-1) 1.0525	(-2) 9.4322	(-2) 8.4445	(-2) 7.5534	(-2) 6.7502
2.8	(-1) 1.1317	(-1) 1.0129	(-2) 9.0579	(-2) 8.0925	(-2) 7.2235	(-2) 6.4422	(-2) 5.7406
2.9	(-2) 9.7528	(-2) 8.7027	(-2) 7.7589	(-2) 6.9114	(-2) 6.1513	(-2) 5.4703	(-2) 4.8608
3.0	(-2) 8.3643	(-2) 7.4416	(-2) 6.6151	(-2) 5.8757	(-2) 5.2146	(-2) 4.6244	(-2) 4.0978
3.1	(-2) 7.1389	(-2) 6.3330	(-2) 5.6137	(-2) 4.9721	(-2) 4.4006	(-2) 3.8918	(-2) 3.4393
3.2	(-2) 6.0636	(-2) 5.3640	(-2) 4.7415	(-2) 4.1881	(-2) 3.6967	(-2) 3.2606	(-2) 2.8739
3.3	(-2) 5.1253	(-2) 4.5215	(-2) 3.9860	(-2) 3.5114	(-2) 3.0912	(-2) 2.7194	(-2) 2.3907
3.4	(-2) 4.3112	(-2) 3.7932	(-2) 3.3351	(-2) 2.9303	(-2) 2.5730	(-2) 2.2577	(-2) 1.9799
3.5	(-2) 3.6089	(-2) 3.1669	(-2) 2.7772	(-2) 2.4340	(-2) 2.1318	(-2) 1.8659	(-2) 1.6322
3.6	(-2) 3.0063	(-2) 2.6314	(-2) 2.3018	(-2) 2.0122	(-2) 1.7580	(-2) 1.5351	(-2) 1.3396
3.7	(-2) 2.4921	(-2) 2.1759	(-2) 1.8986	(-2) 1.6558	(-2) 1.4431	(-2) 1.2571	(-2) 1.0944
3.8	(-2) 2.0558	(-2) 1.7906	(-2) 1.5587	(-2) 1.3560	(-2) 1.1791	(-2) 1.0247	(-3) 8.9001
3.9	(-2) 1.6876	(-2) 1.4664	(-2) 1.2735	(-2) 1.1053	(-3) 9.5887	(-3) 8.3139	(-3) 7.2048
4.0	(-2) 1.3786	(-2) 1.1951	(-2) 1.0355	(-3) 8.9669	(-3) 7.7613	(-3) 6.7143	(-3) 5.8057
4.1	(-2) 1.1207	(-3) 9.6928	(-3) 8.3792	(-3) 7.2400	(-3) 6.2526	(-3) 5.3973	(-3) 4.6568
4.2	(-3) 9.0656	(-3) 7.8234	(-3) 6.7481	(-3) 5.8179	(-3) 5.0135	(-3) 4.3184	(-3) 3.7179
4.3	(-3) 7.2976	(-3) 6.2839	(-3) 5.4085	(-3) 4.6529	(-3) 4.0011	(-3) 3.4390	(-3) 2.9546
4.4	(-3) 5.8457	(-3) 5.0228	(-3) 4.3139	(-3) 3.7034	(-3) 3.1779	(-3) 2.7259	(-3) 2.3371
4.5	(-3) 4.6596	(-3) 3.9954	(-3) 3.4243	(-3) 2.9336	(-3) 2.5122	(-3) 2.1504	(-3) 1.8400
4.6	(-3) 3.6961	(-3) 3.1626	(-3) 2.7050	(-3) 2.3127	(-3) 1.9765	(-3) 1.6885	(-3) 1.4419
4.7	(-3) 2.9173	(-3) 2.4912	(-3) 2.1265	(-3) 1.8145	(-3) 1.5477	(-3) 1.3195	(-3) 1.1246
4.8	(-3) 2.2914	(-3) 1.9528	(-3) 1.6637	(-3) 1.4168	(-3) 1.2061	(-3) 1.0263	(-4) 8.7305
4.9	(-3) 1.7909	(-3) 1.5233	(-3) 1.2952	(-3) 1.1009	(-4) 9.3540	(-4) 7.9449	(-4) 6.7457
5.0	(-3) 1.3929	(-3) 1.1825	(-3) 1.0035	(-4) 8.5136	(-4) 7.2201	(-4) 6.1210	(-4) 5.1875

Table 19.1

x	$V(-0.3, x)$	$V(-0.2, x)$	$V(-0.1, x)$	$V(0, x)$	$V(0.1, x)$	$V(0.2, x)$	$V(0.3, x)$
0.0	(-1) 3.0993	(-1) 4.5280	(-1) 5.7994	(-1) 6.8621	(-1) 7.6731	(-1) 8.2008	(-1) 8.4269
0.1	(-1) 3.7442	(-1) 5.0724	(-1) 6.2358	(-1) 7.1901	(-1) 7.9000	(-1) 8.3406	(-1) 8.5002
0.2	(-1) 4.3780	(-1) 5.6069	(-1) 6.6661	(-1) 7.5184	(-1) 8.1349	(-1) 8.4974	(-1) 8.5993
0.3	(-1) 4.9991	(-1) 6.1307	(-1) 7.0905	(-1) 7.8474	(-1) 8.3788	(-1) 8.6720	(-1) 8.7250
0.4	(-1) 5.6064	(-1) 6.6436	(-1) 7.5093	(-1) 8.1782	(-1) 8.6331	(-1) 8.8660	(-1) 8.8790
0.5	(-1) 6.1992	(-1) 7.1460	(-1) 7.9238	(-1) 8.5124	(-1) 8.8994	(-1) 9.0813	(-1) 9.0632
0.6	(-1) 6.7773	(-1) 7.6386	(-1) 8.3353	(-1) 8.8519	(-1) 9.1803	(-1) 9.3205	(-1) 9.2803
0.7	(-1) 7.3412	(-1) 8.1229	(-1) 8.7460	(-1) 9.1994	(-1) 9.4787	(-1) 9.5867	(-1) 9.5336
0.8	(-1) 7.8922	(-1) 8.6009	(-1) 9.1588	(-1) 9.5583	(-1) 9.7982	(-1) 9.8840	(-1) 9.8273
0.9	(-1) 8.4321	(-1) 9.0756	(-1) 9.5771	(-1) 9.9325	(0) 1.0143	(0) 1.0217	(0) 1.0166
1.0	(-1) 8.9640	(-1) 9.5505	(0) 1.0005	(0) 1.0327	(0) 1.0519	(0) 1.0591	(0) 1.0556
1.1	(-1) 9.4914	(0) 1.0030	(0) 1.0449	(0) 1.0747	(0) 1.0932	(0) 1.1013	(0) 1.1005
1.2	(0) 1.0019	(0) 1.0521	(0) 1.0923	(0) 1.1200	(0) 1.1389	(0) 1.1490	(0) 1.1520
1.3	(0) 1.0553	(0) 1.1028	(0) 1.1406	(0) 1.1693	(0) 1.1898	(0) 1.2032	(0) 1.2110
1.4	(0) 1.1100	(0) 1.1559	(0) 1.1936	(0) 1.2236	(0) 1.2470	(0) 1.2649	(0) 1.2789
1.5	(0) 1.1668	(0) 1.2125	(0) 1.2513	(0) 1.2839	(0) 1.3115	(0) 1.3353	(0) 1.3569
1.6	(0) 1.2267	(0) 1.2734	(0) 1.3147	(0) 1.3515	(0) 1.3848	(0) 1.4160	(0) 1.4466
1.7	(0) 1.2908	(0) 1.3400	(0) 1.3853	(0) 1.4277	(0) 1.4683	(0) 1.5085	(0) 1.5499
1.8	(0) 1.3603	(0) 1.4136	(0) 1.4645	(0) 1.5142	(0) 1.5639	(0) 1.6150	(0) 1.6692
1.9	(0) 1.4368	(0) 1.4958	(0) 1.5542	(0) 1.6130	(0) 1.6738	(0) 1.7379	(0) 1.8070
2.0	(0) 1.5220	(0) 1.5886	(0) 1.6563	(0) 1.7265	(0) 1.8005	(0) 1.8799	(0) 1.9665
2.1	(0) 1.6178	(0) 1.6941	(0) 1.7734	(0) 1.8572	(0) 1.9470	(0) 2.0446	(0) 2.1517
2.2	(0) 1.7267	(0) 1.8149	(0) 1.9083	(0) 2.0085	(0) 2.1171	(0) 2.2360	(0) 2.3672
2.3	(0) 1.8513	(0) 1.9541	(0) 2.0645	(0) 2.1841	(0) 2.3149	(0) 2.4589	(0) 2.6185
2.4	(0) 1.9950	(0) 2.1153	(0) 2.2459	(0) 2.3887	(0) 2.5457	(0) 2.7195	(0) 2.9124
2.5	(0) 2.1614	(0) 2.3028	(0) 2.4576	(0) 2.6278	(0) 2.8159	(0) 3.0247	(0) 3.2572
2.6	(0) 2.3551	(0) 2.5218	(0) 2.7053	(0) 2.9080	(0) 3.1330	(0) 3.3834	(0) 3.6627
2.7	(0) 2.5818	(0) 2.7785	(0) 2.9961	(0) 3.2376	(0) 3.5064	(0) 3.8063	(0) 4.1415
2.8	(0) 2.8478	(0) 3.0803	(0) 3.3387	(0) 3.6263	(0) 3.9474	(0) 4.3064	(0) 4.7084
2.9	(0) 3.1612	(0) 3.4366	(0) 3.7435	(0) 4.0864	(0) 4.4700	(0) 4.8998	(0) 5.3820
3.0	(0) 3.5318	(0) 3.8584	(0) 4.2236	(0) 4.6326	(0) 5.0914	(0) 5.6065	(0) 6.1855
3.1	(0) 3.9715	(0) 4.3596	(0) 4.7948	(0) 5.2835	(0) 5.8328	(0) 6.4510	(0) 7.1472
3.2	(0) 4.4950	(0) 4.9572	(0) 5.4768	(0) 6.0617	(0) 6.7208	(0) 7.4640	(0) 8.3029
3.3	(0) 5.1205	(0) 5.6722	(0) 6.2941	(0) 6.9957	(0) 7.7882	(0) 8.6838	(0) 9.6969
3.4	(0) 5.8704	(0) 6.5308	(0) 7.2770	(0) 8.1210	(0) 9.0763	(1) 1.0158	(1) 1.1385
3.5	(0) 6.7730	(0) 7.5658	(0) 8.4638	(0) 9.4818	(1) 1.0637	(1) 1.1948	(1) 1.3438
3.6	(0) 7.8635	(0) 8.8182	(0) 9.9023	(1) 1.1134	(1) 1.2535	(1) 1.4130	(1) 1.5945
3.7	(0) 9.1860	(1) 1.0340	(1) 1.1653	(1) 1.3149	(1) 1.4854	(1) 1.6799	(1) 1.9019
3.8	(1) 1.0797	(1) 1.2196	(1) 1.3793	(1) 1.5616	(1) 1.7699	(1) 2.0080	(1) 2.2804
3.9	(1) 1.2766	(1) 1.4470	(1) 1.6419	(1) 1.8649	(1) 2.1203	(1) 2.4130	(1) 2.7486
4.0	(1) 1.5185	(1) 1.7268	(1) 1.9656	(1) 2.2395	(1) 2.5539	(1) 2.9150	(1) 3.3300
4.1	(1) 1.8169	(1) 2.0725	(1) 2.3663	(1) 2.7041	(1) 3.0927	(1) 3.5401	(1) 4.0554
4.2	(1) 2.1864	(1) 2.5016	(1) 2.8646	(1) 3.2829	(1) 3.7653	(1) 4.3219	(1) 4.9644
4.3	(1) 2.6464	(1) 3.0366	(1) 3.4870	(1) 4.0073	(1) 4.6086	(1) 5.3040	(1) 6.1085
4.4	(1) 3.2213	(1) 3.7065	(1) 4.2680	(1) 4.9179	(1) 5.6708	(1) 6.5433	(1) 7.5550
4.5	(1) 3.9432	(1) 4.5494	(1) 5.2524	(1) 6.0680	(1) 7.0147	(1) 8.1143	(1) 9.3921
4.6	(1) 4.8541	(1) 5.6148	(1) 6.4990	(1) 7.5270	(1) 8.7230	(2) 1.0115	(2) 1.1736
4.7	(1) 6.0085	(1) 6.9677	(1) 8.0849	(1) 9.3866	(2) 1.0904	(2) 1.2674	(2) 1.4740
4.8	(1) 7.4787	(1) 8.6937	(2) 1.0112	(2) 1.1768	(2) 1.3703	(2) 1.5964	(2) 1.8608
4.9	(1) 9.3598	(2) 1.0906	(2) 1.2715	(2) 1.4831	(2) 1.7309	(2) 2.0211	(2) 2.3611
5.0	(2) 1.1778	(2) 1.3756	(2) 1.6073	(2) 1.8791	(2) 2.1979	(2) 2.5720	(2) 3.0112

Table 19.1

x	$U(0.4, x)$	$U(0.5, x)$	$U(0.6, x)$	$U(0.7, x)$	$U(0.8, x)$	$U(0.9, x)$	$U(1.0, x)$
0.0	(0) 1.2579	(0) 1.2533	(0) 1.2436	(0) 1.2292	(0) 1.2106	(0) 1.1883	(0) 1.1627
0.1	(0) 1.1672	(0) 1.1564	(0) 1.1413	(0) 1.1223	(0) 1.1000	(0) 1.0746	(0) 1.0467
0.2	(0) 1.0811	(0) 1.0652	(0) 1.0458	(0) 1.0233	(-1) 9.9813	(-1) 9.7063	(-1) 9.4122
0.3	(-1) 9.9946	(-1) 9.7955	(-1) 9.5680	(-1) 9.3162	(-1) 9.0440	(-1) 8.7549	(-1) 8.4523
0.4	(-1) 9.2205	(-1) 8.9898	(-1) 8.7372	(-1) 8.4665	(-1) 8.1811	(-1) 7.8843	(-1) 7.5790
0.5	(-1) 8.4870	(-1) 8.2327	(-1) 7.9624	(-1) 7.6795	(-1) 7.3870	(-1) 7.0879	(-1) 6.7845
0.6	(-1) 7.7928	(-1) 7.5219	(-1) 7.2403	(-1) 6.9511	(-1) 6.6567	(-1) 6.3597	(-1) 6.0622
0.7	(-1) 7.1368	(-1) 6.8555	(-1) 6.5683	(-1) 6.2776	(-1) 5.9857	(-1) 5.6945	(-1) 5.4060
0.8	(-1) 6.5181	(-1) 6.2318	(-1) 5.9437	(-1) 5.6558	(-1) 5.3699	(-1) 5.0877	(-1) 4.8105
0.9	(-1) 5.9358	(-1) 5.6493	(-1) 5.3643	(-1) 5.0826	(-1) 4.8057	(-1) 4.5347	(-1) 4.2709
1.0	(-1) 5.3894	(-1) 5.1064	(-1) 4.8280	(-1) 4.5553	(-1) 4.2896	(-1) 4.0318	(-1) 3.7826
1.1	(-1) 4.8780	(-1) 4.6019	(-1) 4.3327	(-1) 4.0713	(-1) 3.8187	(-1) 3.5753	(-1) 3.3417
1.2	(-1) 4.4008	(-1) 4.1343	(-1) 3.8765	(-1) 3.6282	(-1) 3.3898	(-1) 3.1618	(-1) 2.9443
1.3	(-1) 3.9571	(-1) 3.7022	(-1) 3.4575	(-1) 3.2235	(-1) 3.0003	(-1) 2.7881	(-1) 2.5870
1.4	(-1) 3.5459	(-1) 3.3042	(-1) 3.0739	(-1) 2.8550	(-1) 2.6475	(-1) 2.4514	(-1) 2.2665
1.5	(-1) 3.1663	(-1) 2.9390	(-1) 2.7238	(-1) 2.5204	(-1) 2.3288	(-1) 2.1487	(-1) 1.9797
1.6	(-1) 2.8171	(-1) 2.6050	(-1) 2.4053	(-1) 2.2177	(-1) 2.0419	(-1) 1.8774	(-1) 1.7240
1.7	(-1) 2.4972	(-1) 2.3007	(-1) 2.1167	(-1) 1.9447	(-1) 1.7844	(-1) 1.6351	(-1) 1.4965
1.8	(-1) 2.2054	(-1) 2.0246	(-1) 1.8561	(-1) 1.6994	(-1) 1.5540	(-1) 1.4193	(-1) 1.2948
1.9	(-1) 1.9402	(-1) 1.7749	(-1) 1.6216	(-1) 1.4798	(-1) 1.3487	(-1) 1.2278	(-1) 1.1165
2.0	(-1) 1.7003	(-1) 1.5501	(-1) 1.4115	(-1) 1.2838	(-1) 1.1664	(-1) 1.0585	(-2) 9.5952
2.1	(-1) 1.4842	(-1) 1.3486	(-1) 1.2240	(-1) 1.1097	(-1) 1.0050	(-2) 9.0923	(-2) 8.2173
2.2	(-1) 1.2904	(-1) 1.1687	(-1) 1.0574	(-2) 9.5563	(-2) 8.6280	(-2) 7.7820	(-2) 7.0122
2.3	(-1) 1.1174	(-1) 1.0088	(-2) 9.0985	(-2) 8.1979	(-2) 7.3793	(-2) 6.6361	(-2) 5.9622
2.4	(-2) 9.6358	(-2) 8.6728	(-2) 7.7984	(-2) 7.0055	(-2) 6.2874	(-2) 5.6377	(-2) 5.0508
2.5	(-2) 8.2754	(-2) 7.4258	(-2) 6.6573	(-2) 5.9630	(-2) 5.3363	(-2) 4.7714	(-2) 4.2627
2.6	(-2) 7.0773	(-2) 6.3320	(-2) 5.6603	(-2) 5.0555	(-2) 4.5115	(-2) 4.0227	(-2) 3.5839
2.7	(-2) 6.0272	(-2) 5.3770	(-2) 4.7930	(-2) 4.2689	(-2) 3.7990	(-2) 3.3782	(-2) 3.0017
2.8	(-2) 5.1111	(-2) 4.5470	(-2) 4.0418	(-2) 3.5900	(-2) 3.1863	(-2) 2.8258	(-2) 2.5042
2.9	(-2) 4.3157	(-2) 3.8288	(-2) 3.3942	(-2) 3.0068	(-2) 2.6615	(-2) 2.3543	(-2) 2.0810
3.0	(-2) 3.6284	(-2) 3.2104	(-2) 2.8384	(-2) 2.5078	(-2) 2.2142	(-2) 1.9535	(-2) 1.7224
3.1	(-2) 3.0372	(-2) 2.6803	(-2) 2.3636	(-2) 2.0830	(-2) 1.8344	(-2) 1.6144	(-2) 1.4199
3.2	(-2) 2.5313	(-2) 2.2281	(-2) 1.9598	(-2) 1.7228	(-2) 1.5134	(-2) 1.3287	(-2) 1.1658
3.3	(-2) 2.1004	(-2) 1.8441	(-2) 1.6181	(-2) 1.4189	(-2) 1.2434	(-2) 1.0890	(-3) 9.5318
3.4	(-2) 1.7351	(-2) 1.5196	(-2) 1.3301	(-2) 1.1636	(-2) 1.0172	(-3) 8.8881	(-3) 7.7615
3.5	(-2) 1.4270	(-2) 1.2468	(-2) 1.0887	(-3) 9.5009	(-3) 8.2868	(-3) 7.2238	(-3) 6.2937
3.6	(-2) 1.1683	(-2) 1.0184	(-3) 8.8715	(-3) 7.7243	(-3) 6.7217	(-3) 5.8462	(-3) 5.0820
3.7	(-3) 9.5224	(-3) 8.2810	(-3) 7.1975	(-3) 6.2525	(-3) 5.4288	(-3) 4.7111	(-3) 4.0863
3.8	(-3) 7.7263	(-3) 6.7038	(-3) 5.8136	(-3) 5.0391	(-3) 4.3655	(-3) 3.7801	(-3) 3.2716
3.9	(-3) 6.2406	(-3) 5.4026	(-3) 4.6749	(-3) 4.0432	(-3) 3.4952	(-3) 3.0200	(-3) 2.6082
4.0	(-3) 5.0176	(-3) 4.3344	(-3) 3.7425	(-3) 3.2298	(-3) 2.7861	(-3) 2.4023	(-3) 2.0704
4.1	(-3) 4.0160	(-3) 3.4617	(-3) 2.9826	(-3) 2.5686	(-3) 2.2111	(-3) 1.9025	(-3) 1.6363
4.2	(-3) 3.1995	(-3) 2.7521	(-3) 2.3663	(-3) 2.0336	(-3) 1.7470	(-3) 1.5001	(-3) 1.2876
4.3	(-3) 2.5373	(-3) 2.1781	(-3) 1.8689	(-3) 1.6029	(-3) 1.3742	(-3) 1.1776	(-3) 1.0088
4.4	(-3) 2.0029	(-3) 1.7158	(-3) 1.4693	(-3) 1.2577	(-3) 1.0761	(-4) 9.2036	(-4) 7.8686
4.5	(-3) 1.5738	(-3) 1.3455	(-3) 1.1499	(-4) 9.8235	(-4) 8.3889	(-4) 7.1610	(-4) 6.1105
4.6	(-3) 1.2308	(-3) 1.0503	(-4) 8.9583	(-4) 7.6382	(-4) 6.5103	(-4) 5.5468	(-4) 4.7242
4.7	(-4) 9.5815	(-4) 8.1601	(-4) 6.9470	(-4) 5.9121	(-4) 5.0295	(-4) 4.2772	(-4) 3.6361
4.8	(-4) 7.4240	(-4) 6.3107	(-4) 5.3625	(-4) 4.5551	(-4) 3.8680	(-4) 3.2833	(-4) 2.7861
4.9	(-4) 5.7255	(-4) 4.8579	(-4) 4.1203	(-4) 3.4935	(-4) 2.9611	(-4) 2.5090	(-4) 2.1252
5.0	(-4) 4.3948	(-4) 3.7221	(-4) 3.1512	(-4) 2.6671	(-4) 2.2566	(-4) 1.9086	(-4) 1.6138

Table 19.1

x	$V(0.4, x)$	$V(0.5, x)$	$V(0.6, x)$	$V(0.7, x)$	$V(0.8, x)$	$V(0.9, x)$	$V(1.0, x)$
0.0	(-1) 8.3485	(-1) 7.9788	(-1) 7.3474	(-1) 6.4988	(-1) 5.4912	(-1) 4.3932	(-1) 3.2800
0.1	(-1) 8.3808	(-1) 7.9988	(-1) 7.3851	(-1) 6.5836	(-1) 5.6492	(-1) 4.6453	(-1) 3.6401
0.2	(-1) 8.4468	(-1) 8.0590	(-1) 7.4675	(-1) 6.7147	(-1) 5.8526	(-1) 4.9394	(-1) 4.0368
0.3	(-1) 8.5475	(-1) 8.1604	(-1) 7.5954	(-1) 6.8936	(-1) 6.1035	(-1) 5.2785	(-1) 4.4742
0.4	(-1) 8.6844	(-1) 8.3045	(-1) 7.7707	(-1) 7.1224	(-1) 6.4046	(-1) 5.6664	(-1) 4.9575
0.5	(-1) 8.8595	(-1) 8.4934	(-1) 7.9958	(-1) 7.4039	(-1) 6.7596	(-1) 6.1076	(-1) 5.4924
0.6	(-1) 9.0757	(-1) 8.7302	(-1) 8.2739	(-1) 7.7419	(-1) 7.1730	(-1) 6.6077	(-1) 6.0858
0.7	(-1) 9.3364	(-1) 9.0186	(-1) 8.6092	(-1) 8.1412	(-1) 7.6504	(-1) 7.1733	(-1) 6.7457
0.8	(-1) 9.6460	(-1) 9.3633	(-1) 9.0068	(-1) 8.6076	(-1) 8.1984	(-1) 7.8124	(-1) 7.4814
0.9	(0) 1.0010	(-1) 9.7698	(-1) 9.4730	(-1) 9.1481	(-1) 8.8253	(-1) 8.5344	(-1) 8.3040
1.0	(0) 1.0434	(0) 1.0245	(0) 1.0015	(-1) 9.7713	(-1) 9.5408	(-1) 9.3507	(-1) 9.2267
1.1	(0) 1.0926	(0) 1.0797	(0) 1.0643	(0) 1.0488	(0) 1.0357	(0) 1.0275	(0) 1.0265
1.2	(0) 1.1495	(0) 1.1436	(0) 1.1367	(0) 1.1309	(0) 1.1287	(0) 1.1323	(0) 1.1437
1.3	(0) 1.2151	(0) 1.2174	(0) 1.2200	(0) 1.2251	(0) 1.2348	(0) 1.2514	(0) 1.2765
1.4	(0) 1.2908	(0) 1.3024	(0) 1.3158	(0) 1.3330	(0) 1.3561	(0) 1.3870	(0) 1.4276
1.5	(0) 1.3779	(0) 1.4003	(0) 1.4260	(0) 1.4569	(0) 1.4949	(0) 1.5420	(0) 1.5999
1.6	(0) 1.4784	(0) 1.5132	(0) 1.5528	(0) 1.5992	(0) 1.6542	(0) 1.7196	(0) 1.7973
1.7	(0) 1.5943	(0) 1.6433	(0) 1.6989	(0) 1.7629	(0) 1.8373	(0) 1.9238	(0) 2.0243
1.8	(0) 1.7281	(0) 1.7936	(0) 1.8675	(0) 1.9518	(0) 2.0484	(0) 2.1592	(0) 2.2862
1.9	(0) 1.8829	(0) 1.9674	(0) 2.0625	(0) 2.1703	(0) 2.2926	(0) 2.4317	(0) 2.5896
2.0	(0) 2.0622	(0) 2.1689	(0) 2.2886	(0) 2.4236	(0) 2.5760	(0) 2.7481	(0) 2.9424
2.1	(0) 2.2705	(0) 2.4030	(0) 2.5514	(0) 2.7182	(0) 2.9058	(0) 3.1169	(0) 3.3542
2.2	(0) 2.5130	(0) 2.6757	(0) 2.8578	(0) 3.0620	(0) 3.2911	(0) 3.5483	(0) 3.8368
2.3	(0) 2.7961	(0) 2.9943	(0) 3.2160	(0) 3.4644	(0) 3.7428	(0) 4.0548	(0) 4.4044
2.4	(0) 3.1275	(0) 3.3676	(0) 3.6363	(0) 3.9371	(0) 4.2741	(0) 4.6517	(0) 5.0747
2.5	(0) 3.5166	(0) 3.8065	(0) 4.1310	(0) 4.4944	(0) 4.9015	(0) 5.3578	(0) 5.8692
2.6	(0) 3.9749	(0) 4.3241	(0) 4.7153	(0) 5.1536	(0) 5.6451	(0) 6.1963	(0) 6.8146
2.7	(0) 4.5165	(0) 4.9368	(0) 5.4079	(0) 5.9365	(0) 6.5297	(0) 7.1959	(0) 7.9440
2.8	(0) 5.1589	(0) 5.6644	(0) 6.2320	(0) 6.8696	(0) 7.5862	(0) 8.3921	(0) 9.2985
2.9	(0) 5.9235	(0) 6.5320	(0) 7.2162	(0) 7.9862	(0) 8.8529	(0) 9.8292	(1) 1.0929
3.0	(0) 6.8368	(0) 7.5701	(0) 8.3962	(0) 9.3274	(1) 1.0378	(1) 1.1563	(1) 1.2900
3.1	(0) 7.9320	(0) 8.8172	(0) 9.8164	(1) 1.0945	(1) 1.2220	(1) 1.3662	(1) 1.5293
3.2	(0) 9.2504	(1) 1.0321	(1) 1.1533	(1) 1.2903	(1) 1.4455	(1) 1.6214	(1) 1.8207
3.3	(1) 1.0844	(1) 1.2142	(1) 1.3615	(1) 1.5284	(1) 1.7178	(1) 1.9329	(1) 2.1773
3.4	(1) 1.2777	(1) 1.4357	(1) 1.6151	(1) 1.8190	(1) 2.0509	(1) 2.3148	(1) 2.6153
3.5	(1) 1.5132	(1) 1.7060	(1) 1.9253	(1) 2.1752	(1) 2.4601	(1) 2.7849	(1) 3.1555
3.6	(1) 1.8014	(1) 2.0373	(1) 2.3064	(1) 2.6137	(1) 2.9646	(1) 3.3658	(1) 3.8246
3.7	(1) 2.1555	(1) 2.4452	(1) 2.7765	(1) 3.1556	(1) 3.5896	(1) 4.0868	(1) 4.6566
3.8	(1) 2.5923	(1) 2.9495	(1) 3.3588	(1) 3.8282	(1) 4.3669	(1) 4.9853	(1) 5.6956
3.9	(1) 3.1336	(1) 3.5756	(1) 4.0833	(1) 4.6667	(1) 5.3377	(1) 6.1098	(1) 6.9986
4.0	(1) 3.8072	(1) 4.3563	(1) 4.9884	(1) 5.7165	(1) 6.5556	(1) 7.5232	(1) 8.6395
4.1	(1) 4.6493	(1) 5.3341	(1) 6.1242	(1) 7.0364	(1) 8.0899	(1) 9.3073	(2) 1.0715
4.2	(1) 5.7065	(1) 6.5642	(1) 7.5559	(1) 8.7031	(2) 1.0031	(2) 1.1569	(2) 1.3351
4.3	(1) 7.0397	(1) 8.1183	(1) 9.3682	(2) 1.0817	(2) 1.2498	(2) 1.4449	(2) 1.6714
4.4	(1) 8.7286	(2) 1.0091	(2) 1.1673	(2) 1.3511	(2) 1.5647	(2) 1.8131	(2) 2.1022
4.5	(2) 1.0878	(2) 1.2605	(2) 1.4616	(2) 1.6957	(2) 1.9684	(2) 2.2861	(2) 2.6566
4.6	(2) 1.3624	(2) 1.5826	(2) 1.8392	(2) 2.1387	(2) 2.4882	(2) 2.8963	(2) 3.3731
4.7	(2) 1.7151	(2) 1.9968	(2) 2.3259	(2) 2.7106	(2) 3.1606	(2) 3.6870	(2) 4.3032
4.8	(2) 2.1701	(2) 2.5321	(2) 2.9559	(2) 3.4524	(2) 4.0341	(2) 4.7161	(2) 5.5160
4.9	(2) 2.7596	(2) 3.2270	(2) 3.7752	(2) 4.4187	(2) 5.1742	(2) 6.0616	(2) 7.1043
5.0	(2) 3.5270	(2) 4.1331	(2) 4.8456	(2) 5.6833	(2) 6.6688	(2) 7.8285	(2) 9.1938

Table 19.1

x	$U(1.5, x)$	$U(2.0, x)$	$U(2.5, x)$	$U(3.0, x)$	$U(3.5, x)$	$U(4.0, x)$	$U(4.5, x)$	$U(5.0, x)$
0.0	(0) 1.0000	(-1) 8.1085	(-1) 6.2666	(-1) 4.6509	(-1) 3.3333	(-1) 2.3167	(-1) 1.5666	(-1) 1.0335
0.1	(-1) 8.8187	(-1) 7.0232	(-1) 5.3409	(-1) 3.9060	(-1) 2.7615	(-1) 1.8950	(-1) 1.2662	(-2) 8.2588
0.2	(-1) 7.7700	(-1) 6.0787	(-1) 4.5492	(-1) 3.2786	(-1) 2.2867	(-1) 1.5494	(-1) 1.0230	(-2) 6.5971
0.3	(-1) 6.8389	(-1) 5.2566	(-1) 3.8719	(-1) 2.7501	(-1) 1.8924	(-1) 1.2662	(-2) 8.2604	(-2) 5.2673
0.4	(-1) 6.0120	(-1) 4.5410	(-1) 3.2925	(-1) 2.3050	(-1) 1.5650	(-1) 1.0340	(-2) 6.6663	(-2) 4.2032
0.5	(-1) 5.2778	(-1) 3.9182	(-1) 2.7969	(-1) 1.9302	(-1) 1.2931	(-2) 8.4374	(-2) 5.3758	(-2) 3.3518
0.6	(-1) 4.6262	(-1) 3.3763	(-1) 2.3731	(-1) 1.6146	(-1) 1.0674	(-2) 6.8788	(-2) 4.3316	(-2) 2.6707
0.7	(-1) 4.0482	(-1) 2.9051	(-1) 2.0109	(-1) 1.3490	(-2) 8.8019	(-2) 5.6025	(-2) 3.4869	(-2) 2.1262
0.8	(-1) 3.5360	(-1) 2.4957	(-1) 1.7015	(-1) 1.1256	(-2) 7.2491	(-2) 4.5579	(-2) 2.8040	(-2) 1.6910
0.9	(-1) 3.0825	(-1) 2.1403	(-1) 1.4375	(-2) 9.3785	(-2) 5.9624	(-2) 3.7035	(-2) 2.2523	(-2) 1.3434
1.0	(-1) 2.6816	(-1) 1.8321	(-1) 1.2124	(-2) 7.8022	(-2) 4.8971	(-2) 3.0053	(-2) 1.8068	(-2) 1.0660
1.1	(-1) 2.3276	(-1) 1.5651	(-1) 1.0208	(-2) 6.4802	(-2) 4.0160	(-2) 2.4351	(-2) 1.4475	(-3) 8.4479
1.2	(-1) 2.0157	(-1) 1.3343	(-2) 8.5773	(-2) 5.3727	(-2) 3.2880	(-2) 1.9701	(-2) 1.1579	(-3) 6.6856
1.3	(-1) 1.7412	(-1) 1.1350	(-2) 7.1928	(-2) 4.4461	(-2) 2.6872	(-2) 1.5913	(-3) 9.2486	(-3) 5.2831
1.4	(-1) 1.5003	(-2) 9.6317	(-2) 6.0190	(-2) 3.6721	(-2) 2.1922	(-2) 1.2831	(-3) 7.3749	(-3) 4.1683
1.5	(-1) 1.2893	(-2) 8.1541	(-2) 5.0255	(-2) 3.0265	(-2) 1.7849	(-2) 1.0327	(-3) 5.8705	(-3) 3.2833
1.6	(-1) 1.1049	(-2) 6.8857	(-2) 4.1862	(-2) 2.4890	(-2) 1.4503	(-3) 8.2953	(-3) 4.6645	(-3) 2.5816
1.7	(-2) 9.4412	(-2) 5.7994	(-2) 3.4786	(-2) 2.0423	(-2) 1.1759	(-3) 6.6500	(-3) 3.6991	(-3) 2.0262
1.8	(-2) 8.0438	(-2) 4.8712	(-2) 2.8833	(-2) 1.6718	(-3) 9.5127	(-3) 5.3198	(-3) 2.9276	(-3) 1.5873
1.9	(-2) 6.8324	(-2) 4.0801	(-2) 2.3837	(-2) 1.3652	(-3) 7.6780	(-3) 4.2463	(-3) 2.3122	(-3) 1.2409
2.0	(-2) 5.7853	(-2) 3.4076	(-2) 1.9653	(-2) 1.1120	(-3) 6.1823	(-3) 3.3818	(-3) 1.8222	(-4) 9.6810
2.1	(-2) 4.8830	(-2) 2.8375	(-2) 1.6159	(-3) 9.0339	(-3) 4.9656	(-3) 2.6869	(-3) 1.4328	(-4) 7.5364
2.2	(-2) 4.1080	(-2) 2.3556	(-2) 1.3248	(-3) 7.3193	(-3) 3.9782	(-3) 2.1296	(-3) 1.1240	(-4) 5.8538
2.3	(-2) 3.4444	(-2) 1.9495	(-2) 1.0829	(-3) 5.9138	(-3) 3.1787	(-3) 1.6837	(-4) 8.7960	(-4) 4.5364
2.4	(-2) 2.8782	(-2) 1.6082	(-3) 8.8260	(-3) 4.7646	(-3) 2.5331	(-3) 1.3277	(-4) 6.8665	(-4) 3.5071
2.5	(-2) 2.3966	(-2) 1.3223	(-3) 7.1710	(-3) 3.8275	(-3) 2.0129	(-3) 1.0442	(-4) 5.3467	(-4) 2.7047
2.6	(-2) 1.9886	(-2) 1.0837	(-3) 5.8081	(-3) 3.0655	(-3) 1.5951	(-4) 8.1895	(-4) 4.1523	(-4) 2.0806
2.7	(-2) 1.6441	(-3) 8.8509	(-3) 4.6891	(-3) 2.4478	(-3) 1.2603	(-4) 6.4052	(-4) 3.2161	(-4) 1.5964
2.8	(-2) 1.3544	(-3) 7.2040	(-3) 3.7734	(-3) 1.9484	(-4) 9.9277	(-4) 4.9954	(-4) 2.4841	(-4) 1.2216
2.9	(-2) 1.1116	(-3) 5.8431	(-3) 3.0264	(-3) 1.5460	(-4) 7.7967	(-4) 3.8845	(-4) 1.9134	(-5) 9.3228
3.0	(-3) 9.0885	(-3) 4.7224	(-3) 2.4191	(-3) 1.2228	(-4) 6.1042	(-4) 3.0117	(-4) 1.4695	(-5) 7.0950
3.1	(-3) 7.4028	(-3) 3.8030	(-3) 1.9270	(-4) 9.6394	(-4) 4.7641	(-4) 2.3279	(-4) 1.1253	(-5) 5.3843
3.2	(-3) 6.0067	(-3) 3.0513	(-3) 1.5296	(-4) 7.5735	(-4) 3.7062	(-4) 1.7938	(-5) 8.5914	(-5) 4.0742
3.3	(-3) 4.8549	(-3) 2.4392	(-3) 1.2099	(-4) 5.9301	(-4) 2.8738	(-4) 1.3778	(-5) 5.5394	(-5) 3.0738
3.4	(-3) 3.9086	(-3) 1.9426	(-4) 9.5361	(-4) 4.6274	(-4) 2.2210	(-4) 1.0550	(-5) 4.9621	(-5) 2.3121
3.5	(-3) 3.1342	(-3) 1.5412	(-4) 7.4887	(-4) 3.5982	(-4) 1.7107	(-5) 8.0514	(-5) 3.7534	(-5) 1.7338
3.6	(-3) 2.5032	(-3) 1.2181	(-4) 5.8592	(-4) 2.7880	(-4) 1.3131	(-5) 6.1244	(-5) 2.8300	(-5) 1.2961
3.7	(-3) 1.9912	(-4) 9.5895	(-4) 4.5672	(-4) 2.1526	(-4) 1.0045	(-5) 4.6430	(-5) 2.1269	(-6) 9.6590
3.8	(-3) 1.5775	(-4) 7.5202	(-4) 3.5468	(-4) 1.6559	(-5) 7.6567	(-5) 3.5080	(-5) 1.5932	(-6) 7.1749
3.9	(-3) 1.2446	(-4) 5.8741	(-4) 2.7439	(-4) 1.2692	(-5) 5.8157	(-5) 2.6413	(-5) 1.1894	(-6) 5.3123
4.0	(-4) 9.7788	(-4) 4.5702	(-4) 2.1146	(-5) 9.6913	(-5) 4.4015	(-5) 1.9818	(-6) 8.8495	(-6) 3.9203
4.1	(-4) 7.6513	(-4) 3.5414	(-4) 1.6233	(-5) 7.3727	(-5) 3.3191	(-5) 1.4817	(-6) 6.5617	(-6) 2.8834
4.2	(-4) 5.9616	(-4) 2.7331	(-4) 1.2413	(-5) 5.5875	(-5) 2.4937	(-5) 1.1039	(-6) 4.8485	(-6) 2.1136
4.3	(-4) 4.6255	(-4) 2.1007	(-5) 9.4547	(-5) 4.2185	(-5) 1.8667	(-6) 8.1946	(-6) 3.5701	(-6) 1.5440
4.4	(-4) 3.5736	(-4) 1.6081	(-5) 7.1727	(-5) 3.1726	(-5) 1.3920	(-6) 6.0609	(-6) 2.6194	(-6) 1.1240
4.5	(-4) 2.7491	(-4) 1.2259	(-5) 5.4198	(-5) 2.3767	(-5) 1.0342	(-6) 4.4663	(-6) 1.9150	(-7) 8.1539
4.6	(-4) 2.1058	(-5) 9.3061	(-5) 4.0787	(-5) 1.7736	(-6) 7.6538	(-6) 3.2790	(-6) 1.3949	(-7) 5.8942
4.7	(-4) 1.6061	(-5) 7.0352	(-5) 3.0571	(-5) 1.3183	(-6) 5.6428	(-6) 2.3983	(-6) 1.0124	(-7) 4.2455
4.8	(-4) 1.2197	(-5) 5.2961	(-5) 2.2819	(-6) 9.7593	(-6) 4.1440	(-6) 1.7475	(-7) 7.3205	(-7) 3.0469
4.9	(-5) 9.2216	(-5) 3.9701	(-5) 1.6964	(-6) 7.1961	(-6) 3.0315	(-6) 1.2685	(-7) 5.2737	(-7) 2.1788
5.0	(-5) 6.9418	(-5) 2.9634	(-5) 1.2558	(-6) 5.2847	(-6) 2.2089	(-7) 9.1724	(-7) 3.7849	(-7) 1.5523

Table 19.1

x	$V(1.5, x)$	$V(2.0, x)$	$V(2.5, x)$	$V(3.0, x)$	$V(3.5, x)$	$V(4.0, x)$	$V(4.5, x)$	$V(5.0, x)$
0.0	0.0000	(-1) 3.4311	(-1) 7.9788	(-1) 4.9200	0.0000	(0) 0.8578	(0) 2.3937	(0) 1.7220
0.1	(-1) 0.7999	(-1) 3.9591	(-1) 8.0788	(-1) 5.8561	(-1) 2.4076	(0) 1.0483	(0) 2.4477	(0) 2.1545
0.2	(-1) 1.6118	(-1) 4.5665	(-1) 8.3814	(-1) 6.9684	(-1) 4.8999	(0) 1.2810	(0) 2.6124	(0) 2.6952
0.3	(-1) 2.4481	(-1) 5.2660	(-1) 8.8948	(-1) 8.2911	(-1) 7.5647	(0) 1.5652	(0) 2.8954	(0) 3.3715
0.4	(-1) 3.3218	(-1) 6.0721	(-1) 9.6332	(-1) 9.8651	(0) 1.0497	(0) 1.9126	(0) 3.3098	(0) 4.2178
0.5	(-1) 4.2467	(-1) 7.0024	(0) 1.0617	(0) 1.1740	(0) 1.3802	(0) 2.3376	(0) 3.8751	(0) 5.2778
0.6	(-1) 5.2381	(-1) 8.0774	(0) 1.1875	(0) 1.3975	(0) 1.7600	(0) 2.8579	(0) 4.6180	(0) 6.6060
0.7	(-1) 6.3130	(-1) 9.3217	(0) 1.3438	(0) 1.6644	(0) 2.2033	(0) 3.4955	(0) 5.5736	(0) 8.2721
0.8	(-1) 7.4906	(0) 1.0764	(0) 1.5356	(0) 1.9833	(0) 2.7266	(0) 4.2777	(0) 6.7880	(1) 1.0364
0.9	(-1) 8.7928	(0) 1.2440	(0) 1.7685	(0) 2.3652	(0) 3.3501	(0) 5.2386	(0) 8.3200	(1) 1.2993
1.0	(0) 1.0245	(0) 1.4390	(0) 2.0490	(0) 2.8230	(0) 4.0980	(0) 6.4206	(1) 1.0245	(1) 1.6301
1.1	(0) 1.1877	(0) 1.6665	(0) 2.3862	(0) 3.3729	(0) 5.0002	(0) 7.8765	(1) 1.2659	(1) 2.0469
1.2	(0) 1.3724	(0) 1.9325	(0) 2.7905	(0) 4.0346	(0) 6.0933	(0) 9.6727	(1) 1.5683	(1) 2.5728
1.3	(0) 1.5826	(0) 2.2442	(0) 3.2748	(0) 4.8322	(0) 7.4224	(1) 1.1892	(1) 1.9473	(1) 3.2373
1.4	(0) 1.8234	(0) 2.6104	(0) 3.8551	(0) 5.7959	(0) 9.0439	(1) 1.4640	(1) 2.4227	(1) 4.0782
1.5	(0) 2.1005	(0) 3.0418	(0) 4.5511	(0) 6.9626	(1) 1.1028	(1) 1.8048	(1) 3.0195	(1) 5.1442
1.6	(0) 2.4211	(0) 3.5514	(0) 5.3869	(0) 8.3782	(1) 1.3461	(1) 2.2284	(1) 3.7699	(1) 6.4978
1.7	(0) 2.7936	(0) 4.1551	(0) 6.3925	(1) 1.0100	(1) 1.6454	(1) 2.7558	(1) 4.7150	(1) 8.2198
1.8	(0) 3.2284	(0) 4.8722	(0) 7.6047	(1) 1.2199	(1) 2.0145	(1) 3.4139	(1) 5.9076	(2) 1.0415
1.9	(0) 3.7380	(0) 5.7267	(0) 9.0697	(1) 1.4765	(1) 2.4708	(1) 4.2370	(1) 7.4155	(2) 1.3218
2.0	(0) 4.3378	(0) 6.7480	(1) 1.0844	(1) 1.7910	(1) 3.0364	(1) 5.2689	(1) 9.3262	(2) 1.6806
2.1	(0) 5.0463	(0) 7.9725	(1) 1.3000	(1) 2.1774	(1) 3.7393	(1) 6.5656	(2) 1.1753	(2) 2.1408
2.2	(0) 5.8865	(0) 9.4452	(1) 1.5626	(1) 2.6535	(1) 4.6150	(1) 8.1989	(2) 1.4841	(2) 2.7325
2.3	(0) 6.8869	(1) 1.1222	(1) 1.8834	(1) 3.2418	(1) 5.7092	(2) 1.0262	(2) 1.8781	(2) 3.4948
2.4	(0) 8.0823	(1) 1.3374	(1) 2.2765	(1) 3.9709	(1) 7.0801	(2) 1.2873	(2) 2.3822	(2) 4.4794
2.5	(0) 9.5162	(1) 1.5987	(1) 2.7597	(1) 4.8771	(1) 8.8025	(2) 1.6189	(2) 3.0285	(2) 5.7544
2.6	(1) 1.1243	(1) 1.9172	(1) 3.3555	(1) 6.0069	(2) 1.0973	(2) 2.0411	(2) 3.8596	(2) 7.4093
2.7	(1) 1.3329	(1) 2.3068	(1) 4.0926	(1) 7.4199	(2) 1.3716	(2) 2.5801	(2) 4.9310	(2) 9.5631
2.8	(1) 1.5860	(1) 2.7849	(1) 5.0074	(1) 9.1925	(2) 1.7193	(2) 3.2701	(2) 6.3162	(3) 1.2374
2.9	(1) 1.8943	(1) 3.3738	(1) 6.1466	(2) 1.1423	(2) 2.1614	(2) 4.1562	(2) 8.1119	(3) 1.6051
3.0	(1) 2.2710	(1) 4.1018	(1) 7.5701	(2) 1.4240	(2) 2.7252	(2) 5.2976	(3) 1.0447	(3) 2.0877
3.1	(1) 2.7333	(1) 5.0049	(1) 9.3551	(2) 1.7809	(2) 3.4467	(2) 6.7721	(3) 1.3491	(3) 2.7227
3.2	(1) 3.3028	(1) 6.1295	(2) 1.1601	(2) 2.2345	(2) 4.3729	(2) 8.6829	(3) 1.7474	(3) 3.5606
3.3	(1) 4.0070	(1) 7.5350	(2) 1.4437	(2) 2.8131	(2) 5.5657	(3) 1.1167	(3) 2.2698	(3) 4.6697
3.4	(1) 4.8812	(1) 9.2982	(2) 1.8032	(2) 3.5537	(2) 7.1071	(3) 1.4407	(3) 2.9574	(3) 6.1422
3.5	(1) 5.9708	(2) 1.1519	(2) 2.2604	(2) 4.5048	(2) 9.1055	(3) 1.8646	(3) 3.8650	(3) 8.1029
3.6	(1) 7.3343	(2) 1.4325	(2) 2.8441	(2) 5.7308	(3) 1.1705	(3) 2.4212	(3) 5.0672	(4) 1.0722
3.7	(1) 9.0472	(2) 1.7887	(2) 3.5920	(2) 7.3166	(3) 1.5100	(3) 3.1543	(3) 6.6645	(4) 1.4232
3.8	(2) 1.1208	(2) 2.2424	(2) 4.5540	(2) 9.3755	(3) 1.9547	(3) 4.1233	(3) 8.7939	(4) 1.8950
3.9	(2) 1.3945	(2) 2.8227	(2) 5.7960	(3) 1.2058	(3) 2.5393	(3) 5.4084	(4) 1.1642	(4) 2.5313
4.0	(2) 1.7425	(2) 3.5678	(2) 7.4057	(3) 1.5567	(3) 3.3108	(3) 7.1188	(4) 1.5465	(4) 3.3924
4.1	(2) 2.1870	(2) 4.5283	(2) 9.5001	(3) 2.0173	(3) 4.3324	(3) 9.4032	(4) 2.0613	(4) 4.5614
4.2	(2) 2.7569	(2) 5.7716	(3) 1.2236	(3) 2.6243	(3) 5.6903	(4) 1.2465	(4) 2.7570	(4) 6.1538
4.3	(2) 3.4909	(2) 7.3873	(3) 1.5823	(3) 3.4272	(3) 7.5019	(4) 1.6584	(4) 3.7005	(4) 8.3306
4.4	(2) 4.4399	(2) 9.4956	(3) 2.0545	(3) 4.4934	(3) 9.9277	(4) 2.2145	(4) 4.9845	(5) 1.1316
4.5	(2) 5.6724	(3) 1.2258	(3) 2.6786	(3) 5.9146	(4) 1.3188	(4) 2.9680	(4) 6.7384	(5) 1.5426
4.6	(2) 7.2797	(3) 1.5893	(3) 3.5069	(3) 7.8166	(4) 1.7588	(4) 3.9929	(4) 9.1425	(5) 2.1103
4.7	(2) 9.3849	(3) 2.0695	(3) 4.6106	(4) 1.0372	(4) 2.3547	(4) 5.3922	(5) 1.2450	(5) 2.8973
4.8	(3) 1.2154	(3) 2.7065	(3) 6.0871	(4) 1.3819	(4) 3.1649	(4) 7.3096	(5) 1.7018	(5) 3.9923
4.9	(3) 1.5812	(3) 3.5553	(3) 8.0706	(4) 1.8487	(4) 4.2708	(4) 9.9472	(5) 2.3348	(5) 5.5212
5.0	(3) 2.0666	(3) 4.6909	(4) 1.0746	(4) 2.4833	(4) 5.7864	(5) 1.3589	(5) 3.2156	(5) 7.6639

Table 19.2

x	$W(-5.0, x)$	$W(-4.0, x)$	$W(-3.0, x)$	$W(-2.0, x)$	$W(-5.0, -x)$	$W(-4.0, -x)$	$W(-3.0, -x)$	$W(-2.0, -x)$
0.0	0.47348	0.50102	0.53933	0.60027	0.47348	0.50102	0.53933	0.60027
0.1	0.35697	0.39190	0.43901	0.51126	0.56641	0.59017	0.62350	0.67730
0.2	0.22267	0.26715	0.32555	0.41203	0.63113	0.65576	0.68900	0.74078
0.3	+0.07727	+0.13172	0.20231	0.30453	0.66435	0.69515	0.73381	0.78939
0.4	-0.07200	-0.00899	+0.07298	0.19088	0.66434	0.70666	0.75649	0.82206
0.5	-0.21764	-0.14933	-0.05857	+0.07334	0.63099	0.68972	0.75622	0.83798
0.6	-0.35231	-0.28362	-0.18832	-0.04569	0.56583	0.64485	0.73285	0.83665
0.7	-0.46911	-0.40634	-0.31226	-0.16377	0.47199	0.57370	0.68690	0.81785
0.8	-0.56198	-0.51236	-0.42646	-0.27838	0.35408	0.47898	0.61955	0.78173
0.9	-0.62597	-0.59713	-0.52722	-0.38697	0.21799	0.36441	0.53268	0.72875
1.0	-0.65752	-0.65688	-0.61113	-0.48704	+0.07061	0.23458	0.42880	0.65975
1.1	-0.65470	-0.68881	-0.67522	-0.57617	-0.08044	+0.09483	0.31103	0.57594
1.2	-0.61732	-0.69121	-0.71706	-0.65204	-0.22724	-0.04897	0.18303	0.47890
1.3	-0.54700	-0.66357	-0.73488	-0.71255	-0.36189	-0.19063	+0.04890	0.37059
1.4	-0.44716	-0.60670	-0.72761	-0.75583	-0.47700	-0.32388	-0.08688	0.25333
1.5	-0.32290	-0.52270	-0.69502	-0.78031	-0.56602	-0.44262	-0.21962	0.12978
1.6	-0.18077	-0.41495	-0.63774	-0.78484	-0.62369	-0.54122	-0.34454	+0.00294
1.7	-0.02851	-0.28803	-0.55733	-0.76869	-0.64634	-0.61480	-0.45694	-0.12397
1.8	+0.12535	-0.14758	-0.45625	-0.73166	-0.63218	-0.65945	-0.55237	-0.24749
1.9	0.27194	-0.00009	-0.33785	-0.67412	-0.58147	-0.67250	-0.62680	-0.36405
2.0	0.40253	+0.14739	-0.20633	-0.59707	-0.49661	-0.65271	-0.67684	-0.47006
2.1	0.50907	0.28751	-0.06661	-0.50217	-0.38212	-0.60042	-0.69989	-0.56198
2.2	0.58468	0.41299	+0.07581	-0.39174	-0.24445	-0.51764	-0.69432	-0.63649
2.3	0.62416	0.51702	0.21503	-0.26879	-0.09171	-0.40802	-0.65962	-0.69061
2.4	0.62438	0.59364	0.34495	-0.13696	+0.06678	-0.27680	-0.59652	-0.72184
2.5	0.58460	0.63810	0.45960	-0.00046	0.22095	-0.13062	-0.50704	-0.72830
2.6	0.50668	0.64722	0.55333	+0.13603	0.36067	+0.02276	-0.39454	-0.70889
2.7	0.39507	0.61968	0.62119	0.26749	0.47637	0.17482	-0.26363	-0.66340
2.8	0.25669	0.55625	0.65920	0.38872	0.55973	0.31672	-0.12008	-0.59265
2.9	+0.10057	0.45985	0.66463	0.49459	0.60434	0.43980	+0.02936	-0.49853
3.0	-0.06260	0.33555	0.63631	0.58021	0.60627	0.53615	0.17727	-0.38404
3.1	-0.22123	0.19042	0.57472	0.64123	0.56451	0.59915	0.31588	-0.25332
3.2	-0.36354	+0.03320	0.48225	0.67411	0.48124	0.62397	0.43747	-0.11153
3.3	-0.47850	-0.12614	0.36312	0.67637	0.36184	0.60808	0.53481	+0.03530
3.4	-0.55672	-0.27701	0.22333	0.64681	0.21471	0.55155	0.60167	0.18042
3.5	-0.59128	-0.40886	+0.07050	0.58576	+0.05079	0.45725	0.63325	0.31672
3.6	-0.57849	-0.51196	-0.08654	0.49519	-0.11714	0.33088	0.62663	0.43701
3.7	-0.51836	-0.57820	-0.23816	0.37883	-0.27544	0.18074	0.58111	0.53447
3.8	-0.41490	-0.60177	-0.37452	0.24205	-0.41066	+0.01731	0.49849	0.60305
3.9	-0.27601	-0.57982	-0.48622	+0.09180	-0.51073	-0.14737	0.38313	0.63793
4.0	-0.11306	-0.51295	-0.56500	-0.06370	-0.56615	-0.30058	0.24189	0.63597
4.1	+0.05995	-0.40534	-0.60443	-0.21535	-0.57098	-0.42985	+0.08387	0.59605
4.2	0.22741	-0.26474	-0.60059	-0.35365	-0.52367	-0.52406	-0.08010	0.51937
4.3	0.37359	-0.10210	-0.55252	-0.46937	-0.42750	-0.57448	-0.23812	0.40960
4.4	0.48406	+0.06923	-0.46263	-0.55413	-0.29056	-0.57571	-0.37804	0.27290
4.5	0.54726	0.23443	-0.33674	-0.60118	-0.12531	-0.52643	-0.48847	+0.11769
4.6	0.55583	0.37847	-0.18393	-0.60601	+0.05237	-0.42982	-0.55975	-0.04573
4.7	0.50770	0.48758	-0.01604	-0.56693	0.22465	-0.29363	-0.58492	-0.20576
4.8	0.40664	0.55059	+0.15314	-0.48549	0.37342	-0.12977	-0.56059	-0.35036
4.9	0.26226	0.56028	0.30893	-0.36666	0.48233	+0.04660	-0.48753	-0.46788
5.0	0.08936	0.51440	0.43707	-0.21874	0.53861	0.21827	-0.37095	-0.54818
	$\begin{bmatrix} (-3)7 \\ 6 \end{bmatrix}$	$\begin{bmatrix} (-3)7 \\ 6 \end{bmatrix}$	$\begin{bmatrix} (-3)6 \\ 6 \end{bmatrix}$	$\begin{bmatrix} (-3)5 \\ 6 \end{bmatrix}$	$\begin{bmatrix} (-3)7 \\ 6 \end{bmatrix}$	$\begin{bmatrix} (-3)6 \\ 6 \end{bmatrix}$	$\begin{bmatrix} (-3)6 \\ 6 \end{bmatrix}$	$\begin{bmatrix} (-3)5 \\ 6 \end{bmatrix}$

Values of $W(a, x)$ for integral values of a are from National Physical Laboratory, Tables of Weber parabolic cylinder functions. Computed by Scientific Computing Service Ltd. Mathematical Introduction by J. C. P. Miller. Her Majesty's Stationery Office, London, England, 1955 (with permission).

Table 19.2

x	$W(2.0, x)$	$W(3.0, x)$	$W(4.0, x)$	$W(5.0, x)$	$W(2.0, -x)$	$W(3.0, -x)$	$W(4.0, -x)$	$W(5.0, -x)$
0.0	(-1) 6.0027	(-1) 5.3933	(-1) 5.0102	(-1) 4.7348	(-1) 6.0027	(-1) 5.3933	(-1) 5.0102	(-1) 4.7348
0.1	(-1) 5.2271	(-1) 4.5427	(-1) 4.1061	(-1) 3.7888	(-1) 6.8986	(-1) 6.4061	(-1) 6.1154	(-1) 5.9185
0.2	(-1) 4.5561	(-1) 3.8285	(-1) 3.3667	(-1) 3.0330	(-1) 7.9324	(-1) 7.6114	(-1) 7.4658	(-1) 7.3991
0.3	(-1) 3.9758	(-1) 3.2292	(-1) 2.7621	(-1) 2.4291	(-1) 9.1243	(-1) 9.0448	(-1) 9.1150	(-1) 9.2505
0.4	(-1) 3.4744	(-1) 2.7262	(-1) 2.2677	(-1) 1.9466	(0) 1.0497	(0) 1.0748	(0) 1.1128	(0) 1.1564
0.5	(-1) 3.0411	(-1) 2.3041	(-1) 1.8634	(-1) 1.5611	(0) 1.2075	(0) 1.2770	(0) 1.3583	(0) 1.4454
0.6	(-1) 2.6668	(-1) 1.9499	(-1) 1.5327	(-1) 1.2530	(0) 1.3888	(0) 1.5168	(0) 1.6574	(0) 1.8059
0.7	(-1) 2.3436	(-1) 1.6525	(-1) 1.2621	(-1) 1.0067	(0) 1.5967	(0) 1.8008	(0) 2.0215	(0) 2.2555
0.8	(-1) 2.0644	(-1) 1.4028	(-1) 1.0407	(-1) 0.80964	(0) 1.8345	(0) 2.1368	(0) 2.4643	(0) 2.8155
0.9	(-1) 1.8233	(-1) 1.1931	(-2) 8.5930	(-2) 6.5197	(0) 2.1061	(0) 2.5335	(0) 3.0019	(0) 3.5123
1.0	(-1) 1.6151	(-1) 1.0168	(-2) 7.1069	(-2) 5.2572	(0) 2.4156	(0) 3.0013	(0) 3.6538	(0) 4.3782
1.1	(-1) 1.4351	(-2) 8.6859	(-2) 5.8882	(-2) 4.2455	(0) 2.7674	(0) 3.5517	(0) 4.4431	(0) 5.4528
1.2	(-1) 1.2795	(-2) 7.4385	(-2) 4.8880	(-2) 3.4340	(0) 3.1662	(0) 4.1980	(0) 5.3970	(0) 6.7844
1.3	(-1) 1.1450	(-2) 6.3880	(-2) 4.0663	(-2) 2.7825	(0) 3.6169	(0) 4.9554	(0) 6.5479	(0) 8.4318
1.4	(-1) 1.0286	(-2) 5.5025	(-2) 3.3906	(-2) 2.2590	(0) 4.1247	(0) 5.8406	(0) 7.9336	(1) 1.0466
1.5	(-2) 9.2770	(-2) 4.7556	(-2) 2.8343	(-2) 1.8377	(0) 4.6948	(0) 6.8726	(0) 9.5984	(1) 1.2975
1.6	(-2) 8.4018	(-2) 4.1248	(-2) 2.3757	(-2) 1.4984	(0) 5.3324	(0) 8.0723	(1) 1.1594	(1) 1.6060
1.7	(-2) 7.6411	(-2) 3.5917	(-2) 1.9973	(-2) 1.2246	(0) 6.0424	(0) 9.4626	(1) 1.3979	(1) 1.9848
1.8	(-2) 6.9782	(-2) 3.1406	(-2) 1.6845	(-2) 1.0035	(0) 6.8296	(1) 1.1069	(1) 1.6824	(1) 2.4487
1.9	(-2) 6.3984	(-2) 2.7584	(-2) 1.4256	(-3) 8.2455	(0) 7.6980	(1) 1.2917	(1) 2.0206	(1) 3.0155
2.0	(-2) 5.8890	(-2) 2.4342	(-2) 1.2111	(-3) 6.7954	(0) 8.6507	(1) 1.5037	(1) 2.4216	(1) 3.7062
2.1	(-2) 5.4386	(-2) 2.1588	(-2) 1.0330	(-3) 5.6183	(0) 9.6899	(1) 1.7457	(1) 2.8952	(1) 4.5455
2.2	(-2) 5.0372	(-2) 1.9245	(-3) 8.8491	(-3) 4.6610	(1) 1.0816	(1) 2.0209	(1) 3.4529	(1) 5.5623
2.3	(-2) 4.6755	(-2) 1.7247	(-3) 7.6160	(-3) 3.8810	(1) 1.2027	(1) 2.3322	(1) 4.1069	(1) 6.7904
2.4	(-2) 4.3456	(-2) 1.5540	(-3) 6.5875	(-3) 3.2443	(1) 1.3319	(1) 2.6827	(1) 4.8711	(1) 8.2686
2.5	(-2) 4.0402	(-2) 1.4075	(-3) 5.7281	(-3) 2.7236	(1) 1.4686	(1) 3.0749	(1) 5.7600	(2) 1.0042
2.6	(-2) 3.7524	(-2) 1.2813	(-3) 5.0088	(-3) 2.2968	(1) 1.6117	(1) 3.5113	(1) 6.7894	(2) 1.2161
2.7	(-2) 3.4763	(-2) 1.1719	(-3) 4.4055	(-3) 1.9464	(1) 1.7597	(1) 3.9937	(1) 7.9756	(2) 1.4683
2.8	(-2) 3.2064	(-2) 1.0764	(-3) 3.8984	(-3) 1.6580	(1) 1.9108	(1) 4.5230	(1) 9.3355	(2) 1.7672
2.9	(-2) 2.9379	(-3) 9.9205	(-3) 3.4711	(-3) 1.4202	(1) 2.0626	(1) 5.0992	(2) 1.0886	(2) 2.1198
3.0	(-2) 2.6664	(-3) 9.1665	(-3) 3.1099	(-3) 1.2237	(1) 2.2123	(1) 5.7210	(2) 1.2643	(2) 2.5340
3.1	(-2) 2.3883	(-3) 8.4815	(-3) 2.8032	(-3) 1.0610	(1) 2.3564	(1) 6.3856	(2) 1.4620	(2) 3.0179
3.2	(-2) 2.1007	(-3) 7.8473	(-3) 2.5414	(-4) 9.2596	(1) 2.4910	(1) 7.0882	(2) 1.6831	(2) 3.5801
3.3	(-2) 1.8013	(-3) 7.2477	(-3) 2.3163	(-4) 8.1356	(1) 2.6116	(1) 7.8218	(2) 1.9284	(2) 4.2298
3.4	(-2) 1.4891	(-3) 6.6685	(-3) 2.1209	(-4) 7.1975	(1) 2.7132	(1) 8.5768	(2) 2.1983	(2) 4.9757
3.5	(-2) 1.1637	(-3) 6.0967	(-3) 1.9491	(-4) 6.4117	(1) 2.7908	(1) 9.3410	(2) 2.4925	(2) 5.8266
3.6	(-3) 8.2597	(-3) 5.5212	(-3) 1.7956	(-4) 5.7506	(1) 2.8386	(2) 1.0099	(2) 2.8101	(2) 6.7902
3.7	(-3) 4.7816	(-3) 4.9326	(-3) 1.6558	(-4) 5.1910	(1) 2.8513	(2) 1.0833	(2) 3.1488	(2) 7.8732
3.8	(-3) 1.2365	(-3) 4.3233	(-3) 1.5256	(-4) 4.7135	(1) 2.8234	(2) 1.1520	(2) 3.5057	(2) 9.0802
3.9	(-3) -2.3273	(-3) 3.6879	(-3) 1.4014	(-4) 4.3017	(1) 2.7502	(2) 1.2137	(2) 3.8760	(3) 1.0413
4.0	(-3) -5.8480	(-3) 3.0231	(-3) 1.2800	(-4) 3.9416	(1) 2.6275	(2) 1.2657	(2) 4.2539	(3) 1.1870
4.1	(-3) -9.2508	(-3) 2.3283	(-3) 1.1586	(-4) 3.6211	(1) 2.4523	(2) 1.3050	(2) 4.6317	(3) 1.3446
4.2	(-2) -1.2449	(-3) 1.6058	(-3) 1.0349	(-4) 3.3295	(1) 2.2234	(2) 1.3286	(2) 4.9999	(3) 1.5128
4.3	(-2) -1.5347	(-3) 0.8609	(-4) 9.0706	(-4) 3.0577	(1) 1.9410	(2) 1.3334	(2) 5.3475	(3) 1.6899
4.4	(-2) -1.7842	(-3) +0.1023	(-4) 7.7357	(-4) 2.7975	(1) 1.6079	(2) 1.3167	(2) 5.6617	(3) 1.8733
4.5	(-2) -1.9831	(-3) -0.6579	(-4) 6.3364	(-4) 2.5418	(1) 1.2294	(2) 1.2758	(2) 5.9283	(3) 2.0596
4.6	(-2) -2.1213	(-3) -1.4043	(-4) 4.8704	(-4) 2.2847	(0) 8.1345	(2) 1.2086	(2) 6.1317	(3) 2.2445
4.7	(-2) -2.1898	(-3) -2.1182	(-4) 3.3422	(-4) 2.0210	(0) +3.7101	(2) 1.1138	(2) 6.2561	(3) 2.4229
4.8	(-2) -2.1815	(-3) -2.7786	(-4) 1.7637	(-4) 1.7468	(0) -0.8430	(1) 9.9105	(2) 6.2853	(3) 2.5885
4.9	(-2) -2.0914	(-3) -3.3622	(-4) +0.1548	(-4) 1.4595	(0) -5.3626	(1) 8.4104	(2) 6.2040	(3) 2.7344
5.0	(-2) -1.9179	(-3) -3.8449	(-4) -1.4564	(-4) 1.1577	(0) -9.6664	(1) 6.6590	(2) 5.9987	(3) 2.8528

For interpolation, see 19.28.

Table 19.2

x	$W(-1.0, -x)$	$W(-0.9, -x)$	$W(-0.8, -x)$	$W(-0.7, -x)$	$W(-0.6, -x)$	$W(-0.5, -x)$	$W(-0.4, -x)$
0.0	0.73148	0.75416	0.77982	0.80879	0.84130	0.87718	0.91553
0.1	0.79607	0.81697	0.84073	0.86771	0.89814	0.93193	0.96827
0.2	0.85267	0.87241	0.89490	0.92053	0.94958	0.98201	1.01711
0.3	0.90067	0.91990	0.94182	0.96682	0.99522	1.02707	1.06178
0.4	0.93946	0.95892	0.98099	1.00612	1.03467	1.06677	1.10197
0.5	0.96849	0.98892	1.01192	1.03797	1.06749	1.10070	1.13729
0.6	0.98722	1.00940	1.03413	1.06191	1.09323	1.12843	1.16736
0.7	0.99521	1.01990	1.04713	1.07745	1.11143	1.14951	1.19170
0.8	0.99202	1.01997	1.05048	1.08414	1.12160	1.16343	1.20981
0.9	0.97734	1.00923	1.04374	1.08151	1.12325	1.16966	1.22114
1.0	0.95092	0.98738	1.02655	1.06912	1.11589	1.16769	1.22511
1.1	0.91262	0.95418	0.99859	1.04657	1.09904	1.15695	1.22112
1.2	0.86244	0.90952	0.95962	1.01355	1.07228	1.13693	1.20855
1.3	0.80055	0.85341	0.90954	0.96978	1.03523	1.10714	1.18680
1.4	0.72729	0.78603	0.84835	0.91515	0.98760	1.06714	1.15529
1.5	0.64322	0.70774	0.77623	0.84963	0.92923	1.01659	1.11351
1.6	0.54911	0.61912	0.69355	0.77341	0.86006	0.95525	1.06102
1.7	0.44603	0.52099	0.60091	0.68684	0.78025	0.88304	0.99750
1.8	0.33528	0.41443	0.49914	0.59053	0.69014	0.80004	0.92281
1.9	0.21849	0.30081	0.38936	0.48532	0.59032	0.70659	0.83697
2.0	+0.09757	0.18179	0.27298	0.37236	0.48166	0.60326	0.74025
2.1	-0.02528	+0.05934	0.15171	0.25309	0.36531	0.49090	0.63319
2.2	-0.14758	-0.06427	+0.02758	0.12930	0.24278	0.37070	0.51665
2.3	-0.26660	-0.18651	-0.09709	+0.00305	+0.11588	0.24419	0.39182
2.4	-0.37941	-0.30459	-0.21967	-0.12323	-0.01322	+0.11327	0.26028
2.5	-0.48297	-0.41552	-0.33731	-0.24685	-0.14203	-0.01983	+0.12398
2.6	-0.57415	-0.51623	-0.44698	-0.36487	-0.26774	-0.15248	-0.01472
2.7	-0.64990	-0.60356	-0.54551	-0.47416	-0.38730	-0.28178	-0.15309
2.8	-0.70733	-0.67449	-0.62975	-0.57149	-0.49748	-0.40451	-0.28802
2.9	-0.74387	-0.72615	-0.69663	-0.65363	-0.59492	-0.51729	-0.41615
3.0	-0.75737	-0.75605	-0.74331	-0.71748	-0.67629	-0.61660	-0.53384
3.1	-0.74633	-0.76219	-0.76738	-0.76019	-0.73841	-0.69897	-0.63739
3.2	-0.70996	-0.74323	-0.76692	-0.77937	-0.77841	-0.76108	-0.72310
3.3	-0.64841	-0.69863	-0.74077	-0.77320	-0.79386	-0.79994	-0.78743
3.4	-0.56281	-0.62881	-0.68862	-0.74065	-0.78300	-0.81309	-0.82721
3.5	-0.45542	-0.53525	-0.61114	-0.68160	-0.74490	-0.79874	-0.83985
3.6	-0.32961	-0.42059	-0.51016	-0.59701	-0.67961	-0.75603	-0.82349
3.7	-0.18992	-0.28860	-0.38867	-0.48899	-0.58833	-0.68515	-0.77725
3.8	-0.04191	-0.14423	-0.25086	-0.36092	-0.47349	-0.58750	-0.70141
3.9	+0.10799	+0.00657	-0.10208	-0.21739	-0.33883	-0.46582	-0.59756
4.0	0.25266	0.15702	+0.05134	-0.06416	-0.18934	-0.32421	-0.46872
4.1	0.38471	0.29976	0.20225	+0.09203	-0.03124	-0.16811	-0.31938
4.2	0.49679	0.42722	0.34303	0.24366	+0.12831	-0.00420	-0.15545
4.3	0.58208	0.53205	0.46597	0.38285	0.28140	+0.15987	+0.01587
4.4	0.63477	0.60759	0.56372	0.50171	0.41981	0.31572	0.18634
4.5	0.65055	0.64841	0.62979	0.59285	0.53543	0.45473	0.34702
4.6	0.62708	0.65075	0.65910	0.64997	0.62083	0.56851	0.48877
4.7	0.56440	0.61301	0.64846	0.66833	0.66982	0.64950	0.60280
4.8	0.46513	0.53614	0.59705	0.64531	0.67800	0.69154	0.68125
4.9	0.33464	0.42379	0.50672	0.58085	0.64328	0.69050	0.71794
5.0	0.18091	0.28240	0.38215	0.47771	0.56635	0.64481	0.70889
	$\left[\begin{smallmatrix} (-3)5 \\ 5 \end{smallmatrix} \right]$	$\left[\begin{smallmatrix} (-3)5 \\ 5 \end{smallmatrix} \right]$	$\left[\begin{smallmatrix} (-3)5 \\ 5 \end{smallmatrix} \right]$	$\left[\begin{smallmatrix} (-3)5 \\ 5 \end{smallmatrix} \right]$	$\left[\begin{smallmatrix} (-3)5 \\ 5 \end{smallmatrix} \right]$	$\left[\begin{smallmatrix} (-3)6 \\ 5 \end{smallmatrix} \right]$	$\left[\begin{smallmatrix} (-3)6 \\ 5 \end{smallmatrix} \right]$

Table 19.2

x	$W(-0.3, x)$	$W(-0.2, x)$	$W(-0.1, x)$	$W(0, x)$	$W(0.1, x)$	$W(0.2, x)$	$W(0.3, x)$
0.0	0.95411	0.98880	1.01364	1.02277	1.01364	0.98880	0.95411
0.1	0.90030	0.93725	0.96381	0.97388	0.96480	0.93920	0.90311
0.2	0.84377	0.88381	0.91299	0.92496	0.91691	0.89145	0.85480
0.3	0.78461	0.82851	0.86116	0.87595	0.86984	0.84540	0.80896
0.4	0.72293	0.77137	0.80828	0.82673	0.82344	0.80084	0.76536
0.5	0.65878	0.71237	0.75426	0.77719	0.77753	0.75757	0.72375
0.6	0.59225	0.65150	0.69902	0.72716	0.73192	0.71533	0.68386
0.7	0.52341	0.58875	0.64245	0.67647	0.68637	0.67388	0.64540
0.8	0.45236	0.52410	0.58445	0.62496	0.64067	0.63296	0.60809
0.9	0.37924	0.45756	0.52493	0.57244	0.59459	0.59228	0.57163
1.0	0.30421	0.38918	0.46383	0.51877	0.54790	0.55160	0.53573
1.1	0.22751	0.31906	0.40111	0.46381	0.50038	0.51063	0.50010
1.2	0.14946	0.24734	0.33677	0.40744	0.45186	0.46915	0.46446
1.3	+0.07042	0.17425	0.27090	0.34961	0.40217	0.42691	0.42854
1.4	-0.00912	0.10007	0.20361	0.29032	0.35118	0.38374	0.39209
1.5	-0.08857	+0.02522	0.13514	0.22960	0.29883	0.33945	0.35491
1.6	-0.16725	-0.04982	+0.06577	0.16760	0.24510	0.29393	0.31679
1.7	-0.24435	-0.12443	-0.00407	0.10454	0.19006	0.24713	0.27761
1.8	-0.31894	-0.19788	-0.07387	+0.04073	0.13384	0.19904	0.23725
1.9	-0.38999	-0.26933	-0.14299	-0.02340	0.07667	0.14975	0.19569
2.0	-0.45633	-0.33779	-0.21066	-0.08731	+0.01891	0.09941	0.15296
2.1	-0.51674	-0.40219	-0.27600	-0.15034	-0.03902	+0.04828	0.10917
2.2	-0.56989	-0.46135	-0.33802	-0.21170	-0.09655	-0.00327	0.06450
2.3	-0.61444	-0.51400	-0.39560	-0.27048	-0.15300	-0.05478	+0.01926
2.4	-0.64903	-0.55882	-0.44755	-0.32569	-0.20756	-0.10567	-0.02617
2.5	-0.67233	-0.59448	-0.49261	-0.37619	-0.25934	-0.15523	-0.07129
2.6	-0.68311	-0.61966	-0.52947	-0.42082	-0.30731	-0.20267	-0.11551
2.7	-0.68033	-0.63315	-0.55686	-0.45833	-0.35040	-0.24709	-0.15811
2.8	-0.66313	-0.63385	-0.57356	-0.48749	-0.38745	-0.28749	-0.19829
2.9	-0.63097	-0.62088	-0.57846	-0.50710	-0.41729	-0.32283	-0.23518
3.0	-0.58369	-0.59365	-0.57063	-0.51607	-0.43878	-0.35203	-0.26783
3.1	-0.52157	-0.55190	-0.54943	-0.51344	-0.45085	-0.37401	-0.29526
3.2	-0.44541	-0.49584	-0.51451	-0.49851	-0.45256	-0.38777	-0.31648
3.3	-0.35655	-0.42613	-0.46594	-0.47084	-0.44315	-0.39239	-0.33055
3.4	-0.25697	-0.34402	-0.40427	-0.43039	-0.42215	-0.38713	-0.33663
3.5	-0.14924	-0.25134	-0.33055	-0.37754	-0.38941	-0.37148	-0.33401
3.6	-0.03654	-0.15050	-0.24643	-0.31318	-0.34517	-0.34523	-0.32218
3.7	+0.07742	-0.04453	-0.15413	-0.23871	-0.29013	-0.30852	-0.30091
3.8	0.18846	+0.06302	-0.05645	-0.15612	-0.22549	-0.26190	-0.27027
3.9	0.29213	0.16814	+0.04330	-0.06794	-0.15299	-0.20639	-0.23072
4.0	0.38382	0.26651	0.14132	+0.02278	-0.07486	-0.14349	-0.18313
4.1	0.45904	0.35370	0.23354	0.11257	+0.00615	-0.07518	-0.12880
4.2	0.51364	0.42535	0.31572	0.19762	0.08689	-0.00389	-0.06948
4.3	0.54413	0.47744	0.38368	0.27395	0.16386	+0.06754	-0.00733
4.4	0.54793	0.50658	0.43357	0.33764	0.23342	0.13597	+0.05511
4.5	0.52370	0.51029	0.46212	0.38503	0.29194	0.19809	0.11504
4.6	0.47151	0.48726	0.46690	0.41300	0.33601	0.25059	0.16948
4.7	0.39312	0.43762	0.44663	0.41921	0.36270	0.29037	0.21549
4.8	0.29197	0.36308	0.40138	0.40237	0.36981	0.31476	0.25027
4.9	0.17327	0.26703	0.33274	0.36248	0.35608	0.32171	0.27144
5.0	0.04376	0.15455	0.24393	0.30095	0.32145	0.31009	0.27719
	$\left[\begin{smallmatrix} (-3)4 \\ 5 \end{smallmatrix} \right]$	$\left[\begin{smallmatrix} (-3)3 \\ 5 \end{smallmatrix} \right]$	$\left[\begin{smallmatrix} (-3)3 \\ 5 \end{smallmatrix} \right]$	$\left[\begin{smallmatrix} (-3)3 \\ 5 \end{smallmatrix} \right]$	$\left[\begin{smallmatrix} (-3)3 \\ 5 \end{smallmatrix} \right]$	$\left[\begin{smallmatrix} (-3)2 \\ 5 \end{smallmatrix} \right]$	$\left[\begin{smallmatrix} (-3)2 \\ 5 \end{smallmatrix} \right]$

Table 19.2

x	$W(-0.3, -x)$	$W(-0.2, -x)$	$W(-0.1, -x)$	$W(0, -x)$	$W(0.1, -x)$	$W(0.2, -x)$	$W(0.3, -x)$
0.0	0.95411	0.98880	1.01364	1.02277	1.01364	0.98880	0.95411
0.1	1.00506	1.03835	1.06245	1.07165	1.06348	1.04037	1.00797
0.2	1.05296	1.08581	1.11016	1.12050	1.11435	1.09399	1.06483
0.3	1.09759	1.13097	1.15665	1.16924	1.16622	1.14968	1.12477
0.4	1.13868	1.17362	1.20172	1.21771	1.21899	1.20741	1.18782
0.5	1.17589	1.21344	1.24510	1.26568	1.27248	1.26706	1.25396
0.6	1.20884	1.25007	1.28645	1.31285	1.32644	1.32845	1.32307
0.7	1.23706	1.28307	1.32534	1.35884	1.38053	1.39129	1.39494
0.8	1.26006	1.31193	1.36129	1.40315	1.43429	1.45520	1.46928
0.9	1.27725	1.33606	1.39368	1.44521	1.48719	1.51968	1.54567
1.0	1.28802	1.35480	1.42185	1.48433	1.53855	1.58412	1.62356
1.1	1.29171	1.36744	1.44504	1.51974	1.58760	1.64775	1.70224
1.2	1.28761	1.37321	1.46241	1.55054	1.63341	1.70967	1.78087
1.3	1.27501	1.37129	1.47304	1.57575	1.67498	1.76885	1.85841
1.4	1.25320	1.36083	1.47598	1.59429	1.71113	1.82408	1.93366
1.5	1.22150	1.34098	1.47020	1.60502	1.74059	1.87401	2.00522
1.6	1.17926	1.31091	1.45469	1.60672	1.76201	1.91713	2.07150
1.7	1.12596	1.26983	1.42841	1.59813	1.77390	1.95181	2.13072
1.8	1.06115	1.21705	1.39039	1.57800	1.77474	1.97628	2.18093
1.9	0.98458	1.15200	1.33973	1.54509	1.76299	1.98870	2.22000
2.0	0.89620	1.07426	1.27565	1.49825	1.73709	1.98714	2.24569
2.1	0.79618	0.98365	1.19757	1.43644	1.69557	1.96968	2.25565
2.2	0.68503	0.88026	1.10510	1.35882	1.63706	1.93446	2.24752
2.3	0.56357	0.76448	0.99819	1.26478	1.56041	1.87972	2.21894
2.4	0.43300	0.63710	0.87711	1.15405	1.46471	1.80390	2.16770
2.5	0.29492	0.49932	0.74256	1.02673	1.34942	1.70575	2.09177
2.6	0.15140	0.35277	0.59571	0.88342	1.21444	1.58440	1.98946
2.7	+0.00489	0.19959	0.43825	0.72523	1.06021	1.43949	1.85956
2.8	-0.14168	+0.04242	0.27241	0.55388	0.88776	1.27129	1.70140
2.9	-0.28503	-0.11563	+0.10100	0.37173	0.69887	1.08078	1.51507
3.0	-0.42150	-0.27098	-0.07258	+0.18182	0.49606	0.86979	1.30151
3.1	-0.54722	-0.41967	-0.24442	-0.01213	0.28264	0.64105	1.06267
3.2	-0.65815	-0.55742	-0.41011	-0.20574	+0.06279	0.39827	0.80159
3.3	-0.75027	-0.67978	-0.56487	-0.39404	-0.15855	+0.14618	0.52249
3.4	-0.81974	-0.78229	-0.70368	-0.57158	-0.37567	-0.10952	+0.23083
3.5	-0.86311	-0.86067	-0.82147	-0.73259	-0.58228	-0.36221	-0.06670
3.6	-0.87754	-0.91101	-0.91331	-0.87118	-0.77162	-0.60449	-0.36232
3.7	-0.86098	-0.93010	-0.97470	-0.98158	-0.93674	-0.82836	-0.64721
3.8	-0.81248	-0.91559	-1.00185	-1.05844	-1.07077	-1.02554	-0.91187
3.9	-0.73233	-0.86631	-0.99193	-1.09719	-1.16728	-1.18779	-1.14634
4.0	-0.62227	-0.78249	-0.94343	-1.09434	-1.22069	-1.30732	-1.34070
4.1	-0.48559	-0.66595	-0.85640	-1.04786	-1.22662	-1.37730	-1.48554
4.2	-0.32717	-0.52024	-0.73270	-0.95753	-1.18240	-1.39231	-1.57256
4.3	-0.15346	-0.35070	-0.57611	-0.82515	-1.08743	-1.34891	-1.59514
4.4	+0.02771	-0.16437	-0.39249	-0.65483	-0.94350	-1.24610	-1.54901
4.5	0.20739	+0.03014	-0.18962	-0.45301	-0.75508	-1.08573	-1.43285
4.6	0.37594	0.22299	+0.02291	-0.22843	-0.52942	-0.87285	-1.24877
4.7	0.52351	0.40359	0.23414	+0.00810	-0.27649	-0.61582	-1.00271
4.8	0.64069	0.56113	0.43218	0.24408	-0.00874	-0.32626	-0.70462
4.9	0.71919	0.68534	0.60494	0.46598	+0.25940	-0.01876	-0.36835
5.0	0.75259	0.76721	0.74090	0.65996	0.51219	+0.28970	-0.01132
	$\left[\begin{smallmatrix} (-3)6 \\ 5 \end{smallmatrix} \right]$	$\left[\begin{smallmatrix} (-3)5 \\ 5 \end{smallmatrix} \right]$	$\left[\begin{smallmatrix} (-3)5 \\ 5 \end{smallmatrix} \right]$	$\left[\begin{smallmatrix} (-3)5 \\ 5 \end{smallmatrix} \right]$	$\left[\begin{smallmatrix} (-3)6 \\ 5 \end{smallmatrix} \right]$	$\left[\begin{smallmatrix} (-3)7 \\ 5 \end{smallmatrix} \right]$	$\left[\begin{smallmatrix} (-3)9 \\ 5 \end{smallmatrix} \right]$

Table 19.2

x	$W(0.4, x)$	$W(0.5, x)$	$W(0.6, x)$	$W(0.7, x)$	$W(0.8, x)$	$W(0.9, x)$	$W(1.0, x)$
0.0	0.91553	0.87718	0.84130	0.80879	0.77982	0.75416	0.73148
0.1	0.86271	0.82232	0.78433	0.74973	0.71874	0.69116	0.66667
0.2	0.81331	0.77155	0.73205	0.69590	0.66339	0.63436	0.60852
0.3	0.76709	0.72456	0.68408	0.64687	0.61328	0.58321	0.55639
0.4	0.72376	0.68104	0.64007	0.60222	0.56794	0.53718	0.50970
0.5	0.68304	0.64064	0.59964	0.56155	0.52692	0.49578	0.46791
0.6	0.64462	0.60305	0.56244	0.52446	0.48979	0.45853	0.43051
0.7	0.60820	0.56793	0.52810	0.49058	0.45614	0.42499	0.39703
0.8	0.57347	0.53495	0.49629	0.45952	0.42558	0.39476	0.36704
0.9	0.54011	0.50380	0.46666	0.43095	0.39774	0.36745	0.34013
1.0	0.50782	0.47414	0.43889	0.40452	0.37228	0.34271	0.31594
1.1	0.47630	0.44567	0.41266	0.37992	0.34888	0.32020	0.29412
1.2	0.44523	0.41808	0.38765	0.35682	0.32720	0.29960	0.27435
1.3	0.41435	0.39108	0.36358	0.33494	0.30697	0.28063	0.25634
1.4	0.38338	0.36438	0.34015	0.31399	0.28790	0.26299	0.23981
1.5	0.35206	0.33771	0.31709	0.29370	0.26973	0.24643	0.22451
1.6	0.32018	0.31084	0.29416	0.27382	0.25219	0.23071	0.21019
1.7	0.28752	0.28354	0.27111	0.25410	0.23506	0.21559	0.19662
1.8	0.25395	0.25561	0.24773	0.23433	0.21812	0.20085	0.18361
1.9	0.21934	0.22689	0.22384	0.21430	0.20115	0.18629	0.17094
2.0	0.18363	0.19726	0.19927	0.19384	0.18398	0.17173	0.15845
2.1	0.14682	0.16665	0.17390	0.17280	0.16644	0.15700	0.14595
2.2	0.10899	0.13504	0.14767	0.15107	0.14841	0.14195	0.13331
2.3	0.07029	0.10248	0.12054	0.12857	0.12976	0.12647	0.12038
2.4	+0.03094	0.06908	0.09255	0.10528	0.11045	0.11045	0.10707
2.5	-0.00872	0.03504	0.06378	0.08121	0.09043	0.09385	0.09330
2.6	-0.04827	+0.00063	0.03440	0.05645	0.06972	0.07662	0.07900
2.7	-0.08719	-0.03378	+0.00466	0.03113	0.04840	0.05879	0.06416
2.8	-0.12486	-0.06773	-0.02513	+0.00547	0.02659	0.04042	0.04879
2.9	-0.16058	-0.10069	-0.05457	-0.02025	+0.00447	0.02163	0.03296
3.0	-0.19356	-0.13202	-0.08319	-0.04569	-0.01769	+0.00259	0.01677
3.1	-0.22295	-0.16105	-0.11043	-0.07041	-0.03960	-0.01649	+0.00038
3.2	-0.24788	-0.18700	-0.13568	-0.09392	-0.06087	-0.03531	-0.01602
3.3	-0.26746	-0.20910	-0.15826	-0.11569	-0.08106	-0.05355	-0.03216
3.4	-0.28083	-0.22656	-0.17749	-0.13511	-0.09969	-0.07080	-0.04774
3.5	-0.28722	-0.23861	-0.19265	-0.15158	-0.11623	-0.08664	-0.06242
3.6	-0.28598	-0.24455	-0.20307	-0.16446	-0.13014	-0.10061	-0.07581
3.7	-0.27664	-0.24381	-0.20814	-0.17317	-0.14088	-0.11222	-0.08750
3.8	-0.25895	-0.23596	-0.20735	-0.17718	-0.14793	-0.12101	-0.09707
3.9	-0.23299	-0.22079	-0.20033	-0.17604	-0.15084	-0.12652	-0.10411
4.0	-0.19913	-0.19835	-0.18692	-0.16946	-0.14922	-0.12836	-0.10824
4.1	-0.15813	-0.16901	-0.16717	-0.15730	-0.14284	-0.12624	-0.10912
4.2	-0.11115	-0.13343	-0.14143	-0.13965	-0.13162	-0.11996	-0.10653
4.3	-0.05975	-0.09266	-0.11032	-0.11684	-0.11566	-0.10948	-0.10030
4.4	-0.00585	-0.04811	-0.07481	-0.08947	-0.09531	-0.09494	-0.09046
4.5	+0.04828	-0.00149	-0.03614	-0.05843	-0.07112	-0.07669	-0.07716
4.6	0.10016	+0.04518	+0.00411	-0.02485	-0.04392	-0.05525	-0.06075
4.7	0.14714	0.08968	0.04416	+0.00985	-0.01477	-0.03141	-0.04174
4.8	0.18659	0.12967	0.08203	0.04406	+0.01506	-0.00614	-0.02086
4.9	0.21607	0.16286	0.11567	0.07604	0.04414	+0.01943	+0.00100
5.0	0.23350	0.18712	0.14307	0.10399	0.07092	0.04399	0.02281
	$\left[\begin{smallmatrix} (-3)2 \\ 5 \end{smallmatrix} \right]$	$\left[\begin{smallmatrix} (-3)1 \\ 5 \end{smallmatrix} \right]$	$\left[\begin{smallmatrix} (-4)8 \\ 5 \end{smallmatrix} \right]$	$\left[\begin{smallmatrix} (-4)7 \\ 4 \end{smallmatrix} \right]$	$\left[\begin{smallmatrix} (-4)7 \\ 4 \end{smallmatrix} \right]$	$\left[\begin{smallmatrix} (-4)8 \\ 4 \end{smallmatrix} \right]$	$\left[\begin{smallmatrix} (-4)8 \\ 4 \end{smallmatrix} \right]$

Table 19.2

x	$W(0.4, -x)$	$W(0.5, -x)$	$W(0.6, -x)$	$W(0.7, -x)$	$W(0.8, -x)$	$W(0.9, -x)$	$W(1.0, -x)$
0.0	0.91553	0.87718	0.84130	0.80879	0.77982	0.75416	0.73148
0.1	0.97201	0.93642	0.90331	0.87352	0.84714	0.82396	0.80361
0.2	1.03235	1.00031	0.97072	0.94433	0.92122	0.90115	0.88375
0.3	1.09671	1.06911	1.04386	1.02166	1.00258	0.98636	0.97265
0.4	1.16520	1.14300	1.12302	1.10591	1.09173	1.08022	1.07106
0.5	1.23789	1.22215	1.20846	1.19746	1.18917	1.18338	1.17975
0.6	1.31475	1.30664	1.30040	1.29663	1.29538	1.29644	1.29949
0.7	1.39567	1.39648	1.39896	1.40371	1.41079	1.42000	1.43106
0.8	1.48046	1.49158	1.50419	1.51888	1.53574	1.55459	1.57519
0.9	1.56879	1.59174	1.61602	1.64225	1.67051	1.70068	1.73254
1.0	1.6602	1.6966	1.7343	1.7738	1.8153	1.8586	1.9037
1.1	1.7541	1.8057	1.8586	1.9133	1.9700	2.0286	2.0891
1.2	1.8497	1.9184	1.9884	2.0603	2.1345	2.2107	2.2891
1.3	1.9460	2.0337	2.1230	2.2144	2.3083	2.4048	2.5037
1.4	2.0418	2.1506	2.2613	2.3746	2.4909	2.6102	2.7327
1.5	2.1358	2.2677	2.4020	2.5397	2.6811	2.8264	2.9756
1.6	2.2263	2.3833	2.5437	2.7083	2.8777	3.0520	3.2316
1.7	2.3115	2.4956	2.6843	2.8785	3.0788	3.2856	3.4991
1.8	2.3891	2.6023	2.8216	3.0480	3.2823	3.5249	3.7762
1.9	2.4570	2.7009	2.9529	3.2141	3.4854	3.7674	4.0605
2.0	2.5125	2.7886	3.0752	3.3737	3.6849	4.0097	4.3487
2.1	2.5529	2.8623	3.1853	3.5231	3.8770	4.2479	4.6368
2.2	2.5754	2.9188	3.2793	3.6583	4.0573	4.4775	4.9201
2.3	2.5770	2.9546	3.3532	3.7748	4.2209	4.6931	5.1930
2.4	2.5548	2.9660	3.4030	3.8678	4.3624	4.8889	5.4490
2.5	2.5061	2.9496	3.4241	3.9321	4.4760	5.0582	5.6811
2.6	2.4283	2.9018	3.4124	3.9626	4.5555	5.1940	5.8811
2.7	2.3192	2.8196	3.3634	3.9538	4.5944	5.2887	6.0405
2.8	2.1772	2.7001	3.2734	3.9007	4.5863	5.3346	6.1502
2.9	2.0013	2.5413	3.1389	3.7984	4.5251	5.3240	6.2008
3.0	1.7914	2.3419	2.9573	3.6430	4.4050	5.2495	6.1832
3.1	1.5484	2.1015	2.7270	3.4312	4.2211	5.1041	6.0883
3.2	1.2746	1.8213	2.4478	3.1612	3.9697	4.8822	5.9081
3.3	0.9733	1.5038	2.1206	2.8324	3.6486	4.5794	5.6359
3.4	0.6496	1.1529	1.7487	2.4466	3.2576	4.1934	5.2669
3.5	+0.3098	0.7746	1.3369	2.0074	2.7987	3.7241	4.7985
3.6	-0.0381	+0.3767	0.8923	1.5210	2.2767	3.1746	4.2315
3.7	-0.3848	-0.0314	+0.4244	0.9962	1.6994	2.5511	3.5700
3.8	-0.7198	-0.4385	-0.0553	+0.4445	1.0779	1.8636	2.8225
3.9	-1.0317	-0.8319	-0.5332	-0.1199	+0.4263	1.1259	2.0016
4.0	-1.3084	-1.1977	-0.9940	-0.6804	-0.2378	+0.3558	1.1251
4.1	-1.5382	-1.5216	-1.4209	-1.2184	-0.8941	-0.4249	+0.2152
4.2	-1.7095	-1.7893	-1.7966	-1.7136	-1.5199	-1.1915	-0.7013
4.3	-1.8124	-1.9871	-2.1039	-2.1453	-2.0907	-1.9160	-1.5936
4.4	-1.8391	-2.1032	-2.3268	-2.4930	-2.5817	-2.5692	-2.4280
4.5	-1.7844	-2.1283	-2.4513	-2.7376	-2.9685	-3.1213	-3.1692
4.6	-1.6469	-2.0567	-2.4668	-2.8632	-3.2291	-3.5437	-3.7818
4.7	-1.4292	-1.8870	-2.3670	-2.8579	-3.3452	-3.8110	-4.2326
4.8	-1.1387	-1.6231	-2.1513	-2.7153	-3.3040	-3.9027	-4.4924
4.9	-0.7876	-1.2742	-1.8252	-2.4359	-3.0995	-3.8054	-4.5392
5.0	-0.3927	-0.8557	-1.4010	-2.0281	-2.7346	-3.5149	-4.3599
	$\left[\begin{smallmatrix} (-2)1 \\ 5 \end{smallmatrix} \right]$	$\left[\begin{smallmatrix} (-2)1 \\ 5 \end{smallmatrix} \right]$	$\left[\begin{smallmatrix} (-2)1 \\ 5 \end{smallmatrix} \right]$	$\left[\begin{smallmatrix} (-2)2 \\ 5 \end{smallmatrix} \right]$	$\left[\begin{smallmatrix} (-2)2 \\ 5 \end{smallmatrix} \right]$	$\left[\begin{smallmatrix} (-2)2 \\ 5 \end{smallmatrix} \right]$	$\left[\begin{smallmatrix} (-2)3 \\ 5 \end{smallmatrix} \right]$

Table 19.3

AUXILIARY FUNCTIONS

The functions ϑ_1 , ϑ_2 , ϑ_3 of 19.10 and 19.23 are needed in Darwin's expansion and also the function τ of 19.7 and 19.20.

ξ	ϑ_1	ϑ_3	τ	ξ	ϑ_1	ϑ_2	τ
0.0	0.00000	0.39270	-0.70270	5.0	6.9519	5.5506	4.1079
0.1	0.05008	0.34278	-0.64181	5.1	7.2093	5.7981	4.2291
0.2	0.10066	0.29337	-0.57855	5.2	7.4716	6.0507	4.3511
0.3	0.15222	0.24498	-0.51304	5.3	7.7388	6.3084	4.4738
0.4	0.20521	0.19817	-0.44540	5.4	8.0109	6.5712	4.5972
0.5	0.26006	0.15355	-0.37574	5.5	8.2880	6.8391	4.7213
0.6	0.31713	0.11182	-0.30415	5.6	8.5700	7.1120	4.8461
0.7	0.37678	0.07387	-0.23071	5.7	8.8569	7.3901	4.9716
0.8	0.43929	0.04088	-0.15549	5.8	9.1487	7.6732	5.0977
0.9	0.50492	0.01468	-0.07857	5.9	9.4454	7.9614	5.2246
1.0	0.57390	0.00000	0.00000	6.0	9.7471	8.2546	5.3521
1.1	0.64640	0.01513	0.08015	6.1	10.0537	8.5530	5.4803
1.2	0.72261	0.04341	0.16185	6.2	10.3652	8.8564	5.6092
1.3	0.80265	0.08086	0.24502	6.3	10.6817	9.1649	5.7387
1.4	0.88666	0.12617	0.32964	6.4	11.0031	9.4784	5.8688
1.5	0.97473	0.17866	0.41566	6.5	11.3295	9.7970	5.9996
1.6	1.06696	0.23786	0.50304	6.6	11.6608	10.1207	6.1310
1.7	1.16344	0.30347	0.59175	6.7	11.9970	10.4494	6.2631
1.8	1.26422	0.37527	0.68175	6.8	12.3382	10.7832	6.3958
1.9	1.36937	0.45309	0.77300	6.9	12.6843	11.1220	6.5290
2.0	1.47894	0.53679	0.86549	7.0	13.0354	11.4659	6.6629
2.1	1.59299	0.62626	0.95917	7.1	13.3914	11.8148	6.7974
2.2	1.71155	0.72142	1.05403	7.2	13.7524	12.1688	6.9325
2.3	1.83466	0.82220	1.15004	7.3	14.1183	12.5278	7.0682
2.4	1.96236	0.92853	1.24716	7.4	14.4892	12.8919	7.2045
2.5	2.09467	1.04036	1.34539	7.5	14.8651	13.2610	7.3414
2.6	2.23163	1.15764	1.44470	7.6	15.2459	13.6352	7.4789
2.7	2.37325	1.28034	1.54506	7.7	15.6316	14.0144	7.6169
2.8	2.51956	1.40843	1.64646	7.8	16.0223	14.3987	7.7555
2.9	2.67058	1.54187	1.74888	7.9	16.4180	14.7880	7.8947
3.0	2.82632	1.68063	1.85229	8.0	16.8186	15.1823	8.0344
3.1	2.98681	1.82470	1.95669	8.1	17.2242	15.5817	8.1747
3.2	3.15205	1.97406	2.06206	8.2	17.6348	15.9861	8.3155
3.3	3.32207	2.12867	2.16837	8.3	18.0503	16.3956	8.4569
3.4	3.49688	2.28853	2.27562	8.4	18.4708	16.8101	8.5989
3.5	3.67648	2.45363	2.38378	8.5	18.8962	17.2296	8.7413
3.6	3.86089	2.62394	2.49285	8.6	19.3266	17.6542	8.8844
3.7	4.05011	2.79946	2.60281	8.7	19.7620	18.0838	9.0279
3.8	4.24416	2.98017	2.71365	8.8	20.2024	18.5184	9.1720
3.9	4.44305	3.16606	2.82536	8.9	20.6477	18.9581	9.3166
4.0	4.64678	3.35712	2.93791	9.0	21.0980	19.4028	9.4617
4.1	4.85537	3.55335	3.05131	9.1	21.5532	19.8525	9.6074
4.2	5.06880	3.75474	3.16554	9.2	22.0135	20.3073	9.7535
4.3	5.28711	3.96127	3.28058	9.3	22.4787	20.7671	9.9002
4.4	5.51028	4.17295	3.39643	9.4	22.9488	21.2319	10.0474
4.5	5.73833	4.38976	3.51308	9.5	23.4240	21.7017	10.1951
4.6	5.97126	4.61169	3.63051	9.6	23.9041	22.1766	10.3433
4.7	6.20908	4.83875	3.74872	9.7	24.3892	22.6565	10.4920
4.8	6.45178	5.07093	3.86770	9.8	24.8792	23.1414	10.6411
4.9	6.69938	5.30822	3.98743	9.9	25.3742	23.6314	10.7908
5.0	6.95188	5.55062	4.10792	10.0	25.8742	24.1264	10.9410
	$\left[\begin{smallmatrix} (-4)6 \\ 4 \end{smallmatrix} \right]$	$\left[\begin{smallmatrix} (-3)2 \\ 6 \end{smallmatrix} \right]$	$\left[\begin{smallmatrix} (-4)3 \\ 3 \end{smallmatrix} \right]$		$\left[\begin{smallmatrix} (-4)6 \\ 3 \end{smallmatrix} \right]$	$\left[\begin{smallmatrix} (-4)7 \\ 3 \end{smallmatrix} \right]$	$\left[\begin{smallmatrix} (-4)1 \\ 3 \end{smallmatrix} \right]$

When interpolating for ϑ_2 and ϑ_3 for ξ near unity, it is better to interpolate for τ and then use

$$\vartheta_2 = \frac{2}{3}\tau^{3/2} \text{ or } \vartheta_3 = \frac{2}{3}(-\tau)^{3/2}.$$

20. Mathieu Functions

GERTRUDE BLANCH¹

Contents

	Page
Mathematical Properties	722
20.1. Mathieu's Equation	722
20.2. Determination of Characteristic Values	722
20.3. Floquet's Theorem and Its Consequences	727
20.4. Other Solutions of Mathieu's Equation	730
20.5. Properties of Orthogonality and Normalization	732
20.6. Solutions of Mathieu's Modified Equation for Integral ν	732
20.7. Representations by Integrals and Some Integral Equations	735
20.8. Other Properties	738
20.9. Asymptotic Representations	740
20.10. Comparative Notations	744
References	745
Table 20.1. Characteristic Values, Joining Factors, Some Critical Values ($0 \leq q \leq \infty$)	748

Even Solutions

$$a_r, ce_r(0, q), ce_r\left(\frac{\pi}{2}, q\right), ce_r'\left(\frac{\pi}{2}, q\right), (4q)^{\frac{r}{2}} g_{e,r}(q), (4q)^r f_{e,r}(q)$$

Odd Solutions

$$b_r, se_r'(0, q), se_r\left(\frac{\pi}{2}, q\right), se_r'\left(\frac{\pi}{2}, q\right), (4q)^{\frac{r}{2}} g_{o,r}(q), (4q)^r f_{o,r}(q)$$

$$q=0(5)25, \quad 8D \text{ or } S$$

$$a_r + 2q - (4r+2)\sqrt{q}, \quad b_r + 2q - (4r-2)\sqrt{q}$$

$$q^{-\frac{1}{2}} = .16(-.04)0, \quad 8D$$

$$r=0, 1, 2, 5, 10, 15$$

Table 20.2. Coefficients A_m and B_m	750
---	-----

$$q=5, 25; r=0, 1, 2, 5, 10, 15, \quad 9D$$

¹ Aeronautical Research Laboratories, Wright-Patterson Air Force Base, Ohio.

20. Mathieu Functions

Mathematical Properties

20.1. Mathieu's Equation

Canonical Form of the Differential Equation

$$20.1.1 \quad \frac{d^2y}{dv^2} + (a - 2q \cos 2v)y = 0$$

Mathieu's Modified Differential Equation

$$20.1.2 \quad \frac{d^2f}{du^2} - (a - 2q \cosh 2u)f = 0 \quad (v = iu, y = f)$$

Relation Between Mathieu's Equation and the Wave Equation for the Elliptic Cylinder

The wave equation in Cartesian coordinates is

$$20.1.3 \quad \frac{\partial^2 W}{\partial x^2} + \frac{\partial^2 W}{\partial y^2} + \frac{\partial^2 W}{\partial z^2} + k^2 W = 0$$

A solution W is obtainable by separation of variables in elliptical coordinates. Thus, let

$$x = \rho \cosh u \cos v; \quad y = \rho \sinh u \sin v; \quad z = z;$$

ρ a positive constant; 20.1.3 becomes

$$20.1.4 \quad * \frac{\partial^2 W}{\partial z^2} + \frac{2}{\rho^2 (\cosh 2u - \cos 2v)} \left(\frac{\partial^2 W}{\partial u^2} + \frac{\partial^2 W}{\partial v^2} \right) + k^2 W = 0$$

Assuming a solution of the form

$$W = \varphi(z)f(u)g(v)$$

and substituting the above into 20.1.4 one obtains, after dividing through by W ,

$$\frac{1}{\varphi} \frac{d^2 \varphi}{dz^2} + G = 0$$

where

$$* G = \frac{2}{\rho^2 (\cosh 2u - \cos 2v)} \left\{ \frac{d^2 f}{du^2} \frac{1}{f} + \frac{d^2 g}{dv^2} \frac{1}{g} \right\} + k^2$$

Since z, u, v are independent variables, it follows that

$$20.1.5 \quad \frac{d^2 \varphi}{dz^2} + c\varphi = 0$$

where c is a constant.

Again, from the fact that $G = c$ and that u, v are independent variables, one sets

20.1.6

$$* a = \frac{d^2 f}{du^2} \frac{1}{f} + \frac{(k^2 - c)}{2} \rho^2 \cosh 2u$$

$$a = -\frac{d^2 g}{dv^2} \frac{1}{g} + \frac{(k^2 - c)}{2} \rho^2 \cos 2v$$

where a is a constant. The above are equivalent to 20.1.1 and 20.1.2. The constants c and a are often referred to as *separation constants*, due to the role they play in 20.1.5 and 20.1.6.

For some physically important solutions, the function g must be periodic, of period π or 2π . It can be shown that there exists a countably infinite set of *characteristic values* $a_r(q)$ which yield even periodic solutions of 20.1.1; there is another countably infinite sequence of *characteristic values* $b_r(q)$ which yield odd periodic solutions of 20.1.1.

It is known that there exist periodic solutions of period $k\pi$, where k is any positive integer. In what follows, however, the term *characteristic value* will be reserved for a value associated with solutions of period π or 2π only. These characteristic values are of basic importance to the general theory of the differential equation for arbitrary parameters a and q .

An Algebraic Form of Mathieu's Equation

20.1.7

$$(1-t^2) \frac{d^2 y}{dt^2} - t \frac{dy}{dt} + (a + 2q - 4qt^2)y = 0 \quad (\cos v = t)$$

Relation to Spheroidal Wave Equation

$$20.1.8 \quad (1-t^2) \frac{d^2 y}{dt^2} - 2(b+1)t \frac{dy}{dt} + (c - 4qt^2)y = 0 \quad *$$

Thus, Mathieu's equation is a special case of 20.1.8, with $b = -\frac{1}{2}$, $c = a + 2q$.

20.2. Determination of Characteristic Values

A solution of 20.1.1 with v replaced by z , having period π or 2π is of the form

$$20.2.1 \quad y = \sum_{m=0}^{\infty} (A_m \cos mz + B_m \sin mz)$$

where B_0 can be taken as zero. If the above is substituted into 20.1.1 one obtains

20.2.2

$$\sum_{m=-2}^{\infty} [(a-m^2)A_m - q(A_{m-2} + A_{m+2})] \cos mz + \sum_{m=-1}^{\infty} [(a-m^2)B_m - q(B_{m-2} + B_{m+2})] \sin mz = 0$$

$$A_{-m}, B_{-m} = 0 \quad m > 0$$

Equation 20.2.2 can be reduced to one of four simpler types, given in 20.2.3 and 20.2.4 below

20.2.3 $y_0 = \sum_{m=0}^{\infty} A_{2m+p} \cos(2m+p)z, \quad p=0 \text{ or } 1$

20.2.4 $y_1 = \sum_{m=0}^{\infty} B_{2m+p} \sin(2m+p)z, \quad p=0 \text{ or } 1$

If $p=0$, the solution is of period π ; if $p=1$, the solution is of period 2π .

Recurrence Relations Among the Coefficients

Even solutions of period π :

20.2.5 $aA_0 - qA_2 = 0$

20.2.6 $(a-4)A_2 - q(2A_0 + A_4) = 0$

20.2.7 $(a-m^2)A_m - q(A_{m-2} + A_{m+2}) = 0 \quad (m \geq 3)$

Even solutions of period 2π :

20.2.8 $(a-1)A_1 - q(A_1 + A_3) = 0,$

along with 20.2.7 for $m \geq 3$.

Odd solutions of period π :

20.2.9 $(a-4)B_2 - qB_4 = 0$

* 20.2.10 $(a-m^2)B_m - q(B_{m-2} + B_{m+2}) = 0 \quad (m \geq 3)$

Odd solutions of period 2π :

20.2.11 $(a-1)B_1 + q(B_1 - B_3) = 0,$

along with 20.2.10 for $m \geq 3$.

Let

20.2.12 $Ge_m = A_m/A_{m-2}, \quad Go_m = B_m/B_{m-2};$

$G_m = Ge_m$ or Go_m when the same operations apply to both, and no ambiguity is likely to arise. Further let

20.2.13 $V_m = (a-m^2)/q.$

Equations 20.2.5-20.2.7 are equivalent to

20.2.14 $Ge_2 = V_0; \quad Ge_4 = V_2 - \frac{2}{Ge_2}$

20.2.15 $G_m = 1/(V_m - G_{m+2}) \quad (m \geq 3),$

for even solutions of period π .

Similarly

20.2.16 $V_1 - 1 = Ge_3;$ for even solutions of period 2π , along with 20.2.15

20.2.17 $V_1 + 1 = Go_3,$ for odd solutions of period 2π , along with 20.2.15

20.2.18 $V_2 = Go_4,$ for odd solutions of period π , along with 20.2.15

These three-term recurrence relations among the coefficients indicate that every G_m can be developed into two types of continued fractions. Thus 20.2.15 is equivalent to

20.2.19

$$G_m = \frac{1}{V_m - G_{m+2}} = \frac{1}{V_m - \frac{1}{V_{m+2} - \frac{1}{V_{m+4} - \dots}}} \quad (m \geq 3)$$

20.2.20

$$G_{m+2} = V_m - 1/G_m = V_m - \frac{1}{V_{m-2} - \frac{1}{V_{m-4} - \dots - \frac{\varphi_0}{V_{0+d} + \varphi_1}}} \quad (m \geq 3)$$

where

$\varphi_1 = d = 0; \quad \varphi_0 = 2,$ if $G_{m+2} = A_{2s}/A_{2s-2}$

$\varphi_1 = d = \varphi_0 = 0,$ if $G_{m+2} = B_{2s}/B_{2s-2}$

$\varphi_1 = -1; \quad \varphi_0 = d = 1,$ if $G_{m+2} = A_{2s+1}/A_{2s-1}$

$\varphi_1 = d = \varphi_0 = 1,$ if $G_{m+2} = B_{2s+1}/B_{2s-1}$

The four choices of the parameters φ_1, φ_0, d correspond to the four types of solutions 20.2.3-20.2.4. Hereafter, it will be convenient to separate the characteristic values a into two major subsets:

$a = a_r,$ associated with even periodic solutions

$a = b_r,$ associated with odd periodic solutions

If 20.2.19 is suitably combined with 20.2.13-20.2.18 there result four types of continued fractions, the roots of which yield the required characteristic values

20.2.21 $V_0 - \frac{2}{V_2 - \frac{1}{V_4 - \frac{1}{V_6 - \dots}}} = 0 \quad \text{Roots: } a_{2r}$

20.2.22

$$V_1 - 1 - \frac{1}{V_3 - \frac{1}{V_5 - \frac{1}{V_7 - \dots}}} = 0 \quad \text{Roots: } a_{2r+1}$$

20.2.23 $V_2 - \frac{1}{V_4 - \frac{1}{V_6 - \frac{1}{V_8 - \dots}}} = 0 \quad \text{Roots: } b_{2r}$

20.2.24

$$V_1 + 1 - \frac{1}{V_3 - \frac{1}{V_5 - \frac{1}{V_7 - \dots}}} = 0 \quad \text{Roots: } b_{2r+1}$$

If a is a root of 20.2.21-20.2.24, then the corresponding solution exists and is an entire function of z , for general complex values of q .

If q is real, then the Sturmian theory of second order linear differential equations yields the

*See page II.

following:

- (a) For a fixed real q , characteristic values a_r and b_r are real and distinct, if $q \neq 0$; $a_0 < b_1 < a_1 < b_2 < a_2 < \dots$, $q > 0$ and $a_r(q)$, $b_r(q)$ approach r^2 as q approaches zero.
- (b) A solution of 20.1.1 associated with a_r or b_r has r zeros in the interval $0 \leq z < \pi$, (q real).
- (c) The form of 20.2.21 and 20.2.23 shows that if a_{2r} is a root of 20.2.21 and q is different from zero, then a_{2r} cannot be a root of 20.2.23; similarly, no root of 20.2.22 can be a root of 20.2.24 if $q \neq 0$. It may be shown from other considerations that for a given point (a , q) there can be at most one periodic solution of period π or 2π if $q \neq 0$. This no longer holds for solutions of period $s\pi$, $s \geq 3$; for these all solutions are periodic, if one is.

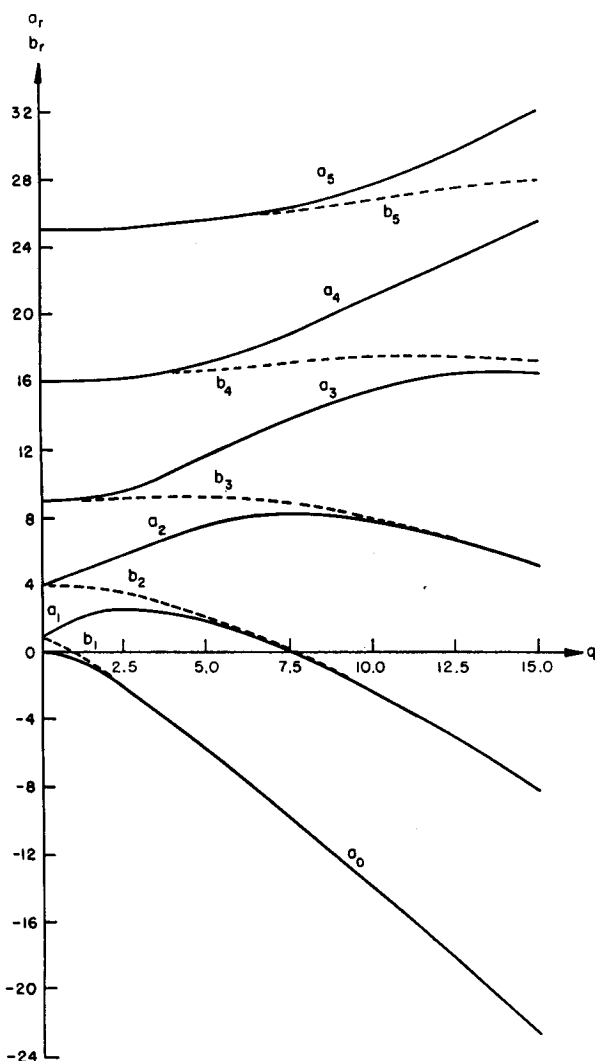

FIGURE 20.1. Characteristic Values a_r , b_r $r=0,1(1)5$

Power Series for Characteristic Values

20.2.25

$$a_0(q) = -\frac{q^2}{2} + \frac{7q^4}{128} - \frac{29q^6}{2304} + \frac{68687q^8}{18874368} + \dots$$

$$a_1(-q) = 1 - q - \frac{q^2}{8} + \frac{q^3}{64} - \frac{q^4}{1536} - \frac{11q^5}{36864} + \frac{49q^6}{589824} \\ b_1(q) = -\frac{55q^7}{9437184} - \frac{83q^8}{35389440} + \dots$$

$$b_2(q) = 4 - \frac{q^2}{12} + \frac{5q^4}{13824} - \frac{289q^6}{79626240} \\ + \frac{21391q^8}{458647142400} + \dots$$

$$a_2(q) = 4 + \frac{5q^2}{12} - \frac{763q^4}{13824} + \frac{1002401q^6}{79626240} \\ - \frac{1669068401q^8}{458647142400} + \dots$$

$$a_3(-q) = 9 + \frac{q^2}{16} - \frac{q^3}{64} + \frac{13q^4}{20480} + \frac{5q^5}{16384} \\ b_3(q) = -\frac{1961q^6}{23592960} + \frac{609q^7}{104857600} + \dots$$

$$b_4(q) = 16 + \frac{q^2}{30} - \frac{317q^4}{864000} + \frac{10049q^6}{2721600000} + \dots$$

$$a_4(q) = 16 + \frac{q^2}{30} + \frac{433q^4}{864000} - \frac{5701q^6}{2721600000} + \dots$$

$$a_5(-q) = 25 + \frac{q^2}{48} + \frac{11q^4}{774144} - \frac{q^5}{147456} \\ b_5(q) = +\frac{37q^6}{891813888} + \dots$$

$$b_6(q) = 36 + \frac{q^2}{70} + \frac{187q^4}{43904000} - \frac{5861633q^6}{92935987200000} + \dots$$

$$a_6(q) = 36 + \frac{q^2}{70} + \frac{187q^4}{43904000} + \frac{6743617q^6}{92935987200000} + \dots$$

For $r \geq 7$, and $|q|$ not too large, a_r is approximately equal to b_r , and the following approximation may be used

20.2.26

$$\left. \begin{array}{l} a_r \\ b_r \end{array} \right\} = r^2 + \frac{q^2}{2(r^2-1)} + \frac{(5r^2+7)q^4}{32(r^2-1)^3(r^2-4)} \\ + \frac{(9r^4+58r^2+29)q^6}{64(r^2-1)^5(r^2-4)(r^2-9)} + \dots$$

The above expansion is not limited to integral values of r , and it is a very good approximation for r of the form $n + \frac{1}{2}$ where n is an integer. In case of integral values of $r = n$, the series holds only up to terms not involving $r^2 - n^2$ in the denominator. Subsequent terms must be derived specially (as shown by Mathieu). Mulholland and Goldstein [20.38] have computed characteristic values for purely imaginary q and found that a_0 and a_2 have a common real value for $|q|$ in the neighborhood of 1.468; Bouwkamp [20.5] has computed this number as $q_0 = \pm i 1.46876852$ to 8 decimals. For values of $-iq > -iq_0$, a_0 and a_2 are conjugate complex numbers. From equation 20.2.25 it follows that the radius of convergence for the series defining a_0 is no greater than $|q_0|$. It is shown in [20.36], section 2.25 that the radius of convergence for $a_{2n}(q)$, $n \geq 2$ is greater than 3. Furthermore

$$a_r - b_r = O(q^r / r^{r-1}), \quad r \rightarrow \infty.$$

Power Series in q for the Periodic Functions (for sufficiently small $|q|$)

20.2.27

$$ce_0(z, q) = 2^{-1} \left[1 - \frac{q}{2} \cos 2z + q^2 \left(\frac{\cos 4z}{32} - \frac{1}{16} \right) - q^3 \left(\frac{\cos 6z}{1152} - \frac{11 \cos 2z}{128} \right) + \dots \right]$$

$$ce_1(z, q) = \cos z - \frac{q}{8} \cos 3z + q^2 \left[\frac{\cos 5z}{192} - \frac{\cos 3z}{64} - \frac{\cos z}{128} \right] - q^3 \left[\frac{\cos 7z}{9216} - \frac{\cos 5z}{1152} - \frac{\cos 3z}{3072} + \frac{\cos z}{512} \right] + \dots$$

$$se_1(z, q) = \sin z - \frac{q}{8} \sin 3z + q^2 \left[\frac{\sin 5z}{192} + \frac{\sin 3z}{64} - \frac{\sin z}{128} \right] - q^3 \left[\frac{\sin 7z}{9216} + \frac{\sin 5z}{1152} - \frac{\sin 3z}{3072} - \frac{\sin z}{512} \right] + \dots$$

$$ce_2(z, q) = \cos 2z - q \left(\frac{\cos 4z}{12} - \frac{1}{4} \right) + q^2 \left(\frac{\cos 6z}{384} - \frac{19 \cos 2z}{288} \right) + \dots$$

$$se_2(z, q) = \sin 2z - q \frac{\sin 4z}{12} + q^2 \left(\frac{\sin 6z}{384} - \frac{\sin 2z}{288} \right) + \dots$$

20.2.28

$$ce_r(z, q) = \cos(rz - p(\pi/2)) - q \left\{ \frac{\cos \left[(r+2)z - p \frac{\pi}{2} \right]}{4(r+1)} - \frac{\cos \left[(r-2)z - p(\pi/2) \right]}{4(r-1)} \right\} + q^2 \left\{ \frac{\cos \left[(r+4)z - p(\pi/2) \right]}{32(r+1)(r+2)} + \frac{\cos \left[(r-4)z - p(\pi/2) \right]}{32(r-1)(r-2)} - \frac{\cos \left[rz - p(\pi/2) \right] \left[\frac{2(r^2+1)}{(r^2-1)^2} \right]}{32} \right\} + \dots$$

with $p=0$ for $ce_r(z, q)$, $p=1$ for $se_r(z, q)$, $r \geq 3$.

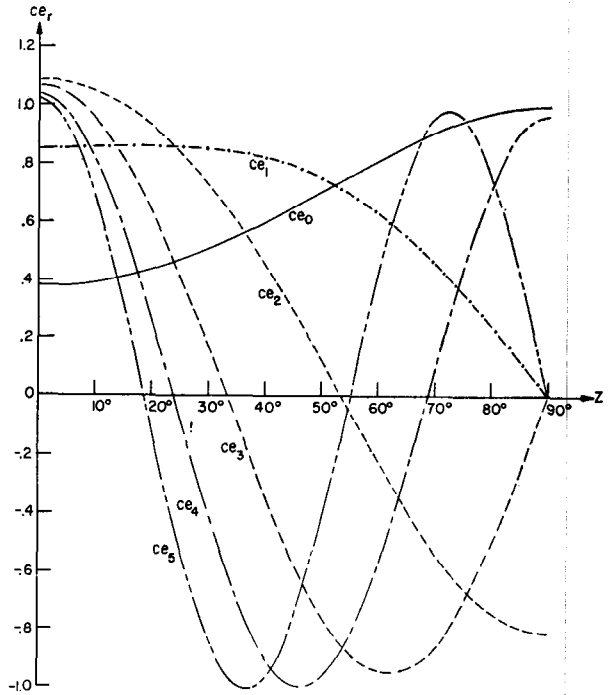

FIGURE 20.2. Even Periodic Mathieu Functions, Orders 0-5 $q=1$.

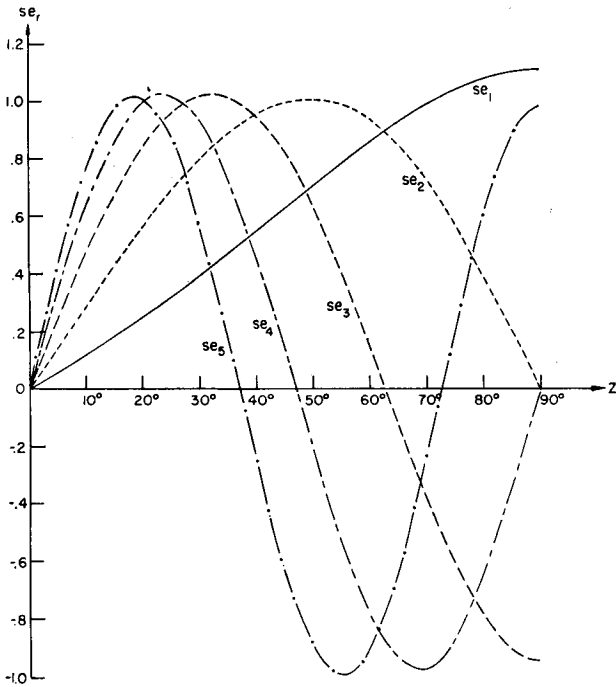

FIGURE 20.3. Odd Periodic Mathieu Functions, Orders 1-5 $q=1$.

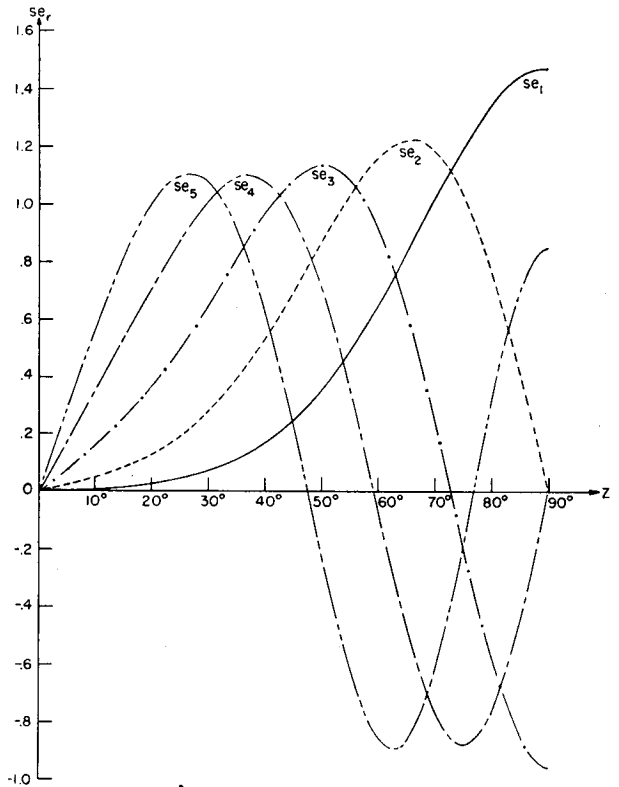

FIGURE 20.5. Odd Periodic Mathieu Functions, Orders 1-5 $q=10$.

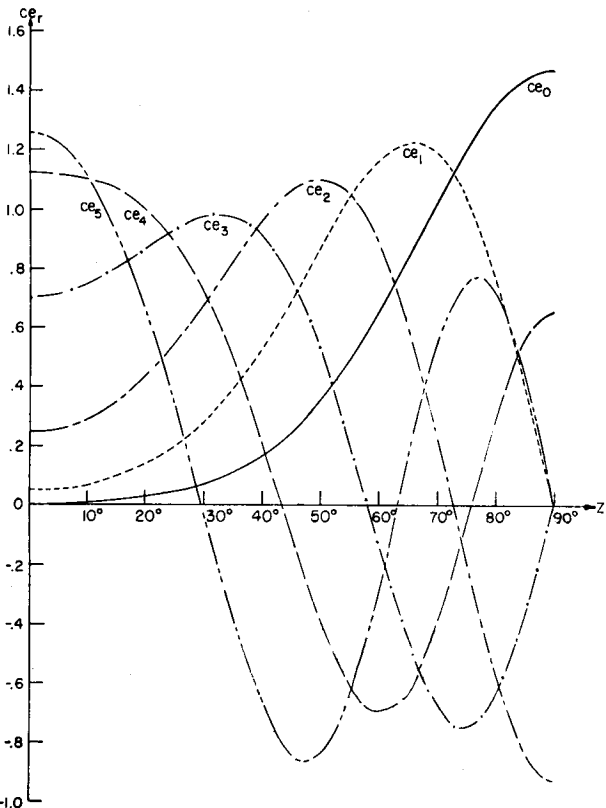

FIGURE 20.4. Even Periodic Mathieu Functions, Orders 0-5 $q=10$.

For coefficients associated with above functions

20.2.29

$$A_0^0(0) = 2^{-1/2}; A_r^r(0) = B_r^r(0) = 1, r > 0$$

$$A_{2s}^0 = [(-1)^s q^s / s! s! 2^{2s-1}] A_0^0 + \dots, s > 0$$

$$\begin{aligned} A_{r+2s}^r &= [(-1)^s r! q^s / 4^s (r+s)! s!] C_r^r + \dots \\ B_{r+2s}^r & \end{aligned}$$

$$rs > 0, C_r^r = A_r^r \text{ or } B_r^r$$

$$A_{r-2s}^r \text{ or } B_{r-2s}^r = \frac{(r-s-1)! q^s}{s! (r-1)! 4^s} C_r^r + \dots$$

Asymptotic Expansion for Characteristic Values, $q \gg 1$

Let $w = 2r + 1, q = w^4 \varphi, \varphi$ real. Then

20.2.30

$$a \sim b_{r+1} \sim -2q + 2w\sqrt{q} - \frac{w^2 + 1}{8} - \frac{\left(w + \frac{3}{w}\right)}{2^7 \sqrt{\varphi}}$$

$$-\frac{d_1}{2^{12} \varphi} - \frac{d_2}{2^{17} \varphi^{3/2}} - \frac{d_3}{2^{20} \varphi^2} - \frac{d_4}{2^{25} \varphi^{5/2}} - \dots$$

where

$$d_1 = 5 + \frac{34}{w^2} + \frac{9}{w^4}$$

$$d_2 = \frac{33}{w} + \frac{410}{w^3} + \frac{405}{w^5}$$

$$d_3 = \frac{63}{w^2} + \frac{1260}{w^4} + \frac{2943}{w^6} + \frac{486}{w^8}$$

$$d_4 = \frac{527}{w^3} + \frac{15617}{w^5} + \frac{69001}{w^7} + \frac{41607}{w^9}$$

20.2.31 $b_{r+1} - a_r \sim 2^{4r+5} \sqrt{2/\pi} q^{4r+1} e^{-4\sqrt{q}/r!}, \quad q \rightarrow \infty$

(given in [20.36] without proof.)

20.3. Floquet's Theorem and Its Consequences

Since the coefficients of Mathieu's equation

20.3.1 $y'' + (a - 2q \cos 2z)y = 0$

are periodic functions of z , it follows from the known theory relating to such equations that there exists a solution of the form

20.3.2 $F_\nu(z) = e^{i\nu z} P(z),$

where ν depends on a and q , and $P(z)$ is a periodic function, of the same period as that of the coefficients in **20.3.1**, namely π . (Floquet's theorem; see [20.16] or [20.22] for its more general form.) The constant ν is called the *characteristic exponent*. Similarly

20.3.3 $F_\nu(-z) = e^{-i\nu z} P(-z)$

satisfies **20.3.1** whenever **20.3.2** does. Both $F_\nu(z)$ and $F_\nu(-z)$ have the property

20.3.4

$y(z+k\pi) = C^k y(z), y = F_\nu(z)$ or $F_\nu(-z),$
 $C = e^{i\nu\pi}$ for $F_\nu(z), C = e^{-i\nu\pi}$ for $F_\nu(-z)$

Solutions having the property **20.3.4** will hereafter be termed *Floquet solutions*. Whenever $F_\nu(z)$ and $F_\nu(-z)$ are linearly independent, the general solution of **20.3.1** can be put into the form

20.3.5 $y = AF_\nu(z) + BF_\nu(-z)$

If $AB \neq 0$, the above solution will *not be a Floquet solution*. It will be seen later, from the method for determining ν when a and q are given, that there is some ambiguity in the definition of ν ; namely, ν can be replaced by $\nu + 2k$, where k is an arbitrary integer. This is as it should be, since the addition of the factor $\exp(2ikz)$ in **20.3.2** still leaves a periodic function of period π for the coefficient of $\exp i\nu z$.

It turns out that when a belongs to the set of characteristic values a_r and b_r of **20.2**, then ν is zero or an integer. It is convenient to associate $\nu = r$ with $a_r(q)$, and $\nu = -r$ with $b_r(q)$; see [20.36]. In the special case when ν is an integer, $F_\nu(z)$ is

proportional to $F_\nu(-z)$; the second, independent solution of **20.3.1** then has the form

20.3.6 $y_2 = z c e_\nu(z, q) + \sum_{k=0}^{\infty} d_{2k+p} \sin(2k+p)z,$
 associated with $c e_\nu(z, q)$

20.3.7 $y_2 = z s e_\nu(z, q) + \sum_{k=0}^{\infty} f_{2k+p} \cos(2k+p)z,$
 associated with $s e_\nu(z, q)$

The coefficients d_{2k+p} and f_{2k+p} depend on the corresponding coefficients A_m and B_m , respectively, of **20.2**, as well as on a and q . See [20.30], section (7.50)-(7.51) and [20.58], section V, for details.

If ν is not an integer, then the Floquet solutions $F_\nu(z)$ and $F_\nu(-z)$ are linearly independent. It is clear that **20.3.2** can be written in the form

20.3.8 $F_\nu(z) = \sum_{k=-\infty}^{\infty} c_{2k} e^{i(\nu+2k)z}.$

From **20.3.8** it follows that if ν is a proper fraction m_1/m_2 , then every solution of **20.3.1** is periodic, and of period at most $2\pi m_2$. This agrees with results already noted in **20.2**; i.e., both independent solutions are periodic, if one is, provided the period is different from π and 2π .

Method of Generating the Characteristic Exponent

Define two linearly independent solutions of **20.3.1**, for fixed a, q by

20.3.9 $y_1(0) = 1; y_1'(0) = 0.$
 $y_2(0) = 0; y_2'(0) = 1.$

Then it can be shown that

20.3.10 $\cos \pi\nu - y_1(\pi) = 0$

20.3.11 $\cos \pi\nu - 1 - 2y_1'(\frac{\pi}{2}) y_2(\frac{\pi}{2}) = 0$

Thus ν may be obtained from a knowledge of $y_1(\pi)$ or from a knowledge of both $y_1'(\frac{\pi}{2})$ and $y_2(\frac{\pi}{2})$.

For numerical purposes **20.3.11** may be more desirable because of the shorter range of integration, and hence the lesser accumulation of round-off errors. Either $\nu, -\nu$, or $\pm\nu + 2k$ (k an arbitrary integer) can be taken as the solution of **20.3.11**. Once ν has been fixed, the coefficients of **20.3.8** can be determined, except for an arbitrary multiplier which is independent of z .

The characteristic exponent can also be computed from a continued fraction, in a manner analogous to developments in **20.2**, if a sufficiently close first approximation to ν is available. For

systematic tabulation, this method is considerably faster than the method of numerical integration. Thus, when 20.3.8 is substituted into 20.3.1, there result the following recurrence relations:

20.3.12 $V_{2n}c_{2n} = c_{2n-2} + c_{2n+2}$

where

20.3.13 $V_{2n} = [a - (2n + \nu)^2] / q, -\infty < n < \infty.$

When ν is complex, the coefficients V_{2n} may also be complex. As in 20.2, it is possible to generate the ratios

$G_m = c_m / c_{m-2}$ and $H_{-m} = c_{-m-2} / c_{-m}$

from the continued fractions

20.3.14

$$G_m = \frac{1}{V_m - \frac{1}{V_{m+2} - \dots}}, \quad m \geq 0$$

$$H_{-m} = \frac{1}{V_{-m-2} - \frac{1}{V_{-m-4} - \dots}}, \quad m \geq 0.$$

From the form of 20.3.13 and the known properties of continued fractions it is assured that for sufficiently large values of $|m|$ both $|G_m|$ and $|H_{-m}|$ converge. Once values of G_m and H_{-m} are available for some sufficiently large value of m , then the finite number of ratios $G_{m-2}, G_{m-4}, \dots, G_0$ can be computed in turn, if they exist. Similarly for H_{-m+2}, \dots, H_0 . It is easy to show that ν is the correct characteristic exponent, appropriate for the point (a, q) , if and only if $H_0 G_0 = 1$. An iteration technique can be used to improve the value of ν , by the method suggested in [20.3]. One coefficient c_j can be assigned arbitrarily; the rest are then completely determined. After all the c_j become available, a multiplier (depending on q but not on z) can be found to satisfy a prescribed normalization.

It is well known that continued fractions can be converted to determinantal form. Equation 20.3.14 can in fact be written as a determinant with an infinite number of rows—a special case of Hill's determinant. See [20.19], [20.36], [20.15], or [20.30] for details. Although the determinant has actually been used in computations where high-speed computers were available, the direct use of the continued fraction seems much less laborious.

Special Cases (a, q Real)

Corresponding to $q=0, y_1 = \cos \sqrt{a}z, y_2 = \sin \sqrt{a}z$; the Floquet solutions are $\exp(iaz)$ and $\exp(-iaz)$. As a, q vary continuously in the q - a plane, ν describes curves; ν is real when $(q, a), q \geq 0$ lies in the region between $a_r(q)$ and $b_{r+1}(q)$ and

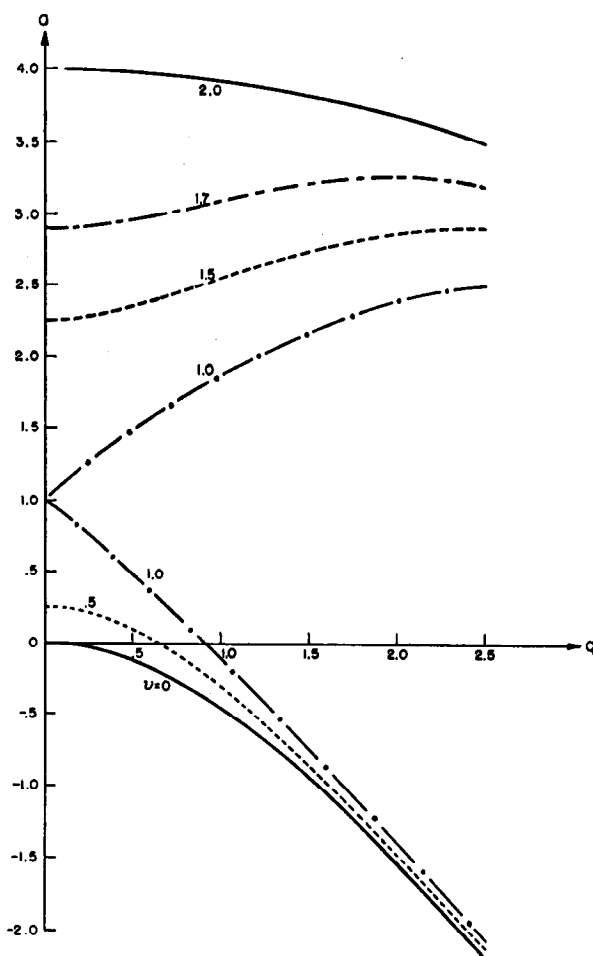

FIGURE 20.6. Characteristic Exponent-First Two Stable Regions $y = e^{\nu z} P(x)$ where $P(x)$ is a periodic function of period π .

Definition of ν ;

- In first stable region, $0 \leq \nu \leq 1,$
- In second stable region, $1 \leq \nu \leq 2.$

(Constructed from tabular values supplied by T. Tamir, Brooklyn Polytechnic Institute)

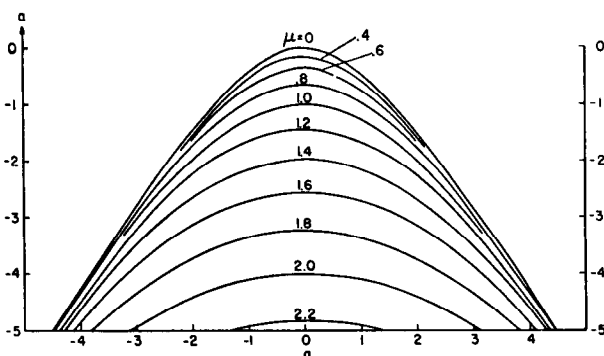

FIGURE 20.7. Characteristic Exponent in First Unstable Region. Differential equation: $y'' + (a - 2q \cos 2x)y = 0$. The Floquet solution $y = e^{\nu z} P(x)$, where $P(x)$ is a periodic function of period π . In the first unstable region, $\nu = i\mu$; μ is given for $a \geq -5$. (Constructed at NBS.)

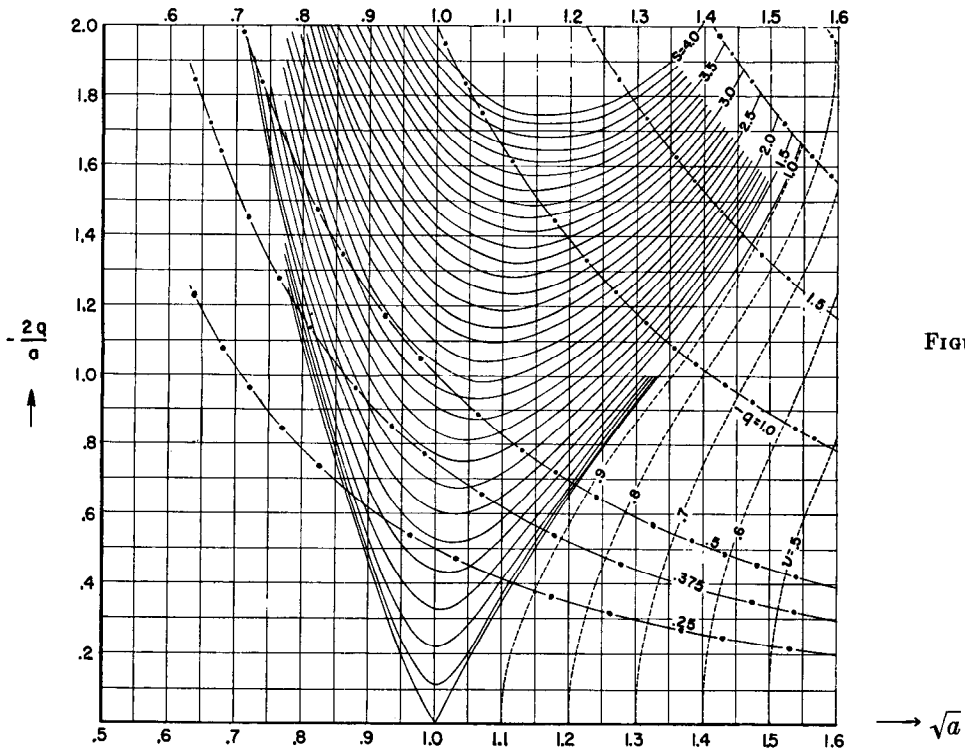

FIGURE 20.8

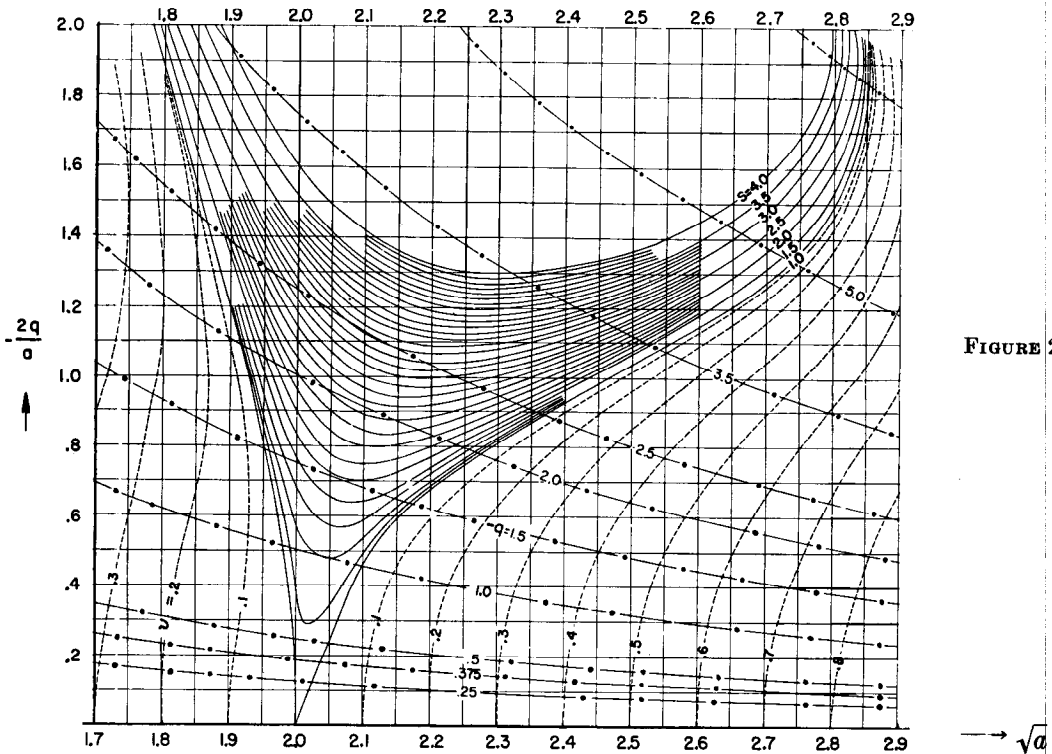

FIGURE 20.9

Charts of the Characteristic Exponent.

(From S. J. Zarodny, An elementary review of the Mathieu-Hill equation of real variable based on numerical solutions, Ballistic Research Laboratory Memo. Rept. 878, Aberdeen Proving Ground, Md., 1955, with permission.)

- $s = e^{i\pi r} = \text{constant}$; in unstable regions
- - - $\nu = \text{constant}$; in stable regions
- . - Lines of constant values of $-q$.

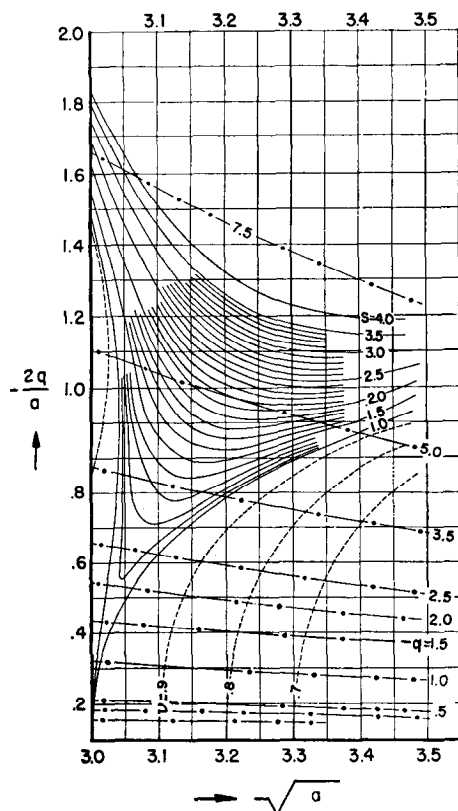

FIGURE 20.10. Chart of the Characteristic Exponent.

(From S. J. Zarodny, An elementary review of the Mathieu-Hill equation of real variable based on numerical solutions, Ballistic Research Laboratory Memo. Rept. 878, Aberdeen Proving Ground, Md., 1955, with permission)

- $s = e^{i\nu\pi} = \text{constant}$; in unstable regions
- - - $\nu = \text{constant}$; in stable regions
- . - . Lines of constant values of $-q$.

all solutions of 20.1.1 for real z are therefore bounded (stable); ν is complex in regions between b_r and a_r ; in these regions every solution becomes infinite at least once; hence these regions are termed "unstable regions". The characteristic curves a_r , b_r separate the regions of stability. For negative q , the stable regions are between b_{2r+1} and b_{2r+2} , a_{2r} and a_{2r+1} ; the unstable regions are between a_{2r+1} and b_{2r+1} , a_{2r} and b_{2r} .

In some problems solutions are required for real values of z only. In such cases a knowledge of the characteristic exponent ν and the periodic function $P(z)$ is sufficient for the evaluation of the required functions. For complex values of z , however, the series defining $P(z)$ converges slowly. Other solutions will be determined in the next section; they all have the remarkable property that they depend on the same coefficients c_m developed in connection with Floquet's theorem (except for an arbitrary normalization factor).

Expansions for Small q ([20.36] chapter 2)

If ν, q are fixed:

20.3.15

$$a = \nu^2 + \frac{q^2}{2(\nu^2 - 1)} + \frac{(5\nu^2 + 7)q^4}{32(\nu^2 - 1)^3(\nu^2 - 4)} + \frac{(9\nu^4 + 58\nu^2 + 29)q^6}{64(\nu^2 - 1)^5(\nu^2 - 4)(\nu^2 - 9)} + \dots \quad (\nu \neq 1, 2, 3).$$

For the coefficients c_2 , of 20.3.8

20.3.16

$$c_2/c_0 = \frac{-q}{4(\nu + 1)} - \frac{(\nu^2 + 4\nu + 7)q^3}{128(\nu + 1)^3(\nu + 2)(\nu - 1)} + \dots \quad (\nu \neq 1, 2)$$

$$c_4/c_0 = q^2/32(\nu + 1)(\nu + 2) + \dots$$

$$c_{2s}/c_0 = (-1)^s q^s \Gamma(\nu + 1) / 2^{2s} s! \Gamma(\nu + s + 1) + \dots$$

20.3.17

$$F_\nu(z) = c_0 \left[e^{i\nu z} - q \left\{ \frac{e^{i(\nu+2)z}}{4(\nu+1)} - \frac{e^{i(\nu-2)z}}{4(\nu-1)} \right\} \right] + \dots \quad (\nu \text{ not an integer})$$

For small values of a

20.3.18

$$\cos \nu\pi = \left(1 - \frac{a\pi^2}{2} + \frac{a^2\pi^4}{24} + \dots \right) - \frac{q^2\pi^2}{4} \left[1 + a \left(1 - \frac{\pi^2}{6} \right) + \dots \right] + q^4 \left(\frac{\pi^4}{96} - \frac{25\pi^2}{256} + \dots \right) + \dots$$

20.4. Other Solutions of Mathieu's Equation

Following Erdélyi [20.14], [20.15], define

20.4.1 $\varphi_k(z) = [e^{i\pi} \cos(z-b)/\cos(z+b)]^{1/2} J_k(f)$

where

20.4.2 $f = 2[q \cos(z-b) \cos(z+b)]^{1/2}$,

and $J_k(f)$ is the Bessel function of order k ; b is a fixed, arbitrary complex number. By using the recurrence relations for Bessel functions the following may be verified:

20.4.3

$$\frac{d^2\varphi_k}{dz^2} - 2q(\cos 2z)\varphi_k + q(\varphi_{k-2} + \varphi_{k+2}) + k^2\varphi_k = 0.$$

It follows that a formal solution of 20.1.1 is given by

20.4.4 $y = \sum_{n=-\infty}^{\infty} c_{2n} \varphi_{2n+\nu}$

where the coefficients c_{2n} are those associated with Floquet's solution. In the above, ν may be complex. Except for the special case when ν is an integer, the following holds:

$$\frac{\varphi_{2n+\nu-2}}{\varphi_{2n+\nu}} \sim \frac{\varphi_{-2n+\nu}}{\varphi_{-2n+\nu+2}} \sim \frac{-4n^2}{q [\cos(z-b)]^2} \quad (n \rightarrow \infty)$$

If ν and n are integers, $J_{-2n+\nu}(f) = (-1)^\nu J_{2n-\nu}(f)$.

$$[\varphi_{2n+\nu}/\varphi_{2n+\nu-2}] \sim -[\cos(z-b)]^2 q/4n^2$$

$$[\varphi_{-2n+\nu}/\varphi_{-2n+\nu+2}] \sim -4n^2/q [\cos(z-b)]^2$$

On the other hand

$$\frac{c_{2n}}{c_{2n-2}} \sim \frac{c_{-2n}}{c_{-2n+2}} \sim \frac{-q}{4n^2} \quad (n \rightarrow \infty)$$

It follows that **20.4.4** converges absolutely and uniformly in every closed region where

$$|\cos(z-b)| > d_1 > 1.$$

There are two such disjoint regions:

(I) $\mathcal{I}(z-b) > d_2 > 0; (|\cos(z-b)| > d_1 > 1)$

(II) $\mathcal{I}(z-b) < -d_2 < 0; (|\cos(z-b)| > d_1 > 1)$

If ν is an integer **20.4.4** converges for all values of z . Various representations are found by specializing b .

20.4.5

If $b=0, y=e^{i\pi\nu/2} \sum_{n=-\infty}^{\infty} c_{2n}(-1)^n J_{2n+\nu}(2\sqrt{q} \cos z)$
 $(|\cos z| > 1, |\arg 2\sqrt{q} \cos z| \leq \pi)$

20.4.6

If $b=\frac{\pi}{2}, y=\sum_{n=-\infty}^{\infty} c_{2n} J_{2n+\nu}(2i\sqrt{q} \sin z)$
 $(|\sin z| > 1, |\arg 2\sqrt{q} \sin z| \leq \pi)$

If $b \rightarrow \infty i, y$ reduces to a multiple of the solution **20.3.8**. The fact that **20.3.8, 20.4.5, and 20.4.6** are special cases of **20.4.4** explains why it is that these apparently dissimilar expansions involve the same set of coefficients c_{2n} .

Since **20.4.4** results from the recurrence properties of Bessel functions, $J_k(f)$ can be replaced by $H_k^{(j)}(f), j=1, 2$, where $H_k^{(j)}$ is the Hankel function, at least formally. Thus let

$$\psi_k^j = [e^{i\pi} \cos(z-b)/\cos(z+b)]^{jk} H_k^{(j)}(f)$$

where f satisfies **20.4.2**. An examination of the ratios $\psi_{2n+\nu}/\psi_{2n+\nu-2}$ shows that

$$y = \sum_{n=-\infty}^{\infty} c_{2n} \psi_{2n+\nu}^{(j)}$$

will be a solution provided

$$|\cos(z-b)| > 1; |\cos(z+b)| > 1.$$

The above two conditions are necessary even when ν is an integer. Once b is fixed, the regions in which the solutions converge can be readily established.

Following [20.36] let

20.4.7

$$J_p(x) = Z_p^{(1)}(x); \quad Y_p(x) = Z_p^{(2)}(x); \\ H_p^{(1)}(x) = Z_p^{(3)}(x); \quad H_p^{(2)}(x) = Z_p^{(4)}(x)$$

If z is replaced by $-iz$ in **20.4.5** and **20.4.6** solutions of **20.1.2** are obtained. Thus

20.4.8

$$y_1^{(j)}(z) = \sum_{n=-\infty}^{\infty} c_{2n} (-1)^n Z_{2n+\nu}^{(j)}(2\sqrt{q} \cosh z) \\ (|\cosh z| > 1)$$

20.4.9

$$y_2^{(j)}(z) = \sum_{n=-\infty}^{\infty} c_{2n} Z_{2n+\nu}^{(j)}(2\sqrt{q} \sinh z) \\ (|\sinh z| > 1, j=1, 2, 3, 4)$$

The relation between $y_1^{(j)}(z)$ and $y_2^{(j)}(z)$ can be determined from the asymptotic properties of the Bessel functions for large values of argument. It can be shown that

20.4.10

$$y_1^{(j)}(z)/y_2^{(j)}(z) = [F_\nu(0)/F_\nu(\frac{\pi}{2})] e^{i\nu\pi/2} \quad (\Re z > 0).$$

When ν is not an integer, the above solutions do not vanish identically. See **20.6** for integral values of ν .

Solutions Involving Products of Bessel Functions

20.4.11

$$y_3^{(j)}(z) = \frac{1}{c_{2s}} \sum_{n=-\infty}^{\infty} c_{2n} (-1)^n Z_{n+\nu+s}^{(j)}(\sqrt{q} e^{iz}) J_{n-s}(\sqrt{q} e^{-iz}) \\ (j=1, 2, 3, 4)$$

satisfies **20.1.1**, where $Z_n^{(j)}(u)$ is defined in **20.4.7**, the coefficients c_{2n} belong to the Floquet solution, and s is an arbitrary integer, $c_{2s} \neq 0$. The solution converges over the entire complex z -plane if $q \neq 0$. Written with z replaced by $-iz$, one obtains solutions of **20.1.2**.

20.4.12

$$M_i^j(z, q) = \frac{1}{c_{2s}^j} \sum_{n=-\infty}^{\infty} c_{2n}^j (-1)^n Z_{n+\nu+s}^{(j)}(\sqrt{q}e^z) J_{n-s}(\sqrt{q}e^{-z})$$

It can be verified from 20.4.8 and 20.4.12 that

20.4.13 $\frac{y_1^{(j)}(z)}{M_j^j(z, q)} = F_\nu(0), \quad (\Re z > 0)$

provided $c_{2s} \neq 0$. If $c_{2s} = 0$, the coefficient of $1/c_{2s}$ in 20.4.11 vanishes identically. For details see [20.43], [20.15], [20.36].

If s is chosen so that $|c_{2s}|$ is the largest coefficient of the set $|c_{2j}|$, then rapid convergence of 20.4.12 is obtained, when $\Re z > 0$. Even then one must be on guard against the possible loss of significant figures in the process of summing the series, especially so when q is large, and $|z|$ small. (If $j \neq 1$, then the phase of the logarithmic terms occurring in 20.4.12 must be defined, to make the functions single-valued.)

20.5. Properties of Orthogonality and Normalization

If $a(\nu+2p, q)$, $a(\nu+2s, q)$ are simple roots of 20.3.10 then

20.5.1 $\int_0^\pi F_{\nu+2p}(z) F_{\nu+2s}(-z) dz = 0$, if $p \neq s$.

Define

20.5.2 $ce_\nu(z, q) = \frac{1}{2} [F_\nu(z) + F_\nu(-z)]$
 $se_\nu(z, q) = -i \frac{1}{2} [F_\nu(z) - F_\nu(-z)]$

$ce_\nu(z, q)$, $se_\nu(z, q)$ are thus even and odd functions of z , respectively, for all ν (when not identically zero).

If ν is an integer, then $ce_\nu(z, q)$, $se_\nu(z, q)$ are either Floquet solutions or identically zero. The solutions $ce_r(z, q)$ are associated with a_r ; $se_r(z, q)$ are associated with b_r ; r an integer.

Normalization for Integral Values of ν and Real q

20.5.3 $\int_0^{2\pi} [ce_r(z, q)]^2 dz = \int_0^{2\pi} [se_r(z, q)]^2 dz = \pi$

For integral values of ν the summation in 20.3.8 reduces to the simpler forms 20.2.3-20.2.4; on account of 20.5.3, the coefficients A_m and B_m (for all orders r) have the property

20.5.4

$$2A_0^2 + A_2^2 + \dots = A_1^2 + A_3^2 + \dots = B_1^2 + B_3^2 + \dots = B_2^2 + B_4^2 + \dots = 1.$$

20.5.5

$$A_0^r = \frac{1}{2\pi} \int_0^{2\pi} ce_{2s}(z, q) dz; \quad A_n^r = \frac{1}{\pi} \int_0^{2\pi} ce_r(z, q) \cos n z dz$$

$$B_n^r = \frac{1}{\pi} \int_0^{2\pi} se_r(z, q) \sin n z dz \quad n \neq 0$$

For integral values of ν , the functions $ce_r(z, q)$ and $se_r(z, q)$ form a complete orthogonal set for the interval $0 \leq z \leq 2\pi$. Each of the four systems $ce_{2r}(z)$, $ce_{2r+1}(z)$, $se_{2r}(z)$, $se_{2r+1}(z)$ is complete in the smaller interval $0 \leq z \leq \frac{1}{2}\pi$, and each of the systems $ce_r(z)$, $se_r(z)$ is complete in $0 \leq z \leq \pi$.

If q is not real, there exist multiple roots of 20.3.10; for such special values of $a(q)$, the integrals in 20.5.3 vanish, and the normalization is therefore impossible. In applications, the particular normalization adopted is of little importance, except possibly for obtaining quantitative relations between solutions of various types. For this reason the normalization of $F_\nu(z)$, for arbitrary complex values of a, q , will not be specified here. It is worth noting, however, that solutions

$$\alpha ce_r(z, q), \quad \beta se_r(z, q)$$

defined so that

$$\alpha ce_r(0, q) = 1; \quad \left[\frac{d}{dz} \beta se_r(z, q) \right]_{z=0} = 1$$

are always possible. This normalization has in fact been used in [20.59], and also in [20.58], where the most extensive tabular material is available. The tabulated entries in [20.58] supply the conversion factors $A=1/\alpha$, $B=1/\beta$, along with the coefficients. Thus conversion from one normalization to another is rather easy.

In a similar vein, no general normalization will be imposed on the functions defined in 20.4.8.

20.6. Solutions of Mathieu's Modified Equation 20.1.2 for Integral ν (Radial Solutions)

Solutions of the first kind

20.6.1

$$C e_{2r+\nu}(z, q) = c e_{2r+\nu}(iz, q)$$

$$= \sum_{k=0}^{\infty} A_{2k+\nu}^{2r+\nu}(q) \cosh(2k+p) z$$

associated with a_r

20.6.2 $Se_{2r+p}(z, q) = -ise_{2r+p}(iz, q) = \sum_{k=0}^{\infty} B_{2k+p}^{2r+p}(q) \sinh(2k+p)z$, associated with b_r ,
 writing $A_{2k+p}^{2r+p}(q) = A_{2k+p}$ for brevity; similarly for B_{2k+p} ; $p=0, 1$,

20.6.3 $Ce_{2r}(z, q) = \frac{ce_{2r}\left(\frac{\pi}{2}, q\right)}{A_0^{2r}} \sum_{k=0}^{\infty} (-1)^k A_{2k} J_{2k}(2\sqrt{q} \cosh z) = \frac{ce_{2r}(0, q)}{A_0^{2r}} \sum_{k=0}^{\infty} A_{2k} J_{2k}(2\sqrt{q} \sinh z)$

20.6.4 $Ce_{2r+1}(z, q) = \frac{ce'_{2r+1}\left(\frac{\pi}{2}, q\right)}{\sqrt{q}A_1^{2r+1}} \sum_{k=0}^{\infty} (-1)^{k+1} A_{2k+1} J_{2k+1}(2\sqrt{q} \cosh z)$
 $= \frac{ce_{2r+1}(0, q)}{\sqrt{q}A_1^{2r+1}} \coth z \sum_{k=0}^{\infty} (2k+1) A_{2k+1} J_{2k+1}(2\sqrt{q} \sinh z)$

20.6.5 $Se_{2r}(z, q) = \frac{se'_{2r}\left(\frac{\pi}{2}, q\right) \tanh z}{qB_2^{2r}} \sum_{k=1}^{\infty} (-1)^k 2k B_{2k} J_{2k}(2\sqrt{q} \cosh z)$
 $= \frac{se'_{2r}(0, q)}{qB_2^{2r}} \coth z \sum_{k=1}^{\infty} 2k B_{2k} J_{2k}(2\sqrt{q} \sinh z)$

20.6.6 $Se_{2r+1}(z, q) = \frac{se_{2r+1}\left(\frac{\pi}{2}, q\right)}{\sqrt{q}B_1^{2r+1}} \tanh z \sum_{k=0}^{\infty} (-1)^k (2k+1) B_{2k+1} J_{2k+1}(2\sqrt{q} \cosh z)$
 $= \frac{se'_{2r+1}(0, q)}{\sqrt{q}B_1^{2r+1}} \sum_{k=0}^{\infty} B_{2k+1} J_{2k+1}(2\sqrt{q} \sinh z)$

See [20.30] for still other forms.

Solutions of the second kind, as well as solutions of the third and fourth kind (analogous to Hankel functions) are obtainable from **20.4.12**.

20.6.7 $Mc_{2r}^{(j)}(z, q) = \sum_{k=0}^{\infty} (-1)^{r+k} A_{2k}^{2r}(q) [J_{k-s}(u_1) Z_{k+s}^{(j)}(u_2) + J_{k+s}(u_1) Z_{k-s}^{(j)}(u_2)] / \epsilon_s A_{2s}^{2r}$

where $\epsilon_0=2, \epsilon_s=1$, for $s=1, 2, \dots$; s arbitrary, associated with a_{2r}

20.6.8 $Mc_{2r+1}^{(j)}(z, q) = \sum_{k=0}^{\infty} (-1)^{r+k} A_{2k+1}^{2r+1}(q) [J_{k-s}(u_1) Z_{k+s+1}^{(j)}(u_2) + J_{k+s+1}(u_1) Z_{k-s}^{(j)}(u_2)] / A_{2s+1}^{2r+1}$

associated with a_{2r+1}

20.6.9 $Ms_{2r}^{(j)}(z, q) = \sum_{k=1}^{\infty} (-1)^{k+r} B_{2k}^{2r}(q) [J_{k-s}(u_1) Z_{k+s}^{(j)}(u_2) - J_{k+s}(u_1) Z_{k-s}^{(j)}(u_2)] / B_{2s}^{2r}$, associated with b_{2r}

20.6.10 $Ms_{2r+1}^{(j)}(z, q) = \sum_{k=0}^{\infty} (-1)^{k+r} B_{2k+1}^{2r+1}(q) [J_{k-s}(u_1) Z_{k+s+1}^{(j)}(u_2) - J_{k+s+1}(u_1) Z_{k-s}^{(j)}(u_2)] / B_{2s+1}^{2r+1}$

associated with b_{2r+1}

where

$$u_1 = \sqrt{q}e^{-z}, u_2 = \sqrt{q}e^z, B_{2s+p}^{2r+p}, A_{2s+p}^{2r+p} \neq 0, p=0, 1.$$

See **20.4.7** for definition of $Z_m^{(j)}(x)$.

Solutions **20.6.7-20.6.10** converge for all values of z , when $q \neq 0$. If $j=2, 3, 4$ the logarithmic terms entering into the Bessel functions $Y_m(u_2)$ must be defined, to make the functions single-valued. This can be accomplished as follows:

Define (as in [20.58])

20.6.11 $\ln(\sqrt{q}e^z) = \ln(\sqrt{q}) + z$

See [20.15] and [20.36], section **2.75** for derivation.

Other Expressions for the Radial Functions (Valid Over More Limited Regions)

20.6.12
$$Mc_{2r}^{(j)}(z, q) = [ce_{2r}(0, q)]^{-1} \sum_{k=0}^{\infty} (-1)^{k+r} A_{2k}^{2r}(q) Z_{2k}^{(j)}(2\sqrt{q} \cosh z)$$

$$Mc_{2r+1}^{(j)}(z, q) = [ce_{2r+1}(0, q)]^{-1} \sum_{k=0}^{\infty} (-1)^{k+r} A_{2k+1}^{2r+1}(q) Z_{2k+1}^{(j)}(2\sqrt{q} \cosh z)$$

20.6.13
$$Ms_{2r}^{(j)}(z, q) = [se'_{2r}(0, q)]^{-1} \tanh z \sum_{k=1}^{\infty} (-1)^{k+r} 2k B_{2k}^{2r}(q) Z_{2k}^{(j)}(2\sqrt{q} \cosh z)$$

$$Ms_{2r+1}^{(j)}(z, q) = [se'_{2r+1}(0, q)]^{-1} \tanh z \sum_{k=0}^{\infty} (-1)^{k+r} (2k+1) B_{2k+1}^{2r+1}(q) Z_{2k+1}^{(j)}(2\sqrt{q} \cosh z)$$

Valid for $\Re z > 0, |\cosh z| > 1$; if $j=1$, valid for all z . They agree with 20.6.7–20.6.10 if the Bessel functions $Y_m(2q^{\frac{1}{2}} \cosh z)$ are made single-valued in a suitable way. For example, let

$$Y_m(u) = \frac{2}{\pi} (\ln u) J_m(u) + \phi(u)$$

where $\phi(u)$ is single-valued for all finite values of u . With $u=2q^{\frac{1}{2}} \cosh z$, define

20.6.14
$$\ln(2q^{\frac{1}{2}} \cosh z) = \ln 2q^{\frac{1}{2}} + z + \ln \frac{1}{2}(1 + e^{-2z}) \quad -\frac{\pi}{2} \leq \arg \frac{1}{2}(1 + e^{-2z}) \leq \frac{\pi}{2}$$

(If q is not positive, the phase of $\ln 2q^{\frac{1}{2}}$ must also be specified, although this specification will not affect continuity with respect to z . If $Y_m(u)$ is defined from some other expression, the definition must be compatible with 20.6.14.)

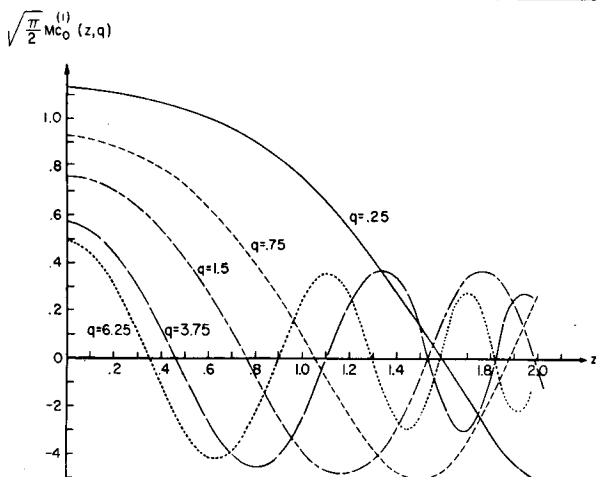

FIGURE 20.11. Radial Mathieu Function of the First Kind. (From J. C. Wiltse and M. J. King, Values of the Mathieu functions, The Johns Hopkins Univ. Radiation Laboratory Tech. Rept. AF-53, 1958, with permission)

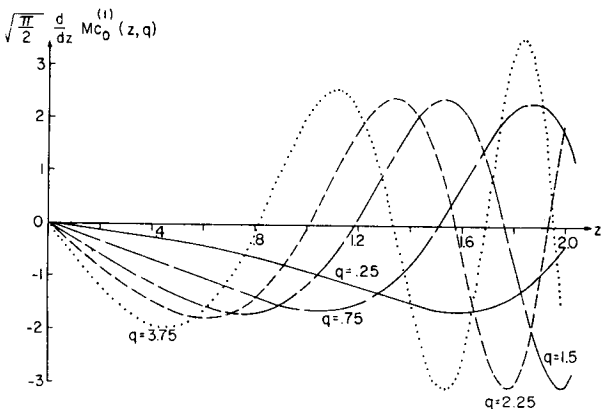

FIGURE 20.12. Derivative of the Radial Mathieu Function of the First Kind. (From J. C. Wiltse and M. J. King, Derivatives, zeros, and other data pertaining to Mathieu functions, The Johns Hopkins Univ. Radiation Laboratory Tech. Rept. AF-57, 1958, with permission)

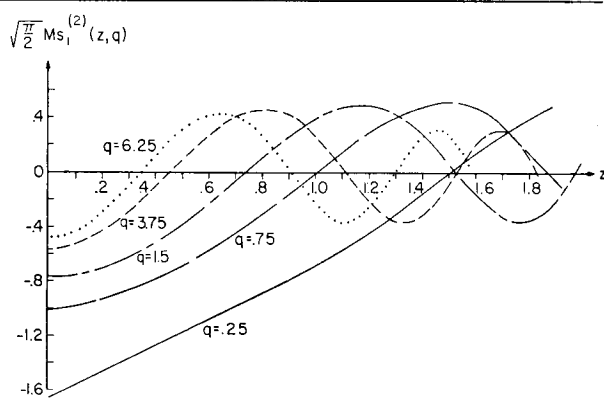

FIGURE 20.13. Radial Mathieu Function of the Second Kind. (From J. C. Wiltse and M. J. King, Values of the Mathieu functions, The Johns Hopkins Univ. Radiation Laboratory Tech. Rept. AF-53, 1958, with permission)

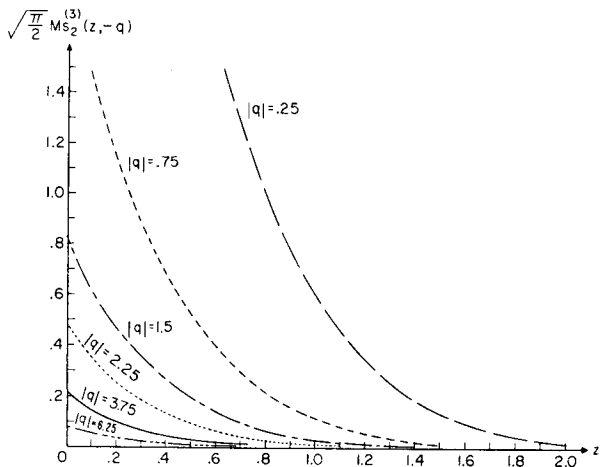

FIGURE 20.14. Radial Mathieu Function of the Third Kind. (From J. C. Wiltse and M. J. King, Values of the Mathieu functions, The Johns Hopkins Univ. Radiation Laboratory Tech. Rept. AF-53, 1958, with permission)

If $j=1$, $Mc_{2r+p}^{(1)}$ and $Ms_{2r+p}^{(1)}$, $p=0, 1$ are solutions of the first kind, proportional to Ce_{2r+p} and Se_{2r+p} respectively.

Thus

20.6.15

$$Ce_{2r}(z, q) = \frac{ce_{2r}\left(\frac{\pi}{2}, q\right) ce_{2r}(0, q)}{(-1)^r A_0^{2r}} Mc_{2r}^{(1)}(z, q)$$

$$Ce_{2r+1}(z, q) = \frac{ce'_{2r+1}\left(\frac{\pi}{2}, q\right) ce_{2r+1}(0, q)}{(-1)^{r+1} \sqrt{q} A_1^{2r+1}} Mc_{2r+1}^{(1)}(z, q)$$

$$Se_{2r}(z, q) = \frac{se_{2r}(0, q) se'_{2r}\left(\frac{\pi}{2}, q\right)}{(-1)^r q B_2^{2r}} Ms_{2r}^{(1)}(z, q)$$

$$Se_{2r+1}(z, q) = \frac{se'_{2r+1}(0, q) se_{2r+1}\left(\frac{\pi}{2}, q\right)}{(-1)^{r+1} \sqrt{q} B_1^{2r+1}} Ms_{2r+1}^{(1)}(z, q)$$

The Mathieu-Hankel functions are

20.6.16

$$M_r^{(3)}(z, q) = M_r^{(1)}(z, q) + iM_r^{(2)}(z, q)$$

$$M_r^{(4)}(z, q) = M_r^{(1)}(z, q) - iM_r^{(2)}(z, q)$$

$$M_r^{(j)} = Mc_r^{(j)} \text{ or } Ms_r^{(j)}.$$

From 20.6.7-20.6.11 and the known properties of Bessel functions one obtains

20.6.17

$$M_{2r+p}^{(2)}(z + in\pi, q) = (-1)^{np} [M_{2r+p}^{(2)}(z, q) + 2niM_{2r+p}^{(1)}(z, q)]$$

$$M_{2r+p}^{(3)}(z + in\pi, q) = (-1)^{np} [M_{2r+p}^{(3)}(z, q) - 2nM_{2r+p}^{(1)}(z, q)]$$

$$M_{2r+p}^{(4)}(z + in\pi, q) = (-1)^{np} [M_{2r+p}^{(4)}(z, q) + 2nM_{2r+p}^{(1)}(z, q)]$$

where $M=Mc$ or Ms throughout any of the above equations.

Other Properties of Characteristic Functions, q Real (Associated With a_r and b_r)

Consider

20.6.18

$$X_1 = Mc_r^{(2)}(z, q) + Mc_r^{(2)}(-z, q);$$

$$X_2 = Ms_r^{(2)}(z, q) - Ms_r^{(2)}(-z, q)$$

Since X_1 is an even solution it must be proportional to $Mc_r^{(1)}(z, q)$; for 20.1.2 admits of only one even solution (aside from an arbitrary constant factor). Similarly, X_2 is proportional to $Ms_r^{(1)}(z, q)$. The proportionality factors can be found by considering values of the functions at $z=0$. Define, therefore,

20.6.19

$$Mc_r^{(2)}(-z, q) = -Mc_r^{(2)}(z, q) - 2f_{e,r} Mc_r^{(1)}(z, q)$$

20.6.20

$$Ms_r^{(2)}(-z, q) = Ms_r^{(2)}(z, q) - 2f_{o,r} Ms_r^{(1)}(z, q)$$

where

20.6.21

$$f_{e,r} = -Mc_r^{(2)}(0, q) / Mc_r^{(1)}(0, q)$$

$$f_{o,r} = \left[\frac{d}{dz} Ms_r^{(2)}(z, q) / \frac{d}{dz} Ms_r^{(1)}(z, q) \right]_{z=0}$$

See [20.58].

In particular the above equations can be used to extend solutions of 20.6.12-20.6.13 when $\Re z < 0$. For although the latter converge for $\Re z < 0$, provided only $|\cosh z| > 1$, they do not represent the same functions as 20.6.9-20.6.10.

20.7. Representations by Integrals and Some Integral Equations

Let

20.7.1
$$G(u) = \oint_C K(u, t) V(t) dt$$

be defined for u in a domain U and let the contour C belong to the region T of the complex t -plane, with $t=\gamma_0$ as the starting point of the contour and $t=\gamma_1$ as its end-point. The kernel $K(u, t)$ and the function $V(t)$ satisfy 20.7.3 and the hypotheses in 20.7.2.

20.7.2 $K(u, t)$ and its first two partial derivatives with respect to u and t are continuous for t on C and u in U ; V and $\frac{dV}{dt}$ are continuous in t .

20.7.3

$$\left[\frac{\partial K}{\partial t} V - \frac{dV}{dt} K \right]_{\gamma_0}^{\gamma_1} = 0; \frac{d^2 V}{dt^2} + (a - 2q \cos 2t) V = 0.$$

If K satisfies

20.7.4
$$\frac{\partial^2 K}{\partial u^2} + \frac{\partial^2 K}{\partial t^2} + 2q(\cosh 2u - \cos 2t) K = 0$$

then $G(u)$ is a solution of Mathieu's modified equation 20.1.2.

If $K(u, t)$ satisfies

20.7.5
$$\frac{\partial^2 K}{\partial u^2} + \frac{\partial^2 K}{\partial t^2} + 2q(\cos 2u - \cos 2t) K = 0$$

then $G(u)$ is a solution of Mathieu's equation 20.1.1, with u replacing v .

Kernels $K_1(z, t)$ and $K_2(z, t)$

20.7.6 $K_1(z, t) = Z_{\nu}^{(j)}(u)[M(z, t)]^{-\nu/2}, \quad (\Re z > 0)$

where

20.7.7 $u = \sqrt{2q(\cosh 2z + \cos 2t)}$

20.7.8 $M(z, t) = \cosh(z + it) / \cosh(z - it)$

To make $M^{-1\nu}$ single-valued, define

20.7.9

$$\begin{aligned} \cosh(z + i\pi) &= e^{i\pi} \cosh z \\ \cosh(z - i\pi) &= e^{-i\pi} \cosh z \\ M(z, 0) &= 1 \\ [M(z, \pi)]^{-1\nu} &= e^{-i\nu\pi} M(z, 0) \end{aligned}$$

Let

20.7.10 $G(z, q) = \frac{1}{\pi} \int_0^{\pi} K_1(u, t) F_{\nu}(t) dt, \quad (\Re z > 0)$

where $F_{\nu}(t)$ is defined in 20.3.8. It may be verified that $K_1 F_{\nu}$ satisfies 20.7.3, K satisfies 20.7.2 and 20.7.4. Hence G is a solution of 20.1.2 (with z replacing u). It can be shown that K_1 may be replaced by the more general function

20.7.11

$K_2(z, t) = Z_{\nu+2s}^{(j)}(u)[M(z, t)]^{-1\nu+2s}, s$ any integer.

See 20.4.7 for definition of $Z_{\nu+2s}^{(j)}(u)$.

From the known expansions for $Z_{\nu+2s}^{(j)}(u)$ when $\Re z$ is large and positive it may be verified that

20.7.12

$M_{\nu}^{(j)}(z, q) =$

$$\frac{(-1)^s}{\pi c_{2s}} \int_0^{\pi} Z_{\nu+2s}^{(j)}(u) \left[\frac{\cosh z + it}{\cosh z - it} \right]^{-1\nu-2s} F_{\nu}(t) dt$$

$(\Re z > 0, \Re(\nu + \frac{1}{2}) > 0)$

where $M_{\nu}^{(j)}(z, q)$ is given by 20.4.12, $s = 0, 1, \dots, c_{2s} \neq 0$, and $F_{\nu}(t)$ is the Floquet solution, 20.3.8.

Kernel $K_3(z, t, a)$

20.7.13 $K_3(z, t, a) = e^{2i\sqrt{q}v}$

where

20.7.14 $w = \cosh z \cos a \cos t + \sinh z \sin a \sin t$

20.7.15 $G(z, q, a) = \frac{1}{\pi} \oint_C e^{2i\sqrt{q}v} F_{\nu}(t) dt$

where $F_{\nu}(t)$ is the Floquet solution 20.3.8. The path C is chosen so that $G(z, t, a)$ exists, and 20.7.2, 20.7.3 are satisfied. Then it may be verified that $K_3(z, t, a)$, considered as a function of z and t , satisfies 20.7.4; also, considered as a function of a and t , K_3 satisfies 20.7.5. Consequently $G(z, q, a) = Y(z, q)y(a, q)$, where Y and y satisfy 20.1.2 and 20.1.1, respectively.

Choice of Path C . Three paths will be defined:

20.7.16

Path C_3 : from $-d_1 + i\infty$ to $d_2 - i\infty$, d_1, d_2 real

$-d_1 < \arg[\sqrt{q}\{\cosh(z + ia) \pm 1\}] < \pi - d_1$

$-d_2 < \arg[\sqrt{q}\{\cosh(z - ia) \pm 1\}] < \pi - d_2$

20.7.17

Path C_4 : from $d_2 - i\infty$ to $2\pi + i\infty - d_1$

(same d_1, d_2 as in 20.7.16)

20.7.18

$$F_{\nu}(a)M_{\nu}^{(j)}(z, q) = \frac{e^{-i\nu\frac{\pi}{2}}}{\pi} \oint_{C_j} e^{2i\sqrt{q}v} F_{\nu}(t) dt \quad j=3, 4$$

where $M_{\nu}^{(j)}(z, q)$ is also given by 20.4.12.

20.7.19 Path C_1 : from $-d_1 + i\infty$ to $2\pi - d_1 + i\infty$

$$F_{\nu}(a)M_{\nu}^{(1)}(z, q) = \frac{e^{-i\nu\frac{\pi}{2}}}{2\pi} \oint_{C_1} e^{2i\sqrt{q}v} F_{\nu}(t) dt$$

See [20.36], section 2.68.

If ν is an integer the paths can be simplified; for in that case $F_{\nu}(t)$ is periodic and the integrals exist when the path is taken from 0 to 2π . Still further simplifications are possible, if z is also real.

The following are among the more important integral representations for the periodic functions $ce_r(z, q)$, $se_r(z, q)$ and for the associated radial solutions.

Let $r = 2s + p$, $p = 0$ or 1

20.7.20

$$ce_r(z, q) = \rho_r \int_0^{\pi/2} \cos\left(2\sqrt{q} \cos z \cos t - p\frac{\pi}{2}\right) ce_r(t, q) dt$$

20.7.21 $ce_r(z, q) = \sigma_r \int_0^{\pi/2} \cosh(2\sqrt{q} \sin z \sin t) [(1-p) + p \cos z \cos t] ce_r(t, q) dt$

20.7.22 $se_r(z, q) = \rho_r \int_0^{\pi/2} \sin\left(2\sqrt{q} \cos z \cos t + p \frac{\pi}{2}\right) \sin z \sin t se_r(t, q) dt$

20.7.23 $se_r(z, q) = \sigma_r \int_0^{\pi/2} \sinh(2\sqrt{q} \sin z \sin t) [(1-p) \cos z \cos t + p] se_r(t, q) dt$

where

20.7.24 $\rho_r = \frac{2}{\pi} ce_{2s}\left(\frac{\pi}{2}, q\right) / A_0^{2s}(q); p=0, \rho_r = -\frac{2}{\pi} ce'_{2s+1}\left(\frac{\pi}{2}, q\right) / \sqrt{q} A_1^{2s+1}(q)$ if $p=1$, for functions $ce_r(z, q)$

$\rho_r = \frac{-4}{\pi} se'_{2s}\left(\frac{\pi}{2}, q\right) / \sqrt{q} B_2^{2s}(q); \rho_r = \frac{4}{\pi} se_{2s+1}\left(\frac{\pi}{2}, q\right) / B_1^{2s+1}(q)$, for functions $se_r(z, q)$

$\sigma_r = \frac{2}{\pi} ce_{2s}(0, q) / A_0^{2s}(q)$ if $p=0$; $\sigma_r = \frac{4}{\pi} ce_{2s+1}(0, q) / A_1^{2s+1}(q)$, if $p=1$; associated with functions $ce_r(z, q)$

$\sigma_r = \frac{4}{\pi} se_{2s}(0, q) / \sqrt{q} B_2^{2s}(q)$, if $p=0$; $\sigma_r = \frac{2}{\pi} se'_{2s+1}(0, q) / \sqrt{q} B_1^{2s+1}(q)$, if $p=1$; associated with $se_r(z, q)$

Integrals Involving Bessel Function Kernels

Let

20.7.25 $u = \sqrt{2q(\cosh 2z + \cos 2t)}$, ($\mathcal{R} \cosh 2z > 1$; if $j=1$, valid also when $z=0$)

20.7.26

$Mc_{2r}^{(j)}(z, q) = \frac{(-1)^r 2}{\pi A_0^{2r}} \int_0^{\frac{\pi}{2}} Z_0^{(j)}(u) ce_{2r}(t, q) dt; Mc_{2r+1}^{(j)}(z, q) = \frac{(-1)^r 8\sqrt{q} \cosh z}{\pi A_1^{2r+1}} \int_0^{\frac{\pi}{2}} \frac{Z_1^{(j)}(u) \cos t}{u} ce_{2r+1}(t, q) dt$

20.7.27

$Ms_{2r}^{(j)}(z, q) = \frac{(-1)^{r+1} 8q \sinh 2z}{\pi B_2^{2r}} \int_0^{\frac{\pi}{2}} \frac{Z_2^{(j)}(u) \sin 2t se_{2r}(t, q) dt}{u^2}$

$Ms_{2r+1}^{(j)}(z, q) = \frac{(-1)^r 8\sqrt{q} \sinh z}{\pi B_1^{2r+1}} \int_0^{\frac{\pi}{2}} \frac{Z_1^{(j)}(u) \sin t se_{2r+1}(t, q) dt}{u}$

In the above the j -convention of 20.4.7 applies and the functions Mc, Ms are defined in 20.5.1-20.5.4. (These solutions are normalized so that they approach the corresponding Bessel-Hankel functions as $\mathcal{R}z \rightarrow \infty$.)

Other Integrals for $Mc^{(1)}(z, q)$ and $Ms^{(1)}(z, q)$

20.7.28 $Mc_r^{(1)}(z, q) = \frac{(-1)^{s2}}{\pi ce_r(0, q)} \int_0^{\frac{\pi}{2}} \cos\left(2\sqrt{q} \cosh z \cos t - p \frac{\pi}{2}\right) ce_r(t, q) dt$

20.7.29 $Mc_r^{(1)}(z, q) = \tau_r \int_0^{\frac{\pi}{2}} [(1-p) + p \cosh z \cos t] \cos(2\sqrt{q} \sinh z \sin t) ce_r(t, q) dt$

$r=2s+p, p=0, 1; \tau_r = \frac{2}{\pi} (-1)^s / ce_{2s}\left(\frac{\pi}{2}, q\right)$, if $p=0$; $\tau_r = \frac{2}{\pi} (-1)^{s+1} 2\sqrt{q} / ce'_{2s+1}\left(\frac{\pi}{2}, q\right)$

20.7.30 $Ms_{2r+1}^{(1)}(z, q) = \frac{2}{\pi} \frac{(-1)^r}{se_{2r+1}\left(\frac{\pi}{2}, q\right)} \int_0^{\frac{\pi}{2}} \sin(2\sqrt{q} \sinh z \sin t) se_{2r+1}(t, q) dt$

20.7.31 $Ms_{2r+1}^{(1)}(z, q) = \frac{4}{\pi} \frac{\sqrt{q} (-1)^r}{se'_{2r+1}(0, q)} \int_0^{\frac{\pi}{2}} \sinh z \sin t \cos(2\sqrt{q} \cosh z \cos t) se_{2r+1}(t, q) dt$

20.7.32 $Ms_{2r}^{(1)}(z, q) = \frac{4}{\pi} \sqrt{q} \frac{(-1)^{r+1}}{se'_{2r}(0, q)} \int_0^{\frac{\pi}{2}} \sin(2\sqrt{q} \cosh z \cos t) [\sinh z \sin t se_{2r}(t, q)] dt$

20.7.33 $Ms_{2r}^{(1)}(z, q) = \frac{4}{\pi} \frac{(-1)^r \sqrt{q}}{se'_{2r}\left(\frac{\pi}{2}, q\right)} \int_0^{\frac{\pi}{2}} \sin(2\sqrt{q} \sinh z \sin t) [\cosh z \cos t se_{2r}(t, q)] dt$

Further with $w = \cosh z \cos \alpha \cos t + \sinh z \sin \alpha \sin t$

$$20.7.34 \quad ce_r(\alpha, q) Mc_r^{(1)}(z, q) = \frac{(-1)^s(i)^{-p}}{2\pi} \int_0^{2\pi} e^{2i\sqrt{q}t} w ce_r(t, q) dt$$

$$20.7.35 \quad se_r(\alpha, q) Ms_r^{(1)}(z, q) = \frac{(-1)^s(-i)^p}{2\pi} \int_0^{2\pi} e^{2i\sqrt{q}t} w se_r(t, q) dt.$$

The above can be differentiated with respect to α , and we obtain

$$20.7.36 \quad ce'_r(\alpha, q) Mc_r^{(1)}(z, q) = \frac{(-1)^s(i)^{-p+1}\sqrt{q}}{\pi} \int_0^{2\pi} e^{2i\sqrt{q}t} w \frac{\partial w}{\partial \alpha} ce_r(t, q) dt$$

$$20.7.37 \quad se'_r(\alpha, q) Ms_r^{(1)}(z, q) = \frac{(-1)^{s+p}(i)^{-p+1}\sqrt{q}}{\pi} \int_0^{2\pi} e^{2i\sqrt{q}t} w \frac{\partial w}{\partial \alpha} se_r(t, q) dt$$

Integrals With Infinite Limits

$$r = 2s + p$$

In 20.7.38–20.7.41 below, z and q are positive.

$$20.7.38 \quad Mc_r^{(1)}(z, q) = \gamma_r \int_0^\infty \sin\left(2\sqrt{q} \cosh z \cosh t + p \frac{\pi}{2}\right) Mc_r^{(1)}(t, q) dt$$

$$\gamma_r = 2ce_{2s}\left(\frac{\pi}{2}, q\right) / \pi A_0^{2s}, \text{ if } p=0 \quad \gamma_r = 2ce'_{2s+1}\left(\frac{\pi}{2}, q\right) / \sqrt{q} \pi A_1^{2s+1}, \text{ if } p=1$$

$$20.7.39 \quad Ms_r^{(1)}(z, q) = \gamma_r \int_0^\infty \sinh z \sinh t \left[\cos\left(2\sqrt{q} \cosh z \cosh t - p \frac{\pi}{2}\right) \right] Ms_r^{(1)}(t, q) dt$$

$$\gamma_r = -4se'_{2s}\left(\frac{\pi}{2}, q\right) / \sqrt{q} \pi B_2^{2s}, \text{ if } p=0 \quad \gamma_r = -4se_{2s+1}\left(\frac{\pi}{2}, q\right) / \pi B_1^{2s+1}, \text{ if } p=1$$

$$20.7.40 \quad Mc_r^{(2)}(z, q) = \gamma_r \int_0^\infty \cos\left(2\sqrt{q} \cosh z \cosh t - p \frac{\pi}{2}\right) Mc_r^{(1)}(t, q) dt$$

$$\gamma_r = -2ce_{2s}\left(\frac{1}{2}\pi, q\right) / \pi A_0^{2s}, \text{ if } p=0 \quad \gamma_r = 2ce'_{2s+1}\left(\frac{1}{2}\pi, q\right) / \pi \sqrt{q} A_1^{2s+1}, \text{ if } p=1$$

$$20.7.41 \quad Ms_r^{(2)}(z, q) = \gamma_r \int_0^\infty \sin\left(2\sqrt{q} \cosh z \cosh t + p \frac{\pi}{2}\right) \sinh z \sinh t Ms_r^{(1)}(t, q) dt$$

$$\gamma_r = -4se'_{2s}\left(\frac{1}{2}\pi, q\right) / \sqrt{q} \pi B_2^{2s}, \text{ if } p=0 \quad \gamma_r = 4se_{2s+1}\left(\frac{1}{2}\pi, q\right) / \pi B_1^{2s+1}, \text{ if } p=1$$

Additional forms in [20.30], [20.36], [20.15].

20.8. Other Properties

Relations Between Solutions for Parameters q and $-q$

Replacing z by $\frac{1}{2}\pi - z$ in 20.1.1 one obtains

$$20.8.1 \quad y'' + (a + 2q \cos 2z)y = 0$$

Hence if $u(z)$ is a solution of 20.1.1 then $u(\frac{1}{2}\pi - z)$ satisfies 20.8.1. It can be shown that

20.8.2

$$a(-\nu, q) = a(\nu, -q) = a(\nu, q), \nu \text{ not an integer}$$

$$c_{2m}^{\nu}(-q) = \rho(-1)^m c_{2m}^{\nu}(q), \nu \text{ not an integer}$$

(c_{2m} defined in 20.3.8) and ρ depending on the normalization;

$$F_{\nu}(z, -q) = \rho e^{-i\nu\pi/2} F_{\nu}\left(z + \frac{\pi}{2}, q\right) = \rho e^{i\nu\pi/2} F_{\nu}\left(z - \frac{\pi}{2}, q\right)$$

20.8.3

$$a_{2r}(-q) = a_{2r}(q); b_{2r}(-q) = b_{2r}(q), \text{ for integral } \nu$$

$$a_{2r+1}(-q) = b_{2r+1}(q), b_{2r+1}(-q) = a_{2r+1}(q)$$

20.8.4

$$ce_{2r}(z, -q) = (-1)^r ce_{2r}(\frac{1}{2}\pi - z, q)$$

$$se_{2r+1}(z, -q) = (-1)^r se_{2r+1}(\frac{1}{2}\pi - z, q)$$

$$se_{2r+1}(z, -q) = (-1)^r ce_{2r+1}(\frac{1}{2}\pi - z, q)$$

$$se_{2r}(z, -q) = (-1)^{r-1} se_{2r}(\frac{1}{2}\pi - z, q)$$

For the coefficients associated with the above solutions for integral ν :

20.8.5

$$A_{2m}^{2r}(-q) = (-1)^{m-r} A_{2m}^{2r}(q);$$

$$B_{2m}^{2r}(-q) = (-1)^{m-r} B_{2m}^{2r}(q)$$

$$A_{2m+1}^{2r+1}(-q) = (-1)^{m-r} B_{2m+1}^{2r+1}(q);$$

$$B_{2m+1}^{2r+1}(-q) = (-1)^{m-r} A_{2m+1}^{2r+1}(q).$$

For the corresponding modified equation

20.8.6 $y'' - (a + 2q \cosh 2z)y = 0$

20.8.7

$$M_r^{(j)}(z, -q) = M_r^{(j)}\left(z + i\frac{\pi}{2}, q\right),$$

$M_r^{(j)}(z, q)$ defined in 20.4.12.

For integral values of ν let

20.8.8

$$Ie_{2r}(z, q) = \sum_{k=0}^{\infty} (-1)^{k+s} A_{2k} [I_{k-s}(u_1) I_{k+s}(u_2) + I_{k+s}(u_1) I_{k-s}(u_2)] / A_{2s} \epsilon_s$$

$$Io_{2r}(z, q) = \sum_{k=1}^{\infty} (-1)^{k+s} B_{2k} [I_{k-s}(u_1) I_{k+s}(u_2) - I_{k+s}(u_1) I_{k-s}(u_2)] / B_{2s}$$

$$Ie_{2r+1}(z, q) = \sum_{k=0}^{\infty} (-1)^{k+s} B_{2k+1} [I_{k-s}(u_1) I_{k+s+1}(u_2) + I_{k+s+1}(u_1) I_{k-s}(u_2)] / B_{2s+1}$$

$$Io_{2r+1}(z, q) = \sum_{k=0}^{\infty} (-1)^{k+s} A_{2k+1} [I_{k-s}(u_1) I_{k+s+1}(u_2) - I_{k+s+1}(u_1) I_{k-s}(u_2)] / A_{2s+1}$$

20.8.9

$$Ke_{2r}(z, q) = \sum_{k=0}^{\infty} A_{2k} [I_{k-s}(u_1) K_{k+s}(u_2) + I_{k+s}(u_1) K_{k-s}(u_2)] / A_{2s} \epsilon_s$$

* $Ko_{2r}(z, q) = \sum_{k=0}^{\infty} B_{2k} [I_{k-s}(u_1) K_{k+s}(u_2) - I_{k+s}(u_1) K_{k-s}(u_2)] / B_{2s}$

* $Ke_{2r+1}(z, q) = \sum_{k=0}^{\infty} B_{2k+1} [I_{k-s}(u_1) K_{k+s+1}(u_2) - I_{k+s+1}(u_1) K_{k-s}(u_2)] / B_{2s+1}$

$$Ko_{2r+1}(z, q) = \sum_{k=0}^{\infty} A_{2k+1} [I_{k-s}(u_1) K_{k+s+1}(u_2) + I_{k+s+1}(u_1) K_{k-s}(u_2)] / A_{2s+1}$$

where $I_m(x)$, $K_m(x)$ are the modified Bessel functions, u_1, u_2 are defined below 20.6.10. Superscripts are omitted, $\epsilon_s = 2$, if $s = 0$, $\epsilon_s = 1$ if $s \neq 0$.

Then for functions of first kind:

20.8.10

$$Mc_{2r}^{(1)}(z, -q) = (-1)^r Ie_{2r}(z, q)$$

$$Ms_{2r}^{(1)}(z, -q) = (-1)^r Io_{2r}(z, q)$$

$$Mc_{2r+1}^{(1)}(z, -q) = (-1)^r i Ie_{2r+1}(z, q)$$

$$Ms_{2r+1}^{(1)}(z, -q) = (-1)^r i Io_{2r+1}(z, q)$$

For the Mathieu-Hankel function of first kind:

20.8.11

$$Mc_{2r}^{(3)}(z, -q) = (-1)^{r+1} i \frac{2}{\pi} Ke_{2r}(z, q)$$

$$Ms_{2r}^{(3)}(z, -q) = (-1)^{r+1} i \frac{2}{\pi} Ko_{2r}(z, q)$$

$$Mc_{2r+1}^{(3)}(z, -q) = (-1)^{r+1} \frac{2}{\pi} Ke_{2r+1}(z, q)$$

$$Ms_{2r+1}^{(3)}(z, -q) = (-1)^{r+1} \frac{2}{\pi} Ko_{2r+1}(z, q)$$

For $M_r^{(j)}(z, -q)$, $j = 2, 4$, one may use the definitions

$$M_r^{(2)} = -i(M_r^{(3)} - M_r^{(1)}); M_r = Mc_r \text{ or } Ms_r,$$

also

$$M_r^{(4)}(z, -q) = 2M_r^{(1)}(z, -q) - M_r^{(3)}(z, -q)$$

$$M = Mc \text{ or } Ms; \text{ for real } z, q, M_r^{(j)}(z, -q)$$

are in general complex if $j = 2, 4$.

Zeros of the Functions for Real Values of q .

See [20.36], section 2.8 for further results. Zeros of $ce_r(z, q)$ and $se_r(z, q)$, $Mc_r^{(1)}(z, q)$, $Ms_r^{(1)}(z, q)$.

In $0 \leq z < \pi$, $ce_r(z, q)$ and $se_r(z, q)$ have r real * zeros.

There are complex zeros if $q > 0$.

If $z_0 = x_0 + iy_0$ is any zero of $ce_r(z, q)$, $se_r(z, q)$ in

$$-\frac{\pi}{2} < x_0 < \frac{\pi}{2}, \text{ then } k\pi \pm z_0, k\pi \pm \bar{z}_0$$

are also zeros, k an integer.

*See page II.

In the strip $-\frac{\pi}{2} < x_0 < \frac{\pi}{2}$, the imaginary zeros of $ce_r(z, q)$, $se_r(z, q)$ are the real zeros of $Ce_r(z, q)$, $Se_r(z, q)$, hence also the real zeros of $Mc_r^{(1)}(z, q)$ and $Ms_r^{(1)}(z, q)$, respectively.

For small q , the large zeros of $Ce_r(z, q)$, $Se_r(z, q)$ approach the zeros of $J_r(2\sqrt{q} \cosh z)$.

Tabulation of Zeros

Ince [20.56] tabulates the first "non-trivial" zero (i.e. different from $0, \frac{\pi}{2}, \pi$) for $ce_r(z)$, $se_r(z)$, $r=2(1)5$ and for $se_6(z)$ to within 10^{-4} , for $q=0(1)10(2)40$. He also gives the "turning" points (zeros of the derivative) and also expansions for them for small q . Wiltse and King [20.61, 2] tabulate the first two (non-trivial) zeros of $Mc_r^{(1)}(z, q)$ and $Ms_r^{(1)}(z, q)$ and of their derivatives $r=0, 1, 2$ for 6 or 7 values of q between .25 and 10. The graphs reproduced here indicate their location.

Between two real zeros of $Mc_r^{(1)}(z, q)$, $Ms_r^{(1)}(z, q)$ there is a zero of $Mc_r^{(2)}(z, q)$, $Ms_r^{(2)}(z, q)$, respectively. No tabulation of such zeros exists yet.

Available tables are described in the References.

The most comprehensive tabulation of the characteristic values a_r, b_r (in a somewhat different notation) and of the coefficients proportional to A_m and B_m as defined in 20.5.4 and 20.5.5 can be found in [20.58]. In addition, the table contains certain important "joining factors", with the aid of which it is possible to obtain values of $Mc_r^{(j)}(z, q)$ and $Ms_r^{(j)}(z, q)$, as well as their derivatives, at $x=0$. Values of the functions $ce_r(x, q)$ and $se_r(x, q)$ for orders up to five or six can be found in [20.56]. Tabulations of less extensive character, but important in some aspects, are outlined in the other references cited. In this chapter only representative values of the various functions are given, along with several graphs.

Special Values for Arguments 0 and $\frac{\pi}{2}$

20.8.12

$$ce_{2r}\left(\frac{\pi}{2}, q\right) = (-1)^r g_{e, 2r}(q) A_0^{2r}(q) \sqrt{\frac{\pi}{2}}$$

$$ce'_{2r+1}\left(\frac{\pi}{2}, q\right) = (-1)^{r+1} g_{e, 2r+1}(q) A_1^{2r+1}(q) \sqrt{\frac{\pi}{2}} q$$

$$se'_{2r}\left(\frac{\pi}{2}, q\right) = (-1)^r g_{o, 2r}(q) B_2^{2r}(q) \cdot q \sqrt{\frac{\pi}{2}}$$

$$se_{2r+1}\left(\frac{\pi}{2}, q\right) = (-1)^r g_{o, 2r+1}(q) B_1^{2r+1}(q) \sqrt{\frac{\pi}{2}} q$$

$$Mc_r^{(1)}(0, q) = \sqrt{\frac{2}{\pi}} \frac{1}{g_{e,r}(q)}$$

$$Mc_r^{(2)}(0, q) = -\sqrt{\frac{2}{\pi}} f_{e,r}(q)/g_{e,r}(q)$$

$$\frac{d}{dz} [Mc_r^{(2)}(z, q)]_{z=0} = \sqrt{\frac{2}{\pi}} g_{e,r}(q)$$

$$\frac{d}{dz} [Ms_r^{(1)}(z, q)]_{z=0} = \sqrt{\frac{2}{\pi}} \frac{1}{g_{o,r}(q)}$$

$$\frac{d}{dz} [Ms_r^{(2)}(z, q)]_{z=0} = \sqrt{\frac{2}{\pi}} f_{o,r}(q)/g_{o,r}(q)$$

$$Ms_r^{(2)}(z, q) = -g_{o,r}(q) \sqrt{\frac{2}{\pi}}$$

The functions $f_{o,r}, g_{o,r}, f_{e,r}, g_{e,r}$ are tabulated in [20.58] for $q \leq 25$.

20.9. Asymptotic Representations

The representations given below are applicable to the *characteristic solutions*, for real values of q , unless otherwise noted. The Floquet exponent ν is defined below, as in [20.36] to be as follows:

In solutions associated with a_r : $\nu = r$

In solutions associated with b_r : $\nu = -r$.

For the functions defined in 20.6.7-20.6.10:

20.9.1

$$Mc_r^{(3)}(z, q) (-1)^r Ms_r^{(3)}(z, q) \sim \frac{e^{i(2\sqrt{q} \cosh z - \frac{r\pi}{2} - \frac{\pi}{4})}}{\pi^{\frac{1}{2}} q^{1/4} (\cosh z - \sigma)^{\frac{1}{2}}} \sum_{m=0}^{\infty} \frac{D_m}{[-4i\sqrt{q}(\cosh z - \sigma)]^m}$$

where $D_{-1} = D_{-2} = 0$; $D_0 = 1$, and the coefficients D_m are obtainable from the following recurrence formula:

20.9.2

$$(m+1)D_{m+1} + \left[\left(m + \frac{1}{2}\right)^2 - \left(m + \frac{1}{4}\right) 8i\sqrt{q} \sigma + 2q - a \right] D_m + \left(m - \frac{1}{2}\right) [16q(1 - \sigma^2) - 8i\sqrt{q} \sigma m] D_{m-1} + 4q(2m-3)(2m-1)(1 - \sigma^2) D_{m-2} = 0$$

20.9.3

$$Mc_r^{(4)}(z, q) (-1)^r Ms_r^{(4)}(z, q) \sim \frac{e^{-i[2\sqrt{q} \cosh z - \frac{1}{2}r\pi - \frac{1}{4}\pi]}}{\pi^{\frac{1}{2}} q^{1/4} (\cosh z - \sigma)^{\frac{1}{2}}} \sum_{m=0}^{\infty} \frac{d_m}{[4i\sqrt{q}(\cosh z - \sigma)]^m}$$

$d_{-1} = d_{-2} = 0$; $d_0 = 1$, and

20.9.4

$$(m+1)d_{m+1} + \left[\left(m + \frac{1}{2}\right)^2 + \left(m + \frac{1}{4}\right) 8i\sqrt{q}\sigma + 2q - a \right] d_m + \left(m - \frac{1}{2}\right) [16q(1-\sigma^2) + 8i\sqrt{q}\sigma m] d_{m-1} + 4q(2m-3)(2m-1)(1-\sigma^2)d_{m-2} = 0.$$

In the above

$$-2\pi < \arg \sqrt{q} \cosh z < \pi$$

$$|\cosh z - \sigma| > |\sigma \pm 1|, \Re z > 0,$$

but σ is otherwise arbitrary. If $\sigma^2 = 1$, 20.9.2 and 20.9.4 become three-term recurrence relations.

Formulas 20.9.1 and 20.9.3 are valid for arbitrary a, q , provided ν is also known; they give multiples of 20.4.12, normalized so as to approach the corresponding Hankel functions $H_\nu^{(1)}(\sqrt{q}e^z)$, $H_\nu^{(2)}(\sqrt{q}e^z)$, as $z \rightarrow \infty$. See [20.36], section 2.63. The formula is especially useful if $|\cosh z|$ is large and q is not too large; thus if $\sigma = -1$, the absolute ratio of two successive terms in the expansion is essentially

$$\left| \left(\frac{\sqrt{q}}{m} + \frac{m}{4\sqrt{q}} + 2 \right) / (\cosh z + 1) \right|.$$

If a, q, z, ν are real, the real and imaginary components of $Mc_r^{(3)}(z, q)$ are $Mc_r^{(1)}(z, q)$ and $Mc_r^{(2)}(z, q)$, respectively; similarly for the components of $Ms_r^{(3)}(z, q)$. If the parameters are complex

20.9.5 $Mc_r^{(1)}(z, q) = \frac{1}{2} [Mc_r^{(3)}(z, q) + Mc_r^{(4)}(z, q)]$

20.9.6 $Mc_r^{(2)}(z, q) = -\frac{i}{2} [Mc_r^{(3)}(z, q) - Mc_r^{(4)}(z, q)]$

Replacing c by s in the above will yield corresponding relations among $Ms_r^{(j)}(z, q)$.

Formulas in which the parameter a does not enter explicitly:

Goldstein's Expansions

20.9.7

$$Mc_r^{(3)}(z, q) \sim iMs_{r+1}^{(3)}(z, q) \approx [F_0(z) - iF_1(z)]e^{i\phi/\pi} q^{\frac{1}{2}} (\cosh z)^{\frac{1}{2}}$$

where

20.9.8

$$\phi = 2\sqrt{q} \sinh z - \frac{1}{2} (2r+1) \arctan \sinh z,$$

$$\Re z > 0, q \gg 1, w = 2r+1$$

20.9.9

$$F_0(z) \sim 1 + \frac{w}{8\sqrt{q} \cosh^2 z} + \frac{1}{2048q} \left[\frac{w^4 + 86w^2 + 105}{\cosh^4 z} - \frac{w^4 + 22w^2 + 57}{\cosh^2 z} \right] + \frac{1}{16384q^{3/2}} \left[\frac{-(w^5 + 14w^3 + 33w)}{\cosh^2 z} - \frac{(2w^5 + 124w^3 + 1122w)}{\cosh^4 z} + \frac{3w^5 + 290w^3 + 1627w}{\cosh^6 z} \right] + \dots$$

20.9.10

$$F_1(z) \sim \frac{\sinh z}{\cosh^2 z} \left[\frac{w^2 + 3}{32\sqrt{q}} + \frac{1}{512q} \left(w^3 + 3w + \frac{4w^3 + 44w}{\cosh^2 z} \right) + \frac{1}{16384q^{3/2}} \left\{ \begin{aligned} &5w^4 + 34w^2 + 9 \\ &- \frac{(w^6 - 47w^4 + 667w^2 + 2835)}{12 \cosh^2 z} \\ &+ \frac{(w^6 + 505w^4 + 12139w^2 + 10395)}{12 \cosh^4 z} \end{aligned} \right\} \right] + \dots$$

See [20.18] for details and an added term in $q^{-5/2}$; a correction to the latter is noted in [20.58].

The expansions 20.9.7 are especially useful when q is large and z is bounded away from zero. The order of magnitude of $Mc_r^{(j)}(0, q)$ cannot be obtained from the expansion. The expansion can also be used, with some success, for $z = ix$, when q is large, if $|\cos x| \gg 0$; they fail at $x = \frac{1}{2}\pi$. Thus, if q, x are real, one obtains

20.9.11

$$ce_r(x, q) \sim \frac{ce_r(0, q)2^{r-1}}{F_0(0)} \{W_1[P_0(x) - P_1(x)] + W_2[P_0(x) + P_1(x)]\}$$

20.9.12

$$se_{r+1}(x, q) \sim se'_{r+1}(0, q)\tau_{r+1} \{W_1[P_0(x) - P_1(x)] - W_2[P_0(x) + P_1(x)]\}$$

In the above, $P_0(x)$ and $P_1(x)$ are obtainable from $F_0(z), F_1(z)$ in 20.9.9-20.9.10 by replacing $\cosh z$ with $\cos x$ and $\sinh z$ with $\sin x$. Thus $P_0(x) = F_0(ix); P_1(x) = -iF_1(ix)$:

20.9.13

$$W_1 = e^{2\sqrt{q} \sin x} [\cos(\frac{1}{2}x + \frac{1}{4}\pi)]^{2r+1} / (\cos x)^{r+1}$$

$$W_2 = e^{-2\sqrt{q} \sin x} [\sin(\frac{1}{2}x + \frac{1}{4}\pi)]^{2r+1} / (\cos x)^{r+1}$$

20.9.14

$$\tau_{r+1} \sim 2^{r-1} \sqrt{\left[2\sqrt{q} - \frac{1}{4}w - \frac{(2w^2+3)}{64\sqrt{q}} - \frac{(7w^3+47w)}{1024q} - \dots \right]}$$

See 20.9.23-20.9.24 for expressions relating to $ce_r(0, q)$ and $se_r'(0, q)$. When $|\cos x| > \sqrt{4r+2/q^{\frac{1}{2}}}$, 20.9.11-20.9.12 are useful. The approximations become poorer as r increases.

Expansions in Terms of Parabolic Cylinder Functions

(Good for angles close to $\frac{1}{2}\pi$, for large values of q , especially when $|\cos x| < 2^{\frac{1}{2}}/q^{\frac{1}{2}}$.) Due to Sips [20.44-20.46].

$$20.9.15 \quad ce_r(x, q) \sim C_r[Z_0(\alpha) + Z_1(\alpha)]$$

20.9.16

$$se_{r+1}(x, q) \sim S_r[Z_0(\alpha) - Z_1(\alpha)] \sin x, \quad \alpha = 2q^{\frac{1}{2}} \cos x.$$

$$\text{Let } D_k = D_k(\alpha) = (-1)^k e^{i\alpha^2} \frac{d^k}{d\alpha^2} e^{-i\alpha^2}.$$

20.9.17

$$\begin{aligned} Z_0(\alpha) \sim & D_r + \frac{1}{4q^{\frac{1}{2}}} \left[-\frac{D_{r+4}}{16} + \frac{3}{2} \binom{r}{4} D_{r-4} \right] \\ & + \frac{1}{16q} \left[\frac{D_{r+8}}{512} - \frac{(r+2)D_{r+4}}{16} + \frac{3}{2} (r-1) \binom{r}{4} D_{r-4} \right. \\ & \left. + \frac{315}{4} \binom{r}{8} D_{r-8} \right] + \dots \end{aligned}$$

20.9.18

$$\begin{aligned} Z_1(\alpha) \sim & \frac{1}{4q^{\frac{1}{2}}} \left[-\frac{1}{4} D_{r+2} - \frac{r(r-1)}{4} D_{r-2} \right] \\ & + \frac{1}{16q} \left[\frac{D_{r+6}}{64} + \frac{(r^2-25r-36)}{64} D_{r+2} \right. \\ & \left. + \frac{r(r-1)(-r^2-27r+10)}{64} D_{r-2} - \frac{45}{4} \binom{r}{6} D_{r-6} + \dots \right] \end{aligned}$$

20.9.19

$$\begin{aligned} C_r \sim & \left(\frac{\pi}{2} \right)^{\frac{1}{2}} q^{\frac{1}{2}} / (r!)^{\frac{1}{2}} \left[1 + \frac{2r+1}{8q^{\frac{1}{2}}} \right. \\ & \left. + \frac{r^4+2r^3+263r^2+262r+108}{2048q} + \frac{f_1}{16384q^{\frac{3}{2}}} + \dots \right]^{-\frac{1}{2}} \\ & f_1 = 6r^5 + 15r^4 + 1280r^3 + 1905r^2 + 1778r + 572 \end{aligned}$$

20.9.20

$$\begin{aligned} S_r \sim & \left(\frac{\pi}{2} \right)^{\frac{1}{2}} q^{\frac{1}{2}} / (r!)^{\frac{1}{2}} \left[1 - \frac{2r+1}{8q^{\frac{1}{2}}} \right. \\ & \left. + \frac{r^4+2r^3-121r^2-122r-84}{2048q} + \frac{f_2}{16384q^{\frac{3}{2}}} + \dots \right]^{-\frac{1}{2}} \\ & f_2 = 2r^5 + 5r^4 - 416r^3 - 629r^2 - 1162r - 476 \end{aligned}$$

It should be noted that 20.9.15 is also valid as an approximation for $se_{r+1}(x, q)$, but 20.9.16 may give slightly better results. See [20.4.]

Explicit Expansions for Orders 0, 1, to Terms in $q^{-3/2}$ (q Large)20.9.21 For $r=0$:

$$\begin{aligned} Z_0 \sim & D_0 - \frac{D_4}{64\sqrt{q}} + \frac{1}{16q} \left(-\frac{D_4}{8} + \frac{D_8}{512} \right) * \\ & + \frac{1}{64q^{3/2}} \left(-\frac{99D_4}{256} + \frac{3D_8}{256} - \frac{D_{12}}{24576} \right) + \dots \end{aligned}$$

$$\begin{aligned} Z_1 \sim & \frac{-D_2}{16\sqrt{q}} + \frac{1}{16q} \left(-\frac{9D_2}{16} + \frac{D_6}{64} \right) \\ & + \frac{1}{64q^{3/2}} \left(-\frac{61D_2}{32} + \frac{25D_6}{256} - \frac{5D_{10}}{10240} \right) + \dots \end{aligned}$$

20.9.22 For $r=1$:

$$\begin{aligned} Z_0 \sim & D_1 - \frac{D_5}{64\sqrt{q}} + \frac{1}{16q} \left(-\frac{3D_5}{16} + \frac{D_9}{512} \right) \\ & + \frac{1}{64q^{3/2}} \left(-\frac{207D_5}{256} + \frac{D_9}{64} - \frac{D_{13}}{24576} \right) + \dots \end{aligned}$$

$$\begin{aligned} Z_1 \sim & \frac{-D_3}{16\sqrt{q}} + \frac{1}{16q} \left(-\frac{15D_3}{16} + \frac{D_7}{64} \right) \\ & + \frac{1}{64q^{3/2}} \left(-\frac{153D_3}{32} + \frac{35D_7}{256} - \frac{D_{11}}{2048} \right) + \dots \end{aligned}$$

Formulas Involving $ce_r(0, q)$ and $se_r(0, q)$

20.9.23

$$\begin{aligned} \frac{ce_0(0, q)}{ce_0(\frac{1}{2}\pi, q)} & \sim 2\sqrt{2} e^{-2\sqrt{q}} \left(1 + \frac{1}{16\sqrt{q}} + \frac{9}{256q} + \dots \right) \\ \frac{ce_2(0, q)}{ce_2(\frac{1}{2}\pi, q)} & \sim -32q\sqrt{2} e^{-2\sqrt{q}} \left(1 - \frac{1}{16\sqrt{q}} + \frac{29}{128q} + \dots \right) \end{aligned}$$

*See page II.

$$\frac{ce_1(0, q)}{ce'_1(\frac{1}{2}\pi, q)} \sim -4\sqrt{2}e^{-2\sqrt{q}} \left(1 + \frac{3}{16\sqrt{q}} + \frac{45}{256q} + \dots\right)$$

$$\frac{ce_3(0, q)}{ce'_3(\frac{1}{2}\pi, q)} \sim \frac{64}{3} q\sqrt{2} e^{-2\sqrt{q}} \left(1 - \frac{3}{16\sqrt{q}} + \frac{47}{128q} + \dots\right)$$

20.9.24

$$\frac{se'_1(0, q)}{se_1(\frac{1}{2}\pi, q)} \sim 4 q\sqrt{2} e^{-2\sqrt{q}} \left(1 - \frac{3}{16\sqrt{q}} - \frac{11}{256q} + \dots\right)$$

$$\frac{se'_3(0, q)}{se_3(\frac{1}{2}\pi, q)} \sim -64 q\sqrt{2} e^{-2\sqrt{q}} \left(1 - \frac{21}{16\sqrt{q}} - \frac{17}{128q} + \dots\right)$$

$$\frac{se'_2(0, q)}{se_2(\frac{1}{2}\pi, q)} \sim -8 q\sqrt{2} e^{-2\sqrt{q}} \left(1 - \frac{9}{16\sqrt{q}} - \frac{39}{256q} + \dots\right)$$

$$\frac{se'_4(0, q)}{se_4(\frac{1}{2}\pi, q)} \sim \frac{128}{3} q\sqrt{2} e^{-2\sqrt{q}} \left(1 - \frac{31}{16\sqrt{q}} - \frac{15}{128q} + \dots\right)$$

For higher orders, these ratios are increasingly more difficult to obtain. One method of estimating values at the origin is to evaluate both **20.9.11** and **20.9.15** for some x where both expansions are satisfactory, and so to use **20.9.11** as a means to solve for $ce_r(0, q)$; similarly for $se'_r(0, q)$.

Other asymptotic expansions, valid over various regions of the complex z -plane, for real values of a, q , have been given by Langer [20.25]. It is not always easy, however, to determine the linear combinations of Langer's solutions which coincide with those defined here.

20.10. Comparative Notations

	This Volume	[20.58] NBS	[20.59] Stratton-Morse, etc.	[20.36] Meisner and Schäfer	[20.30] McLachlan	[20.15] Bateman Manuscript	Comments
Parameters in 20.1.1.....	a q a_r b_r	$b = a + 2q$ $s = 4q$ $be_r = a_r + 2q$ $bo_r = b_r + 2q$	b $c = 2\sqrt{q}$ $b_r = a_r + 2q$ $b'_r = b_r + 2q$	λ h^2 a_r b_r	a q a_r b_r	h θ a_r b_r	
Periodic Solutions, of 20.1.1:							
Even.....	$ce_r(z, q)$	$A^r Se_r(s, z)$ *	$A^r Se_r^{(1)}(c, \cos x)$ *	$ce_r(z, h^2)$ *	$ce_r(z, q)$	$ce_r(z, \theta)$	See Note 1.
Odd.....	$se_r(z, q)$	$B^r So_r(s, z)$ *	$A^r So_r^{(1)}(c, \cos x)$ *	$se_r(z, h^2)$ *	$se_r(z, q)$	$se_r(z, \theta)$	
Coefficients in Periodic Solutions:							
Even.....	$A'_m(q)$	$A^r De_m^r(s)$ *	$A^r D_r^r$ *	A'_m	A'_m	A'_m	
Odd.....	$B'_m(q)$	$B^r Do_m^r(s)$ *	$B^r F_r^r$ *	B'_m	B'_m	B'_m	
$\frac{1}{\pi} \int_0^{2\pi} y^2 dx$, y is the Standard Solution of 20.1.1.	1	$(A^r)^{-2}$ or $(B^r)^{-2}$	$(A^r)^{-2}$ or $(B^r)^{-2}$	1	1	1	See Note 1.
Floquet's Solutions 20.3.3.....	$F_r(z)$			$me_r(z, h^2)$	$\phi(z)$		
Characteristic Exponent.....	ν	$\mu = i\nu$		ν	$\mu = i\nu$	$\mu = i\nu$	
Normalizations of Floquet's Solutions.	Unspecified			$\frac{1}{\pi} \int_0^{2\pi} (me_r(z, h^2) me_{-r}(z, h^2) - 1)$			
Solutions of Modified Equation 20.1.2.	$Ce_r(z, q)$ $Se_r(z, q)$ $Mc_r^{(1)}(z, q)$ $Ms_r^{(1)}(z, q)$ $Mc_r^{(2)}(z, q)$ $Ms_r^{(2)}(z, q)$	$Ag_{...}(s)Je_r(s, q)$ $Bg_{...}(s)Jo_r(s, q)$ $\sqrt{\frac{2}{\pi}} Je_r(s, z)$ $\sqrt{\frac{2}{\pi}} Jo_r(s, z)$ $\sqrt{\frac{2}{\pi}} Ne_r(s, z)$ $\sqrt{\frac{2}{\pi}} No_r(s, z)$	$Ag_{...}(s)Je_r(c, \cosh x)$ $Bg_{...}(s)Jo_r(c, \cosh x)$ $\sqrt{\frac{2}{\pi}} Je_r(c, \cosh z)$ $\sqrt{\frac{2}{\pi}} Jo_r(c, \cosh z)$ $\sqrt{\frac{2}{\pi}} Ne_r(c, \cosh z)$ $\sqrt{\frac{2}{\pi}} No_r(c, \cosh z)$	$Ce_r(z, q)$ $Se_r(z, q)$ $Mc_r^{(1)}(z, h)$ $Ms_r^{(1)}(z, h)$ $Mc_r^{(2)}(z, h)$ $Ms_r^{(2)}(z, h)$	$Ce_r(z, q)$ $Se_r(z, q)$ $\sqrt{\frac{2}{\pi}} Ce_r(z, q) / Ag_{...}(q)$ $\sqrt{\frac{2}{\pi}} Se_r(z, q) / Bg_{...}(q)$ $\sqrt{\frac{2}{\pi}} Fey_r(z, q) / Ag_{...}(q)$ $\sqrt{\frac{2}{\pi}} Gey_r(z, q) / Bg_{...}(q)$	$Ce_r(z, \theta)$ $Se_r(z, \theta)$ $\sqrt{\frac{2}{\pi}} Ce_r(z, \theta) / Ag_{...}(q)$ $\sqrt{\frac{2}{\pi}} Se_r(z, \theta) / Bg_{...}(q)$ $\sqrt{\frac{2}{\pi}} Fey_r(z, \theta) / Ag_{...}(q)$ $\sqrt{\frac{2}{\pi}} Gey_r(z, \theta) / Bg_{...}(q)$	
Joining Factors.....	$\sqrt{2/\pi} / Mc_r^{(1)}(0, q)$ $\sqrt{2/\pi} / \frac{d}{dz} [Ms_r^{(1)}(z, q)]_{z=0}$ $-Mc_r^{(2)}(0, q) / Mc_r^{(1)}(0, q)$ $\left[\frac{d}{dz} Ms_r^{(1)}(z, q) \right]_{z=0}$ $\left[\frac{d}{dz} Ms_r^{(2)}(z, q) \right]_{z=0}$	$g_{...}(s)$ $g_{...}(s)$ $f_{...}(s)$ $f_{...}(s)$	$\sqrt{2/\pi} \lambda_r^{(e)}$ $\sqrt{2/\pi} \lambda_r^{(o)}$ $-\frac{2}{\pi} \frac{K'_1}{K_1}$ $\frac{2}{\pi} \frac{K'_1}{K_1}$	$\sqrt{2/\pi} / Mc_r^{(1)}(0, h)$ $\sqrt{2/\pi} / \frac{d}{dz} [Ms_r^{(1)}(z, h)]_{z=0}$ $-Mc_r^{(2)}(0, h) / Mc_r^{(1)}(0, h)$ Same as this volume	$(-1)^r p_r \sqrt{\frac{2}{\pi}} / A$ $(-1)^r s_r \sqrt{\frac{2}{\pi}} / B$ $-\frac{Fey_r(0, q)}{Ce_r(0, q)}$ $\left[\frac{d}{dz} Gey_r(z, q) \right]_{z=0}$ $\left[\frac{d}{dz} Se_r(z, q) \right]_{z=0}$	Same as [20.30] Same as [20.30] Same as [20.30]	See Note 2. See Note 3.

NOTE: 1. The conversion factors A^r and B^r are tabulated in [20.58] along with the coefficients.
 2. The multipliers p_r and s_r are defined in [20.30], Appendix 1, section 3, equations 3, 4, 5, 6.
 3. See [20.59], sections (5.3) and (5.5). In eq. (316) of (5.5), the first term should have a minus sign.

*See page II.

References

Texts

- [20.1] W. G. Bickley, The tabulation of Mathieu functions, *Math. Tables Aids Comp.* **1**, 409-419 (1945).
- [20.2] W. G. Bickley and N. W. McLachlan, Mathieu functions of integral order and their tabulation, *Math. Tables Aids Comp.* **2**, 1-11 (1946).
- [20.3] G. Blanch, On the computation of Mathieu functions, *J. Math. Phys.* **25**, 1-20 (1946).
- [20.4] G. Blanch, The asymptotic expansions for the odd periodic Mathieu functions, *Trans. Amer. Math. Soc.* **97**, 2, 357-366 (1960).
- [20.5] C. J. Bouwkamp, A note on Mathieu functions, *Kon. Nederl. Akad. Wetensch. Proc.* **51**, 891-893 (1948).
- [20.6] C. J. Bouwkamp, On spheroidal wave functions of order zero. *J. Math. Phys.* **26**, 79-92 (1947).
- [20.7] M. R. Campbell, Sur les solutions de période 2π de l'équation de Mathieu associée, *C.R. Acad. Sci., Paris*, **223**, 123-125 (1946).
- [20.8] M. R. Campbell, Sur une catégorie remarquable de solutions de l'équation de Mathieu associée, *C.R. Acad. Sci., Paris*, **226**, 2114-2116 (1948).
- [20.9] T. M. Cherry, Uniform asymptotic formulae for functions with transition points, *Trans. Amer. Math. Soc.* **68**, 224-257 (1950).
- [20.10] S. C. Dhar, *Mathieu functions* (Calcutta Univ. Press, Calcutta, India, 1928).
- [20.11] J. Dougall, The solution of Mathieu's differential equation, *Proc. Edinburgh Math. Soc.* **34**, 176-196 (1916).
- [20.12] J. Dougall, On the solutions of Mathieu's differential equation, and their asymptotic expansions, *Proc. Edinburgh Math. Soc.* **41**, 26-48 (1923).
- [20.13] A. Erdélyi, Über die Integration der Mathieschen Differentialgleichung durch Laplacesche Integrale, *Math. Z.* **41**, 653-664 (1936).
- [20.14] A. Erdélyi, On certain expansions of the solutions of Mathieu's differential equation, *Proc. Cambridge Philos. Soc.* **38**, 28-33 (1942).
- [20.15] A. Erdélyi et al., *Higher transcendental functions*, vol. 3 (McGraw-Hill Book Co., Inc., New York, N.Y., 1955).
- [20.16] G. Floquet, Sur les équations différentielles linéaires à coefficients périodiques, *Ann. École Norm. Sup.* **12**, 47 (1883).
- [20.17] S. Goldstein, The second solution of Mathieu's differential equation, *Proc. Cambridge Philos. Soc.* **24**, 223-230 (1928).
- [20.18] S. Goldstein, Mathieu functions, *Trans. Cambridge Philos. Soc.* **23**, 303-336 (1927).
- [20.19] G. W. Hill, On the path of motion of the lunar perigee, *Acta Math.* **8**, 1 (1886).
- [20.20] E. Hille, On the zeros of the Mathieu functions, *Proc. London Math. Soc.* **23**, 185-237 (1924).
- [20.21] E. L. Ince, A proof of the impossibility of the co-existence of two Mathieu functions, *Proc. Cambridge Philos. Soc.* **21**, 117-120 (1922).
- [20.22] E. L. Ince, *Ordinary differential equations* (Longmans, Green & Co., 1927, reprinted by Dover Publications, Inc., New York, N.Y., 1944).
- [20.23] H. Jeffreys, On the modified Mathieu's equation, *Proc. London Math. Soc.* **23**, 449-454 (1924).
- [20.24] V. D. Kupradze, *Fundamental problems in the mathematical theory of diffraction* (1935). Translated from the Russian by Curtis D. Benster, NBS Report 200 (Oct. 1952).
- [20.25] R. E. Langer, The solutions of the Mathieu equation with a complex variable and at least one parameter large, *Trans. Amer. Math. Soc.* **36**, 637-695 (1934).
- [20.26] S. Lubkin and J. J. Stoker, Stability of columns and strings under periodically varying forces, *Quart. Appl. Math.* **1**, 215-236 (1943).
- [20.27] É. Mathieu, Mémoire sur le mouvement vibratoire d'une membrane de forme elliptique, *J. Math. Pures Appl.* **13**, 137-203 (1868).
- [20.28] N. W. McLachlan, Mathieu functions and their classification, *J. Math. Phys.* **25**, 209-240 (1946).
- [20.29] N. W. McLachlan, Mathieu functions of fractional order, *J. Math. Phys.* **26**, 29-41 (1947).
- [20.30] N. W. McLachlan, *Theory and application of Mathieu functions* (Clarendon Press, Oxford, England, 1947).
- [20.31] N. W. McLachlan, Application of Mathieu's equation to stability of non-linear oscillator, *Math. Gaz.* **35**, 105-107 (1951).
- [20.32] J. Meixner, Über das asymptotische Verhalten von Funktionen, die durch Reihen nach Zylinderfunktionen dargestellt werden können, *Math. Nachr.* **3**, 9-13, Reihenentwicklungen von Produkten zweier Mathieschen Funktionen nach Produkten von Zylinder und Exponentialfunktionen, 14-19 (1949).
- [20.33] J. Meixner, Integralbeziehungen zwischen Mathieschen Funktionen, *Math. Nachr.* **5**, 371-378 (1951).
- [20.34] J. Meixner, Reihenentwicklungen vom Siegerschen Typus für die Sphäroid Funktionen, *Arch. Math. Oberwolfach* **1**, 432-440 (1949).
- [20.35] J. Meixner, Asymptotische Entwicklung der Eigenwerte und Eigenfunktionen der Differentialgleichungen der Sphäroidfunktionen und der Mathieschen Funktionen, *Z. Angew. Math. Mech.* **28**, 304-310 (1948).
- [20.36] J. Meixner and F. W. Schäfke, *Mathiesche Funktionen und Sphäroidfunktionen* (Springer-Verlag, Berlin, Germany, 1954).
- [20.37] P. M. Morse and P. J. Rubinstein, The diffraction of waves by ribbons and by slits, *Phys. Rev.* **54**, 895-898 (1938).
- [20.38] H. P. Mulholland and S. Goldstein, The characteristic numbers of the Mathieu equation with purely imaginary parameters, *Phil. Mag.* **8**, 834-840 (1929).
- [20.39] L. Onsager, *Solutions of the Mathieu equation of period 4π and certain related functions* (Yale Univ. Dissertation, New Haven, Conn., 1935).

- [20.40] F. W. Schäfer, Über die Stabilitätskarte der Mathieschen Differentialgleichung, *Math. Nachr.* 4, 175-183 (1950).
- [20.41] F. W. Schäfer, Das Additions theorem der Mathieschen Funktionen, *Math. Z.* 58, 436-447 (1953).
- [20.42] F. W. Schäfer, Eine Methode zur Berechnung des charakteristischen Exponenten einer Hillschen Differentialgleichung, *Z. Angew. Math. Mech.* 33, 279-280 (1953).
- [20.43] B. Sieger, Die Beugung einer ebenen elektrischen Welle an einem Schirm von elliptischem Querschnitt, *Ann. Physik.* 4, 27, 626-664 (1908).
- [20.44] R. Sips, Représentation asymptotique des fonctions de Mathieu et des fonctions d'onde sphéroïdales, *Trans. Amer. Math. Soc.* 66, 93-134 (1949).
- [20.45] R. Sips, Représentation asymptotique des fonctions de Mathieu et des fonctions sphéroïdales II, *Trans. Amer. Math. Soc.* 90, 2, 340-368 (1959).
- [20.46] R. Sips, Recherches sur les fonctions de Mathieu, *Bull. Soc. Roy. Sci. Liège* 22, 341-355, 374-387, 444-455, 530-540 (1953); 23, 37-47, 90-103 (1954).
- [20.47] M. J. O. Strutt, Die Hillsche Differentialgleichung im komplexen Gebiet, *Nieuw. Arch. Wisk.* 18 31-55 (1935).
- [20.48] M. J. O. Strutt, Lamésche, Mathiesche und verwandte Funktionen in Physik und Technik, *Ergeb. Math. Grenzgeb.* 1, 199-323 (1932).
- [20.49] M. J. O. Strutt, On Hill's problems with complex parameters and a real periodic function, *Proc. Roy. Soc. Edinburgh Sect. A* 62, 278-296 (1948).
- [20.50] E. T. Whittaker, On functions associated with elliptic cylinders in harmonic analysis, *Proc. Intl. Congr. Math. Cambr.* 1, 366 (1912).
- [20.51] E. T. Whittaker, On the general solution of Mathieu's equation, *Proc. Edinburgh Math. Soc.* 32, 75-80 (1914).
- [20.52] E. T. Whittaker and G. N. Watson, *A course of modern analysis*, 4th ed. (Cambridge Univ. Press, Cambridge, England, 1952).
- Tables**
- [20.53] G. Blanch and I. Rhodes, Table of characteristic values of Mathieu's equation for large values of the parameter, *J. Washington Acad. Sci.* 45, 6, 166-196 (1955). $Be_r(t) = a_r(q) + 2q - 2(2r+1)\sqrt{q}$, $Bo_r(t) = b_r(q) + 2q - 2(2r-1)\sqrt{q}$, $t = 1/2\sqrt{q}$, $r = 0(1)15$, $0 \leq t \leq .1$, with δ^2 , δ^{4*} ; 8D (about); interpolable.
- [20.54] J. G. Brainerd, H. J. Gray, and R. Merwin, Solution of the Mathieu equation, *Am. Inst. Elec. Engrs.* 67 (1948). Characteristic exponent over a wide range. μ , M for $\epsilon = 1(1)10$; $k = .1(1)1$, 5D; $g(t)$, $h(t)$ for $t = 0(.1)3.1$, π , 5D; $\epsilon = 1(1)10$, $k = .1(1)1$, where $g(t)$, $h(t)$ are solutions of $y'' + \epsilon(1+k \cos t)y = 0$, with $g(0) = h'(0) = 1$, $g'(0) = h(0) = 0$, $\cos 2\pi\mu = 2g(\pi)h'(\pi) - 1$, $M = [-g(\pi)g'(\pi)/h(\pi)h'(\pi)]^{1/2}$.
- [20.55] J. G. Brainerd and C. N. Weygandt, Solutions of Mathieu's equation, *Phil. Mag.* 30, 458-477 (1940).
- [20.56] E. L. Ince, Tables of the elliptic cylinder functions, *Proc. Roy. Soc. Edinburgh* 52, 355-423; Zeros and turning points, 52, 424-433 (1932). Characteristic values $a_0, a_1, \dots, a_s, b_1, b_2, \dots, b_s$, and coefficients for $\theta = 0(1)10(2)20(4)40$; 7D. Also $ce_r(x, \theta)$, $se_r(x, \theta)$, $\theta = 0(1)10$, $x = 0^\circ(1^\circ)90^\circ$; 5D, corresponding to characteristic values in the tables. $a_r = be_r - 2q$; $b_r = bo_r - 2q$; $\theta = q$.
- [20.57] E. T. Kirkpatrick, Tables of values of the modified Mathieu function, *Math. Comp.* 14, 70 (1960). $Ce_r(u, q)$, $r = 0(1)5$, $Se_r(u, q)$, $r = 1(1)6$; $u = .1(1)1$; $q = 1(1)20$.
- [20.58] National Bureau of Standards, Tables relating to Mathieu functions (Columbia Univ. Press, New York, N. Y., 1951). Characteristic values $be_r(s)$, $bo_r(s)$ for $0 \leq s \leq 100$, along with δ^{2*} , interpolable to 8D; coefficients $De_r(s)$, $Do_r(s)$ and conversion factors for $ce_r(q)$, $se_r(q)$, same range, without differences but interpolable to 9D with Lagrangian formulas of order 7. "Joining factors" $s^{\dagger}g_{a,r}$, $s^{\dagger}g_{b,r}$, $s^{\dagger}f_{a,r}$, $s^{\dagger}f_{b,r}$ along with δ^{2*} ; interpolable to 8S.
- [20.59] J. A. Stratton, P. M. Morse, L. J. Chu and R. A. Hutner, Elliptic cylinder and spheroidal wave functions (John Wiley & Sons, Inc., New York, N. Y., 1941). Theory and tables for $b_0, b_1, b_2, b_3, b_4, b'_1, b'_2, b'_3, b'_4$, and coefficients for $Se_r(s, x)$ and $So_r(s, x)$ for $c = 0(.2)4.4$ and $.5(1)4.5$; mostly 5S; $c = 2q^{\dagger}$, $b_r = a_r + 2q$, $b'_r = b_r + 2q$.
- [20.60] T. Tamir, Characteristic exponents of Mathieu* equations, *Math. Comp.* 16, 77 (1962). The Floquet exponent ν_r of the first three stable regions; namely $r = 0, 1, 2$; $q = .1(1)2.5$; $a = r(.1)r + 1$, 5D.
- [20.61] J. C. Wiltse and M. J. King, Values of the Mathieu functions, The Johns Hopkins Univ. Radiation Laboratory Technical Report AF-53, Baltimore, Md. (1958). (Notation of [20.58] used: $ce_n(v, q)/A$, $se_n(v, q)/B$ for 12 values of q between .25 and 10 and from 8 to 14 values of v ; $\sqrt{\pi/2} Mc_j^i(u, q)$, $\sqrt{\pi/2} Ms_j^i(u, q)$, $j = 1, 2$ for 6 to 8 values of q between .25 and 10 and about 20 values of u , $r = 0, 1, 2$; $\sqrt{\pi/2} Mc_r^{(3)}(-|u|, q)$, $\sqrt{\pi/2} Ms_r^{(3)}(-|u|, q)$, $r = 0, 1, 2$ for about 9 values of u and q , 2 to 4 D in all.
- [20.62] J. C. Wiltse and M. J. King, Derivatives, zeros, and other data pertaining to Mathieu functions, The Johns Hopkins Univ. Radiation Laboratory Technical Report AF-57, Baltimore, Md. (1958).
- [20.63] S. J. Zaroodny, An elementary review of the Mathieu-Hill equation of real variable based on numerical solutions, Ballistic Research Laboratory Memorandum Report 878, Aberdeen Proving Ground, Md. (1955). Chart of the characteristic exponent.
See also [20.18]. It contains, among other tabulations, values of a_r , b_r and coefficients for $ce_r(x, q)$, $se_r(x, q)$, $q = 40(20)100(50)200$; 5D, $r \leq 2$.

Table 20.1 CHARACTERISTIC VALUES, JOINING FACTORS, SOME CRITICAL VALUES
EVEN SOLUTIONS

r	q	a_r	$ce_r(0, q)$	$ce_r(\frac{1}{2}\pi, q)$	$(4q)^{\frac{1}{2}r}g_{e,r}(q)$	$(4q)^rf_{e,r}(q)$
0	0	0.00000 000	(-1) 7.07106 781	(-1) 7.07106 78	(-1) 7.97884 56	∞
	5	- 5.80004 602	(-2) 4.48001 817	1.33484 87	1.97009 00	(- 3) 1.86132 97
	10	- 13.93697 996	(-3) 7.62651 757	1.46866 05	2.40237 95	(- 5) 5.54257 96
	15	- 22.51303 776	(-3) 1.93250 832	1.55010 82	2.68433 53	(- 6) 3.59660 89
	20	- 31.31339 007	(-4) 6.03743 829	1.60989 09	2.90011 25	(- 7) 3.53093 01
25	- 40.25677 955	(-4) 2.15863 018	1.65751 03	3.07743 91	(- 8) 4.53098 68	
2	0	4.00000 000	1.00000 000	-1.00000 00	(1) 1.27661 53	(1) 8.14873 31
	5	7.44910 974	(-1) 7.35294 308	(-1) -7.24488 15	(1) 2.63509 89	(2) 1.68665 79
	10	7.71736 985	(-1) 2.45888 349	(-1) -9.26759 26	(1) 7.22275 58	(1) 6.89192 56
	15	5.07798 320	(-2) 7.87928 278	-1.01996 62	(2) 1.32067 71	(1) 1.73770 48
	20	+ 1.15428 288	(-2) 2.86489 431	-1.07529 32	(2) 1.98201 14	4.29953 32
25	- 3.52216 473	(-2) 1.15128 663	-1.11627 90	(2) 2.69191 26	1.11858 69	
10	0	100.00000 000	1.00000 000	-1.00000 00	(12) 1.51800 43	(23) 2.30433 72
	5	100.12636 922	1.02599 503	(-1) -9.75347 49	(12) 1.48332 54	(23) 2.31909 77
	10	100.50677 002	1.05381 599	(-1) -9.51645 32	(12) 1.45530 39	(23) 2.36418 54
	15	101.14520 345	1.08410 631	(-1) -9.28548 06	(12) 1.43299 34	(23) 2.44213 04
	20	102.04891 602	1.11778 863	(-1) -9.05710 78	(12) 1.41537 24	(23) 2.55760 55
25	103.23020 480	1.15623 992	(-1) -8.82691 92	(12) 1.40118 52	(23) 2.71854 15	

r	q	a_r	$ce_r(0, q)$	$ce'_r(\frac{1}{2}\pi, q)$	$(4q)^{\frac{1}{2}r}g_{e,r}(q)$	$(4q)^rf_{e,r}(q)$
1	0	1.00000 000	1.00000 000	-1.00000 00	1.59576 91	2.54647 91
	5	+ 1.85818 754	(-1) 2.56542 879	-3.46904 21	7.26039 84	1.02263 46
	10	- 2.39914 240	(-2) 5.35987 478	-4.85043 83	(1) 1.35943 49	(- 2) 9.72660 12
	15	- 8.10110 513	(-2) 1.50400 665	-5.76420 64	(1) 1.91348 51	(- 2) 1.19739 95
	20	- 14.49130 142	(-3) 5.05181 376	-6.49056 58	(1) 2.42144 01	(- 3) 1.84066 20
25	- 21.31489 969	(-3) 1.91105 151	-7.10674 15	(1) 2.89856 94	(- 4) 3.33747 55	
5	0	25.00000 000	1.00000 000	-5.00000 00	(4) 4.90220 27	(8) 4.80631 83
	5	25.54997 175	1.12480 725	-5.39248 61	(4) 4.43075 22	(8) 5.11270 71
	10	27.70376 873	1.25801 994	-5.32127 65	(4) 4.19827 66	(8) 6.83327 77
	15	31.95782 125	1.19343 223	-5.11914 99	(4) 5.25017 04	(9) 1.18373 72
	20	36.64498 973	(-1) 9.36575 531	-5.77867 52	(4) 8.96243 97	(9) 1.85341 57
25	40.05019 099	(-1) 6.10694 310	-7.05988 45	(5) 1.71582 55	(9) 2.09679 12	
15	0	225.00000 000	1.00000 000	(1) 1.50000 00	(20) 5.60156 72	(40) 2.09183 70
	5	225.05581 248	1.01129 373	(1) 1.51636 57	(20) 5.54349 84	(40) 2.09575 00
	10	225.22335 698	1.02287 828	(1) 1.53198 84	(20) 5.49405 67	(40) 2.10754 45
	15	225.50295 624	1.03479 365	(1) 1.54687 43	(20) 5.45287 72	(40) 2.12738 84
	20	225.89515 341	1.04708 434	(1) 1.56102 79	(20) 5.41964 26	(40) 2.15556 69
25	226.40072 004	1.05980 044	(1) 1.57444 72	(20) 5.39407 68	(40) 2.19249 18	

Compiled from National Bureau of Standards, Tables relating to Mathieu functions, Columbia Univ. Press, New York, N.Y., 1951 (with permission).

$q^{-\frac{1}{2}r}$	$a_r + 2q - (4r+2)\sqrt{q}$								$\langle q \rangle$
	0	1	2	5	10	15			
0.16	-0.25532 994	-1.30027 212	-3.45639 483	-17.84809 551	-76.04295 314	- 80.93485 048		39	
0.12	-0.25393 098	-1.28658 972	-3.39777 782	-16.92019 225	-76.84607 855	-141.64507 841		69	
0.08	-0.25257 851	-1.27371 191	-3.34441 938	-16.25305 645	-63.58155 264	-162.30500 052		156	
0.04	-0.25126 918	-1.26154 161	-3.29538 745	-15.70968 373	-58.63500 546	-132.08298 271		625	
0.00	-0.25000 000	-1.25000 000	-3.25000 000	-15.25000 000	-55.25000 000	-120.25000 000		∞	

For $g_{e,r}$ and $f_{e,r}$ see 20.8.12.

$\langle q \rangle$ = nearest integer to q .

Compiled from G. Blanch and I. Rhodes, Table of characteristic values of Mathieu's equation for large values of the parameter, Jour. Wash. Acad. Sci., 45, 6, 1955 (with permission).

CHARACTERISTIC VALUES, JOINING FACTORS, SOME CRITICAL VALUES Table 20.1

ODD SOLUTIONS

r	q	b_r	$se'_r(0, q)$	$se'_r(\frac{1}{2}\pi, q)$	$(4q)^{\frac{1}{2}r}g_{0,r}(q)$	$(4q)^r f_{0,r}(q)$
2	0	4.00000 000	2.00000 00	-2.00000 00	6.38307 65	(1)8.14873 31
	5	+ 2.09946 045	(-1)7.33166 22	-3.64051 79	(1)1.24474 88	(1)2.24948 08
	10	- 2.38215 824	(-1)2.48822 84	-4.86342 21	(1)1.86133 36	3.91049 85
	15	- 8.09934 680	(-2)9.18197 14	-5.76557 38	(1)2.42888 57	(- 1)7.18762 28
	20	- 14.49106 325	(-2)3.70277 78	-6.49075 22	(1)2.95502 89	(- 1)1.47260 95
25	- 21.31486 062	(-2)1.60562 17	-7.10677 19	(1)3.44997 83	(- 2)3.33750 27	
10	0	100.00000 000	(1)1.00000 00	(1)-1.00000 00	(11)1.51800 43	(23)2.30433 72
	5	100.12636 922	9.73417 32	(1)-1.02396 46	(11)1.56344 50	(23)2.31909 77
	10	100.50676 946	9.44040 54	(1)-1.04539 48	(11)1.62453 03	(23)2.36418 52
	15	101.14517 229	9.11575 13	(1)-1.06429 00	(11)1.70421 18	(23)2.44211 78
	20	102.04839 286	8.75554 51	(1)-1.08057 24	(11)1.80695 19	(23)2.55740 30
25	103.22568 004	8.35267 84	(1)-1.09413 54	(11)1.93959 86	(23)2.71681 11	

r	q	b_r	$se'_r(0, q)$	$se'_r(\frac{1}{2}\pi, q)$	$(4q)^{\frac{1}{2}r}g_{0,r}(q)$	$(4q)^r f_{0,r}(q)$
1	0	+ 1.00000 000	1.00000 00	1.00000 00	1.59576 91	2.54647 91
	5	- 5.79008 060	(-1)1.74675 40	1.33743 39	2.27041 76	(- 2)3.74062 82
	10	- 13.93655 248	(-2)4.40225 66	1.46875 57	2.63262 99	(- 3)2.21737 88
	15	- 22.51300 350	(-2)1.39251 35	1.55011 51	2.88561 87	(- 4)2.15798 83
	20	- 31.31338 617	(-3)5.07788 49	1.60989 16	3.08411 21	(- 4)2.82474 71
25	- 40.25677 898	(-3)2.04435 94	1.65751 04	3.24945 50	(- 6)4.53098 74	
5	0	25.00000 000	5.00000 00	1.00000 00	(3)9.80440 55	(8)4.80631 83
	5	25.51081 605	4.33957 00	(-1) 9.06077 93	(4)1.14793 21	(8)5.05257 20
	10	26.76642 636	3.40722 68	(-1) 8.46038 43	(4)1.52179 77	(8)5.46799 57
	15	27.96788 060	2.41166 65	(-1) 8.37949 34	(4)2.20680 20	(8)5.27524 17
	20	28.46822 133	1.56889 69	(-1) 8.63543 12	(4)3.27551 12	(8)4.26215 66
25	28.06276 590	(-1)9.64071 62	(-1) 8.99268 33	(4)4.76476 62	(8)2.94147 89	
15	0	225.00000 000	(1)1.50000 00	-1.00000 00	(19)3.73437 81	(40)2.09183 70
	5	225.05581 248	(1)1.48287 89	(-1)-9.88960 70	(19)3.78055 49	(40)2.09575 00
	10	225.22335 698	(1)1.46498 60	(-1)-9.78142 35	(19)3.83604 43	(40)2.10754 45
	15	225.50295 624	(1)1.44630 01	(-1)-9.67513 70	(19)3.90140 52	(40)2.12738 84
	20	225.89515 341	(1)1.42679 46	(-1)-9.57045 25	(19)3.97732 29	(40)2.15556 69
25	226.40072 004	(1)1.40643 73	(-1)-9.46708 70	(19)4.06462 83	(40)2.19249 18	

$$b_r + 2q - (4r - 2)\sqrt{q}$$

$q^{-\frac{1}{2}}r$	1	2	5	10	15	$\langle q \rangle$
0.16	-0.25532 994	-1.30027 164	-11.53046 855	-51.32546 875	- 55.93485 112	39
0.12	-0.25393 098	-1.28658 971	-11.12574 983	-56.10964 961	-108.31442 060	69
0.08	-0.25257 851	-1.27371 191	-10.78895 146	-51.15347 975	-132.59692 424	156
0.04	-0.25126 918	-1.26154 161	-10.50135 748	-47.72149 533	-114.76358 461	625
0.00	-0.25000 000	-1.25000 000	-10.25000 000	-45.25000 000	-105.25000 000	∞

For $g_{0,r}$ and $f_{0,r}$ see 20.8.12.

$\langle q \rangle$ = nearest integer to q .

MATHIEU FUNCTIONS

Table 20.2

COEFFICIENTS A_m AND B_m

A_m

$q=5$

$m \setminus r$	0	2	10	$m \setminus r$	1	5	15
0	+0.54061 2446	+0.43873 7166	+0.00000 1679	1	+0.76246 3686	+0.07768 5798	0.00000 0000
2	-0.62711 5414	+0.65364 0260	+0.00003 3619	3	-0.63159 6319	+0.30375 1030	+0.00000 0002
4	+0.14792 7090	-0.42657 8935	+0.00064 2987	5	+0.13968 4806	+0.92772 8396	+0.00000 0106
6	-0.01784 8061	+0.07588 5673	+0.01078 4807	7	-0.01491 5596	-0.20170 6148	+0.00000 4227
8	+0.00128 2863	-0.00674 1769	+0.13767 5121	9	+0.00094 4842	+0.01827 4579	+0.00014 8749
10	-0.00006 0723	+0.00036 4942	+0.98395 5640	11	-0.00003 9702	-0.00095 9038	+0.00428 1393
12	+0.00000 2028	-0.00001 3376	-0.11280 6780	13	+0.00000 1189	+0.00003 3457	+0.08895 2014
14	-0.00000 0050	+0.00000 0355	+0.00589 2962	15	-0.00000 0027	-0.00000 0839	+0.99297 4092
16	+0.00000 0001	-0.00000 0007	-0.00018 9166	17	+0.00000 0001	+0.00000 0016	-0.07786 7946
18			+0.00000 4226	19			+0.00286 6409
20			-0.00000 0071	21			-0.00006 6394
22			+0.00000 0001	23			+0.00000 1092
				25			-0.00000 0014

$q=25$

$m \setminus r$	0	2	10	$m \setminus r$	1	5	15
0	+0.42974 1038	+0.33086 5777	+0.00502 6361	1	+0.39125 2265	+0.65659 0398	+0.00000 4658
2	-0.69199 9610	-0.04661 4551	+0.02075 4891	3	-0.74048 2467	+0.36900 8820	+0.00003 7337
4	+0.36554 4890	-0.64770 5862	+0.07232 7761	5	+0.50665 3803	-0.19827 8625	+0.00032 0026
6	-0.13057 5523	+0.55239 9372	+0.23161 1726	7	-0.19814 2336	-0.48837 4067	+0.00254 0806
8	+0.03274 5863	-0.22557 4897	+0.55052 4391	9	+0.05064 0536	+0.37311 2810	+0.01770 9603
10	-0.00598 3606	+0.05685 2843	+0.63227 5658	11	-0.00910 8920	-0.12278 1866	+0.10045 8755
12	+0.00082 3792	-0.00984 6277	-0.46882 9197	13	+0.00121 2864	+0.02445 3933	+0.40582 7402
14	-0.00008 7961	+0.00124 8919	+0.13228 7155	15	-0.00012 4121	-0.00335 1335	+0.83133 2650
16	+0.00000 7466	-0.00012 1205	-0.02206 0893	17	+0.00001 0053	+0.00033 9214	-0.35924 8831
18	-0.00000 0514	+0.00000 9296	+0.00252 2374	19	-0.00000 0660	-0.00002 6552	+0.06821 6074
20	+0.00000 0029	-0.00000 0578	-0.00021 3672	21	+0.00000 0036	+0.00000 1661	-0.00802 4550
22	-0.00000 0001	+0.00000 0030	+0.00001 4078	23	-0.00000 0002	-0.00000 0085	+0.00066 6432
24		-0.00000 0001	-0.00000 0746	25		+0.00000 0004	-0.00004 1930
26			+0.00000 0032	27			+0.00000 2090
28			-0.00000 0001	29			-0.00000 0085
				31			+0.00000 0003

B_m

$q=5$

$m \setminus r$	2	10	$m \setminus r$	1	5	15
2	+0.93342 9442	+0.00003 3444	1	+0.94001 9024	+0.05038 2462	0.00000 0000
4	-0.35480 3915	+0.00064 2976	3	-0.33654 1963	+0.29736 5513	+0.00000 0002
6	+0.05296 3730	+0.01078 4807	5	+0.05547 7529	+0.93156 6997	+0.00000 0106
8	-0.00429 5885	+0.13767 5120	7	-0.00508 9553	-0.20219 3638	+0.00000 4227
10	+0.00021 9797	+0.98395 5640	9	+0.00029 3879	+0.01830 5721	+0.00014 8749
12	-0.00000 7752	-0.11280 6780	11	-0.00001 1602	-0.00096 0277	+0.00428 1392
14	+0.00000 0200	+0.00589 2962	13	+0.00000 0332	+0.00003 3493	+0.08895 2014
16	-0.00000 0004	-0.00018 9166	15	-0.00000 0007	-0.00000 0842	+0.99297 4092
18		+0.00000 4227	17		+0.00000 0017	-0.07786 7946
20		-0.00000 0070	19			+0.00286 6409
22		+0.00000 0001	21			-0.00006 6394
			23			+0.00000 1093
			25			-0.00000 0013

$q=25$

$m \setminus r$	2	10	$m \setminus r$	1	5	15
2	+0.65743 9912	+0.01800 3596	1	+0.81398 3846	+0.30117 4196	+0.00000 3717
4	-0.66571 9990	+0.07145 6762	3	-0.52931 0219	+0.62719 8468	+0.00003 7227
6	+0.33621 0033	+0.23131 0990	5	+0.22890 0813	+0.17707 1306	+0.00032 0013
8	-0.10507 3258	+0.55054 4783	7	-0.06818 2972	-0.60550 5349	+0.00254 0804
10	+0.02236 2380	+0.63250 8750	9	+0.01453 0886	+0.33003 2984	+0.01770 9603
12	-0.00344 2304	-0.46893 3949	11	-0.00229 5765	-0.09333 5984	+0.10045 8755
14	+0.00040 0182	+0.13230 9765	13	+0.00027 7422	+0.01694 2545	+0.40582 7403
16	-0.00003 6315	-0.02206 3990	15	-0.00002 6336	-0.00217 7430	+0.83133 2650
18	+0.00000 2640	+0.00252 2676	17	+0.00000 2009	+0.00021 0135	-0.35924 8830
20	-0.00000 0157	-0.00021 3694	19	-0.00000 0126	-0.00001 5851	+0.06821 6074
22	+0.00000 0008	+0.00001 4079	21	+0.00000 0007	+0.00000 0962	-0.00802 4551
24		-0.00000 0746	23		-0.00000 0048	+0.00066 6432
26		+0.00000 0033	25		+0.00000 0002	-0.00004 1930
			27			+0.00000 2090
			29			-0.00000 0086
			31			+0.00000 0003

For A_m and B_m see 20.2.3-20.2.11

Compiled from National Bureau of Standards, Tables relating to Mathieu functions, Columbia Univ. Press, New York, N.Y., 1951 (with permission).

21. Spheroidal Wave Functions

ARNOLD N. LOWAN¹

Contents

	Page
Mathematical Properties	752
21.1. Definition of Elliptical Coordinates	752
21.2. Definition of Prolate Spheroidal Coordinates	752
21.3. Definition of Oblate Spheroidal Coordinates	752
21.4. Laplacian in Spheroidal Coordinates	752
21.5. Wave Equation in Prolate and Oblate Spheroidal Coordinates	752
21.6. Differential Equations for Radial and Angular Spheroidal Wave Functions	753
21.7. Prolate Angular Functions	753
21.8. Oblate Angular Functions	756
21.9. Radial Spheroidal Wave Functions	756
21.10. Joining Factors for Prolate Spheroidal Wave Functions	757
21.11. Notation	758
References	759
Table 21.1. Eigenvalues—Prolate and Oblate	760
$m=0(1)2, n=m(1)m+4$ $c^2=0(1)16, c^{-1}=.25(-.01)0, 4-6D$	
Table 21.2. Angular Functions—Prolate and Oblate	766
$m=0(1)2, n=m(1)3, \eta=0(.1)1$ $\theta=0^\circ(10^\circ)90^\circ, c=1(1)5, 2-4D$	
Table 21.3. Prolate Radial Functions—First and Second Kinds	768
$m=0(1)2, n=m(1)3$ $\xi=1.005, 1.02, 1.044, 1.077, c=1(1)5, 4S$	
Table 21.4. Oblate Radial Functions—First and Second Kinds	769
$m=0, 1, n=m(1)m+2; m, n=2$ $\xi=0, .75, c=.2, .5, .8, 1(.5)2.5, 5S$	
Table 21.5. Prolate Joining Factors—First Kind	769
$m=0, 1, n=m(1)m+2; m, n=2$ $c=1(1)5, 4S$	

¹Yeshiva University. (Prepared under contract with the National Bureau of Standards.) (Deceased.)

21. Spheroidal Wave Functions

Mathematical Properties

21.1. Definition of Elliptical Coordinates

$$21.1.1 \quad \xi = \frac{r_1 + r_2}{2f}; \quad \eta = \frac{r_1 - r_2}{2f}$$

r_1 and r_2 are the distances to the foci of a family of confocal ellipses and hyperbolas; $2f$ is the distance between foci.

$$21.1.2 \quad a = f\xi, \quad b = f\sqrt{\xi^2 - 1}, \quad e = \frac{f}{a}$$

a = semi-major axis; b = semi-minor axis; e = eccentricity.

Equation of Family of Confocal Ellipses

$$21.1.3 \quad \frac{x^2}{\xi^2} + \frac{y^2}{\xi^2 - 1} = f^2 \quad (1 < \xi < \infty)$$

Equation of Family of Confocal Hyperbolas

$$21.1.4 \quad \frac{x^2}{\eta^2} - \frac{y^2}{1 - \eta^2} = f^2 \quad (-1 < \eta < 1)$$

Relations Between Cartesian and Elliptical Coordinates

$$21.1.5 \quad x = f\xi\eta; \quad y = f\sqrt{(\xi^2 - 1)(1 - \eta^2)}$$

21.2. Definition of Prolate Spheroidal Coordinates

If the system of confocal ellipses and hyperbolas referred to in 21.1.3 and 21.1.4 revolves around the major axis, then

$$21.2.1 \quad \frac{x^2}{\xi^2} + \frac{r^2}{\xi^2 - 1} = f^2; \quad \frac{x^2}{\eta^2} - \frac{r^2}{1 - \eta^2} = f^2$$

$$y = r \cos \phi; \quad z = r \sin \phi; \quad 0 \leq \phi \leq 2\pi$$

where ξ , η and ϕ are prolate spheroidal coordinates.

Relations Between Cartesian and Prolate Spheroidal Coordinates

21.2.2

$$x = f\xi\eta; \quad y = f\sqrt{(\xi^2 - 1)(1 - \eta^2)} \cos \phi; \\ z = f\sqrt{(\xi^2 - 1)(1 - \eta^2)} \sin \phi$$

21.3. Definition of Oblate Spheroidal Coordinates

If the system of confocal ellipses and hyperbolas referred to in 21.1.3 and 21.1.4 revolves around the minor axis, then

$$21.3.1 \quad \frac{r^2}{\xi^2} + \frac{y^2}{\xi^2 - 1} = f^2; \quad \frac{r^2}{\eta^2} - \frac{y^2}{1 - \eta^2} = f^2$$

$$z = r \cos \phi; \quad x = r \sin \phi; \quad 0 \leq \phi \leq 2\pi$$

where ξ , η and ϕ are oblate spheroidal coordinates.

Relations Between Cartesian and Oblate Spheroidal Coordinates

21.3.2

$$x = f\xi\eta \sin \phi; \quad y = f\sqrt{(\xi^2 - 1)(1 - \eta^2)}; \quad z = f\xi\eta \cos \phi$$

21.4. Laplacian in Spheroidal Coordinates

21.4.1

$$\nabla^2 = \frac{1}{h_\xi h_\eta h_\phi} \left[\frac{\partial}{\partial \xi} \left(\frac{h_\eta h_\phi}{h_\xi} \frac{\partial}{\partial \xi} \right) + \frac{\partial}{\partial \eta} \left(\frac{h_\xi h_\phi}{h_\eta} \frac{\partial}{\partial \eta} \right) + \frac{\partial}{\partial \phi} \left(\frac{h_\xi h_\eta}{h_\phi} \frac{\partial}{\partial \phi} \right) \right]$$

$$h_\xi^2 = \left(\frac{\partial x}{\partial \xi} \right)^2 + \left(\frac{\partial y}{\partial \xi} \right)^2 + \left(\frac{\partial z}{\partial \xi} \right)^2$$

$$h_\eta^2 = \left(\frac{\partial x}{\partial \eta} \right)^2 + \left(\frac{\partial y}{\partial \eta} \right)^2 + \left(\frac{\partial z}{\partial \eta} \right)^2$$

$$h_\phi^2 = \left(\frac{\partial x}{\partial \phi} \right)^2 + \left(\frac{\partial y}{\partial \phi} \right)^2 + \left(\frac{\partial z}{\partial \phi} \right)^2$$

Metric Coefficients for Prolate Spheroidal Coordinates

21.4.2

$$h_\xi = f\sqrt{\frac{\xi^2 - \eta^2}{\xi^2 - 1}}; \quad h_\eta = f\sqrt{\frac{\xi^2 - \eta^2}{1 - \eta^2}}; \quad h_\phi = f\sqrt{(\xi^2 - 1)(1 - \eta^2)} \quad *$$

Metric Coefficients for Oblate Spheroidal Coordinates

21.4.3

$$h_\xi = f\sqrt{\frac{\xi^2 - \eta^2}{\xi^2 - 1}}; \quad h_\eta = f\sqrt{\frac{\xi^2 - \eta^2}{1 - \eta^2}}; \quad h_\phi = f\xi\eta \quad *$$

21.5. Wave Equation in Prolate and Oblate Spheroidal Coordinates

Wave Equation in Prolate Spheroidal Coordinates

21.5.1

$$\nabla^2 \Phi + k^2 \Phi = \frac{\partial}{\partial \xi} \left[(\xi^2 - 1) \frac{\partial \Phi}{\partial \xi} \right] + \frac{\partial}{\partial \eta} \left[(1 - \eta^2) \frac{\partial \Phi}{\partial \eta} \right] \\ + \frac{\xi^2 - \eta^2}{(\xi^2 - 1)(1 - \eta^2)} \frac{\partial^2 \Phi}{\partial \phi^2} + c^2 (\xi^2 - \eta^2) \Phi = 0$$

$$\left(c = \frac{1}{2}fk \right)$$

*See page II.

Wave Equation in Oblate Spheroidal Coordinates

21.5.2

$$\nabla^2\Phi + k^2\Phi = \frac{\partial}{\partial\xi} \left[(\xi^2+1) \frac{\partial\Phi}{\partial\xi} \right] + \frac{\partial}{\partial\eta} \left[(1-\eta^2) \frac{\partial\Phi}{\partial\eta} \right] + \frac{\xi^2+\eta^2}{(\xi^2+1)(1-\eta^2)} \frac{\partial^2\Phi}{\partial\phi^2} + c^2(\xi^2+\eta^2)\Phi = 0$$

$$\left(c = \frac{1}{2}fk \right)$$

21.5.2 may be obtained from 21.5.1 by the transformations

$$\xi \rightarrow \pm i\xi, c \rightarrow \mp ic.$$

21.6. Differential Equations for Radial and Angular Prolate Spheroidal Wave Functions

If in 21.5.1 we put

$$\Phi = R_{mn}(c, \xi) S_{mn}(c, \eta) \frac{\cos}{\sin} m\phi$$

then the "radial solution" $R_{mn}(c, \xi)$ and the "angular solution" $S_{mn}(c, \eta)$ satisfy the differential equations

21.6.1

$$\frac{d}{d\xi} \left[(\xi^2-1) \frac{d}{d\xi} R_{mn}(c, \xi) \right] - \left(\lambda_{mn} - c^2\xi^2 + \frac{m^2}{\xi^2-1} \right) R_{mn}(c, \xi) = 0$$

21.6.2

$$\frac{d}{d\eta} \left[(1-\eta^2) \frac{d}{d\eta} S_{mn}(c, \eta) \right] + \left(\lambda_{mn} - c^2\eta^2 - \frac{m^2}{1-\eta^2} \right) S_{mn}(c, \eta) = 0$$

where the separation constants (or eigenvalues) λ_{mn} are to be determined so that $R_{mn}(c, \xi)$ and $S_{mn}(c, \eta)$ are finite at $\xi = \pm 1$ and $\eta = \pm 1$ respectively.

(21.6.1 and 21.6.2 are identical. Radial and angular prolate spheroidal functions satisfy the same differential equation over different ranges of the variable.)

Differential Equations for Radial and Angular Oblate Spheroidal Functions

21.6.3

$$\frac{d}{d\xi} \left[(\xi^2+1) \frac{d}{d\xi} R_{mn}(c, \xi) \right] - \left(\lambda_{mn} - c^2\xi^2 - \frac{m^2}{\xi^2+1} \right) R_{mn}(c, \xi) = 0$$

21.6.4

$$\frac{d}{d\eta} \left[(1-\eta^2) \frac{d}{d\eta} S_{mn}(c, \eta) \right] + \left(\lambda_{mn} + c^2\eta^2 - \frac{m^2}{1-\eta^2} \right) S_{mn}(c, \eta) = 0$$

(21.6.3 may be obtained from 21.6.1 by the transformations $\xi \rightarrow \pm i\xi, c \rightarrow \mp ic$; 21.6.4 may be obtained from 21.6.2 by the transformation $c \rightarrow \mp ic$.)

21.7. Prolate Angular Functions

21.7.1

$$S_{mn}^{(1)}(c, \eta) = \sum_{r=0,1}^{\infty} d_r^{mn}(c) P_{m+r}^m(\eta)$$

= Prolate angular function of the first kind

21.7.2

$$S_{mn}^{(2)}(c, \eta) = \sum_{r=-\infty}^{\infty} d_r^{mn}(c) Q_{m+r}^m(\eta)$$

= Prolate angular function of the second kind

($P_n^m(\eta)$ and $Q_n^m(\eta)$ are associated Legendre functions of the first and second kinds respectively. However, for $-1 \leq z \leq 1, P_n^m(z) = (1-z^2)^{m/2} d^m P_n(z) / dz^m$ (see 8.6.6). The summation is extended over even values or odd values of r .)

Recurrence Relations Between the Coefficients

21.7.3

$$\alpha_k d_{k+2} + (\beta_k - \lambda_{mn}) d_k + \gamma_k d_{k-2} = 0$$

$$\alpha_k = \frac{(2m+k+2)(2m+k+1)c^2}{(2m+2k+3)(2m+2k+5)}$$

$$\beta_k = (m+k)(m+k+1)$$

$$+ \frac{2(m+k)(m+k+1) - 2m^2 - 1}{(2m+2k-1)(2m+2k+3)} c^2$$

$$\gamma_k = \frac{k(k-1)c^2}{(2m+2k-3)(2m+2k-1)}$$

Transcendental Equation for λ_{mn}

21.7.4

$$U(\lambda_{mn}) = U_1(\lambda_{mn}) + U_2(\lambda_{mn}) = 0$$

$$U_1(\lambda_{mn}) = \gamma_r^m - \lambda_{mn} - \frac{\beta_r^m}{\gamma_{r-2}^m - \lambda_{mn}} - \frac{\beta_{r-2}^m}{\gamma_{r-4}^m - \lambda_{mn}} - \dots$$

$$U_2(\lambda_{mn}) = -\frac{\beta_{r+2}^m}{\gamma_{r+2}^m - \lambda_{mn}} - \frac{\beta_{r+4}^m}{\gamma_{r+4}^m - \lambda_{mn}} - \dots$$

$$\beta_k^m = \frac{k(k-1)(2m+k)(2m+k-1)c^4}{(2m+2k-1)^2(2m+2k+1)(2m+2k-3)}$$

($k \geq 2$)

$$\gamma_k^m = (m+k)(m+k+1)$$

$$+ \frac{1}{2}c^2 \left[1 - \frac{4m^2-1}{(2m+2k-1)(2m+2k+3)} \right] \quad (k \geq 0)$$

(The choice of r in 21.7.4 is arbitrary.)

Power Series Expansion for λ_{mn}

21.7.5

$$\lambda_{mn} = \sum_{k=0}^{\infty} l_{2k} c^{2k}$$

$$l_0 = n(n+1)$$

$$l_2 = \frac{1}{2} \left[1 - \frac{(2m-1)(2m+1)}{(2n-1)(2n+3)} \right]$$

$$l_4 = \frac{-(n-m+1)(n-m+2)(n+m+1)(n+m+2)}{2(2n+1)(2n+3)^3(2n+5)} + \frac{(n-m-1)(n-m)(n+m-1)(n+m)}{2(2n-3)(2n-1)^3(2n+1)}$$

$$l_6 = (4m^2 - 1) \left[\frac{(n-m+1)(n-m+2)(n+m+1)(n+m+2)}{(2n-1)(2n+1)(2n+3)^5(2n+5)(2n+7)} - \frac{(n-m-1)(n-m)(n+m-1)(n+m)}{(2n-5)(2n-3)(2n-1)^5(2n+1)(2n+3)} \right]$$

$$l_8 = 2(4m^2 - 1)^2 A + \frac{1}{16} B + \frac{1}{8} C + \frac{1}{2} D$$

$$A = \frac{(n-m-1)(n-m)(n+m-1)(n+m)}{(2n-5)^2(2n-3)(2n-1)^2(2n+1)(2n+3)^2} - \frac{(n-m+1)(n-m+2)(n+m+1)(n+m+2)}{(2n-1)^2(2n+1)(2n+3)^2(2n+5)(2n+7)^2}$$

$$B = \frac{(n-m-3)(n-m-2)(n-m-1)(n-m)(n+m-3)(n+m-2)(n+m-1)(n+m)}{(2n-7)(2n-5)^2(2n-3)^3(2n-1)^4(2n+1)} \\ - \frac{(n-m+1)(n-m+2)(n-m+3)(n-m+4)(n+m+1)(n+m+2)(n+m+3)(n+m+4)}{(2n+1)(2n+3)^4(2n+5)^3(2n+7)^2(2n+9)}$$

$$C = \frac{(n-m+1)^2(n-m+2)^2(n+m+1)^2(n+m+2)^2}{(2n+1)^2(2n+3)^2(2n+5)^2} - \frac{(n-m-1)^2(n-m)^2(n+m-1)^2(n+m)^2}{(2n-3)^2(2n-1)^2(2n+1)^2}$$

$$D = \frac{(n-m-1)(n-m)(n-m+1)(n-m+2)(n+m-1)(n+m)(n+m+1)(n+m+2)}{(2n-3)(2n-1)^4(2n+1)^2(2n+3)^4(2n+5)}$$

Asymptotic Expansion for λ_{mn}

21.7.6

$$\lambda_{mn}(c) = cq + m^2 - \frac{1}{8}(q^2 + 5) - \frac{q}{64c}(q^2 + 11 - 32m^2) \\ - \frac{1}{1024c^2} [5(q^4 + 26q^2 + 21) - 384m^2(q^2 + 1)] \\ - \frac{1}{c^3} \left[\frac{1}{128^2} (33q^5 + 1594q^3 + 5621q) \right. \\ \left. - \frac{m^2}{128} (37q^3 + 167q) + \frac{m^4}{8} q \right] \\ - \frac{1}{c^4} \left[\frac{1}{256^2} (63q^6 + 4940q^4 + 43327q^2 + 22470) \right. \\ \left. - \frac{m^2}{512} (115q^4 + 1310q^2 + 735) + \frac{3m^4}{8} (q^2 + 1) \right] \\ - \frac{1}{c^5} \left[\frac{1}{1024^2} (527q^7 + 61529q^5 + 1043961q^3 \right. \\ \left. + 2241599q) - \frac{m^2}{32 \cdot 1024} (5739q^5 + 127550q^3 \right. \\ \left. + 298951q) + \frac{m^4}{512} (355q^3 + 1505q) - \frac{m^6 q}{16} \right] + O(c^{-6}) \\ q = 2(n-m) + 1$$

Refinement of Approximate Values of λ_{mn}

If $\lambda_{mn}^{(1)}$ is an approximation to λ_{mn} obtained either from 21.7.5 or 21.7.6 then

21.7.7

$$\lambda_{mn} = \lambda_{mn}^{(1)} + \delta\lambda_{mn}$$

$$\delta\lambda_{mn} = \frac{U_1(\lambda_{mn}^{(1)}) + U_2(\lambda_{mn}^{(1)})}{\Delta_1 + \Delta_2}$$

$$\Delta_1 = 1 + \frac{\beta_r^m}{(N_r^m)^2} + \frac{\beta_r^m \beta_{r-2}^m}{(N_r^m N_{r-2}^m)^2} + \frac{\beta_r^m \beta_{r-2}^m \beta_{r-4}^m}{(N_r^m N_{r-2}^m N_{r-4}^m)^2} + \dots$$

$$\Delta_2 = \frac{(N_{r+2}^m)^2}{\beta_{r+2}^m} + \frac{(N_{r+2}^m N_{r+4}^m)^2}{\beta_{r+2}^m \beta_{r+4}^m} + \frac{(N_{r+2}^m N_{r+4}^m N_{r+6}^m)^2}{\beta_{r+2}^m \beta_{r+4}^m \beta_{r+6}^m} + \dots$$

$$N_r^m = \frac{(2m+r)(2m+r-1)c^2}{(2m+2r-1)(2m+2r+1)} \frac{d_r}{d_{r-2}} \quad (r \geq 2)$$

$$\beta_r^m = \frac{r(r-1)(2m+r)(2m+r-1)c^4}{(2m+2r-1)^2(2m+2r+1)(2m+2r-3)}$$

$$(r \geq 2)$$

Evaluation of Coefficients

Step 1. Calculate $N_r^{m'}$'s from

21.7.8

$$N_{r+2}^m = \gamma_r^m - \lambda_{mn} - \frac{\beta_r^m}{N_r^m} \quad (r \geq 2)$$

$$N_2^m = \gamma_0^m - \lambda_{mn}; N_3^m = \gamma_1^m - \lambda_{mn}$$

$$\gamma_r^m = (m+r)(m+r+1)$$

$$+ \frac{1}{2} c^2 \left[1 - \frac{4m^2 - 1}{(2m+2r-1)(2m+2r+3)} \right] \quad (r \geq 0)$$

Step 2. Calculate ratios $\frac{d_0}{d_{2r}}$ and $\frac{d_1}{d_{2p+1}}$ from

21.7.9
$$\frac{d_0}{d_{2r}} = \left(\frac{d_0}{d_2}\right) \left(\frac{d_2}{d_4}\right) \dots \left(\frac{d_{2r-2}}{d_{2r}}\right)$$

21.7.10
$$\frac{d_1}{d_{2p+1}} = \left(\frac{d_1}{d_3}\right) \left(\frac{d_3}{d_5}\right) \dots \left(\frac{d_{2p-1}}{d_{2p+1}}\right)$$

and the formula for N_r^m in 21.7.7.

The coefficients $d_r^{m'}$ are determined to within the arbitrary factor d_0 for r even and d_1 for r odd. The choice of these factors depends on the normalization scheme adopted.

Normalization of Angular Functions

Meixner-Schäpfke Scheme

21.7.11
$$\int_{-1}^1 [S_{mn}(c, \eta)]^2 d\eta = \frac{2}{2n+1} \frac{(n+m)!}{(n-m)!}$$

Stratton-Morse-Chu-Little-Corbato Scheme

21.7.12
$$\sum_{r=0,1}^{\infty} \frac{(r+2m)!}{r!} d_r = \frac{(n+m)!}{(n-m)!}$$

(This normalization has the effect that $S_{mn}(c, \eta) \rightarrow P_n^m(\eta)$ as $\eta \rightarrow 1$.)

Flammer Scheme [21.4]

21.7.13

$$S_{mn}(c, 0) = P_n^m(0) = \frac{(-1)^{\frac{n-m}{2}} (n+m)!}{2^n \left(\frac{n-m}{2}\right)! \left(\frac{n+m}{2}\right)!} \quad (n-m) \text{ even}$$

21.7.14

$$S'_{mn}(c, 0) = P_n^m(0) = \frac{(-1)^{\frac{n-m-1}{2}} (n+m+1)!}{2^n \left(\frac{n-m-1}{2}\right)! \left(\frac{n+m+1}{2}\right)!} \quad (n-m) \text{ odd}$$

The above lead to the following conditions for $d_r^{m'}$

21.7.15

$$\sum_{r=0}^{\infty} \frac{(-1)^{r/2} (r+2m)!}{2^r \left(\frac{r}{2}\right)! \left(\frac{r+2m}{2}\right)!} d_r^{m'} = \frac{(-1)^{\frac{n-m}{2}} (n+m)!}{2^{n-m} \left(\frac{n-m}{2}\right)! \left(\frac{n+m}{2}\right)!} \quad (n-m) \text{ even}$$

21.7.16

$$\sum_{r=1}^{\infty} \frac{(-1)^{\frac{r-1}{2}} (r+2m+1)!}{2^r \left(\frac{r-1}{2}\right)! \left(\frac{r+2m+1}{2}\right)!} d_r^{m'} = \frac{(-1)^{\frac{n-m-1}{2}} (n+m+1)!}{2^{n-m} \left(\frac{n-m-1}{2}\right)! \left(\frac{n+m+1}{2}\right)!} \quad (n-m) \text{ odd}$$

(The normalization scheme 21.7.13 and 21.7.14 is also used in [21.10].)

Asymptotic Expansions for $S_{mn}(c, \eta)$

21.7.17

$$S_{mn}(c, \eta) = (1-\eta^2)^{\frac{1}{2}} U_{mn}(c, \eta) \quad (c \rightarrow \infty)$$

$$U_{mn}(x) = \sum_{l=-\infty}^{\infty} h_l^{\dagger} D_{l+r}(x) \quad l = n-m$$

where the $D_l(x)$'s are the parabolic cylinder functions (see chapter 19).

$$D_r(x) = (-1)^r e^{x^2/4} \frac{d^2}{dx^2} e^{-x^2/2} = 2^{-r/2} e^{-x^2/4} H_r \left(\frac{x}{\sqrt{2}} \right)$$

and the $H_r(x)$ are the Hermite polynomials (see chapter 22). (For tables of $h_{\pm}^{\dagger}/h_0^{\dagger}$ see [21.4].)

Expansion of $S_{mn}(c, \eta)$ in Powers of η

21.7.18

$$S_{mn}(c, \eta) = (1-\eta^2)^{m/2} \sum_{r=0,1}^{\infty} p_r^{mn}(c) \eta^r$$

$$(r+1)(r+2)p_{r+2}^{mn}(c) - [r(r+2m+1) + m(m+1) - \lambda_{mn}(c)]p_r^{mn}(c) - c^2 p_{r-2}^{mn}(c) = 0$$

(The derivation of the transcendental equation for λ_{mn} is similar to the derivation of 21.7.4 from 21.7.3.)

Expansion of $S_{mn}(c, \eta)$ in Powers of $(1-\eta^2)$

21.7.19

$$S_{mn}(c, \eta) = (1-\eta^2)^{m/2} \sum_{k=0}^{\infty} c_{2k}^{mn} (1-\eta^2)^k \quad (n-m) \text{ even}$$

21.7.20

$$S_{mn}(c, \eta) = \eta(1-\eta^2)^{m/2} \sum_{k=0}^{\infty} c_{2k}^{mn} (1-\eta^2)^k \quad (n-m) \text{ odd}$$

$$c_{2k}^{mn} = \frac{1}{2^m k! (m+k)!} \sum_{r=k}^{\infty} \frac{(2m+2r)!}{(2r)!} (-r)_k \left(m+r+\frac{1}{2}\right)_k d_{2r}^{mn} \quad (n-m) \text{ even}$$

$$c_{2k}^{mn} = \frac{1}{2^m k! (m+k)!} \sum_{r=k}^{\infty} \frac{(2m+2r+1)!}{(2r+1)!} (-r)_k \left(m+r+\frac{3}{2}\right)_k d_{2r+1}^{mn} \quad (n-m) \text{ odd}$$

$$(\alpha)_k = \alpha(\alpha+1)(\alpha+2) \dots (\alpha+k-1)$$

(The d_r^{mn} 's are the coefficients in 21.7.1.)

Prolate Angular Functions—Second Kind

Expansion 21.7.2 ultimately leads to

21.7.21

$$S_{mn}^{(2)}(c, \eta) = \sum_{r=-2m, -2m+1}^{\infty} d_r^{mn} Q_{m+r}^n(\eta) + \sum_{r=2m+2, 2m+1}^{\infty} d_{r/2}^{mn} P_{r-m-1}^m(\eta)$$

(The coefficients d_r^{mn} are the same as in 21.7.1; the coefficients $d_{r/2}^{mn}$ are tabulated in [21.4].)

21.8. Oblate Angular Functions

Power Series Expansion for Eigenvalues

21.8.1
$$\lambda_{mn} = \sum_{k=0}^{\infty} (-1)^k l_{2k} c^{2k}$$

where the l_k 's are the same as in 21.7.5.

Asymptotic Expansion for Eigenvalues [21.4]

21.8.2

$$\lambda_{mn} = -c^2 + 2c(2\nu+m+1) - 2\nu(\nu+m+1) - (m+1) + \Lambda_{mn}$$

$$\nu = \frac{1}{2}(n-m) \text{ for } (n-m) \text{ even;}$$

$$\nu = \frac{1}{2}(n-m-1) \text{ for } (n-m) \text{ odd}$$

$$\Lambda_{mn} = \sum_{k=1}^{\infty} \beta_k^{mn} c^{-k}$$

$$\beta_1^{mn} = -2^{-3}q(q^2+1-m^2)$$

$$\beta_2^{mn} = -2^{-6}[5q^4+10q^2+1-2m^2(3q^2+1)+m^4]$$

$$\beta_3^{mn} = -2^{-9}q[33q^4+114q^2+37-2m^2(23q^2+25) + 13m^4]$$

$$\beta_4^{mn} = -2^{-10}[63q^6+340q^4+239q^2+14 - 10m^2(10q^4+23q^2+3)+m^4(39q^2-18)-2m^6]$$

$$\beta_k^{mn} = \nu(\nu+m)a_k^{-1} + (\nu+1)(\nu+m+1)a_k^{-1}$$

$$q = n+1 \text{ for } (n-m) \text{ even; } q = n \text{ for } (n-m) \text{ odd}$$

(For the definition of $a_k^{\pm r}$ see 21.8.3.)

Asymptotic Expansion for Oblate Angular Functions

21.8.3

$$S_{mn}(-ic, \eta) \sim (1-\eta^2)^{m/2} \sum_{s=-\nu}^{\infty} A_s^{mn} \{ e^{-c(1-\eta)} L_{\nu+s}^{(m)}[2c(1-\eta)] + (-1)^{n-m} e^{-c(1+\eta)} L_{\nu+s}^{(m)}[2c(1+\eta)] \}$$

where the $L_{\nu}^{(m)}(x)$ are Laguerre polynomials (see chapter 22) and

$$\frac{A_{\pm r}^{mn}}{A_0^{mn}} = \sum_{k=r}^{\infty} a_k^{\pm r}(m, n) c^{-k}$$

(Expressions of $a_k^{\pm r}$ are given in [21.4].)

21.9. Radial Spheroidal Wave Functions

21.9.1

$$R_{mn}^{(p)}(c, \xi) = \left\{ \sum_{r=0,1}^{\infty} \frac{(2m+r)!}{r!} d_r^{mn} \right\}^{-1} \left(\frac{\xi^2-1}{\xi^2} \right)^{m/2} \cdot \sum_{r=0,1}^{\infty} i^{r+m-n} \frac{(2m+r)!}{r!} d_r^{mn} Z_{m+r}^{(p)}(c\xi)^*$$

$$Z_n^{(p)}(z) = \sqrt{\frac{\pi}{2z}} J_{n+\frac{1}{2}}(z) \quad (p=1)$$

$$= \sqrt{\frac{\pi}{2z}} Y_{n+\frac{1}{2}}(z) \quad (p=2)$$

($J_{n+\frac{1}{2}}(z)$ and $Y_{n+\frac{1}{2}}(z)$ are Bessel functions, order $n+\frac{1}{2}$, of the first and second kind respectively (see chapter 10).)

21.9.2
$$R_{mn}^{(3)}(c, \xi) = R_{mn}^{(1)}(c, \xi) + iR_{mn}^{(2)}(c, \xi)$$

21.9.3
$$R_{mn}^{(4)}(c, \xi) = R_{mn}^{(1)}(c, \xi) - iR_{mn}^{(2)}(c, \xi)$$

Asymptotic Behavior of $R_{mn}^{(1)}(c, \xi)$ and $R_{mn}^{(2)}(c, \xi)$

21.9.4
$$R_{mn}^{(1)}(c, \xi) \xrightarrow{c\xi \rightarrow \infty} \frac{1}{c\xi} \cos [c\xi - \frac{1}{2}(n+1)\pi]$$

21.9.5
$$R_{mn}^{(2)}(c, \xi) \xrightarrow{c\xi \rightarrow \infty} \frac{1}{c\xi} \sin [c\xi - \frac{1}{2}(n+1)\pi]$$

*See page II.

21.10. Joining Factors for Prolate Spheroidal Wave Functions

21.10.1

$$S_{mn}^{(1)}(c, \xi) = \kappa_{mn}^{(1)}(c) R_{mn}^{(1)}(c, \xi)$$

$$\kappa_{mn}^{(1)}(c) = \frac{(2m+1)(n+m)! \sum_{r=0}^{\infty} d_r^{mn} (2m+r)! / r!}{2^{n+m} d_0^{mn}(c) c^m m! \left(\frac{n-m}{2}\right)! \left(\frac{n+m}{2}\right)!} \quad (n-m) \text{ even}$$

$$= \frac{(2m+3)(n+m+1)! \sum_{r=1}^{\infty} d_r^{mn} (2m+r)! / r!}{2^{n+m} d_1^{mn}(c) c^{m+1} m! \left(\frac{n-m-1}{2}\right)! \left(\frac{n+m+1}{2}\right)!} \quad (n-m) \text{ odd}$$

21.10.2

$$S_{mn}^{(2)}(c, \xi) = \kappa_{mn}^{(2)}(c) R_{mn}^{(2)}(c, \xi)$$

$$\kappa_{mn}^{(2)}(c) = \frac{2^{n-m} (2m)! \left(\frac{n-m}{2}\right)! \left(\frac{n+m}{2}\right)! d_{-2m}^{mn}(c)}{(2m-1)m!(n+m)! c^{m-1}} \sum_{r=0}^{\infty} \frac{(2m+r)!}{r!} d_r^{mn}(c) \quad (n-m) \text{ even}$$

$$= \frac{2^{n-m} (2m)! \left(\frac{n-m-1}{2}\right)! \left(\frac{n+m+1}{2}\right)! d_{-2m+1}^{mn}(c)}{(2m-3)(2m-1)m!(n+m+1)! c^{m-2}} \sum_{r=1}^{\infty} \frac{(2m+r)!}{r!} d_r^{mn}(c) \quad (n-m) \text{ odd}$$

(The expression for joining factors appropriate to the oblate case may be obtained from the above formulas by the transformation $c \rightarrow -ic$.)

21.11. Notation

Notation for Prolate Spheroidal Wave Functions

	Ang. coord.	Rad. coord.	Independent variable	Ang. wave function	Rad. wave function	Eigenvalue	Normalization of angular functions	Remarks
Stratton, Morse, Chu, Little and Corbató	η	ξ	h	$S_{ml}(h, \eta)$	$j_{eml}(h, \xi)$ $ne_{ml}(h, \xi)$ $he_{ml}(h, \xi)$	$A_{ml}(h)$	$S_{ml}(h, 1) = P_l^m(1)$	$l = \text{Flammer's } n$ $A_{ml} = \lambda_{mn}$
Flammer and this chapter	η	ξ	c	$S_{mn}(c, \eta)$	$R_{mn}^{(l)}(c, \xi)$	$\lambda_{mn}(c)$	$S_{mn}(c, 0) = P_n^m(0)$ ($n-m$) even $S_{mn}(c, 0) = P_n^{m'}(0)$ ($n-m$) odd	
Chu and Stratton	η	ξ	c	$S_{ml}^{(l)}(c, \eta)$	$R_{ml}^{(l)}(c, \xi)$	A_{ml}	$S_{ml}^{(l)}(c, 0) = P_{m+l}^m(0)$ (l even) $S_{ml}^{(l)}(c, 0) = P_{m+l}^{m'}(0)$ (l odd)	$l = \text{Flammer's } n-m$ $A_{ml} = -\lambda_{m, n-m}$
Meixner and Schäfke	η	ξ	γ	$PS_n^m(\eta, \gamma^2)$	$S_n^{m(l)}(\xi, \gamma^2)$	$\lambda_n^m(\gamma^2)$	$\int_{-1}^1 [PS_n^m(\eta, \gamma^2)]^2 d\eta$ $= \frac{2}{2n+1} \frac{(n+m)!}{(n-m)!}$	$\lambda_n^m(\gamma^2) = \lambda_{mn}(c) - c^2$
Morse and Feshbach	$\eta = \cos \vartheta$	$\xi = \cosh \mu$	h	$S_{ml}(h, \eta)$	$j_{eml}(h, \xi)$ $ne_{ml}(h, \xi)$ $he_{ml}(h, \xi)$	A_{ml}	$[(1-\eta^2)^{-m/2} S_{ml}(h, \eta)]_{\eta=1} = [(1-\eta^2)^{-m/2} P_l^m(\eta)]_{\eta=1}$	$l = \text{Flammer's } n$ $A_{ml} = \lambda_{mn}$
Page	ξ	η	ϵ	$U_{lm}(\xi)$	$v_{lm}(\eta)$ $p_{lm}(\eta)$ $q_{lm}(\eta)$	α_{lm}	$[(1-\xi^2)^{-m/2} U_{lm}(\xi)] = 1$ $\xi = 1$	$l = \text{Flammer's } n$ $\alpha_{lm} = \lambda_{mn} - c^2$

Notation for Oblate Spheroidal Wave Functions

Stratton, Morse, Chu, Little and Corbató	η	ξ	g	$S_{ml}(ig, \eta)$	$j_{eml}(ig, -i\xi)$	A_{ml}	$S_{ml}(ig, 1) = P_l^m(1)$	$l = \text{Flammer's } n$ $A_{ml} = \lambda_{mn}$
Flammer and this chapter	η	ξ	c	$S_{mn}(-ic, \eta)$	$R_{mn}^{(l)}(-ic, i\xi)$	$\lambda_{mn}(-ic)$	$S_{mn}(-ic, 0) = P_n^m(0)$ ($n-m$) even $S_{mn}(-ic, 0) = P_n^{m'}(0)$ ($n-m$) odd	
Chu and Stratton	η	ξ	c	$S_{ml}^{(l)}(-ic, \eta)$	$R_{ml}^{(l)}(-ic, i\xi)$	B_{ml}	$S_{ml}^{(l)}(-ic, 0) = P_{m+l}^m(0)$ (l even) $S_{ml}^{(l)}(-ic, 0) = P_{m+l}^{m'}(0)$ (l odd)	$l = \text{Flammer's } n-m$ $B_{lm} = -\lambda_{m, n-m}$
Meixner and Schäfke	η	ξ	γ	$ps_n^m(\eta, -\gamma^2)$	$S_n^{m(l)}(-i\xi, i\gamma^2)$	$\lambda_n^m(-\gamma^2)$	$\int_{-1}^1 [ps_n^m(\eta, -\gamma^2)]^2 d\eta$ $= \frac{2}{2n+1} \frac{(n+m)!}{(n-m)!}$	$\lambda_n^m(-\gamma^2) = \lambda_{mn}(-ic) + c^2$
Morse and Feshbach	$\eta = \cos \vartheta$	$\xi = \sinh \mu$	g	$S_{ml}(ig, \eta)$	$j_{eml}(ig, -i\xi)$ $ne_{ml}(ig, -i\xi)$ $he_{ml}(ig, -i\xi)$	A_{ml}	$[(1-\eta^2)^{-m/2} S_{ml}(ig, \eta)]_{\eta=1} = [(1-\eta^2)^{-m/2} P_l^m(\eta)]_{\eta=1}$	$l = \text{Flammer's } n$ $A_{ml} = \lambda_{mn}$
Leitner and Spence	η	ξ	ϵ	$U_{lm}(\eta)$	(i) $v_{lm}(\xi)$	α_{lm}	$[(1-\eta^2)^{-m/2} U_{lm}(\eta)]_{\eta=1} = 1$	$l = \text{Flammer's } n$ $\alpha_{lm} = \lambda_{mn} + c^2$

The notation in this chapter closely follows the notation in [21.4].

References

- [21.1] M. Abramowitz, Asymptotic expansion of spheroidal wave functions, *J. Math. Phys.* **28**, 195-199 (1949).
- [21.2] G. Blanch, On the computation of Mathieu functions, *J. Math. Phys.* **25**, 1-20 (1946).
- [21.3] C. J. Bouwkamp, Theoretische en numerieke behandeling van de buiging door en ronde opening, Diss. Groningen, Groningen-Batavia, (1941).
- [21.4] C. Flammer, Spheroidal wave functions (Stanford Univ. Press, Stanford, Calif., 1957).
- [21.5] A. Leitner and R. D. Spence, The oblate spheroidal wave functions, *J. Franklin Inst.* **249**, 299-321 (1950).
- [21.6] J. Meixner and F. W. Schäfke, Mathieusche Funktionen und Sphäroidfunktionen (Springer-Verlag, Berlin, Göttingen, Heidelberg, Germany, 1954).
- [21.7] P. M. Morse and H. Feshbach, Methods of theoretical physics (McGraw-Hill Book Co., Inc., New York, N.Y., 1953).
- [21.8] L. Page, The electrical oscillations of a prolate spheroid, *Phys. Rev.* **65**, 98-117 (1944).
- [21.9] J. A. Stratton, P. M. Morse, L. J. Chu and R. A. Hutner, Elliptic cylinder and spheroidal wave functions (John Wiley & Sons, Inc., New York, N.Y., 1941).
- [21.10] J. A. Stratton, P. M. Morse, L. J. Chu, J. D. C. Little, and F. J. Corbató, Spheroidal wave functions (John Wiley & Sons, Inc., New York, N.Y., 1956).

Table 21.1

EIGENVALUES—PROLATE AND OBLATE

		PROLATE				
		$\lambda_{mn}(c) - m(m+1)$ *				
		$\lambda_{0n}(c)$				
$c^2 \backslash n$	0	1	2	3	4	
0	0.000000	2.000000	6.000000	12.000000	20.000000	
1	0.319000	2.593084	6.533471	12.514462	20.508274	
2	0.611314	3.172127	7.084258	13.035830	21.020137	
3	0.879933	3.736869	7.649317	13.564354	21.535636	
4	1.127734	4.287128	8.225713	14.100203	22.054829	
5	1.357356	4.822809	8.810735	14.643458	22.577779	
6	1.571155	5.343903	9.401958	15.194110	23.104553	
7	1.771183	5.850492	9.997251	15.752059	23.635223	
8	1.959206	6.342739	10.594773	16.317122	24.169860	
9	2.136732	6.820888	11.192938	16.889030	24.708534	
10	2.305040	7.285254	11.790394	17.467444	25.251312	
11	2.465217	7.736212	12.385986	18.051962	25.798254	
12	2.618185	8.174189	12.978730	18.642128	26.349411	
13	2.764731	8.599648	13.567791	19.237446	26.904827	
14	2.905523	9.013085	14.152458	19.837389	27.464530	
15	3.041137	9.415010	14.732130	20.441413	28.028539	
16	3.172067	9.805943	15.306299	21.048960	28.596854	
	$\left[\begin{smallmatrix} (-3)3 \\ 6 \end{smallmatrix} \right]$	$\left[\begin{smallmatrix} (-3)2 \\ 5 \end{smallmatrix} \right]$	$\left[\begin{smallmatrix} (-3)2 \\ 6 \end{smallmatrix} \right]$	$\left[\begin{smallmatrix} (-4)9 \\ 5 \end{smallmatrix} \right]$	$\left[\begin{smallmatrix} (-4)5 \\ 5 \end{smallmatrix} \right]$	
$c^{-1} \backslash n$	0	1	2	3	4	
0.25	0.793016	2.451485	3.826574	5.26224	7.14921	
0.24	0.802442	2.477117	3.858771	5.25133	7.05054	
0.23	0.811763	2.503218	3.895890	5.25040	6.96237	
0.22	0.820971	2.529593	3.937869	5.26046	6.88638	
0.21	0.830059	2.556036	3.984499	5.28251	6.82460	
0.20	0.839025	2.582340	4.035382	5.31747	6.77941	
0.19	0.847869	2.608310	4.089903	5.36610	6.75360	
0.18	0.856592	2.633778	4.147207	5.42883	6.75030	
0.17	0.865200	2.658616	4.206229	5.50551	6.77286	
0.16	0.873698	2.682743	4.265772	5.59516	6.82451	
0.15	0.882095	2.706127	4.324653	5.69566	6.90779	
0.14	0.890399	2.728784	4.381878	5.80359	7.02356	
0.13	0.898617	2.750762	4.436798	5.91452	7.16962	
0.12	0.906758	2.772133	4.489168	6.02383	7.33916	
0.11	0.914827	2.792971	4.539096	6.12806	7.52035	
0.10	0.922830	2.813346	4.586895	6.22577	7.69932	
0.09	0.930772	2.833316	4.632927	6.31730	7.86638	
0.08	0.938657	2.852927	4.677506	6.40385	8.01951	
0.07	0.946487	2.872213	4.720863	6.48655	8.16148	
0.06	0.954267	2.891203	4.763160	6.56618	8.29538	
0.05	0.961998	2.909920	4.804519	6.64326	8.42315	
0.04	0.969683	2.928382	4.845033	6.71812	8.54594	
0.03	0.977324	2.946608	4.884779	6.79104	8.66452	
0.02	0.984923	2.964611	4.923820	6.86221	8.77945	
0.01	0.992481	2.982404	4.962212	6.93182	8.89116	
0.00	1.000000	3.000000	5.000000	7.00000	9.00000	
	$\left[\begin{smallmatrix} (-5)2 \\ 4 \end{smallmatrix} \right]$	$\left[\begin{smallmatrix} (-5)9 \\ 5 \end{smallmatrix} \right]$	$\left[\begin{smallmatrix} (-4)6 \\ 6 \end{smallmatrix} \right]$	$\left[\begin{smallmatrix} (-3)2 \\ 6 \end{smallmatrix} \right]$	$\left[\begin{smallmatrix} (-3)4 \\ 9 \end{smallmatrix} \right]$	

*See page II.

EIGENVALUES—PROLATE AND OBLATE

Table 21.1

OBLATE

$c^2 \backslash n$	$\lambda_{mn}(-ic) - m(m+1)$ *				
	$\lambda_{0n}(-ic)$				
	0	1	2	3	4
0	0.000000	2.000000	6.000000	12.000000	20.000000
1	-0.348602	1.393206	5.486800	11.492120	19.495276
2	-0.729391	0.773097	4.996484	10.990438	18.994079
3	-1.144328	+0.140119	4.531027	10.494512	18.496395
4	-1.594493	-0.505243	4.091509	10.003863	18.002228
5	-2.079934	-1.162477	3.677958	9.517982	17.511597
6	-2.599668	-1.831050	3.289357	9.036338	17.024540
7	-3.151841	-2.510421	2.923796	8.558395	16.541110
8	-3.733981	-3.200049	2.578730	8.083615	16.061382
9	-4.343292	-3.899400	2.251269	7.611465	15.585448
10	-4.976895	-4.607952	1.938419	7.141427	15.113424
11	-5.632021	-5.325200	1.637277	6.673700	14.645441
12	-6.306116	-6.050659	1.345136	6.205705	14.181652
13	-6.996903	-6.783867	1.059541	5.739084	13.722230
14	-7.702385	-7.524384	0.778305	5.272706	13.267364
15	-8.420841	-8.271795	0.499495	4.806165	12.817261
16	-9.150793	-9.025710	0.221407	4.339082	12.372144
	$\left[\begin{smallmatrix} (-3)4 \\ 7 \end{smallmatrix} \right]$	$\left[\begin{smallmatrix} (-3)2 \\ 5 \end{smallmatrix} \right]$	$\left[\begin{smallmatrix} (-3)3 \\ 7 \end{smallmatrix} \right]$	$\left[\begin{smallmatrix} (-4)8 \\ 5 \end{smallmatrix} \right]$	$\left[\begin{smallmatrix} (-4)6 \\ 5 \end{smallmatrix} \right]$
$c^{-1} \backslash n$	$c^{-2}[\lambda_{0n}(-ic)]$				
	0	1	2	3	4
0.25	-0.571924	-0.564106	+0.013837	0.271192	0.77325
0.24	-0.585248	-0.579552	-0.009136	0.213225	0.67822
0.23	-0.599067	-0.595037	-0.031481	0.157464	0.58772
0.22	-0.613349	-0.610591	-0.053477	0.103825	0.50191
0.21	-0.628058	-0.626242	-0.075480	0.052196	0.42099
0.20	-0.643161	-0.642016	-0.097943	+0.002437	0.34521
0.19	-0.658625	-0.657938	-0.121428	-0.045635	0.27490
0.18	-0.674418	-0.674031	-0.146603	-0.092251	0.21043
0.17	-0.690515	-0.690310	-0.174201	-0.137692	0.15215
0.16	-0.706891	-0.706792	-0.204894	-0.182301	0.10020
0.15	-0.723530	-0.723486	-0.239109	-0.226469	0.05428
0.14	-0.740416	-0.740399	-0.276886	-0.270627	+0.01332
0.13	-0.757541	-0.757535	-0.317881	-0.315206	-0.02476
0.12	-0.774896	-0.774894	-0.361548	-0.360594	-0.06337
0.11	-0.792476	-0.792476	-0.407352	-0.407081	-0.10723
0.10	-0.810279	-0.810279	-0.454896	-0.454839	-0.16065
0.09	-0.828301	-0.828301	-0.503937	-0.503928	-0.22419
0.08	-0.846539	-0.846539	-0.554337	-0.554337	-0.29513
0.07	-0.864992	-0.864992	-0.606021	-0.606021	-0.37117
0.06	-0.883657	-0.883657	-0.658931	-0.658931	-0.45125
0.05	-0.902532	-0.902532	-0.713025	-0.713025	-0.53495
0.04	-0.921616	-0.921616	-0.768262	-0.768262	-0.62200
0.03	-0.940906	-0.940906	-0.824608	-0.824608	-0.71218
0.02	-0.960402	-0.960402	-0.882031	-0.882031	-0.80533
0.01	-0.980100	-0.980100	-0.940503	-0.940503	-0.90131
0.00	-1.000000	-1.000000	-1.000000	-1.000000	-1.00000
	$\left[\begin{smallmatrix} (-5)6 \\ 4 \end{smallmatrix} \right]$	$\left[\begin{smallmatrix} (-5)3 \\ 4 \end{smallmatrix} \right]$	$\left[\begin{smallmatrix} (-4)4 \\ 7 \end{smallmatrix} \right]$	$\left[\begin{smallmatrix} (-4)3 \\ 6 \end{smallmatrix} \right]$	$\left[\begin{smallmatrix} (-3)1 \\ 8 \end{smallmatrix} \right]$

*See page II.

Table 21.1

EIGENVALUES—PROLATE AND OBLATE

PROLATE					
$\lambda_{mn}(c) - m(m+1)$ *					
$\lambda_{1n}(c) - 2$ *					
$c^2 \backslash n$	1	2	3	4	5
0	0.000000	4.000000	10.000000	18.000000	28.000000
1	0.195548	4.424699	10.467915	18.481696	28.488065
2	0.382655	4.841718	10.937881	18.965685	28.977891
3	0.561975	5.251162	11.409266	19.451871	29.469456
4	0.734111	5.653149	11.881493	19.940143	29.962738
5	0.899615	6.047807	12.354034	20.430382	30.457716
6	1.058995	6.435272	12.826413	20.922458	30.954363
7	1.212711	6.815691	13.298196	21.416235	31.452653
8	1.361183	7.189213	13.768997	21.911569	31.952557
9	1.504795	7.555998	14.238466	22.408312	32.454044
10	1.643895	7.916206	14.706292	22.906311	32.957080
11	1.778798	8.270004	15.172199	23.405410	33.461629
12	1.909792	8.617558	15.635940	23.905451	33.967652
13	2.037141	8.959038	16.097297	24.406277	34.475109
14	2.161081	9.294612	16.556078	24.907729	34.983956
15	2.281832	9.624450	17.012115	25.409649	35.494147
16	2.399593	9.948719	17.465260	25.911881	36.005634
	$\begin{bmatrix} (-3)1 \\ 5 \end{bmatrix}$	$\begin{bmatrix} (-3)1 \\ 5 \end{bmatrix}$	$\begin{bmatrix} (-4)4 \\ 5 \end{bmatrix}$	$\begin{bmatrix} (-4)3 \\ 4 \end{bmatrix}$	$\begin{bmatrix} (-4)2 \\ 4 \end{bmatrix}$
$c^{-1} \backslash \lambda_{1n}(c) - 2$ *					
$c^{-1} \backslash n$	1	2	3	4	5
0.25	0.599898	2.487179	4.366315	6.47797	9.00140
0.24	0.613295	2.491544	4.338520	6.38296	8.80891
0.23	0.627023	2.497852	4.315609	6.29522	8.62445
0.22	0.641073	2.506130	4.297923	6.21556	8.44916
0.21	0.655431	2.516383	4.285792	6.14494	8.28436
0.20	0.670084	2.528591	4.279522	6.08438	8.13163
0.19	0.685014	2.542705	4.279366	6.03498	7.99282
0.18	0.700204	2.558644	4.285495	5.99788	7.87010
0.17	0.715632	2.576296	4.297965	5.97420	7.76598
0.16	0.731281	2.595516	4.316672	5.96496	7.68328
0.15	0.747129	2.616135	4.341320	5.97090	7.62508
0.14	0.763159	2.637968	4.371397	5.99230	7.59446
0.13	0.779353	2.660829	4.406191	6.02874	7.59407
0.12	0.795696	2.684536	4.444844	6.07889	7.62539
0.11	0.812174	2.708934	4.486445	6.14051	7.68773
0.10	0.828776	2.733891	4.530151	6.21063	7.77728
0.09	0.845493	2.759305	4.575277	6.28624	7.88714
0.08	0.862316	2.785099	4.621329	6.36482	8.00897
0.07	0.879237	2.811212	4.667984	6.44473	8.13579
0.06	0.896251	2.837600	4.715031	6.52505	8.26355
0.05	0.913352	2.864224	4.762333	6.60532	8.39048
0.04	0.930535	2.891056	4.809790	6.68528	8.51592
0.03	0.947796	2.918069	4.857332	6.76480	8.63963
0.02	0.965129	2.945243	4.904906	6.84378	8.76153
0.01	0.982531	2.972558	4.952472	6.92219	8.88164
0.00	1.000000	3.000000	5.000000	7.00000	9.00000
	$\begin{bmatrix} (-5)4 \\ 4 \end{bmatrix}$	$\begin{bmatrix} (-4)2 \\ 5 \end{bmatrix}$	$\begin{bmatrix} (-4)8 \\ 6 \end{bmatrix}$	$\begin{bmatrix} (-3)2 \\ 6 \end{bmatrix}$	$\begin{bmatrix} (-3)4 \\ 7 \end{bmatrix}$

*See page II.

EIGENVALUES—PROLATE AND OBLATE

Table 21.1

OBLATE

	$\lambda_{mn}(-ic) - m(m+1)$ *				
	$\lambda_{1n}(-ic) - 2$ *				
$c^2 \backslash n$	1	2	3	4	5
0	0.000000	4.000000	10.000000	18.000000	28.000000
1	-0.204695	3.567527	9.534818	17.520683	27.513713
2	-0.419293	3.127202	9.073104	17.043817	27.029223
3	-0.644596	2.678958	8.615640	16.569461	26.546548
4	-0.881446	2.222747	8.163245	16.097655	26.065706
5	-1.130712	1.758534	7.716768	15.628426	25.586715
6	-1.393280	1.286300	7.277072	15.161786	25.109592
7	-1.670028	0.806045	6.845015	14.697727	24.634357
8	-1.961809	+0.317782	6.421425	14.236229	24.161031
9	-2.269420	-0.178458	6.007074	13.777252	23.689634
10	-2.593577	-0.682630	5.602649	13.320743	23.220190
11	-2.934882	-1.194673	5.208724	12.866634	22.752726
12	-3.293803	-1.714511	4.825732	12.414840	22.287271
13	-3.670646	-2.242055	4.453947	11.965266	21.823856
14	-4.065548	-2.777205	4.093464	11.517803	21.362516
15	-4.478470	-3.319848	3.744202	11.072331	20.903290
16	-4.909200	-3.869861	3.405903	10.628718	20.446222
	$\left[\begin{smallmatrix} (-3)2 \\ 5 \end{smallmatrix} \right]$	$\left[\begin{smallmatrix} (-3)1 \\ 5 \end{smallmatrix} \right]$	$\left[\begin{smallmatrix} (-3)1 \\ 5 \end{smallmatrix} \right]$	$\left[\begin{smallmatrix} (-4)3 \\ 5 \end{smallmatrix} \right]$	$\left[\begin{smallmatrix} (-4)3 \\ 4 \end{smallmatrix} \right]$
	$c^{-1} \backslash n$				
	1	2	3	4	5
0.25	-0.306825	-0.241866	0.21286	0.66429	1.2778
0.24	-0.318148	-0.266693	0.17062	0.57759	1.1420
0.23	-0.330984	-0.291340	0.13125	0.49460	1.0120
0.22	-0.345469	-0.315894	0.09476	0.41533	0.8879
0.21	-0.361702	-0.340450	0.06107	0.33974	0.7697
0.20	-0.379735	-0.365113	0.03001	0.26779	0.6575
0.19	-0.399564	-0.389998	+0.00127	0.19942	0.5515
0.18	-0.421125	-0.415222	-0.02563	0.13449	0.4520
0.17	-0.444308	-0.440907	-0.05142	0.07282	0.3591
0.16	-0.468974	-0.467166	-0.07710	+0.01411	0.2735
0.15	-0.494976	-0.494104	-0.10406	-0.04205	0.1958
0.14	-0.522180	-0.521805	-0.13412	-0.09625	0.1271
0.13	-0.550474	-0.550335	-0.16924	-0.14929	0.0680
0.12	-0.579775	-0.579732	-0.21076	-0.20210	+0.0183
0.11	-0.610027	-0.610016	-0.25868	-0.25572	-0.0250
0.10	-0.641193	-0.641191	-0.31185	-0.31111	-0.0685
0.09	-0.673251	-0.673251	-0.36901	-0.36888	-0.1219
0.08	-0.706186	-0.706186	-0.42934	-0.42932	-0.1907
0.07	-0.739985	-0.739985	-0.49242	-0.49242	-0.2714
0.06	-0.774638	-0.774638	-0.55807	-0.55807	-0.3598
0.05	-0.810135	-0.810135	-0.62616	-0.62616	-0.4542
0.04	-0.846468	-0.846468	-0.69657	-0.69657	-0.5540
0.03	-0.883628	-0.883628	-0.76923	-0.76923	-0.6588
0.02	-0.921608	-0.921608	-0.84406	-0.84406	-0.7682
0.01	-0.960401	-0.960401	-0.92100	-0.92100	-0.8820
0.00	-1.000000	-1.000000	-1.00000	-1.00000	-1.0000
	$\left[\begin{smallmatrix} (-4)2 \\ 5 \end{smallmatrix} \right]$	$\left[\begin{smallmatrix} (-4)1 \\ 5 \end{smallmatrix} \right]$	$\left[\begin{smallmatrix} (-4)8 \\ 6 \end{smallmatrix} \right]$	$\left[\begin{smallmatrix} (-4)5 \\ 5 \end{smallmatrix} \right]$	$\left[\begin{smallmatrix} (-3)2 \\ 7 \end{smallmatrix} \right]$

*See page II.

Table 21.1

EIGENVALUES—PROLATE AND OBLATE

		PROLATE				
		$\lambda_{mn}(c) - m(m+1)$				*
		$\lambda_{2n}(c) - 6$				*
$c^2 \setminus n$	2	3	4	5	6	
0	0.000000	6.000000	14.000000	24.000000	36.000000	
1	0.140948	6.331101	14.402353	24.436145	36.454889	
2	0.278219	6.657791	14.804100	24.872744	36.910449	
3	0.412006	6.980147	15.205077	25.309731	37.366657	
4	0.542495	7.298250	15.605133	25.747043	37.823486	
5	0.669857	7.612179	16.004126	26.184612	38.280913	
6	0.794252	7.922016	16.401931	26.622373	38.738910	
7	0.915832	8.227840	16.798429	27.060261	39.197451	
8	1.034738	8.529734	17.193516	27.498208	39.656510	
9	1.151100	8.827778	17.587093	27.936151	40.116059	
10	1.265042	9.122052	17.979073	28.374023	40.576070	
11	1.376681	9.412636	18.369377	28.811761	41.036514	
12	1.486122	9.699610	18.757932	29.249302	41.497364	
13	1.593469	9.983052	19.144675	29.686584	41.958589	
14	1.698816	10.263039	19.529549	30.123544	42.420160	
15	1.802252	10.539650	19.912501	30.560125	42.882048	
16	1.903860	10.812958	20.293486	30.996267	43.344222	
	$\left[\begin{smallmatrix} (-4)5 \\ 4 \end{smallmatrix} \right]$	$\left[\begin{smallmatrix} (-4)6 \\ 4 \end{smallmatrix} \right]$	$\left[\begin{smallmatrix} (-4)2 \\ 4 \end{smallmatrix} \right]$	$\left[\begin{smallmatrix} (-5)6 \\ 4 \end{smallmatrix} \right]$	$\left[\begin{smallmatrix} (-5)8 \\ 4 \end{smallmatrix} \right]$	
$c^{-1} \setminus n$	2	3	4	5	6	
$c^{-1}[\lambda_{2n}(c) - 6]$ *						
0.25	0.475965	2.703239	5.073371	7.74906	10.8360	
0.24	0.489447	2.683149	4.994116	7.58138	10.5536	
0.23	0.503526	2.665356	4.919290	7.41971	10.2781	
0.22	0.518220	2.650003	4.849313	7.26479	10.0103	
0.21	0.533551	2.637236	4.784640	7.11743	9.7512	
0.20	0.549534	2.627196	4.725757	6.97858	9.5023	
0.19	0.566185	2.620017	4.673177	6.84931	9.2649	
0.18	0.583513	2.615819	4.627427	6.73081	9.0409	
0.17	0.601526	2.614701	4.589031	6.62442	8.8323	
0.16	0.620224	2.616735	4.558480	6.53155	8.6417	
0.15	0.639604	2.621954	4.536196	6.45371	8.4718	
0.14	0.659659	2.630349	4.522485	6.39236	8.3260	
0.13	0.680376	2.641862	4.517479	6.34878	8.2078	
0.12	0.701737	2.656384	4.521086	6.32389	8.1208	
0.11	0.723722	2.673764	4.532956	6.31794	8.0678	
0.10	0.746308	2.693817	4.552484	6.33030	8.0507	
0.09	0.769471	2.716339	4.578871	6.35935	8.0688	
0.08	0.793186	2.741120	4.611219	6.40263	8.1184	
0.07	0.817429	2.767960	4.648642	6.45738	8.1932	
0.06	0.842175	2.796673	4.690346	6.52096	8.2864	
0.05	0.867402	2.827089	4.735658	6.59127	8.3919	
0.04	0.893087	2.859059	4.784022	6.66670	8.5057	
0.03	0.919209	2.892449	4.834980	6.74607	8.6249	
0.02	0.945747	2.927138	4.888160	6.82849	8.7477	
0.01	0.972684	2.963019	4.943252	6.91330	8.8730	
0.00	1.000000	3.000000	5.000000	7.00000	9.0000	
	$\left[\begin{smallmatrix} (-5)9 \\ 4 \end{smallmatrix} \right]$	$\left[\begin{smallmatrix} (-4)4 \\ 5 \end{smallmatrix} \right]$	$\left[\begin{smallmatrix} (-3)1 \\ 6 \end{smallmatrix} \right]$	$\left[\begin{smallmatrix} (-3)2 \\ 6 \end{smallmatrix} \right]$	$\left[\begin{smallmatrix} (-3)4 \\ 5 \end{smallmatrix} \right]$	

*See page 11.

EIGENVALUES—PROLATE AND OBLATE

Table 21.1

OBLATE					
$\lambda_{mn}(-ic) - m(m+1)$ *					
$\lambda_{2n}(-ic) - 6$ *					
$c^2 \backslash n$	2	3	4	5	6
0	0.000000	6.000000	14.000000	24.000000	36.000000
1	-0.144837	5.664409	13.597220	23.564371	35.545806
2	-0.293786	5.324253	13.194206	23.129322	35.092330
3	-0.447086	4.979458	12.791168	22.694912	34.639597
4	-0.604989	4.629951	12.388328	22.261201	34.187627
5	-0.767764	4.275662	11.985928	21.828245	33.736444
6	-0.935698	3.916525	11.584224	21.396098	33.286069
7	-1.109090	3.552475	11.183489	20.964812	32.836522
8	-1.288259	3.183450	10.784014	20.534436	32.387826
9	-1.473539	2.809393	10.386106	20.105013	31.940000
10	-1.665278	2.430250	9.990084	19.676587	31.493066
11	-1.863838	2.045970	9.596286	19.249195	31.047043
12	-2.069595	1.656508	9.205059	18.822869	30.601952
13	-2.282933	1.261822	8.816762	18.397640	30.157814
14	-2.504245	0.861875	8.431761	17.973532	29.714648
15	-2.733927	0.456635	8.050424	17.550565	29.272476
16	-2.972375	0.046076	7.673121	17.128753	28.831317
	$\begin{bmatrix} (-3)1 \\ 4 \end{bmatrix}$	$\begin{bmatrix} (-4)7 \\ 4 \end{bmatrix}$	$\begin{bmatrix} (-4)5 \\ 4 \end{bmatrix}$	$\begin{bmatrix} (-4)1 \\ 4 \end{bmatrix}$	$\begin{bmatrix} (-4)1 \\ 4 \end{bmatrix}$
$c^{-2}[\lambda_{2n}(-ic) - 6]$ *					
$c^{-1} \backslash n$	2	3	4	5	6
0.25	-0.185773	+0.002879	0.47957	1.07054	1.8019
0.24	-0.190754	-0.030028	0.41280	0.95365	1.6261
0.23	-0.196680	-0.062228	0.34933	0.84167	1.4577
0.22	-0.203790	-0.093813	0.28933	0.73461	1.2965
0.21	-0.212386	-0.124893	0.23297	0.63251	1.1428
0.20	-0.222841	-0.155607	0.18049	0.53537	0.9964
0.19	-0.235596	-0.186120	0.13215	0.44322	0.8574
0.18	-0.251126	-0.216631	0.08816	0.35607	0.7260
0.17	-0.269873	-0.247375	0.04864	0.27389	0.6022
0.16	-0.292149	-0.278624	+0.01342	0.19662	0.4863
0.15	-0.318047	-0.310677	-0.01813	0.12409	0.3785
0.14	-0.347414	-0.343847	-0.04727	+0.05600	0.2795
0.13	-0.379928	-0.378432	-0.07609	-0.00822	0.1901
0.12	-0.415213	-0.414688	-0.10778	-0.06954	0.1120
0.11	-0.452947	-0.452800	-0.14643	-0.12937	+0.0470
0.10	-0.492902	-0.492871	-0.19508	-0.18959	-0.0051
0.09	-0.534942	-0.534937	-0.25333	-0.25217	-0.0517
0.08	-0.578991	-0.578991	-0.31876	-0.31861	-0.1076
0.07	-0.625006	-0.625006	-0.38955	-0.38955	-0.1844
0.06	-0.672956	-0.672956	-0.46494	-0.46494	-0.2768
0.05	-0.722813	-0.722813	-0.54456	-0.54456	-0.3791
0.04	-0.774556	-0.774556	-0.62821	-0.62821	-0.4895
0.03	-0.828164	-0.828164	-0.71571	-0.71571	-0.6073
0.02	-0.883618	-0.883618	-0.80691	-0.80691	-0.7319
0.01	-0.940902	-0.940902	-0.90171	-0.90171	-0.8629
0.00	-1.000000	-1.000000	-1.00000	-1.00000	-1.0000
	$\begin{bmatrix} (-4)5 \\ 6 \end{bmatrix}$	$\begin{bmatrix} (-4)2 \\ 5 \end{bmatrix}$	$\begin{bmatrix} (-3)1 \\ 8 \end{bmatrix}$	$\begin{bmatrix} (-4)6 \\ 6 \end{bmatrix}$	$\begin{bmatrix} (-3)3 \\ 8 \end{bmatrix}$

*See page II.

Table 21.2 ANGULAR FUNCTIONS—PROLATE AND OBLATE
PROLATE

		$S_{mn}(c, \cos \theta)$										
m	n	$c \setminus \theta$	0°	10°	20°	30°	40°	50°	60°	70°	80°	90°
0	0	1	0.8481	0.8525	0.8651	0.8847	0.9091	0.9354	0.9606	0.9815	0.9952	1.000
		2	0.5315	0.5431	0.5772	0.6320	0.7032	0.7842	0.8654	0.9355	0.9831	1.000
		3	0.2675	0.2815	0.3242	0.3967	0.4980	0.6226	0.7571	0.8805	0.9682	1.000
		4	0.1194	0.1312	0.1689	0.2379	0.3442	0.4885	0.6589	0.8271	0.9530	1.000
		5	0.0502	0.0585	0.0861	0.1419	0.2380	0.3839	0.5742	0.7776	0.9383	1.000
0	1	1	0.9046	0.8936	0.8602	0.8035	0.7225	0.6169	0.4878	0.3381	0.1731	0
		2	0.6681	0.6665	0.6598	0.6429	0.6081	0.5472	0.4540	0.3270	0.1717	0
		3	0.4034	0.4099	0.4273	0.4489	0.4630	0.4543	0.4068	0.3110	0.1695	0
		4	0.2042	0.2138	0.2415	0.2833	0.3294	0.3618	0.3566	0.2929	0.1669	0
		5	0.0916	0.1001	0.1262	0.1703	0.2279	0.2840	0.3104	0.2752	0.1643	0
0	2	1	1.022	0.9795	0.8553	0.6621	0.4198	0.1556	-0.0988	-0.3105	-0.4509	-0.5000
		2	1.064	1.030	0.9271	0.7579	0.5296	0.2602	-0.0192	-0.2668	-0.4385	-0.5000
		3	1.041	1.023	0.9640	0.8497	0.6660	0.4104	+0.1061	-0.1938	-0.4171	-0.5000
		4	0.8730	0.8768	0.8787	0.8513	0.7549	0.5553	0.2512	-0.0998	-0.3879	-0.5000
		5	0.6018	0.6233	0.6792	0.7407	0.7537	0.6494	0.3844	+0.0008	-0.3542	-0.5000
0	3	1	0.9892	0.9042	0.6692	0.3400	-0.0045	-0.2816	-0.4259	-0.4085	-0.2467	0
		2	0.9590	0.8864	0.6816	0.3840	+0.0560	-0.2261	-0.3907	-0.3949	-0.2447	0
		3	0.9090	0.8546	0.6957	0.4485	0.1501	-0.1364	-0.3319	-0.3714	-0.2412	0
		4	0.8197	0.7877	0.6868	0.5087	0.2591	-0.0215	-0.2514	-0.3376	-0.2361	0
		5	0.6650	0.6560	0.6183	0.5245	0.3482	+0.0971	-0.1575	-0.2952	-0.2293	0
1	1	1	0	0.1578	0.3134	0.4643	0.6067	0.7355	0.8450	0.9290	0.9819	1.000
		2	0	0.1194	0.2437	0.3757	0.5149	0.6562	0.7892	0.9000	0.9740	1.000
		3	0	0.0776	0.1654	0.2724	0.4030	0.5546	0.7144	0.8597	0.9627	1.000
		4	0	0.0449	0.1018	0.1832	0.2994	0.4537	0.6353	0.8150	0.9497	1.000
		5	0	0.0239	0.0588	0.1179	0.2162	0.3650	0.5602	0.7698	0.9361	1.000
1	2	1	0	0.4788	0.9054	1.232	1.417	1.435	1.276	0.9562	0.5119	0
		2	0	0.3896	0.7509	1.052	1.253	1.316	1.212	0.9335	0.5088	0
		3	0	0.2780	0.5538	0.8148	1.030	1.149	1.118	0.8992	0.5039	0
		4	0	0.1762	0.3683	0.5813	0.7968	0.9643	1.008	0.8575	0.4979	0
		5	0	0.1011	0.2254	0.3896	0.5906	0.7879	0.8957	0.8127	0.4911	0
1	3	1	0	0.9928	1.745	2.075	1.903	1.280	0.3775	-0.5521	-1.244	-1.500
		2	0	0.9559	1.710	2.092	1.998	1.432	0.5298	-0.4541	-1.214	-1.500
		3	0	0.8745	1.611	2.063	2.097	1.640	0.7606	-0.2972	-1.174	-1.500
		4	0	0.7393	1.418	1.934	2.128	1.841	1.032	-0.0951	-1.097	-1.500
		5	0	0.5662	1.146	1.691	2.047	1.975	1.299	+0.1319	-1.017	-1.500
2	2	1	0	0.0844	0.3295	0.7111	1.189	1.710	2.211	2.627	2.903	3.000
		2	0	0.0690	0.2744	0.6092	1.054	1.572	2.101	2.566	2.886	3.000
		3	0	0.0500	0.2051	0.4773	0.8738	1.380	1.944	2.475	2.859	3.000
		4	0	0.0328	0.1405	0.3487	0.6876	1.171	1.764	2.367	2.827	3.000
		5	0	0.0198	0.0898	0.2414	0.5212	0.9701	1.580	2.251	2.791	3.000
2	3	1	0	0.4222	1.570	3.116	4.596	5.530	5.548	4.501	2.522	0
		2	0	0.3597	1.358	2.755	4.175	5.170	5.327	4.417	2.510	0
		3	0	0.2765	1.070	2.255	3.576	4.641	4.994	4.286	2.491	0
		4	0	0.1934	0.7758	1.723	2.909	4.025	4.588	4.122	2.466	0
		5	0	0.1244	0.5226	1.243	2.269	3.395	4.150	3.936	2.437	0

From C. Flammer, Spheroidal wave functions. Stanford Univ. Press, Stanford, Calif., 1957 (with permission).

ANGULAR FUNCTIONS—PROLATE AND OBLATE

Table 21.2

OBLATE

$$S_{mn}(-ic, \eta)$$

<i>m</i>	<i>n</i>	<i>c</i> \η	0	0.1	0.2	0.3	0.4	0.5	0.6	0.7	0.8	0.9	1.0
0	0	1	1.000	1.002	1.007	1.016	1.028	1.044	1.064	1.088	1.115	1.147	1.183
		2	1.000	1.008	1.032	1.073	1.132	1.210	1.310	1.434	1.585	1.767	1.986
		3	1.000	1.022	1.089	1.205	1.377	1.617	1.940	2.366	2.923	3.648	4.589
		4	1.000	1.047	1.191	1.449	1.854	2.452	3.319	4.557	6.323	8.837	12.42
		5	1.000	1.083	1.341	1.835	2.648	3.952	6.000	9.211	14.23	22.11	34.48
0	1	1	0	0.1001	0.2009	0.3027	0.4065	0.5128	0.6222	0.7353	0.8530	0.9760	1.105
		2	0	0.1004	0.2034	0.3114	0.4274	0.5542	0.6952	0.8539	1.035	1.243	1.484
		3	0	0.1011	0.2079	0.3273	0.4664	0.6338	0.8398	1.098	1.425	1.842	2.378
		4	0	0.1016	0.2150	0.3526	0.5298	0.7681	1.096	1.552	2.195	3.105	4.396
		5	0	0.1032	0.2252	0.3884	0.6252	0.9804	1.525	2.369	3.684	5.741	8.970
0	2	1	-0.5000	-0.4863	-0.4450	-0.3757	-0.2779	-0.1507	+0.0070	0.1965	0.4197	0.6784	0.9749
		2	-0.5000	-0.4897	-0.4585	-0.4052	-0.3277	-0.2231	-0.0872	+0.0849	0.2999	0.5660	0.8930
		3	-0.5000	-0.4943	-0.4766	-0.4448	-0.3952	-0.3223	-0.2183	-0.0721	+0.1311	0.3845	0.7958
		4	-0.5000	-0.4994	-0.4966	-0.4891	-0.4716	-0.4356	-0.3681	-0.2485	-0.0458	0.2868	0.8201
		5	-0.5000	-0.5061	-0.5234	-0.5495	-0.5780	-0.5977	-0.5869	-0.5067	-0.2880	0.1892	1.132
0	3	1	0	-0.1477	-0.2810	-0.3855	-0.4466	-0.4491	-0.3768	-0.2130	+0.0600	0.4613	1.011
		2	0	-0.1480	-0.2839	-0.3947	-0.4668	-0.4839	-0.4275	-0.2757	-0.0015	0.4274	1.051
		3	0	-0.1486	-0.2885	-0.4097	-0.4998	-0.5421	-0.5140	-0.3841	-0.1091	0.3711	1.138
		4	0	-0.1495	-0.2949	-0.4306	-0.5415	-0.6270	-0.6432	-0.5540	-0.2765	0.2912	1.327
		5	0	-0.1504	-0.3033	-0.4589	-0.6123	-0.7489	-0.8356	-0.8080	-0.5447	0.1715	1.723
1	1	1	1.000	0.9961	0.9838	0.9628	0.9316	0.8884	0.8299	0.7506	0.6402	0.4731	0
		2	1.000	0.9994	0.9973	0.9923	0.9827	0.9652	0.9340	0.8802	0.7864	0.6118	0
		3	1.000	1.006	1.025	1.055	1.093	1.135	1.172	1.188	1.149	0.9724	0
		4	1.000	1.020	1.079	1.178	1.319	1.498	1.708	1.920	2.067	1.950	0
		5	1.000	1.041	1.174	1.406	1.776	2.242	2.878	3.642	4.400	4.651	0
1	2	1	0	0.2987	0.5897	0.8643	1.113	1.322	1.478	1.554	1.508	1.247	0
		2	0	0.2985	0.5950	0.8815	1.153	1.398	1.600	1.730	1.734	1.487	0
		3	0	0.3005	0.6043	0.9140	1.228	1.541	1.837	2.082	2.200	2.000	0
		4	0	0.3022	0.6213	0.9640	1.349	1.780	2.250	2.723	3.092	3.033	0
		5	0	0.2990	0.6400	1.040	1.537	2.165	2.947	3.868	4.786	5.138	0
1	3	1	-1.500	-1.421	-1.189	-0.8136	-0.3165	0.2710	0.9015	1.501	1.946	1.988	0
		2	-1.500	-1.431	-1.228	-0.8941	-0.4427	+0.1060	0.7174	1.329	1.826	1.951	0
		3	-1.500	-1.447	-1.289	-1.024	-0.6502	-0.1738	+0.3916	1.006	1.572	1.834	0
		4	-1.500	-1.467	-1.364	-1.184	-0.9148	-0.5415	-0.0538	0.5403	1.177	1.619	0
		5	-1.500	-1.486	-1.442	-1.353	-1.198	-0.9435	-0.5506	0.0161	0.7471	1.439	0
2	2	1	3.000	2.972	2.889	2.748	2.549	2.291	1.970	1.585	1.131	0.6041	0
		2	3.000	2.979	2.915	2.805	2.644	2.425	2.138	1.770	1.305	0.7234	0
		3	3.000	2.992	2.965	2.915	2.830	2.693	2.481	2.161	1.687	0.9944	0
		4	3.000	3.013	3.052	3.111	3.170	3.200	3.157	2.966	2.512	1.615	0
		5	3.000	3.052	3.211	3.469	3.813	4.202	4.564	4.746	4.460	3.188	0
2	3	1	0	1.486	2.886	4.115	5.086	5.704	5.877	5.503	4.477	2.683	0
		2	0	1.488	2.906	4.180	5.226	5.954	6.251	5.982	4.990	3.077	0
		3	0	1.494	2.943	4.295	5.482	6.413	6.951	6.904	6.008	3.879	0
		4	0	1.498	2.996	4.475	5.891	7.166	8.132	8.515	7.857	5.408	0
		5	0	1.509	3.073	4.738	6.515	8.347	10.07	11.28	11.21	8.354	0

Table 21.3

PROLATE RADIAL FUNCTIONS—FIRST AND SECOND KINDS

m	n	$c \setminus \xi$	$R_{mn}^{(1)}(c, \xi)$				$P_{mn}^{(2)}(c, \xi)$			
			1.005	1.020	1.044	1.077	1.005	1.020	1.044	1.077
0	0	1	(-1)9.468	(-1)9.419	(-1)9.339	(-1)9.228	(0)-2.838	(0)-2.096	(0)-1.666	(0)-1.356
		2	(-1)8.257	(-1)8.077	(-1)7.789	(-1)7.392	(0)-1.244	(-1)-8.020	(-1)-5.341	(-1)-3.333
		3	(-1)7.026	(-1)6.662	(-1)6.091	(-1)5.330	(-1)-7.104	(-1)-3.422	(-1)-1.281	(-2)3.51
		4	(-1)6.054	(-1)5.471	(-1)4.585	(-1)3.463	(-1)-4.508	(-1)-1.287	(-2)6.61	(-1)1.952
		5	(-1)5.313	(-1)4.488	(-1)3.287	(-1)1.869	(-1)-3.052	(-2)-1.02	(-1)1.537	(-1)2.291
0	1	1	(-1)3.153	(-1)3.190	(-1)3.249	(-1)3.328	(0)-6.912	(0)-4.801	(0)-3.669	(0)-2.920
		2	(-1)5.289	(-1)5.298	(-1)5.308	(-1)5.311	(0)-2.189	(0)-1.540	(0)-1.177	(-1)-9.216
		3	(-1)6.064	(-1)5.960	(-1)5.786	(-1)5.529	(0)-1.133	(-1)-7.365	(-1)-4.987	(-1)-3.207
		4	(-1)5.892	(-1)5.612	(-1)5.162	(-1)4.542	(-1)-6.741	(-1)-3.528	(-1)-1.534	(-3)-4.9
		5	(-1)5.381	(-1)4.888	(-1)4.125	(-1)3.137	(-1)-4.293	(-1)-1.390	(-2)3.87	(-1)1.594
0	2	1	(-2)4.470	(-2)4.655	(-2)4.954	(-2)5.373	(1)-3.593	(1)-2.185	(1)-1.484	(1)-1.056
		2	(-1)1.696	(-1)1.749	(-1)1.833	(-1)1.947	(0)-5.241	(0)-3.358	(0)-2.403	(-1)-1.807
		3	(-1)3.295	(-1)3.346	(-1)3.421	(-1)3.509	(0)-2.031	(0)-1.364	(0)-1.007	(-1)-7.694
		4	(-1)4.507	(-1)4.477	(-1)4.413	(-1)4.293	(0)-1.095	(-1)-7.053	(-1)-4.783	(-1)-3.115
		5	(-1)4.952	(-1)4.763	(-1)4.444	(-1)3.976	(-1)-7.388	(-1)-4.417	(-1)-2.630	(-1)-1.340
0	3	1	(-3)3.912	(-3)4.249	(-3)4.814	(-3)5.638	(-2)-3.288	(2)-1.659	(2)-1.082	(1)-6.916
		2	(-2)3.085	(-2)3.317	(-2)3.700	(-2)4.249	(-1)-2.194	(1)-1.223	(0)-7.705	(0)-5.123
		3	(-2)9.956	(-1)1.054	(-1)1.147	(-1)1.275	(0)-5.020	(0)-2.966	(0)-1.985	(0)-1.408
		4	(-1)2.107	(-1)2.183	(-1)2.298	(-1)2.443	(0)-2.043	(0)-1.293	(-1)-9.141	(-1)-6.749
		5	(-1)3.298	(-1)3.329	(-1)3.360	(-1)3.362	(0)-1.149	(-1)-7.422	(-1)-5.182	(-1)-3.612
1	1	1	(-2)3.270	(-2)6.544	(-2)9.716	(-1)1.287	(1)-1.506	(0)-7.294	(0)-4.734	(0)-3.432
		2	(-2)6.187	(-1)1.227	(-1)1.793	(-1)2.323	(0)-4.079	(0)-2.077	(0)-1.417	(0)-1.071
		3	(-2)8.596	(-1)1.677	(-1)2.386	(-1)2.973	(0)-2.019	(0)-1.075	(-1)-7.453	(-1)-5.480
		4	(-1)1.053	(-1)2.007	(-1)2.744	(-1)3.221	(0)-1.273	(-1)-6.911	(-1)-4.585	(-1)-2.924
		5	(-1)1.211	(-1)2.235	(-1)2.894	(-1)3.118	(-1)-9.101	(-1)-4.885	(-1)-2.874	(-1)-1.248
1	2	1	(-3)6.503	(-2)1.322	(-2)2.012	(-2)2.754	(1)-7.295	(1)-3.269	(1)-1.939	(1)-1.275
		2	(-2)2.378	(-2)4.802	(-2)7.227	(-2)9.738	(1)-1.014	(0)-4.717	(0)-2.932	(0)-2.038
		3	(-2)4.658	(-2)9.296	(-1)1.372	(-1)1.798	(0)-3.552	(0)-1.751	(0)-1.156	(-1)-8.473
		4	(-2)6.975	(-1)1.367	(-1)1.960	(-1)2.460	(0)-1.842	(-1)-9.597	(-1)-6.533	(-1)-4.718
		5	(-2)9.035	(-1)1.739	(-1)2.376	(-1)2.803	(0)-1.778	(-1)-6.362	(-1)-4.170	(-1)-2.651
1	3	1	(-4)7.586	(-3)1.577	(-3)2.483	(-3)3.556	(2)-6.014	(2)-2.491	(2)-1.354	(1)-8.127
		2	(-3)5.725	(-2)1.183	(-2)1.845	(-2)2.607	(1)-4.027	(1)-1.707	(0)-9.553	(0)-5.934
		3	(-2)1.737	(-2)3.553	(-2)5.453	(-2)7.529	(0)-9.025	(0)-3.994	(0)-2.354	(0)-1.552
		4	(-2)3.516	(-2)7.089	(-1)1.063	(-1)1.418	(0)-3.449	(0)-1.629	(0)-1.032	(-1)-7.288
		5	(-2)5.604	(-1)1.108	(-1)1.608	(-1)2.048	(0)-1.692	(-1)-8.600	(-1)-5.214	(-1)-3.006
2	2	1	(-4)6.612	(-3)2.659	(-3)5.898	(-2)1.044	(2)-3.750	(1)-9.112	(1)-3.973	(1)-2.156
		2	(-3)2.566	(-2)1.025	(-2)2.249	(-2)3.920	(1)-4.852	(1)-1.203	(0)-5.417	(0)-3.077
		3	(-3)5.520	(-2)2.181	(-2)4.698	(-2)7.974	(1)-1.515	(0)-3.889	(0)-1.852	(0)-1.126
		4	(-3)9.302	(-2)3.616	(-2)7.587	(-1)1.239	(0)-6.821	(0)-1.843	(-1)-9.431	(-1)-6.132
		5	(-2)1.372	(-2)5.223	(-1)1.058	(-1)1.639	(0)-3.755	(0)-1.081	(-1)-5.907	(-1)-3.910
2	3	1	(-5)9.415	(-4)3.845	(-4)8.736	(-3)1.596	(3)-2.609	(2)-6.096	(2)-2.517	(2)-1.279
		2	(-4)7.128	(-3)2.896	(-3)6.525	(-2)1.178	(2)-1.728	(1)-4.095	(1)-1.727	(0)-9.031
		3	(-3)2.208	(-3)8.889	(-2)1.974	(-2)3.492	(1)-3.745	(0)-9.098	(0)-3.994	(0)-2.208
		4	(-3)4.683	(-2)1.862	(-2)4.048	(-2)6.946	(1)-1.334	(0)-3.370	(0)-1.573	(-1)-9.397
		5	(-3)8.060	(-2)3.150	(-2)6.657	(-1)1.096	(0)-6.274	(0)-1.671	(-1)-8.409	(-1)-5.379

From C. Flammer, Spheroidal wave functions. Stanford Univ. Press, Stanford, Calif., 1957 (with permission).

OBLATE RADIAL FUNCTIONS—FIRST AND SECOND KINDS Table 21.4

m	n	c\xi	$R_{mn}^{(1)}(-ic, i\xi)$		$R_{mn}^{(2)}(-ic, i\xi)$	
			0	0.75	0	0.75
0	0	0.2	(-1) 9.9557	(-1) 9.9183	(0) -7.7864	(0) -4.5290
		0.5	(-1) 9.7265	(-1) 9.4976	(0) -2.9707	(0) -1.5906
		0.8	(-1) 9.3168	(-1) 8.7520	(0) -1.7002	(-1) -7.5527
		1.0	(-1) 8.9565	(-1) 8.1032	(0) -1.2524	(-1) -4.4277
		1.5	(-1) 7.8320	(-1) 6.1209	(-1) -6.2189	(-2) +1.2204
		2.0	(-1) 6.5571	(-1) 3.9526	(-1) -3.0356	(-1) 2.2634
		2.5	(-1) 5.3430	(-1) 1.9680	(-1) -1.3758	(-1) 3.0225
0	1	0.2	0	(-2) 4.9808	(1) -7.5120	(1) -2.3239
		0.5	0	(-1) 1.2202	(1) -1.2120	(0) -4.0338
		0.8	0	(-1) 1.8802	(0) -4.8077	(0) -1.7744
		1.0	0	(-1) 2.2696	(0) -3.1202	(0) -1.2314
		1.5	0	(-1) 3.0132	(0) -1.4537	(-1) -6.3156
		2.0	0	(-1) 3.3765	(-1) -8.7035	(-1) -3.4641
		2.5	0	(-1) 3.3530	(-1) -6.0006	(-1) -1.5694
0	2	0.2	(-4) 8.8992	(-3) 2.3840	(3) -2.2106	(2) -3.4260
		0.5	(-3) 5.5964	(-2) 1.4744	(2) -1.4205	(1) -2.2700
		0.8	(-2) 1.4489	(-2) 3.6993	(1) -3.5130	(0) -5.9376
		1.0	(-2) 2.2868	(-2) 5.6728	(1) -1.8068	(0) -3.2496
		1.5	(-2) 5.3150	(-1) 1.1932	(0) -5.5629	(0) -1.2084
		2.0	(-2) 9.7914	(-1) 1.9147	(0) -2.5149	(-1) -6.5653
		2.5	(-1) 1.5649	(-1) 2.5730	(0) -1.4263	(-1) -3.9702
1	1	0.2	(-2) 6.6454	(-2) 8.2880	(1) -5.9560	(1) -2.1507
		0.5	(-1) 1.6336	(-1) 2.0133	(1) -1.0060	(0) -3.8583
		0.8	(-1) 2.5333	(-1) 3.0524	(0) -4.2765	(0) -1.7483
		1.0	(-1) 3.0762	(-1) 3.6283	(0) -2.9165	(0) -1.2196
		1.5	(-1) 4.1708	(-1) 4.5492	(0) -1.4980	(-1) -5.8081
		2.0	(-1) 4.8229	(-1) 4.6553	(-1) -9.1106	(-1) -2.3210
		2.5	(-1) 5.0170	(-1) 4.0221	(-1) -5.7028	(-3) +3.168
1	2	0.2	0	(-3) 2.4923	(3) -1.8781	(2) -3.2287
		0.5	0	(-2) 1.5314	(2) -1.2123	(1) -2.1474
		0.8	0	(-2) 3.7974	(1) -3.0070	(0) -5.6543
		1.0	0	(-2) 5.7617	(1) -1.5622	(0) -3.1109
		1.5	0	(-1) 1.1699	(0) -4.8667	(0) -1.1709
		2.0	0	(-1) 1.7976	(0) -2.1999	(-1) -6.4134
		2.5	0	(-1) 2.3200	(0) -1.2282	(-1) -3.9677
1	3	0.2	(-5) 1.5236	(-5) 7.2462	(4) -9.6745	(3) -8.1316
		0.5	(-4) 2.3850	(-3) 1.1206	(3) -2.4841	(2) -2.1259
		0.8	(-4) 9.7909	(-3) 4.4965	(2) -3.8151	(1) -3.3786
		1.0	(-3) 1.9166	(-3) 8.6200	(2) -1.5721	(1) -1.4390
		1.5	(-3) 6.5244	(-2) 2.7259	(1) -3.1742	(0) -3.2838
		2.0	(-2) 1.5669	(-2) 5.8920	(1) -1.0386	(0) -1.2924
		2.5	(-2) 3.1147	(-1) 1.0193	(0) -4.4705	(-1) -6.9734
2	2	0.2	(-3) 2.6602	(-3) 4.1496	(3) -1.1093	(2) -2.6888
		0.5	(-2) 1.6413	(-2) 2.5393	(1) -7.2682	(1) -1.8121
		0.8	(-2) 4.1024	(-2) 6.2453	(1) -1.8724	(0) -4.9121
		1.0	(-2) 6.2694	(-2) 9.4031	(0) -9.9297	(0) -2.7508
		1.5	(-1) 1.3055	(-1) 1.8562	(0) -3.4267	(0) -1.0939
		2.0	(-1) 2.0801	(-1) 2.7317	(0) -1.7581	(-1) -6.0206
		2.5	(-1) 2.8190	(-1) 3.3111	(0) -1.0954	(-1) -3.3594

PROLATE JOINING FACTORS—FIRST KIND $k_{mn}^{(1)}(c)$ Table 21.5

c	$k_{00}^{(1)}$	$k_{01}^{(1)}$	$k_{02}^{(1)}$	$k_{11}^{(1)}$	$k_{12}^{(1)}$	$k_{13}^{(1)}$	$k_{22}^{(1)}$
1	(-1) 8.943	(-1) 9.422	(1) 4.637	(0) 2.770	(1) 4.319	(2) 7.919	(1) 4.234
2	(-1) 6.391	(0) 1.586	(1) 1.268	(0) 1.095	(0) 9.527	(2) 1.002	(0) 8.838
3	(-1) 3.742	(0) 1.829	(0) 6.352	(-1) 5.011	(0) 3.417	(1) 2.982	(0) 2.935
4	(-1) 1.909	(0) 1.795	(0) 3.867	(-1) 2.294	(0) 1.413	(1) 1.222	(0) 1.118
5	(-2) 8.97	(0) 1.665	(0) 2.401	(-1) 1.023	(-1) 6.067	(0) 5.725	(-1) 4.455

From C. Flammer, Spheroidal wave functions. Stanford Univ. Press, Stanford, Calif., 1957 (with permission).

22. Orthogonal Polynomials

URS W. HOCHSTRASSER¹

Contents

	Page
Mathematical Properties	773
22.1. Definition of Orthogonal Polynomials	773
22.2. Orthogonality Relations	774
22.3. Explicit Expressions	775
22.4. Special Values	777
22.5. Interrelations	777
22.6. Differential Equations	781
22.7. Recurrence Relations	782
22.8. Differential Relations	783
22.9. Generating Functions	783
22.10. Integral Representations	784
22.11. Rodrigues' Formula	785
22.12. Sum Formulas	785
22.13. Integrals Involving Orthogonal Polynomials	785
22.14. Inequalities	786
22.15. Limit Relations	787
22.16. Zeros	787
22.17. Orthogonal Polynomials of a Discrete Variable	788
Numerical Methods	788
22.18. Use and Extension of the Tables	788
22.19. Least Square Approximations	790
22.20. Economization of Series	791
References	792
Table 22.1. Coefficients for the Jacobi Polynomials $P_n^{(\alpha, \beta)}(x)$	793
$n=0(1)6$	
Table 22.2. Coefficients for the Ultraspherical Polynomials $C_n^{(\alpha)}(x)$ and for x^n in Terms of $C_m^{(\alpha)}(x)$	794
$n=0(1)6$	
Table 22.3. Coefficients for the Chebyshev Polynomials $T_n(x)$ and for x^n in Terms of $T_m(x)$	795
$n=0(1)12$	
Table 22.4. Values of the Chebyshev Polynomials $T_n(x)$	795
$n=0(1)12, x=.2(.2)1, 10D$	
Table 22.5. Coefficients for the Chebyshev Polynomials $U_n(x)$ and for x^n in Terms of $U_m(x)$	796
$n=0(1)12$	
Table 22.6. Values of the Chebyshev Polynomials $U_n(x)$	796
$n=0(1)12, x=.2(.2)1, 10D$	

¹ Guest Worker, National Bureau of Standards, from The American University. (Presently, Atomic Energy Commission, Switzerland.)

	Page
Table 22.7. Coefficients for the Chebyshev Polynomials $C_n(x)$ and for x^n in Terms of $C_m(x)$ $n=0(1)12$	797
Table 22.8. Coefficients for the Chebyshev Polynomials $S_n(x)$ and for x^n in Terms of $S_m(x)$ $n=0(1)12$	797
Table 22.9. Coefficients for the Legendre Polynomials $P_n(x)$ and for x^n in Terms of $P_m(x)$ $n=0(1)12$	798
Table 22.10. Coefficients for the Laguerre Polynomials $L_n(x)$ and for x^n in Terms of $L_m(x)$ $n=0(1)12$	799
Table 22.11. Values of the Laguerre Polynomials $L_n(x)$ $n=0(1)12, x=.5, 1, 3, 5, 10, \text{ Exact or 10D}$	800
Table 22.12. Coefficients for the Hermite Polynomials $H_n(x)$ and for x^n in Terms of $H_m(x)$ $n=0(1)12$	801
Table 22.13. Values of the Hermite Polynomials $H_n(x)$ $n=0(1)12, x=.5, 1, 3, 5, 10, \text{ Exact or 11S}$	802

22. Orthogonal Polynomials

Mathematical Properties

22.1. Definition of Orthogonal Polynomials

A system of polynomials $f_n(x)$, degree $[f_n(x)] = n$, is called orthogonal on the interval $a \leq x \leq b$, with respect to the weight function $w(x)$, if

22.1.1

$$\int_a^b w(x) f_n(x) f_m(x) dx = 0 \quad (n \neq m; n, m = 0, 1, 2, \dots)$$

The weight function $w(x)[w(x) \geq 0]$ determines the system $f_n(x)$ up to a constant factor in each polynomial. The specification of these factors is referred to as standardization. For suitably standardized orthogonal polynomials we set

22.1.2

$$\int_a^b w(x) f_n^2(x) dx = h_n, \quad f_n(x) = k_n x^n + k'_n x^{n-1} + \dots \quad (n = 0, 1, 2, \dots)$$

These polynomials satisfy a number of relationships of the same general form. The most important ones are:

Differential Equation

$$22.1.3 \quad g_2(x) f_n'' + g_1(x) f_n' + a_n f_n = 0$$

where $g_2(x)$, $g_1(x)$ are independent of n and a_n a constant depending only on n .

Recurrence Relation

$$22.1.4 \quad f_{n+1} = (a_n + x b_n) f_n - c_n f_{n-1}$$

where

22.1.5

$$b_n = \frac{k_{n+1}}{k_n}, \quad a_n = b_n \left(\frac{k'_{n+1}}{k_{n+1}} - \frac{k'_n}{k_n} \right), \quad c_n = \frac{k_{n+1} k_{n-1} h_n}{k_n^2 h_{n-1}}$$

Rodrigues' Formula

$$22.1.6 \quad f_n = \frac{1}{e_n w(x)} \frac{d^n}{dx^n} \{ w(x) [g(x)]^n \}$$

where $g(x)$ is a polynomial in x independent of n . The system $\left\{ \frac{df_n}{dx} \right\}$ consists again of orthogonal polynomials.

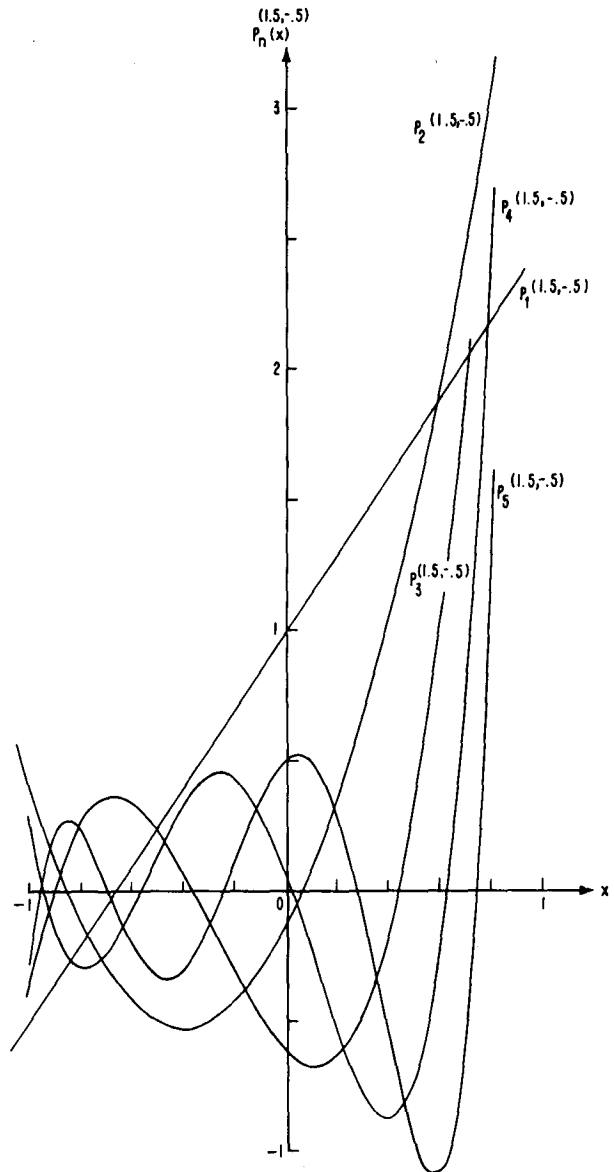

FIGURE 22.1. *Jacobi Polynomials* $P_n^{(\alpha, \beta)}(x)$, $\alpha = 1.5, \beta = -.5, n = 1(1)5$.

22.2. Orthogonality Relations

	$f_n(x)$	Name of Polynomial	a	b	$w(x)$	Standardization	h_n	Remarks
22.2.1	$P_n^{(\alpha, \beta)}(x)$	Jacobi	-1	1	$(1-x)^\alpha(1+x)^\beta$	$P_n^{(\alpha, \beta)}(1) = \binom{n+\alpha}{n}$	$\frac{2^{\alpha+\beta+1}}{2n+\alpha+\beta+1} \frac{\Gamma(n+\alpha+1)\Gamma(n+\beta+1)}{n!\Gamma(n+\alpha+\beta+1)}$	$\alpha > -1, \beta > -1$
22.2.2	$G_n(p, q, x)$	Jacobi	0	1	$(1-x)^{p-\alpha}x^{\alpha-1}$	$k_n=1$	$\frac{n!\Gamma(n+q)\Gamma(n+p)\Gamma(n+p-q+1)}{(2n+p)\Gamma^2(2n+p)}$	$p-q > -1, q > 0$
22.2.3	$C_n^{(\alpha)}(x)$	Ultraspherical (Gegenbauer)	-1	1	$(1-x^2)^{\alpha-\frac{1}{2}}$	$C_n^{(\alpha)}(1) = \binom{n+2\alpha-1}{n}$ ($\alpha \neq 0$)	$\frac{\pi 2^{1-2\alpha}\Gamma(n+2\alpha)}{n!(n+\alpha)[\Gamma(\alpha)]^2} \quad \alpha \neq 0$	$\alpha > -\frac{1}{2}$
						$C_n^{(0)}(1) = \frac{2}{n},$ $C_0^{(0)}(1) = 1$	$\frac{2\pi}{n^2} \quad \alpha = 0$	
22.2.4	$T_n(x)$	Chebyshev of the first kind	-1	1	$(1-x^2)^{-\frac{1}{2}}$	$T_n(1) = 1$	$\begin{cases} \frac{\pi}{2} & n \neq 0 \\ \pi & n = 0 \end{cases}$	
22.2.5	$U_n(x)$	Chebyshev of the second kind	-1	1	$(1-x^2)^{\frac{1}{2}}$	$U_n(1) = n+1$	$\frac{\pi}{2}$	8
22.2.6	$C_n(x)$	Chebyshev of the first kind	-2	2	$\left(1-\frac{x^2}{4}\right)^{-\frac{1}{2}}$	$C_n(2) = 2$	$\begin{cases} 4\pi & n \neq 0 \\ 8\pi & n = 0 \end{cases}$	
22.2.7	$S_n(x)$	Chebyshev of the second kind	-2	2	$\left(1-\frac{x^2}{4}\right)^{\frac{1}{2}}$	$S_n(2) = n+1$	π	
22.2.8	$T_n^*(x)$	Shifted Chebyshev of the first kind	0	1	$(x-x^2)^{-\frac{1}{2}}$	$T_n^*(1) = 1$	$\begin{cases} \frac{\pi}{2} & n \neq 0 \\ \pi & n = 0 \end{cases}$	
22.2.9	$U_n^*(x)$	Shifted Chebyshev of the second kind	0	1	$(x-x^2)^{\frac{1}{2}}$	$U_n^*(1) = n+1$	$\frac{\pi}{8} \quad *$	
22.2.10	$P_n(x)$	Legendre (Spherical)	-1	1	1	$P_n(1) = 1$	$\frac{2}{2n+1}$	
22.2.11	$P_n^*(x)$	Shifted Legendre	0	1	1		$\frac{1}{2n+1}$	

*See page 11.

22.2. Orthogonality Relations—Continued

22.2.12	$L_n^{(\alpha)}(x)$	Generalized Laguerre	0	∞	$e^{-x}x^\alpha$	$k_n = \frac{(-1)^n}{n!}$	$\frac{\Gamma(\alpha+n+1)}{n!}$	$\alpha > -1$
22.2.13	$L_n(x)$	Laguerre	0	∞	e^{-x}	$k_n = \frac{(-1)^n}{n!}$	1	
*	22.2.14	$H_n(x)$	Hermite	$-\infty$	∞	e^{-x^2}	$e_n = (-1)^n$	$\sqrt{\pi}2^n n!$
*	22.2.15	$He_n(x)$	Hermite	$-\infty$	∞	$e^{-\frac{x^2}{2}}$	$e_n = (-1)^n$	$\sqrt{2\pi}n!$

*See page II.

22.3. Explicit Expressions

$$f_n(x) = d_n \sum_{m=0}^N c_m g_m(x)$$

	$f_n(x)$	N	d_n	c_m	$g_m(x)$	k_n	Remarks
22.3.1	$P_n^{(\alpha, \beta)}(x)$	n	$\frac{1}{2^n}$	$\binom{n+\alpha}{m} \binom{n+\beta}{n-m}$	$(x-1)^{n-m}(x+1)^m$	$\frac{1}{2^n} \binom{2n+\alpha+\beta}{n}$	$\alpha > -1, \beta > -1$
22.3.2	$P_n^{(\alpha, \beta)}(x)$	n	$\frac{\Gamma(\alpha+n+1)}{n! \Gamma(\alpha+\beta+n+1)}$	$\binom{n}{m} \frac{\Gamma(\alpha+\beta+n+m+1)}{2^m \Gamma(\alpha+m+1)}$	$(x-1)^m$	$\frac{1}{2^n} \binom{2n+\alpha+\beta}{n}$	$\alpha > -1, \beta > -1$
22.3.3	$G_n(p, q, x)$	n	$\frac{\Gamma(q+n)}{\Gamma(p+2n)}$	$(-1)^m \binom{n}{m} \frac{\Gamma(p+2n-m)}{\Gamma(q+n-m)}$	x^{n-m}	1	$p-q > -1, q > 0$
22.3.4	$C_n^{(\alpha)}(x)$	$\left[\frac{n}{2} \right]$	$\frac{1}{\Gamma(\alpha)}$	$(-1)^m \frac{\Gamma(\alpha+n-m)}{m!(n-2m)!}$	$(2x)^{n-2m}$	$\frac{2^n}{n!} \frac{\Gamma(\alpha+n)}{\Gamma(\alpha)}$	$\alpha > -\frac{1}{2}, \alpha \neq 0$
22.3.5	$C_n^{(0)}(x)$	$\left[\frac{n}{2} \right]$	1	$(-1)^m \frac{(n-m-1)!}{m!(n-2m)!}$	$(2x)^{n-2m}$	$\frac{2^n}{n} \quad n \neq 0$	$n \neq 0, C_0^{(0)}(1) = 1$
22.3.6	$T_n(x)$	$\left[\frac{n}{2} \right]$	$\frac{n}{2}$	$(-1)^m \frac{(n-m-1)!}{m!(n-2m)!}$	$(2x)^{n-2m}$	2^{n-1}	
22.3.7	$U_n(x)$	$\left[\frac{n}{2} \right]$	1	$(-1)^m \frac{(n-m)!}{m!(n-2m)!}$	$(2x)^{n-2m}$	2^n	
22.3.8	$P_n(x)$	$\left[\frac{n}{2} \right]$	$\frac{1}{2^n}$	$(-1)^m \binom{n}{m} \binom{2n-2m}{n}$	x^{n-2m}	$\frac{(2n)!}{2^n (n!)^2}$	
22.3.9	$L_n^{(\alpha)}(x)$	n	1	$(-1)^m \binom{n+\alpha}{n-m} \frac{1}{m!}$	x^m	$\frac{(-1)^n}{n!}$	$\alpha > -1$
22.3.10	$H_n(x)$	$\left[\frac{n}{2} \right]$	$n!$	$(-1)^m \frac{1}{m!(n-2m)!}$	$(2x)^{n-2m}$	2^n	see 22.11
22.3.11	$He_n(x)$	$\left[\frac{n}{2} \right]$	$n!$	$(-1)^m \frac{1}{m! 2^m (n-2m)!}$	x^{n-2m}	1	

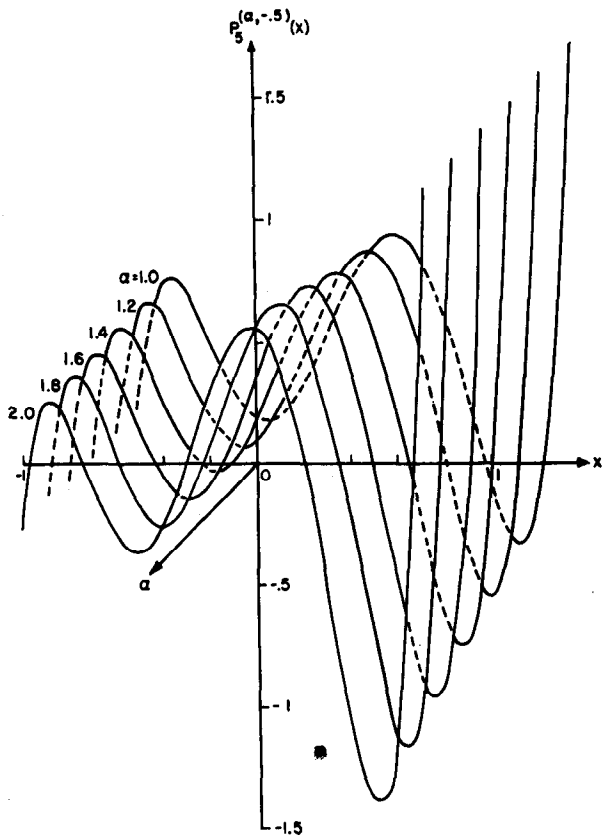

FIGURE 22.2. *Jacobi Polynomials* $P_n^{(\alpha, \beta)}(x)$, $\alpha=1(.2)2, \beta=-.5, n=5$.

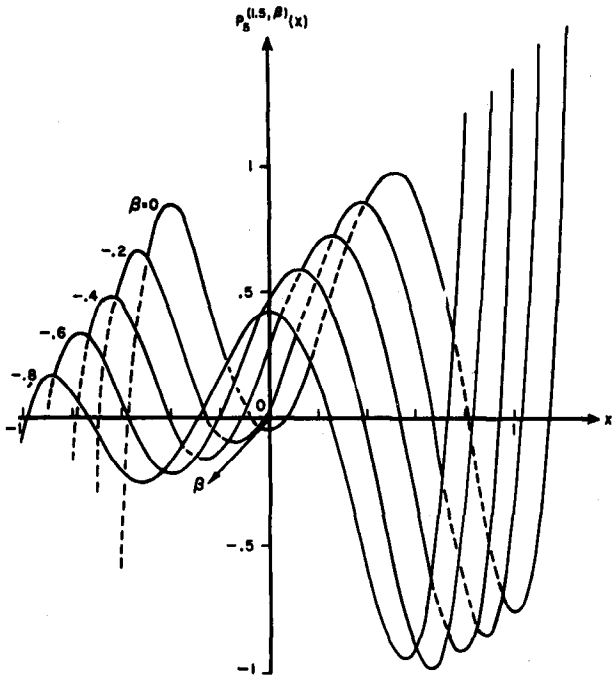

FIGURE 22.3. *Jacobi Polynomials* $P_n^{(\alpha, \beta)}(x)$, $\alpha=1.5, \beta=-.8(.2)0, n=5$.

Explicit Expressions Involving Trigonometric Functions

$$f_n(\cos \theta) = \sum_{m=0}^n a_m \cos(n-2m)\theta$$

	$f_n(\cos \theta)$	a_m	Remarks
22.3.12	$C_n^{(\alpha)}(\cos \theta)$	$\frac{\Gamma(\alpha+m)\Gamma(\alpha+n-m)}{m!(n-m)![\Gamma(\alpha)]^2}$	$\alpha \neq 0$
22.3.13	$P_n(\cos \theta)$	$\frac{1}{4^n} \binom{2m}{m} \binom{2n-2m}{n-m}$	

22.3.14 $C_n^{(0)}(\cos \theta) = \frac{2}{n} \cos n\theta$

22.3.15 $T_n(\cos \theta) = \cos n\theta$

22.3.16 $U_n(\cos \theta) = \frac{\sin(n+1)\theta}{\sin \theta}$

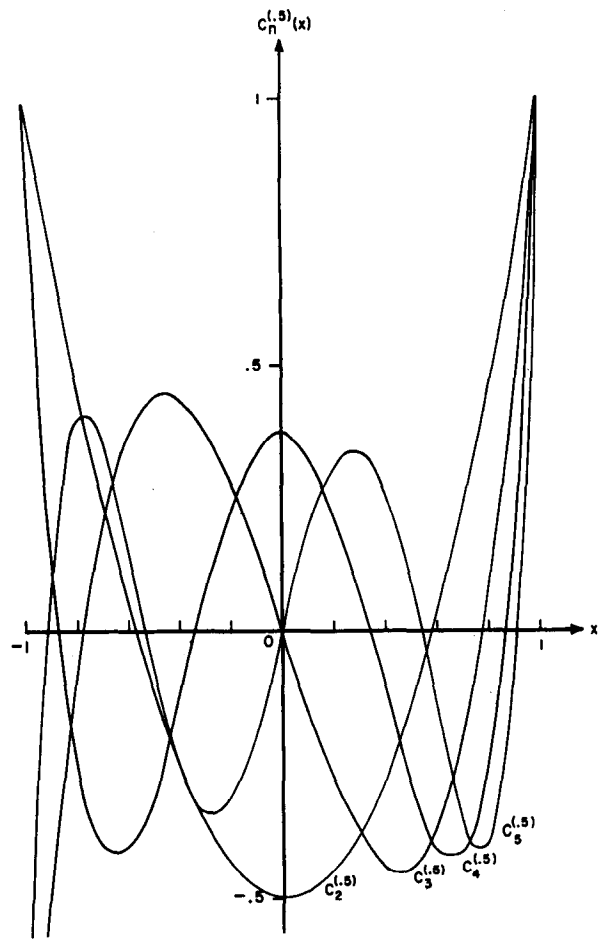

FIGURE 22.4. *Gegenbauer (Ultraspherical) Polynomials* $C_n^{(\alpha)}(x)$, $\alpha=.5, n=2(1)5$.

22.4. Special Values

	$f_n(x)$	$f_n(-x)$	$f_n(1)$	$f_n(0)$	$f_0(x)$	$f_1(x)$
22.4.1	$P_n^{(\alpha, \beta)}(x)$	$(-1)^n P_n^{(\beta, \alpha)}(x)$	$\binom{n+\alpha}{n}^*$		1	$\frac{1}{2}[\alpha - \beta + (\alpha + \beta + 2)x]$
22.4.2	$C_n^{(\alpha)}(x)$ $\alpha \neq 0$	$(-1)^n C_n^{(\alpha)}(x)$	$\binom{n+2\alpha-1}{n}$	$\begin{cases} 0, n=2m+1 \\ (-1)^{n/2} \frac{\Gamma(\alpha+n/2)}{\Gamma(\alpha)(n/2)!}, n=2m \end{cases}$	1	$2\alpha x$
22.4.3	$C_n^{(0)}(x)$	$(-1)^n C_n^{(0)}(x)$	$\frac{2}{n}, n \neq 0$	$\begin{cases} \frac{(-1)^m}{m}, n=2m \neq 0 \\ 0, n=2m+1 \end{cases}$	1	$2x$
22.4.4	$T_n(x)$	$(-1)^n T_n(x)$	1	$\begin{cases} (-1)^m, n=2m \\ 0, n=2m+1 \end{cases}$	1	x
22.4.5	$U_n(x)$	$(-1)^n U_n(x)$	$n+1$	$\begin{cases} (-1)^m, n=2m \\ 0, n=2m+1 \end{cases}$	1	$2x$
22.4.6	$P_n(x)$	$(-1)^n P_n(x)$	1	$\begin{cases} \frac{(-1)^m}{4^m} \binom{2m}{m}, n=2m^* \\ 0, n=2m+1 \end{cases}$	1	x
22.4.7	$L_n^{(\alpha)}(x)$			$\binom{n+\alpha}{n}$	1	$-x + \alpha + 1$
22.4.8	$H_n(x)$	$(-1)^n H_n(x)$		$\begin{cases} (-1)^m \frac{(2m)!}{m!}, n=2m \\ 0, n=2m+1 \end{cases}$	1	$2x$

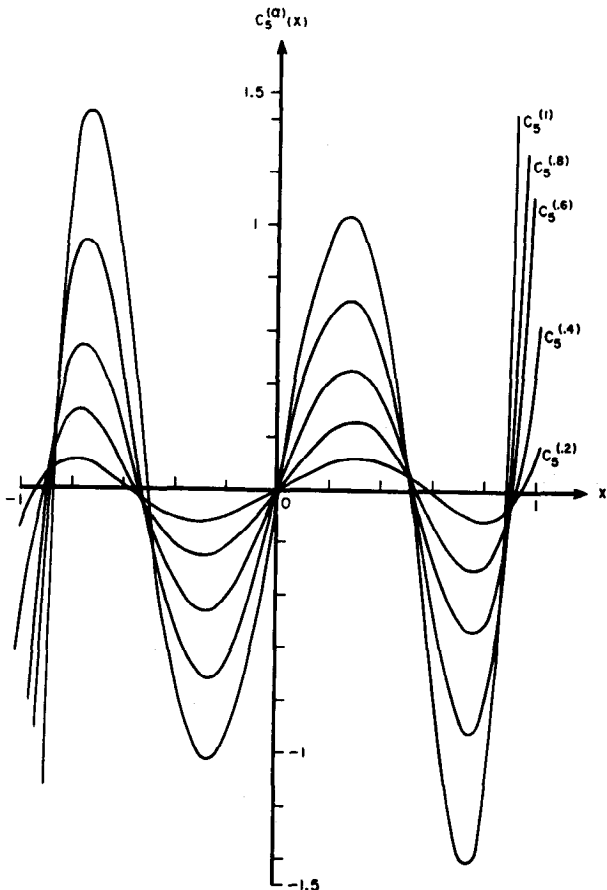

FIGURE 22.5. Gegenbauer (Ultraspherical) Polynomials $C_n^{(\alpha)}(x)$, $\alpha = 2.2(1)$, $n = 5$.

22.5. Interrelations

Interrelations Between Orthogonal Polynomials of the Same Family

Jacobi Polynomials

22.5.1

$$P_n^{(\alpha, \beta)}(x) = \frac{\Gamma(2n + \alpha + \beta + 1)}{n! \Gamma(n + \alpha + \beta + 1)} G_n\left(\alpha + \beta + 1, \beta + 1, \frac{x+1}{2}\right)$$

22.5.2

$$G_n(p, q, x) = \frac{n! \Gamma(n+p)}{\Gamma(2n+p)} P_n^{(p-q, q-1)}(2x-1)$$

(see [22.21]).

22.5.3

$$F_n(p, q, x) = (-1)^n n! \frac{\Gamma(q)}{\Gamma(q+n)} P_n^{(p-q, q-1)}(2x-1)$$

(see [22.13]).

Ultraspherical Polynomials

22.5.4
$$C_n^{(0)}(x) = \lim_{\alpha \rightarrow 0} \frac{1}{\alpha} C_n^{(\alpha)}(x)$$

Chebyshev Polynomials

22.5.5
$$T_n(x) = \frac{1}{2} C_n(2x) = T_n^*\left(\frac{1+x}{2}\right)$$

22.5.6
$$T_n(x) = U_n(x) - xU_{n-1}(x)$$

*See page II.

$$22.5.7 \quad T_n(x) = xU_{n-1}(x) - U_{n-2}(x)$$

$$22.5.8 \quad T_n(x) = \frac{1}{2} [U_n(x) - U_{n-2}(x)]$$

$$22.5.9 \quad U_n(x) = S_n(2x) = U_n^* \left(\frac{1+x}{2} \right)$$

$$22.5.10 \quad U_{n-1}(x) = \frac{1}{1-x^2} [xT_n(x) - T_{n+1}(x)]$$

$$22.5.11 \quad C_n(x) = 2T_n \left(\frac{x}{2} \right) = 2T_n^* \left(\frac{x+2}{4} \right)$$

$$22.5.12 \quad C_n(x) = S_n(x) - S_{n-2}(x)$$

$$22.5.13 \quad S_n(x) = U_n \left(\frac{x}{2} \right) = U_n^* \left(\frac{x+2}{4} \right)$$

$$22.5.14 \quad T_n^*(x) = T_n(2x-1) = \frac{1}{2} C_n(4x-2)$$

(see [22.22]).

$$22.5.15 \quad U_n^*(x) = S_n(4x-2) = U_n(2x-1)$$

(see [22.22]).

Generalized Laguerre Polynomials

$$22.5.16 \quad L_n^{(0)}(x) = L_n(x)$$

$$22.5.17 \quad L_n^{(m)}(x) = (-1)^m \frac{d^m}{dx^m} [L_{n+m}(x)]$$

Hermite Polynomials

$$22.5.18 \quad He_n(x) = 2^{-n/2} H_n \left(\frac{x}{\sqrt{2}} \right)$$

(see [22.20]).

$$22.5.19 \quad H_n(x) = 2^{n/2} He_n(x\sqrt{2})$$

(see [22.13], [22.20]).

Interrelations Between Orthogonal Polynomials of Different Families

Jacobi Polynomials

22.5.20

$$P_n^{(\alpha-\frac{1}{2}, \alpha-\frac{1}{2})}(x) = \frac{\Gamma(2\alpha)\Gamma(\alpha+n+\frac{1}{2})}{\Gamma(2\alpha+n)\Gamma(\alpha+\frac{1}{2})} C_n^{(\alpha)}(x)$$

22.5.21

$$P_n^{(\alpha, \frac{1}{2})}(x) = \frac{\left(\frac{1}{2}\right)_{n+1}}{\sqrt{\frac{x+1}{2}} (\alpha+\frac{1}{2})_{n+1}} C_{2n+1}^{(\alpha+\frac{1}{2})} \left(\sqrt{\frac{x+1}{2}} \right)$$

$$22.5.22 \quad P_n^{(\alpha, -\frac{1}{2})}(x) = \frac{\left(\frac{1}{2}\right)_n}{(\alpha+\frac{1}{2})_n} C_{2n}^{(\alpha+\frac{1}{2})} \left(\sqrt{\frac{x+1}{2}} \right)$$

$$22.5.23 \quad P_n^{(-\frac{1}{2}, -\frac{1}{2})}(x) = \frac{1}{4^n} \binom{2n}{n} T_n(x)$$

$$22.5.24 \quad P_n^{(0,0)}(x) = P_n(x)$$

Ultraspherical Polynomials

22.5.25

$$C_{2n}^{(\alpha)}(x) = \frac{\Gamma(\alpha+n)n!2^{2n}}{\Gamma(\alpha)(2n)!} P_n^{(\alpha-\frac{1}{2}, -\frac{1}{2})}(2x^2-1) \quad (\alpha \neq 0)$$

22.5.26

$$C_{2n+1}^{(\alpha)}(x) = \frac{\Gamma(\alpha+n+1)n!2^{2n+1}}{\Gamma(\alpha)(2n+1)!} x P_n^{(\alpha-\frac{1}{2}, \frac{1}{2})}(2x^2-1) \quad (\alpha \neq 0)$$

22.5.27

$$C_n^{(\alpha)}(x) = \frac{\Gamma(\alpha+\frac{1}{2})\Gamma(2\alpha+n)}{\Gamma(2\alpha)\Gamma(\alpha+n+\frac{1}{2})} P_n^{(\alpha-\frac{1}{2}, \alpha-\frac{1}{2})}(x) \quad (\alpha \neq 0)$$

22.5.28

$$C_n^{(0)}(x) = \frac{2}{n} T_n(x) = 2 \frac{(n-1)!}{\Gamma(n+\frac{1}{2})} \sqrt{\pi} P_n^{(-\frac{1}{2}, -\frac{1}{2})}(x) \quad *$$

Chebyshev Polynomials

$$22.5.29 \quad T_{2n+1}(x) = \frac{n! \sqrt{\pi}}{\Gamma(n+\frac{1}{2})} x P_n^{(-\frac{1}{2}, \frac{1}{2})}(2x^2-1)$$

$$22.5.30 \quad U_{2n}(x) = \frac{n! \sqrt{\pi}}{\Gamma(n+\frac{1}{2})} P_n^{(\frac{1}{2}, -\frac{1}{2})}(2x^2-1)$$

$$22.5.31 \quad T_n(x) = \frac{n! \sqrt{\pi}}{\Gamma(n+\frac{1}{2})} P_n^{(-\frac{1}{2}, -\frac{1}{2})}(x)$$

$$22.5.32 \quad U_n(x) = \frac{(n+1)! \sqrt{\pi}}{2\Gamma(n+\frac{3}{2})} P_n^{(\frac{1}{2}, \frac{1}{2})}(x)$$

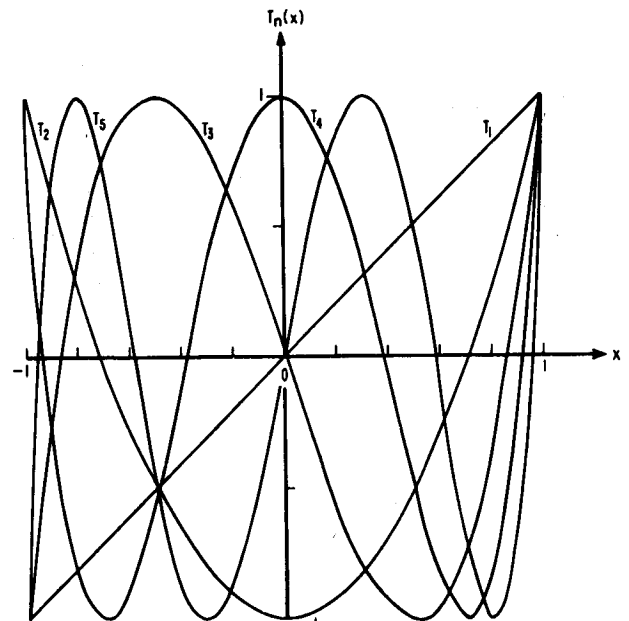

FIGURE 22.6. Chebyshev Polynomials $T_n(x)$, $n=1(1)5$.

*See page II.

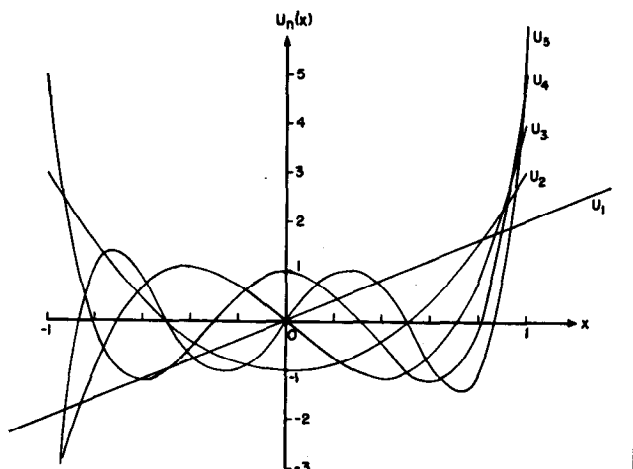

FIGURE 22.7. Chebyshev Polynomials $U_n(x)$, $n=1(1)5$.

22.5.33 $T_n(x) = \frac{n}{2} C_n^{(0)}(x)$

22.5.34 $U_n(x) = C_n^{(1)}(x)$

Legendre Polynomials

22.5.35 $P_n(x) = P_n^{(0,0)}(x)$

22.5.36 $P_n(x) = C_n^{(1/2)}(x)$

22.5.37

$\frac{d^m}{dx^m} [P_n(x)] = 1 \cdot 3 \dots (2m-1) C_{n-m}^{(m+1)}(x) \quad (m \leq n)$

Generalized Laguerre Polynomials

22.5.38 $L_n^{(-1/2)}(x) = \frac{(-1)^n}{n! 2^{2n}} H_{2n}(\sqrt{x})$

22.5.39 $L_n^{(1/2)}(x) = \frac{(-1)^n}{n! 2^{2n+1} \sqrt{x}} H_{2n+1}(\sqrt{x})$

Hermite Polynomials

22.5.40 $H_{2m}(x) = (-1)^m 2^{2m} m! L_m^{(-1/2)}(x^2)$

22.5.41 $H_{2m+1}(x) = (-1)^m 2^{2m+1} m! x L_m^{(1/2)}(x^2)$

Orthogonal Polynomials as Hypergeometric Functions (see chapter 15)

$f_n(x) = {}_dF(a, b; c; g(x))$

For each of the listed polynomials there are numerous other representations in terms of hypergeometric functions.

	$f_n(x)$	d	a	b	c	$g(x)$
22.5.42	$P_n^{(\alpha, \beta)}(x)$	$\binom{n+\alpha}{n}$	$-n$	$n+\alpha+\beta+1$	$\alpha+1$	$\frac{1-x}{2}$
22.5.43	$P_n^{(\alpha, \beta)}(x)$	$\binom{2n+\alpha+\beta}{n} \left(\frac{x-1}{2}\right)^n$	$-n$	$-n-\alpha$	$-2n-\alpha-\beta$	$\frac{2}{1-x}$
22.5.44	$P_n^{(\alpha, \beta)}(x)$	$\binom{n+\alpha}{n} \left(\frac{1+x}{2}\right)^n$	$-n$	$-n-\beta$	$\alpha+1$	$\frac{x-1}{x+1}$
22.5.45	$P_n^{(\alpha, \beta)}(x)$	$\binom{n+\beta}{n} \left(\frac{x-1}{2}\right)^n$	$-n$	$-n-\alpha$	$\beta+1$	$\frac{x+1}{x-1}$
22.5.46	$C_n^{(\alpha)}(x)$	$\frac{\Gamma(n+2\alpha)}{n! \Gamma(2\alpha)}$	$-n$	$n+2\alpha$	$\alpha+\frac{1}{2}$	$\frac{1-x}{2}$
22.5.47	$T_n(x)$	1	$-n$	n	$\frac{1}{2}$	$\frac{1-x}{2}$
22.5.48	$U_n(x)$	$n+1$	$-n$	$n+2$	$\frac{3}{2}$	$\frac{1-x}{2}$
22.5.49	$P_n(x)$	1	$-n$	$n+1$	1	$\frac{1-x}{2}$
22.5.50	$P_n(x)$	$\binom{2n}{n} \left(\frac{x-1}{2}\right)^n$	$-n$	$-n$	$-2n$	$\frac{2}{1-x}$
22.5.51	$P_n(x)$	$\binom{2n}{n} \left(\frac{x}{2}\right)^n$	$-\frac{n}{2}$	$\frac{1-n}{2}$	$\frac{1}{2}-n$	$\frac{1}{x^2}$
22.5.52	$P_{2n}(x)$	$(-1)^n \frac{(2n)!}{2^{2n} (n!)^2}$	$-n$	$n+\frac{1}{2}$	$\frac{1}{2}$	x^2
22.5.53	$P_{2n+1}(x)$	$(-1)^n \frac{(2n+1)!}{2^{2n} (n!)^2} x$	$-n$	$n+\frac{3}{2}$	$\frac{3}{2}$	x^2

*See page II.

Orthogonal Polynomials as Confluent Hypergeometric Functions (see chapter 13)

22.5.54 $L_n^{(\alpha)}(x) = \binom{n+\alpha}{n} M(-n, \alpha+1, x)$

Orthogonal Polynomials as Parabolic Cylinder Functions (see chapter 19)

22.5.55 $H_n(x) = 2^n U\left(\frac{1}{2}n, \frac{3}{2}, x^2\right)$

22.5.56 $H_{2m}(x) = (-1)^m \frac{(2m)!}{m!} M\left(-m, \frac{1}{2}, x^2\right)$

22.5.57

* $H_{2m+1}(x) = (-1)^m \frac{(2m+1)!}{m!} 2xM\left(-m, \frac{3}{2}, x^2\right)$

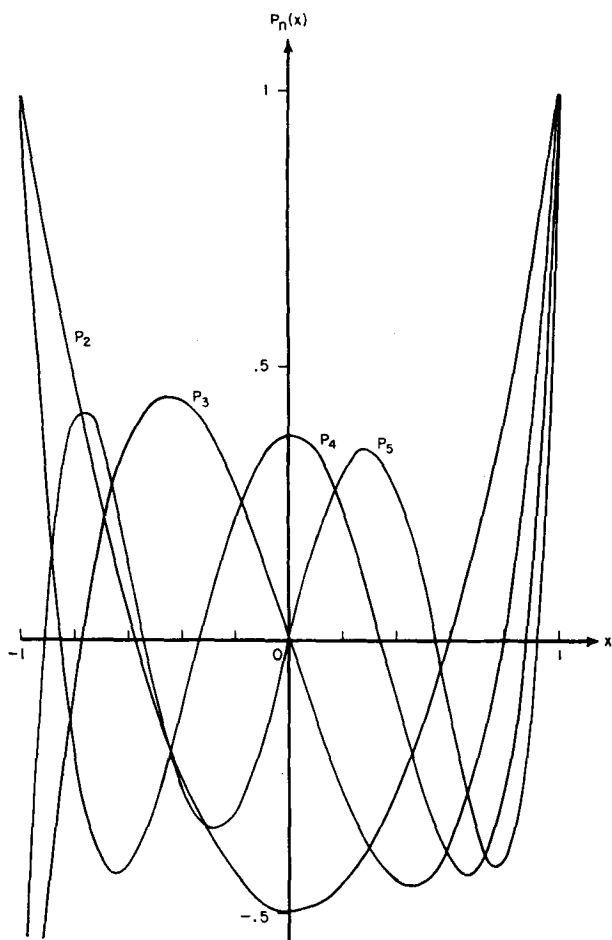

FIGURE 22.8. Legendre Polynomials $P_n(x)$, $n=2(1)5$.

*See page II.

22.5.58

$H_n(x) = 2^{n/2} e^{x^2/2} D_n(\sqrt{2}x) = 2^{n/2} e^{x^2/2} U\left(-n - \frac{1}{2}, \sqrt{2}x\right)$

22.5.59 $He_n(x) = e^{x^2/4} D_n(x) = e^{x^2/4} U\left(-n - \frac{1}{2}, x\right)$

Orthogonal Polynomials as Legendre Functions (see chapter 8)

22.5.60

$C_n^{(\alpha)}(x) =$

$\frac{\Gamma(\alpha + \frac{1}{2})\Gamma(2\alpha + n)}{n!\Gamma(2\alpha)} \left[\frac{1}{4}(x^2 - 1)\right]^{1-\frac{\alpha}{2}} P_{n+\alpha-\frac{1}{2}}^{(\alpha)}(x)$
 $(\alpha \neq 0)$

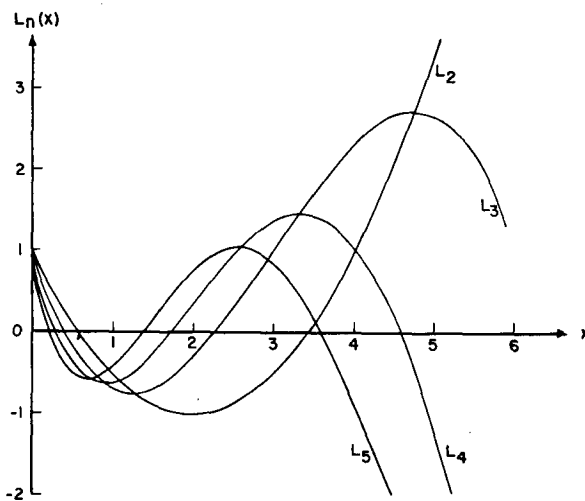

FIGURE 22.9. Laguerre Polynomials $L_n(x)$, $n=2(1)5$.

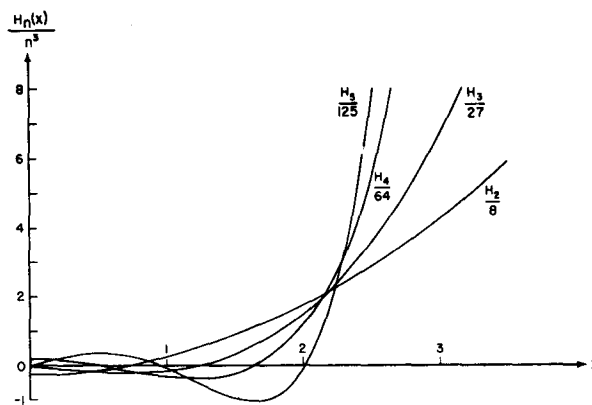

FIGURE 22.10. Hermite Polynomials $\frac{H_n(x)}{n^3}$, $n=2(1)5$.

22.6. Differential Equations

$$g_2(x)y'' + g_1(x)y' + g_0(x)y = 0$$

	y	$g_2(x)$	$g_1(x)$	$g_0(x)$
22.6.1	$P_n^{(\alpha, \beta)}(x)$	$1-x^2$	$\beta - \alpha - (\alpha + \beta + 2)x$	$n(n + \alpha + \beta + 1)$
22.6.2	$(1-x)^\alpha(1+x)^\beta P_n^{(\alpha, \beta)}(x)$	$1-x^2$	$\alpha - \beta + (\alpha + \beta - 2)x$	$(n+1)(n + \alpha + \beta)$
22.6.3	$(1-x)^{\frac{\alpha+1}{2}}(1+x)^{\frac{\beta+1}{2}} P_n^{(\alpha, \beta)}(x)$	1	0	$\frac{1}{4} \frac{1-\alpha^2}{(1-x)^2} + \frac{1}{4} \frac{1-\beta^2}{(1+x)^2}$ $+ \frac{2n(n + \alpha + \beta + 1) + (\alpha + 1)(\beta + 1)}{2(1-x^2)}$
22.6.4	$\left(\sin \frac{x}{2}\right)^{\alpha+\frac{1}{2}} \left(\cos \frac{x}{2}\right)^{\beta+\frac{1}{2}} P_n^{(\alpha, \beta)}(\cos x)$	1	0	$\frac{1-4\alpha^2}{16 \sin^2 \frac{x}{2}} + \frac{1-4\beta^2}{16 \cos^2 \frac{x}{2}}$ $+ \left(n + \frac{\alpha + \beta + 1}{2}\right)^2$
22.6.5	$C_n^{(\alpha)}(x)$	$1-x^2$	$-(2\alpha+1)x$	$n(n+2\alpha)$
22.6.6	$(1-x^2)^{\alpha-\frac{1}{2}} C_n^{(\alpha)}(x)$	$1-x^2$	$(2\alpha-3)x$	$(n+1)(n+2\alpha-1)$
22.6.7	$(1-x^2)^{\frac{\alpha+1}{4}} C_n^{(\alpha)}(x)$	1	0	$\frac{(n+\alpha)^2}{1-x^2} + \frac{2+4\alpha-4\alpha^2+x^2}{4(1-x^2)^2}$
22.6.8	$(\sin x)^\alpha C_n^{(\alpha)}(\cos x)$	1	0	$(n+\alpha)^2 + \frac{\alpha(1-\alpha)}{\sin^2 x}$
22.6.9	$T_n(x)$	$1-x^2$	$-x$	n^2
22.6.10	$T_n(\cos x)$	1	0	n^2
22.6.11	$\frac{1}{\sqrt{1-x^2}} T_n(x); U_{n-1}(x)$	$1-x^2$	$-3x$	n^2-1
22.6.12	$U_n(x)$	$1-x^2$	$-3x$	$n(n+2)$
22.6.13	$P_n(x)$	$1-x^2$	$-2x$	$n(n+1)$
22.6.14	$\sqrt{1-x^2} P_n(x)$	1	0	$\frac{n(n+1)}{1-x^2} + \frac{1}{(1-x^2)^2}$
22.6.15	$L_n^{(\alpha)}(x)$	x	$\alpha+1-x$	n
22.6.16	$e^{-x} x^{\alpha/2} L_n^{(\alpha)}(x)$	x	$x+1$	$n + \frac{\alpha}{2} + 1 - \frac{\alpha^2}{4x}$
22.6.17	$e^{-x/2} x^{(\alpha+1)/2} L_n^{(\alpha)}(x)$	1	0	$\frac{2n+\alpha+1}{2x} + \frac{1-\alpha^2}{4x^2} - \frac{1}{4}$
22.6.18	$e^{-x^2/2} x^{\alpha+\frac{1}{2}} L_n^{(\alpha)}(x^2)$	1	0	$4n+2\alpha+2-x^2 + \frac{1-4\alpha^2}{4x^2}$
22.6.19	$H_n(x)$	1	$-2x$	$2n$
22.6.20	$e^{-\frac{x^2}{2}} H_n(x)$	1	0	$2n+1-x^2$
22.6.21	$He_n(x)$	1	$-x$	n

*See page II.

22.7. Recurrence Relations

Recurrence Relations With Respect to the Degree n

$$a_{1n}f_{n+1}(x) = (a_{2n} + a_{3n}x)f_n(x) - a_{4n}f_{n-1}(x)$$

	f_n	a_{1n}	a_{2n}	a_{3n}	a_{4n}
22.7.1	$P_n^{(\alpha, \beta)}(x)$	$2(n+1)(n+\alpha+\beta+1)$ $(2n+\alpha+\beta)$	$(2n+\alpha+\beta+1)(\alpha^2-\beta^2)$	$(2n+\alpha+\beta)_3$	$2(n+\alpha)(n+\beta)$ $(2n+\alpha+\beta+2)$
22.7.2	$G_n(p, q, x)$	$(2n+p-2)_4(2n+p-1)$	$-[2n(n+p)+q(p-1)]$ $(2n+p-2)_3$	$(2n+p-2)_4$ $(2n+p-1)$	$n(n+q-1)(n+p-1)$ $(n+p-q)(2n+p+1)$
22.7.3	$C_n^{(\alpha)}(x)$	$n+1$	0	$2(n+\alpha)$	$n+2\alpha-1$
22.7.4	$T_n(x)$	1	0	2	1
22.7.5	$U_n(x)$	1	0	2	1
22.7.6	$S_n(x)$	1	0	1	1
22.7.7	$C_n(x)$	1	0	1	1
22.7.8	$T_n^*(x)$	1	-2	4	1
22.7.9	$U_n^*(x)$	1	-2	4	1
22.7.10	$P_n(x)$	$n+1$	0	$2n+1$	n
22.7.11	$P_n^*(x)$	$n+1$	$-2n-1$	$4n+2$	n
22.7.12	$L_n^{(\alpha)}(x)$	$n+1$	$2n+\alpha+1$	-1	$n+\alpha$
22.7.13	$H_n(x)$	1	0	2	$2n$
22.7.14	$He_n(x)$	1	0	1	n

Miscellaneous Recurrence Relations

Jacobi Polynomials

22.7.15

$$\left(n + \frac{\alpha}{2} + \frac{\beta}{2} + 1\right) (1-x)P_n^{(\alpha+1, \beta)}(x) = (n+\alpha+1)P_n^{(\alpha, \beta)}(x) - (n+1)P_{n+1}^{(\alpha, \beta)}(x)$$

22.7.16

$$\left(n + \frac{\alpha}{2} + \frac{\beta}{2} + 1\right) (1+x)P_n^{(\alpha, \beta+1)}(x) = (n+\beta+1)P_n^{(\alpha, \beta)}(x) + (n+1)P_{n+1}^{(\alpha, \beta)}(x)$$

22.7.17

$$(1-x)P_n^{(\alpha+1, \beta)}(x) + (1+x)P_n^{(\alpha, \beta+1)}(x) = 2P_n^{(\alpha, \beta)}(x)$$

22.7.18

$$(2n+\alpha+\beta)P_n^{(\alpha-1, \beta)}(x) = (n+\alpha+\beta)P_n^{(\alpha, \beta)}(x) - (n+\beta)P_{n-1}^{(\alpha, \beta)}(x)$$

22.7.19

$$(2n+\alpha+\beta)P_n^{(\alpha, \beta-1)}(x) = (n+\alpha+\beta)P_n^{(\alpha, \beta)}(x) + (n+\alpha)P_{n-1}^{(\alpha, \beta)}(x)$$

22.7.20 $P_n^{(\alpha, \beta-1)}(x) - P_n^{(\alpha-1, \beta)}(x) = P_{n-1}^{(\alpha, \beta)}(x)$

Ultraspherical Polynomials

22.7.21

$$2\alpha(1-x^2)C_{n-1}^{(\alpha+1)}(x) = (2\alpha+n-1)C_{n-1}^{(\alpha)}(x) - nx C_n^{(\alpha)}(x)$$

22.7.22

$$= (n+2\alpha)x C_n^{(\alpha)}(x) - (n+1)C_{n+1}^{(\alpha)}(x)$$

22.7.23

$$(n+\alpha)C_{n+1}^{(\alpha-1)}(x) = (\alpha-1)[C_{n+1}^{(\alpha)}(x) - C_{n-1}^{(\alpha)}(x)]$$

Chebyshev Polynomials

22.7.24

$$2T_m(x)T_n(x) = T_{n+m}(x) + T_{n-m}(x) \quad (n \geq m) \quad *$$

22.7.25

$$2(x^2-1)U_{m-1}(x)U_{n-1}(x) = T_{n+m}(x) - T_{n-m}(x) \quad (n \geq m)$$

22.7.26

$$2T_m(x)U_{n-1}(x) = U_{n+m-1}(x) + U_{n-m-1}(x) \quad (n > m)$$

22.7.27

$$2T_n(x)U_{m-1}(x) = U_{n+m-1}(x) - U_{n-m-1}(x) \quad (n > m)$$

22.7.28

$$2T_n(x)U_{n-1}(x) = U_{2n-1}(x)$$

*See page II.

Generalized Laguerre Polynomials

22.7.29

$$L_n^{(\alpha+1)}(x) = \frac{1}{x} [(x-n)L_n^{(\alpha)}(x) + (\alpha+n)L_{n-1}^{(\alpha)}(x)]$$

22.7.30

$$L_n^{(\alpha-1)}(x) = L_n^{(\alpha)}(x) - L_{n-1}^{(\alpha)}(x)$$

22.7.31

$$L_n^{(\alpha+1)}(x) = \frac{1}{x} [(n+\alpha+1)L_n^{(\alpha)}(x) - (n+1)L_{n+1}^{(\alpha)}(x)]$$

22.7.32

$$L_n^{(\alpha-1)}(x) = \frac{1}{n+\alpha} [(n+1)L_{n+1}^{(\alpha)}(x) - (n+1-x)L_n^{(\alpha)}(x)]$$

22.8. Differential Relations

$$g_2(x) \frac{d}{dx} f_n(x) = g_1(x) f_n(x) + g_0(x) f_{n-1}(x)$$

	f_n	g_2	g_1	g_0
22.8.1	$P_n^{(\alpha, \beta)}(x)$	$(2n + \alpha + \beta)(1 - x^2)$	$n[\alpha - \beta - (2n + \alpha + \beta)x]$	$2(n + \alpha)(n + \beta)$
22.8.2	$C_n^{(\alpha)}(x)$	$1 - x^2$	$-nx$	$n + 2\alpha - 1$
22.8.3	$T_n(x)$	$1 - x^2$	$-nx$	n
22.8.4	$U_n(x)$	$1 - x^2$	$-nx$	$n + 1$
22.8.5	$P_n(x)$	$1 - x^2$	$-nx$	n
22.8.6	$L_n^{(\alpha)}(x)$	x	n	$-(n + \alpha)$
22.8.7	$H_n(x)$	1	0	$2n$
22.8.8	$He_n(x)$	1	0	n

22.9. Generating Functions

$$g(x, z) = \sum_{n=0}^{\infty} a_n f_n(x) z^n$$

$$R = \sqrt{1 - 2xz + z^2}$$

	$f_n(x)$	a_n	$g(x, z)$	Remarks
22.9.1	$P_n^{(\alpha, \beta)}(x)$	$2^{-n-\beta}$	$R^{-1}(1-z+R)^{-\alpha}(1+z+R)^{-\beta}$	$ z < 1$
22.9.2	$C_n^{(\alpha)}(x)$	$\frac{2^{1-\alpha} \Gamma(\alpha + \frac{1}{2} + n) \Gamma(2\alpha)}{\Gamma(\alpha + \frac{1}{2}) \Gamma(2\alpha + n)}$	$R^{-1}(1-xz+R)^{1-\alpha}$	$ z < 1, \alpha \neq 0$
22.9.3	$C_n^{(\alpha)}(x)$	1	$R^{-2\alpha}$	$ z < 1, \alpha \neq 0$
22.9.4	$C_n^{(0)}(x)$	1	$-\ln R^2$	$ z < 1$
22.9.5	$C_n^{(\alpha)}(x)$	$\frac{\Gamma(2\alpha)}{\Gamma(\alpha + \frac{1}{2}) \Gamma(2\alpha + n)}$	$e^{z \cos \theta} \left(\frac{z}{2} \sin \theta\right)^{1-\alpha} J_{\alpha-1}(z \sin \theta)$	$x = \cos \theta$
22.9.6	$T_n(x)$	2	$\left(\frac{1-xz}{R^2} + 1\right)$	$-1 < x < 1$ $ z < 1$
22.9.7	$T_n(x)$	$\frac{\sqrt{2}}{4^n} \binom{2n}{n}$	$R^{-1}(1-xz+R)^{1/2}$	$-1 < x < 1$ $ z < 1$
22.9.8	$T_n(x)$	$\frac{1}{n}$	$1 - \frac{1}{2} \ln R^2$	$a_0 = 1$ $-1 < x < 1$ $ z < 1$
22.9.9	$T_n(x)$	1	$\frac{1-xz}{R^2}$	$-1 < x < 1$ $ z < 1$
22.9.10	$U_n(x)$	1	R^{-2}	$-1 < x < 1$ $ z < 1$
22.9.11	$U_n(x)$	$\frac{\sqrt{2}}{4^{n+1}} \binom{2n+2}{n+1}$	$\frac{1}{R} (1-xz+R)^{-1/2}$ *	$-1 < x < 1$ $ z < 1$

*See page II.

22.9. Generating Functions—Continued

$$g(x, z) = \sum_{n=0}^{\infty} a_n f_n(x) z^n \quad R = \sqrt{1 - 2xz + z^2}$$

	$f_n(x)$	a_n	$g(x, z)$	Remarks
22.9.12	$P_n(x)$	1	R^{-1}	$-1 < x < 1$ $ z < 1$
22.9.13	$P_n(x)$	$\frac{1}{n!}$	$e^x \cos^{\alpha} J_0(z \sin \theta)$	$x = \cos \theta$
22.9.14	$S_n(x)$	1	$(1 - 2xz + z^2)^{-1}$	$-2 < x < 2$ $ z < 1$
22.9.15	$L_n^{(\alpha)}(x)$	1	$(1 - z)^{-\alpha-1} \exp\left(\frac{xz}{z-1}\right)$	$ z < 1$
22.9.16	$L_n^{(\alpha)}(x)$	$\frac{1}{\Gamma(n + \alpha + 1)}$	$(xz)^{-1} e^x J_n[2(xz)^{1/2}]$	
22.9.17	$H_n(x)$	$\frac{1}{n!}$	$e^{2xz - z^2}$	
22.9.18	$H_{2n}(x)$	$\frac{(-1)^n}{(2n)!}$	$e^z \cos(2x\sqrt{z})$ *	
22.9.19	$H_{2n+1}(x)$	$\frac{(-1)^n}{(2n+1)!}$	$z^{-1/2} e^z \sin(2x\sqrt{z})$ *	

22.10. Integral Representations

Contour Integral Representations

$$f_n(x) = \frac{g_0(x)}{2\pi i} \int_C [g_1(z, x)]^n g_2(z, x) dz \text{ where } C \text{ is a closed contour taken around } z=a \text{ in the positive sense}$$

	$f_n(x)$	$g_0(x)$	$g_1(z, x)$	$g_2(z, x)$	a	Remarks
22.10.1	$P_n^{(\alpha, \beta)}(x)$	$\frac{1}{(1-x)^\alpha (1+x)^\beta}$	$\frac{z^2 - 1}{2(z-x)}$	$\frac{(1-z)^\alpha (1+z)^\beta}{z-x}$	x	± 1 outside C
22.10.2	$C_n^{(\alpha)}(x)$	1	$1/z$	$(1 - 2xz + z^2)^{-\alpha} z^{-1}$	0	Both zeros of $1 - 2xz + z^2$ outside C , $\alpha > 0$
22.10.3	$T_n(x)$	1/2	$1/z$	$\frac{1 - z^2}{z(1 - 2xz + z^2)}$	0	Both zeros of $1 - 2xz + z^2$ outside C
22.10.4	$U_n(x)$	1	$1/z$	$\frac{1}{z(1 - 2xz + z^2)}$	0	Both zeros of $1 - 2xz + z^2$ outside C
22.10.5	$P_n(x)$	1	$1/z$	$\frac{1}{z} (1 - 2xz + z^2)^{-1/2}$	0	Both zeros of $1 - 2xz + z^2$ outside C
22.10.6	$P_n(x)$	$\frac{1}{2^n}$	$\frac{z^2 - 1}{z - x}$	$\frac{1}{z - x}$	x	
22.10.7	$L_n^{(\alpha)}(x)$	$e^{2x - \alpha}$	$\frac{z}{z - x}$	$\frac{z^\alpha}{z - x} e^{-x}$	x	Zero outside C
22.10.8	$L_n^{(\alpha)}(x)$	1	$1 + \frac{x}{z}$	$e^{-x} \left(1 + \frac{x}{z}\right)^\alpha 1/z$	0	$z = -x$ outside C
22.10.9	$H_n(x)$	$n!$	$1/z$	$\frac{e^{2xz - z^2}}{z}$	0	

Miscellaneous Integral Representations

$$22.10.10 \quad C_n^{(\alpha)}(x) = \frac{2^{(1-2\alpha)} \Gamma(n+2\alpha)}{n! [\Gamma(\alpha)]^2} \int_0^\pi [x + \sqrt{x^2 - 1} \cos \phi]^n (\sin \phi)^{2\alpha - 1} d\phi \quad (\alpha > 0)$$

$$22.10.11 \quad C_n^{(\alpha)}(\cos \theta) = \frac{2^{1-\alpha} \Gamma(n+2\alpha)}{n! [\Gamma(\alpha)]^2} (\sin \theta)^{1-2\alpha} \int_0^\theta \frac{\cos(n+\alpha)\phi}{(\cos \phi - \cos \theta)^{1-\alpha}} d\phi \quad (\alpha > 0)$$

*See page II.

22.10.12 $P_n(\cos \theta) = \frac{1}{\pi} \int_0^\pi (\cos \theta + i \sin \theta \cos \phi)^n d\phi$

22.10.13 $P_n(\cos \theta) = \frac{\sqrt{2}}{\pi} \int_0^\pi \frac{\sin(n + \frac{1}{2})\phi d\phi}{(\cos \theta - \cos \phi)^{\frac{1}{2}}}$

22.10.14 $L_n^{(\alpha)}(x) = \frac{e^x x^{-\frac{\alpha}{2}}}{n!} \int_0^\infty e^{-t} t^{n+\frac{\alpha}{2}} J_\alpha(2\sqrt{tx}) dt$

22.10.15 $H_n(x) = e^{x^2} \frac{2^{n+1}}{\sqrt{\pi}} \int_0^\infty e^{-t^2} t^n \cos\left(2xt - \frac{n}{2}\pi\right) dt$

22.11. Rodrigues' Formula

$$f_n(x) = \frac{1}{a_n \rho(x)} \frac{d^n}{dx^n} \{ \rho(x)(g(x))^n \}$$

The polynomials given in the following table are the only orthogonal polynomials which satisfy this formula.

	$f_n(x)$	a_n	$\rho(x)$	$g(x)$
22.11.1	$P_n^{(\alpha, \beta)}(x)$	$(-1)^n 2^n n!$	$(1-x)^\alpha (1+x)^\beta$	$1-x^2$
22.11.2	$C_n^{(\alpha)}(x)$	$(-1)^n 2^n n! \frac{\Gamma(2\alpha)\Gamma(\alpha+n+\frac{1}{2})}{\Gamma(\alpha+\frac{1}{2})\Gamma(n+2\alpha)}$	$(1-x^2)^{\alpha-\frac{1}{2}}$	$1-x^2$
22.11.3	$T_n(x)$	$(-1)^n 2^n \frac{\Gamma(n+\frac{1}{2})}{\sqrt{\pi}}$	$(1-x^2)^{-\frac{1}{2}}$	$1-x^2$
22.11.4	$U_n(x)$	$(-1)^n 2^{n+1} \frac{\Gamma(n+\frac{1}{2})}{(n+1)\sqrt{\pi}}$	$(1-x^2)^{\frac{1}{2}}$	$1-x^2$
22.11.5	$P_n(x)$	$(-1)^n 2^n n!$	1	$1-x^2$
22.11.6	$L_n^{(\alpha)}(x)$	$n!$	$e^{-x} x^\alpha$	x
22.11.7	$H_n(x)$	$(-1)^n$	e^{-x^2}	1
22.11.8	$He_n(x)$	$(-1)^n$	$e^{-x^2/2}$	1

22.12. Sum Formulas

Christoffel-Darboux Formula

22.12.1

$$\sum_{m=0}^n \frac{1}{h_m} f_m(x) f_m(y) = \frac{k_n}{k_{n+1} h_n} \frac{f_{n+1}(x) f_n(y) - f_n(x) f_{n+1}(y)}{x-y}$$

Miscellaneous Sum Formulas (Only a Limited Selection Is Given Here.)

22.12.2 $\sum_{m=0}^n T_{2m}(x) = \frac{1}{2} [1 + U_{2n}(x)]$

22.12.3 $\sum_{m=0}^{n-1} T_{2m+1}(x) = \frac{1}{2} U_{2n-1}(x)$

22.12.4 $\sum_{m=0}^n U_{2m}(x) = \frac{1 - T_{2n+2}(x)}{2(1-x^2)}$

22.12.5 $\sum_{m=0}^{n-1} U_{2m+1}(x) = \frac{x - T_{2n+1}(x)}{2(1-x^2)}$

22.12.6 $\sum_{m=0}^n L_m^{(\alpha)}(x) L_n^{(\beta)}(y) = L_n^{(\alpha+\beta+1)}(x+y)$

22.12.7 $\sum_{m=0}^n \binom{n+\alpha}{m} \mu^{n-m} (1-\mu)^m L_n^{(\alpha)}(x) = L_n^{(\alpha)}(\mu x)$

22.12.8

$$H_n(x+y) = \frac{1}{2^{n/2}} \sum_{k=0}^n \binom{n}{k} H_k(\sqrt{2}x) H_{n-k}(\sqrt{2}y)$$

22.13. Integrals Involving Orthogonal Polynomials

22.13.1

$$2n \int_0^x (1-y)^\alpha (1+y)^\beta P_n^{(\alpha, \beta)}(y) dy = P_{n-1}^{(\alpha+1, \beta+1)}(0) - (1-x)^{\alpha+1} (1+x)^{\beta+1} P_{n-1}^{(\alpha+1, \beta+1)}(x)$$

22.13.2

$$\frac{n(2\alpha+n)}{2\alpha} \int_0^x (1-y^2)^{\alpha-\frac{1}{2}} C_n^{(\alpha)}(y) dy = C_{n-1}^{(\alpha+1)}(0) - (1-x^2)^{\alpha+\frac{1}{2}} C_{n-1}^{(\alpha+1)}(x)$$

22.13.3 $\int_{-1}^1 \frac{T_n(y) dy}{(y-x)\sqrt{1-y^2}} = \pi U_{n-1}(x)$

22.13.4 $\int_{-1}^1 \frac{\sqrt{1-y^2} U_{n-1}(y) dy}{(y-x)} = -\pi T_n(x)$ *

22.13.5 $\int_{-1}^1 (1-x)^{-1/2} P_n(x) dx = \frac{2^{3/2}}{2n+1}$ *

22.13.6 $\int_0^\pi P_{2n}(\cos \theta) d\theta = \frac{\pi}{16^n} \binom{2n}{n}^2$

22.13.7 $\int_0^\pi P_{2n+1}(\cos \theta) \cos \theta d\theta = \frac{\pi}{4^{2n+1}} \binom{2n}{n} \binom{2n+2}{n+1}$

*See page 11.

22.13.8

$$\int_0^1 x^\lambda P_{2n}(x) dx = \frac{(-1)^n \Gamma\left(n - \frac{\lambda}{2}\right) \Gamma\left(\frac{1}{2} + \frac{\lambda}{2}\right)}{2\Gamma\left(-\frac{\lambda}{2}\right) \Gamma\left(n + \frac{3}{2} + \frac{\lambda}{2}\right)} \quad (\lambda > -1)$$

22.13.9

$$\int_0^1 x^\lambda P_{2n+1}(x) dx = \frac{(-1)^n \Gamma\left(n + \frac{1}{2} - \frac{\lambda}{2}\right) \Gamma\left(1 + \frac{\lambda}{2}\right)}{2\Gamma\left(n + 2 + \frac{\lambda}{2}\right) \Gamma\left(\frac{1}{2} - \frac{\lambda}{2}\right)} \quad (\lambda > -2)$$

22.13.10

$$\int_{-1}^x \frac{P_n(t) dt}{\sqrt{x-t}} = \frac{1}{(n + \frac{1}{2})\sqrt{1+x}} [T_n(x) + T_{n+1}(x)]$$

22.13.11

$$\int_x^1 \frac{P_n(t) dt}{\sqrt{t-x}} = \frac{1}{(n + \frac{1}{2})\sqrt{1-x}} [T_n(x) - T_{n+1}(x)]$$

$$22.13.12 \quad \int_x^\infty e^{-t} L_n^{(\alpha)}(t) dt = e^{-x} [L_n^{(\alpha)}(x) - L_{n-1}^{(\alpha)}(x)]$$

22.13.13

$$\Gamma(\alpha + \beta + n + 1) \int_0^x (x-t)^{\beta-1} t^\alpha L_n^{(\alpha)}(t) dt = \Gamma(\alpha + n + 1) \Gamma(\beta) x^{\alpha+\beta} L_n^{(\alpha+\beta)}(x) \quad (\Re\alpha > -1, \Re\beta > 0)$$

22.13.14

$$\int_0^x L_m(t) L_n(x-t) dt = \int_0^x L_{m+n}(t) dt = L_{m+n}(x) - L_{m+n+1}(x)$$

$$22.13.15 \quad \int_0^x e^{-t^2} H_n(t) dt = H_{n-1}(0) - e^{-x^2} H_{n-1}(x)$$

$$22.13.16 \quad \int_0^x H_n(t) dt = \frac{1}{2(n+1)} [H_{n+1}(x) - H_{n+1}(0)]$$

$$22.13.17 \quad \int_{-\infty}^\infty e^{-t^2} H_{2m}(tx) dt = \sqrt{\pi} \frac{(2m)!}{m!} (x^2 - 1)^m$$

22.13.18

$$\int_{-\infty}^\infty e^{-t^2} t H_{2m+1}(tx) dt = \sqrt{\pi} \frac{(2m+1)!}{m!} x(x^2 - 1)^m$$

$$22.13.19 \quad \int_{-\infty}^\infty e^{-t^2} t^n H_n(xt) dt = \sqrt{\pi} n! P_n(x)$$

22.13.20

$$\int_0^\infty e^{-t^2} [H_n(t)]^2 \cos(xt) dt = \sqrt{\pi} 2^{n-1} n! e^{-x^2/2} L_n\left(\frac{x^2}{2}\right)$$

22.14. Inequalities

22.14.1

$$|P_n^{(\alpha, \beta)}(x)| \leq \begin{cases} \binom{n+q}{n} \approx n^q, & \text{if } q = \max(\alpha, \beta) \geq -1/2 \\ & (\alpha > -1, \beta > -1) \\ |P_n^{(\alpha, \beta)}(x')| \approx \sqrt{\frac{1}{n}}, & \text{if } q < -\frac{1}{2} \end{cases}$$

x' maximum point nearest to $\frac{\beta - \alpha}{\alpha + \beta + 1}$

22.14.2

$$|C_n^{(\alpha)}(x)| \leq \begin{cases} \binom{n+2\alpha-1}{n} & (\alpha > 0) \\ |C_n^{(\alpha)}(x')| & \left(-\frac{1}{2} < \alpha < 0\right) \end{cases}$$

$x' = 0$ if $n = 2m$; $x' =$ maximum point nearest zero if $n = 2m + 1$

22.14.3

$$|C_n^{(\alpha)}(\cos \theta)| < 2^{1-\alpha} \frac{n^{\alpha-1}}{(\sin \theta)^\alpha \Gamma(\alpha)} \quad (0 < \alpha < 1, 0 < \theta < \pi)$$

$$22.14.4 \quad |T_n(x)| \leq 1 \quad (-1 \leq x \leq 1)$$

$$22.14.5 \quad \left| \frac{dT_n(x)}{dx} \right| \leq n^2 \quad (-1 \leq x \leq 1)$$

$$22.14.6 \quad |U_n(x)| \leq n + 1 \quad (-1 \leq x \leq 1)$$

$$22.14.7 \quad |P_n(x)| \leq 1 \quad (-1 \leq x \leq 1)$$

$$22.14.8 \quad \left| \frac{dP_n(x)}{dx} \right| \leq \frac{1}{2} n(n+1) \quad (-1 \leq x \leq 1)$$

$$22.14.9 \quad |P_n(x)| \leq \sqrt{\frac{2}{\pi n}} \frac{1}{4\sqrt{1-x^2}} \quad (-1 < x \leq 1)$$

22.14.10

$$P_n^2(x) - P_{n-1}(x)P_{n+1}(x) < \frac{2n+1}{3n(n+1)} \quad (-1 \leq x \leq 1)$$

22.14.11

$$P_n^2(x) - P_{n-1}(x)P_{n+1}(x) \geq \frac{1 - P_n^2(x)}{(2n-1)(n+1)} \quad (-1 \leq x \leq 1)$$

$$22.14.12 \quad |L_n(x)| \leq e^{x/2} \quad (x \geq 0)$$

$$22.14.13 \quad |L_n^{(\alpha)}(x)| \leq \frac{\Gamma(\alpha + n + 1)}{n! \Gamma(\alpha + 1)} e^{x/2} \quad (\alpha \geq 0, x \geq 0)$$

22.14.14

$$|L_n^{(\alpha)}(x)| \leq \left[2 - \frac{\Gamma(\alpha + n + 1)}{n! \Gamma(\alpha + 1)} \right] e^{x/2} \quad (-1 < \alpha < 0, x \geq 0)$$

22.14.15 $|H_{2m}(x)| \leq e^{x^2/2} 2^{2m} m! \left[2 - \frac{1}{2^{2m}} \binom{2m}{m} \right]$

22.14.16 $|H_{2m+1}(x)| \leq x e^{x^2/2} \frac{(2m+2)!}{(m+1)!} \quad (x \geq 0)$

22.14.17 $|H_n(x)| < e^{x^2/2} k 2^{n/2} \sqrt{n!} \quad k \approx 1.086435$

22.15. Limit Relations

22.15.1

$$\lim_{n \rightarrow \infty} \left[\frac{1}{n^\alpha} P_n^{(\alpha, \beta)} \left(\cos \frac{x}{n} \right) \right]$$

$$= \lim_{n \rightarrow \infty} \frac{1}{n^\alpha} P_n^{(\alpha, \beta)} \left(1 - \frac{x^2}{2n^2} \right) = \left(\frac{2}{x} \right)^\alpha J_\alpha(x)$$

22.15.2 $\lim_{n \rightarrow \infty} \left[\frac{1}{n^\alpha} L_n^{(\alpha)} \left(\frac{x}{n} \right) \right] = x^{-\alpha/2} J_\alpha(2\sqrt{x})$

22.15.3 $\lim_{n \rightarrow \infty} \left[\frac{(-1)^n \sqrt{n}}{4^n n!} H_{2n} \left(\frac{x}{2\sqrt{n}} \right) \right] = \frac{1}{\sqrt{\pi}} \cos x$

22.15.4 $\lim_{n \rightarrow \infty} \left[\frac{(-1)^n}{4^n n!} H_{2n+1} \left(\frac{x}{2\sqrt{n}} \right) \right] = \frac{2}{\sqrt{\pi}} \sin x$

22.15.5 $\lim_{\beta \rightarrow \infty} P_n^{(\alpha, \beta)} \left(1 - \frac{2x}{\beta} \right) = L_n^{(\alpha)}(x)$

22.15.6 $\lim_{\alpha \rightarrow \infty} \frac{1}{\alpha^{n/2}} C_n^{(\alpha)} \left(\frac{x}{\sqrt{\alpha}} \right) = \frac{1}{n!} H_n(x)$

For asymptotic expansions, see [22.5] and [22.17].

22.16. Zeros

For tables of the zeros and associated weight factors necessary for the Gaussian-type quadrature formulas see chapter 25. All the zeros of the orthogonal polynomials are real, simple and located in the interior of the interval of orthogonality.

Explicit and Asymptotic Formulas and Inequalities

Notations:

$$x_m^{(n)} \text{ mth zero of } f_n(x) (x_1^{(n)} < x_2^{(n)} < \dots < x_n^{(n)}) \quad \left| \quad j_{\alpha, m}, \text{ mth positive zero of the Bessel function } J_\alpha(x) \right.$$

$$\theta_m^{(n)} = \arccos x_{n-m+1}^{(n)} (0 < \theta_1^{(n)} < \theta_2^{(n)} < \dots < \theta_n^{(n)} < \pi) \quad \left| \quad 0 < j_{\alpha, 1} < j_{\alpha, 2} < \dots \right.$$

	$f_n(x)$	Relation
22.16.1	$P_n^{(\alpha, \beta)}(\cos \theta)$	$\lim_{n \rightarrow \infty} n \theta_m^{(n)} = j_{\alpha, m} \quad (\alpha > -1, \beta > -1)$
22.16.2	$C_n^{(\alpha)}(x)$	$x_m^{(n)} = 1 - \frac{j_{\alpha-1/2, m}^2}{2n^2} \left[1 - \frac{2\alpha}{n} + O\left(\frac{1}{n^2}\right) \right]$
22.16.3	$C_n^{(\alpha)}(\cos \theta)$	$\frac{(m+\alpha-1)\pi}{n+\alpha} \leq \theta_m^{(n)} \leq \frac{m\pi}{n+\alpha} \quad (0 \leq \alpha \leq 1)$
22.16.4	$T_n(x)$	$x_m^{(n)} = \cos \frac{2m-1}{2n} \pi$
22.16.5	$U_n(x)$	$x_m^{(n)} = \cos \frac{m}{n+1} \pi$
22.16.6	$P_n(\cos \theta)$	$\frac{2m-1}{2n+1} \pi \leq \theta_m^{(n)} \leq \frac{2m}{2n+1} \pi$ $\theta_m^{(n)} = \frac{4m-1}{4n+2} \pi + \frac{1}{8n^2} \cot \frac{4m-1}{4n+2} \pi + O(n^{-3})$
22.16.7	$P_n(x)$	$x_m^{(n)} = 1 - \frac{j_{0, m}^2}{2n^2} \left[1 - \frac{1}{n} + O(n^{-2}) \right]$ $x_m^{(n)} = 1 - \frac{4\xi_m^{(n)}}{2n+1+\xi_m^{(n)}}; \xi_m^{(n)} = \frac{j_{0, m}^2}{4n+2} \left[1 + \frac{j_{0, m-2}^2}{12(2n+1)^2} \right] + O\left(\frac{1}{n^5}\right)$
22.16.8	$L_n^{(\alpha)}(x)$	$x_m^{(n)} > \frac{j_{\alpha, m}^2}{4k_n}$ $x_m^{(n)} < \frac{k_m}{k_n} (2k_m + \sqrt{4k_m^2 + \frac{1}{4} - \alpha^2})$ $x_m^{(n)} = \frac{j_{\alpha, m}^2}{4k_n} \left(1 + \frac{2(\alpha^2-1) + j_{\alpha, m}^2}{48k_n^2} \right) + O(n^{-5})$

For error estimates see [22.6].

22.17. Orthogonal Polynomials of a Discrete Variable

In this section some polynomials $f_n(x)$ are listed which are orthogonal with respect to the scalar product

22.17.1 $(f_n, f_m) = \sum_i w^*(x_i) f_n(x_i) f_m(x_i).$

The x_i are the integers in the interval $a \leq x_i \leq b$ and $w^*(x_i)$ is a positive function such that

$\sum_i w^*(x_i)$ is finite. The constant factor which is still free in each polynomial when only the orthogonality condition is given is defined here by the explicit representation (which corresponds to the Rodrigues' formula)

22.17.2 $f_n(x) = \frac{1}{r_n w^*(x)} \Delta^n [w^*(x) g(x, n)]$

where $g(x, n) = g(x)g(x-1) \dots g(x-n+1)$ and $g(x)$ is a polynomial in x independent of n .

Name	a	b	$w^*(x)$	r_n	$g(x, n)$	Remarks
Chebyshev	0	$N-1$	1	$1/n!$	$\binom{x}{n} \binom{x-N}{n}$	
Krawtchouk	0	N	$p^x q^{N-x} \binom{N}{x}$	$(-1)^n n!$	$\frac{q^x x!}{(x-n)!}$	$p, q > 0;$ $p+q=1$
Charlier	0	∞	$\frac{e^{-a} a^x}{x!}$	$(-1)^n \sqrt{a^n n!}$	$\frac{x!}{(x-n)!}$	$a > 0$
Meixner	0	∞	$\frac{c^x \Gamma(b+x)}{\Gamma(b)x!}$	c^n	$\frac{x!}{(x-n)!}$	$b > 0, 0 < c < 1$
Hahn	0	∞	$\frac{\Gamma(b)\Gamma(c+x)\Gamma(d+x)}{x!\Gamma(b+x)\Gamma(c)\Gamma(d)}$	$n!$	$\frac{x!\Gamma(b+x)}{(x-n)!\Gamma(b+x-n)}$	

For a more complete list of the properties of these polynomials see [22.5] and [22.17].

Numerical Methods

22.18. Use and Extension of the Tables

Evaluation of an orthogonal polynomial for which the coefficients are given numerically.

Example 1. Evaluate $L_6(1.5)$ and its first and second derivative using **Table 22.10** and the Horner scheme.

	1	-36	450	-2400	5400	-4320	720
$x=1.5$		1.5	-51.75	597.375	-2703.9375	4044.09375	-413.859375
	1	-34.5	398.25	-1802.625	2696.0625	-275.90625	306.140625
1.5		1.5	-49.5	523.125	-1919.25	1165.21875	$L_6 = \frac{306.140625}{720}$ $= .42519\ 53$
	1	-33.0	348.75	-1279.500	776.8125	889.3125	
1.5		1.5	-47.25	452.250	-1240.875		$L'_6 = \frac{889.3125}{720}$ $= 1.23515\ 625$
	1	-31.5	301.50	-827.250	-464.0625		$L''_6 = 2 \frac{[-464.0625]}{720}$ $= -1.28906\ 25$

Evaluation of an orthogonal polynomial using the explicit representation when the coefficients are not given numerically.

If an isolated value of the orthogonal polynomial $f_n(x)$ is to be computed, use the proper explicit expression rewritten in the form

$$f_n(x) = d_n(x)a_0(x)$$

and generate $a_0(x)$ recursively, where

$$a_{m-1}(x) = 1 - \frac{b_m}{c_m} f(x) a_m(x) \quad (m = n, n-1, \dots, 2, 1, a_n(x) = 1).$$

The $d_n(x)$, b_m , c_m , $f(x)$ for the polynomials of this chapter are listed in the following table:

$f_n(x)$	$d_n(x)$	b_m	c_m	$f(x)$
$P_n^{(\alpha, \beta)}$	$\binom{n+\alpha}{n}$	$(n-m+1)(\alpha+\beta+n+m)$	$2m(\alpha+m)$	$1-x$
$C_{2n}^{(\alpha)}$	$(-1)^n \frac{(\alpha)_n}{n!}$	$2(n-m+1)(\alpha+n+m-1)$	$m(2m-1)$	x^2
$C_{2n+1}^{(\alpha)}$	$(-1)^n \frac{(\alpha)_{n+1}}{n!} 2x$	$2(n-m+1)(\alpha+n+m)$	$m(2m+1)$	x^2
T_{2n}	$(-1)^n$	$2(n-m+1)(n+m-1)$	$m(2m-1)$	x^2
T_{2n+1}	$(-1)^n (2n+1)x$	$2(n-m+1)(n+m)$	$m(2m+1)$	x^2
U_{2n}	$(-1)^n$	$2(n-m+1)(n+m)$	$m(2m-1)$	x^2
U_{2n+1}	$(-1)^n 2(n+1)x$	$2(n-m+1)(n+m+1)$	$m(2m+1)$	x^2
P_{2n}	$\frac{(-1)^n}{4^n} \binom{2n}{n}$	$(n-m+1)(2n+2m-1)$	$m(2m-1)$	x^2
P_{2n+1}	$\frac{(-1)^n}{4^n} \binom{2n+1}{n} (n+1)x$	$(n-m+1)(2n+2m+1)$	$m(2m+1)$	x^2
$L_n^{(\alpha)}$	$\binom{n+\alpha}{n}$	$n-m+1$	$m(\alpha+m)$	x
H_{2n}	$(-1)^n \frac{(2n)!}{n!}$	$2(n-m+1)$	$m(2m-1)$	x^2
H_{2n+1}	$(-1)^n \frac{(2n+1)!}{n!} 2x$	$2(n-m+1)$	$m(2m+1)$	x^2

Example 2. Compute $P_8^{(1/2, 3/2)}(2)$. Here $d_8 = \binom{8.5}{8} = 3.33847$, $f(2) = -1$.

m	8	7	6	5	4	3	2	1	0
a_m	1	1.132353	1.366667	1.841026	3.008392	6.849651	26.44156	223.1091	6545.533
b_m	18	34	48	60	70	78	84	88	90
c_m	136	105	78	55	36	21	10	3	0

$$P_8^{(1/2, 3/2)}(2) = d_8 a_0(2) = (3.33847)(6545.533) = 21852.07$$

Evaluation of orthogonal polynomials by means of their recurrence relations

Example 3. Compute $C_n^{(1)}(2.5)$ for $n=2, 3, 4, 5, 6$.

From **Table 22.2** $C_0^{(1)}=1$, $C_1^{(1)}=1.25$ and from **22.7** the recurrence relation is

$$C_{n+1}^{(1)}(2.5) = [5(n+\frac{1}{2})C_n^{(1)}(2.5) - (n-\frac{1}{2})C_{n-1}^{(1)}(2.5)] \frac{1}{n+1}$$

n	2	3	4	5	6
$C_n^{(1)}(2.5)$	3.65625	13.08594	50.87648	207.0649	867.7516

Check: Compute $C_6^{(1)}(2.5)$ by the method of **Example 2**.

Change of Interval of Orthogonality

In some applications it is more convenient to use polynomials orthogonal on the interval $[0, 1]$. One can obtain the new polynomials from the ones given in this chapter by the substitution $x=2\bar{x}-1$. The coefficients of the new polynomial can be computed from the old by the following recursive scheme, provided the standardization is not changed. If

$$f_n(x) = \sum_{m=0}^n a_m x^m, \quad f_n^*(x) = f_n(2x-1) = \sum_{m=0}^n a_m^* x^m$$

then the a_m^* are given recursively by the a_m through the relations

$$a_m^{(j)} = 2a_m^{(j-1)} - a_{m+1}^{(j)}; \quad m=n-1, n-2, \dots, j; \quad j=0, 1, 2, \dots, n$$

$$a_m^{(-1)} = a_m/2, \quad m=0, 1, 2, \dots, n$$

$$a_n^{(j)} = 2^j a_n, \quad j=0, 1, 2, \dots, n \text{ and } a_m^{(m)} = a_m^*; \quad m=0, 1, 2, \dots, n.$$

Example 4. Given $T_5(x) = 5x - 20x^3 + 16x^5$, find $T_5^*(x)$.

$m \backslash j$	5	4	3	2	1	0
-1	$8 = a_5^{(-1)}$	0	$-10 = a_3^{(-1)}$	0	$2.5 = a_1^{(-1)}$	0
0	16	-16	-4	4	1	$-1 = a_0$
1	32	-64	56	-48	$50 = a_1^*$	
2	64	-192	304	$-400 = a_2^*$		
3	128	-512	$1120 = a_3^*$			
4	256	$-1280 = a_4^*$				
5	$512 = a_5^*$					

Hence, $T_5^*(x) = 512x^5 - 1280x^4 + 1120x^3 - 400x^2 + 50x - 1$.

22.19. Least Square Approximations

Problem: Given a function $f(x)$ (analytically or in form of a table) in a domain D (which may be a continuous interval or a set of discrete points).² Approximate $f(x)$ by a polynomial $F_n(x)$ of given degree n such that a weighted sum of the squares of the errors in D is least.

Solution: Let $w(x) \geq 0$ be the weight function chosen according to the relative importance of the errors in different parts of D . Let $f_m(x)$ be orthogonal polynomials in D relative to $w(x)$, i.e. $(f_m, f_n) = 0$ for $m \neq n$, where

$$(f, g) = \begin{cases} \int_D w(x)f(x)g(x)dx & \text{if } D \text{ is a continuous interval} \\ \sum_{m=1}^N w(x_m)f(x_m)g(x_m) & \text{if } D \text{ is a set of } N \text{ discrete points } x_m. \end{cases}$$

Then

$$F_n(x) = \sum_{m=0}^n a_m f_m(x)$$

where

$$a_m = (f, f_m) / (f_m, f_m).$$

² $f(x)$ has to be square integrable, see e.g. [22.17].

*See page II.

D a Continuous Interval

Example 5. Find a least square polynomial of degree 5 for $f(x) = \frac{1}{1+x}$, in the interval $2 \leq x \leq 5$, using the weight function

$$w(x) = \frac{1}{\sqrt{(x-2)(5-x)}}$$

which stresses the importance of the errors at the ends of the interval.

Reduction to interval $[-1, 1]$, $t = \frac{2x-7}{3}$

$$w(x(t)) = \frac{2}{3} \frac{1}{\sqrt{1-t^2}}$$

From 22.2, $f_m(t) = T_m(t)$ and

$$a_m = \frac{4}{3\pi} \int_{-1}^1 \frac{1}{\sqrt{1-t^2}} \frac{1}{t+3} T_m(t) dt \quad (m \neq 0)$$

$$a_0 = \frac{2}{3\pi} \int_{-1}^1 \frac{1}{\sqrt{1-t^2}} \frac{dt}{t+3}$$

Evaluating the integrals numerically we get

$$\frac{1}{1+x} \sim .235703 - .080880T_1\left(\frac{2x-7}{3}\right) + .013876T_2\left(\frac{2x-7}{3}\right) - .002380T_3\left(\frac{2x-7}{3}\right) \\ + .000408T_4\left(\frac{2x-7}{3}\right) - .000070T_5\left(\frac{2x-7}{3}\right)$$

D a Set of Discrete Points

If $x_m = m (m=0, 1, 2, \dots, N)$ and $w(x)=1$, use the Chebyshev polynomials in the discrete range 22.17. It is convenient to introduce here a slightly different standardization such that

$$f_n(x) = \sum_{m=0}^n (-1)^m \binom{n}{m} \binom{n+m}{m} \frac{x!(N-m)!}{(x-m)!N!}$$

$$(f_n, f_n) = \frac{(N+n+1)!(N-n)!}{(2n+1)(N!)^2}$$

Recurrence relation: $f_0(x)=1, f_1(x)=1 - \frac{2x}{N}$

$$(n+1)(N-n)f_{n+1}(x) = (2n+1)(N-2x)f_n(x) - n(N+n+1)f_{n-1}(x)$$

Example 6. Approximate in the least square sense the function $f(x)$ given in the following table by a third degree polynomial.

x	$f(x)$	$\bar{x} = \frac{x-10}{2}$	$f_0(\bar{x})$	$f_1(\bar{x})$	$f_2(\bar{x})$	$f_3(\bar{x})$
10	.3162	0	1	1	1	1
12	.2887	1	1	1/2	-1/2	-2
14	.2673	2	1	0	-1	0
16	.2500	3	1	-1/2	-1/2	2
18	.2357	4	1	-1	1	-1

	$f_0(\bar{x})$	$f_1(\bar{x})$	$f_2(\bar{x})$	$f_3(\bar{x})$
$(f_n, f_n) = \sum_{\bar{x}=0}^4 f_n^2(\bar{x})$	5	2.5	3.5	10
$(f, f_n) = \sum_{\bar{x}=0}^4 f_n(\bar{x})f(2\bar{x}+10)$	1.3579	.09985	.01525	.0031
$a_n = \frac{(f, f_n)}{(f_n, f_n)}$.271580	.039940	.0043571	.000310

$$f(x) \sim .27158 + .03994(3.5 - .25x) + .0043571(23.5 - 3.5x + .125x^2) + .00031(266 - 59.8333x \\ + 4.375x^2 - .10417x^3)$$

$$f(x) \sim .59447 - .043658x + .0019009x^2 - .000032292x^3$$

22.20. Economization of Series

Problem: Given $f(x) = \sum_{m=0}^n a_m x^m$ in the interval $-1 \leq x \leq 1$ and $R > 0$. Find $\bar{f}(x) = \sum_{m=0}^N b_m x^m$ with N as small as possible, such that $|\bar{f}(x) - f(x)| < R$.

Solution: Express $f(x)$ in terms of Chebyshev polynomials using Table 22.3,

$$f(x) = \sum_{m=0}^n b_m T_m(x)$$

Then, since $|T_m(x)| \leq 1 (-1 \leq x \leq 1)$

$$\bar{f}(x) = \sum_{m=0}^N b_m T_m(x)$$

within the desired accuracy if

$$\sum_{m=N+1}^n |b_m| < R$$

$\bar{f}(x)$ is evaluated most conveniently by using the recurrence relation (see 22.7).

Example 7. Economize $f(x) = 1 + x/2 + x^2/3 + x^3/4 + x^4/5 + x^5/6$ with $R = .05$.

From Table 22.3

$$f(x) = \frac{1}{120} [149T_0(x) + 32T_2(x) + 3T_4(x) + \frac{1}{96} [76T_1(x) + 11T_3(x) + T_5(x)]]$$

so

$$\bar{f}(x) = \frac{1}{120} [149T_0(x) + 32T_2(x)] + \frac{1}{96} [76T_1(x) + 11T_3(x)]$$

since

$$|\bar{f}(x) - f(x)| \leq \frac{1}{40} + \frac{1}{96} < .05$$

References

Texts

- [22.1] Bibliography on orthogonal polynomials, Bull. of the National Research Council No. 103, Washington, D.C. (1940).
- [22.2] P. L. Chebyshev, Sur l'interpolation. Oeuvres, vol. 2, pp. 59-68.
- [22.3] R. Courant and D. Hilbert, Methods of mathematical physics, vol. 1, ch. 7 (Interscience Publishers, New York, N.Y., 1953).
- [22.4] G. Doetsch, Die in der Statistik seltener Ereignisse auftretenden Charlierschen Polynome und eine damit zusammenhängende Differential-differenzgleichung, Math. Ann. **109**, 257-266 (1934).
- [22.5] A. Erdélyi et al., Higher transcendental functions, vol. 2, ch. 10 (McGraw-Hill Book Co., Inc., New York, N.Y., 1953).
- [22.6] L. Gatteschi, Limitazione degli errori nelle formule asintotiche per le funzioni speciali, Rend. Sem. Mat. Univ. Torina **16**, 83-94 (1956-57).
- [22.7] T. L. Geronimus, Teoria ortogonalnikh mnogochlenov (Moscow, U.S.S.R., 1950).
- [22.8] W. Hahn, Über Orthogonalpolynome, die q-Differenzgleichungen genügen, Math. Nachr. **2**, 4-34 (1949).
- [22.9] St. Kaczmarz and H. Steinhaus, Theorie der Orthogonalreihen, ch. 4 (Chelsea Publishing Co., New York, N.Y., 1951).
- [22.10] M. Krawtchouk, Sur une généralisation des polynomes d'Hermite, C.R. Acad. Sci. Paris **187**, 620-622 (1929).
- [22.11] C. Lanczos, Trigonometric interpolation of empirical and analytical functions, J. Math. Phys. **17**, 123-199 (1938).
- [22.12] C. Lanczos, Applied analysis (Prentice-Hall, Inc., Englewood Cliffs, N.J., 1956).
- [22.13] W. Magnus and F. Oberhettinger, Formeln und Sätze für die speziellen Funktionen der mathematischen Physik, ch. 5, 2d ed. (Springer-Verlag, Berlin, Germany, 1948).

- [22.14] J. Meixner, Orthogonale Polynomsysteme mit einer besonderen Gestalt der erzeugenden Funktion, J. London Math. Soc. **9**, 6-13 (1934).
- [22.15] G. Sansone, Orthogonal functions, Pure and Applied Mathematics, vol. IX (Interscience Publishers, New York, N.Y., 1959).
- [22.16] J. Shohat, Théorie générale des polynomes orthogonaux de Tchebichef, Mém. Soc. Math. **66** (Gauthier-Villars, Paris, France, 1934).
- [22.17] G. Szegő, Orthogonal polynomials, Amer. Math. Soc. Colloquium Publications **23**, rev. ed. (1959).
- [22.18] F. G. Tricomi, Vorlesungen über Orthogonalreihen, chs. 4, 5, 6 (Springer-Verlag, Berlin, Germany, 1955).

Tables

- [22.19] British Association for the Advancement of Science, Legendre Polynomials, Mathematical Tables, Part vol. A (Cambridge Univ. Press, Cambridge, England, 1946). $P_n(x)$, $x=0(.01)6$, $n=1(1)12$, 7-8D.
- [22.20] N. R. Jörgensen, Undersøgelser over frekvensflader og korrelation (Busck, Copenhagen, Denmark, 1916). $He_n(x)$, $x=0(.01)4$, $n=1(1)6$, exact.
- [22.21] L. N. Karmazina, Tablitsy polinomov Jacobi (Izdat. Akad. Nauk SSSR., Moscow, U.S.S.R., 1954). $G_n(p, q, x)$, $x=0(.01)1$, $q=.1(1)1$, $p=1.1(1)3$, $n=1(1)5$, 7D.
- [22.22] National Bureau of Standards, Tables of Chebyshev polynomials $S_n(x)$ and $C_n(x)$, Applied Math. Series 9 (U.S. Government Printing Office, Washington, D.C., 1952). $x=0(.001)2$, $n=2(1)12$, 12D; Coefficients for $T_n(x)$, $U_n(x)$, $C_n(x)$, $S_n(x)$ for $n=0(1)12$.
- [22.23] J. B. Russel, A table of Hermite functions, J. Math. Phys. **12**, 291-297 (1933). $e^{-x^2/2}H_n(x)$, $x=0(.04)1(1)4(2)7(.5)8$, $n=0(1)11$, 5D.
- [22.24] N. Wiener, Extrapolation, interpolation and smoothing of stationary time series (John Wiley & Sons, Inc., New York, N.Y., 1949). $L_n(x)$, $n=0(1)5$, $x=0(.01).1(1)18(.2)20(.5)21(1)26(2)30$, 3-5D.

Coefficients for the Jacobi Polynomials $P_n^{(\alpha, \beta)}(x) = a_n^{-1} \sum_{m=0}^n c_m (x-1)^m$

Table 22.1

a_n	$(x-1)^0$	$(x-1)^1$	$(x-1)^2$	$(x-1)^3$	$(x-1)^4$	$(x-1)^5$	$(x-1)^6$
$P_0^{(\alpha, \beta)}$	1	1					
$P_1^{(\alpha, \beta)}$	2	$2(\alpha+1)$	$\alpha+\beta+2$				
$P_2^{(\alpha, \beta)}$	8	$4(\alpha+1)_2$	$4(\alpha+\beta+3)(\alpha+2)$	$(\alpha+\beta+3)_2$			
$P_3^{(\alpha, \beta)}$	48	$8(\alpha+1)_3$	$12(\alpha+\beta+4)(\alpha+2)_2$	$6(\alpha+\beta+4)_2(\alpha+3)$	$(\alpha+\beta+4)_3$		
$P_4^{(\alpha, \beta)}$	384	$16(\alpha+1)_4$	$32(\alpha+\beta+5)(\alpha+2)_3$	$24(\alpha+\beta+5)_2(\alpha+3)_2$	$8(\alpha+\beta+5)_3(\alpha+4)$	$(\alpha+\beta+5)_4$	
$P_5^{(\alpha, \beta)}$	3840	$32(\alpha+1)_5$	$80(\alpha+\beta+6)(\alpha+2)_4$	$80(\alpha+\beta+6)_2(\alpha+3)_3$	$40(\alpha+\beta+6)_3(\alpha+4)_2$	$10(\alpha+\beta+6)_4(\alpha+5)$	$(\alpha+\beta+6)_5$
$P_6^{(\alpha, \beta)}$	46080	$64(\alpha+1)_6$	$192(\alpha+\beta+7)(\alpha+2)_5$	$240(\alpha+\beta+7)_2(\alpha+3)_4$	$160(\alpha+\beta+7)_3(\alpha+4)_3$	$60(\alpha+\beta+7)_4(\alpha+5)_2$	$12(\alpha+\beta+7)_5(\alpha+6)$ $(\alpha+\beta+7)_6$

$$(m)_n = m(m+1)(m+2) \dots (m+n-1)$$

$$P_5^{(1,1)}(x) = \frac{1}{3840} [(8)_5(x-1)^5 + 10(8)_4(6)(x-1)^4 + 40(8)_3(5)_2(x-1)^3 + 80(8)_2(4)_3(x-1)^2 + 80(8)(3)_4(x-1) + 32(2)_5]$$

$$P_6^{(1,1)}(x) = \frac{1}{3840} [95040(x-1)^6 + 475200(x-1)^5 + 864000(x-1)^4 + 691200(x-1)^3 + 230400(x-1)^2 + 230400(x-1) + 23040]$$

Table 22.2

Coefficients for the Ultraspherical Polynomials $C_n^{(\alpha)}(x)$ and for x^n in terms of $C_m^{(\alpha)}(x)$

$$C_n^{(\alpha)}(x) = a_n^{-1} \sum_{m=0}^n c_m x^m \quad \text{and} \quad x^n = b_n^{-1} \sum_{m=0}^n d_m C_m^{(\alpha)}(x) \quad (\alpha \neq 0)$$

		x^0	x^1	x^2	x^3	x^4	x^5	x^6	
	b_n	1	2α	$2(\alpha)_2$	$4(\alpha)_3$	$4(\alpha)_4$	$8(\alpha)_5$	$8(\alpha)_6$	
$C_0^{(\alpha)}$	a_n 1	1 1		α		$3\alpha(\alpha+3)$		$15\alpha(\alpha+4)(\alpha+5)$	$C_0^{(\alpha)}$
$C_1^{(\alpha)}$	1		2α 1		$3(\alpha+1)$		$15(\alpha+1)(\alpha+4)$		$C_1^{(\alpha)}$
$C_2^{(\alpha)}$	1	$-\alpha$		$2(\alpha)_2$ 1		$6(\alpha+2)$		$45(\alpha+2)(\alpha+5)$	$C_2^{(\alpha)}$
$C_3^{(\alpha)}$	3		$-6(\alpha)_2$		$4(\alpha)_3$ 3		$30(\alpha+3)$		$C_3^{(\alpha)}$
$C_4^{(\alpha)}$	6	$3(\alpha)_2$		$-12(\alpha)_3$		$4(\alpha)_4$ 6		$90(\alpha+4)$	$C_4^{(\alpha)}$
$C_5^{(\alpha)}$	15		$15(\alpha)_3$		$-20(\alpha)_4$		$4(\alpha)_5$ 30		$C_5^{(\alpha)}$
$C_6^{(\alpha)}$	90	$-15(\alpha)_3$		$90(\alpha)_4$		$-60(\alpha)_5$		$8(\alpha)_6$ 90	$C_6^{(\alpha)}$
		x^0	x^1	x^2	x^3	x^4	x^5	x^6	

$$(\alpha)_n = \alpha(\alpha+1)(\alpha+2) \dots (\alpha+n-1)$$

$$C_3^{(2)}(x) = \frac{1}{3} [4(2)_2 x^3 - 6(2)_2 x] \quad x^3 = \frac{1}{4(2)_3} [3(3)C_1^{(2)}(x) + 3C_3^{(2)}(x)]$$

$$C_5^{(2)}(x) = \frac{1}{3} [96x^5 - 36x] \quad x^5 = \frac{1}{96} [9C_1^{(2)}(x) + 3C_5^{(2)}(x)]$$

Table 22.3

Coefficients for the Chebyshev Polynomials $T_n(x)$ and for x^n in terms of $T_m(x)$

$$T_n(x) = \sum_{m=0}^n c_m x^m \quad x^n = b_n^{-1} \sum_{m=0}^n d_m T_m(x)$$

	x^0	x^1	x^2	x^3	x^4	x^5	x^6	x^7	x^8	x^9	x^{10}	x^{11}	x^{12}	
b_n	1	1	2	4	8	16	32	64	128	256	512	1024	2048	
T_0	1	1		1		3		10		35		126		462
T_1		1	1		3		10		35		126		462	
T_2	-1		2	1		4		15		56		210		792
T_3		-3		4	1		5		21		84		330	
T_4	1		-8		8	1		6		28		120		495
T_5		5		-20		16	1		7		36		165	
T_6	-1		18		-48		32	1		8		45		220
T_7		-7		56		-112		64	1		9		55	
T_8	1		-32		160		-256		128	1		10		66
T_9		9		-120		432		-576		256	1		11	
T_{10}	-1		50		-400		1120		-1280		512	1		12
T_{11}		-11		220		-1232		2816		-2816		1024	1	
T_{12}	1		-72		840		-3584		6912		-6144		2048	1
	x^0	x^1	x^2	x^3	x^4	x^5	x^6	x^7	x^8	x^9	x^{10}	x^{11}	x^{12}	

$$T_5(x) = 32x^5 - 48x^4 + 18x^2 - 1 \quad x^6 = \frac{1}{32} [10T_6 + 15T_2 + 6T_4 + T_6]$$

Chebyshev Polynomials $T_n(x)$

Table 22.4

$n \backslash x$	0.2	0.4	0.6	0.8	1.0
0	+1.0000 0000	+1.0000 0000	+1.0000 0000	+1.0000 0000	1
1	+0.2000 0000	+0.4000 0000	+0.6000 0000	+0.8000 0000	1
2	-0.9200 0000	-0.6800 0000	-0.2800 0000	+0.2800 0000	1
3	-0.5680 0000	-0.9440 0000	-0.9360 0000	-0.3520 0000	1
4	+0.6928 0000	-0.0752 0000	-0.8432 0000	-0.8432 0000	1
5	+0.8451 2000	+0.8838 4000	-0.0758 4000	-0.9971 2000	1
6	-0.3547 5000	+0.7827 2000	+0.7521 9000	-0.7521 9000	1
7	-0.9870 2000	-0.2580 2000	+0.9784 7000	-0.2063 8000	1
8	-0.0400 5000	-0.9886 8000	+0.4219 7000	+0.4219 7000	1
9	+0.9709 9000	-0.5329 2000	-0.4721 0000	+0.8815 4000	1
10	+0.4284 5000	+0.5623 4000	-0.9884 9000	+0.9884 9000	1
11	-0.7996 1000	+0.9828 0000	-0.7140 9000	+0.7000 5000	1
12	-0.7483 0000	+0.2238 9000	+0.1315 8000	+0.1315 8000	1

Table 22.5

Coefficients for the Chebyshev Polynomials $U_n(x)$ and for x^n in terms of $U_m(x)$

$$U_n(x) = \sum_{m=0}^n c_m x^m \quad x^n = b_n^{-1} \sum_{m=0}^n d_m U_m(x)$$

	x^0	x^1	x^2	x^3	x^4	x^5	x^6	x^7	x^8	x^9	x^{10}	x^{11}	x^{12}	
b_n	1	2	4	8	16	32	64	128	256	512	1024	2048	4096	
U_0	1	1		1		2		5		14		42		U_0
U_1		2	1			5		14		42		132		U_1
U_2	-1		4	1		9		28		90		297		U_2
U_3		-4		8	1		4		14		48		165	U_3
U_4	1		-12		16	1		5		20		75		U_4
U_5		6		-32		32	1		6		27		110	U_5
U_6	-1		24		-80		64	1		7		35		U_6
U_7		-8		80		-192		128	1		8		44	U_7
U_8	1		-40		240		-448		256	1		9		U_8
U_9		10		-160		672		-1024		512	1		10	U_9
U_{10}	-1		60		-560		1792		-2304		1024	1		U_{10}
U_{11}		-12		280		-1792		4608		-5120		2048	1	U_{11}
U_{12}	1		-84		1120		-5376		11520		-11264		4096	U_{12}
	x^0	x^1	x^2	x^3	x^4	x^5	x^6	x^7	x^8	x^9	x^{10}	x^{11}	x^{12}	

$$U_6(x) = 64x^6 - 80x^4 + 24x^2 - 1 \quad x^6 = \frac{1}{64} [5U_0 + 9U_2 + 5U_4 + U_6]$$

Table 22.6

Chebyshev Polynomials $U_n(x)$

$n \setminus x$	0.2	0.4	0.6	0.8	1.0
0	+1.0000 0000	+1.0000 0000	+1.0000 0000	+1.0000 0000	1
1	+0.4000 0000	+0.8000 0000	+1.2000 0000	+1.6000 0000	2
2	-0.8400 0000	-0.3600 0000	+0.4400 0000	+1.5600 0000	3
3	-0.7360 0000	-1.0880 0000	-0.6720 0000	+0.8960 0000	4
4	+0.5456 0000	-0.5104 0000	-1.2464 0000	-0.1264 0000	5
5	+0.95424 0000	+0.67968 0000	-0.82368 0000	-1.09824 0000	6
6	-0.16390 4000	+1.05414 4000	+0.25798 4000	-1.63078 4000	7
7	-1.01980 1600	+0.16363 5200	+1.13326 0800	-1.51101 4400	8
8	-0.24401 6640	-0.92323 5840	+1.10192 8960	-0.78683 9040	9
9	+0.92219 4944	-0.90222 3872	+0.18905 3952	+0.25207 1936	10
10	+0.61289 46176	+0.20145 67424	-0.87506 42176	+1.19015 41376	11
11	-0.67703 70970	+1.06338 92659	-1.23913 10131	+1.65217 46842	12
12	-0.88370 94564	+0.64925 46703	-0.61189 29981	+1.45332 53571	13

Table 22.7

Coefficients for the Chebyshev Polynomials $C_n(x)$ and for x^n in terms of $C_m(x)$

$$C_n(x) = \sum_{m=0}^n c_m x^m \quad x^n = b_n^{-1} \sum_{m=0}^n d_m C_m(x)$$

	x^0	x^1	x^2	x^3	x^4	x^5	x^6	x^7	x^8	x^9	x^{10}	x^{11}	x^{12}		
b_n	2	1	1	1	1	1	1	1	1	1	1	1	1		
C_0	2	1		1		3		10		35		126		462	C_0
C_1		1	1		3		10		35		126		462		C_1
C_2	-2		1	1		4		15		56		210		792	C_2
C_3		-3		1	1		5		21		84		330		C_3
C_4	2		-4		1	1		6		28		120		495	C_4
C_5^*		5		-5		1	1		7		36		165		C_5
C_6	-2		9		-6		1	1		8		45		220	C_6
C_7		-7		14		-7		1	1		9		55		C_7
C_8	2		-16		20		-8		1	1		10		66	C_8
C_9		9		-30		27		-9		1	1		11		C_9
C_{10}	-2		25		-50		35		-10		1	1		12	C_{10}
C_{11}		-11		55		-77		44		-11		1	1		C_{11}
C_{12}	2		-36		105		-112		54		-12		1	1	C_{12}
	x^0	x^1	x^2	x^3	x^4	x^5	x^6	x^7	x^8	x^9	x^{10}	x^{11}	x^{12}		

*

*See page II.

$$C_6(x) = x^6 - 6x^4 + 9x^2 - 2 \quad x^6 = 10C_0 + 15C_2 + 6C_4 + C_6$$

Table 22.8

Coefficients for the Chebyshev Polynomials $S_n(x)$ and for x^n in terms of $S_m(x)$

$$S_n(x) = \sum_{m=0}^n c_m x^m \quad x^n = \sum_{m=0}^n d_m S_m(x)$$

	x^0	x^1	x^2	x^3	x^4	x^5	x^6	x^7	x^8	x^9	x^{10}	x^{11}	x^{12}		
S_0	1	1		1		2		5		14		42		132	S_0
S_1		1	1		2		5		14		42		132		S_1
S_2	-1		1	1		3		9		28		90		297	S_2
S_3		-2		1	1		4		14		48		165		S_3
S_4	1		-3		1	1		5		20		75		275	S_4
S_5		3		-4		1	1		6		27		110		S_5
S_6	-1		6		-5		1	1		7		35		154	S_6
S_7		-4		10		-6		1	1		8		44		S_7
S_8	1		-10		15		-7		1	1		9		54	S_8
S_9		5		-20		21		-8		1	1		10		S_9
S_{10}	-1		15		-35		28		-9		1	1		11	S_{10}
S_{11}		-6		35		-56		36		-10		1	1		S_{11}
S_{12}	1		-21		70		-84		45		-11		1	1	S_{12}
	x^0	x^1	x^2	x^3	x^4	x^5	x^6	x^7	x^8	x^9	x^{10}	x^{11}	x^{12}		

$$S_6(x) = x^6 - 5x^4 + 6x^2 - 1 \quad x^6 = 5S_0 + 9S_2 + 5S_4 + S_6$$

*See page II.

Table 22.9

Coefficients for the Legendre Polynomials $P_n(x)$ and for x^n in terms of $P_m(x)$

$$P_n(x) = a_n^{-1} \sum_{m=0}^n c_m x^m \quad x^n = b_n^{-1} \sum_{m=0}^n d_m P_m(x)$$

		x^0	x^1	x^2	x^3	x^4	x^5	x^6	x^7	x^8	x^9	x^{10}	x^{11}	x^{12}		
	$a_n \ b_n$	1	1	3	5	35	63	231	429	6435	12155	46189	88179	676039	b_n	
P_0	1	1	1	1		7		33		715		4199		52003	P_0	
P_1	1		1	1		3		27		143		3315		20349	P_1	
P_2	2	-1		3	2		20		110		2600		16150		P_2	
P_3	2		-3		5	2		28		182		4760		31654	P_3	
P_4	8	3		-30		35	8		72		2160		15504		P_4	
P_5	8		15		-70		63	8		88		2992		23408	P_5	
P_6	16	-5		105		-315		231	16		832		7904		P_6	
P_7	16		-35		315		-693		429	16		960		10080	P_7	
P_8	128	35		-1260		6930		-12012		6435	128		2176		P_8	
P_9	128		315		-4620		18018		-25740		12155	128		2432	P_9	
P_{10}	256	-63		3465		-30030		90090		-109395		46189	256		P_{10}	
P_{11}	256		-693		15015		-90090		218790		-230945		88179	256	P_{11}	
P_{12}	1024	231		-18018		225225		-1021020		2078505		-1939938		676039	1024	P_{12}
		x^0	x^1	x^2	x^3	x^4	x^5	x^6	x^7	x^8	x^9	x^{10}	x^{11}	x^{12}		

$$P_6(x) = \frac{1}{16} [231x^6 - 315x^4 + 105x^2 - 5] \quad x^6 = \frac{1}{231} [33P_0 + 110P_2 + 72P_4 + 16P_6]$$

For values of $P_n(x)$, see chapter 8.

Coefficients for the Laguerre Polynomials $L_n(x)$ and for x^n in terms of $L_m(x)$

Table 22.10

$$L_n(x) = a_n^{-1} \sum_{m=0}^n c_m x^m \quad x^n = \sum_{m=0}^n d_m L_m(x)$$

	a_n	x^0	x^1	x^2	x^3	x^4	x^5	x^6	x^7	x^8	x^9	x^{10}	x^{11}	x^{12}		
L_0	1	1	1	2	6	24	120	720	5040	40320	362880	3628800	39916800	479001600	L_0	
L_1	1	1	-1	-1	-4	-18	-96	-600	-4320	-35280	-322560	-3265920	-36288000	-439084800	-5748019200	L_1
L_2	2	2	-4	1	2	18	144	1200	10800	105840	1128960	13063680	163296000	2195424000	31614105600	L_2
L_3	6	6	-18	9	-1	-6	-96	-1200	-14400	-176400	-2257920	-30481920	-435456000	-6586272000	-105380352000	L_3
L_4	24	24	-96	72	-16	1	24	600	10800	176400	2822400	45722880	762048000	13172544000	237105792000	L_4
L_5	120	120	-600	600	-200	25	-1	-120	-4320	-105840	-2257920	-45722880	-914457600	-18441561600	-379369267200	L_5
L_6	720	720	-4320	5400	-2400	450	-36	1	720	35280	1128960	30481920	762048000	18441561600	442597478400	L_6
L_7	5040	5040	-35280	52920	-29400	7350	-882	49	-1	-5040	-322560	-13063680	-435456000	-13172544000	-379369267200	L_7
L_8	40320	40320	-322560	564480	-376320	117600	-18816	1568	-64	1	40320	3269520	163296000	6586272000	237105792000	L_8
L_9	362880	362880	-3265920	6631840	-5080320	1905120	-381024	42336	-2592	81	-1	-362880	-36288000	-2195424000	-105380352000	L_9
L_{10}	3628800	3628800	-36288000	81648000	-72576000	31752000	-7620480	1058400	-86400	4050	-100	1	3628800	439084800	31614105600	L_{10}
L_{11}	39916800	39916800	-439084800	1097712000	-1097712000	548856000	-153679680	25613280	-2613600	163350	-6050	121	-1	-39916800	-5748019200	L_{11}
L_{12}	479001600	479001600	-5748019200	15807052800	-17563392000	9679408000	-3161410560	614718720	-75271680	5880600	-290400	8712	-144	1	479001600	L_{12}
	a_n	x^0	x^1	x^2	x^3	x^4	x^5	x^6	x^7	x^8	x^9	x^{10}	x^{11}	x^{12}		

$$L_6(x) = \frac{1}{720} [x^6 - 36x^5 + 450x^4 - 2400x^3 + 5400x^2 - 4320x + 720]$$

$$x^6 = 720L_0 - 4320L_1 + 10800L_2 - 14400L_3 + 10800L_4 - 4320L_5 + 720L_6$$

Table 22.11

Laguerre Polynomials $L_n(x)$

$n \backslash x$	0.5	1.0	3.0	5.0	10.0
0	+1.0000 00000	+1.0000 00000	+1.0000 00000	+1.0000 00000	+1.0000 00000
1	+0.50000 00000	0.00000 00000	-2.00000 00000	-4.00000 00000	-9.00000 00000
2	+0.12500 00000	-0.50000 00000	-0.50000 00000	+3.50000 00000	+31.00000 00000
3	-0.14583 33333	-0.66666 66667	+1.00000 00000	+2.66666 66667	-45.66666 66667
4	-0.33072 91667	-0.62500 00000	+1.37500 00000	-1.29166 66667	+11.00000 00000
5	-0.44557 29167	-0.46666 66667	+0.85000 00000	-3.16666 66667	+34.33333 33333
6	-0.50414 49653	-0.25694 44444	-0.01250 00000	-2.09027 77778	-3.44444 44444
7	-0.51833 92237	-0.04047 91905	-0.74642 85714	+0.32539 68254	-30.90476 19048
8	-0.49836 29984	+0.15399 30556	-1.10870 53571	+2.23573 90873	-16.30158 73016
9	-0.45291 95204	+0.30974 42681	-1.06116 07143	+2.69174 38272	+14.79188 71252
10	-0.38937 44141	+0.41894 59325	-0.70002 23214	+1.75627 61795	+27.98412 69841
11	-0.31390 72988	+0.48013 41791	-0.18079 95130	+0.10754 36909	+14.53695 68703
12	-0.23164 96389	+0.49621 22235	+0.34035 46063	-1.44860 42948	-9.90374 64593

Coefficients for the Hermite Polynomials $H_n(x)$ and for x^n in terms of $H_m(x)$

Table 22.12

$$H_n(x) = \sum_{m=0}^n c_m x^m \quad x^n = b_n^{-1} \sum_{m=0}^n d_m H_m(x)$$

	x^0	x^1	x^2	x^3	x^4	x^5	x^6	x^7	x^8	x^9	x^{10}	x^{11}	x^{12}	
b_n	1	2	4	8	16	32	64	128	256	512	1024	2048	4096	b_n
H_0	1 1		2		12		120		1680		* 30240		665280	H_0
H_1		2 1		6		60		840		15120		332640		H_1
H_2	-2		4 1		12		180		3360		75600		1995840	H_2
H_3		-12		8 1		20		420		10080		277200		H_3
H_4	12		-48		16 1		30		840		25200		831600	H_4
H_5		120		-160		32 1		42		1512		55440		H_5
H_6	-120		720		-480		64 1		56		2520		110880	H_6
H_7		-1680		3360		-1344		128 1		72		3960		H_7
H_8	1680		-13440		13440		-3584		256 1		90		5940	H_8
H_9		30240		-80640		48384		-9216		512 1		110		H_9
H_{10}	-30240		302400		-403200		161280		-23040		1024 1		132	H_{10}
H_{11}		-665280		2217600		-1774080		506880		-56320		2048 1		H_{11}
H_{12}	665280		-7983360		13305600		-7096320		1520640		-135168		4096 1	H_{12}
	x^0	x^1	x^2	x^3	x^4	x^5	x^6	x^7	x^8	x^9	x^{10}	x^{11}	x^{12}	

$$H_6(x) = 64x^6 - 480x^4 + 720x^2 - 120$$

$$x^6 = \frac{1}{64} (120H_0 + 180H_2 + 30H_4 + H_6)$$

*See page II.

Table 22.13

Hermite Polynomials $H_n(x)$

$n \backslash x$	0.5	1.0	3.0	5.0	10.0
0	+1.00000	+1.00000	+1.00000 00	1.00000 00000	1.00000 00000
1	+1.00000	+2.00000	+6.00000 00	(1)1.00000 00000	(1)2.00000 00000
2	-1.00000	+2.00000	(1)+3.40000 00	(1)9.80000 00000	(2)3.98000 00000
3	-5.00000	-4.00000	(2)+1.80000 00	(2)9.40000 00000	(3)7.88000 00000
4	+1.00000	(1)-2.00000	(2)+8.76000 00	(3)8.81200 00000	(5)1.55212 00000
5	(1)+4.10000	(0)-8.00000	(3)+3.81600 00	(4)8.06000 00000	(6)3.04120 00000
6	(1)+3.10000	(2)+1.84000	(4)+1.41360 00	(5)7.17880 00000	(7)5.92718 80000
7	(2)-4.61000	(2)+4.64000	(4)+3.90240 00	(6)6.21160 00000	(9)1.14894 32000
8	(2)-8.95000	(3)-1.64800	(4)+3.62400 00	(7)5.20656 80000	(10)2.21490 57680
9	(3)+6.48100	(4)-1.07200	(5)-4.06944 00	(8)4.21271 20000	(11)4.24598 06240
10	(4)+2.25910	(3)+8.22400	(6)-3.09398 40	(9)3.27552 97600	(12)8.09327 82098
11	(5)-1.07029	(5)+2.30848	(7)-1.04250 24	(10)2.43298 73600	(14)1.53373 60295
12	(5)-6.04031	(5)+2.80768	(6)+5.51750 40	(11)1.71237 08128	(15)2.88941 99383

23. Bernoulli and Euler Polynomials— Riemann Zeta Function

EMILIE V. HAYNSWORTH¹ AND KARL GOLDBERG²

Contents

	Page
Mathematical Properties	804
23.1. Bernoulli and Euler Polynomials and the Euler-Maclaurin Formula	804
23.2. Riemann Zeta Function and Other Sums of Reciprocal Powers	807
References	808
Table 23.1. Coefficients of the Bernoulli and Euler Polynomials . . . $B_n(x)$ and $E_n(x)$, $n=0(1)15$	809
Table 23.2. Bernoulli and Euler Numbers B_n and E_n , $n=0, 1, 2(2)60$, Exact and B_n to 10S	810
Table 23.3. Sums of Reciprocal Powers	811

$$\zeta(n) = \sum_{k=1}^{\infty} \frac{1}{k^n}, \quad 20D$$

$$\eta(n) = \sum_{k=1}^{\infty} \frac{(-1)^{k-1}}{k^n}, \quad 20D$$

$$\lambda(n) = \sum_{k=0}^{\infty} \frac{1}{(2k+1)^n}, \quad 20D$$

$$\beta(n) = \sum_{k=0}^{\infty} \frac{(-1)^k}{(2k+1)^n}, \quad 18D$$

$$n=1(1)42$$

Table 23.4. Sums of Positive Powers	813
--	-----

$$\sum_{k=1}^m k^n, \quad n=1(1)10, \quad m=1(1)100$$

Table 23.5. $x^n/n!$, $x=2(1)9$, $n=1(1)50$, 10S	818
--	-----

The authors acknowledge the assistance of Ruth E. Capuano in the preparation and checking of the tables.

¹National Bureau of Standards. (Presently, Auburn University.)

²National Bureau of Standards.

23. Bernoulli and Euler Polynomials—Riemann Zeta Function

Mathematical Properties

23.1. Bernoulli and Euler Polynomials and the Euler-Maclaurin Formula

Generating Functions

$$23.1.1 \quad \frac{te^{xt}}{e^t-1} = \sum_{n=0}^{\infty} B_n(x) \frac{t^n}{n!} \quad \left| \quad \frac{2e^{xt}}{e^t+1} = \sum_{n=0}^{\infty} E_n(x) \frac{t^n}{n!} \quad \right| \quad |t| < \pi$$

Bernoulli and Euler Numbers

$$23.1.2 \quad B_n = B_n(0) \quad n=0, 1, \dots \quad \left| \quad E_n = 2^n E_n\left(\frac{1}{2}\right) = \text{integer} \quad \right| \quad n=0, 1, \dots$$

$$23.1.3 \quad B_0=1, B_1=-\frac{1}{2}, B_2=\frac{1}{6}, B_4=-\frac{1}{30} \quad \left| \quad E_0=1, E_2=-1, E_4=5 \quad \right|$$

(For occurrence of B_n and E_n in series expansions of circular functions, see chapter 4.)

Sums of Powers

$$23.1.4 \quad \sum_{k=1}^m k^n = \frac{B_{n+1}(m+1) - B_{n+1}}{n+1} \quad \left| \quad \sum_{k=1}^m (-1)^{m-k} k^n = \frac{E_n(m+1) + (-1)^m E_n(0)}{2} \quad \right| \quad m, n=1, 2, \dots$$

Derivatives and Differences

$$23.1.5 \quad B'_n(x) = nB_{n-1}(x) \quad n=1, 2, \dots \quad \left| \quad E'_n(x) = nE_{n-1}(x) \quad \right| \quad n=1, 2, \dots$$

$$23.1.6 \quad B_n(x+1) - B_n(x) = nx^{n-1} \quad n=0, 1, \dots \quad \left| \quad E_n(x+1) + E_n(x) = 2x^n \quad \right| \quad n=0, 1, \dots$$

Expansions

$$23.1.7 \quad B_n(x+h) = \sum_{k=0}^n \binom{n}{k} B_k(x) h^{n-k} \quad n=0, 1, \dots \quad \left| \quad E_n(x+h) = \sum_{k=0}^n \binom{n}{k} E_k(x) h^{n-k} \quad \right| \quad n=0, 1, \dots$$

$$E_n(x) = \sum_{k=0}^n \binom{n}{k} \frac{E_k}{2^k} \left(x - \frac{1}{2}\right)^{n-k} \quad n=0, 1, \dots$$

Symmetry

$$23.1.8 \quad B_n(1-x) = (-1)^n B_n(x) \quad n=0, 1, \dots \quad \left| \quad E_n(1-x) = (-1)^n E_n(x) \quad \right| \quad n=0, 1, \dots$$

$$23.1.9 \quad (-1)^n B_n(-x) = B_n(x) + nx^{n-1} \quad n=0, 1, \dots \quad \left| \quad (-1)^{n+1} E_n(-x) = E_n(x) - 2x^n \quad \right| \quad n=0, 1, \dots$$

Multiplication Theorem

$$23.1.10 \quad B_n(mx) = m^{n-1} \sum_{k=0}^{m-1} B_n\left(x + \frac{k}{m}\right) \quad n=0, 1, \dots \quad \left| \quad E_n(mx) = m^n \sum_{k=0}^{m-1} (-1)^k E_n\left(x + \frac{k}{m}\right) \quad \right| \quad n=0, 1, \dots$$

$$m=1, 2, \dots \quad \left| \quad E_n(mx) = -\frac{2}{n+1} m^n \sum_{k=0}^{m-1} (-1)^k B_{n+1}\left(x + \frac{k}{m}\right) \quad \right| \quad m=1, 3, \dots$$

$$E_n(mx) = -\frac{2}{n+1} m^n \sum_{k=0}^{m-1} (-1)^k B_{n+1}\left(x + \frac{k}{m}\right) \quad n=0, 1, \dots$$

$$m=2, 4, \dots$$

Integrals

<p>23.1.11 $\int_a^x B_n(t)dt = \frac{B_{n+1}(x) - B_{n+1}(a)}{n+1}$</p> <p>23.1.12 $\int_0^1 B_n(t)B_m(t)dt = (-1)^{n-1} \frac{m!n!}{(m+n)!} B_{m+n}$ $m, n = 1, 2, \dots$</p>	<p>$\int_a^x E_n(t)dt = \frac{E_{n+1}(x) - E_{n+1}(a)}{n+1}$</p> <p>$\int_0^1 E_n(t)E_m(t)dt = (-1)^n 4^{2^{m+n+2}-1} \frac{m!n!}{(m+n+2)!} B_{m+n+2}$ $m, n = 0, 1, \dots$</p>
---	---

(The polynomials are orthogonal for $m+n$ odd.)

Inequalities

<p>23.1.13 $B_{2n} > B_{2n}(x) \quad n=1, 2, \dots, \quad 1 > x > 0$</p> <p>23.1.14 $\frac{2(2n+1)!}{(2\pi)^{2n+1}} \left(\frac{1}{1-2^{-2n}} \right) > (-1)^{n+1} B_{2n+1}(x) > 0$ $n=1, 2, \dots, \quad \frac{1}{2} > x > 0$</p> <p>23.1.15 $\frac{2(2n)!}{(2\pi)^{2n}} \left(\frac{1}{1-2^{1-2n}} \right) > (-1)^{n+1} B_{2n} > \frac{2(2n)!}{(2\pi)^{2n}}$ $n=1, 2, \dots$</p>	<p>$4^{-n} E_{2n} > (-1)^n E_{2n}(x) > 0 \quad n=1, 2, \dots, \quad \frac{1}{2} > x > 0$</p> <p>$\frac{4(2n-1)!}{\pi^{2n}} \left(1 + \frac{1}{2^{2n}-2} \right) > (-1)^n E_{2n-1}(x) > 0$ $n=1, 2, \dots, \quad \frac{1}{2} > x > 0$</p> <p>$\frac{4^{n+1}(2n)!}{\pi^{2n+1}} > (-1)^n E_{2n} > \frac{4^{n+1}(2n)!}{\pi^{2n+1}} \left(\frac{1}{1+3^{-1-2n}} \right)$ $n=0, 1, \dots$</p>
---	--

Fourier Expansions

<p>23.1.16 $B_n(x) = -2 \frac{n!}{(2\pi)^n} \sum_{k=1}^{\infty} \frac{\cos(2\pi kx - \frac{1}{2}\pi n)}{k^n}$ $n > 1, 1 \geq x \geq 0$ $n=1, 1 > x > 0$</p> <p>23.1.17 $B_{2n-1}(x) = \frac{(-1)^n 2(2n-1)!}{(2\pi)^{2n-1}} \sum_{k=1}^{\infty} \frac{\sin 2k\pi x}{k^{2n-1}}$ $n > 1, 1 \geq x \geq 0$ $n=1, 1 > x > 0$</p> <p>23.1.18 $B_{2n}(x) = \frac{(-1)^{n-1} 2(2n)!}{(2\pi)^{2n}} \sum_{k=1}^{\infty} \frac{\cos 2k\pi x}{k^{2n}}$ $n=1, 2, \dots, \quad 1 \geq x \geq 0$</p>	<p>$E_n(x) = 4 \frac{n!}{\pi^{n+1}} \sum_{k=0}^{\infty} \frac{\sin((2k+1)\pi x - \frac{1}{2}\pi n)}{(2k+1)^{n+1}}$ $n > 0, 1 \geq x \geq 0$ $n=0, 1 > x > 0$</p> <p>$E_{2n-1}(x) = \frac{(-1)^n 4(2n-1)!}{\pi^{2n}} \sum_{k=0}^{\infty} \frac{\cos(2k+1)\pi x}{(2k+1)^{2n}}$ $n=1, 2, \dots, \quad 1 \geq x \geq 0$</p> <p>$E_{2n}(x) = \frac{(-1)^n 4(2n)!}{\pi^{2n+1}} \sum_{k=0}^{\infty} \frac{\sin(2k+1)\pi x}{(2k+1)^{2n+1}}$ $n > 0, 1 \geq x \geq 0$ $n=0, 1 > x > 0$</p>
---	--

Special Values

<p>23.1.19 $B_{2n+1} = 0 \quad n=1, 2, \dots$</p> <p>23.1.20 $B_n(0) = (-1)^n B_n(1) = B_n$ $n=0, 1, \dots$</p> <p>23.1.21 $B_n(\frac{1}{2}) = -(1-2^{1-n})B_n$ $n=0, 1, \dots$</p>	<p>$E_{2n+1} = 0 \quad n=0, 1, \dots$</p> <p>$E_n(0) = -E_n(1) = -2(n+1)^{-1}(2^{n+1}-1)B_{n+1} \quad n=1, 2, \dots$</p> <p>$E_n(\frac{1}{2}) = 2^{-n}E_n \quad n=0, 1, \dots$</p>
---	---

$$23.1.22 \quad B_n\left(\frac{1}{4}\right) = (-1)^n B_n\left(\frac{3}{4}\right) \\ = -2^{-n}(1-2^{1-n})B_n - n4^{-n}E_{n-1} \quad n=1, 2, \dots$$

$$E_{2n-1}\left(\frac{1}{3}\right) = -E_{2n-1}\left(\frac{2}{3}\right) \\ = -(2n)^{-1}(1-3^{1-2n})(2^{2n}-1)B_{2n} \quad n=1, 2, \dots$$

$$23.1.23 \quad B_{2n}\left(\frac{1}{3}\right) = B_{2n}\left(\frac{2}{3}\right) \\ = -2^{-1}(1-3^{1-2n})B_{2n} \quad n=0, 1, \dots$$

$$23.1.24 \quad B_{2n}\left(\frac{1}{6}\right) = B_{2n}\left(\frac{5}{6}\right) \\ = 2^{-1}(1-2^{1-2n})(1-3^{1-2n})B_{2n} \quad n=0, 1, \dots$$

Symbolic Operations

$$23.1.25 \quad p(B(x)+1) - p(B(x)) = p'(x)$$

$$p(E(x)+1) + p(E(x)) = 2p(x)$$

$$23.1.26 \quad B_n(x+h) = (B(x)+h)^n \quad n=0, 1, \dots$$

$$E_n(x+h) = (E(x)+h)^n \quad n=0, 1, \dots$$

Here $p(x)$ denotes a polynomial in x and after expanding we set $\{B(x)\}^n = B_n(x)$ and $\{E(x)\}^n = E_n(x)$.

Relations Between the Polynomials

$$23.1.27 \quad E_{n-1}(x) = \frac{2^n}{n} \left\{ B_n\left(\frac{x+1}{2}\right) - B_n\left(\frac{x}{2}\right) \right\} \\ = \frac{2}{n} \left\{ B_n(x) - 2^n B_n\left(\frac{x}{2}\right) \right\} \quad n=1, 2, \dots$$

$$23.1.28 \quad E_{n-2}(x) = 2 \binom{n}{2}^{-1} \sum_{k=0}^{n-2} \binom{n}{k} (2^{n-k}-1) B_{n-k} B_k(x) \\ n=2, 3, \dots$$

$$23.1.29 \quad B_n(x) = 2^{-n} \sum_{k=0}^n \binom{n}{k} B_{n-k} E_k(2x) \quad n=0, 1, \dots$$

Euler-Maclaurin Formulas

Let $F(x)$ have its first $2n$ derivatives continuous on an interval (a, b) . Divide the interval into m equal parts and let $h=(b-a)/m$. Then for some $\theta, 1 > \theta > 0$, depending on $F^{(2n)}(x)$ on (a, b) , we have

$$23.1.30 \quad \sum_{k=0}^m F(a+kh) = \frac{1}{h} \int_a^b F(t) dt + \frac{1}{2} \{F(b)+F(a)\} \\ + \sum_{k=1}^{n-1} \frac{h^{2k-1}}{(2k)!} B_{2k} \{F^{(2k-1)}(b) - F^{(2k-1)}(a)\} \\ + \frac{h^{2n}}{(2n)!} B_{2n} \sum_{k=0}^{m-1} F^{(2n)}(a+kh+\theta h)$$

Equivalent to this is

$$23.1.31 \quad \frac{1}{h} \int_x^{x+h} F(t) dt = \frac{1}{2} \{F(x+h)+F(x)\} \\ - \sum_{k=1}^{n-1} \frac{h^{2k-1}}{(2k)!} B_{2k} \{F^{(2k-1)}(x+h) - F^{(2k-1)}(x)\} \\ - \frac{h^{2n}}{(2n)!} B_{2n} F^{(2n)}(x+\theta h) \quad b-h \geq x \geq a$$

Let $\hat{B}_n(x) = B_n(x-[x])$. The Euler Summation Formula is

$$23.1.32 \quad \sum_{k=0}^{m-1} F(a+kh+\omega h) = \frac{1}{h} \int_a^b F(t) dt \\ + \sum_{k=1}^p \frac{h^{k-1}}{k!} B_k(\omega) \{F^{(k-1)}(b) - F^{(k-1)}(a)\} \\ - \frac{h^p}{p!} \int_0^1 \hat{B}_p(\omega-t) \left\{ \sum_{k=0}^{m-1} F^{(p)}(a+kh+th) \right\} dt \\ p \leq 2n, 1 \geq \omega \geq 0$$

23.2. Riemann Zeta Function and Other Sums of Reciprocal Powers

23.2.1 $\zeta(s) = \sum_{k=1}^{\infty} k^{-s}$ $\Re s > 1$

23.2.2 $= \prod_p (1 - p^{-s})^{-1}$ $\Re s > 1$

(product over all primes p).

23.2.3
$$= \frac{1}{s-1} + \frac{1}{2} + \sum_{k=1}^n \frac{B_{2k}}{2k} \binom{s+2k-2}{2k-1} - \frac{(s+2n)}{(2n+1)} \int_1^{\infty} \frac{B_{2n+1}(x-[x])}{x^{s+2n+1}} dx$$
 $s \neq 1, n=1, 2, \dots, \Re s > -2n$

* **23.2.4**
$$= -\frac{\Gamma(1-s)}{2\pi i} \int_C \frac{(-z)^{s-1}}{e^z - 1} dz$$

23.2.5
$$= \frac{1}{s-1} + \sum_{n=0}^{\infty} \frac{(-1)^n}{n!} \gamma_n (s-1)^n$$

where

$$\gamma_n = \lim_{m \rightarrow \infty} \left\{ \sum_{k=1}^m \frac{(\ln k)^n}{k} - \frac{(\ln m)^{n+1}}{n+1} \right\}$$
 $\Re s > 0$

23.2.6
$$= 2^s \pi^{s-1} \sin\left(\frac{1}{2}\pi s\right) \Gamma(1-s) \zeta(1-s)$$

23.2.7
$$= \frac{1}{\Gamma(s)} \int_0^{\infty} \frac{x^{s-1}}{e^x - 1} dx$$
 $\Re s > 1$

23.2.8
$$= \frac{1}{(1-2^{1-s})\Gamma(s)} \int_0^{\infty} \frac{x^{s-1}}{e^x + 1} dx$$

23.2.9
$$= \sum_{k=1}^n k^{-s} + (s-1)^{-1} n^{1-s} - s \int_n^{\infty} \frac{x-[x]}{x^{s+1}} dx$$
 $n=1, 2, \dots, \Re s > 0$

23.2.10
$$= \frac{\exp(\ln 2\pi - 1 - \frac{1}{2}\gamma)s}{2(s-1)\Gamma(\frac{1}{2}s+1)} \prod_{\rho} \left(1 - \frac{s}{\rho}\right) e^{\frac{s}{\rho}}$$

product over all zeros ρ of $\zeta(s)$ with $\Re \rho > 0$.

The contour C in the fourth formula starts at infinity on the positive real axis, circles the origin once in the positive direction excluding the points $\pm 2ni\pi$ for $n=1, 2, \dots$, and returns to the starting point. Therefore $\zeta(s)$ is regular for all values of s except for a simple pole at $s=1$ with residue 1.

Special Values

23.2.11 $\zeta(0) = -\frac{1}{2}$

23.2.12 $\zeta(1) = \infty$

23.2.13 $\zeta'(0) = -\frac{1}{2} \ln 2\pi$

23.2.14 $\zeta(-2n) = 0$ $n=1, 2, \dots$

23.2.15 $\zeta(1-2n) = -\frac{B_{2n}}{2n}$ $n=1, 2, \dots$

23.2.16 $\zeta(2n) = \frac{(2\pi)^{2n}}{2(2n)!} |B_{2n}|$ $n=1, 2, \dots$

23.2.17

$$\zeta(2n+1) = \frac{(-1)^{n+1} (2\pi)^{2n+1}}{2(2n+1)!} \int_0^1 B_{2n+1}(x) \cot(\pi x) dx$$
 $n=1, 2, \dots$

Sums of Reciprocal Powers

The sums referred to are

23.2.18 $\zeta(n) = \sum_{k=1}^{\infty} k^{-n}$ $n=2, 3, \dots$

23.2.19

$$\eta(n) = \sum_{k=1}^{\infty} (-1)^{k-1} k^{-n} = (1-2^{1-n})\zeta(n)$$
 $n=1, 2, \dots$

23.2.20

$$\lambda(n) = \sum_{k=0}^{\infty} (2k+1)^{-n} = (1-2^{-n})\zeta(n)$$
 $n=2, 3, \dots$

23.2.21

$$\beta(n) = \sum_{k=0}^{\infty} (-1)^k (2k+1)^{-n}$$
 $n=1, 2, \dots$

These sums can be calculated from the Bernoulli and Euler polynomials by means of the last two formulas for special values of the zeta function (note that $\eta(1) = \ln 2$), and

23.2.22 $\beta(2n+1) = \frac{(\pi/2)^{2n+1}}{2(2n)!} |E_{2n}|$ $n=0, 1, \dots$

23.2.23

$$\beta(2n) = \frac{(-1)^n \pi^{2n}}{4(2n-1)!} \int_0^1 E_{2n-1}(x) \sec(\pi x) dx$$
 $n=1, 2, \dots$

$\beta(2)$ is known as Catalan's constant. Some other special values are

23.2.24 $\zeta(2) = 1 + \frac{1}{2^2} + \frac{1}{3^2} + \dots = \frac{\pi^2}{6}$

23.2.25 $\zeta(4) = 1 + \frac{1}{2^4} + \frac{1}{3^4} + \dots = \frac{\pi^4}{90}$

* See page 11.

$$23.2.26 \quad \eta(2) = 1 - \frac{1}{2^2} + \frac{1}{3^2} - \dots = \frac{\pi^2}{12}$$

$$23.2.27 \quad \eta(4) = 1 - \frac{1}{2^4} + \frac{1}{3^4} - \dots = \frac{7\pi^4}{720}$$

$$23.2.28 \quad \lambda(2) = 1 + \frac{1}{3^2} + \frac{1}{5^2} + \dots = \frac{\pi^2}{8}$$

$$23.2.29 \quad \lambda(4) = 1 + \frac{1}{3^4} + \frac{1}{5^4} + \dots = \frac{\pi^4}{96}$$

$$23.2.30 \quad \beta(1) = 1 - \frac{1}{3} + \frac{1}{5} - \dots = \frac{\pi}{4}$$

$$23.2.31 \quad \beta(3) = 1 - \frac{1}{3^3} + \frac{1}{5^3} - \dots = \frac{\pi^3}{32}$$

References

Texts

- [23.1] G. Boole, *The calculus of finite differences*, 3d ed. (Hafner Publishing Co., New York, N.Y., 1932).
- [23.2] W. E. Briggs and S. Chowla, *The power series coefficients of $\zeta(s)$* , *Amer. Math. Monthly* **62**, 323-325 (1955).
- [23.3] T. Fort, *Finite differences* (Clarendon Press, Oxford, England, 1948).
- [23.4] C. Jordan, *Calculus of finite differences*, 2d ed. (Chelsea Publishing Co., New York, N.Y., 1960).
- [23.5] K. Knopp, *Theory and application of infinite series* (Blackie and Son, Ltd., London, England, 1951).
- [23.6] L. M. Milne-Thomson, *Calculus of finite differences* (Macmillan and Co., Ltd., London, England, 1951).
- [23.7] N. E. Nörlund, *Vorlesungen über Differenzenrechnung* (Edwards Bros., Ann Arbor, Mich., 1945).
- [23.8] C. H. Richardson, *An introduction to the calculus of finite differences* (D. Van Nostrand Co., Inc., New York, N.Y., 1954).
- [23.9] J. F. Steffensen, *Interpolation* (Chelsea Publishing Co., New York, N.Y., 1950).
- [23.10] E. C. Titchmarsh, *The zeta-function of Riemann* (Cambridge Univ. Press, Cambridge, England, 1930).
- [23.11] A. D. Wheelon, *A short table of summable series*, Report No. SM-14642, Douglas Aircraft Co., Inc., Santa Monica, Calif. (1953).

Tables

- [23.12] G. Blanch and R. Siegel, *Table of modified Bernoulli polynomials*, *J. Research NBS* **44**, 103-107 (1950) RP2060.
- [23.13] H. T. Davis, *Tables of the higher mathematical functions*, vol. II (Principia Press, Bloomington, Ind., 1935).
- [23.14] R. Hensman, *Tables of the generalized Riemann Zeta function*, Report No. T2111, Telecommunications Research Establishment, Ministry of Supply, Great Malvern, Worcestershire, England (1948). $\zeta(s, a)$, $s = -10(.1)0$, $a = 0(.1)2$, 5D; $(s-1)\zeta(s, a)$, $s = 0(.1)1$, $a = 0(.1)2$, 5D.
- [23.15] D. H. Lehmer, *On the maxima and minima of Bernoulli polynomials*, *Amer. Math. Monthly* **47**, 533-538 (1940).
- [23.16] E. O. Powell, *A table of the generalized Riemann Zeta function in a particular case*, *Quart. J. Mech. Appl. Math.* **5**, 116-123 (1952). $\zeta(\frac{1}{2}, a)$, $a = 1(.01)2(.02)5(.05)10$, 10D.

COEFFICIENTS b_k OF THE BERNOULLI POLYNOMIALS $B_n(x) = \sum_{k=0}^n b_k x^k$

Table 23.1

$n \backslash k$	0	1	2	3	4	5	6	7	8	9	10	11	12	13	14	15
0	1															
1	$-\frac{1}{2}$	1														
2	$\frac{1}{6}$	-1	1													
3	0	$\frac{1}{2}$	$-\frac{3}{2}$	1												
4	$-\frac{1}{30}$	0	1	-2	1											
5	0	$-\frac{1}{6}$	0	$\frac{5}{3}$	$-\frac{5}{2}$	1										
6	$\frac{1}{42}$	0	$-\frac{1}{2}$	0	$-\frac{5}{2}$	-3	1									
7	0	$\frac{1}{6}$	0	$-\frac{7}{6}$	0	$\frac{7}{2}$	$-\frac{7}{2}$	1								
8	$-\frac{1}{30}$	0	$\frac{2}{3}$	0	$-\frac{7}{3}$	0	$\frac{14}{3}$	-4	1							
9	0	$-\frac{3}{10}$	0	2	0	$-\frac{21}{5}$	0	6	$-\frac{9}{2}$	1						
10	$\frac{5}{66}$	0	$-\frac{3}{2}$	0	5	0	-7	0	$\frac{15}{2}$	-5	1					
11	0	$\frac{5}{6}$	0	$-\frac{11}{2}$	0	11	0	-11	0	$\frac{55}{6}$	$-\frac{11}{2}$	1				
12	$-\frac{691}{2730}$	0	5	0	$-\frac{33}{2}$	0	22	0	$-\frac{33}{2}$	0	11	-6	1			
13	0	$-\frac{691}{210}$	0	$\frac{65}{3}$	0	$-\frac{429}{10}$	0	$\frac{286}{7}$	0	$-\frac{143}{6}$	0	13	$-\frac{13}{2}$	1		
14	$\frac{7}{6}$	0	$-\frac{691}{30}$	0	$\frac{455}{6}$	0	$-\frac{1001}{10}$	0	$\frac{143}{2}$	0	$-\frac{1001}{30}$	0	$\frac{91}{6}$	-7	1	
15	0	$\frac{35}{2}$	0	$-\frac{691}{6}$	0	$\frac{455}{2}$	0	$-\frac{429}{2}$	0	$\frac{715}{6}$	0	$-\frac{91}{2}$	0	$\frac{35}{2}$	$-\frac{15}{2}$	1

$B_n = B_n(0)$

COEFFICIENTS e_k OF THE EULER POLYNOMIALS $E_n(x) = \sum_{k=0}^n e_k x^k$

$n \backslash k$	0	1	2	3	4	5	6	7	8	9	10	11	12	13	14	15
0	1															
1	$-\frac{1}{2}$	1														
2	0	-1	1													
3	$\frac{1}{4}$	0	$-\frac{3}{2}$	1												
4	0	1	0	-2	1											
5	$-\frac{1}{2}$	0	$\frac{5}{2}$	0	$-\frac{5}{2}$	1										
6	0	-3	0	5	0	-3	1									
7	$\frac{17}{8}$	0	$-\frac{21}{2}$	0	$\frac{35}{4}$	0	$-\frac{7}{2}$	1								
8	0	17	0	-28	0	14	0	-4	1							
9	$-\frac{31}{2}$	0	$\frac{153}{2}$	0	-63	0	21	0	$-\frac{9}{2}$	1						
10	0	-155	0	255	0	-126	0	30	0	-5	1					
11	$\frac{691}{4}$	0	$-\frac{1705}{2}$	0	$\frac{2805}{4}$	0	-231	0	$\frac{165}{4}$	0	$-\frac{11}{2}$	1				
12	0	2073	0	-3410	0	1683	0	-396	0	55	0	-6	1			
13	$-\frac{5461}{2}$	0	$\frac{26949}{2}$	0	$-\frac{22165}{2}$	0	$\frac{7293}{2}$	0	$-\frac{1287}{2}$	0	$\frac{143}{2}$	0	$-\frac{13}{2}$	1		
14	0	-38227	0	62881	0	-31031	0	7293	0	-1001	0	91	0	-7	1	
15	$\frac{929569}{16}$	0	$-\frac{573405}{2}$	0	$\frac{943215}{4}$	0	$-\frac{155155}{2}$	0	$\frac{109395}{8}$	0	$-\frac{3003}{2}$	0	$\frac{455}{4}$	0	$-\frac{15}{2}$	1

Table 23.2

BERNOULLI AND EULER NUMBERS

$$B_n = N/D$$

n	N	D	B_n
0	1	1	(0) 1.0000 00000
1	-1	2	(-1) -5.0000 00000 0
2	1	6	(-1) 1.6666 66667 1
4	-1	30	(-2) -3.3333 33333 2
6	1	42	(-2) 2.3809 52381 3
8	-1	30	(-2) -3.3333 33333 4
10	5	66	(-2) 7.5757 57576 5
12	-691	2730	(-1) -2.5311 35531 6
14	7	6	(0) 1.1666 66667 7
16	-3617	510	(0) -7.0921 56863 8
18	43867	798	(1) 5.4971 17794 9
20	-1 74611	330	(2) -5.2912 42424 10
22	8 54513	138	(3) 6.1921 23188 11
24	-2363 64091	2730	(4) -8.6580 25311 12
26	85 53103	6	(6) 1.4255 17167 13
28	-2 37494 61029	870	(7) -2.7298 23107 14
30	861 58412 76005	14322	(8) 6.0158 08739 15
32	-770 93210 41217	510	(10) -1.5116 31577 16
34	257 76878 58367	6	(11) 4.2961 46431 17
36	-26315 27155 30534 77373	19 19190	(13) -1.3711 65521 18
38	2 92999 39138 41559	6	(14) 4.8833 23190 19
40	-2 61082 71849 64491 22051	13530	(16) -1.9296 57934 20
42	15 20097 64391 80708 02691	1806	(17) 8.4169 30476 21
44	-278 33269 57930 10242 35023	690	(19) -4.0338 07185 22
46	5964 51111 59391 21632 77961	282	(21) 2.1150 74864 23
48	-560 94033 68997 81768 62491 27547	46410	(23) -1.2086 62652 24
50	49 50572 05241 07964 82124 77525	66	(24) 7.5008 66746 25
52	-80116 57181 35489 95734 79249 91853	1590	(26) -5.0387 78101 26
54	29 14996 36348 84862 42141 81238 12691	798	(28) 3.6528 77648 27
56	-2479 39292 93132 26753 68541 57396 63229	870	(30) -2.8498 76930 28
58	84483 61334 88800 41862 04677 59940 36021	354	(32) 2.3865 42750 29
60	-121 52331 40483 75557 20403 04994 07982 02460 41491	567 86730	(34) -2.1399 94926 30

n	E_n
0	1
2	-1
4	5
6	-61
8	1385
10	-50521
12	27 02765
14	-1993 60981
16	1 93915 12145
18	-240 48796 75441
20	37037 11882 37525
22	-69 34887 43931 37901
24	15514 53416 35570 86905
26	-40 87072 50929 31238 92361
28	12522 59641 40362 98654 68285
30	-44 15438 93249 02310 45536 82821
32	17751 93915 79539 28943 66647 89665
34	-80 72329 92358 87898 06216 82474 53281
36	41222 06033 95177 02122 34707 96712 59045
38	-234 89580 52704 31082 52017 82857 61989 47741
40	1 48511 50718 11498 00178 77156 78140 58266 84425
42	-1036 46227 33519 61211 93979 57304 74518 59763 10201
44	7 94757 94225 97592 70360 80405 10088 07061 95192 73805
46	-6667 53751 66855 44977 43502 84747 73748 19752 41076 84661
48	60 96278 64556 85421 58691 68574 28768 43153 97653 90444 35185
50	-60532 85248 18862 18963 14383 78511 16490 88103 49822 51468 15121
52	650 61624 86684 60884 77158 70634 08082 29834 83644 23676 53855 76565
54	-7 54665 99390 08739 09806 14325 65889 73674 42122 40024 71169 98586 45581
56	9420 32189 64202 41204 20228 62376 90583 22720 93888 52599 64600 93949 59545
58	-126 22019 25180 62187 19903 40923 72874 89255 48234 10611 91825 59406 99649 20041
60	181089 11496 57923 04965 45807 74165 21586 88733 48734 92363 14106 00809 54542 31325

From H. T. Davis, Tables of the higher mathematical functions, vol. II. Principia Press, Bloomington, Ind., 1935 (with permission).

SUMS OF RECIPROCAL POWERS Table 23.3

n	$\zeta(n) = \sum_{k=1}^{\infty} k^{-n}$				$\eta(n) = \sum_{k=1}^{\infty} (-1)^{k-1} k^{-n}$			
1					0.69314	71805	59945	30942
2	1.64493	40668	48226	43647	0.82246	70334	24113	21824
3	1.20205	69031	59594	28540	0.90154	26773	69695	71405
4	1.08232	32337	11138	19152	0.94703	28294	97245	91758
5	1.03692	77551	43369	92633	0.97211	97704	46909	30594
6	1.01734	30619	84449	13971	0.98555	10912	97435	10410
7	1.00834	92773	81922	82684	0.99259	38199	22830	28267
8	1.00407	73561	97944	33938	0.99623	30018	52647	89923
9	1.00200	83928	26082	21442	0.99809	42975	41605	33077
10	1.00099	45751	27818	08534	0.99903	95075	98271	56564
11	1.00049	41886	04119	46456	0.99951	71434	98060	75414
12	1.00024	60865	53308	04830	0.99975	76851	43858	19085
13	1.00012	27133	47578	48915	0.99987	85427	63265	11549
14	1.00006	12481	35058	70483	0.99993	91703	45979	71817
15	1.00003	05882	36307	02049	0.99996	95512	13099	23808
16	1.00001	52822	59408	65187	0.99998	47642	14906	10644
17	1.00000	76371	97637	89976	0.99999	23782	92041	01198
18	1.00000	38172	93264	99984	0.99999	61878	69610	11348
19	1.00000	19082	12716	55394	0.99999	80935	08171	67511
20	1.00000	09539	62033	87280	0.99999	90466	11581	52212
21	1.00000	04769	32986	78781	0.99999	95232	58215	54282
22	1.00000	02384	50502	72773	0.99999	97616	13230	82255
23	1.00000	01192	19925	96531	0.99999	98808	01318	43950
24	1.00000	00596	08189	05126	0.99999	99403	98892	39463
25	1.00000	00298	03503	51465	0.99999	99701	98856	96283
26	1.00000	00149	01554	82837	0.99999	99850	99231	99657
27	1.00000	00074	50711	78984	0.99999	99925	49550	48496
28	1.00000	00037	25334	02479	0.99999	99962	74753	40011
29	1.00000	00018	62659	72351	0.99999	99981	37369	41811
30	1.00000	00009	31327	43242	0.99999	99990	68682	28145
31	1.00000	00004	65662	90650	0.99999	99995	34340	33145
32	1.00000	00002	32831	18337	0.99999	99997	67169	89595
33	1.00000	00001	16415	50173	0.99999	99998	83584	85805
34	1.00000	00000	58207	72088	0.99999	99999	41792	39905
35	1.00000	00000	29103	85044	0.99999	99999	70896	18953
36	1.00000	00000	14551	92189	0.99999	99999	85448	09143
37	1.00000	00000	07275	95984	0.99999	99999	92724	04461
38	1.00000	00000	03637	97955	0.99999	99999	96362	02193
39	1.00000	00000	01818	98965	0.99999	99999	98181	01084
40	1.00000	00000	00909	49478	0.99999	99999	99090	50538
41	1.00000	00000	00454	74738	0.99999	99999	99545	25268
42	1.00000	00000	00227	37368	0.99999	99999	99772	62633

$\pi^2/6 \leftarrow$
 $\pi^4/90 \leftarrow$
 $\pi^6/945 \leftarrow$
 $\pi^8/9450 \leftarrow$

\log^2
 $\pi^2/12$
 $7\pi^4/960$

For $n > 42$, $\zeta(n+1) = \frac{1}{2}[1 + \zeta(n)]$ $\eta(n+1) = \frac{1}{2}[1 + \eta(n)]$

From H. T. Davis, Tables of the higher mathematical functions, vol. II. Principia Press, Bloomington, Ind., 1935 (with permission).

Table 23.3

SUMS OF RECIPROCAL POWERS

n	$\lambda(n) = \sum_{k=0}^{\infty} (2k+1)^{-n}$				<i>CATALAN</i>	$\beta(n) = \sum_{k=0}^{\infty} (-1)^k (2k+1)^{-n}$			
1									
$\pi^2/8 \leftarrow$ 2	1.23370	05501	36169	82735	$\rightarrow 7/8$	0.78539	81633	97448	310 $-\pi/4$
3	1.05179	97902	64644	99972		0.91596	55941	77219	015 $\rightarrow \pi^3/32$
$\pi^4/96 \leftarrow$ 4	1.01467	80316	04192	05455	$\rightarrow 2/3$	0.96894	61462	59369	380
5	1.00452	37627	95139	61613		0.98894	45517	41105	336
6	1.00144	70766	40942	12191		0.99615	78280	77088	064
7	1.00047	15486	52376	55476	$-\frac{1}{12}$	0.99868	52222	18438	135
8	1.00015	51790	25296	11930		0.99955	45078	90539	909
9	1.00005	13451	83843	77259		0.99984	99902	46829	657
10	1.00001	70413	63044	82549		0.99994	96841	87220	090
11	1.00000	56660	51090	10935		0.99998	31640	26196	877
12	1.00000	18858	48583	11958		0.99999	43749	73823	699
13	1.00000	06280	55421	80232		0.99999	81223	50587	882
14	1.00000	02092	40519	21150		0.99999	93735	83771	841
15	1.00000	00697	24703	12929		0.99999	97910	87248	735
16	1.00000	00232	37157	37916		0.99999	99303	40842	624
17	1.00000	00077	44839	45587		0.99999	99767	75950	903
18	1.00000	00025	81437	55666		0.99999	99922	57782	104
19	1.00000	00008	60444	11452		0.99999	99974	19086	745
20	1.00000	00002	86807	69746		0.99999	99991	39660	745
21	1.00000	00000	95601	16531		0.99999	99997	13213	274
22	1.00000	00000	31866	77514		0.99999	99999	04403	029
23	1.00000	00000	10622	20241		0.99999	99999	68134	064
24	1.00000	00000	03540	72294		0.99999	99999	89377	965
25	1.00000	00000	01180	23874		0.99999	99999	96459	311
26	1.00000	00000	00393	41247		0.99999	99999	98819	768
27	1.00000	00000	00131	13740		0.99999	99999	99606	589
28	1.00000	00000	00043	71245		0.99999	99999	99868	863
29	1.00000	00000	00014	57081		0.99999	99999	99956	288
30	1.00000	00000	00004	85694		0.99999	99999	99985	429
31	1.00000	00000	00001	61898		0.99999	99999	99995	143
32	1.00000	00000	00000	53966		0.99999	99999	99998	381
33	1.00000	00000	00000	17989		0.99999	99999	99999	460
34	1.00000	00000	00000	05996		0.99999	99999	99999	820
35	1.00000	00000	00000	01999		0.99999	99999	99999	940
36	1.00000	00000	00000	00666		0.99999	99999	99999	980
37	1.00000	00000	00000	00222		0.99999	99999	99999	993
38	1.00000	00000	00000	00074		0.99999	99999	99999	999
39	1.00000	00000	00000	00025					
40	1.00000	00000	00000	00008					
41	1.00000	00000	00000	00003					
42	1.00000	00000	00000	00001					

SUMS OF POSITIVE POWERS $\sum_{k=1}^m k^n$

Table 23.4

$m \setminus n$	1	2	3	4	5	6
1	1	1	1	1	1	1
2	3	5	9	17	33	65
3	6	14	36	98	276	794
4	10	30	100	354	1300	4890
5	15	55	225	979	4425	20515
6	21	91	441	2275	12201	67171
7	28	140	784	4676	29008	1 84820
8	36	204	1296	8772	61776	4 46964
9	45	285	2025	15333	1 20825	9 78405
10	55	385	3025	25333	2 20825	19 78405
11	66	506	4356	39974	3 81876	37 49966
12	78	650	6084	60710	6 30708	67 35950
13	91	819	8281	89271	10 02001	115 62759
14	105	1015	11025	1 27687	15 39825	190 92295
15	120	1240	14400	1 78312	22 99200	304 82920
16	136	1496	18496	2 43848	33 47776	472 60136
17	153	1785	23409	3 27369	47 67633	713 97705
18	171	2109	29241	4 32345	66 57201	1054 09929
19	190	2470	36100	5 62666	91 33300	1524 55810
20	210	2870	44100	7 22666	123 33300	2164 55810
21	231	3311	53361	9 17147	164 17401	3022 21931
22	253	3795	64009	11 51403	215 71033	4156 01835
23	276	4324	76176	14 31244	280 07376	5636 37724
24	300	4900	90000	17 63020	359 70000	7547 40700
25	325	5525	1 05625	21 53645	457 35625	9988 81325
26	351	6201	1 23201	26 10621	576 17001	13077 97101
27	378	6930	1 42884	31 42062	719 65908	16952 17590
28	406	7714	1 64836	37 56718	891 76276	21771 07894
29	435	8555	1 89225	44 63999	1096 87425	27719 31215
30	465	9455	2 16225	52 73999	1339 87425	35009 31215
31	496	10416	2 46016	61 97520	1626 16576	43884 34896
32	528	11440	2 78784	72 46096	1961 71008	54621 76720
33	561	12529	3 14721	84 32017	2353 06401	67536 44689
34	595	13685	3 54025	97 68353	2807 41825	82984 49105
35	630	14910	3 96900	112 68978	3332 63700	1 01367 14730
36	666	16206	4 43556	129 48594	3937 29876	1 23134 97066
37	703	17575	4 94209	148 22755	4630 73833	1 48792 23475
38	741	19019	5 49081	169 07891	5423 09001	1 78901 59859
39	780	20540	6 08400	192 21332	6325 33200	2 14089 03620
40	820	22140	6 72400	217 81332	7349 33200	2 55049 03620
41	861	23821	7 41321	246 07093	8507 89401	3 02550 07861
42	903	25585	8 15409	277 18789	9814 80633	3 57440 39605
43	946	27434	8 94916	311 37590	11284 89076	4 20654 02654
44	990	29370	9 80100	348 85686	12934 05300	4 93217 16510
45	1035	31395	10 71225	389 86311	14779 33425	5 76254 82135
46	1081	33511	11 68561	434 63767	16838 96401	6 70997 79031
47	1128	35720	12 72384	483 43448	19132 41408	7 78789 94360
48	1176	38024	13 82976	536 51864	21680 45376	9 01095 84824
49	1225	40425	15 00625	594 16665	24505 20625	10 39508 72025
50	1275	42925	16 25625	656 66665	27630 20625	11 95758 72025

From H. T. Davis, Tables of the higher mathematical functions, vol. II. Principia Press, Bloomington, Ind., 1935 (with permission).

Table 23.4

SUMS OF POSITIVE POWERS $\sum_{k=1}^m k^n$

$m \backslash n$	1	2	3	4	5	6
51	1326	45526	17 58276	724 31866	31080 45876	13 71721 59826
52	1378	48230	18 98884	797 43482	34882 49908	15 69427 69490
53	1431	51039	20 47761	876 33963	39064 45401	17 91071 30619
54	1485	53955	22 05225	961 37019	43656 10425	20 39020 41915
55	1540	56980	23 71600	1052 87644	48688 94800	23 15826 82540
56	1596	60116	25 47216	1151 22140	54196 26576	26 24236 61996
57	1653	63365	27 32409	1256 78141	60213 18633	29 67201 09245
58	1711	66729	29 27521	1369 94637	66776 75401	33 47888 01789
59	1770	70210	31 32900	1491 11998	73925 99700	37 69693 35430
60	1830	73810	33 48900	1620 71998	81701 99700	42 36253 35430
61	1891	77531	35 75881	1759 17839	90147 96001	47 51457 09791
62	1953	81375	38 14209	1906 94175	99309 28833	53 19459 45375
63	2016	85344	40 64256	2064 47136	1 09233 65376	59 44694 47584
64	2080	89440	43 26400	2232 24352	1 19971 07200	66 31889 24320
65	2145	93665	46 01025	2410 74977	1 31573 97825	73 86078 14945
66	2211	98021	48 88521	2600 49713	1 44097 30401	82 12617 64961
67	2278	1 02510	51 89284	2802 00834	1 57598 55508	91 17201 47130
68	2346	1 07134	55 03716	3015 82210	1 72137 89076	101 05876 29754
69	2415	1 11895	58 32225	3242 49331	1 87778 20425	111 85057 92835
70	2485	1 16795	61 75225	3482 59331	2 04585 20425	123 61547 92835
71	2556	1 21836	65 33136	3736 71012	2 22627 49776	136 42550 76756
72	2628	1 27020	69 06384	4005 44868	2 41976 67408	150 35691 46260
73	2701	1 32349	72 95401	4289 43109	2 62707 39001	165 49033 72549
74	2775	1 37825	77 00625	4589 29685	2 84897 45625	181 91098 62725
75	2850	1 43450	81 22500	4905 70310	3 08627 92500	199 70883 78350
76	2926	1 49226	85 61476	5239 32486	3 33983 17876	218 97883 06926
77	3003	1 55155	90 18009	5590 85527	3 61051 02033	239 82106 87015
78	3081	1 61239	94 92561	5961 00583	3 89922 76401	262 34102 87719
79	3160	1 67480	99 85600	6350 50664	4 20693 32800	286 64977 43240
80	3240	1 73880	104 97600	6760 10664	4 53461 32800	312 86417 43240
81	3321	1 80441	110 29041	7190 57385	4 88329 17201	341 10712 79721
82	3403	1 87165	115 80409	7642 69561	5 25403 15633	371 50779 51145
83	3486	1 94054	121 52196	8117 27882	5 64793 56276	404 20183 24514
84	3570	2 01110	127 44900	8615 15018	6 06614 75700	439 33163 56130
85	3655	2 08335	133 59025	9137 15643	6 50985 28825	477 04658 71755
86	3741	2 15731	139 95081	9684 16459	6 98027 99001	517 50331 06891
87	3828	2 23300	146 53584	10257 06220	7 47870 08208	560 86593 07900
88	3916	2 31044	153 35056	10856 75756	8 00643 27376	607 30633 94684
89	4005	2 38965	160 40025	11484 17997	8 56483 86825	657 00446 85645
90	4095	2 47065	167 69025	12140 27997	9 15532 86825	710 14856 85645
91	4186	2 55346	175 22596	12826 02958	9 77936 08276	766 93549 37686
92	4278	2 63810	183 01284	13542 42254	10 43844 23508	827 57099 39030
93	4371	2 72459	191 05641	14290 47455	11 13413 07201	892 27001 22479
94	4465	2 81295	199 36225	15071 22351	11 86803 47425	961 25699 03535
95	4560	2 90320	207 93600	15885 72976	12 64181 56800	1034 76617 94160
96	4656	2 99536	216 78336	16735 07632	13 45718 83776	1113 04195 83856
97	4753	3 08945	225 91009	17620 36913	14 31592 24033	1196 33915 88785
98	4851	3 18549	235 32201	18542 73729	15 21984 32001	1284 92339 69649
99	4950	3 28350	245 02500	19503 33330	16 17083 32500	1379 07141 19050
100	5050	3 38350	255 02500	20503 33330	17 17083 32500	1479 07141 19050

SUMS OF POSITIVE POWERS $\sum_{k=1}^m k^n$

Table 23.4

$m \setminus n$	7	8	9
1	1	1	1
2	129	257	513
3	2316	6818	20196
4	18700	72354	2 82340
5	96825	4 62979	22 35465
6	3 76761	21 42595	123 13161
7	12 00304	79 07396	526 66768
8	32 97456	246 84612	1868 84496
9	80 80425	677 31333	5743 04985
10	180 80425	1677 31333	15743 04985
11	375 67596	3820 90214	39322 52676
12	733 99404	8120 71910	90920 33028
13	1361 47921	16278 02631	1 96965 32401
14	2415 61425	31035 91687	4 03575 79185
15	4124 20800	56664 82312	7 88009 38560
16	6808 56256	99614 49608	14 75204 15296
17	10911 94929	1 69372 07049	26 61082 91793
18	17034 14961	2 79571 67625	46 44675 82161
19	25972 86700	4 49407 30666	78 71552 79940
20	38772 86700	7 05407 30666	129 91552 79940
21	56783 75241	10 83635 90027	209 34353 26521
22	81727 33129	16 32394 63563	330 07045 44313
23	1 15775 58576	24 15504 48844	510 18572 05776
24	1 61640 30000	35 16257 63020	774 36647 46000
25	2 22675 45625	50 42136 53645	1155 83620 11625
26	3 02993 55801	71 30407 18221	1698 78656 90601
27	4 07597 09004	99 54702 54702	2461 34631 75588
28	5 42526 37516	137 32722 53038	3519 19191 28996
29	7 15025 13825	187 35186 65999	4969 90651 04865
30	9 33725 13825	252 96186 65999	6938 20651 04865
31	12 08851 27936	338 25097 03440	9582 16872 65536
32	15 52448 66304	448 20213 31216	13100 60593 54368
33	19 78633 09281	588 84299 49457	17741 75437 56321
34	25 03866 59425	767 42238 54353	23813 45365 22785
35	31 47259 56300	992 60992 44978	31695 01751 94660
36	39 30901 20396	1274 72091 52434	41851 01318 63076
37	48 80219 97529	1625 96886 06355	54847 18716 58153
38	60 24375 80121	2060 74807 44851	71368 79729 21001
39	73 96685 86800	2595 94900 05332	92241 63340 79760
40	90 35085 86800	3251 30900 05332	1 18456 03340 79760
41	109 82628 60681	4049 80152 34453	1 51194 22684 73721
42	132 88021 93929	5018 06672 30869	1 91861 36523 23193
43	160 06208 05036	6186 88675 08470	2 42120 62642 60036
44	191 98986 14700	7591 70911 33686	3 03932 81037 69540
45	229 35680 67825	9273 22165 24311	3 79600 87463 47665
46	272 93857 25041	11277 98287 56247	4 71819 89090 16721
47	323 60088 45504	13659 11154 18008	5 83732 93821 19488
48	382 30771 87776	16477 03958 47064	7 18993 48427 14176
49	450 13002 60625	19800 33264 16665	8 81834 84406 24625
50	528 25502 60625	23706 58264 16665	10 77147 34406 24625

Table 23.4 SUMS OF POSITIVE POWERS $\sum_{k=1}^m k^n$

$m \backslash n$	7			8			9			
51	617	99609	38476	28283	37709	87066	13	10563	86137	15076
52	720	80326	41004	33629	34995	18522	15	88554	44973	50788
53	838	27437	80841	39855	31899	29883	19	18530	80891	52921
54	972	16689	90825	47085	51512	69019	23	08961	40014	66265
55	1124	41042	25200	55458	90891	59644	27	69498	05854	50640
56	1297	11990	74736	65130	64007	33660	33	11115	00335	95536
57	1492	60965	67929	76273	55578	45661	39	46261	19889	79593
58	1713	40807	35481	89079	86395	63677	46	89027	07286	24521
59	1962	27322	20300	1 03762	90771	67998	55	55326	65472	79460
60	2242	20922	20300	1 20559	06771	67998	65	63096	25472	79460
61	2556	48350	56321	1 39729	79901	65279	77	32510	86401	13601
62	2908	64496	62529	1 61563	80957	50175	90	86219	51863	77153
63	3302	54303	01696	1 86379	38760	17696	106	49600	93432	30976
64	3742	34768	12800	2 14526	88527	28352	124	51040	78527	12960
65	4232	57047	03425	2 46391	36656	18977	145	22232	06906	03585
66	4778	08654	04481	2 82395	42718	88673	168	98500	07044	03521
67	5384	15770	09804	3 23002	19494	45314	196	19153	51006	98468
68	6056	45658	28236	3 68718	51890	98690	227	27863	53971	28036
69	6801	09190	80825	4 20098	35635	27331	262	73072	32327	04265
70	7624	63490	80825	4 77746	36635	27331	303	08433	02327	04265
71	8534	14692	39216	5 42321	71947	73092	348	93283	09511	53296
72	9537	20822	43504	6 14542	13310	81828	400	93152	87653	82288
73	10641	94807	62601	6 95188	14229	75909	459	80311	54736	50201
74	11857	07610	35625	7 85107	61631	79685	526	34352	62487	29625
75	13191	91497	07500	8 85220	53135	70310	601	42821	25280	26500
76	14656	43442	79276	9 96524	01010	25286	686	01885	63746	04676
77	16261	28675	46129	11 20097	63925	72967	781	17055	08237	76113
78	18017	84364	01041	12 57109	07632	56103	888	03947	17370	60721
79	19938	23453	87200	14 08819	95731	62664	1007	89106	77196	79040
80	22035	38653	87200	15 76592	11731	62664	1142	10879	57196	79040
81	24323	06578	42161	17 61894	13620	14505	1292	20343	10166	78161
82	26815	92048	98929	19 66308	22206	69481	1459	82298	14263	86193
83	29529	52558	88556	21 91537	44528	08522	1646	76323	66939	26596
84	32480	42905	44300	24 39413	33638	91018	1854	97898	52248	56260
85	35686	19993	72425	27 11903	86142	81643	2086	59593	15080	59385
86	39165	47815	94121	30 11121	78853	47499	2343	92334	88197	23001
87	42938	02610	81904	33 39333	46007	84620	2629	46750	30627	52528
88	47024	78207	18896	36 98967	98488	39916	2945	94588	48916	18576
89	51447	91556	14425	40 92626	86545	41997	3296	30228	85991	03785
90	56230	88456	14425	45 23094	07545	41997	3683	72277	75991	03785
91	61398	49475	50156	49 93346	60306	93518	4111	65257	77288	92196
92	66976	96076	73804	55 06565	47620	69134	4583	81394	10154	48868
93	72993	96947	34561	60 66147	28587	19535	5104	22502	40039	36161
94	79478	74541	53825	66 75716	22441	30351	5677	21982	62325	52865
95	86462	11837	63200	73 39136	65570	20976	6307	46923	59571	62240
96	93976	59315	74016	80 60526	23468	59312	7000	00323	17816	42496
97	1 02056	42160	52129	88 44269	59412	36273	7760	23429	04362	07713
98	1 10737	67693	76801	96 95032	61670	54129	8593	98205	25663	57601
99	1 20058	33041	67500	106 17777	31113	33330	9507	49930	00499	98500
100	1 30058	33041	67500	116 17777	31113	33330	10507	49930	00499	98500

SUMS OF POSITIVE POWERS $\sum_{k=1}^m k^n$

Table 23.4

$m \setminus n$	10				$m \setminus n$	10			
1				1	51	613	38941	75112	62626
2				1025	52	757	94452	34603	19650
3				60074	53	932	83199	38258	32699
4			11	08650	54	1143	66451	30907	53275
5			108	74275	55	1396	95967	52098	93900
6			713	40451	56	1700	26516	43060	08076
7			3538	15700	57	2062	29849	57628	99325
8			14275	57524	58	2493	10270	26623	05149
9			49143	41925	59	3004	21945	59629	46550
10	1		49143	41925	60	3608	88121	59629	46550
11		4	08517	66526	61	4322	22412	76258	29151
12		10	27691	30750	62	5161	52349	34941	69375
13		24	06276	22599	63	6146	45378	53759	60224
14		52	98822	77575	64	7299	37528	99828	07200
15		110	65326	68200	65	8645	64962	44456	97825
16		220	60442	95976	66	10213	98650	53564	93601
17		422	20381	96425	67	12036	82430	99082	55050
18		779	25054	23049	68	14150	74713	00654	65674
19		1392	35716	80850	69	16596	94119	07202	25475
20		2416	35716	80850	70	19421	69368	07202	25475
21		4084	34526	59051	71	22676	93723	17301	06676
22		6740	33754	50475	72	26420	84347	43545	94100
23		10882	98866	64124	73	30718	46930	40581	51749
24		17223	32676	29500	74	35642	45970	14140	29125
25		26760	06992	70125	75	41273	81117	23612	94750
26		40876	77949	23501	76	47702	70010	47012	36126
27		61465	89270	18150	77	55029	38057	72874	36775
28		91085	56937	13574	78	63365	15640	85236	36199
29	1	33156	29270	13775	79	72833	43249	11504	83400
30	1	92205	29270	13775	80	83570	85073	11504	83400
31	2	74168	12139	94576	81	95728	51619	02074	12201
32	3	86758	11208	37200	82	1 09473	31932	38034	70825
33	5	39916	01061	01649	83	1 24989	36051	10093	24274
34	7	46353	78601	61425	84	1 42479	48338	76074	16050
35	10	22208	52136	77050	85	1 62166	92382	16796	81675
36	13	87824	36537	40026	86	1 84297	08171	04827	52651
37	18	68682	80261	57875	87	2 09139	42312	96263	21500
38	24	96503	98741	46099	88	2 36989	52073	05665	33724
39	33	10544	59593	37700	89	2 68171	24066	05327	17325
40	43	59120	59593	37700	90	3 03039	08467	05327	17325
41	57	01386	52694	90101	91	3 41980	69648	23434	62726
42	74	09406	33911	67925	92	3 85419	54190	47066	76550
43	95	70554	57044	52174	93	4 33817	77262	26359	94799
44	122	90290	66428	70350	94	4 87679	28403	21259	64975
45	156	95353	55588	85975	95	5 47552	97795	59638	55600
46	199	37428	30416	62551	96	6 14036	24155	51139	60176
47	251	97341	52774	92600	97	6 87778	65424	46067	86225
48	316	89847	73860	37624	98	7 69485	93493	33614	75249
49	396	69074	36836	49625	99	8 59924	14243	42419	24250
50	494	34699	36836	49625	100	9 59924	14243	42419	24250

Table 23.5

 $x^n/n!$

$n \setminus x$	2	3	4	5
1	(0) 2.0000 00000	(0) 3.0000 00000	(0) 4.0000 00000	(0) 5.0000 00000
2	(0) 2.0000 00000	(0) 4.5000 00000	(0) 8.0000 00000	(1) 1.2500 00000
3	(0) 1.3333 33333	(0) 4.5000 00000	(1) 1.0666 66667	(1) 2.0833 33333
4	(- 1) 6.6666 66667	(0) 3.3750 00000	(1) 1.0666 66667	(1) 2.6041 66667
5	(- 1) 2.6666 66667	(0) 2.0250 00000	(0) 8.5333 33333	(1) 2.6041 66667
6	(- 2) 8.8888 88889	(0) 1.0125 00000	(0) 5.6888 88889	(1) 2.1701 38889
7	(- 2) 2.5396 82540	(- 1) 4.3392 85714	(0) 3.2507 93651	(1) 1.5500 99206
8	(- 3) 6.3492 06349	(- 1) 1.6272 32143	(0) 1.6253 96825	(0) 9.6881 20040
9	(- 3) 1.4109 34744	(- 2) 5.4241 07143	(- 1) 7.2239 85891	(0) 5.3822 88911
10	(- 4) 2.8218 69489	(- 2) 1.6272 32143	(- 1) 2.8895 94356	(0) 2.6911 44455
11	(- 5) 5.1306 71797	(- 3) 4.4379 05844	(- 1) 1.0507 61584	(0) 1.2232 47480
12	(- 6) 8.5511 19662	(- 3) 1.1094 76461	(- 2) 3.5025 38614	(- 1) 5.0968 64499
13	(- 6) 1.3155 56871	(- 4) 2.5603 30295	(- 2) 1.0777 04189	(- 1) 1.9603 32500
14	(- 7) 1.8793 66959	(- 5) 5.4864 22060	(- 3) 3.0791 54825	(- 2) 7.0011 87499
15	(- 8) 2.5058 22612	(- 5) 1.0972 84412	(- 4) 8.2110 79534	(- 2) 2.3337 29166
16	(- 9) 3.1322 78265	(- 6) 2.0574 08273	(- 4) 2.0527 69883	(- 3) 7.2929 03644
17	(-10) 3.6850 33252	(- 7) 3.6307 20481	(- 5) 4.8300 46785	(- 3) 2.1449 71660
18	(-11) 4.0944 81392	(- 8) 6.0512 00802	(- 5) 1.0733 43730	(- 4) 5.9582 54611
19	(-12) 4.3099 80412	(- 9) 9.5545 27581	(- 6) 2.2596 71010	(- 4) 1.5679 61740
20	(-13) 4.3099 80412	(- 9) 1.4331 79137	(- 7) 4.5193 42021	(- 5) 3.9199 04350
21	(-14) 4.1047 43250	(-10) 2.0473 98767	(- 8) 8.6082 70516	(- 6) 9.3331 05594
22	(-15) 3.7315 84772	(-11) 2.7919 07410	(- 8) 1.5651 40094	(- 6) 2.1211 60362
23	(-16) 3.2448 56324	(-12) 3.6416 18361	(- 9) 2.7219 82772	(- 7) 4.6112 18179
24	(-17) 2.7040 46937	(-13) 4.5520 22951	(-10) 4.5366 37953	(- 8) 9.6067 04540
25	(-18) 2.1632 37549	(-14) 5.4624 27542	(-11) 7.2586 20725	(- 8) 1.9213 40908
26	(-19) 1.6640 28884	(-15) 6.3028 01010	(-11) 1.1167 10881	(- 9) 3.6948 86361
27	(-20) 1.2326 13988	(-16) 7.0031 12233	(-12) 1.6543 86490	(-10) 6.8423 82151
28	(-22) 8.8043 85630	(-17) 7.5033 34535	(-13) 2.3634 09271	(-10) 1.2218 53955
29	(-23) 6.0719 90090	(-18) 7.7620 70209	(-14) 3.2598 74857	(-11) 2.1066 44751
30	(-24) 4.0479 93393	(-19) 7.7620 70209	(-15) 4.3464 99809	(-12) 3.5110 74585
31	(-25) 2.6116 08641	(-20) 7.5116 80847	(-16) 5.6083 86851	(-13) 5.6630 23524
32	(-26) 1.6322 55400	(-21) 7.0422 00794	(-17) 7.0104 83563	(-14) 8.8484 74256
33	(-28) 9.8924 56972	(-22) 6.4020 00722	(-18) 8.4975 55835	(-14) 1.3406 77918
34	(-29) 5.8190 92337	(-23) 5.6488 24167	(-19) 9.9971 24511	(-15) 1.9715 85173
35	(-30) 3.3251 95621	(-24) 4.8418 49286	(-19) 1.1425 28516	(-16) 2.8165 50247
36	(-31) 1.8473 30901	(-25) 4.0348 74405	(-20) 1.2694 76128	(-17) 3.9118 75343
37	(-33) 9.9855 72435	(-26) 3.2715 19788	(-21) 1.3724 06625	(-18) 5.2863 18031
38	(-34) 5.2555 64440	(-27) 2.5827 78780	(-22) 1.4446 38553	(-19) 6.9556 81620
39	(-35) 2.6951 61251	(-28) 1.9867 52907	(-23) 1.4816 80567	(-20) 8.9175 40538
40	(-36) 1.3475 80626	(-29) 1.4900 64681	(-24) 1.4816 80567	(-20) 1.1146 92567
41	(-38) 6.5735 64027	(-30) 1.0902 91230	(-25) 1.4455 42017	(-21) 1.3593 81180
42	(-39) 3.1302 68584	(-32) 7.7877 94498	(-26) 1.3767 06683	(-22) 1.6183 10928
43	(-40) 1.4559 38876	(-33) 5.4333 44998	(-27) 1.2806 57379	(-23) 1.8817 56893
44	(-42) 6.6179 03984	(-34) 3.7045 53408	(-28) 1.1642 33981	(-24) 2.1383 60106
45	(-43) 2.9412 90659	(-35) 2.4697 02272	(-29) 1.0348 74650	(-25) 2.3759 55673
46	(-44) 1.2788 22026	(-36) 1.6106 75395	(-31) 8.9989 09998	(-26) 2.5825 60514
47	(-46) 5.4417 95855	(-37) 1.0280 90678	(-32) 7.6586 46807	(-27) 2.7474 04802
48	(-47) 2.2674 14939	(-39) 6.4255 66735	(-33) 6.3822 05673	(-28) 2.8618 80003
49	(-49) 9.2547 54855	(-40) 3.9340 20450	(-34) 5.2099 63814	(-29) 2.9202 85717
50	(-50) 3.7019 01942	(-41) 2.3604 12270	(-35) 4.1679 71052	(-30) 2.9202 85717

For $x=1$, see Table 6.3.

$x^n/n!$

Table 23.5

$n \setminus x$	6	7	8	9
1	(0) 6.0000 00000	(0) 7.0000 00000	(0) 8.0000 00000	(0) 9.0000 00000
2	(1) 1.8000 00000	(1) 2.4500 00000	(1) 3.2000 00000	(1) 4.0500 00000
3	(1) 3.6000 00000	(1) 5.7166 66667	(1) 8.5333 33333	(2) 1.2150 00000
4	(1) 5.4000 00000	(2) 1.0004 16667	(2) 1.7066 66667	(2) 2.7337 50000
5	(1) 6.4800 00000	(2) 1.4005 83333	(2) 2.7306 66667	(2) 4.9207 50000
6	(1) 6.4800 00000	(2) 1.6340 13889	(2) 3.6408 88889	(2) 7.3811 25000
7	(1) 5.5542 85714	(2) 1.6340 13889	(2) 4.1610 15873	(2) 9.4900 17857
8	(1) 4.1657 14286	(2) 1.4297 62153	(2) 4.1610 15873	(3) 1.0676 27009
9	(1) 2.7771 42857	(2) 1.1120 37230	(2) 3.6986 80776	(3) 1.0676 27009
10	(1) 1.6662 85714	(1) 7.7842 60610	(2) 2.9589 44621	(2) 9.6086 43080
11	(0) 9.0888 31169	(1) 4.9536 20388	(2) 2.1519 59724	(2) 7.8616 17066
12	(0) 4.5444 15584	(1) 2.8896 11893	(2) 1.4346 39816	(2) 5.8962 12799
13	(0) 2.0974 22577	(1) 1.5559 44865	(1) 8.8285 52715	(2) 4.0819 93476
14	(- 1) 8.9889 53903	(0) 7.7797 24327	(1) 5.0448 87266	(2) 2.6241 38663
15	(- 1) 3.5955 81561	(0) 3.6305 38019	(1) 2.6906 06542	(2) 1.5744 83198
16	(- 1) 1.3483 43085	(0) 1.5883 60383	(1) 1.3453 03271	(1) 8.8564 67989
17	(- 2) 4.7588 57949	(- 1) 6.5403 07461	(0) 6.3308 38922	(1) 4.6887 18347
18	(- 2) 1.5862 85983	(- 1) 2.5434 52902	(0) 2.8137 06187	(1) 2.3443 59174
19	(- 3) 5.0093 24157	(- 2) 9.3706 15953	(0) 1.1847 18395	(1) 1.1104 85924
20	(- 3) 1.5027 97247	(- 2) 3.2797 15584	(- 1) 4.7388 73579	(0) 4.9971 86659
21	(- 4) 4.2937 06420	(- 2) 1.0932 38528	(- 1) 1.8052 85173	(0) 2.1416 51425
22	(- 4) 1.1710 10842	(- 3) 3.4784 86225	(- 2) 6.5646 73356	(- 1) 8.7613 01286
23	(- 5) 3.0548 10892	(- 3) 1.0586 69721	(- 2) 2.2833 64645	(- 1) 3.4283 35286
24	(- 6) 7.6370 27229	(- 4) 3.0877 86685	(- 3) 7.6112 15485	(- 1) 1.2856 25732
25	(- 6) 1.8328 86535	(- 5) 8.6458 02719	(- 3) 2.4355 88955	(- 2) 4.6282 52636
26	(- 7) 4.2297 38158	(- 5) 2.3277 16117	(- 4) 7.4941 19862	(- 2) 1.6020 87451
27	(- 8) 9.3994 18128	(- 6) 6.0348 19562	(- 4) 2.2204 79959	(- 3) 5.3402 91503
28	(- 8) 2.0141 61027	(- 6) 1.5087 04890	(- 5) 6.3442 28455	(- 3) 1.7165 22269
29	(- 9) 4.1672 29712	(- 7) 3.6417 01460	(- 5) 1.7501 31987	(- 4) 5.3271 38076
30	(-10) 8.3344 59424	(- 8) 8.4973 03406	(- 6) 4.6670 18633	(- 4) 1.5981 41423
31	(-10) 1.6131 21179	(- 8) 1.9187 45930	(- 6) 1.2043 91905	(- 5) 4.6397 65421
32	(-11) 3.0246 02210	(- 9) 4.1972 56723	(- 7) 3.0109 79763	(- 5) 1.3049 34025
33	(-12) 5.4992 76746	(-10) 8.9032 71836	(- 8) 7.2993 44881	(- 6) 3.5589 10976
34	(-13) 9.7046 06022	(-10) 1.8330 26554	(- 8) 1.7174 92913	(- 7) 9.4206 46701
35	(-13) 1.6636 46746	(-11) 3.6660 53109	(- 9) 3.9256 98087	(- 7) 2.4224 52009
36	(-14) 2.7727 44578	(-12) 7.1284 36600	(-10) 8.7237 73527	(- 8) 6.0561 30022
37	(-15) 4.4963 42559	(-12) 1.3486 23141	(-10) 1.8862 21303	(- 8) 1.4731 12708
38	(-16) 7.0994 88251	(-13) 2.4843 05785	(-11) 3.9709 92217	(- 9) 3.4889 51151
39	(-16) 1.0922 28962	(-14) 4.4590 10384	(-12) 8.1456 25061	(-10) 8.0514 25733
40	(-17) 1.6383 43442	(-15) 7.8032 68172	(-12) 1.6291 25012	(-10) 1.8115 70790
41	(-18) 2.3975 75769	(-15) 1.3322 65298	(-13) 3.1787 80512	(-11) 3.9766 18807
42	(-19) 3.4251 08242	(-16) 2.2204 42163	(-14) 6.0548 20022	(-12) 8.5213 26015
43	(-20) 4.7792 20803	(-17) 3.6146 73288	(-14) 1.1264 78144	(-12) 1.7835 33352
44	(-21) 6.5171 19277	(-18) 5.7506 16595	(-15) 2.0481 42079	(-13) 3.6481 36402
45	(-22) 8.6894 92369	(-19) 8.9454 03592	(-16) 3.6411 41474	(-14) 7.2962 72802
46	(-22) 1.1334 12048	(-19) 1.3612 57068	(-17) 6.3324 19956	(-14) 1.4275 31635
47	(-23) 1.4469 08998	(-20) 2.0274 04144	(-17) 1.0778 58716	(-15) 2.7335 71217
48	(-24) 1.8086 36247	(-21) 2.9566 31044	(-18) 1.7964 31193	(-16) 5.1254 46032
49	(-25) 2.2146 56629	(-22) 4.2237 58634	(-19) 2.9329 48887	(-17) 9.4140 84548
50	(-26) 2.6575 87955	(-23) 5.9132 62088	(-20) 4.6927 18219	(-17) 1.6945 35219

24. Combinatorial Analysis

K. GOLDBERG,¹ M. NEWMAN,² E. HAYNSWORTH³

Contents

	Page
Mathematical Properties	822
24.1. Basic Numbers	822
24.1.1 Binomial Coefficients	822
24.1.2 Multinomial Coefficients	823
24.1.3 Stirling Numbers of the First Kind	824
24.1.4 Stirling Numbers of the Second Kind	824
24.2. Partitions	825
24.2.1 Unrestricted Partitions	825
24.2.2 Partitions Into Distinct Parts	825
24.3. Number Theoretic Functions	826
24.3.1 The Möbius Function	826
24.3.2 The Euler Function	826
24.3.3 Divisor Functions	827
24.3.4 Primitive Roots	827
References	827
Table 24.1. Binomial Coefficients $\binom{n}{m}$	828
$n \leq 50, m \leq 25$	
Table 24.2. Multinomials (Including a List of Partitions)	831
$n \leq 10$	
Table 24.3. Stirling Numbers of the First Kind $S_n^{(m)}$	833
$n \leq 25$	
Table 24.4. Stirling Numbers of the Second Kind $\mathfrak{S}_n^{(m)}$	835
$n \leq 25$	
Table 24.5. Number of Partitions and Partitions Into Distinct Parts . .	836
$p(n), q(n), n \leq 500$	
Table 24.6. Arithmetic Functions	840
$\varphi(n), \sigma_0(n), \sigma_1(n), n \leq 1000$	
Table 24.7. Factorizations	844
$n < 10000$	
Table 24.8. Primitive Roots, Factorization of $p-1$	864
$n < 10000$	
Table 24.9. Primes	870
$p \leq 10^5$	

^{1, 2} National Bureau of Standards.

³ National Bureau of Standards. (Presently, Auburn University.)

24. Combinatorial Analysis

Mathematical Properties

In each sub-section of this chapter we use a fixed format which emphasizes the use and methods of extending the accompanying tables. The format follows this form:

I. Definitions

- A. Combinatorial
- B. Generating functions
- C. Closed form

II. Relations

- A. Recurrences
- B. Checks in computing
- C. Basic use in numerical analysis

III. Asymptotic and Special Values

In general the notations used are standard. This includes the difference operator Δ defined on functions of x by $\Delta f(x) = f(x+1) - f(x)$, $\Delta^{n+1}f(x) = \Delta(\Delta^n f(x))$, the Kronecker delta δ_{ij} , the Riemann zeta function $\zeta(s)$ and the greatest common divisor symbol (m, n) . The range of the summands for a summation sign without limits is explained to the right of the formula.

The notations which are not standard are those for the multinomials which are arbitrary shorthand for use in this chapter, and those for the Stirling numbers which have never been standardized. A short table of various notations for these numbers follows:

Notations for the Stirling Numbers

Reference	First Kind	Second Kind
This chapter	$S_n^{(m)}$	$\mathfrak{S}_n^{(m)}$
[24.2] Fort	$S_n^{(m)}$	$\mathcal{P}_n^{(m)}$ *
[24.7] Jordan	$S_n^{(m)}$	\mathfrak{E}_n^m *
[24.10] Moser and Wyman	$S_n^{(m)}$	σ_n^m
[24.9] Milne-Thomson	$\binom{n-1}{m-1} B_{n-m}^{(n)}$	$\binom{n}{m} B_{n-m}^{(n-m)}$
[24.15] Riordan	$s(n, m)$	$S(n, m)$
[24.1] Carlitz }	$(-1)^{n-m} S_1(n-1, n-m)$	$S_2(m, n-m)$
[24.3] Gould }		
Miksa	$S(n-m+1, n)$	$m S_n$
(Unpublished tables)		
[24.17] Gupta		$u(n, m)$

We feel that a capital S is natural for Stirling numbers of the first kind; it is infrequently used for other notation in this context. But once it is used we have difficulty finding a suitable symbol for Stirling numbers of the second kind. The numbers are sufficiently important to warrant

a special and easily recognizable symbol, and yet that symbol must be easy to write. We have settled on a script capital \mathfrak{S} without any certainty that we have settled this question permanently.

We feel that the subscript-superscript notation emphasizes the generating functions (which are powers of mutually inverse functions) from which most of the important relations flow.

24.1. Basic Numbers

24.1.1 Binomial Coefficients

I. Definitions

A. $\binom{n}{m}$ is the number of ways of choosing m objects from a collection of n distinct objects without regard to order.

B. Generating functions

$$* (1+x)^n = \sum_{m=0}^n \binom{n}{m} x^m \quad n=0, 1, \dots$$

$$(1-x)^{-m-1} = \sum_{n=m}^{\infty} \binom{n}{m} x^{n-m} \quad |x| < 1$$

C. Closed form

$$\binom{n}{m} = \frac{n!}{m!(n-m)!} = \binom{n}{n-m} \quad n \geq m$$

$$= \frac{n(n-1)\dots(n-m+1)}{m!}$$

II. Relations

A. Recurrences

$$\binom{n+1}{m} = \binom{n}{m} + \binom{n}{m-1} \quad n \geq m \geq 1$$

$$= \binom{n}{m} + \binom{n-1}{m-1} + \dots + \binom{n-m}{0} \quad n \geq m$$

B. Checks

$$\sum_{m=0}^n \binom{r}{m} \binom{s}{n-m} = \binom{r+s}{n} \quad r+s \geq n$$

$$\sum_{m=0}^n (-1)^{n-m} \binom{r}{m} = \binom{r-1}{n} \quad r \geq n+1$$

$$\binom{n}{m} \equiv \binom{n_0}{m_0} \binom{n_1}{m_1} \dots \pmod{p} \quad p \text{ a prime}$$

where

$$n = \sum_{k=0}^{\infty} n_k p^k, \quad m = \sum_{k=0}^{\infty} m_k p^k \quad p > m_k, n_k \geq 0$$

$$\begin{aligned} & \sum_{m=0}^s (-1)^m \binom{n}{m} f(x-m) \\ &= \sum_{k=0}^s (-1)^{s-k} \binom{n-k-1}{s-k} \Delta^k f(x-s) \quad s < n \end{aligned}$$

C. Numerical analysis

$$\begin{aligned} \Delta^n f(x) &= \sum_{m=0}^n (-1)^{n-m} \binom{n}{m} f(x+m) \\ &= \sum_{k=0}^r \binom{r}{k} \Delta^{n+k} f(x-r) \end{aligned}$$

III. Special Values

$$\begin{aligned} \binom{n}{0} &= \binom{n}{n} = 1 \\ \binom{2n}{n} &= \frac{2^n(2n-1)(2n-3)\dots 3 \cdot 1}{n!} \end{aligned}$$

24.1.2 Multinomial Coefficients

I. Definitions

A. $(n; n_1, n_2, \dots, n_m)$ is the number of ways of putting $n = n_1 + n_2 + \dots + n_m$ different objects into m different boxes with n_k in the k -th box, $k = 1, 2, \dots, m$.

$(n; a_1, a_2, \dots, a_n)^*$ is the number of permutations of $n = a_1 + 2a_2 + \dots + na_n$ symbols composed of a_k cycles of length k for $k = 1, 2, \dots, n$.

$(n; a_1, a_2, \dots, a_n)'$ is the number of ways of partitioning a set of $n = a_1 + 2a_2 + \dots + na_n$ different objects into a_k subsets containing k objects for $k = 1, 2, \dots, n$.

B. Generating functions

$$(x_1 + x_2 + \dots + x_m)^n = \Sigma(n; n_1, n_2, \dots, n_m) x_1^{n_1} x_2^{n_2} \dots x_m^{n_m} \quad \text{summed over } n_1 + n_2 + \dots + n_m = n$$

$$\left(\sum_{k=1}^{\infty} \frac{x_k}{k} t^k \right)^m = m! \sum_{n=m}^{\infty} \frac{t^n}{n!} \Sigma(n; a_1, a_2, \dots, a_n)^* x_1^{a_1} x_2^{a_2} \dots x_n^{a_n} \quad \text{summed over } a_1 + 2a_2 + \dots + na_n = n$$

$$\left(\sum_{k=1}^{\infty} \frac{x_k}{k!} t^k \right)^m = m! \sum_{n=m}^{\infty} \frac{t^n}{n!} \Sigma(n; a_1, a_2, \dots, a_n)' x_1^{a_1} x_2^{a_2} \dots x_n^{a_n} \quad \text{and } a_1 + a_2 + \dots + a_n = m$$

C. Closed forms

$$(n; n_1, n_2, \dots, n_m) = n! / n_1! n_2! \dots n_m! \quad n_1 + n_2 + \dots + n_m = n$$

$$(n; a_1, a_2, \dots, a_n)^* = n! / 1^{a_1} a_1! 2^{a_2} a_2! \dots n^{a_n} a_n! \quad a_1 + 2a_2 + \dots + na_n = n$$

$$(n; a_1, a_2, \dots, a_n)' = n! / (1!)^{a_1} a_1! (2!)^{a_2} a_2! \dots (n!)^{a_n} a_n! \quad a_1 + a_2 + \dots + a_n = n$$

II. Relations

A. Recurrence

$$(n+m; n_1+1, n_2+1, \dots, n_m+1) = \sum_{k=1}^m (n+m-1; n_1+1, \dots, n_{k-1}+1, n_k, n_{k+1}+1, \dots, n_m+1)$$

B. Checks

$$* \Sigma(n; n_1, n_2, \dots, n_m) = \begin{cases} m^n & \text{all } n_i \geq 1 \\ m! S_n^{(m)} & \end{cases} \quad \text{summed over } n_1 + n_2 + \dots + n_m = n$$

$$\Sigma(n; a_1, a_2, \dots, a_n)^* = (-1)^{n-m} S_n^{(m)} \quad \text{summed over } a_1 + 2a_2 + \dots + na_n = n \text{ and } a_1 + a_2 + \dots + a_n = m$$

$$\Sigma(n; a_1, a_2, \dots, a_n)' = S_n^{(m)}$$

C. Numerical analysis (Faà di Bruno's formula)

$$\frac{d^n}{dx^n} f(g(x)) = \sum_{m=0}^n f^{(m)}(g(x)) \Sigma(n; a_1, a_2, \dots, a_n)' \{g'(x)\}^{a_1} \{g''(x)\}^{a_2} \dots \{g^{(n)}(x)\}^{a_n}$$

summed over $a_1 + 2a_2 + \dots + na_n = n$ and $a_1 + a_2 + \dots + a_n = m$.

*See page II.

$$\begin{vmatrix}
 P_1 & 1 & 0 & \dots & 0 \\
 P_2 & P_1 & 2 & \dots & \cdot \\
 P_3 & P_2 & P_1 & \dots & \cdot \\
 \cdot & \cdot & \cdot & \dots & \cdot \\
 \cdot & \cdot & \cdot & \dots & 0 \\
 \cdot & \cdot & \cdot & \dots & n-1 \\
 P_n & P_{n-1} & P_{n-2} & \dots & P_1
 \end{vmatrix} = \Sigma (-1)^{n-\Sigma a_i} (n; a_1, a_2, \dots, a_n) * P_1^{a_1} P_2^{a_2} \dots P_n^{a_n}$$

summed over $a_1+2a_2+\dots+na_n=n$; e.g. if $P_k=\Sigma_{j=1}^k x_j^k$ for $k=1, 2, \dots, n$ then the determinant and sum equal $n! \Sigma x_1 x_2 \dots x_n$, the latter sum denoting the n -th elementary symmetric function of x_1, x_2, \dots, x_r .

24.1.3 Stirling Numbers of the First Kind

I. Definitions

A. $(-1)^{n-m} S_n^{(m)}$ is the number of permutations of n symbols which have exactly m cycles.

B. Generating functions

$$x(x-1)\dots(x-n+1) = \sum_{m=0}^n S_n^{(m)} x^m$$

$$\{\ln(1+x)\}^m = m! \sum_{n=m}^{\infty} \frac{S_n^{(m)} x^n}{n!} \quad |x| < 1$$

C. Closed form (see closed form for $\mathfrak{S}_n^{(m)}$)

$$S_n^{(m)} = \sum_{k=0}^{n-m} (-1)^k \binom{n-1+k}{n-m+k} \binom{2n-m}{n-m-k} \mathfrak{S}_{n-m+k}^{(k)}$$

II. Relations

A. Recurrences

$$S_{n+1}^{(m)} = S_n^{(m-1)} - n S_n^{(m)} \quad n \geq m \geq 1$$

$$\binom{m}{r} S_n^{(m)} = \sum_{k=m-r}^{n-r} \binom{n}{k} S_{n-k}^{(r)} S_k^{(m-r)} \quad n \geq m \geq r$$

B. Checks

$$\sum_{m=1}^n S_n^{(m)} = 0 \quad n > 1$$

$$\sum_{m=0}^n (-1)^{n-m} S_n^{(m)} = n!$$

$$\sum_{k=m}^n S_{n+1}^{(k+1)} n^{k-m} = S_n^{(m)}$$

C. Numerical analysis

$$\frac{d^m}{dx^m} f(x) = m! \sum_{n=m}^{\infty} \frac{S_n^{(m)}}{n!} \Delta^n f(x)$$

if convergent.

III. Asymptotics and Special Values

$$|S_n^{(m)}| \sim (n-1)! (\gamma + \ln n)^{m-1} / (m-1)!$$

for $m = o(\ln n)$

$$\lim_{m \rightarrow \infty} \frac{S_{n+m}^{(m)}}{m^{2n}} = \frac{(-1)^n}{2^n n!}$$

$$\lim_{n \rightarrow \infty} \frac{S_{n+1}^{(m)}}{n S_n^{(m)}} = -1$$

$$S_n^{(0)} = \delta_{0n}$$

$$S_n^{(1)} = (-1)^{n-1} (n-1)!$$

$$S_n^{(n-1)} = -\binom{n}{2}$$

$$S_n^{(n)} = 1$$

24.1.4 Stirling Numbers of the Second Kind

I. Definitions

A. $\mathfrak{S}_n^{(m)}$ is the number of ways of partitioning a set of n elements into m non-empty subsets.

B. Generating functions

$$x^n = \sum_{m=0}^n \mathfrak{S}_n^{(m)} x(x-1)\dots(x-m+1)$$

$$(e^x - 1)^m = m! \sum_{n=m}^{\infty} \frac{\mathfrak{S}_n^{(m)} x^n}{n!}$$

$$(1-x)^{-1} (1-2x)^{-1} \dots (1-mx)^{-1} = \sum_{n=m}^{\infty} \mathfrak{S}_n^{(m)} x^{n-m} \quad |x| < m^{-1}$$

C. Closed form

$$\mathfrak{S}_n^{(m)} = \frac{1}{m!} \sum_{k=0}^m (-1)^{m-k} \binom{m}{k} k^n$$

II. Relations

A. Recurrences

$$\mathfrak{S}_{n+1}^{(m)} = m \mathfrak{S}_n^{(m)} + \mathfrak{S}_n^{(m-1)} \quad n \geq m \geq 1$$

$$\binom{m}{r} \mathfrak{S}_n^{(m)} = \sum_{k=m-r}^{n-r} \binom{n}{k} \mathfrak{S}_{n-k}^{(r)} \mathfrak{S}_k^{(m-r)} \quad n \geq m \geq r$$

B. Checks

$$\sum_{m=0}^n (-1)^{n-m} m! \mathfrak{S}_n^{(m)} = 1$$

$$\sum_{k=m}^n \mathfrak{S}_{k-1}^{(m-1)} m^{n-k} = \mathfrak{S}_n^{(m)}$$

$$\mathfrak{S}_n^{(m)} = \sum_{k=0}^{n-m} (-1)^k \binom{n-1+k}{n-m+k} \binom{2n-m}{n-m-k} \mathfrak{S}_{n-m+k}^{(k)}$$

$$\sum_{k=m}^n \mathfrak{S}_k^{(m)} \mathfrak{S}_n^{(k)} = \sum_{k=m}^n \mathfrak{S}_n^{(k)} \mathfrak{S}_k^{(m)} = \delta_{mn}$$

C. Numerical analysis

$$\Delta^m f(x) = m! \sum_{n=m}^{\infty} \frac{\mathfrak{S}_n^{(m)}}{n!} f^{(n)}(x) \quad \text{if convergent}$$

$$\sum_{k=0}^n k^m = \sum_{k=0}^m k! \mathfrak{S}_m^{(k)} \binom{n+1}{k+1}$$

$$\sum_{k=0}^n k^m x^k = \sum_{j=0}^m \mathfrak{S}_m^{(j)} x^j \frac{d^j}{dx^j} \left\{ \frac{1-x^{n+1}}{1-x} \right\}$$

III. Asymptotics and Special Values

$$\lim_{n \rightarrow \infty} m^{-n} \mathfrak{S}_n^{(m)} = m!^{-1}$$

$$\mathfrak{S}_{n+m}^{(m)} \sim \frac{m^{2n}}{2^n n!} \quad \text{for } n = o(m^2)$$

$$\lim_{n \rightarrow \infty} \frac{\mathfrak{S}_{n+1}^{(m)}}{\mathfrak{S}_n^{(m)}} = m$$

$$\mathfrak{S}_n^{(0)} = \delta_{0n}$$

$$\mathfrak{S}_n^{(1)} = \mathfrak{S}_n^{(n)} = 1$$

$$\mathfrak{S}_n^{(n-1)} = \binom{n}{2}$$

24.2. Partitions

24.2.1 Unrestricted Partitions

I. Definitions

A. $p(n)$ is the number of decompositions of n into integer summands without regard to order. E.g., $5 = 1 + 4 = 2 + 3 = 1 + 1 + 3 = 1 + 2 + 2 = 1 + 1 + 1 + 2 = 1 + 1 + 1 + 1 + 1$ so that $p(5) = 7$.

B. Generating function

$$\sum_{n=0}^{\infty} p(n) x^n = \prod_{n=1}^{\infty} (1-x^n)^{-1} = \left\{ \sum_{n=-\infty}^{\infty} (-1)^n x^{\frac{3n^2+n}{2}} \right\}^{-1} \quad |x| < 1$$

C. Closed form

$$p(n) = \frac{1}{\pi\sqrt{2}} \sum_{k=1}^{\infty} \sqrt{k} A_k(n) \frac{d}{dn} \frac{\sinh \left\{ \frac{\pi}{k} \sqrt{\frac{2}{3}} \sqrt{n - \frac{1}{24}} \right\}}{\sqrt{n - \frac{1}{24}}}$$

where

$$A_k(n) = \sum_{\substack{0 < h \leq k \\ (h, k) = 1}} e^{\pi i s(h, k)} e^{-\frac{2\pi i h n}{k}}$$

$$s(h, k) = \sum_{j=1}^{k-1} \frac{j}{k} \left(\left(\frac{hj}{k} \right) \right)$$

$$\begin{aligned} ((x)) &= x - [x] - \frac{1}{2} \quad \text{if } x \text{ is not an integer} \\ &= 0 \quad \text{if } x \text{ is an integer} \end{aligned}$$

II. Relations

A. Recurrence

$$\begin{aligned} p(n) &= \sum_{1 \leq \frac{3k^2 \pm k}{2} \leq n} (-1)^{k-1} p \left(n - \frac{3k^2 \pm k}{2} \right) \quad p(0) = 1 \\ &= \frac{1}{n} \sum_{k=1}^n \sigma_1(k) p(n-k) \end{aligned}$$

B. Check

$$p(n) + \sum_{1 \leq \frac{3k^2 \pm k}{2} \leq n} (-1)^k \frac{3k^2 \pm k}{2} p \left(n - \frac{3k^2 \pm k}{2} \right) = \sigma_1(n)$$

III. Asymptotics

$$p(n) \sim \frac{1}{4n\sqrt{3}} e^{\pi\sqrt{\frac{2}{3}}\sqrt{n}}$$

24.2.2 Partitions Into Distinct Parts

I. Definitions

A. $q(n)$ is the number of decompositions of n into distinct integer summands without regard to order. E.g., $5 = 1 + 4 = 2 + 3$ so that $q(5) = 3$.

B. Generating function

$$\sum_{n=0}^{\infty} q(n) x^n = \prod_{n=1}^{\infty} (1+x^n) = \prod_{n=1}^{\infty} (1-x^{2n-1})^{-1} \quad |x| < 1$$

C. Closed form

$$q(n) = \frac{1}{\sqrt{2}} \sum_{k=1}^{\infty} A_{2k-1}(n) \frac{d}{dn} J_0 \left(\frac{\pi i}{2k-1} \sqrt{\frac{1}{3}} \sqrt{n + \frac{1}{24}} \right)$$

where $J_0(x)$ is the Bessel function of order 0 and $A_{2k-1}(n)$ was defined in part I.C. of the previous subsection.

II. Relations

A. Recurrences

$$\sum_{0 \leq \frac{3k^2 \pm k}{2} \leq n} (-1)^k q\left(n - \frac{3k^2 \pm k}{2}\right) = (-1)^r \text{ if } n = 3r^2 \pm r$$

$$q(0) = 1$$

$$= 0 \text{ otherwise}$$

$$q(n) = \frac{1}{n} \sum_{k=1}^n \left\{ \sigma_1(k) - 2\sigma_1\left(\frac{k}{2}\right) \right\} q(n-k)$$

B. Check

$$\sum_{0 \leq 3k^2 \pm k \leq n} (-1)^k q(n - (3k^2 \pm k)) = 1 \text{ if } n = \frac{r^2 - r}{2}$$

$$= 0 \text{ otherwise.}$$

III. Asymptotics

$$q(n) \sim \frac{1}{4 \cdot 3^{1/4} \cdot n^{3/4}} e^{\pi \sqrt{1/3} \sqrt{n}}$$

24.3. Number Theoretic Functions

24.3.1 The Möbius Function

I. Definitions

A. $\mu(n) = 1$ if $n = 1$
 $= (-1)^k$ if n is the product of k distinct primes
 $= 0$ if n is divisible by a square > 1 .

B. Generating functions

$$\sum_{n=1}^{\infty} \mu(n) n^{-s} = 1/\zeta(s) \quad \Re s > 1$$

$$\sum_{n=1}^{\infty} \frac{\mu(n) x^n}{1-x^n} = x \quad |x| < 1$$

II. Relations

A. Recurrence

$$\mu(mn) = \mu(m)\mu(n) \text{ if } (m, n) = 1$$

$$= 0 \text{ if } (m, n) > 1$$

B. Check

$$\sum_{d|n} \mu(d) = \delta_{n1}$$

C. Numerical analysis

$$g(n) = \sum_{d|n} f(d) \text{ for all } n \text{ if and only if}$$

$$f(n) = \sum_{d|n} \mu(d) g(n/d) \text{ for all } n$$

$$g(n) = \prod_{d|n} f(d) \text{ for all } n \text{ if and only if}$$

$$f(n) = \prod_{d|n} g(n/d)^{\mu(d)} \text{ for all } n$$

$$g(x) = \sum_{n=1}^{\lfloor x \rfloor} f(x/n) \text{ for all } x > 0 \text{ if and only if}$$

$$f(x) = \sum_{n=1}^{\lfloor x \rfloor} \mu(n) g(x/n) \text{ for all } x > 0$$

$$g(x) = \sum_{n=1}^{\infty} f(nx) \text{ for all } x > 0 \text{ if and only if}$$

$$f(x) = \sum_{n=1}^{\infty} \mu(n) g(nx) \text{ for all } x > 0$$

$$\text{and if } \sum_{m=1}^{\infty} \sum_{n=1}^{\infty} |f(mnx)| = \sum_{n=1}^{\infty} \sigma_0(n) |f(nx)| \text{ converges.}$$

The cyclotomic polynomial of order n is $\prod_{d|n} (x^d - 1)^{\mu(n/d)}$

III. Asymptotics

$$\sum_{n=1}^{\infty} \frac{\mu(n)}{n} = 0$$

$$\sum_{n=1}^{\infty} \frac{\mu(n)}{n} \ln n = -1$$

$$\sum_{n \leq x} \mu(n) = O(xe^{-c\sqrt{\ln x}})$$

24.3.2 The Euler Totient Function

I. Definitions

A. $\varphi(n)$ is the number of integers not exceeding and relatively prime to n .

B. Generating functions

$$\sum_{n=1}^{\infty} \varphi(n) n^{-s} = \frac{\zeta(s-1)}{\zeta(s)} \quad \Re s > 2$$

$$\sum_{n=1}^{\infty} \frac{\varphi(n) x^n}{1-x^n} = \frac{x}{(1-x)^2} = \sum_{k=1}^{\infty} k x^k \quad |x| < 1$$

C. Closed form

$$\varphi(n) = n \prod_{p|n} \left(1 - \frac{1}{p}\right)$$

over distinct primes p dividing n .

II. Relations

A. Recurrence

$$\varphi(mn) = \varphi(m)\varphi(n) \quad (m, n) = 1$$

B. Checks

$$\sum_{d|n} \varphi(d) = n$$

$$\varphi(n) = \sum_{d|n} \mu\left(\frac{n}{d}\right) d$$

$$a^{\varphi(n)} \equiv 1 \pmod{n} \quad (a, n) = 1$$

III. Asymptotics

$$\frac{1}{n^2} \sum_{k=1}^n \varphi(k) = \frac{3}{\pi^2} + O\left(\frac{\ln n}{n}\right)$$

24.3.3 Divisor Functions

I. Definitions

A. $\sigma_k(n)$ is the sum of the k -th powers of the divisors of n . Often $\sigma_0(n)$ is denoted by $d(n)$, and $\sigma_1(n)$ by $\sigma(n)$.

B. Generating functions

$$\sum_{n=1}^{\infty} \sigma_k(n)n^{-s} = \zeta(s)\zeta(s-k) \quad \Re s > k+1$$

$$\sum_{n=1}^{\infty} \sigma_k(n)x^n = \sum_{n=1}^{\infty} \frac{n^k x^n}{1-x^n} \quad |x| < 1$$

C. Closed form

$$\sigma_k(n) = \sum_{d|n} d^k = \prod_{i=1}^s \frac{p_i^{k(\alpha_i+1)} - 1}{p_i^k - 1} \quad n = p_1^{\alpha_1} p_2^{\alpha_2} \dots p_s^{\alpha_s}$$

II. Relations

A. Recurrences

$$\sigma_k(mn) = \sigma_k(m)\sigma_k(n) \quad (m, n) = 1$$

$$\sigma_k(np) = \sigma_k(n)\sigma_k(p) - p^k \sigma_k(n/p) \quad p \text{ prime}$$

III. Asymptotics

$$\frac{1}{n} \sum_{m=1}^n \sigma_0(m) = \ln n + 2\gamma - 1 + O(n^{-1})$$

(γ = Euler's constant)

$$\frac{1}{n^2} \sum_{m=1}^n \sigma_1(m) = \frac{\pi^2}{12} + O\left(\frac{\ln n}{n}\right)$$

24.3.4 Primitive Roots

I. Definitions

The integers not exceeding and relatively prime to a fixed integer n form a group; the group is cyclic if and only if $n=2, 4$ or n is of the form p^k or $2p^k$ where p is an odd prime. Then g is a primitive root of n if it generates that group; i.e., if $g, g^2, \dots, g^{\varphi(n)}$ are distinct modulo n . There are $\varphi(\varphi(n))$ primitive roots of n .

II. Relations

A. Recurrences. If g is a primitive root of a prime p and $g^{p-1} \not\equiv 1 \pmod{p^2}$ then g is a primitive root of p^k for all k . If $g^{p-1} \equiv 1 \pmod{p^2}$ then $g+p$ is a primitive root of p^k for all k .

If g is a primitive root of p^k then either g or $g+p^k$, whichever is odd, is a primitive root of $2p^k$.

B. Checks. If g is a primitive root of n then g^k is a primitive root of n if and only if $(k, \varphi(n)) = 1$, and each primitive root of n is of this form.

References

Texts

[24.1] L. Carlitz, Note on Nörlunds polynomial $B_n^{(s)}$, Proc. Amer. Math. Soc. **11**, 452-455 (1960).
 [24.2] T. Fort, Finite differences (Clarendon Press, Oxford, England, 1948).
 [24.3] H. W. Gould, Stirling number representation problems, Proc. Amer. Math. Soc. **11**, 447-451 (1960).
 [24.4] G. H. Hardy, Ramanujan (Chelsea Publishing Co., New York, N.Y., 1959).
 [24.5] G. H. Hardy and E. M. Wright, An introduction to the theory of numbers, 4th ed. (Clarendon Press, Oxford, England, 1960).
 [24.6] L. K. Hua, On the number of partitions of a number into unequal parts, Trans. Amer. Math. Soc. **51**, 194-201 (1942).
 [24.7] C. Jordan, Calculus of finite differences, 2d ed. (Chelsea Publishing Co., New York, N.Y., 1960).
 [24.8] K. Knopp, Theory and application of infinite series (Blackie and Son, Ltd., London, England, 1951).
 [24.9] L. M. Milne-Thomson, The calculus of finite differences (Macmillan and Co., Ltd., London, England, 1951).
 [24.10] L. Moser and M. Wyman, Stirling numbers of the second kind, Duke Math. J. **25**, 29-43 (1958).
 [24.11] L. Moser and M. Wyman, Asymptotic development of the Stirling numbers of the first kind, J. London Math. Soc. **33**, 133-146 (1958).
 [24.12] H. H. Ostmann, Additive Zahlentheorie, vol. I (Springer-Verlag, Berlin, Germany, 1956).

[24.13] H. Rademacher, On the partition function, Proc. London Math. Soc. **43**, 241-254 (1937).
 [24.14] H. Rademacher and A. Whiteman, Theorems on Dedekind sums, Amer. J. Math. **63**, 377-407 (1941).
 [24.15] J. Riordan, An introduction to combinatorial analysis (John Wiley & Sons, Inc., New York, N.Y., 1958).
 [24.16] J. V. Uspensky and M. A. Heaslet, Elementary number theory (McGraw-Hill Book Co., Inc., New York, N.Y., 1939).

Tables

[24.17] British Association for the Advancement of Science, Mathematical Tables, vol. VIII, Number-divisor tables (Cambridge Univ. Press, Cambridge, England, 1940). $n \leq 10^4$.
 [24.18] H. Gupta, Tables of distributions, Res. Bull. East Panjab Univ. **13-44** (1950); 750 (1951).
 [24.19] H. Gupta, A table of partitions, Proc. London Math. Soc. **39**, 142-149 (1935) and **II. 42**, 546-549 (1937). $p(n), n=1(1)300; p(n), n=301(1)600$.
 [24.20] G. Kavan, Factor tables (Macmillan and Co., Ltd., London, England, 1937). $n \leq 256,000$.
 [24.21] D. N. Lehmer, List of prime numbers from 1 to 10,006,721, Carnegie Institution of Washington, Publication No. 165, Washington, D.C. (1914).
 [24.22] Royal Society Mathematical Tables, vol. 3, Table of binomial coefficients (Cambridge Univ. Press, Cambridge, England, 1954). (*) for $r \leq \frac{1}{2}n \leq 100$.
 [24.23] G. N. Watson, Two tables of partitions, Proc. London Math. Soc. **42**, 550-556 (1937).

Table 24.1

BINOMIAL COEFFICIENTS $\binom{n}{m}$

$n \setminus m$	0	1	2	3	4	5	6	7	8
1	1	1							
2	1	2							
3	1	3	1						
4	1	4	6	1					
5	1	5	10	10	5	1			
6	1	6	15	20	15	6	1		
7	1	7	21	35	35	21	7	1	
8	1	8	28	56	70	56	28	8	1
9	1	9	36	84	126	126	84	36	9
10	1	10	45	120	210	252	210	120	45
11	1	11	55	165	330	462	462	330	165
12	1	12	66	220	495	792	924	792	495
13	1	13	78	286	715	1287	1716	1716	1287
14	1	14	91	364	1001	2002	3003	3432	3003
15	1	15	105	455	1365	3003	5005	6435	6435
16	1	16	120	560	1820	4368	8008	11440	12870
17	1	17	136	680	2380	6188	12376	19448	24310
18	1	18	153	816	3060	8568	18564	31824	43758
19	1	19	171	969	3876	11628	27132	50388	75582
20	1	20	190	1140	4845	15504	38760	77520	1 25970
21	1	21	210	1330	5985	20349	54264	1 16280	2 03490
22	1	22	231	1540	7315	26334	74613	1 70544	3 19770
23	1	23	253	1771	8855	33649	1 00947	2 45157	4 90314
24	1	24	276	2024	10626	42504	1 34596	3 46104	7 35471
25	1	25	300	2300	12650	53130	1 77100	4 80700	10 81575
26	1	26	325	2600	14950	65780	2 30230	6 57800	15 62275
27	1	27	351	2925	17550	80730	2 96010	8 88030	22 20075
28	1	28	378	3276	20475	98280	3 76740	11 84040	31 08105
29	1	29	406	3654	23751	1 18755	4 75020	15 60780	42 92145
30	1	30	435	4060	27405	1 42506	5 93775	20 35800	58 52925
31	1	31	465	4495	31465	1 69911	7 36281	26 29575	78 88725
32	1	32	496	4960	35960	2 01376	9 06192	33 65856	105 18300
33	1	33	528	5456	40920	2 37336	11 07568	42 72048	138 84156
34	1	34	561	5984	46376	2 78256	13 44904	53 79616	181 56204
35	1	35	595	6545	52360	3 24632	16 23160	67 24520	235 35820
36	1	36	630	7140	58905	3 76992	19 47792	83 47680	302 60340
37	1	37	666	7770	66045	4 35897	23 24784	102 95472	386 08020
38	1	38	703	8436	73815	5 01942	27 60681	126 20256	489 03492
39	1	39	741	9139	82251	5 75757	32 62623	153 80937	615 23748
40	1	40	780	9880	91390	6 58008	38 38380	186 43560	769 04685
41	1	41	820	10660	101270	7 49398	44 96388	224 81940	955 48245
42	1	42	861	11480	111930	8 50668	52 45786	269 78328	1180 30185
43	1	43	903	12341	123410	9 62598	60 96454	322 24114	1450 08513
44	1	44	946	13244	135751	10 86008	70 59052	383 20568	1772 32627
45	1	45	990	14190	148995	12 21759	81 45060	453 79620	2155 53195
46	1	46	1035	15180	163185	13 70754	93 66819	535 24680	2609 32815
47	1	47	1081	16215	178365	15 33939	107 37573	628 91499	3144 57495
48	1	48	1128	17296	194580	17 12304	122 71512	736 29072	3773 48994
49	1	49	1176	18424	211876	19 06884	139 83816	859 00584	4509 78066
50	1	50	1225	19600	230300	21 18760	158 90700	998 84400	5368 78650

From Royal Society Mathematical Tables, vol. 3, Table of binomial coefficients. Cambridge Univ. Press, Cambridge, England, 1954 (with permission).

BINOMIAL COEFFICIENTS $\binom{n}{m}$

Table 24.1

$n \setminus m$	9	10	11	12	13
9	1				
10	10	1			
11	55	11	1		
12	220	66	12		
13	715	286	78	1	
14	2002	1001	364	91	14
15	5005	3003	1365	455	105
16	11440	8008	4368	1820	560
17	24310	19448	12376	6188	2380
18	48620	43758	31824	18564	8568
19	92378	92378	75582	50388	27132
20	1 67960	1 84756	1 67960	1 25970	77520
21	2 93930	3 52716	3 52716	2 93930	2 03490
22	4 97420	6 46646	7 05432	6 46646	4 97420
23	8 17190	11 44066	13 52078	13 52078	11 44066
24	13 07504	19 61256	24 96144	27 04156	24 96144
25	20 42975	32 68760	44 57400	52 00300	52 00300
26	31 24550	53 11735	77 26160	96 57700	104 00600
27	46 86825	84 36285	130 37895	173 83860	200 58300
28	69 06900	131 23110	214 74180	304 21755	374 42160
29	100 15005	200 30010	345 97290	518 95935	678 63915
30	143 07150	300 45015	546 27300	864 93225	1197 59850
31	201 60075	443 52165	846 72315	1411 20525	2062 53075
32	280 48800	645 12240	1290 24480	2257 92840	3473 73600
33	385 67100	925 61040	1935 36720	3548 17320	5731 66440
34	524 51256	1311 28140	2860 97760	5483 54040	9279 83760
35	706 07460	1835 79396	4172 25900	8344 51800	14763 37800
36	941 43280	2541 86856	6008 05296	12516 77700	23107 89600
37	1244 03620	3483 30136	8549 92152	18524 82996	35624 67300
38	1630 11640	4727 33756	12033 22288	27074 75148	54149 50296
39	2119 15132	6357 45396	16760 56044	39107 97436	81224 25444
40	2734 38880	8476 60528	23118 01440	55868 53480	1 20332 22880
41	3503 43565	11210 99408	31594 61968	78986 54920	1 76200 76360
42	4458 91810	14714 42973	42805 61376	1 10581 16888	2 55187 31280
43	5639 21995	19173 34783	57520 04349	1 53386 78264	3 65768 48168
44	7089 30508	24812 56778	76693 39132	2 10906 82613	5 19155 26432
45	8861 63135	31901 87286	1 01505 95910	2 87600 21745	7 30062 09045
46	11017 16330	40763 50421	1 33407 83196	3 89106 17655	10 17662 30790
47	13626 49145	51780 66751	1 74171 33617	5 22514 00851	14 06768 48445
48	16771 06640	65407 15896	2 25952 00368	6 96685 34468	19 29282 49296
49	20544 55634	82178 22536	2 91359 16264	9 22637 34836	26 25967 83764
50	25054 33700	1 02722 78170	3 73537 38800	12 13996 51100	35 48605 18600

Table 24.1

BINOMIAL COEFFICIENTS $\binom{n}{m}$

$n \setminus m$	14	15	16	17	18	19
14	1					
15	15	1				
16	120	16	1			
17	680	136	17	1		
18	3060	816	153	18	1	
19	11628	3876	969	171	19	1
20	38760	15504	4845	1140	190	20
21	1 16280	54264	20349	5985	1330	210
22	3 19770	1 70544	74613	26334	7315	1540
23	8 17190	4 90314	2 45157	1 00947	33649	8855
24	19 61256	13 07504	7 35471	3 46104	1 34596	42504
25	44 57400	32 68760	20 42975	10 81575	4 80700	1 77100
26	96 57700	77 26160	53 11735	31 24550	15 62275	6 57800
27	200 58300	173 83860	130 37895	84 36285	46 86825	22 20075
28	401 16600	374 42160	304 21755	214 74180	131 23110	69 06900
29	775 58760	775 58760	678 63915	518 95935	345 97290	200 30010
30	1454 22675	1551 17520	1454 22675	1197 59850	864 93225	546 27300
31	2651 82525	3005 40195	3005 40195	2651 82525	2062 53075	1411 20525
32	4714 35600	5657 22720	6010 80390	5657 22720	4714 39600	3473 73600
33	8188 09200	10371 58320	11668 03110	11668 03110	10371 58320	8188 09200
34	13919 75640	18559 67520	22039 61430	23336 06220	22039 61430	18559 67520
35	23199 59400	32479 43160	40599 28950	45375 67650	45375 67650	40599 28950
36	37962 97200	55679 02560	73078 72110	85974 96600	90751 35300	85974 96600
37	61070 86800	93641 99760	1 28757 74670	1 59053 68710	1 76726 31900	1 76726 31900
38	96695 54100	1 54712 86560	2 22399 74430	2 87811 43380	3 35780 00610	3 53452 63800
39	1 50845 04396	2 51408 40660	3 77112 60990	5 10211 17810	6 23591 43990	6 89232 64410
40	2 32069 29840	4 02253 45056	6 28521 01650	8 87323 78800	11 33802 61800	13 12824 08400
41	3 52401 52720	6 34322 74896	10 30774 46706	15 15844 80450	20 21126 40600	24 46626 70200
42	5 28602 29080	9 86724 27616	16 65097 21602	25 46619 27156	35 36971 21050	44 67753 10800
43	7 83789 60360	15 15326 56696	26 51821 49218	42 11716 48758	60 83590 48206	80 04724 31850
44	11 49558 08528	22 99116 17056	41 67148 05914	68 63537 97976	102 95306 96964	140 88314 80056
45	16 68713 34960	34 48674 25584	64 66264 22970	110 30686 03890	171 58844 94940	243 83621 77020
46	23 98775 44005	51 17387 60544	99 14938 48554	174 96950 26860	281 89530 98830	415 42466 71960
47	34 16437 74795	75 16163 04549	150 32326 09098	274 11888 75414	456 86481 25690	697 31997 70790
48	48 23206 73240	109 32600 79344	225 48489 13647	424 44214 84512	730 98370 01104	1154 18478 96480
49	67 52488 72536	157 55807 02584	334 81089 92991	649 92703 98159	1155 42584 85616	1885 16848 97584
50	93 78456 56300	225 08295 75120	492 36896 95575	984 73793 91150	1805 35288 83775	3040 59433 83200
$n \setminus m$	20	21	22	23	24	25
20	1					
21	21	1				
22	231	22	1			
23	1771	253	23	1		
24	10626	2024	276	24	1	
25	53130	12650	2300	300	25	1
26	2 30230	65780	14950	2600	325	26
27	8 88030	2 96010	80730	17550	2925	351
28	31 08105	11 84040	3 76740	98280	20475	3276
29	100 15005	42 92145	15 60780	4 75020	1 18755	23751
30	300 45015	143 07150	58 52925	20 35800	5 93775	1 42506
31	846 72315	443 52165	201 60075	78 88725	26 29575	7 36281
32	2257 92840	1290 24480	645 12240	280 48800	105 18300	33 65856
33	5731 66440	3548 17320	1935 36720	925 61040	385 67100	138 84156
34	13919 75640	9279 83760	5483 54040	2860 97760	1311 28140	524 51256
35	32479 43160	23199 59400	14763 37800	8344 51800	4172 25900	1835 79396
36	73078 72110	55679 02560	37962 97200	23107 89600	12516 77700	6008 05296
37	1 59053 68710	1 28757 74670	93641 99760	61070 86800	35624 67300	18524 82996
38	3 35780 00610	2 87811 43380	2 22399 74430	1 54712 86560	96695 54100	54149 50296
39	6 89232 64410	6 23591 43990	5 10211 17810	3 77112 60990	2 51408 40660	1 50845 04396
40	13 78465 28820	13 12824 08400	11 33802 61800	8 87323 78800	6 28521 01650	4 02253 45056
41	26 91289 37220	26 91289 37220	24 46626 70200	20 21126 40600	15 15844 80450	10 30774 46706
42	51 37916 07420	53 82578 74440	51 37916 07420	44 67753 10800	35 36971 21050	25 46619 27156
43	96 05669 18220	105 20494 81860	105 20494 81860	96 05669 18220	80 04724 31850	60 83590 48206
44	176 10393 50070	201 26164 00080	210 40989 63720	201 26164 00080	176 10393 50070	140 88314 80056
45	316 98708 30126	377 36557 50150	411 67153 63800	411 67153 63800	377 36557 50150	316 98708 30126
46	560 82330 07146	694 35265 80276	789 03711 13950	823 34307 27600	789 03711 13950	694 35265 80276
47	976 24796 79106	1255 17595 87422	1483 38976 94226	1612 38018 41550	1612 38018 41550	1483 38976 94226
48	1673 56794 49896	2231 42392 66528	2738 56572 81648	3095 76995 35776	3224 76036 83100	3095 76995 35776
49	2827 75273 46376	3904 99187 16424	4969 98965 48176	5834 33568 17424	6320 53032 18876	6320 53032 18876
50	4712 92122 43960	6732 74460 62800	8874 98152 64600	10804 32533 66600	12154 86600 36300	12641 06064 37752

Multinomials and Partitions

Table 24.2

$$\pi = 1^{a_1}, 2^{a_2}, \dots, n^{a_n}, n = a_1 + 2a_2 + \dots + na_n, m = a_1 + a_2 + \dots + a_n$$

$$M_1 = (n; n_1, n_2, \dots, n_m) = n! / (1!)^{a_1} (2!)^{a_2} \dots (n!)^{a_n}$$

$$M_2 = (n; a_1, a_2, \dots, a_n)^* = n! / 1^{a_1} a_1! 2^{a_2} a_2! \dots n^{a_n} a_n!$$

$$M_3 = (n; a_1, a_2, \dots, a_n)' = n! / (1!)^{a_1} a_1! (2!)^{a_2} a_2! \dots (n!)^{a_n} a_n!$$

<i>n</i>	<i>m</i>	π	M_1	M_2	M_3	<i>n</i>	<i>m</i>	π	M_1	M_2	M_3
1	1	1	1	1	1	8	1	8	1	5040	1
							2	1, 7	8	5760	8
2	1	2	1	1	1			2, 6	28	3360	28
	2	1 ²	2	1	1			3, 5	56	2688	56
								4 ²	70	1260	35
3	1	3	1	2	1		3	1 ² , 6	56	3360	28
	2	1, 2	3	3	3			1, 2, 5	168	4032	168
	3	1 ³	6	1	1			1, 3, 4	280	3360	280
								2 ² , 4	420	1260	210
4	1	4	1	6	1		4	2, 3 ²	560	1120	280
	2	1, 3	4	8	4			1 ³ , 5	336	1344	56
		2 ²	6	3	3			1 ² , 2, 4	840	2520	420
	3	1 ² , 2	12	6	6			1 ² , 3 ²	1120	1120	280
	4	1 ⁴	24	1	1			1, 2 ² , 3	1680	1680	840
								2 ⁴	2520	105	105
5	1	5	1	24	1		5	1 ⁴ , 4	1680	420	70
	2	1, 4	5	30	5			1 ³ , 2, 3	3360	1120	560
		2, 3	10	20	10			1 ² , 2 ³	5040	420	420
	3	1 ² , 3	20	20	10		6	1 ⁵ , 3	6720	112	56
		1, 2 ²	30	15	15			1 ⁴ , 2 ²	10080	210	210
	4	1 ³ , 2	60	10	10		7	1 ⁶ , 2	20160	28	28
	5	1 ⁵	120	1	1		8	1 ⁸	40320	1	1
						9	1	9	1	40320	1
6	1	6	1	120	1		2	1, 8	9	45360	9
	2	1, 5	6	144	6			2, 7	36	25920	36
		2, 4	15	90	15			3, 6	84	20160	84
		3 ²	20	40	10			4, 5	126	18144	126
	3	1 ² , 4	30	90	15		3	1 ² , 7	72	25920	36
		1, 2, 3	60	120	60			1, 2, 6	252	30240	252
		2 ³	90	15	15			1, 3, 5	504	24192	504
	4	1 ³ , 3	120	40	20			1, 4 ²	630	11340	315
		1 ² , 2 ²	180	45	45			2 ² , 5	756	9072	378
	5	1 ⁴ , 2	360	15	15			2, 3, 4	1260	15120	1260
	6	1 ⁶	720	1	1			3 ³	1680	2240	280
							4	1 ³ , 6	504	10080	84
								1 ² , 2, 5	1512	18144	756
								1 ² , 3, 4	2520	15120	1260
7	1	7	1	720	1			1, 2 ² , 4	3780	11340	1890
	2	1, 6	7	840	7			1, 2, 3 ²	5040	10080	2520
		2, 5	21	504	21			2 ³ , 3	7560	2520	1260
		3, 4	35	420	35			1 ⁴ , 5	3024	3024	126
	3	1 ² , 5	42	504	21		5	1 ³ , 2, 4	7560	7560	1260
		1, 2, 4	105	630	105			1 ³ , 3 ²	10080	3360	840
		1, 3 ²	140	280	70			1 ² , 2 ² , 3	15120	7560	3780
		2 ² , 3	210	210	105			1, 2 ⁴	22680	945	945
	4	1 ³ , 4	210	210	35			1 ⁵ , 4	15120	756	126
		1 ² , 2, 3	420	420	210		6	1 ⁴ , 2, 3	30240	2520	1260
		1, 2 ³	630	105	105			1 ³ , 2 ³	45360	1260	1260
	5	1 ⁴ , 3	840	70	35			1 ⁶ , 3	60480	168	84
		1 ³ , 2 ²	1260	105	105			1 ⁵ , 2 ²	90720	378	378
	6	1 ⁶ , 2	2520	21	21			1 ⁷ , 2	181440	36	36
	7	1 ⁷	5040	1	1		9	1 ⁹	362880	1	1

Table 24.2

Multinomials and Partitions

n	m	π	M_1	M_2	M_3	n	m	π	M_1	M_2	M_3
10	1	10	1	362880	1	10		$2^3, 4$	18900	18900	3150
	2	1, 9	10	403200	10			$2^2, 3^2$	25200	25200	6300
		2, 8	45	226800	45		5	$1^4, 6$	5040	25200	210
	3, 7	120	172800	120	$1^3, 2, 5$			15120	60480	2520	
	4, 6	210	151200	210	$1^3, 3, 4$		25200	50400	4200		
	5^2	252	72576	126	$1^2, 2^2, 4$		*37800	*56700	9450		
	3	$1^2, 8$	90	226800	45		$1^2, 2, 3^2$	50400	50400	12600	
		1, 2, 7	360	259200	360		$1, 2^3, 3$	75600	25200	12600	
	1, 3, 6	840	201600	840	6		2^5	113400	945	945	
	1, 4, 5	1260	181440	1260			$1^5, 5$	30240	6048	252	
	$2^2, 6$	1260	75600	630	$1^4, 2, 4$		75600	18900	3150		
	2, 3, 5	2520	*120960	2520	$1^4, 3^2$		100800	8400	2100		
	$2, 4^2$	3150	56700	1575	$1^3, 2^2, 3$		151200	25200	12600		
	$3^2, 4$	4200	50400	2100	$1^2, 2^4$		226800	4725	4725		
	4	$1^3, 7$	720	86400	120		7	$1^6, 4$	151200	1260	210
		$1^2, 2, 6$	2520	151200	1260			$1^5, 2, 3$	302400	5040	2520
	$1^2, 3, 5$	5040	120960	2520	$1^4, 2^3$		453600	3150	3150		
	$1^2, 4^2$	6300	56700	1575	8		$1^7, 3$	604800	240	120	
	1, $2^2, 5$	7560	90720	3780			$1^6, 2^2$	907200	630	630	
	1, 2, 3, 4	12600	151200	12600	9		$1^8, 2$	1814400	45	45	
$1, 3^3$	16800	22400	2800	10		1^{10}	3628800	1	1		

*See page II.

STIRLING NUMBERS OF THE FIRST KIND $s_n^{(m)}$

Table 24.3

$n \setminus m$	1	2	3
1	1		
2	-1	1	
3	2	-3	1
4	-6	11	-6
5	24	-50	35
6	-120	274	-225
7	720	-1764	1624
8	-5040	13068	-13132
9	40320	-1 09584	1 18124
10	-3 62880	10 26576	-11 72700
11	36 28800	-106 28640	127 53576
12	-399 16800	1205 43840	-1509 17976
13	4790 01600	-14864 42880	19315 59552
14	-62270 20800	1 98027 59040	-2 65967 17056
15	8 71782 91200	-28 34656 47360	39 21567 97824
16	-130 76743 68000	433 91630 01600	-616 58176 14720
17	2092 27898 88000	-7073 42823 93600	10299 22448 37120
18	-35568 74280 96000	1 22340 55905 79200	-1 82160 24446 24640
19	6 40237 37057 28000	-22 37698 80585 21600	34 01224 95938 22720
20	-121 64510 04088 32000	431 56514 68176 38400	-668 60973 03411 53280
21	2432 90200 81766 40000	-8752 94803 67616 00000	13803 75975 36407 04000
22	-51090 94217 17094 40000	1 86244 81078 01702 40000	-2 98631 90286 32163 84000
23	11 24000 72777 76076 80000	-41 48476 77933 54547 20000	67 56146 67377 09306 88000
24	-258 52016 73888 49766 40000	965 38966 65249 30662 40000	-1595 39850 27606 68605 44000
25	6204 48401 73323 94393 60000	-23427 87216 39871 85664 00000	39254 95373 27809 77192 96000

$$\sum_{m=1}^{\infty} S_m^{(1)} x^m = e^x$$

AD 142

$$\sum_{m=2}^{\infty} S_m^{(2)} x^m = 0,7407267843$$

AD 254

$n \setminus m$	4	5	6
4	1		
5	-10	1	
6	85	-15	1
7	-735	175	-21
8	6769	-1960	322
9	-67284	22449	-4536
10	7 23680	-2 69325	63273
11	-84 09500	34 16930	-9 02055
12	1052 58076	-459 95730	133 39535
13	-14140 14888	6572 06836	-2060 70150
14	2 03137 53096	-99577 03756	33361 18786
15	-31 09892 60400	15 97216 05680	-5 66633 66760
16	505 69957 03824	-270 68133 45600	100 96721 07080
17	-8707 77488 75904	4836 60092 33424	-1886 15670 58880
18	1 58331 39757 27488	-90929 99058 44112	36901 26492 34384
19	-30 32125 40077 19424	17 95071 22809 21504	-7 55152 75920 63024
20	610 11607 57404 91776	-371 38478 73452 28000	161 42973 65301 18960
21	-12870 93124 51509 88800	8037 81182 26450 51776	-3599 97951 79476 07200
22	2 84093 31590 18114 68800	-1 81664 97952 06970 76096	83637 38169 95448 02976
23	-65 48684 85270 30686 97600	42 80722 86535 71471 42912	-20 21687 37691 06827 41568
24	1573 75898 28594 15107 32800	-1050 05310 75591 74529 84576	507 79532 53430 28501 98976
25	-39365 61409 13866 31181 31200	26775 03356 42796 03823 62624	-13237 14091 57918 58577 60000

From unpublished tables of Francis L. Miksa, with permission.

Table 24.3 STIRLING NUMBERS OF THE FIRST KIND $S_n^{(m)}$

$n \setminus m$	7	8	9
7	1		
8	-28	1	
9	546	-36	1
10	-9450	870	-45
11	1 57773	- 18150	1320
12	-26 37558	3 57423	- 32670
13	449 90231	-69 26634	7 49463
14	-7909 43153	1350 36473	-166 69653
15	1 44093 22928	- 26814 53775	3684 11615
16	-27 28032 10680	5 46311 29553	- 82076 28000
17	537 45234 77960	-114 69012 83528	18 59531 77553
18	- 11022 84661 84200	2487 18452 97936	-430 81053 01929
19	2 35312 50405 49984	- 55792 16815 47048	10241 77407 32658
20	-52 26090 33625 12720	12 95363 69899 43896	-2 50385 87554 67550
21	1206 64780 37803 73360	-311 33364 31613 90640	63 03081 20992 94896
22	- 28939 58339 73354 47760	7744 65431 01695 76800	-1634 98069 72465 83456
23	7 20308 21644 09246 53696	-1 99321 97822 10661 37360	43714 22964 95944 12832
24	-185 88776 35505 19497 76576	53 04713 71552 54458 12976	-12 04749 26016 17376 32496
25	4969 10165 05554 96448 36800	-1459 01905 52766 26492 88000	342 18695 95940 71489 92880

$n \setminus m$	10	11	12
10	1		
11	-55	1	
12	1925	-66	1
13	- 55770	2717	-78
14	14 74473	- 91091	3731
15	-373 12275	27 49747	-1 43325
16	9280 95740	-785 58480	48 99622
17	-2 30571 59840	21850 31420	-1569 52432
18	57 79248 94833	-6 02026 93980	48532 22764
19	-1471 07534 08923	166 15733 86473	-14 75607 03732
20	38192 20555 02195	-4628 06477 51910	446 52267 57381
21	-10 14229 98655 11450	1 30753 50105 40395	- 13558 51828 99530
22	276 01910 92750 35346	-37 60053 50868 59745	4 15482 38514 30525
23	-7707 40110 12973 61068	1103 23088 11859 49736	-129 00665 98183 31295
24	2 20984 45497 94337 17396	- 33081 71136 85742 04996	4070 38405 70075 69521
25	-65 08376 17966 81468 50000	10 14945 52782 52146 37300	-1 30770 92873 67558 73500

$n \setminus m$	13	14	15	16
13	1			
14	-91	1		
15	5005	-105	1	
16	-2 18400	6580	-120	1
17	83 94022	-3 23680	8500	-136
18	-2996 50806	138 96582	-4 68180	10812
19	1 02469 37272	-5497 89282	223 23822	-6 62796
20	-34 22525 11900	2 06929 33630	-9739 41900	349 16946
21	1131 02769 95381	-75 61111 84500	4 01717 71630	- 16722 80820
22	- 37310 09998 02531	2718 86118 69881	-159 97183 88730	7 52896 68850
23	12 36304 58470 86207	- 97125 04609 39913	6238 24164 21941	-325 60911 03430
24	-413 35671 43013 14056	34 70180 64487 04206	-2 40604 60386 44556	13727 25118 00831
25	13990 94520 02391 06865	-1246 20006 90702 15000	92 44691 13761 73550	-5 70058 63218 64500

$n \setminus m$	17	18	19	20	21	22	23	24	25
17	1								
18	-153	1							
19	13566	-171	1						
20	-9 20550	16815	-190	1					
21	533 27946	-12 56850	20615	-210	1				
22	- 27921 67686	797 21796	-16 89765	25025	-231	1			
23	13 67173 57942	- 45460 47198	1168 96626	-22 40315	30107	-253	1		
24	-640 05903 36096	24 12764 43496	- 72346 69596	1684 23871	-29 32776	35926	-276	1	
25	29088 66798 67135	-1219 12249 80000	41 49085 13800	-1 12768 42500	2388 10495	-37 95000	42550	-300	1

COMBINATORIAL ANALYSIS

STIRLING NUMBERS OF THE SECOND KIND $S_n^{(m)}$ Table 24.1

$n \setminus m$	2	3	4	5	6
1 1					
2 1	1				
3 1	3	1			
4 1	7	6	1		
5 1	15	25	10	1	
6 1	31	90	65	15	1
7 1	63	301	350	140	21
8 1	127	966	1701	1050	266
9 1	255	3025	7770	6951	2646
10 1	511	9330	34105	42525	22827
11 1	1023	28501	1 45750	2 46730	1 79487
12 1	2047	86526	6 11501	13 79400	13 23652
13 1	4095	2 61625	25 32530	75 08501	93 21312
14 1	8191	7 88970	103 91745	400 75035	634 36373
15 1	16383	23 75101	423 55950	2107 66920	4206 93273
16 1	32767	71 41686	1717 98901	10961 90550	27349 26558
17 1	65535	214 57825	6943 37290	56527 51651	1 75057 49898
18 1	1 31071	644 39010	27988 06985	2 89580 95545	11 06872 51039
19 1	2 62143	1934 48101	1 12596 66950	14 75892 84710	69 30816 01779
20 1	5 24287	5806 06446	4 52321 15901	74 92060 90500	430 60788 95384
21 1	10 48575	17423 43625	18 15090 70050	379 12625 68401	2658 56794 62804
22 1	20 97151	52280 79450	72 77786 23825	1913 78219 12055	16330 53393 45225
23 1	41 94303	1 56863 35501	291 63425 74750	9641 68881 84100	99896 98579 83405
24 1	83 88607	4 70632 00806	1168 10566 34501	48500 07834 95250	6 09023 60360 84530
25 1	167 77215	14 11979 91025	4677 12897 38810	2 43668 49741 10751	37 02641 70000 02430

$n \setminus m$	7	8	9	10
7 1				
8 1	28	1		
9 1	462	36	1	
10 1	5880	750	45	1
11 1	63987	11880	1155	55
12 1	6 27396	1 59027	3 22275	1705
13 1	57 15424	18 99612	3 59502	39325
14 1	493 29280	209 12320	51 35130	7 52752
15 1	4087 41333	2166 27840	671 28490	126 62650
16 1	32818 82604	21417 64053	8207 84250	1937 54990
17 1	2 57081 04786	2 04159 95028	95288 22303	27583 34150
18 1	19 74624 83400	18 90360 65010	10 61753 95755	3 71121 63803
19 1	149 29246 34839	170 97510 03480	114 46146 26805	47 72970 33785
20 1	1114 35540 45652	1517 09326 62679	1201 12826 44725	591 75849 64655
21 1	8231 09572 14948	13251 10153 47084	12327 24764 65204	7118 71322 91275
22 1	60276 23799 67440	1 14239 90799 91620	1 24196 33035 33920	83514 37993 77954
23 1	4 38264 19991 17305	9 74195 50199 00400	12 32006 88117 96900	9 59340 12973 13460
24 1	31 67746 38518 04540	82 31828 21583 20505	120 62257 43260 72500	108 25408 17849 31500
25 1	227 83248 29987 16310	690 22372 11183 68580	1167 92146 10929 73005	1203 16339 21753 87500

$n \setminus m$	11	12	13	14
11 1				
12 1	66	1		
13 1	2431	78	1	
14 1	66066	3367	91	1
15 1	14 79478	1 06470	4550	105
16 1	289 36908	27 57118	1 65620	6020
17 1	5120 60978	620 22324	49 10178	2 49900
18 1	83910 04908	12563 28866	1258 54638	84 08778
19 1	12 94132 17791	2 34669 51300	28924 39160	2435 77530
20 1	190 08424 29486	41 10166 33391	6 10686 60380	63025 24580
21 1	2682 68516 89001	683 30420 30178	120 49092 18331	14 93040 04500
22 1	36628 25008 70286	10882 33560 51137	2249 68618 68481	329 51652 81331
23 1	4 86425 13089 51100	1 67216 27734 83930	40128 25603 41390	6862 91758 07115
24 1	63 10016 56957 75660	24 93020 45907 58260	6 88883 60579 22000	1 36209 10216 46000
25 1	802 35590 44384 62660	362 26262 07848 74680	114 48507 33437 44260	25 95811 03608 96000

$n \setminus m$	15	16	17	18	19
15 1					
16 1	120	1			
17 1	7820	136	1		
18 1	3 67200	9996	153	1	
19 1	139 16778	5 27136	12597	171	1
20 1	4523 29200	223 50954	7 41285	15675	190
21 1	1 30874 62580	8099 44464	349 52799	10 23435	19285
22 1	34 56159 43200	2 60465 74004	14041 42047	533 74629	13 89850
23 1	847 94044 29331	76 23611 27264	4 99169 88803	23648 85369	797 81779
24 1	19582 02422 47080	2067 71824 65555	161 09499 36915	9 24849 25445	38807 39170
25 1	4 29939 46553 47200	52665 51616 95960	4806 33313 93110	327 56785 94925	16 62189 69675

$n \setminus m$	20	21	22	23	24	25
20 1						
21 1	210	1				
22 1	23485	231	1			
23 1	18 59550	28336	253	1		
24 1	1169 72779	24 54606	33902	276	1	
25 1	62201 94750	1685 19505	32 00450	40250	300	1

From unpublished tables of Francis L. Miksa, with permission.

*See page II.

Table 21.5

NUMBER OF PARTITIONS AND PARTITIONS INTO DISTINCT PARTS

n	$p(n)$	$q(n)$	n	$p(n)$	$q(n)$	n	$p(n)$	$q(n)$	n	$p(n)$	$q(n)$
0		1	50	2 04226	3658	100	1905 69292	4 44793	150	4 08532 35313	194 06016
1	1	1	51	2 39943	4097	101	2144 81126	4 83330	151	4 50606 24582	207 92120
2	2	1	52	2 81589	4582	102	2412 65379	5 25016	152	4 96862 88421	222 72512
3	3	2	53	3 29931	5120	103	2712 48950	5 70078	153	5 47703 36324	238 53318
4	5	2	54	3 86155	5718	104	3048 01365	6 18784	154	6 03566 73280	255 40982
5	7	3	55	4 51276	6378	105	3423 25709	6 71418	155	6 64931 82097	273 42421
6	11	4	56	5 26823	7108	106	3842 76336	7 28260	156	7 32322 43759	292 64960
7	15	5	57	6 14154	7917	107	4311 49389	7 89640	157	8 06309 64769	313 16314
8	22	6	58	7 15220	8808	108	4835 02844	8 55906	158	8 87517 78802	335 04746
9	30	8	59	8 31820	9792	109	5419 46240	9 27406	159	9 76627 28555	358 39008
10	42	10	60	9 66467	10880	110	6071 63746	10 04544	160	10 74381 59466	383 28320
11	56	12	61	11 21505	12076	111	6799 03203	10 87744	161	11 81590 68427	409 82540
12	77	15	62	13 00156	13394	112	7610 02156	11 77438	162	12 99139 04637	438 12110
13	101	18	63	15 05499	14848	113	8513 76628	12 74118	163	14 27989 95930	468 28032
14	135	22	64	17 41630	16444	114	9520 50665	13 78304	164	15 69194 75295	500 42056
15	176	27	65	20 12558	18200	115	10641 44451	14 90528	165	17 23898 00255	534 66624
16	231	32	66	23 23520	20132	116	11889 08248	16 11388	166	18 93348 22579	571 14844
17	297	38	67	26 79689	22250	117	13277 10076	17 41521	167	20 78904 20102	610 00704
18	385	46	68	30 87735	24576	118	14820 74143	18 81578	168	22 82047 32751	651 39008
19	490	54	69	35 54345	27130	119	16536 68665	20 32290	169	25 04389 25115	695 45358
20	627	64	70	40 87968	29927	120	18443 49560	21 94432	170	27 47686 17130	742 36384
21	792	76	71	46 97205	32992	121	20561 48051	23 68800	171	30 13848 02048	792 29676
22	1002	89	72	53 92783	36352	122	22913 20912	25 56284	172	33 04954 99613	845 43782
23	1255	104	73	61 85689	40026	123	25523 38241	27 57826	173	36 23268 59895	901 98446
24	1575	122	74	70 89500	44046	124	28419 40500*	29 74400	174	39 71250 74750	962 14550
25	1958	142	75	81 18264	48446	125	31631 27352	32 07086	175	43 51576 97830	1026 14114
26	2436	165	76	92 89091	53250	126	35192 22692	34 57027	176	47 67158 57290	1094 20549
27	3010	192	77	106 19863	58499	127	39138 64295	37 25410	177	52 21158 31195	1166 58616
28	3718	222	78	121 32164	64234	128	43510 78600	40 13544	178	57 17016 05655	1243 54422
29	4565	256	79	138 48650	70488	129	48352 71870	43 22816	179	62 58467 53120	1325 35702
30	5604	296	80	157 96476	77312	130	53713 15400	46 54670	180	68 49573 90936	1412 31780
31	6842	340	81	180 04327	84756	131	59645 39504	50 10688	181	74 94744 11781	1504 73568
32	8349	390	82	205 06255	92864	132	66208 30889	53 92550	182	81 98769 08323	1602 93888
33	10143	448	83	233 38469	101698	133	73466 29512	58 02008	183	89 66848 17527	1707 27424
34	12310	512	84	265 43660	111322	134	81490 40695	62 40974	184	98 04628 80430	1818 10744
35	14883	585	85	301 67357	121792	135	90358 36076	67 11480	185	107 18237 74337	1935 82642
36	17977	668	86	342 62962	133184	136	1 00155 81680	72 15644	186	117 14326 92373	2060 84096
37	21637	760	87	388 87673	145578	137	1 10976 45016	77 55776	187	128 00110 42268	2193 58315
38	26015	864	88	441 08109	159046	138	1 22923 41831	83 34326	188	139 83417 45571	2334 51098
39	31185	982	89	499 95925	173682	139	1 36109 49895	89 53856	189	152 72735 99625	2484 10816
40	37338	1113	90	566 34173	189586	140	1 50658 78135	96 17150	190	166 77274 04093	2642 88462
41	44583	1260	91	641 12359	206848	141	1 66706 89208	103 27156	191	182 07011 00652	2811 38048
42	53174	1426	92	725 33807	225585	142	1 84402 93320	110 86968	192	198 72768 56363	2990 16608
43	63261	1610	93	820 10177	245920	143	2 03909 82757	118 99934	193	216 86271 05469	3179 84256
44	75175	1816	94	926 69720	267968	144	2 25406 54445	127 69602	194	236 60227 41845	3381 04630
45	89134	2048	95	1046 51419	291874	145	2 49088 58009	136 99699	195	258 08402 12973	3594 44904
46	105558	2304	96	1181 14304	317788	146	2 75170 52599	146 94244	196	281 45709 87591	3820 75868
47	124754	2590	97	1332 30930	345856	147	3 03886 71978	157 57502	197	306 88298 78530	4060 72422
48	147273	2910	98	1501 98136	376256	148	3 35494 19497	168 93952	198	334 53659 83698	4315 13602
49	173525	3264	99	1692 29875	409174	149	3 70273 55200	181 08418	199	364 60724 32125	4584 82688
50	204226	3658	100	1905 69292	444793	150	4 08532 35313	194 06016	200	397 29990 29388	4870 67746

Values of $p(n)$ from H. Gupta, A table of partitions, Proc. London Math. Soc. 39, 142-149, 1935 and II. 42, 546-549, 1937 (with permission).

$$\sum_{n=1}^{\infty} \frac{1}{2^{p(n)}} \text{ eu base 10} = 0,9145815382 \approx 1066/1159$$

$$\sum_{n=1}^{\infty} \frac{1}{2^{q(n)}} = 2,2395365315$$

Handwritten notes:
 5, 9, 11, 13, 15, 16, 18, 20, 21, 22, 23, 24, 25, 26, 27, 28, 29, 30, 31, 32, 33, 34, 35, 36, 37, 38, 39, 40, 41, 42, 43, 44, 45, 46, 47, 48, 49, 50

NUMBER OF PARTITIONS AND PARTITIONS INTO DISTINCT PARTS

Table 24.5

n	$p(n)$			$q(n)$			n	$p(n)$			$q(n)$		
200	397	29990	29388	4870	67746		250	23079	35543	64681	85192	80128	
201	432	83636	58647	5173	61670		251	24929	14511	68559	89949	26602	
202	471	45668	86083	5494	62336		252	26923	27012	52579	94961	58208	
203	513	42052	87973	5834	73184		253	29072	69579	16112	1 00243	00890	
204	559	00883	17495	6195	03296		254	31389	19913	06665	1 05807	47264	
205	608	52538	59260	6576	67584		255	33885	42642	48680	1 11669	59338	
206	662	29877	08040	6980	87424		256	36574	95668	70782	1 17844	71548	
207	720	68417	06490	7408	90786		257	39472	36766	55357	1 24348	95064	
208	784	06562	26137	7862	12446		258	42593	30844	09356	1 31199	20928	
209	852	85813	02375	8341	94700		259	45954	57504	48675	1 38413	23582	
210	927	51025	75355	8849	87529		260	49574	19347	60846	1 46009	65705	
211	1008	50658	85767	9387	48852		261	53471	50629	08609	1 54008	01856	
212	1096	37072	05259	9956	45336		262	57667	26749	47168	1 62428	82560	
213	1191	66812	36278	10558	52590		263	62183	74165	09615	1 71293	59744	
214	1295	00959	25895	11195	55488		264	67044	81230	60170	1 80624	90974	
215	1407	05456	99287	11869	49056		265	72276	09536	90372	1 90446	44146	
216	1528	51512	48481	12582	38720		266	77905	06295	62167	2 00783	03620	
217	1660	15981	07914	13336	40710		267	83961	17303	66814	2 11660	75136	
218	1802	81825	16671	14133	83026		268	90476	01083	16360	2 23106	91192	
219	1957	38561	61145	14977	05768		269	97483	43699	44625	2 35150	17984	
220	2124	82790	09367	15868	61606		270	1 05019	74899	31117	2 47820	61070	
221	2306	18711	73849	16811	16852		271	1 13123	85039	38606	2 61149	71540	
222	2502	58737	60111	17807	51883		272	1 21837	43498	44333	2 75170	53882	
223	2715	24089	25615	18860	61684		273	1 31205	18008	16215	2 89917	72486	
224	2945	45499	41750	19973	57056		274	1 41274	95651	73450	3 05427	58738	
225	3194	63906	96157	21149	65120		275	1 52098	04928	51175	3 21738	19904	
226	3464	31263	22519	22392	29960		276	1 63729	39693	37171	3 38889	46600	
227	3756	11335	82570	23705	13986		277	1 76227	84330	57269	3 56923	20960	
228	4071	80636	27362	25091	98528		278	1 89656	41035	91584	3 75883	26642	
229	4413	29348	84255	26556	84608		279	2 04082	58525	75075	3 95815	57440	
230	4782	62397	45920	28103	94454		280	2 19578	63116	82516	4 16768	26624	
231	5182	00518	38712	29737	72212		281	2 36221	91453	37711	4 38791	78240	
232	5613	81486	70947	31462	84870		282	2 54095	25900	45698	4 61938	97032	
233	6080	61354	38329	33284	23936		283	2 73287	31835	47535	4 86265	19094	
234	6585	15859	70275	35207	06304		284	2 93892	97939	29555	5 11828	44672	
235	7130	41855	14919	37236	75326		285	3 16013	78671	48997	5 38689	49522	
236	7719	58926	63512	39379	02688		286	3 39758	40119	86773	5 66911	97084	
237	8356	11039	25871	41639	89458		287	3 65243	08360	71053	5 96562	52987	
238	9043	68396	68817	44025	67324		288	3 92592	21614	89422	6 27710	98024	
239	9786	29337	03585	46543	00706		289	4 21938	85285	87095	6 60430	42088	
240	10588	22467	22733	49198	87992		290	4 53425	31269	00886	6 94797	40554	
241	11454	08845	53038	52000	62976		291	4 87203	80564	72084	7 30892	09120	
242	12388	84430	77259	54955	97248		292	5 23437	10697	53672	7 68798	39744	
243	13397	82593	44888	58073	01632		293	5 62299	26919	50605	8 08604	19136	
244	14486	76924	96445	61360	27874		294	6 03976	38820	95515	8 50401	45750	
245	15661	84125	27946	64826	71322		295	6 48667	41270	79088	8 94286	47940	
246	16929	67223	91554	68481	72604		296	6 96585	01441	95831	9 40360	04868	
247	18297	38898	54026	72335	19619		297	7 47956	50785	10584	9 88727	65938	
248	19772	65166	81672	76397	50522		298	8 03024	83849	43040	10 39499	71456	
249	21363	69198	20625	80679	55712		299	8 62049	62754	65025	10 92791	76298	
250	23079	35543	64681	85192	80128		300	9 25308	29367	23602	11 48724	72064	

Table 24.5 NUMBER OF PARTITIONS AND PARTITIONS INTO DISTINCT PARTS

n	$p(n)$			$q(n)$			n	$p(n)$			$q(n)$				
300	9	25308	29367	23602	11	48724	72064	350	279	36332	84837	02152	126	91829	24648
301	9	93097	23924	03501	12	07425	10607	351	298	33006	30627	58076	132	93477	19190
302	10	65733	12325	48839	12	69025	30816	352	318	55597	37883	29084	139	22769	71520
303	11	43554	20778	22104	13	33663	83848	353	340	12281	00485	77428	145	80938	18816
304	12	26921	80192	29465	14	01485	59930	354	363	11751	20481	10005	152	69267	15868
305	13	16221	78950	57704	14	72642	18618	355	387	63253	29190	29223	159	89096	56578
306	14	11866	26652	80005	15	47292	17536	356	413	76618	09333	42362	167	41824	09148
307	15	14295	27388	57194	16	25601	42890	357	441	62298	19293	58437	175	28907	55072
308	16	23978	65358	29663	17	07743	43642	358	471	31406	42683	98780	183	51867	38752
309	17	41418	01331	47295	17	93899	64242	359	502	95756	65060	00020	192	12289	32216
310	18	67148	82996	00364	18	84259	79304	360	536	67907	03106	91121	201	11827	04478
311	20	01742	67625	76945	19	79022	32212	361	572	61205	88980	37559	210	52205	02772
312	21	45809	60373	52891	20	78394	72390	362	610	89840	37518	84101	220	35221	50410
313	23	00000	66554	87337	21	82593	94656	363	651	68887	99972	06959	230	62751	50210
314	24	65010	61508	30490	22	91846	82870	364	695	14371	34589	46040	241	36750	01278
315	26	41580	76335	66326	24	06390	52286	365	741	43315	98840	81684	252	59255	33946
316	28	30502	03409	96003	25	26472	94208	366	790	73811	96494	11319	264	32392	51488
317	30	32618	19898	42964	26	52353	25352	367	843	25078	85625	28427	276	58376	86784
318	32	48829	33514	66654	27	84302	35904	368	899	17534	83960	88349	289	39517	78822
319	34	80095	48694	40830	29	22603	40224	369	958	72869	79123	38045	302	78222	57408
320	37	27440	57767	48077	30	67552	32574	370	1022	14122	83673	45362	316	77000	44480
321	39	91956	55269	99991	32	19458	41664	371	1089	65764	44243	99782	331	38466	77248
322	42	74807	80359	54696	33	78644	88192	372	1161	53783	48499	62850	346	65347	41118
323	45	77235	85435	78028	35	45449	47722	373	1238	05779	41191	25085	362	60483	21048
324	49	00564	36352	37875	37	20225	12608	374	1319	51059	97274	73500	379	26834	76992
325	52	46204	42288	28641	39	03340	57172	375	1406	20744	65614	84054	396	67487	30794
326	56	15660	21128	74289	40	95181	08690	376	1498	47874	35905	81081	414	85655	73659
327	60	10534	98396	66544	42	96149	17632	377	1596	67527	44907	56791	433	84690	00206
328	64	32537	46091	14550	45	06665	31450	378	1701	16942	79758	13525	453	68080	55808
329	68	83488	59460	73850	47	27168	74732	379	1812	35649	97394	72950	474	39464	06976
330	73	65328	78618	50339	49	58118	28759	380	1930	65607	23504	65812	496	02629	40968
331	78	80125	53026	66615	51	99993	15040	381	2056	51347	53366	33805	518	61523	80864
332	84	30081	56362	25119	54	53293	85792	382	2190	40133	24237	65131	542	20259	26436
333	90	17543	49805	49623	57	18543	13990	383	2332	82119	85438	92336	566	83119	27092
334	96	45011	01922	02760	59	96286	87918	384	2484	30529	42654	18180	592	54565	72864
335	103	15146	63217	35325	62	87095	13216	385	2645	41834	06887	63701	619	39246	14094
336	110	30786	04252	92772	65	91563	14788	386	2816	75950	32179	42792	647	42001	16480
337	117	94949	15461	13972	69	10312	43770	387	2998	96444	77364	52194	676	67872	37064
338	126	10851	78337	96355	72	43991	92576	388	3192	70751	84335	32826	707	22110	32064
339	134	81918	06233	01520	75	93279	10200	389	3398	70404	13581	60275	739	10183	03854
340	144	11793	65278	73832	79	58881	23110	390	3617	71276	38676	04423	772	37784	71936
341	154	04359	73795	76030	83	41536	64940	391	3850	53843	46674	29186	807	10844	79444
342	164	63747	91657	61044	87	42016	06890	392	4098	03453	56265	94791	843	35537	42947
343	175	94355	98104	22753	91	61123	94270	393	4361	10617	07622	84114	881	18291	29614
344	188	00864	70522	92980	95	99699	92704	394	4640	71312	46996	23515	920	65799	74150
345	200	88255	62876	83159	100	58620	35461	395	4937	87309	67881	91655	961	85031	43424
346	214	61829	97432	86299	105	38799	77632	396	5253	66512	44169	75163	1004	83241	32444
347	229	27228	68712	17150	110	41192	60918	397	5589	23320	25954	04488	1049	67982	04736
348	244	90453	74553	82406	115	66794	79970	398	5945	79011	47078	74597	1096	47115	85280
349	261	57890	73511	44125	121	16645	56454	399	6324	62148	25042	94325	1145	28826	89344
350	279	36332	84837	02152	126	91829	24648	400	6727	09005	17410	41926	1196	21634	00706

NUMBER OF PARTITIONS AND PARTITIONS INTO DISTINCT PARTS

Table 24.5

n	$p(n)$				$q(n)$				n	$p(n)$				$q(n)$			
400	6727	09005	17410	41926	1196	21634	00706	450	1	34508	18800	15729	23840	9893	14440	61528	
401	7154	64022	26539	42321	1249	34404	08000	451	1	42573	13615	53474	04229	10307	93957	13070	
402	7608	80284	33398	79269	1304	76365	81998	452	1	51112	26207	19173	13678	10739	65687	10144	
403	8091	20027	64844	65581	1362	57124	07808	453	1	60152	90524	45537	15585	11188	96810	43072	
404	8603	55175	93486	55060	1422	86674	81438	454	1	69723	95104	64580	40965	11656	57102	54336	
405	9147	67906	88591	17602	1485	75420	52794	455	1	79855	91645	39582	67598	12143	19032	12544	
406	9725	51251	37420	21729	1551	34186	29884	456	1	90581	04044	26519	31034	12649	57862	22432	
407	10339	09726	71239	47241	1619	74236	54282	457	2	01933	37928	51146	88629	13176	51755	08648	
408	10990	60006	37759	26994	1691	07292	29128	458	2	13948	90703	27330	69132	13724	81881	00782	
409	11682	31627	71923	17780	1765	45549	15430	459	2	26665	62143	58313	45565	14295	32530	93376	
410	12416	67740	31511	90382	1843	01696	07104	460	2	40123	65561	39251	92081	14888	91233	20640	
411	13196	25896	69254	35702	1923	88934	65516	461	2	54365	39575	85741	99975	15506	48874	75476	
412	14023	78888	35188	47344	2008	20999	30208	462	2	69435	60521	29549	94471	16148	99826	46592	
413	14902	15629	03099	48968	2096	12178	16576	463	2	85381	55524	19619	86287	16817	42073	15550	
414	15834	42088	44881	87770	2187	77334	80960	464	3	02253	16287	25766	36605	17512	77348	45952	
415	16823	82278	71392	35544	2283	31930	70488	465	3	20103	13615	29932	90544	18236	11274	38194	
416	17873	79296	96898	76004	2382	92048	69148	466	3	38987	12724	95254	32549	18988	53505	94524	
417	18987	96426	73316	64557	2486	74417	20078	467	3	58963	89376	81628	76613	19771	17881	29024	
418	20170	18301	88059	33659	2594	96435	42056	468	3	80095	46876	31205	98477	20585	22576	95744	
419	21424	52136	02556	36320	2707	76199	52640	469	4	02447	33986	17114	75160	21431	90268	83034	
420	22755	29021	65800	25259	2825	32529	77152	470	4	26088	63801	56524	13417	22312	48299	10884	
421	24167	05302	14413	63961	2947	84998	62528	471	4	51092	33635	50960	99864	23228	28849	04960	
422	25664	64021	38377	14846	3075	53960	09352	472	4	77535	45970	81641	15593	24180	69117	98586	
423	27253	16454	62304	21739	3208	60580	00384	473	5	05499	30531	42046	29558	25171	11509	01902	
424	28938	03725	70847	98150	3347	26867	45954	474	5	35069	67535	16072	62125	26201	03821	12696	
425	30724	98514	70950	51099	3491	75707	60097	475	5	66337	12186	58055	99675	27271	99448	23232	
426	32620	06861	74102	32189	3642	30895	45254	476	5	99397	20478	23018	52926	28385	57585	65430	
427	34629	70071	39035	75934	3799	17171	07136	477	6	34350	76365	37870	28583	29543	43443	69603	
428	36760	66724	18315	27309	3962	60256	14146	478	6	71304	20389	67318	07232	30747	28468	94368	
429	39020	14800	02372	59665	4132	86891	79000	479	7	10369	79823	66282	38005	31998	90573	73738	
430	41415	73920	71023	58378	4310	24877	85006	480	7	51666	00419	49931	25591	33300	14373	57056	
431	43955	47717	05181	16534	4495	03113	72460	481	7	95317	79841	47582	32180	34652	91433	03468	
432	46647	86328	42292	67991	4687	51640	62334	482	8	41457	02874	28236	49455	36059	20520	80640	
433	49501	89040	94051	50715	4888	01685	40672	483	8	90222	78495	19280	88294	37521	07873	43946	
434	52527	07072	91082	40605	5096	85706	20480	484	9	41761	78911	49976	98055	39040	67468	62530	
435	55733	46514	46362	86656	5314	37439	57460	485	9	96228	80660	85734	11012	40620	21308	45496	
436	59131	71430	91696	18645	5540	91949	44512	486	10	53787	07886	24553	46513	42261	99712	45764	
437	62733	07137	60430	79215	5776	85678	02880	487	11	14608	77893	64264	84248	43968	41621	12802	
438	66549	43656	69662	97367	6022	56498	45546	488	11	78875	49115	57358	02646	45741	94910	51264	
439	70593	39364	65621	35510	6278	43769	39520	489	12	46778	71600	12729	19665	47585	16717	64998	
440	74878	24841	94708	86233	6544	88391	85792	490	13	18520	40161	22702	33223	49500	73777	62304	
441	79418	06934	64434	02240	6822	32867	92200	491	13	94313	50322	44478	16939	51491	42772	84172	
442	84227	73040	77294	99781	7111	21361	67457	492	14	74382	57204	03639	53132	53560	10694	36938	
443	89322	95632	13536	45667	7411	99762	56080	493	15	58964	37499	49778	06173	55709	75216	10170	
444	94720	37025	78934	71820	7725	15750	89318	494	16	48308	54706	61724	38760	57943	45082	47040	
445	1	00437	54417	17528	47604	8051	18865	81728	495	17	42678	27774	77609	81187	60264	40509	50309
446	1	06493	05190	52391	18581	8390	60575	94564	496	18	42351	03350	31598	91466	62675	93600	10788
447	1	12906	52519	91961	03354	8743	94352	40798	497	19	47619	31798	76580	64007	65181	48774	31176
448	1	19698	71278	27202	05954	9111	75744	62854	498	20	58791	47204	28849	01563	67784	63214	30326
449	1	26891	54269	09814	18000	9494	62459	05984	499	21	76192	51543	92874	61625	70489	07325	21792
450	1	34508	18800	15729	23840	9893	14440	61528	500	23	00165	03257	43239	95027	73298	65212	45024

Table 24.6

ARITHMETIC FUNCTIONS

<i>n</i>	$\varphi(n)$	σ_0	σ_1	<i>n</i>	$\varphi(n)$	σ_0	σ_1	<i>n</i>	$\varphi(n)$	σ_0	σ_1	<i>n</i>	$\varphi(n)$	σ_0	σ_1	<i>n</i>	$\varphi(n)$	σ_0	σ_1
1	1	1	1	51	32	4	72	101	100	2	102	151	150	2	152	201	132	4	272
2	1	2	3	52	24	6	98	102	32	8	216	152	72	8	300	202	100	4	306
3	2	2	4	53	52	2	54	103	102	2	104	153	96	6	234	203	168	4	240
4	2	3	7	54	18	8	120	104	48	8	210	154	60	8	288	204	64	12	504
5	4	2	6	55	40	4	72	105	48	8	192	155	120	4	192	205	160	4	252
6	2	4	12	56	24	8	120	106	52	4	162	156	48	12	392	206	102	4	312
7	6	2	8	57	36	4	80	107	106	2	108	157	156	2	158	207	132	6	312
8	4	4	15	58	28	4	90	108	36	12	280	158	78	4	240	208	96	10	434
9	6	3	13	59	58	2	60	109	108	2	110	159	104	4	216	209	180	4	240
10	4	4	18	60	16	12	168	110	40	8	216	160	64	12	378	210	48	16	576
11	10	2	12	61	60	2	62	111	72	4	152	161	132	4	192	211	210	2	212
12	4	6	28	62	30	4	96	112	48	10	248	162	54	10	363	212	104	6	378
13	12	2	14	63	36	6	104	113	112	2	114	163	162	2	164	213	140	4	288
14	6	4	24	64	32	7	127	114	36	8	240	164	80	6	294	214	106	4	324
15	8	4	24	65	48	4	84	115	88	4	144	165	80	8	288	215	168	4	264
16	8	5	31	66	20	8	144	116	56	6	210	166	82	4	252	216	72	16	600
17	16	2	18	67	66	2	68	117	72	6	182	167	166	2	168	217	180	4	256
18	6	6	39	68	32	6	126	118	58	4	180	168	48	16	480	218	108	4	330
19	18	2	20	69	44	4	96	119	96	4	144	169	156	3	183	219	144	4	296
20	8	6	42	70	24	8	144	120	32	16	360	170	64	8	324	220	80	12	504
21	12	4	32	71	70	2	72	121	110	3	133	171	108	6	260	221	192	4	252
22	10	4	36	72	24	12	195	122	60	4	186	172	84	6	308	222	72	8	456
23	22	2	24	73	72	2	74	123	80	4	168	173	172	2	174	223	222	2	224
24	8	8	60	74	36	4	114	124	60	6	224	174	56	8	360	224	96	12	504
25	20	3	31	75	40	6	124	125	100	4	156	175	120	6	248	225	120	9	403
26	12	4	42	76	36	6	140	126	36	12	312	176	80	10	372	226	112	4	342
27	18	4	40	77	60	4	96	127	126	2	128	177	116	4	240	227	226	2	228
28	12	6	56	78	24	8	168	128	64	8	255	178	88	4	270	228	72	12	560
29	28	2	30	79	78	2	80	129	84	4	176	179	178	2	180	229	228	2	230
30	8	8	72	80	32	10	186	130	48	8	252	180	48	18	546	230	88	8	432
31	30	2	32	81	54	5	121	131	130	2	132	181	180	2	182	231	120	8	384
32	16	6	63	82	40	4	126	132	40	12	336	182	72	8	336	232	112	8	450
33	20	4	48	83	82	2	84	133	108	4	160	183	120	4	248	233	232	2	234
34	16	4	54	84	24	12	224	134	66	4	204	184	88	8	360	234	72	12	546
35	24	4	48	85	64	4	108	135	72	8	240	185	144	4	228	235	184	4	288
36	12	9	91	86	42	4	132	136	64	8	270	186	60	8	384	236	116	6	420
37	36	2	38	87	56	4	120	137	136	2	138	187	160	4	216	237	156	4	320
38	18	4	60	88	40	8	180	138	44	8	288	188	92	6	336	238	96	8	432
39	24	4	56	89	88	2	90	139	138	2	140	189	108	8	320	239	238	2	240
40	16	8	90	90	24	12	234	140	48	12	336	190	72	8	360	240	64	20	744
41	40	2	42	91	72	4	112	141	92	4	192	191	190	2	192	241	240	2	242
42	12	8	96	92	44	6	168	142	70	4	216	192	64	14	508	242	110	6	399
43	42	2	44	93	60	4	128	143	120	4	168	193	192	2	194	243	162	6	364
44	20	6	84	94	46	4	144	144	48	15	403	194	96	4	294	244	120	6	434
45	24	6	78	95	72	4	120	145	112	4	180	195	96	8	336	245	168	6	342
46	22	4	72	96	32	12	252	146	72	4	222	196	84	9	399	246	80	8	504
47	46	2	48	97	96	2	98	147	84	6	228	197	196	2	198	247	216	4	280
48	16	10	124	98	42	6	171	148	72	6	266	198	60	12	468	248	120	8	480
49	42	3	57	99	60	6	156	149	148	2	150	199	198	2	200	249	164	4	336
50	20	6	93	100	40	9	217	150	40	12	372	200	80	12	465	250	100	8	468

From British Association for the Advancement of Science, Mathematical Tables, vol. VIII, Number-divisor tables. Cambridge Univ. Press, Cambridge, England, 1940 (with permission).

$$\sum_1^{24} \phi(m) = 180$$

$$\sum_1^{42} \phi(m) = 542$$

$$\sum_1^{60} \phi(m) = 1162$$

ARITHMETIC FUNCTIONS

Table 24.6

n	$\varphi(n)$	σ_0	σ_1	n	$\varphi(n)$	σ_0	σ_1	n	$\varphi(n)$	σ_0	σ_1	n	$\varphi(n)$	σ_0	σ_1	n	$\varphi(n)$	σ_0	σ_1
251	250	2	252	301	252	4	352	351	216	8	560	401	400	2	402	451	400	4	504
252	72	18	728	302	150	4	456	352	160	12	756	402	132	8	816	452	224	6	798
253	220	4	288	303	200	4	408	353	352	2	354	403	360	4	448	453	300	4	608
254	126	4	384	304	144	10	620	354	116	8	720	404	200	6	714	454	226	4	684
255	128	8	432	305	240	4	372	355	280	4	432	405	216	10	726	455	288	8	672
256	128	9	511	306	96	12	702	356	176	6	630	406	168	8	720	456	144	16	1200
257	256	2	258	307	306	2	308	357	192	8	576	407	360	4	456	457	456	2	458
258	84	8	528	308	120	12	672	358	178	4	540	408	128	16	1080	458	228	4	690
259	216	4	304	309	204	4	416	359	358	2	360	409	408	2	410	459	288	8	720
260	96	12	588	310	120	8	576	360	96	24	1170	410	160	8	756	460	176	12	1008
261	168	6	390	311	310	2	312	361	342	3	381	411	272	4	552	461	460	2	462
262	130	4	396	312	96	16	840	362	180	4	546	412	204	6	728	462	120	16	1152
263	262	2	264	313	312	2	314	363	220	6	532	413	348	4	480	463	462	2	464
264	80	16	720	314	156	4	474	364	144	12	784	414	132	12	936	464	224	10	930
265	208	4	324	315	144	12	624	365	288	4	444	415	328	4	504	465	240	8	768
266	108	8	480	316	156	6	560	366	120	8	744	416	192	12	882	466	232	4	702
267	176	4	360	317	316	2	318	367	366	2	368	417	276	4	560	467	466	2	468
268	132	6	476	318	104	8	648	368	176	10	744	418	180	8	720	468	144	18	1274
269	268	2	270	319	280	4	360	369	240	6	546	419	418	2	420	469	396	4	544
270	72	16	720	320	128	14	762	370	144	8	684	420	96	24	1344	470	184	8	864
271	270	2	272	321	212	4	432	371	312	4	432	421	420	2	422	471	312	4	632
272	128	10	558	322	132	8	576	372	120	12	896	422	210	4	636	472	232	8	900
273	144	8	448	323	288	4	360	373	372	2	374	423	276	6	624	473	420	4	528
274	136	4	414	324	108	15	847	374	160	8	648	424	208	8	810	474	156	8	960
275	200	6	372	325	240	6	434	375	200	8	624	425	320	6	558	475	360	6	620
276	88	12	672	326	162	4	492	376	184	8	720	426	140	8	864	476	192	12	1008
277	276	2	278	327	216	4	440	377	336	4	420	427	360	4	496	477	312	6	702
278	138	4	420	328	160	8	630	378	108	16	960	428	212	6	756	478	238	4	720
279	180	6	416	329	276	4	384	379	378	2	380	429	240	8	672	479	478	2	480
280	96	16	720	330	80	16	864	380	144	12	840	430	168	8	792	480	128	24	1512
281	280	2	282	331	330	2	332	381	252	4	512	431	430	2	432	481	432	4	532
282	92	8	576	332	164	6	588	382	190	4	576	432	144	20	1240	482	240	4	726
283	282	2	284	333	216	6	494	383	382	2	384	433	432	2	434	483	264	8	768
284	140	6	504	334	166	4	504	384	128	16	1020	434	180	8	768	484	220	9	931
285	144	8	480	335	264	4	408	385	240	8	576	435	224	8	720	485	384	4	588
286	120	8	504	336	96	20	992	386	192	4	582	436	216	6	770	486	162	12	1092
287	240	4	336	337	336	2	338	387	252	6	572	437	396	4	480	487	486	2	488
288	96	18	819	338	156	6	549	388	192	6	686	438	144	8	888	488	240	8	930
289	272	3	307	339	224	4	456	389	388	2	390	439	438	2	440	489	324	4	656
290	112	8	540	340	128	12	756	390	96	16	1008	440	160	16	1080	490	168	12	1026
291	192	4	392	341	300	4	384	391	352	4	432	441	252	9	741	491	490	2	492
292	144	6	578	342	108	12	780	392	168	12	855	442	192	8	756	492	160	12	1176
293	292	2	294	343	294	4	400	393	260	4	528	443	442	2	444	493	448	4	540
294	84	12	684	344	168	8	660	394	196	4	594	444	144	12	1064	494	216	8	840
295	232	4	360	345	176	8	576	395	312	4	480	445	352	4	540	495	240	12	936
296	144	8	570	346	172	4	522	396	120	18	1092	446	222	4	672	496	240	10	992
297	180	8	480	347	346	2	348	397	396	2	398	447	296	4	600	497	420	4	576
298	148	4	450	348	112	12	840	398	198	4	600	448	192	14	1016	498	164	8	1008
299	264	4	336	349	348	2	350	399	216	8	640	449	448	2	450	499	498	2	500
300	80	18	868	350	120	12	744	400	160	15	961	450	120	18	1209	500	200	12	1092

Table 24.6

ARITHMETIC FUNCTIONS

n	$\varphi(n)$	σ_0	σ_1	n	$\varphi(n)$	σ_0	σ_1	n	$\varphi(n)$	σ_0	σ_1	n	$\varphi(n)$	σ_0	σ_1	n	$\varphi(n)$	σ_0	σ_1
501	332	4	672	551	504	4	600	601	600	2	602	651	360	8	1024	701	700	2	702
502	250	4	756	552	176	16	1440	602	252	8	1056	652	324	6	1148	702	216	16	1680
503	502	2	504	553	468	4	640	603	396	6	884	653	652	2	654	703	648	4	760
504	144	24	1560	554	276	4	834	604	300	6	1064	654	216	8	1320	704	320	14	1524
505	400	4	612	555	288	8	912	605	440	6	798	655	520	4	792	705	368	8	1152
506	220	8	864	556	276	6	980	606	200	8	1224	656	320	10	1302	706	352	4	1062
507	312	6	732	557	556	2	558	607	606	2	608	657	432	6	962	707	600	4	816
508	252	6	896	558	180	12	1248	608	288	12	1260	658	276	8	1152	708	232	12	1680
509	508	2	510	559	504	4	616	609	336	8	960	659	658	2	660	709	708	2	710
510	128	16	1296	560	192	20	1488	610	240	8	1116	660	160	24	2016	710	280	8	1296
511	432	4	592	561	320	8	864	611	552	4	672	661	660	2	662	711	468	6	1040
512	256	10	1023	562	280	4	846	612	192	18	1638	662	330	4	996	712	352	8	1350
513	324	8	800	563	562	2	564	613	612	2	614	663	384	8	1008	713	660	4	768
514	256	4	774	564	184	12	1344	614	306	4	924	664	328	8	1260	714	192	16	1728
515	408	4	624	565	448	4	684	615	320	8	1008	665	432	8	960	715	480	8	1008
516	168	12	1232	566	282	4	852	616	240	16	1440	666	216	12	1482	716	356	6	1260
517	460	4	576	567	324	10	968	617	616	2	618	667	616	4	720	717	476	4	960
518	216	8	912	568	280	8	1080	618	204	8	1248	668	332	6	1176	718	358	4	1080
519	344	4	696	569	568	2	570	619	618	2	620	669	444	4	896	719	718	2	720
520	192	16	1260	570	144	16	1440	620	240	12	1344	670	264	8	1224	720	192	30	2418
521	520	2	522	571	570	2	572	621	396	8	960	671	600	4	744	721	612	4	832
522	168	12	1170	572	240	12	1176	622	310	4	936	672	192	24	2016	722	342	6	1143
523	522	2	524	573	380	4	768	623	528	4	720	673	672	2	674	723	480	4	968
524	260	6	924	574	240	8	1008	624	192	20	1736	674	336	4	1014	724	360	6	1274
525	240	12	992	575	440	6	744	625	500	5	781	675	360	12	1240	725	560	6	930
526	262	4	792	576	192	21	1651	626	312	4	942	676	312	9	1281	726	220	12	1596
527	480	4	576	577	576	2	578	627	360	8	960	677	676	2	678	727	726	2	728
528	160	20	1488	578	272	6	921	628	312	6	1106	678	224	8	1368	728	288	16	1680
529	506	3	553	579	384	4	776	629	576	4	684	679	576	4	784	729	486	7	1093
530	208	8	972	580	224	12	1260	630	144	24	1872	680	256	16	1620	730	288	8	1332
531	348	6	780	581	492	4	672	631	630	2	632	681	452	4	912	731	672	4	792
532	216	12	1120	582	192	8	1176	632	312	8	1200	682	300	8	1152	732	240	12	1736
533	480	4	588	583	520	4	648	633	420	4	848	683	682	2	684	733	732	2	734
534	176	8	1080	584	288	8	1110	634	316	4	954	684	216	18	1820	734	366	4	1104
535	424	4	648	585	288	12	1092	635	504	4	768	685	544	4	828	735	336	12	1368
536	264	8	1020	586	292	4	882	636	208	12	1512	686	294	8	1200	736	352	12	1512
537	356	4	720	587	586	2	588	637	504	6	798	687	456	4	920	737	660	4	816
538	268	4	810	588	168	18	1596	638	280	8	1080	688	336	10	1364	738	240	12	1638
539	420	6	684	589	540	4	640	639	420	6	936	689	624	4	756	739	738	2	740
540	144	24	1680	590	232	8	1080	640	256	16	1530	690	176	16	1728	740	288	12	1596
541	540	2	542	591	392	4	792	641	640	2	642	691	690	2	692	741	432	8	1120
542	270	4	816	592	288	10	1178	642	212	8	1296	692	344	6	1218	742	312	8	1296
543	360	4	728	593	592	2	594	643	642	2	644	693	360	12	1248	743	742	2	744
544	256	12	1134	594	180	16	1440	644	264	12	1344	694	346	4	1044	744	240	16	1920
545	432	4	660	595	384	8	864	645	336	8	1056	695	552	4	840	745	592	4	900
546	144	16	1344	596	296	6	1050	646	288	8	1080	696	224	16	1800	746	372	4	1122
547	546	2	548	597	396	4	800	647	646	2	648	697	640	4	756	747	492	6	1092
548	272	6	966	598	264	8	1008	648	216	20	1815	698	348	4	1050	748	320	12	1512
549	360	6	806	599	598	2	600	649	580	4	720	699	464	4	936	749	636	4	864
550	200	12	1116	600	160	24	1860	650	240	12	1302	700	240	18	1736	750	200	16	1872

Tout dans III

ARITHMETIC FUNCTIONS

Table 24.6

n	$\varphi(n)$	σ_0	σ_1	n	$\varphi(n)$	σ_0	σ_1	n	$\varphi(n)$	σ_0	σ_1	n	$\varphi(n)$	σ_0	σ_1	n	$\varphi(n)$	σ_0	σ_1
751	750	2	752	801	528	6	1170	851	792	4	912	901	832	4	972	951	632	4	1272
752	368	10	1488	802	400	4	1206	852	280	12	2016	902	400	8	1512	952	384	16	2160
753	500	4	1008	803	720	4	888	853	852	2	854	903	504	8	1408	953	952	2	954
754	336	8	1260	804	264	12	1904	854	360	8	1488	904	448	8	1710	954	312	12	2106
755	600	4	912	805	528	8	1152	855	432	12	1560	905	720	4	1092	955	760	4	1152
756	216	24	2240	806	360	8	1344	856	424	8	1620	906	300	8	1824	956	476	6	1680
757	756	2	758	807	536	4	1080	857	856	2	858	907	906	2	908	957	560	8	1440
758	378	4	1140	808	400	8	1530	858	240	16	2016	908	452	6	1596	958	478	4	1440
759	440	8	1152	809	808	2	810	859	858	2	860	909	600	6	1326	959	816	4	1104
760	288	16	1800	810	216	20	2178	860	336	12	1848	910	288	16	2016	960	256	28	3048
761	760	2	762	811	810	2	812	861	480	8	1344	911	910	2	912	961	930	3	993
762	252	8	1536	812	336	12	1680	862	430	4	1296	912	288	20	2480	962	432	8	1596
763	648	4	880	813	540	4	1088	863	862	2	864	913	820	4	1008	963	636	6	1404
764	380	6	1344	814	360	8	1368	864	288	24	2520	914	456	4	1374	964	480	6	1694
765	384	12	1404	815	648	4	984	865	688	4	1044	915	480	8	1488	965	768	4	1164
766	382	4	1152	816	256	20	2232	866	432	4	1302	916	456	6	1610	966	264	16	2304
767	696	4	840	817	756	4	880	867	544	6	1228	917	780	4	1056	967	966	2	968
768	256	18	2044	818	408	4	1230	868	360	12	1792	918	288	16	2160	968	440	12	1995
769	768	2	770	819	432	12	1456	869	780	4	960	919	918	2	920	969	576	8	1440
770	240	16	1728	820	320	12	1764	870	224	16	2160	920	352	16	2160	970	384	8	1764
771	512	4	1032	821	820	2	822	871	792	4	952	921	612	4	1232	971	970	2	972
772	384	6	1358	822	272	8	1656	872	432	8	1650	922	460	4	1386	972	324	18	2548
773	772	2	774	823	822	2	824	873	576	6	1274	923	840	4	1008	973	828	4	1120
774	252	12	1716	824	408	8	1560	874	396	8	1440	924	240	24	2688	974	486	4	1464
775	600	6	992	825	400	12	1488	875	600	8	1248	925	720	6	1178	975	480	12	1736
776	384	8	1470	826	348	8	1440	876	288	12	2072	926	462	4	1392	976	480	10	1922
777	432	8	1216	827	826	2	828	877	876	2	878	927	612	6	1352	977	976	2	978
778	388	4	1170	828	264	18	2184	878	438	4	1320	928	448	12	1890	978	324	8	1968
779	720	4	840	829	828	2	830	879	584	4	1176	929	928	2	930	979	880	4	1080
780	192	24	2352	830	328	8	1512	880	320	20	2232	930	240	16	2304	980	336	18	2394
781	700	4	864	831	552	4	1112	881	880	2	882	931	756	6	1140	981	648	6	1430
782	352	8	1296	832	384	14	1778	882	252	18	2223	932	464	6	1638	982	490	4	1476
783	504	8	1200	833	672	6	1026	883	882	2	884	933	620	4	1248	983	982	2	984
784	336	15	1767	834	276	8	1680	884	384	12	1764	934	466	4	1404	984	320	16	2520
785	624	4	948	835	664	4	1008	885	464	8	1440	935	640	8	1296	985	784	4	1188
786	260	8	1584	836	360	12	1680	886	442	4	1332	936	288	24	2730	986	448	8	1620
787	786	2	788	837	540	8	1280	887	886	2	888	937	936	2	938	987	552	8	1536
788	392	6	1386	838	418	4	1260	888	288	16	2280	938	396	8	1632	988	432	12	1960
789	524	4	1056	839	838	2	840	889	756	4	1024	939	624	4	1256	989	924	4	1056
790	312	8	1440	840	192	32	2880	890	352	8	1620	940	368	12	2016	990	240	24	2808
791	672	4	912	841	812	3	871	891	540	10	1452	941	940	2	942	991	990	2	992
792	240	24	2340	842	420	4	1266	892	444	6	1568	942	312	8	1896	992	480	12	2016
793	720	4	868	843	560	4	1128	893	828	4	960	943	880	4	1008	993	660	4	1328
794	396	4	1194	844	420	6	1484	894	296	8	1800	944	464	10	1860	994	420	8	1728
795	416	8	1296	845	624	6	1098	895	712	4	1080	945	432	16	1920	995	792	4	1200
796	396	6	1400	846	276	12	1872	896	384	16	2040	946	420	8	1584	996	328	12	2352
797	796	2	798	847	660	6	1064	897	528	8	1344	947	946	2	948	997	996	2	998
798	216	16	1920	848	416	10	1674	898	448	4	1350	948	312	12	2240	998	498	4	1500
799	736	4	864	849	564	4	1136	899	840	4	960	949	864	4	1036	999	648	8	1520
800	320	18	1953	850	320	12	1674	900	240	27	2921	950	360	12	1860	1000	400	16	2340

N	0	1	2	3	4	5	6	7	8	9	N
0	—	1	2	3	2 ²	5	2·3	7	2 ³	3 ²	0
1	2·5	11	2 ² ·3	13	2·7	3·5	2 ⁴	17	2·3 ²	19	1
2	2 ² ·5	3·7	2·11	23	2 ² ·3	5 ²	2·13	3 ³	2 ² ·7	29	2
3	2 ³ ·5	31	2 ⁵	3·11	2·17	5·7	2 ² ·3 ²	37	2·19	3·13	3
4	2 ⁴ ·5	41	2 ³ ·7	43	2 ² ·11	3 ² ·5	2·23	47	2 ⁴ ·3	7 ²	4
5	2·5 ²	3·17	2 ² ·13	53	2·3 ³	5·11	2 ³ ·7	3·19	2·29	59	5
6	2 ² ·3·5	61	2·31	3 ² ·7	2 ⁶	5·13	2·3·11	67	2 ² ·17	3·23	6
7	2·5·7	71	2 ³ ·3 ²	73	2·37	3·5 ²	2 ² ·19	7·11	2·3·13	79	7
8	2 ⁴ ·5	3 ⁴	2·41	83	2 ² ·3·7	5·17	2·43	3·29	2 ³ ·11	89	8
9	2·3 ² ·5	7·13	2 ² ·23	3·31	2·47	5·19	2 ⁵ ·3	97	2·7 ²	3 ² ·11	9
10	2 ² ·5 ²	101	2·3·17	103	2 ² ·13	3·5·7	2·53	107	2 ² ·3 ³	109	10
11	2·5·11	3·37	2 ⁴ ·7	113	2·3·19	5·23	2 ² ·29	3 ² ·13	2·59	7·17	11
12	2 ³ ·3·5	11 ²	2·61	3·41	2 ² ·31	5 ³	2·3 ² ·7	127	2 ⁷	3·43	12
13	2·5·13	131	2 ² ·3·11	7·19	2·67	3 ⁴ ·5	2 ² ·17	137	2·3·23	139	13
14	2 ² ·5·7	3·47	2·71	11·13	2·4·3 ²	5·29	2·73	3·7 ²	2 ² ·37	149	14
15	2·3·5 ²	151	2 ³ ·19	3 ² ·17	2·7·11	5·31	2 ² ·3·13	157	2·79	3·53	15
16	2 ⁵ ·5	7·23	2·3 ⁴	163	2 ² ·41	3·5·11	2·83	167	2 ³ ·3·7	13 ²	16
17	2·5·17	3 ² ·19	2 ² ·43	173	2·3·29	5 ² ·7	2 ⁴ ·11	3·59	2·89	179	17
18	2 ² ·3 ² ·5	181	2·7·13	3·61	2 ² ·23	5·37	2·3·31	11·17	2 ² ·47	3 ² ·7	18
19	2·5·19	191	2 ⁶ ·3	193	2·97	3·5·13	2 ² ·7 ²	197	2·3 ² ·11	199	19
20	2 ³ ·5 ²	3·67	2·101	7·29	2 ² ·3·17	5·41	2·103	3 ² ·23	2 ⁴ ·13	11·19	20
21	2·3·5·7	211	2 ² ·53	3·71	2·107	5·43	2 ³ ·3 ³	7·31	2·109	3·73	21
22	2 ² ·5·11	13·17	2·3·37	223	2 ² ·7	3 ² ·5 ²	2·113	227	2 ² ·3·19	229	22
23	2·5·23	3·7·11	2 ³ ·29	233	2·3 ² ·13	5·47	2 ² ·59	3·79	2·7·17	239	23
24	2 ⁴ ·3·5	241	2·11 ²	3 ⁵	2 ² ·61	5·7 ²	2·3·41	13·19	2 ³ ·31	3·83	24
25	2·5 ³	251	2 ² ·3 ² ·7	11·23	2·127	3·5·17	2 ⁸	257	2·3·43	7·37	25
26	2 ² ·5·13	3 ² ·29	2·131	263	2 ² ·3·11	5·53	2·7·19	3·89	2 ² ·67	269	26
27	2·3 ³ ·5	271	2 ⁴ ·17	3·7·13	2·137	5 ² ·11	2 ² ·3·23	277	2·139	3 ² ·31	27
28	2 ³ ·5·7	281	2·3·47	283	2 ² ·71	3·5·19	2·11·13	7·41	2 ⁵ ·3 ²	17 ²	28
29	2·5·29	3·97	2 ² ·73	293	2·3·7 ²	5·59	2 ³ ·37	3 ² ·11	2·149	13·23	29
30	2 ² ·3·5 ²	7·43	2·151	3·101	2 ⁴ ·19	5·61	2·3 ² ·17	307	2 ² ·7·11	3·103	30
31	2·5·31	311	2 ³ ·3·13	313	2·157	3 ² ·5·7	2 ² ·79	317	2·3·53	11·29	31
32	2 ⁶ ·5	3·107	2·7·23	17·19	2 ² ·3 ⁴	5 ² ·13	2·163	3·109	2 ³ ·41	7·47	32
33	2·3·5·11	331	2 ² ·83	3 ² ·37	2·167	5·67	2 ⁴ ·3·7	337	2·13 ²	3·113	33
34	2 ² ·5·17	11·31	2·3 ² ·19	7 ²	2 ³ ·43	3·5·23	2·173	347	2 ² ·3·29	349	34
35	2·5 ² ·7	3 ³ ·13	2 ⁵ ·11	353	2·3·59	5·71	2 ² ·89	3·7·17	2·179	359	35
36	2 ³ ·3 ² ·5	19 ²	2·181	3·11 ²	2 ² ·7·13	5·73	2·3·61	367	2 ² ·23	3 ² ·41	36
37	2·5·37	7·53	2 ² ·3·31	373	2·11·17	3·5 ³	2 ³ ·47	13·29	2·3 ² ·7	379	37
38	2 ² ·5·19	3·127	2·191	383	2 ⁷ ·3	5·7·11	2·193	3 ² ·43	2 ² ·97	389	38
39	2·3·5·13	17·23	2 ³ ·7 ²	3·131	2·197	5·79	2 ² ·3 ² ·11	397	2·199	3·7·19	39
40	2 ⁴ ·5 ²	401	2·3·67	13·31	2 ² ·101	3 ⁴ ·5	2·7·29	11·37	2 ² ·3·17	409	40
41	2·5·41	3·137	2 ² ·103	7·59	2·3 ² ·23	5·83	2 ⁵ ·13	3·139	2·11·19	419	41
42	2 ² ·3·5·7	421	2·211	3 ² ·47	2 ³ ·53	5 ² ·17	2·3·71	7·61	2 ² ·107	3·11·13	42
43	2·5·43	431	2 ⁴ ·3 ³	433	2·7·31	3·5·29	2 ² ·109	19·23	2·3·73	439	43
44	2 ² ·5·11	3 ² ·7 ²	2·13·17	443	2 ² ·3·37	5·89	2·223	3·149	2 ⁶ ·7	449	44
45	2·3 ² ·5 ²	11·41	2 ² ·113	3·151	2·227	5·7·13	2 ² ·3·19	457	2·229	3 ³ ·17	45
46	2 ² ·5·23	461	2·3·7·11	463	2 ⁴ ·29	3·5·31	2·233	467	2 ² ·3 ² ·13	7·67	46
47	2·5·47	3·157	2 ² ·59	11·43	2·3·79	5 ² ·19	2 ² ·7·17	3 ² ·53	2·239	479	47
48	2 ³ ·3·5	13·37	2·241	3·7·23	2 ² ·11 ²	5·97	2·3 ⁵	487	2 ³ ·61	3·163	48
49	2·5·7 ²	491	2 ² ·3·41	17·29	2·13·19	3 ² ·5·11	2 ⁴ ·31	7·71	2·3·83	499	49

From G. Kavan, Factor tables. Macmillan and Co., Ltd., London, England, 1937 (with permission).
*See page II.

50	$2^3 \cdot 5^3$	3-167	2-251	503	$2^3 \cdot 3^2 \cdot 7$	5-101	2-11-23	$3 \cdot 13^2$	$2^2 \cdot 127$	509	50
51	$2^3 \cdot 3 \cdot 5 \cdot 17$	7-73	2^9	3^3 \cdot 19	2-257	5-103	$2^2 \cdot 3 \cdot 43$	11-47	2-7-37	3-173	50
52	$2^3 \cdot 5 \cdot 13$	521	$2 \cdot 3^2 \cdot 29$	523	$2^2 \cdot 131$	$3 \cdot 5^2 \cdot 7$	2-263	17-31	$2^4 \cdot 3 \cdot 11$	23^2	52
53	$2 \cdot 5 \cdot 53$	$3^2 \cdot 59$	$2^2 \cdot 7 \cdot 19$	13-41	$2 \cdot 3 \cdot 89$	5-107	$2^3 \cdot 67$	3-179	2-269	$7^2 \cdot 11$	53
54	$2^2 \cdot 3^3 \cdot 5$	541	2-271	3-181	$2^2 \cdot 17$	5-109	2-3-7-13	547	$2^2 \cdot 137$	$3^2 \cdot 61$	54
55	$2 \cdot 5^2 \cdot 11$	19-29	$2^3 \cdot 3 \cdot 23$	7-79	2-277	$3 \cdot 5 \cdot 37$	$2^2 \cdot 139$	557	$2 \cdot 3^2 \cdot 31$	13-43	55
56	$2^4 \cdot 5 \cdot 7$	3-11-17	2-281	563	$2^2 \cdot 3 \cdot 47$	5-113	2-283	3-7	$2^3 \cdot 71$	569	56
57	$2 \cdot 3 \cdot 5 \cdot 19$	571	$2^2 \cdot 11 \cdot 13$	3 \cdot 191	2-7-41	$5^2 \cdot 23$	$2^2 \cdot 3^2$	577	2-17 ²	3-193	57
58	$2^2 \cdot 5 \cdot 29$	7-83	$2 \cdot 3 \cdot 97$	11-53	$2^2 \cdot 73$	$3^2 \cdot 5 \cdot 13$	2-293	587	$2^2 \cdot 3 \cdot 7^2$	19-31	58
59	$2 \cdot 5 \cdot 59$	3-197	$2^4 \cdot 37$	593	$2 \cdot 3^3 \cdot 11$	5-7-17	$2^2 \cdot 149$	3-199	2-13-23	599	59
60	$2^3 \cdot 3 \cdot 5^2$	601	2-7-43	$3^2 \cdot 67$	$2^2 \cdot 151$	5-11 ²	2-3-101	607	$2^5 \cdot 19$	3-7-29	60
61	$2 \cdot 5 \cdot 61$	13-47	$2^2 \cdot 3^2 \cdot 17$	613	2-307	3-5-41	$2^3 \cdot 7 \cdot 11$	617	2-3-103	619	61
62	$2^2 \cdot 5 \cdot 31$	$3^3 \cdot 23$	2-311	7-89	$2^4 \cdot 3 \cdot 13$	5 ⁴	2-313	3-11-19	$2^2 \cdot 157$	17-37	62
63	$2 \cdot 3^2 \cdot 5 \cdot 7$	631	$2^3 \cdot 79$	3-211	2-317	5-127	$2^2 \cdot 3 \cdot 53$	$7^2 \cdot 13$	2-11-29	$3^2 \cdot 71$	63
64	$2^2 \cdot 5$	641	2-3-107	643	$2^2 \cdot 7 \cdot 23$	3-5-43	2-17-19	647	$2^3 \cdot 3^4$	11-59	64
65	$2 \cdot 5^2 \cdot 13$	3-7-31	$2^2 \cdot 163$	653	2-3-109	5-131	$2^4 \cdot 41$	$3^2 \cdot 73$	2-7-47	659	65
66	$2^2 \cdot 3 \cdot 5 \cdot 11$	661	2-331	3-13-17	$2^2 \cdot 83$	5-7-19	$2 \cdot 3^2 \cdot 37$	23-29	$2^2 \cdot 167$	3-223	66
67	$2 \cdot 5 \cdot 67$	11-61	$2^2 \cdot 3 \cdot 7$	673	2-337	$3^2 \cdot 5^2$	$2^2 \cdot 13^2$	677	2-3-113	7-97	67
68	$2^3 \cdot 5 \cdot 17$	3-227	2-11-31	683	$2^2 \cdot 3^2 \cdot 19$	5-137	2-7 ²	3-229	$2^4 \cdot 43$	13-53	68
69	$2 \cdot 3 \cdot 5 \cdot 23$	691	$2^2 \cdot 173$	$3^2 \cdot 7 \cdot 11$	2-347	5-139	$2^3 \cdot 3 \cdot 29$	17-41	2-349	3-233	69
70	$2^2 \cdot 5^2 \cdot 7$	701	$2 \cdot 3^3 \cdot 13$	19-37	$2^5 \cdot 11$	3-5-47	2-353	7-101	$2^2 \cdot 3 \cdot 59$	709	70
71	$2 \cdot 5 \cdot 71$	$3^2 \cdot 79$	$2^2 \cdot 89$	23-31	2-3-7-17	5-11-13	$2^2 \cdot 179$	3-239	2-359	719	71
72	$2^4 \cdot 3^2 \cdot 5$	7-103	2-19 ²	3-241	$2^2 \cdot 181$	$5^2 \cdot 29$	$2 \cdot 3 \cdot 11^2$	727	$2^3 \cdot 7 \cdot 13$	3^6	72
73	$2 \cdot 5 \cdot 73$	17-43	$2^2 \cdot 3 \cdot 61$	733	2-367	$3 \cdot 5 \cdot 7^2$	$2^3 \cdot 23$	11-67	$2^3 \cdot 41$	739	73
74	$2^2 \cdot 5 \cdot 37$	3-13-19	2-7-53	743	$2^3 \cdot 3 \cdot 31$	5-149	2-373	$3^2 \cdot 83$	$2^2 \cdot 11 \cdot 17$	7-107	74
75	$2 \cdot 3 \cdot 5^3$	751	$2^4 \cdot 47$	3-251	2-13-29	5-151	$2^2 \cdot 3^2 \cdot 7$	757	2-379	3-11-23	75
76	$2^3 \cdot 5 \cdot 19$	761	2-3-127	7-109	$2^2 \cdot 191$	$3^2 \cdot 5 \cdot 17$	2-383	13-59	$2^2 \cdot 3$	769	76
77	$2 \cdot 5 \cdot 7 \cdot 11$	3-257	$2^2 \cdot 193$	773	$2 \cdot 3^2 \cdot 43$	5-31	$2^3 \cdot 97$	3-7-37	2-389	19-41	77
78	$2^2 \cdot 3 \cdot 5 \cdot 13$	11-71	2-17-23	$3^2 \cdot 29$	$2^4 \cdot 7^2$	5-157	2-3-131	787	$2^2 \cdot 197$	3-263	78
79	$2 \cdot 5 \cdot 79$	7-113	$2^3 \cdot 3^2 \cdot 11$	13-61	2-397	3-5-53	$2^2 \cdot 199$	797	2-3-7-19	17-47	79
80	$2^5 \cdot 5^2$	$3^2 \cdot 89$	2-401	11-73	$2^2 \cdot 3 \cdot 67$	5-7-23	2-13-31	3-269	$2^3 \cdot 101$	809	80
81	$2 \cdot 3^4 \cdot 5$	811	$2^2 \cdot 7 \cdot 29$	3-271	2-11-37	5-163	$2^4 \cdot 3 \cdot 17$	19-43	2-409	$3^2 \cdot 7 \cdot 13$	81
82	$2^2 \cdot 5 \cdot 41$	821	2-3-137	823	$2^3 \cdot 103$	$3 \cdot 5^2 \cdot 11$	2-7-59	827	$2^2 \cdot 3^2 \cdot 23$	829	82
83	$2 \cdot 5 \cdot 83$	3-277	$2^5 \cdot 13$	7 ² -17	2-3-139	5-167	$2^2 \cdot 11 \cdot 19$	$3^3 \cdot 31$	2-419	839	83
84	$2^3 \cdot 3 \cdot 5 \cdot 7$	29^2	2-421	3-281	$2^2 \cdot 211$	$5 \cdot 13^2$	$2 \cdot 3^2 \cdot 47$	$7 \cdot 11^2$	$2^4 \cdot 53$	3-283	84
85	$2 \cdot 5^2 \cdot 17$	23-37	$2^2 \cdot 3 \cdot 71$	853	2-7-61	$3^2 \cdot 5 \cdot 19$	$2^3 \cdot 107$	857	2-3-11-13	859	85
86	$2^2 \cdot 5 \cdot 43$	3-7-41	2-431	863	$2^5 \cdot 3^3$	5-173	2-433	3-17 ²	$2^2 \cdot 7 \cdot 31$	11-79	86
87	$2 \cdot 3 \cdot 5 \cdot 29$	13-67	$2^3 \cdot 109$	$3^2 \cdot 97$	2-19-23	5 ³ -7	$2^2 \cdot 3 \cdot 73$	877	2-439	3-293	87
88	$2^4 \cdot 5 \cdot 11$	881	$2 \cdot 3^2 \cdot 7^2$	883	$2^2 \cdot 13 \cdot 17$	3-5-59	2-443	887	$2^3 \cdot 3 \cdot 37$	7-127	88
89	$2 \cdot 5 \cdot 89$	3-11	$2^2 \cdot 223$	19-47	2-3-149	5-179	2 ⁷ -7	3-13-23	2-449	29-31	89
90	$2^2 \cdot 3^2 \cdot 5^2$	17-53	2-11-41	3-7-43	$2^3 \cdot 113$	5-181	2-3-151	907	$2^2 \cdot 227$	$3^2 \cdot 101$	90
91	$2 \cdot 5 \cdot 7 \cdot 13$	911	$2^4 \cdot 3 \cdot 19$	11-83	2-457	3-5-61	$2^2 \cdot 229$	7-131	$2 \cdot 3^3 \cdot 17$	919	91
92	$2^3 \cdot 5 \cdot 23$	3-307	2-461	13-71	$2^2 \cdot 3 \cdot 7 \cdot 11$	5 ² -37	2-463	$3^2 \cdot 103$	$2^5 \cdot 29$	929	92
93	$2 \cdot 3 \cdot 5 \cdot 31$	$7^2 \cdot 19$	$2^2 \cdot 233$	3-311	2-467	5-11-17	$2^3 \cdot 3^2 \cdot 13$	937	2-7-67	3-313	93
94	$2^2 \cdot 5 \cdot 47$	941	2-3-157	23-41	$2^4 \cdot 59$	$3^3 \cdot 5 \cdot 7$	2-11-43	947	$2^2 \cdot 3 \cdot 79$	13-73	94
95	$2 \cdot 5^2 \cdot 19$	3-317	$2^3 \cdot 7 \cdot 17$	953	$2 \cdot 3^2 \cdot 53$	5-191	$2^2 \cdot 239$	3-11-29	2-479	7-137	95
96	$2^3 \cdot 3 \cdot 5$	31^2	2-13-37	$3^2 \cdot 107$	$2^2 \cdot 241$	5-193	2-3-7-23	967	$2^3 \cdot 11^2$	3-17-19	96
97	$2 \cdot 5 \cdot 97$	971	$2^2 \cdot 3^5$	7-139	2-487	$3 \cdot 5^2 \cdot 13$	$2^4 \cdot 61$	977	2-3-163	11-89	97
98	$2^2 \cdot 5 \cdot 7^2$	$3^2 \cdot 109$	$2 \cdot 491$	983	$2^3 \cdot 3 \cdot 41$	5-197	2-17-29	3-7-47	$2^2 \cdot 13 \cdot 19$	23-43	98
99	$2 \cdot 3^2 \cdot 5 \cdot 11$	991	$2^5 \cdot 31$	3-331	2-7-71	5-199	$2^2 \cdot 3 \cdot 83$	997	2-499	$3^3 \cdot 37$	99

Table 24.7
1000

N	0	1	2	3	4	5	6	7	8	9	N
100	2 ³ .5 ³	7-11-13	2-3-167	17-59	2 ² .251	3-5-67	2-503	19-53	2 ⁴ .3 ² .7	1009	100
101	2-5-101	3-337	2 ² .11-23	1013	2-3-13 ²	5-7-29	2 ² .127	3 ² .113	2-509	1019	101
102	2 ² .3-5-17	1021	2-7-73	3-11-31	2 ¹⁰	5 ² .41	2-3 ² .19	13-79	2 ² .257	3-7 ³	102
103	2-5-103	1031	2 ² .3-43	1033	2-11-47	3 ² .5-23	2 ² .7-37	17-61	2-3-173	1039	103
104	2 ² .5-13	3-347	2-521	7-149	2 ² .3 ² .29	5-11-19	2-523	3-349	2 ² .131	1049	104
105	2-3-5 ² .7	1051	2 ² .263	3 ⁴ .13	2-17-31	5-211	2 ² .3-11	7-151	2-23 ²	3-353	105
106	2 ² .5-53	1061	2-3 ² .59	1063	2 ² .7-19	3-5-71	2-13-41	11-97	2 ² .3-89	1069	106
107	2-5-107	3 ² .7-17	2 ⁴ .67	29-37	2-3-179	5 ² .43	2 ² .269	3-359	2-7 ² .11	13-83	107
108	2 ² .3 ² .5	23-47	2-541	3-19 ²	2 ² .271	5-7-31	2-3-181	1087	2 ² .17	3 ² .11 ²	108
109	2-5-109	1091	2 ² .3-7-13	1093	2-547	3-5-73	2 ² .137	1097	2-3 ² .61	7-157	109
110	2 ² .5 ² .11	3-367	2-19-29	1103	2 ⁴ .3-23	5-13-17	2-7-79	3 ² .41	2 ² .277	1109	110
111	2-3-5-37	11-101	2 ² .139	3-7-53	2-557	5-223	2 ² .3 ² .31	1117	2-13-43	3-373	111
112	2 ² .5-7	19-59	2-3-11-17	1123	2 ² .281	3 ² .5 ³	2-563	7 ² .23	2 ² .3-47	1129	112
113	2-5-113	3-13-29	2 ² .283	11-103	2-3 ⁴ .7	5-227	2 ⁴ .71	3-379	2-569	17-67	113
114	2 ² .3-5-19	7-163	2-571	3 ² .127	2 ² .11-13	5-229	2-3-191	31-37	2 ² .7-41	3-383	114
115	2-5 ² .23	1151	2 ⁷ .3 ²	1153	2-577	3-5-7-11	2 ² .17 ²	13-89	2-3-193	19-61	115
116	2 ² .5-29	3 ² .43	2-7-83	1163	2 ² .3-97	5-233	2-11-53	3-389	2 ⁴ .73	7-167	116
117	2-3 ² .5-13	1171	2 ² .293	3-17-23	2-587	5 ² .47	2 ² .3-7 ²	11-107	2-19-31	3 ² .131	117
118	2 ² .5-59	1181	2-3-197	7-13 ²	2 ² .37	3-5-79	2-593	1187	2 ² .3 ² .11	29-41	118
119	2-5-7-17	3-397	2 ² .149	1193	2-3-199	5-239	2 ² .13-23	3 ² .7-19	2-599	11-109	119
120	2 ⁴ .3-5 ²	1201	2-601	3-401	2 ² .7-43	5-241	2-3 ² .67	17-71	2 ² .151	3-13-31	120
121	2-5-11 ²	7-173	2 ² .3-101	1213	2-607	3 ² .5	2 ² .19	1217	2-3-7-29	23-53	121
122	2 ² .5-61	3-11-37	2-13-47	1223	2 ² .3 ² .17	5 ² .7 ²	2-613	3-409	2 ² .307	1229	122
123	2-3-5-41	1231	2 ⁴ .7-11	3 ² .137	2-617	5-13-19	2 ² .3-103	1237	2-619	3-7-59	123
124	2 ² .5-31	17-73	2-3 ² .23	11-113	2 ² .311	3-5-83	2-7-89	29-43	2 ² .3-13	1249	124
125	2-5 ⁴	3 ² .139	2 ² .313	7-179	2-3-11-19	5-251	2 ² .157	3-419	2-17-37	1259	125
126	2 ² .3 ² .5-7	13-97	2-631	3-421	2 ⁴ .79	5-11-23	2-3-211	7-181	2 ² .317	3 ² .47	126
127	2-5-127	31-41	2 ² .3-53	19-67	2-7 ² .13	3-5 ² .17	2 ² .11-29	1277	2-3 ² .71	1279	127
128	2 ² .5	3-7-61	2-641	1283	2 ² .3-107	5-257	2-643	3 ² .11-13	2 ² .7-23	1289	128
129	2-3-5-43	1291	2 ² .17-19	3-431	2-647	5-7-37	2 ⁴ .3 ⁴	1297	2-11-59	3-433	129
130	2 ² .5 ² .13	1301	2-3-7-31	1303	2 ² .163	3 ² .5-29	2-653	1307	2 ² .3-109	7-11-17	130
131	2-5-131	3-19-23	2 ² .41	13-101	2-3 ² .73	5-263	2 ² .7-47	3-439	2-659	1319	131
132	2 ² .3-5-11	1321	2-661	3 ² .7 ²	2 ² .331	5 ² .53	2-3-13-17	1327	2 ⁴ .83	3-443	132
133	2-5-7-19	11 ³	2 ² .3 ² .37	31-43	2-23-29	3-5-89	2 ² .167	7-191	2-3-223	13-103	133
134	2 ² .5-67	3 ² .149	2-11-61	17-79	2 ² .3-7	5-269	2-673	3-449	2 ² .337	19-71	134
135	2-3 ² .5 ²	7-193	2 ² .13 ²	3-11-41	2-677	5-271	2 ² .3-113	23-59	2-7-97	3 ² .151	135
136	2 ⁴ .5-17	1361	2-3-227	29-47	2 ² .11-31	3-5-7-13	2-683	1367	2 ² .3 ² .19	37 ²	136
137	2-5-137	3-457	2 ² .7 ³	1373	2-3-229	5 ² .11	2 ² .43	3 ⁴ .17	2-13-53	7-197	137
138	2 ² .3-5-23	1381	2-691	3-461	2 ² .173	5-277	2-3 ² .7-11	19-73	2 ² .347	3-463	138
139	2-5-139	13-107	2 ⁴ .3-29	7-199	2-17-41	3 ² .5-31	2 ² .349	11-127	2-3-233	1399	139
140	2 ² .5 ² .7	3-467	2-701	23-61	2 ² .3 ² .13	5-281	2-19-37	3-7-67	2 ² .11	1409	140
141	2-3-5-47	17-83	2 ² .353	3 ² .157	2-7-101	5-283	2 ² .3-59	13-109	2-709	3-11-43	141
142	2 ² .5-71	7 ² .29	2-3 ² .79	1423	2 ⁴ .89	3-5 ² .19	2-23-31	1427	2 ² .3-7-17	1429	142
143	2-5-11-13	3 ² .53	2 ² .179	1433	2-3-239	5-7-41	2 ² .359	3-479	2-719	1439	143
144	2 ² .3 ² .5	11-131	2-7-103	3-13-37	2 ² .19 ²	5-17 ²	2-3-241	1447	2 ² .181	3 ² .7-23	144
145	2-5 ² .29	1451	2 ² .3-11 ²	1453	2-727	3-5-97	2 ⁴ .7-13	31-47	2-3 ²	1459	145
146	2 ² .5-73	3-487	2-17-43	7-11-19	2 ² .3-61	5-293	2-733	3 ² .163	2 ² .367	13-113	146
147	2-3-5-7 ²	1471	2 ² .23	3-491	2-11-67	5 ² .59	2 ² .3 ² .41	7-211	2-739	3-17-29	147
148	2 ² .5-37	1481	2-3-13-19	1483	2 ² .7-53	3 ² .5-11	2-743	1487	2 ⁴ .3-31	1489	148
149	2-5-149	3-7-71	2 ² .373	1493	2-3 ² .83	5-13-23	2 ² .11-17	3-499	2-7-107	1499	149

150	2 ² ·3·5 ²	19·79	2·751	3 ² ·167	2 ⁸ ·47	5·7·43	2·3·251	11·137	2 ² ·13·29	3·503	150
151	2·5·151	1511	2 ⁸ ·3 ² ·7	17·89	2·757	3·5·101	2 ² ·379	37·41	2·3·11·23	7 ² ·31	151
152	2 ⁴ ·5·19	3 ² ·13 ²	2·761	1523	2 ² ·3·127	5 ² ·61	2·7·109	3·509	2 ⁸ ·191	11·139	152
153	2·3 ² ·5·17	1531	2 ² ·383	3·7·73	2·13·59	5·307	2 ² ·3	29·53	2·769	3 ⁴ ·19	153
154	2 ² ·5·7·11	23·67	2·3·257	1543	2 ² ·193	3·5·103	2·773	7·13·17	2 ² ·3 ² ·43	1549	154
155	2·5 ² ·31	3·11·47	2 ⁴ ·97	1553	2·3·7·37	5·311	2 ² ·389	3 ² ·173	2·19·41	1559	155
156	2 ² ·3·5·13	7·223	2·11·71	3·521	2 ² ·17·23	5·313	2·3 ² ·29	1567	2 ⁵ ·7 ²	3·523	156
157	2·5·157	1571	2 ² ·3·131	11 ² ·13	2·787	3 ² ·5 ² ·7	2 ² ·197	19·83	2·3·263	1579	157
158	2 ² ·5·79	3·17·31	2·7·113	1583	2 ⁴ ·3 ² ·11	5·317	2·13·61	3·23 ²	2 ² ·397	7·227	158
159	2·3·5·53	37·43	2 ² ·199	3 ² ·59	2·797	5·11·29	2 ² ·3·7·19	1597	2·17·47	3·13·41	159
160	2 ⁶ ·5 ²	1601	2·3 ² ·89	7·229	2 ² ·401	3·5·107	2·11·73	1607	2 ² ·3·67	1609	160
161	2·5·7·23	3 ² ·179	2 ² ·13·31	1613	2·3·269	5·17·19	2 ⁴ ·101	3·7 ² ·11	2·809	1619	161
162	2 ² ·3 ⁴ ·5	1621	2·811	3·541	2 ² ·7·29	5 ² ·13	2·3·271	1627	2 ² ·11·37	3 ² ·181	162
163	2·5·163	7·233	2 ⁵ ·3·17	23·71	2·19·43	3·5·109	2 ² ·409	1637	2·3 ² ·7·13	11·149	163
164	2 ² ·5·41	3·547	2·821	31·53	2 ² ·3·137	5·7·47	2·823	3 ² ·61	2 ⁴ ·103	17·97	164
165	2·3·5 ² ·11	13·127	2 ² ·7·59	3·19·29	2·827	5·331	2 ² ·3 ² ·23	1657	2·829	3·7·79	165
166	2 ² ·5·83	11·151	2·3·277	1663	2 ² ·13	3 ² ·5·37	2·7 ² ·17	1667	2 ² ·3·139	1669	166
167	2·5·167	3·557	2 ² ·11·19	7·239	2·3 ² ·31	5 ² ·67	2 ² ·419	3·13·43	2·839	23·73	167
168	2 ⁴ ·3·5·7	41 ²	2·29 ²	3 ² ·11·17	2 ² ·421	5·337	2·3·281	7·241	2 ² ·211	3·563	168
169	2·5·13 ²	19·89	2 ² ·3 ² ·47	1693	2·7·11 ²	3·5·113	2 ⁵ ·53	1697	2·3·283	1699	169
170	2 ² ·5 ² ·17	3 ⁵ ·7	2·23·37	13·131	2 ² ·3·71	5·11·31	2·853	3·569	2 ² ·7·61	1709	170
171	2·3 ² ·5·19	29·59	2 ⁴ ·107	3·571	2·857	5·7 ²	2 ² ·3·11·13	17·101	2·859	3 ² ·191	171
172	2 ² ·5·43	1721	2·3·7·41	1723	2 ² ·431	3·5 ² ·23	2·863	11·157	2 ² ·3 ²	7·13·19	172
173	2·5·173	3·577	2 ² ·433	1733	2·3·17 ²	5·347	2 ² ·7·31	3 ² ·193	2·11·79	37·47	173
174	2 ² ·3·5·29	1741	2·13·67	3·7·83	2 ⁴ ·109	5·349	2·3 ² ·97	1747	2 ² ·19·23	3·11·53	174
175	2·5 ² ·7	17·103	2 ² ·3·73	1753	2·877	3 ² ·5·13	2 ² ·439	7·251	2·3·293	1759	175
176	2 ² ·5·11	3·587	2·881	41·43	2 ² ·3 ² ·7 ²	5·353	2·883	3·19·31	2 ² ·13·17	29·61	176
177	2·3·5·59	7·11·23	2 ² ·443	3 ² ·197	2·887	5 ² ·71	2 ² ·3·37	1777	2·7·127	3·593	177
178	2 ² ·5·89	13·137	2·3 ⁴ ·11	1783	2 ² ·223	3·5·7·17	2·19·47	1787	2 ² ·3·149	1789	178
179	2·5·179	3 ² ·199	2 ⁸ ·7	11·163	2·3·13·23	5·359	2 ² ·449	3·599	2·29·31	7·257	179
180	2 ² ·3 ² ·5 ²	1801	2·17·53	3·601	2 ² ·11·41	5·19 ²	2·3·7·43	13·139	2 ⁴ ·113	3 ² ·67	180
181	2·5·181	1811	2 ² ·3·151	7 ² ·37	2·907	3·5·11 ²	2 ² ·227	23·79	2·3 ² ·101	17·107	181
182	2 ² ·5·7·13	3·607	2·911	1823	2 ² ·3·19	5 ² ·73	2·11·83	3 ² ·7·29	2 ² ·457	31·59	182
183	2·3·5·61	1831	2 ² ·229	3·13·47	2·7·131	5·367	2 ² ·3 ² ·17	11·167	2·919	3·613	183
184	2 ⁴ ·5·23	7·263	2·3·307	19·97	2 ² ·461	3 ² ·5·41	2·13·71	1847	2 ² ·3·7·11	43 ²	184
185	2·5 ² ·37	3·617	2 ² ·463	17·109	2·3 ² ·103	5·7·53	2 ² ·29	3·619	2·929	11·13 ²	185
186	2 ² ·3·5·31	1861	2·7 ² ·19	3 ² ·23	2 ² ·233	5·373	2·3·311	1867	2 ² ·467	3·7·89	186
187	2·5·11·17	1871	2 ⁴ ·3 ² ·13	1873	2·937	3·5 ⁴	2 ² ·7·67	1877	2·3·313	1879	187
188	2 ² ·5·47	3 ² ·11·19	2·941	7·269	2 ² ·3·157	5·13·29	2·23·41	3·17·37	2 ² ·59	1889	188
189	2·3 ² ·5·7	31·61	2 ² ·11·43	3·631	2·947	5·379	2 ² ·3·79	7·271	2·13·73	3 ² ·211	189
190	2 ² ·5 ² ·19	1901	2·3·317	11·173	2 ⁴ ·7·17	3·5·127	2·953	1907	2 ² ·3 ² ·53	23·83	190
191	2·5·191	3·7 ² ·13	2 ² ·239	1913	2·3·11·29	5·383	2 ² ·479	3 ² ·71	2·7·137	19·101	191
192	2 ² ·3·5	17·113	2·31 ²	3·641	2 ² ·13·37	5 ² ·7·11	2·3 ² ·107	41·47	2 ² ·241	3·643	192
193	2·5·193	1931	2 ² ·3·7·23	1933	2·967	3 ² ·5·43	2 ² ·11 ²	13·149	2·3·17·19	7·277	193
194	2 ² ·5·97	3·647	2·971	29·67	2 ² ·3 ⁵	5·389	2·7·139	3·11·59	2 ² ·487	1949	194
195	2·3·5 ² ·13	1951	2 ⁵ ·61	3 ² ·7·31	2·977	5·17·23	2 ² ·3·163	19·103	2·11·89	3·653	195
196	2 ² ·5·7 ²	37·53	2·3 ² ·109	13·151	2 ² ·491	3·5·131	2·983	7·281	2 ⁴ ·3·41	11·179	196
197	2·5·197	3 ² ·73	2 ² ·17·29	1973	2·3·7·47	5 ² ·79	2 ² ·13·19	3·659	2·23·43	1979	197
198	2 ² ·3 ² ·5·11	7·283	2·991	3·661	2 ² ·31	5·397	2·3·331	1987	2 ² ·7·71	3 ² ·13·17	198
199	2·5·199	11·181	2 ² ·3·83	1993	2·997	3·5·7·19	2 ² ·499	1997	2·3 ² ·37	1999	199

COMBINATORIAL ANALYSIS

Factorizations

Table 24.7

1999

847

Table 24.7

2499

N	0	1	2	3	4	5	6	7	8	9	N
200	2 ⁴ ·5 ³	3·23·29	2·7·11·13	2003	2 ³ ·3·167	5·401	2·17·59	3 ² ·223	2 ³ ·251	7 ² ·41	200
201	2·3·5·67	2011	2 ⁵ ·503	3·11·61	2·19·53	5·13·31	2 ⁵ ·3 ² ·7	2017	2·1009	3·673	201
202	2 ² ·5·101	43·47	2·3·337	7·17 ²	2 ³ ·11·23	3 ⁴ ·5 ²	2·1013	2027	2 ² ·3·13 ²	2029	202
203	2·5·7·29	3·677	2 ⁴ ·127	19·107	2·3 ² ·113	5·11·37	2 ² ·509	3·7·97	2·1019	2039	203
204	2 ³ ·3·5·17	13·157	2·1021	3 ² ·227	2 ² ·7·73	5·409	2·3·11·31	23·89	2 ¹¹	3·683	204
205	2·5 ² ·41	7·293	2 ² ·3 ³ ·19	2053	2·13·79	3·5·137	2 ³ ·257	11 ² ·17	2·3·7 ³	29·71	205
206	2 ² ·5·103	3 ² ·229	2·1031	2063	2 ⁴ ·3·43	5·7·59	2·1033	3·13·53	2 ² ·11·47	2069	206
207	2·3 ² ·5·23	19·109	2 ³ ·7·37	3·691	2·17·61	5 ² ·83	2 ² ·3·173	31·67	2·1039	3 ³ ·7·11	207
208	2 ⁵ ·5·13	2081	2·3·347	2083	2 ² ·521	3·5·139	2·7·149	2087	2 ³ ·3 ² ·29	2089	208
209	2·5·11·19	3·17·41	2 ² ·523	7·13·23	2·3·349	5·419	2 ⁴ ·131	3 ² ·233	2·1049	2099	209
210	2 ² ·3·5 ² ·7	11·191	2·1051	3·701	2 ³ ·263	5·421	2·3 ⁴ ·13	7 ² ·43	2 ² ·17·31	3·19·37	210
211	2·5·211	2111	2 ³ ·3·11	2113	2·7·151	3 ² ·5·47	2 ² ·23 ²	29·73	2·3·353	13·163	211
212	2 ³ ·5·53	3·7·101	2·1061	11·193	2 ² ·3 ² ·59	5 ³ ·17	2·1063	3·709	2 ⁴ ·7·19	2129	212
213	2·3·5·71	2131	2 ² ·13·41	3 ³ ·79	2·11·97	5·7·61	2 ³ ·3·89	2137	2·1069	3·23·31	213
214	2 ² ·5·107	2141	2·3 ² ·7·17	2143	2 ⁵ ·67	3·5·11·13	2·29·37	19·113	2 ² ·3·179	7·307	214
215	2·5 ² ·43	3 ² ·239	2 ³ ·269	2153	2·3·359	5·431	2 ² ·7 ² ·11	3·719	2·13·83	17·127	215
216	2 ⁴ ·3 ³ ·5	2161	2·23·47	3·7·103	5·433	2·3·19 ²	2·3·19 ²	11·197	2 ³ ·271	3 ² ·241	216
217	2·5·7·31	13·167	2 ² ·3·181	41·53	2·1087	3·5 ² ·29	2 ⁷ ·17	7·311	2·3 ² ·11 ²	2179	217
218	2 ² ·5·109	3·727	2·1091	37·59	2 ³ ·3·7·13	5·19·23	2·1093	3 ⁷	2 ² ·547	11·199	218
219	2·3·5·73	7·313	2 ⁴ ·137	3·17·43	2·1097	5·439	2 ² ·3 ² ·61	13 ³	2·7·157	3·733	219
220	2 ³ ·5 ² ·11	31·71	2·3·367	2203	2 ² ·19·29	3 ² ·5·7 ²	2·1103	2207	2 ³ ·3·23	47 ²	220
221	2·5·13·17	3·11·67	2 ² ·7·79	2213	2·3 ³ ·41	5·443	2 ³ ·277	3·739	2·1109	7·317	221
222	2 ² ·3·5·37	2221	2·11·101	3 ³ ·13·19	2 ⁴ ·139	5 ² ·89	2·3·7·53	17·131	2 ² ·557	3·743	222
223	2·5·223	23·97	2 ³ ·3 ² ·31	7·11·29	2·1117	3·5·149	2 ² ·13·43	2237	2·3·373	2239	223
224	2 ⁶ ·5·7	3 ³ ·83	2·19·59	2243	2 ² ·3·11·17	5·449	2·1123	3·7·107	2 ³ ·281	13·173	224
225	2·3 ² ·5 ³	2251	2 ² ·563	3·751	2·7 ² ·23	5·11·41	2 ⁴ ·3·47	37·61	2·1129	3 ² ·251	225
226	2 ² ·5·113	7·17·19	2·3·13·29	31·73	2 ³ ·283	3·5·151	2·11·103	2267	2 ² ·3 ⁴ ·7	2269	226
227	2·5·227	3·757	2 ⁵ ·71	2273	2·3·379	5 ² ·7·13	2 ² ·569	3 ² ·11·23	2·17·67	43·53	227
228	2 ³ ·3·5·19	2281	2·7·163	3·761	2 ² ·571	5·457	2·3 ² ·127	2287	2 ⁴ ·11·13	3·7·109	228
229	2·5·229	29·79	2 ² ·3·191	2293	2·31·37	3 ³ ·5·17	2 ³ ·7·41	2297	2·3·383	11 ² ·19	229
230	2 ² ·5 ² ·23	3·13·59	2·1151	7 ² ·47	2 ³ ·3 ²	5·461	2·1153	3·769	2 ² ·577	2309	230
231	2·3·5·7·11	2311	2 ³ ·17 ²	3 ² ·257	2·13·89	5·463	2 ² ·3·193	7·331	2·19·61	3·773	231
232	2 ⁴ ·5·29	11·211	2·3 ³ ·43	23101	2 ² ·7·83	3·5 ² ·31	2·1163	13·179	2 ³ ·3·97	17·137	232
233	2·5·233	3 ² ·7·37	2 ² ·11·53	2333	2·3·389	5·467	2 ⁵ ·73	3·19·41	2·7·167	2339	233
234	2 ² ·3 ² ·5·13	2341	2·1171	3·11·71	2 ³ ·293	5·7·67	2·3·17·23	2347	2 ² ·587	3 ⁴ ·29	234
235	2·5 ² ·47	2351	2 ⁴ ·3·7 ²	13·181	2·11·107	3·5·157	2 ² ·19·31	2357	2·3 ² ·131	7·337	235
236	2 ³ ·5·59	3·787	2·1181	17·139	2 ² ·3·197	5·11·43	2·7·13 ²	3 ² ·263	2 ³ ·37	23·103	236
237	2·3·5·79	2371	2 ² ·593	3·7·113	2·1187	5 ³ ·19	2 ³ ·3 ² ·11	2377	2·29·41	3·13·61	237
238	2 ² ·5·7·17	2381	2·3·397	2383	2 ⁴ ·149	3 ² ·5·53	2·1193	7·11·31	2 ² ·3·199	2389	238
239	2·5·239	3·797	2 ³ ·13·23	2393	2·3 ² ·7·19	5·479	2 ² ·599	3·17·47	2·11·109	2399	239
240	2 ³ ·3·5 ²	7 ⁴	2·1201	3 ³ ·89	2 ² ·601	5·13·37	2·3·401	29·83	2 ³ ·7·43	3·11·73	240
241	2·5·241	2411	2 ² ·3 ² ·67	19·127	2·17·71	3·5·7·23	2 ⁴ ·151	2417	2·3·13·31	41·59	241
242	2 ² ·5·11 ²	3 ² ·269	2·7·173	2423	2 ³ ·3·101	5 ² ·97	2·1213	3·809	2 ² ·607	7·347	242
243	2·3 ⁵ ·5	11·13·17	2 ⁷ ·19	3·811	2·1217	5·487	2 ² ·3·7·29	2437	2·23·53	3 ² ·271	243
244	2 ³ ·5·61	2441	2·3·11·37	7·349	2 ² ·13·47	3·5·163	2·1223	2447	2 ⁴ ·3 ² ·17	31·79	244
245	2·5 ² ·7 ²	3·19·43	2 ² ·613	11·223	2·3·409	5·491	2 ³ ·307	3 ³ ·7·13	2·1229	2459	245
246	2 ² ·3·5·41	23·107	2·1231	3·821	2 ² ·7·11	5·17·29	2·3 ² ·137	2467	2 ² ·617	3·823	246
247	2·5·13·19	7·353	2 ³ ·3·103	2473	2·1237	3 ² ·5 ² ·11	2 ² ·619	2477	2·3·7·59	37·67	247
248	2 ⁴ ·5·31	3·827	2·17·73	13·191	2 ² ·3 ² ·23	5·7·71	2·11·113	3·829	2 ³ ·311	19·131	248
249	2·3·5·83	47·53	2 ² ·7·89	3 ² ·277	2·29·43	5·499	2 ³ ·3·13	11·227	2·1249	3·7 ² ·17	249

Factorizations

250	2 ² ·5 ⁴	41·61	2 ² ·3 ² ·139	2503	2 ³ ·313	3·5·167	2·7·179	23·109	2 ² ·3·11·19	13·193	250
251	2·5·251	3 ⁴ ·31	2 ⁴ ·157	7·359	2·3·419	5·503	2 ² ·17·37	3·839	2·1259	11·229	251
252	2 ³ ·3 ² ·5·7	2521	2·13·97	3·29 ²	2 ² ·631	5 ² ·101	2·3·421	7·19 ²	2 ⁵ ·79	3 ² ·281	252
253	2·5·11·23	2531	2 ² ·3·211	17·149	2·7·181	3·5·13 ²	2 ³ ·317	43·59	2·3 ² ·47	2539	253
254	2 ² ·5·127	3·7·11 ²	2·31·41	2543	2 ⁴ ·3·53	5·509	2·19·67	3 ² ·283	2 ² ·7 ² ·13	2549	254
255	2·3·5 ² ·17	2551	2 ³ ·11·29	3·23·37	2·1277	5·7·73	2 ² ·3 ² ·71	2557	2·1279	3·853	255
256	2 ² ·5	13·197	2·3·7·61	11·233	2 ² ·641	3 ³ ·5·19	2·1283	17·151	2 ³ ·3·107	7·367	256
257	2·5·257	3·857	2 ² ·643	31·83	2 ² ·3·11·13	5 ² ·103	2·7·23	3·859	2·1289	2579	257
258	2 ² ·3·5·43	29·89	2·1291	3 ² ·7·41	2 ³ ·17·19	5·11·47	2·3·431	13·199	2 ² ·647	3·863	258
259	2·5·7·37	2591	2 ⁵ ·3 ⁴	2593	2·1297	3·5·173	2 ² ·11·59	7 ² ·53	2·3·433	23·113	259
260	2 ³ ·5 ² ·13	3 ² ·17 ²	2·1301	19·137	2 ² ·3·7·31	5·521	2·1303	3·11·79	2 ⁴ ·163	2609	260
261	2 ² ·3·5·29	7·373	2 ² ·653	3·13·67	2·1307	5·523	2 ² ·3·109	2617	2·7·11·17	3 ² ·97	261
262	2 ² ·5·131	2621	2·3·19·23	43·61	2 ² ·41	3·5 ² ·7	2·13·101	37·71	2 ² ·3 ² ·73	11·239	262
263	2·5·263	3·877	2 ³ ·7·47	2633	2·3·439	5·17·31	2 ² ·659	3 ² ·293	2·1319	7·13·29	263
264	2 ⁴ ·3·5·11	19·139	2·1321	3·881	2 ² ·661	5·23 ²	2·3 ² ·7 ²	2647	2 ³ ·331	3·883	264
265	2·5 ² ·53	11·241	2 ² ·3·13·17	7·379	2·1327	3 ² ·5·59	2 ⁵ ·83	2657	2·3·443	2659	265
266	2 ² ·5·7·19	3·887	2·11 ³	2663	2 ³ ·3 ² ·37	5·13·41	2·31·43	3·7·127	2 ² ·23·29	17·157	266
267	2·3·5·89	2671	2 ⁴ ·167	3 ² ·11	2·7·191	5 ² ·107	2 ² ·3·223	2677	2·13·103	3·19·47	267
268	2 ³ ·5·67	7·383	2·3 ² ·149	2683	2 ² ·11·61	3·5·179	2·17·79	2687	2 ² ·3·7	2689	268
269	2·5·269	3 ² ·13·23	2 ² ·673	2693	2·3·449	5·7 ² ·11	2 ³ ·337	3·29·31	2·19·71	2699	269
270	2 ² ·3 ³ ·5 ²	37·73	2·7·193	3·17·53	2 ⁴ ·13 ²	5·541	2·3·11·41	2707	2 ² ·677	3 ² ·7·43	270
271	2·5·271	2711	2 ³ ·3·113	2713	2·23·59	3·5·181	2 ² ·7·97	11·13·19	2·3 ² ·151	2719	271
272	2 ² ·5·17	3·907	2·1361	7·389	2 ² ·3·227	5 ² ·109	2·29·47	3 ² ·101	2 ³ ·11·31	2729	272
273	2·3·5·7·13	2731	2 ² ·683	3·911	2·1367	5·547	2 ⁴ ·3 ² ·19	7·17·23	2·37 ²	3·11·83	273
274	2 ² ·5·137	2741	2·3·457	13·211	2 ³ ·7 ²	3 ² ·5·61	2·1373	41·67	2 ² ·3·229	2749	274
275	2·5 ² ·11	3·7·131	2 ⁶ ·43	2753	2·3 ⁴ ·17	5·19·29	2 ² ·13·53	3·919	2·7·197	31·89	275
276	2 ³ ·3·5·23	11·251	2·1381	3 ² ·307	2 ² ·691	5·7·79	2·3·461	2767	2 ⁴ ·173	3·13·71	276
277	2·5·277	17·163	2 ² ·3 ² ·7·11	47·59	2·19·73	3·5 ² ·37	2 ² ·3·47	2777	2·3·463	7·397	277
278	2 ² ·5·139	3 ³ ·103	2·13·107	11 ² ·23	2 ⁵ ·3·29	5·557	2·7·199	3·929	2 ² ·17·41	2789	278
279	2·3 ² ·5·31	2791	2 ² ·349	3·7 ² ·19	2·11·127	5·13·43	2 ² ·3·233	2797	2·1399	3 ² ·311	279
280	2 ⁴ ·5 ² ·7	2801	2·3·467	2803	2 ² ·701	3·5·11·17	2·23·61	7·401	2 ³ ·3 ² ·13	53 ²	280
281	2·5·281	3·937	2 ² ·19·37	29·97	2·3·7·67	5·563	2 ² ·11	3 ² ·313	2·1409	2819	281
282	2 ² ·3·5·47	7·13·31	2·17·83	3·941	2 ² ·353	5 ² ·113	2·3 ² ·157	11·257	2 ² ·7·101	3·23·41	282
283	2·5·283	19·149	2 ⁴ ·3·59	2833	2·13·109	3 ⁴ ·5·7	2 ² ·709	2837	2·3·11·43	17·167	283
284	2 ³ ·5·71	3·947	2·7 ² ·29	2843	2 ² ·3 ² ·79	5·569	2·1423	3·13·73	2 ⁵ ·89	7·11·37	284
285	2·3·5 ² ·19	2851	2 ² ·23·31	3 ² ·317	2·1427	5·571	2 ² ·3·7·17	2857	2·1429	3·953	285
286	2 ² ·5·11·13	2861	2·3 ² ·53	7·409	2 ⁴ ·179	3·5·191	2·1433	47·61	2 ² ·3·239	19·151	286
287	2·5·7·41	3 ² ·11·29	2 ³ ·359	13 ² ·17	2·3·479	5 ² ·23	2 ² ·719	3·7·137	2·1439	2879	287
288	2 ⁴ ·3 ² ·5	43·67	2·11·131	3·31 ²	2 ² ·7·103	5·577	2·3·13·37	2887	2 ³ ·19 ²	3 ² ·107	288
289	2·5·17 ²	7 ² ·59	2 ² ·3·241	11·263	2·1447	3·5·193	2 ⁴ ·181	2897	2·3 ² ·7·23	13·223	289
290	2 ² ·5 ² ·29	3·967	2·1451	2903	2 ³ ·3·11 ²	5·7·83	2·1453	3 ² ·17·19	2 ² ·727	2909	290
291	2·3·5·97	41·71	2 ² ·7·13	3·971	2·31·47	5·11·53	2 ² ·3 ²	2917	2·1459	3·7·139	291
292	2 ³ ·5·73	23·127	2·3·487	37·79	2 ² ·17·43	3 ² ·5 ² ·13	2·7·11·19	2927	2 ⁴ ·3·61	29·101	292
293	2·5·293	3·977	2 ² ·733	7·419	2·3 ² ·163	5·587	2 ³ ·367	3·11·89	2·13·113	2939	293
294	2 ² ·3·5·7 ²	17·173	2·1471	3 ² ·109	2 ² ·23	5·19·31	2·3·491	7·421	2 ² ·11·67	3·983	294
295	2·5 ² ·59	13·227	2 ³ ·3 ² ·41	2953	2·7·211	3·5·197	2 ² ·739	2957	2·3·17·29	11·269	295
296	2 ⁴ ·5·37	3 ² ·7·47	2·1481	2963	2 ² ·3·13·19	5·593	2·1483	3·23·43	2 ³ ·7·53	2969	296
297	2·3 ² ·5·11	2971	2 ² ·743	3·991	2·1487	5 ² ·7·17	2 ⁵ ·3·31	13·229	2·1489	3 ² ·331	297
298	2 ² ·5·149	11·271	2·3·7·71	19·157	2 ² ·373	3·5·199	2·1493	29·103	2 ² ·3 ² ·83	7 ² ·61	298
299	2·5·13·23	3·997	2 ⁴ ·11·17	41·73	2·3·499	5·599	2 ² ·7·107	3 ⁴ ·37	2·1499	2999	299

2500

COMBINATORIAL ANALYSIS
FactorizationsTable 24.7
2999

849

Table 24.7
3000

Factorizations

3499

N	0	1	2	3	4	5	6	7	8	9	N
300	2 ³ .5 ³	3001	2-19-79	3-7-11-13	2 ² .751	5-601	2-3 ² .167	31-97	2 ⁴ .47	3-17-59	300
301	2-5-7-43	3011	2 ² .3-251	23-131	2-11-137	3 ² .5-67	2 ³ .13-29	7-431	2-3-503	3019	301
302	2 ² .5-151	3-19-53	2-1511	3023	2 ⁴ .3 ² .7	5 ² .11 ²	2-17-89	3-1009	2 ² .757	13-233	302
303	2-3-5-101	7-433	2 ² .379	3 ² .337	2-37-41	5-607	2 ² .3-11-23	3037	2-7 ² .31	3-1013	303
304	2 ² .5-19	3041	2-3 ² .13 ²	17-179	2 ² .761	3-5-7-29	2-1523	11-277	2 ² .3-127	3049	304
305	2-5 ² .61	3 ³ .113	2 ² .7-109	43-71	2-3-509	5-13-47	2 ⁴ .191	3-1019	2-11-139	7-19-23	305
306	2 ² .3 ² .5-17	3061	2-1531	3-1021	2 ² .383	5-613	2-3-7-73	3067	2 ² .13-59	3 ² .11-31	306
307	2-5-307	37-83	2 ¹⁰ .3	7-439	2-29-53	3-5 ² .41	2 ² .769	17-181	2-3 ² .19	3079	307
308	2 ² .5-7-11	3-13-79	2-23-67	3083	2 ² .3-257	5-617	2-1543	3 ² .7 ²	2 ⁴ .193	3089	308
309	2-3-5-103	11-281	2 ² .773	3-1031	2-7-13-17	5-619	2 ² .3 ² .43	19-163	2-1549	3-1033	309
310	2 ² .5 ² .31	7-443	2-3-11-47	29-107	2 ² .97	3 ² .5-23	2-1553	13-239	2 ² .3-7-37	3109	310
311	2-5-311	3-17-61	2 ² .389	11-283	2-3 ² .173	5-7-89	2 ² .19-41	3-1039	2-1559	3119	311
312	2 ⁴ .3-5-13	3121	2-7-223	3 ² .347	2-7-11-71	5 ⁵	2-3-521	53-59	2 ² .17-23	3-7-149	312
313	2-5-313	31-101	2 ² .3 ² .29	13-241	2-1567	3-5-11-19	2 ² .7 ²	3137	2-3-523	43-73	313
314	2 ² .5-157	3 ² .349	2-1571	7-449	2 ² .3-131	5-17-37	2-11 ² .13	3-1049	2 ² .787	47-67	314
315	2-3 ² .5 ² .7	23-137	2 ⁴ .197	3-1051	2-19-83	5-631	2 ² .3-263	7-11-41	2-1579	3 ² .13	315
316	2 ² .5-7-9	29-109	2-3-17-31	3163	2 ² .7-113	3-5-211	2-1583	3167	2 ² .3 ² .11	3169	316
317	2-5-317	3-7-151	2 ² .13-61	19-167	2-3-23 ²	5 ² .127	2 ² .397	3 ² .353	2-7-227	11-17 ²	317
318	2 ² .3-5-53	3181	2-37-43	3-1061	2 ⁴ .199	5-7-13	2-3 ² .59	3187	2 ² .797	3-1063	318
319	2-5-11-29	3191	2 ² .3-7-19	31-103	2-1597	3 ² .5-71	2 ² .17-47	23-139	2-3-13-41	7-457	319
320	2 ⁷ .5 ²	3-11-97	2-1601	3203	2 ² .3 ² .89	5-641	2-7-229	3-1069	2 ² .401	3209	320
321	2-3-5-107	13 ² .19	2 ² .11-73	3 ² .7-17	2-1607	5-643	2-3-67	3217	2-1609	3-29-37	321
322	2 ² .5-7-23	3221	2-3 ² .179	11-293	2-13-31	3-5 ² .43	2-1613	7-461	2 ² .3-269	3229	322
323	2-5-17-19	3 ² .359	2 ² .101	53-61	2-3-7 ² .11	5-647	2 ² .809	3-13-83	2-1619	41-79	323
324	2 ² .3 ² .5	7-463	2-1621	3-23-47	2 ² .811	5-11-59	2-3-541	17-191	2 ⁴ .7-29	3 ² .19 ²	324
325	2-5 ² .13	3251	2 ² .3-271	3253	2-1627	3-5-7-31	2 ² .11-37	3257	2-3 ² .181	3259	325
326	2 ² .5-163	3-1087	2-7-233	13-251	2 ² .3-17	5-653	2-23-71	3 ² .11 ²	2 ² .19-43	7-467	326
327	2-3-5-109	3271	2 ² .409	3-1091	2-1637	5 ² .131	2 ² .3 ² .7-13	29-113	2-11-149	3-1093	327
328	2 ² .5-41	17-193	2-3-547	7 ² .67	2 ² .821	3 ² .5-73	2-31-53	19-173	2 ² .3-137	11-13-23	328
329	2-5-7-47	3-1097	2 ² .823	37-89	2-3 ² .61	5-659	2 ² .103	3-7-157	2-17-97	3299	329
330	2 ² .3-5 ² .11	3301	2-13-127	3 ² .367	2 ² .7-59	5-661	2-3-19-29	3307	2 ² .827	3-1103	330
331	2-5-331	7-11-43	2 ⁴ .3 ² .23	3313	2-1657	3-5-13-17	2 ² .829	31-107	2-3-7-79	3319	331
332	2 ² .5-83	3 ⁴ .41	2-11-151	3323	2 ² .3-277	5 ² .7-19	2-1663	3-1109	2 ² .13	3329	332
333	2-3 ² .5-37	3331	2 ² .7 ² .17	3-11-101	2-1667	5-23-29	2 ² .3-139	47-71	2-1669	3 ² .7-53	333
334	2 ² .5-167	13-257	2-3-557	3343	2 ² .11-19	3-5-223	2-7-239	3347	2 ² .3 ² .31	17-197	334
335	2-5 ² .67	3-1117	2 ² .419	7-479	2-3-13-43	5-11-61	2 ² .839	3 ² .373	2-23-73	3359	335
336	2 ² .3-5-7	3361	2-41 ²	3-19-59	2 ² .29 ²	5-673	2-3 ² .11-17	7-13-37	2 ² .421	3-1123	336
337	2-5-337	3371	2 ² .3-281	3373	2-7-241	3 ² .5 ²	2 ⁴ .211	11-307	2-3-563	31-109	337
338	2 ² .5-13 ²	3-7 ² .23	2-19-89	17-199	2 ² .3 ² .47	5-677	2-1693	3-1129	2 ² .7-11 ²	3389	338
339	2-3-5-113	3391	2 ² .53	3 ² .13-29	2-1697	5-7-97	2 ² .3-283	43-79	2-1699	3-11-103	339
340	2 ² .5 ² .17	19-179	2-3 ² .7	41-83	2 ² .23-37	3-5-227	2-13-131	3407	2 ⁴ .3-71	7-487	340
341	2-5-11-31	3 ² .379	2 ² .853	3413	2-3-569	5-683	2-3-7-61	3-17-67	2-1709	13-263	341
342	2 ² .3 ² .5-19	11-311	2-29-59	3-7-163	2 ² .107	5 ² .137	2-3-5-19	23-149	2 ² .857	3 ² .127	342
343	2-5-7 ²	47-73	2 ² .3-11-13	3433	2-17-101	3-5-229	2 ² .859	7-491	2-3 ² .191	19-181	343
344	2 ² .5-43	3-31-37	2-1721	11-313	2 ² .3-7-41	5-13-53	2-1723	3 ² .383	2 ² .431	3449	344
345	2-3-5 ² .23	7-17-29	2 ² .863	3-1151	2-11-157	5-691	2 ² .7 ³	3457	2-7-13-19	3-1153	345
346	2 ² .5-173	3461	2-3-577	3463	2 ² .433	3 ² .5-7-11	2-1733	3467	2 ² .3-17 ²	3469	346
347	2-5-347	3-13-89	2 ⁴ .7-31	23-151	2-3 ² .193	5 ² .139	2 ² .11-79	3-19-61	2-37-47	7 ² .71	347
348	2 ² .3-5-29	59 ²	2-1741	3 ⁴ .43	2 ² .13-67	5-17-41	2-3-7-83	11-317	2 ² .109	3-1163	348
349	2-5-349	3491	2 ² .3 ² .97	7-499	2-1747	3-5-233	2 ² .19-23	13-269	2-3-11-53	3499	349

350	2 ² .5 ⁴ .7	3 ² .389	2.17.103	31.113	2 ⁴ .3.73	5.701	2.1753	3.7.167	2 ² .877	11 ² .29	350
351	2.3 ⁴ .5.13	3511	2 ² .439	3.1171	2.7.251	5.19.37	2 ² .3.293	3517	2.1759	3 ² .17.23	351
352	2 ² .5.11	7.503	2.3.587	13.271	2 ² .881	3.5 ² .47	2.41.43	3527	2 ³ .3 ² .7 ²	3529	352
353	2.5.353	3.11.107	2 ² .883	3533	2.3.19.31	5.7.101	2 ⁴ .13.17	3 ² .131	2.29.61	3539	353
354	2 ² .3.5.59	3541	2.7.11.23	3.1181	2 ² .443	5.709	2.3 ² .197	3547	2 ² .887	3.7.13 ²	354
355	2.5 ² .71	53.67	2 ⁵ .3.37	11.17.19	2.1777	3 ² .5.79	2 ² .7.127	3557	2.3.593	3559	355
356	2 ² .5.89	3.1187	2.13.137	7.509	2 ² .3 ⁴ .11	5.23.31	2.1783	3.29.41	2 ⁴ .223	43.83	356
357	2.3.5.7.17	3571	2.19.47	3 ² .397	2.1787	5 ² .11.13	2 ² .3.149	7 ² .73	2.1789	3.1193	357
358	2 ² .5.179	3581	2.3 ² .199	3583	2 ² .7	3.5.239	2.11.163	17.211	2 ² .3.13.23	37.97	358
359	2.5.359	3 ² .7.19	2 ² .449	3593	2.3.599	5.719	2 ² .29.31	3.11.109	2.7.257	59.61	359
360	2 ⁴ .3 ² .5 ²	13.277	2.1801	3.1201	2 ² .17.53	5.7.103	2.3.601	3607	2 ² .11.41	8 ² .401	360
361	2.5.19 ²	23.157	2 ² .3.7.43	3613	2.13.139	3.5.241	2 ² .113	3617	2.3 ² .67	7.11.47	361
362	2 ² .5.181	3.17.71	2.1811	3623	2 ² .3.151	5 ² .29	2.7 ² .37	3 ² .13.31	2 ² .907	19.191	362
363	2.3.5.11 ²	3631	2 ⁴ .227	3.7.173	2.23.79	5.727	2 ² .3 ² .101	3637	2.17.107	3.1213	363
364	2 ² .5.7.13	11.331	2.3.607	3643	2 ² .911	3 ² .5	2.1823	7.521	2 ² .3.19	41.89	364
365	2.5 ² .73	3.1217	2 ² .11.83	13.281	2.3 ² .7.29	5.17.43	2 ² .457	3.23.53	2.31.59	3659	365
366	2 ² .3.5.61	7.523	2.1831	3 ² .11.37	2 ⁴ .229	5.733	2.3.13.47	19.193	2 ² .7.131	3.1223	366
367	2.5.367	3671	2 ² .3 ² .17	3673	2.11.167	3.5 ² .7 ²	2 ² .919	3677	2.3.613	13.283	367
368	2 ² .5.23	3 ² .409	2.7.263	29.127	2 ² .3.307	5.11.67	2.19.97	3.1229	2 ² .461	7.17.31	368
369	2.3 ² .5.41	3691	2 ² .13.71	3.1231	2.1847	5.739	2 ² .3.7.11	3697	2.43 ²	3 ² .137	369
370	2 ² .5 ² .37	3701	2.3.617	7.23 ²	2 ² .463	3.5.13.19	2.17.109	11.337	2 ² .3 ² .103	3709	370
371	2.5.7.53	3.1237	2 ² .29	47.79	2.3.619	5.743	2 ² .929	3 ² .7.59	2.11.13 ²	3719	371
372	2 ² .3.5.31	61 ²	2.1861	3.17.73	2 ² .7 ² .19	5 ² .149	2.3 ² .23	3727	2 ⁴ .233	3.11.113	372
373	2.5.373	7.13.41	2 ² .3.311	3733	2.1867	3 ² .5.83	2 ² .467	37.101	2.3.7.89	3739	373
374	2 ² .5.11.17	3.29.43	2.1871	19.197	2 ² .3 ² .13	5.7.107	2.1873	3.1249	2 ² .937	23.163	374
375	2.3.5 ⁴	11 ² .31	2 ² .7.67	3 ² .139	2.1877	5.751	2 ² .3.313	13.17 ²	2.1879	3.7.179	375
376	2 ⁴ .5.47	3761	2.3 ² .11.19	53.71	2 ² .941	3.5.251	2.7.269	3767	2 ² .3.157	3769	376
377	2.5.13.29	3 ² .419	2 ² .23.41	7 ² .11	2.3.17.37	5 ² .151	2 ² .59	3.1259	2.1889	3779	377
378	2 ² .3 ² .5.7	19.199	2.31.61	3.13.97	2 ² .11.43	5.757	2.3.631	7.541	2 ² .947	3 ² .421	378
379	2.5.379	17.223	2 ⁴ .3.79	3793	2.7.271	3.5.11.23	2 ² .13.73	3797	2.3 ² .211	29.131	379
380	2 ² .5 ² .19	3.7.181	2.1901	3803	2 ² .3.317	5.761	2.11.173	3 ⁴ .47	2 ² .7.17	13.293	380
381	2.3.5.127	37.103	2 ² .953	3.31.41	2.1907	5.7.109	2 ² .3 ² .53	11.347	2.23.83	3.19.67	381
382	2 ² .5.191	3821	2.3.7 ² .13	3823	2 ⁴ .239	3 ² .5 ² .17	2.1913	43.89	2 ² .3.11.29	7.547	382
383	2.5.383	3.1277	2 ² .479	3833	2.3 ² .71	5.13.59	2 ² .7.137	3.1279	2.19.101	11.349	383
384	2 ² .3.5	23.167	2.17.113	3 ² .7.61	2 ² .31 ²	5.769	2.3.641	3847	2 ² .13.37	3.1283	384
385	2.5 ² .7.11	3851	2 ² .3 ² .107	3853	2.41.47	3.5.257	2 ⁴ .241	7.19.29	2.3.643	17.227	385
386	2 ² .5.193	3 ² .11.13	2.1931	3863	2 ² .3.7.23	5.773	2.1933	3.1289	2 ² .967	53.73	386
387	2.3 ² .5.43	7 ² .79	2 ² .11 ²	3.1291	2.13.149	5 ² .31	2 ² .3.17.19	3877	2.7.277	3 ² .431	387
388	2 ² .5.97	3881	2.3.647	11.353	2 ² .971	3.5.7.37	2.29.67	13 ² .23	2 ⁴ .3 ²	3889	388
389	2.5.389	3.1297	2 ² .7.139	17.229	2.3.11.59	5.19.41	2 ² .487	3 ² .433	2.1949	7.557	389
390	2 ² .3.5 ² .13	47.83	2.1951	3.1301	2 ² .61	5.11.71	2.3 ² .7.31	3907	2 ² .977	3.1303	390
391	2.5.17.23	3911	2 ² .3.163	7.13.43	2.19.103	3 ² .5.29	2 ² .11.89	3917	2.3.653	3919	391
392	2 ² .5.7 ²	3.1307	2.37.53	3923	2 ² .3 ² .109	5 ² .157	2.13.151	3.7.11.17	2 ² .491	3929	392
393	2.3.5.131	3931	2 ² .983	3 ² .19.23	2.7.281	5.787	2 ² .3.41	31.127	2.11.179	3.13.101	393
394	2 ² .5.197	7.563	2.3 ² .73	3943	2 ² .17.29	3.5.263	2.1973	3947	2 ² .3.7.47	11.359	394
395	2.5 ² .79	3 ² .439	2 ⁴ .13.19	59.67	2.3.659	5.7.113	2 ² .23.43	3.1319	2.1979	37.107	395
396	2 ² .3 ² .5.11	17.233	2.7.283	3.1321	2 ² .991	5.13.61	2.3.661	3967	2 ² .31	3 ⁴ .7 ²	396
397	2.5.397	11.19 ²	2 ² .3.331	29.137	2.1987	3.5 ² .53	2 ² .7.71	41.97	2.3 ² .13.17	23.173	397
398	2 ² .5.199	3.1327	2.11.181	7.569	2 ² .3.83	5.797	2.1993	3 ² .443	2 ² .997	3989	398
399	2.3.5.7.19	13.307	2 ² .499	3.11 ²	2.1997	5.17.47	2 ² .3 ² .37	7.571	2.1999	3.31.43	399

3500

COMBINATORIAL ANALYSIS
FactorizationsTable 24.7
3999

851

Table 24.7
4000

N	0	1	2	3	4	5	6	7	8	9	N
400	2 ⁵ .5 ²	4001	2-3-23-29	4003	2 ² .7-11-13	3 ² .5-89	2-2003	4007	2 ³ .3-167	19-211	400
401	2-5-401	3-7-191	2-17-59	4013	2-3 ² .223	5-11-73	2 ² .251	3-13-103	2-7-41	4019	401
402	2 ² .3-5-67	4021	2-2011	3 ³ .149	2 ³ .503	5 ² .7-23	2-3-11-61	4027	2 ² .19-53	3-17-79	402
403	2-5-13-31	29-139	2 ⁶ .3 ² .7	37-109	2-2017	3-5-269	2 ² .1009	11-367	2-3-673	7-577	403
404	2 ² .5-101	3 ² .449	2-43-47	13-311	2 ² .3-337	5-809	2-7-17 ²	3-19-71	2 ⁴ .11-23	4049	404
405	2-3 ⁴ .5 ²	4051	2 ² .1013	3-7-193	2-2027	5-811	2 ³ .3-13 ²	4057	2-2029	3 ² .11-41	405
406	2 ² .5-7-29	31-131	2-3-677	17-239	2 ⁵ .127	3-5-271	2-19-107	7 ² .83	2 ² .3 ² .113	13-313	406
407	2-5-11-37	3-23-59	2 ³ .509	4073	2-3-7-97	5 ² .163	2 ² .1019	3 ³ .151	2-2039	4079	407
408	2 ⁴ .3-5-17	7-11-53	2-13-157	3-1361	2 ² .1021	5-19-43	2-3 ² .227	61-67	2 ³ .7-73	3-29-47	408
409	2-5-409	4091	2 ² .3-11-31	4093	2-23-89	3 ² .5-7-13	2 ¹²	17-241	2-3-683	4099	409
410	2 ² .5 ² .41	3-1367	2-7-293	11-373	2 ³ .3 ³ .19	5-821	2-2053	3-37 ²	2 ² .13-79	7-587	410
411	2-3-5-137	4111	2 ⁴ .257	3 ² .457	2-11 ² .17	5-823	2 ² .3-7 ³	23-179	2-29-71	3-1373	411
412	2 ² .5-103	13-317	2-3 ² .229	7-19-31	2 ² .1031	3-5 ³ .11	2-2063	4127	2 ² .3-43	4129	412
413	2-5-7-59	3 ⁵ .17	2 ² .1033	4133	2-3-13-53	5-827	2 ³ .11-47	3-7-197	2-2069	4139	413
414	2 ² .3 ² .5-23	41-101	2-19-109	3-1381	2 ⁴ .7-37	5-829	2-3-691	11-13-29	2 ² .17-61	3 ² .461	414
415	2-5 ² .83	7-593	2 ³ .3-173	4153	2-31-67	3-5-277	2 ² .1039	4157	2-3 ³ .7-11	4159	415
416	2 ⁶ .5-13	3-19-73	2-2081	23-181	2 ² .3-347	5-7 ² .17	2-2083	3 ² .463	2 ³ .521	11-379	416
417	2-3-5-139	43-97	2 ² .7-149	3-13-107	2-2087	5 ² .167	2 ⁴ .3 ² .29	4177	2-2089	3-7-199	417
418	2 ² .5-11-19	37-113	2-3-17-41	47-89	2 ² .523	3 ³ .5-31	2-7-13-23	53-79	2 ² .3-349	59-71	418
419	2-5-419	3-11-127	2 ⁵ .131	7-599	2-3 ² .233	5-839	2 ² .1049	3-1399	2-2099	13-17-19	419
420	2 ³ .3-5 ² .7	4201	2-11-191	3 ² .467	2 ² .1051	5-29 ²	2-3-701	7-601	2 ⁴ .263	3-23-61	420
421	2-5-421	4211	2 ² .3 ⁴ .13	11-383	2-7 ² .43	3-5-281	2 ³ .17-31	4217	2-3-19-37	4219	421
422	2 ² .5-211	3 ² .7-67	2-2111	41-103	2 ² .3-11	5 ² .13 ²	2-2113	3-1409	2 ² .7-151	4229	422
423	2-3 ² .5-47	4231	2 ³ .23 ²	3-17-83	2-29-73	5-7-11 ²	2 ² .3-353	19-223	2-13-163	3 ³ .157	423
424	2 ⁴ .5-53	4241	2-3-7-101	4243	2 ² .1061	3-5-283	2-11-193	31-137	2 ³ .3 ² .59	7-607	424
425	2-5 ³ .17	3-13-109	2 ² .1063	4253	2-3-709	5-23-37	2 ⁵ .7-19	3 ² .11-43	2-2129	4259	425
426	2 ² .3-5-71	4261	2-2131	3-7 ² .29	2 ³ .13-41	5-853	2-3 ² .79	17-251	2 ² .11-97	3-1423	426
427	2-5-7-61	4271	2 ⁴ .3-89	4273	2-2137	3 ² .5 ² .19	2 ² .1069	7-13-47	2-3-23-31	11-389	427
428	2 ³ .5-107	3-1427	2-2141	4283	2 ² .3 ² .7-17	5-857	2-2143	3-1429	2 ⁶ .67	4289	428
429	2-3-5-11-13	7-613	2 ² .29-37	3 ⁴ .53	2-19-113	5-859	2 ³ .3-179	4297	2-7-307	3-1433	429
430	2 ² .5 ² .43	11-17-23	2-3 ² .239	13-331	2 ⁴ .269	3-5-7-41	2-2153	59-73	2 ² .3-359	31-139	430
431	2-5-431	3 ² .479	2 ³ .7 ² .11	19-227	2-3-719	5-863	2 ² .13-83	3-1439	2-17-127	7-617	431
432	2 ⁵ .3 ³ .5	29-149	2-2161	3-11-131	2 ² .23-47	5 ² .173	2-3-7-103	4327	2 ³ .541	3 ² .13-37	432
433	2-5-433	61-71	2 ² .3-19 ²	7-619	2-11-197	3-5-17 ²	2 ⁴ .271	4337	2-3 ² .241	4339	433
434	2 ² .5-7-31	3-1447	2-13-167	43-101	2 ³ .3-181	5-11-79	2-41-53	3 ² .7-23	2 ² .1087	4349	434
435	2-3-5 ² .29	19-229	2 ⁸ .17	3-1451	2-7-311	5-13-67	2 ² .3 ² .11 ²	4357	2-2179	3-1453	435
436	2 ² .5-109	7 ² .89	2-3-727	4363	2 ² .1091	3 ² .5-97	2-37-59	11-397	2 ⁴ .3-7-13	17-257	436
437	2-5-19-23	3-31-47	2-1093	4373	2-3 ²	5 ⁴ .	2 ³ .547	3-1459	2-11-199	29-151	437
438	2 ² .3-5-73	13-337	2-7-313	3 ² .487	2 ² .137	5-877	2-3-17-43	41-107	2 ² .1097	3-7-11-19	438
439	2-5-439	4391	2 ² .3 ² .61	23-191	2-13 ³	3-5-293	2 ² .7-157	4397	2-3-733	53-83	439
440	2 ⁴ .5 ² .11	3 ³ .163	2-31-71	7-17-37	2 ² .3-367	5-881	2-2203	3-13-113	2 ³ .19-29	4409	440
441	2-3 ² .5-7 ²	11-401	2 ² .1103	3-1471	2-2207	5-883	2 ³ .3-23	7-631	2-47 ²	3 ² .491	441
442	2 ² .5-13-17	4421	2-3-11-67	4423	2 ³ .7-79	3-5 ² .59	2-2213	19-233	2 ² .3 ² .41	43-103	442
443	2-5-443	3-7-211	2 ⁴ .277	11-13-31	2-3-739	5-887	2 ² .1109	3 ² .17-29	2-7-317	23-193	443
444	2 ³ .3-5-37	4441	2-2221	3-1481	2 ² .11-101	5-7-127	2-3 ² .13-19	4447	2 ⁵ .139	3-1483	444
445	2-5 ² .89	4451	2 ² .3-7-53	61-73	2-17-131	3 ⁴ .5-11	2 ³ .557	4457	2-3-743	7 ³ .13	445
446	2 ² .5-223	3-1487	2-23-97	4463	2 ⁴ .3 ² .31	5-19-47	2-7-11-29	3-1489	2 ² .1117	41-109	446
447	2-3-5-149	17-263	2 ² .13-43	3 ² .7-71	2-2237	5 ² .179	2 ² .3-373	11 ² .37	2-2239	3-1493	447
448	2 ² .5-7	4481	2-3 ³ .83	4483	2 ² .19-59	3-5-13-23	2-2243	7-641	2 ³ .3-11-17	67 ²	448
449	2-5-449	3 ² .499	2 ² .1123	4493	2-3-7-107	5-29-31	2 ⁴ .281	3-1499	2-13-173	11-409	449

450	2 ³ .3 ² .5 ⁸	7-643	2-2251	3-19-79	2 ³ .563	5-17-53	2-3-751	4507	2 ² .7 ² .23	3 ³ .167	450
451	2-5-11-41	13-347	2 ⁵ .3-47	4513	2-37-61	3-5-7-43	2 ² .1129	4517	2-3 ² .251	4519	451
452	2 ³ .5-113	3-11-137	2-7-17-19	4523	2 ² .3-13-29	5 ² .181	2-31-73	3 ² .503	2 ⁴ .283	7-647	452
453	2-3-5-151	23-197	2 ² .11-103	3-1511	2-2267	5-907	2 ³ .3-7	13-349	2-2269	3-17-89	453
454	2 ² .5-227	19-239	2-3-757	7-11-59	2 ² .71	3 ² .5-101	2-2273	4547	2 ² .3-379	4549	454
455	2-5 ² .7-13	3-37-41	2 ³ .569	29-157	2-3 ² .11-23	5-911	2 ² .17-67	3-7 ² .31	2-43-53	47-97	455
456	2 ⁴ .3-5-19	4561	2-2281	3 ³ .13 ²	2 ² .7-163	5-11-83	2-3-761	4567	2 ³ .571	3-1523	456
457	2-5-457	7-653	2 ² .3 ² .127	17-269	2-2287	3-5 ² .61	2 ² .11-13	23-199	2-3-7-109	19-241	457
458	2 ² .5-229	3 ² .509	2-29-79	4583	2 ³ .3-191	5-7-131	2-2293	3-11-139	2 ² .31-37	13-353	458
459	2-3 ² .5-17	4591	2 ⁴ .7-41	3-1531	2-2297	5-919	2 ² .3-383	4597	2-11 ² .19	3 ² .7-73	459
460	2 ³ .5 ² .23	43-107	2-3-13-59	4603	2 ² .1151	3-5-307	2-7 ² .47	17-271	2 ² .3 ²	11-419	460
461	2-5-461	3-29-53	2 ² .1153	7-659	2-3-769	5-13-71	2 ² .577	3 ² .19	2-2309	31-149	461
462	2 ² .3-5-7-11	4621	2-2311	3-23-67	2 ⁴ .17 ²	5 ² .37	2-3 ² .257	7-661	2 ² .13-89	3-1543	462
463	2-5-463	11-421	2 ² .3-193	41-113	2-7-331	3 ² .5-103	2 ² .19-61	4637	2-3-773	4639	463
464	2 ² .5-29	3-7-13-17	2-11-211	4643	2 ² .3 ² .43	5-929	2-23-101	3-1549	2 ² .7-83	4649	464
465	2-3-5 ² .31	4651	2 ² .1163	3 ² .11-47	2-13-179	5-7 ² .19	2 ⁴ .3-97	4657	2-17-137	3-1553	465
466	2 ² .5-233	59-79	2-3 ² .7-37	4663	2 ³ .11-53	3-5-311	2-2333	13-359	2 ² .3-389	7-23-29	466
467	2-5-467	3 ³ .173	2 ² .73	4673	2-3-19-41	5 ² .11-17	2 ² .7-167	3-1559	2-2339	4679	467
468	2 ³ .3 ² .5-13	31-151	2-2341	3-7-223	2 ² .1171	5-937	2-3-11-71	43-109	2 ⁴ .293	3 ² .521	468
469	2-5-7-67	4691	2 ² .3-17-23	13-19 ²	2-2347	3-5-313	2 ³ .587	7-11-61	2-3 ² .29	37-127	469
470	2 ² .5 ² .47	3-1567	2-2351	4703	2 ³ .3-7 ²	5-941	2-13-181	3 ² .523	2 ² .11-107	17-277	470
471	2-3-5-157	7-673	2 ² .19-31	3-1571	2-2357	5-23-41	2 ² .3 ² .131	53-89	2-7-337	3-11 ² .13	471
472	2 ⁴ .5-59	4721	2-3-787	4723	2 ² .1181	3 ³ .5 ² .7	2-17-139	29-163	2 ³ .3-197	4729	472
473	2-5-11-43	3-19-83	2 ² .7-13 ²	4733	2-3 ² .263	5-947	2 ² .37	3-1579	2-23-103	7-677	473
474	2 ² .3-5-79	11-431	2-2371	3 ² .17-31	2 ² .593	5-13-73	2-3-7-113	47-101	2 ² .1187	3-1583	474
475	2-5 ² .19	4751	2 ⁴ .3 ² .11	7 ² .97	2-2377	3-5-317	2 ² .29-41	67-71	2-3-13-61	4759	475
476	2 ² .5-7-17	3 ² .23 ²	2-2381	11-433	2 ² .3-397	5-953	2-2383	3-7-227	2 ² .149	19-251	476
477	2-3 ² .5-53	13-367	2 ² .1193	3-37-43	2-7-11-31	5 ² .191	2 ³ .3-199	17-281	2-2389	3 ⁴ .59	477
478	2 ² .5-239	7-683	2-3-797	4783	2 ⁴ .13-23	3-5-11-29	2-2393	4787	2 ² .3 ² .7-19	4789	478
479	2-5-479	3-1597	2 ² .599	4793	2-3-17-47	5-7-137	2 ² .11-109	3 ² .13-41	2-2399	4799	479
480	2 ² .3-5 ²	4801	2-7 ⁴	3-1601	2 ² .1201	5-31 ²	2-3 ³ .89	11-19-23	2 ² .601	3-7-229	480
481	2-5-13-37	17-283	2 ² .3-401	4813	2-29-83	3 ² .5-107	2 ⁴ .7-43	4817	2-3-11-73	61-79	481
482	2 ² .5-241	3-1607	2-2411	7-13-53	2 ³ .3 ² .67	5 ² .193	2-19-127	3-1609	2 ² .17-71	11-439	482
483	2-3-5-7-23	4831	2 ² .151	3 ² .179	2-2417	5-967	2 ² .3-13-31	7-691	2-41-59	3-1613	483
484	2 ³ .5-11 ²	47-103	2-3 ² .269	29-167	2 ² .7-173	3-5-17-19	2-2423	37-131	2 ⁴ .3-101	13-373	484
485	2-5 ² .97	3 ² .7 ² .11	2 ² .1213	23-211	2-3-809	5-971	2 ² .607	3-1619	2-7-347	43-113	485
486	2 ² .3 ² .5	4861	2-11-13-17	3-1621	2 ² .19	5-7-139	2-3-811	31-157	2 ² .1217	3 ² .541	486
487	2-5-487	4871	2 ³ .3-7-29	11-443	2-2437	3-5 ² .13	2 ² .23-53	4877	2-3 ² .271	7-17-41	487
488	2 ² .5-61	3-1627	2-2441	19-257	2 ² .3-11-37	5-977	2-7-349	3 ² .181	2 ² .13-47	4889	488
489	2-3-5-163	67-73	2 ² .1223	3-7-233	2-2447	5-11-89	2 ² .3 ² .17	59-83	2-31-79	3-23-71	489
490	2 ² .5 ² .7 ²	13 ² .29	2-3-19-43	4903	2 ² .613	3 ² .5-109	2-11-223	7-701	2 ² .3-409	4909	490
491	2-5-491	3-1637	2 ⁴ .307	17 ²	2-3 ³ .7-13	5-983	2 ² .1229	3-11-149	2-2459	4919	491
492	2 ² .3-5-41	7-19-37	2-23-107	3 ² .547	2 ² .1231	5 ² .197	2-3-821	13-379	2 ² .7-11	3-31-53	492
493	2-5-17-29	4931	2 ² .3 ² .137	4933	2-2467	3-5-7-47	2 ² .617	4937	2-3-823	11-449	493
494	2 ² .5-13-19	3 ⁴ .61	2-7-353	4943	2 ⁴ .3-103	5-23-43	2-2473	3-17-97	2 ² .1237	7 ² .101	494
495	2-3 ² .5 ² .11	4951	2 ² .619	3-13-127	2-2477	5-991	2 ² .3-7-59	4957	2-37-67	3 ² .19-29	495
496	2 ² .5-31	11 ² .41	2-3-827	7-709	2 ² .17-73	3-5-331	2-13-191	4967	2 ² .3 ² .23	4969	496
497	2-5-7-71	3-1657	2 ² .11-113	4973	2-3-829	5 ² .199	2 ⁴ .311	3 ² .7-79	2-19-131	13-383	497
498	2 ² .3-5-83	17-293	2-47-53	3-11-151	2-7-89	5-997	2-3 ² .277	4987	2 ² .29-43	3-1663	498
499	2-5-499	7-23-31	2 ² .3-13	4993	2-11-227	3 ² .5-37	2 ² .1249	19-263	2-3-7 ² .17	4999	499

COMBINATORIAL ANALYSIS
Factorizations

N	0	1	2	3	4	5	6	7	8	9	N
500	2 ⁵ ·5 ⁴	3·1667	2·41·61	5003	2 ² ·3 ² ·139	5·7·11·13	2·2503	3·1669	2 ⁴ ·313	5009	500
501	2 ³ ·5·167	5011	2 ² ·7·179	3 ² ·557	2·23·109	5·17·59	2 ³ ·3·11·19	29·173	2·13·193	3·7·239	501
502	2 ⁵ ·5·251	5021	2 ² ·3 ² ·31	5023	2 ⁵ ·157	3·5 ² ·67	2 ² ·7·359	11·457	2 ² ·3·419	47·107	502
503	2 ⁵ ·503	3 ² ·13·43	2 ³ ·17·37	7·719	2·3·839	5·19·53	2 ² ·1259	3·23·73	2·11·229	5039	503
504	2 ⁴ ·3 ² ·5·7	71 ²	2·2521	3·41 ²	2 ² ·13·97	5·1009	2·3·29 ²	7 ² ·103	2 ³ ·631	3 ³ ·11·17	504
505	2·5 ² ·101	5051	2 ² ·3·421	31·163	2·7·19 ²	3·5·337	2 ² ·79	13·389	2·3 ² ·281	5059	505
506	2 ² ·5·11·23	3·7·241	2·2531	61·83	2 ³ ·3·211	5·1013	2·17·149	3 ² ·563	2 ² ·7·181	37·137	506
507	2 ³ ·5·13 ²	11·461	2 ⁴ ·317	3·19·89	2·43·59	5 ² ·7·29	2 ² ·3 ² ·47	5077	2·2539	3·1693	507
508	2 ³ ·5·127	5081	2·3·7·11 ²	13·17·23	2 ² ·31·41	3 ² ·5·113	2·2543	5087	2 ⁵ ·3·53	7·727	508
509	2·5·509	3·1697	2 ² ·19·67	11·463	2·3 ² ·283	5·1019	2 ³ ·7 ² ·13	3·1699	2·2549	5099	509
510	2 ² ·3·5 ² ·17	5101	2·2551	3 ² ·7	2 ⁴ ·11·29	5·1021	2·3·23·37	5107	2 ² ·1277	3·13·131	510
511	2·5·7·73	19·269	2 ³ ·3 ² ·71	5113	2·2557	3·5·11·31	2 ² ·1279	7·17·43	2·3·853	5119	511
512	2 ¹⁰ ·5	3 ² ·569	2·13·197	47·109	2 ² ·3·7·61	5 ² ·41	2·11·233	3·1709	2 ³ ·641	23·223	512
513	2 ³ ·5·5·19	7·733	2 ² ·1283	3·29·59	2·17·151	5·13·79	2 ⁴ ·3·107	11·467	2·7·367	3 ² ·571	513
514	2 ² ·5·257	53·97	2·3·857	37·139	2 ³ ·643	3·5·7 ³	2·31·83	5147	2 ² ·3 ² ·11·13	19·271	514
515	2·5 ² ·103	3·17·101	2 ⁵ ·7·23	5153	2·3·859	5·1031	2 ² ·1289	3 ³ ·191	2·2579	7·11·67	515
516	2 ² ·3·5·43	13·397	2·29·89	3·1721	2 ² ·1291	5·1033	2·3 ² ·7·41	5167	2 ⁴ ·17·19	3·1723	516
517	2 ⁵ ·11·47	5171	2 ² ·3·431	7·739	2·13·199	3 ² ·5 ² ·23	2 ³ ·647	31·167	2·3·863	5179	517
518	2 ² ·5·7·37	3·11·157	2·2591	71·73	2 ³ ·3 ⁴	5·17·61	2·2593	3·7·13·19	2 ² ·1297	5189	518
519	2·3·5·173	29·179	2 ³ ·11·59	3 ² ·577	2·7 ² ·53	5·1039	2 ² ·3·433	5197	2·23·113	3·1733	519
520	2 ⁴ ·5 ² ·13	7·743	2·3 ² ·17 ²	11 ² ·43	2 ² ·1301	3·5·347	2·19·137	41·127	2 ³ ·7·31	5209	520
521	2·5·521	3 ² ·193	2 ² ·1303	13·401	2·3·11·79	5·7·149	2 ² ·163	3·37·47	2·2609	17·307	521
522	2 ² ·3 ² ·5·29	23·227	2·7·373	3·1741	2 ³ ·653	5 ² ·11·19	2·3·13·67	5227	2 ² ·1307	3 ² ·7·83	522
523	2·5·523	5231	2 ⁴ ·3·109	5233	2·2617	3·5·349	2 ² ·7·11·17	5237	2·3 ² ·97	13 ² ·31	523
524	2 ² ·5·131	3·1747	2·2621	7 ² ·107	2 ² ·3·19·23	5·1049	2·43·61	3 ² ·11·53	2 ² ·41	29·181	524
525	2·3·5 ² ·7	59·89	2 ² ·13·101	3·17·103	2·37·71	5·1051	2 ³ ·3 ² ·73	7·751	2·11·239	3·1753	525
526	2 ² ·5·263	5261	2·3·877	19·277	2 ² ·7·47	3 ⁴ ·5·13	2·2633	23·229	2 ² ·3·439	11·479	526
527	2·5·17·31	3·7·251	2 ³ ·659	5273	2·3 ² ·293	5 ² ·211	2 ² ·1319	3·1759	2·7·13·29	5279	527
528	2 ² ·3·5·11	5281	2·19·139	3 ² ·587	2 ² ·1321	5·7·151	2·3·881	17·311	2 ³ ·661	3·41·43	528
529	2·5·23 ²	11·13·37	2 ² ·3 ² ·7 ²	67·79	2·2647	3·5·353	2 ⁴ ·331	5297	2·3·883	7·757	529
530	2 ² ·5 ² ·53	3 ² ·19·31	2·11·241	5303	2 ³ ·3·13·17	5·1061	2·7·379	3·29·61	2 ² ·1327	5309	530
531	2·3 ² ·5·59	47·113	2 ³ ·83	3·7·11·23	2·2657	5·1063	2 ² ·3·443	13·409	2·2659	3 ² ·197	531
532	2 ² ·5·7·19	17·313	2·3·887	5323	2 ² ·11 ³	3·5 ² ·71	2·2663	7·761	2 ⁴ ·3 ² ·37	73 ²	532
533	2·5·13·41	3·1777	2 ² ·31·43	5333	2·3·7·127	5·11·97	2 ² ·23·29	3 ² ·593	2·17·157	19·281	533
534	2 ² ·3·5·89	7 ² ·109	2·2671	3·13·137	2 ³ ·167	5·1069	2·3 ⁵ ·11	5347	2 ² ·7·191	3·1783	534
535	2·5 ² ·107	5351	2 ² ·3·223	53·101	2·2677	3 ² ·5·7·17	2 ² ·13·103	11·487	2·3·19·47	23·233	535
536	2 ⁴ ·5·67	3·1787	2·7·383	31·173	2 ² ·3 ² ·149	5·29·37	2·2683	3·1789	2 ² ·11·61	7·13·59	536
537	2·3·5·179	41·131	2 ² ·17·79	3 ² ·199	2·2687	5 ² ·43	2 ³ ·3·7	19·283	2·2689	3·11·163	537
538	2 ² ·5·269	5381	2·3 ² ·13·23	7·769	2 ³ ·673	3·5·359	2·2693	5387	2 ² ·3·449	17·317	538
539	2·5·7 ² ·11	3 ² ·599	2 ⁴ ·337	5393	2·3·29·31	5·13·83	2 ² ·19·71	3·7·257	2·2699	5399	539
540	2 ² ·3 ² ·5 ²	11·491	2·37·73	3·1801	2 ² ·7·193	5·23·47	2·3·17·53	5407	2 ⁵ ·13 ²	3 ² ·601	540
541	2·5·541	7·773	2 ² ·3·11·41	5413	2·2707	3·5·19 ²	3 ² ·677	5417	2·3 ² ·7·43	5419	541
542	2 ² ·5·271	3·13·139	2·2711	11·17·29	2 ² ·3·113	5 ² ·7·31	2·2713	3 ⁴ ·67	2 ² ·23·59	61·89	542
543	2·3·5·181	5431	2 ² ·7·97	3·1811	2·11·13·19	5·1087	2 ² ·3 ² ·151	5437	2·2719	3·7 ² ·37	543
544	2 ² ·5·17	5441	2·3·907	5443	2 ² ·1361	3 ² ·5·11 ²	2·7·389	13·419	2 ² ·3·227	5449	544
545	2·5 ² ·109	3·23·79	2 ² ·29·47	7·19·41	2·3 ³ ·101	5·1091	2 ⁴ ·11·31	3·17·107	2·2729	53·103	545
546	2 ² ·3·5·7·13	43·127	2·2731	3 ² ·607	2 ³ ·683	5·1093	2·3·911	7·11·71	2 ² ·1367	3·1823	546
547	2 ² ·5·547	5471	2 ² ·3 ² ·19	13·421	2·7·17·23	3·5 ² ·73	2 ² ·37 ²	5477	2·3·11·83	5479	547
548	2 ² ·5·137	3 ² ·7·29	2·2741	5483	2 ² ·3·457	5·1097	2·13·211	3·31·59	2 ⁴ ·7 ³	11·499	548
549	2·3 ² ·5·61	17 ² ·19	2 ² ·1373	3·1831	2·41·67	5·7·157	2 ² ·3·229	23·239	2·2749	3 ² ·13·47	549

550	2 ² ·5 ³ ·11	5501	2·3·7·131	5503	2 ⁷ ·43	3·5·367*	2·2753	5507	2 ² ·3 ⁴ ·17	7·787	550
551	2 ⁵ ·19·29	3·11·167	2 ² ·13·53	37·149	2·3·919	5·1103	2 ² ·7·197	3 ² ·613	2·31·89	5519	551
552	2 ⁴ ·3·5·23	5521	2·11·251	3·7·263	2 ² ·1381	5 ² ·13·17	2·3 ² ·307	5527	2 ² ·691	3·19·97	552
553	2·5·7·79	5531	2 ² ·3·461	11·503	2·2767	3 ² ·5·41	2 ² ·173	7 ² ·113	2·3·13·71	29·191	553
554	2 ² ·5·277	3·1847	2·17·163	23·241	2 ² ·3 ² ·7·11	5·1109	2·47·59	3·43 ²	2 ² ·19·73	31·179	554
555	2·3·5 ² ·37	7·13·61	2 ⁴ ·347	3 ² ·617	2·2777	5·11·101	2 ² ·3·463	5557	2·7·397	3·17·109	555
556	2 ² ·5·139	67·83	2·3 ² ·103	5563	2 ² ·13·107	3·5·7·53	2·11 ² ·23	19·293	2 ² ·3·29	5569	556
557	2·5·557	3 ² ·619	2 ² ·7·199	5573	2·3·929	5 ² ·223	2 ² ·17·41	3·11·13 ²	2·2789	7·797	557
558	2 ² ·3 ² ·5·31	5581	2·2791	3·1861	2 ⁴ ·349	5·1117	2·3·7 ² ·19	37·151	2 ² ·11·127	3 ² ·23	558
559	2·5·13·43	5591	2 ² ·3·233	7·17·47	2·2797	3·5·373	2 ² ·1399	29·193	2·3 ² ·311	11·509	559
560	2 ⁵ ·5 ² ·7	3·1867	2·2801	13·431	2 ² ·3·467	5·19·59	2·2803	3 ² ·7·89	2 ² ·701	71·79	560
561	2·3·5·11·17	31·181	2 ² ·23·61	3·1871	2·7·401	5·1123	2 ⁴ ·3 ² ·13	41·137	2·53 ²	3·1873	561
562	2 ² ·5·281	7·11·73	2·3·937	5623	2 ² ·19·37	3 ² ·5 ²	2·29·97	17·331	2 ² ·3·7·67	13·433	562
563	2·5·563	3·1877	2 ² ·11	43·131	2·3 ² ·313	5·7 ² ·23	2 ² ·1409	3·1879	2 ² ·2819	5639	563
564	2 ² ·3·5·47	5641	2·7·13·31	3 ² ·11·19	2 ² ·17·83	5·1129	2·3·941	5647	2 ⁴ ·353	3·7·269	564
565	2·5 ² ·113	5651	2 ² ·3 ² ·157	5653	2·11·257	3·5·13·29	2 ² ·7·101	5657	2·3·23·41	5659	565
566	2 ² ·5·283	3 ² ·17·37	2·19·149	7·809	2 ² ·3·59	5·11·103	2·2833	3·1889	2 ² ·13·109	5669	566
567	2·3 ⁴ ·5·7	53·107	2 ² ·709	3·31·61	2·2837	5 ² ·227	2 ² ·3·11·43	7·811	2·17·167	3 ² ·631	567
568	2 ² ·5·71	13·19·23	2·3·947	5683	2 ² ·7 ² ·29	3·5·379	2·2843	11 ² ·47	2 ² ·3 ² ·79	5689	568
569	2·5·569	3·7·271	2 ² ·1423	5693	2·3·13·73	5·17·67	2 ² ·89	3 ² ·211	2·7·11·37	41·139	569
570	2 ² ·3·5 ² ·19	5701	2·2851	3·1901	2 ² ·23·31	5·7·163	2·3 ² ·317	13·439	2 ² ·1427	3·11·173	570
571	2·5·571	5711	2 ⁴ ·3·7·17	29·197	2·2857	3 ² ·5·127	2 ² ·1429	5717	2·3·953	7·19·43	571
572	2 ² ·5·11·13	3·1907	2·2861	59·97	2 ² ·3 ² ·53	5 ² ·229	2·7·409	3·23·83	2 ² ·179	17·337	572
573	2·3·5·191	11·521	2 ² ·1433	3 ² ·7 ² ·13	2·47·61	5·31·37	2 ² ·3·239	5737	2·19·151	3·1913	573
574	2 ² ·5·7·41	5741	2·3 ² ·11·29	5743	2 ⁴ ·359	3·5·383	2·13 ² ·17	7·821	2 ² ·3·479	5749	574
575	2·5 ² ·23	3 ⁴ ·71	2 ² ·719	11·523	2·3·7·137	5·1151	2 ² ·1439	3·19·101	2·2879	13·443	575
576	2 ² ·3 ² ·5	7·823	2·43·67	3·17·113	2 ² ·11·131	5·1153	2·3·31 ²	73·79	2 ² ·7·103	3 ² ·641	576
577	2·5·577	29·199	2 ² ·3·13·37	23·251	2·2887	3·5 ² ·7·11	2 ⁴ ·19 ²	53·109	2·3·107	5779	577
578	2 ² ·5·17 ²	3·41·47	2·7 ² ·59	5783	2 ² ·3·241	5·13·89	2·11·263	3 ² ·643	2 ² ·1447	7·827	578
579	2·3·5·193	5791	2 ⁵ ·181	3·1931	2·2897	5·19·61	2 ² ·3 ² ·7·23	11·17·31	2·13·223	3·1933	579
580	2 ² ·5 ² ·29	5801	2·3·967	7·829	2 ² ·1451	3 ² ·5·43	2·2903	5807	2 ⁴ ·3·11 ²	37·157	580
581	2·5·7·83	3·13·149	2 ² ·1453	5813	2·3 ² ·17·19	5·1163	2 ² ·727	3·7·277	2·2909	11·23 ²	581
582	2 ² ·3·5·97	5821	2·41·71	3 ² ·647	2 ² ·7·13	5 ² ·233	2·3·971	5827	2 ² ·31·47	3·29·67	582
583	2·5·11·53	7 ² ·17	2 ² ·3 ⁶	19·307	2·2917	3·5·389	2 ² ·1459	13·449	2·3·7·139	5839	583
584	2 ⁴ ·5·73	3 ² ·11·59	2·23·127	5843	2 ² ·3·487	5·7·167	2·37·79	3·1949	2 ² ·17·43	5849	584
585	2·3 ² ·5 ² ·13	5851	2 ² ·7·11·19	3·1951	2·2927	5·1171	2 ² ·3·61	5857	2·29·101	3 ² ·7·31	585
586	2 ² ·5·293	5861	2·3·977	11·13·41	2 ² ·733	3·5·17·23	2·7·419	5867	2 ² ·3 ² ·163	5869	586
587	2·5·587	3·19·103	2 ⁴ ·367	7·839	2·3·11·89	5 ² ·47	2 ² ·13·113	3 ² ·653	2·2939	5879	587
588	2 ² ·3·5·7 ²	5881	2·17·173	3·37·53	2 ² ·1471	5·11·107	2·3 ² ·109	7·29 ²	2 ² ·23	3·13·151	588
589	2·5·19·31	43·137	2 ² ·3·491	71·83	2·7·421	3 ² ·5·131	2 ² ·11·67	5897	2·3·983	17·347	589
590	2 ² ·5 ² ·59	3·7·281	2·13·227	5903	2 ⁴ ·3 ² ·41	5·1181	2·2953	3·11·179	2 ² ·7·211	19·311	590
591	2·3·5·197	23·257	2 ² ·739	3 ⁴ ·73	2·2957	5·7·13 ²	2 ² ·3·17·29	61·97	2·11·269	3·1973	591
592	2 ² ·5·37	31·191	2·3 ² ·7·47	5923	2 ² ·1481	3·5 ² ·79	2·2963	5927	2 ² ·3·13·19	7 ² ·11 ²	592
593	2·5·593	3 ² ·659	2 ² ·1483	17·349	2·3·23·43	5·1187	2 ⁴ ·7·53	3·1979	2·2969	5939	593
594	2 ² ·3 ² ·5·11	13·457	2·2971	3·7·283	2 ² ·743	5·29·41	2·3·991	19·313	2 ² ·1487	3 ² ·661	594
595	2·5 ² ·7·17	11·541	2 ² ·3·31	5953	2·13·229	3·5·397	2 ² ·1489	7·23·37	2·3 ² ·331	59·101	595
596	2 ² ·5·149	3·1987	2·11·271	67·89	2 ² ·3·7·71	5·1193	2·19·157	3 ² ·13·17	2 ² ·373	47·127	596
597	2·3·5·199	7·853	2 ² ·1493	3·11·181	2·29·103	5 ² ·239	2 ² ·3 ² ·83	43·139	2·7 ² ·61	3·1993	597
598	2 ² ·5·13·23	5981	2·3·997	31·193	2 ² ·11·17	3 ² ·5·7·19	2·41·73	5987	2 ² ·3·499	53·113	598
599	2·5·599	3·1997	2 ² ·7·107	13·461	2·3 ⁴ ·37	5·11·109	2 ² ·1499	3·1999	2·2999	7·857	599

COMBINATORIAL ANALYSIS
Factorizations

Table 24.7
855
5999

Table 24.7
6000

Factorizations

6499

N	0	1	2	3	4	5	6	7	8	9	N
600	2 ⁴ ·3·5 ³	17·353	2·3001	3 ² ·23·29	2 ² ·19·79	5·1201	2·3·7·11·13	6007	2 ³ ·751	3·2003	600
601	2·5·601	6011	2 ² ·3 ² ·167	7·859	2·31·97	3·5·401	2 ² ·47	11·547	2·3·17·59	13·463	601
602	2 ² ·5·7·43	3 ² ·223	2·3011	19·317	2 ³ ·3·251	5 ² ·241	2·23·131	3·7 ² ·41	2 ² ·11·137	6029	602
603	2·3 ² ·5·67	37·163	2 ⁴ ·13·29	3·2011	2·7·431	5·17·71	2 ² ·3·503	6037	2·3019	3 ² ·11·61	603
604	2 ² ·5·151	7·863	2·3·19·53	6043	2 ² ·1511	3·5·13·31	2·3023	6047	2 ² ·3 ² ·7	23·263	604
605	2·5 ² ·11 ²	3·2017	2 ² ·17·89	6053	2·3·1009	5·7·173	2 ³ ·757	3 ² ·673	2·13·233	73·83	605
606	2 ² ·3·5·101	11·19·29	2·7·433	3·43·47	2 ⁴ ·379	5·1213	2·3 ² ·337	6067	2 ² ·37·41	3·7·17 ²	606
607	2·5·607	13·467	2 ³ ·3·11·23	6073	2·3037	3 ⁵ ·5 ²	2 ² ·7 ² ·31	59·103	2·3·1013	6079	607
608	2 ² ·5·19	3·2027	2·3041	7·11·79	2 ² ·3 ² ·13 ²	5·1217	2·17·179	3·2029	2 ² ·761	6089	608
609	2·3·5·7·29	6091	2 ² ·1523	3 ² ·677	2·11·277	5·23·53	2 ⁴ ·3·127	7·13·67	2·3049	3·19·107	609
610	2 ² ·5 ² ·61	6101	2·3 ³ ·113	17·359	2 ³ ·7·109	3·5·11·37	2·43·71	31·197	2 ² ·3·509	41·149	610
611	2·5·13·47	3 ² ·7·97	2 ⁵ ·191	6113	2·3·1019	5·1223	2 ² ·11·139	3·2039	2·7·19·23	29·211	611
612	2 ³ ·3 ² ·5·17	6121	2·3061	3·13·157	2 ² ·1531	5 ³ ·7 ²	2·3·1021	11·557	2 ⁴ ·383	3 ² ·227	612
613	2·5·613	6131	2 ² ·3·7·73	6133	2·3067	3·5·409	2 ³ ·13·59	17·19 ²	2·3 ² ·11·31	7·877	613
614	2 ² ·5·307	3·23·89	2·37·83	6143	2 ¹¹ ·3	5·1229	2·7·439	3 ² ·683	2 ² ·29·53	11·13·43	614
615	2·3·5 ² ·41	6151	2 ³ ·769	3·7·293	2·17·181	5·1231	2 ² ·3 ⁴ ·19	47·131	2·3079	3·2053	615
616	2 ⁴ ·5·7·11	61·101	2·3·13·79	6163	2 ² ·23·67	3 ² ·5·137	2·3083	7·881	2 ³ ·3·257	31·199	616
617	2·5·617	3·11 ² ·17	2 ² ·1543	6173	2·3 ² ·7 ³	5 ² ·13·19	2 ⁵ ·193	3·29·71	2·3089	37·167	617
618	2 ² ·3·5·103	7·883	2·11·281	3 ² ·229	2 ² ·773	5·1237	2·3·1031	23·269	2 ² ·7·13·17	3·2063	618
619	2·5·619	41·151	2 ⁴ ·3 ² ·43	11·563	2·19·163	3·5·7·59	2 ² ·1549	6197	2·3·1033	6199	619
620	2 ² ·5 ² ·31	3 ² ·13·53	2·7·443	6203	2 ² ·3·11·47	5·17·73	2·29·107	3·2069	2 ⁶ ·97	7·887	620
621	2·3 ² ·5·23	6211	2 ² ·1553	3·19·109	2·13·239	5·11·113	2 ³ ·3·7·37	6217	2·3109	3 ² ·691	621
622	2 ² ·5·311	6221	2·3·17·61	7 ² ·127	2 ⁴ ·389	3·5 ² ·83	2·11·283	13·479	2 ² ·3 ² ·173	6229	622
623	2·5·7·89	3·31·67	2 ³ ·19·41	23·271	2·3·1039	5·29·43	2 ² ·1559	3 ⁴ ·7·11	2·3119	17·367	623
624	2 ² ·3·5·13	79 ²	2·3121	3·2081	2 ² ·7·223	5·1249	2·3 ² ·347	6247	2 ⁵ ·11·71	3·2083	624
625	2·5 ⁵	7·19·47	2 ² ·3·521	13 ² ·37	2·53·59	3 ² ·5·139	2 ⁴ ·17·23	6257	2·3·7·149	11·569	625
626	2 ³ ·5·313	3·2087	2·31·101	6263	2 ² ·3 ² ·29	5·7·179	2·13·241	3·2089	2 ² ·1567	6269	626
627	2·3·5·11·19	6271	2 ⁷ ·7 ²	3 ² ·17·41	2·3137	5 ² ·251	2 ² ·3·523	6277	2·43·73	3·7·13·23	627
628	2 ³ ·5·157	11·571	2·3 ² ·349	61·103	2 ² ·1571	3·5·419	2·7·449	6287	2 ⁴ ·3·131	19·331	628
629	2·5·17·37	3 ² ·233	2 ² ·11 ² ·13	7·29·31	2·3·1049	5·1259	2 ² ·787	3·2099	2·47·67	6299	629
630	2 ² ·3 ² ·5 ² ·7	6301	2·23·137	3·11·191	2 ⁵ ·197	5·13·97	2·3·1051	7·17·53	2 ² ·19·83	3 ² ·701	630
631	2·5·631	6311	2 ³ ·3·263	59·107	2·7·11·41	3·5·421	2 ² ·1579	6317	2·3 ² ·13	71·89	631
632	2 ⁴ ·5·79	3·7 ² ·43	2·29·109	6323	2 ² ·3·17·31	5 ² ·11·23	2·3163	3 ² ·19·37	2 ³ ·7·113	6329	632
633	2·3·5·211	13·487	2 ² ·1583	3·2111	2·3167	5·7·181	2 ² ·3 ² ·11	6337	2·3169	3·2113	633
634	2 ² ·5·317	17·373	2·3·7·151	6343	2 ³ ·13·61	3 ³ ·5·47	2·19·167	11·577	2 ² ·3·23 ²	7·907	634
635	2·5 ² ·127	3·29·73	2 ⁴ ·397	6353	2·3 ² ·353	5·31·41	2 ² ·7·227	3·13·163	2·11·17 ²	6359	635
636	2 ² ·3·5·53	6361	2·3181	3 ² ·7·101	2 ² ·37·43	5·19·67	2·3·1061	6367	2 ⁵ ·199	3·11·193	636
637	2·5·7 ² ·13	23·277	2 ² ·3 ² ·59	6373	2·3187	3·5 ³ ·17	2 ² ·797	7·911	2·3·1063	6379	637
638	2 ² ·5·11·29	3 ² ·709	2·3191	13·491	2 ⁴ ·3·7·19	5·1277	2·31·103	3·2129	2 ² ·1597	6389	638
639	2·3 ² ·5·71	7·11·83	2 ² ·17·47	3·2131	2·23·139	5·1279	2 ² ·3·13·41	6397	2·7·457	3 ⁴ ·79	639
640	2 ² ·5 ²	37·173	2·3·11·97	19·337	2 ² ·1601	3·5·7·61	2·3203	43·149	2 ³ ·3 ² ·89	13·17·29	640
641	2·5·641	3·2137	2 ² ·7·229	11 ² ·53	2·3·1069	5·1283	2 ⁴ ·401	3 ² ·23·31	2·3209	7 ² ·131	641
642	2 ² ·3·5·107	6421	2·13 ² ·19	3·2141	2 ³ ·11·73	5 ² ·257	2·3 ² ·7·17	6427	2 ² ·1607	3·2143	642
643	2·5·643	59·109	2 ⁵ ·3·67	7·919	2·3217	3 ² ·5·11·13	2 ² ·1609	41·157	2·3·29·37	47·137	643
644	2 ³ ·5·7·23	3·19·113	2·3221	17·379	2 ² ·3 ² ·179	5·1289	2·11·293	3·7·307	2 ⁴ ·13·31	6449	644
645	2·3·5 ² ·43	6451	2 ² ·1613	3 ² ·239	2·7·461	5·1291	2 ² ·3·269	11·587	2·3229	3·2153	645
646	2 ² ·5·17·19	7·13·71	2·3 ² ·359	23·281	2 ² ·101	3·5·431	2·53·61	29·223	2 ² ·3·7 ² ·11	6469	646
647	2·5·647	3 ² ·719	2 ³ ·809	6473	2·3·13·83	5 ² ·7·37	2 ² ·1619	3·17·127	2·41·79	11·19·31	647
648	2 ⁴ ·3 ⁴ ·5	6481	2·7·463	3·2161	2 ² ·1621	5·1297	2·3·23·47	13·499	2 ² ·811	3 ² ·7·103	648
649	2·5·11·59	6491	2 ² ·3·541	43·151	2·17·191	3·5·433	2 ⁵ ·7·29	73·89	2·3 ² ·19 ²	67·97	649

650	2 ² .5 ³ .13	3-11-197	2-3251	7-929	2 ² .3-271	5-1301	2-3253	3 ² .241	2 ² .1627	23-283	650
651	2-3-5-7-31	17-383	2 ⁴ .11-37	3-13-167	2-3257	5-1303	2-3 ² .181	7 ² .19	2-3259	3-41-53	651
652	2 ² .5-163	6521	2-3-1087	11-593	2 ² .7-233	3 ² .5 ² .29	2-13-251	61-107	2-3-17	6529	652
653	2-5-653	3-7-311	2 ² .23-71	47-139	2-3 ² .11 ²	5-1307	2 ² .19-43	3-2179	2-7-467	13-503	653
654	2 ² .3-5-109	31-211	2-3271	3 ² .727	2 ⁴ .409	5-7-11-17	2-3-1091	6547	2 ² .1637	3-37-59	654
655	2-5 ² .131	6551	2 ² .3 ² .7-13	6553	2-29-113	3-5-19-23	2 ² .11-149	79-83	2-3-1093	7-937	655
656	2 ² .5-41	3 ²	2-17-193	6563	2 ² .3-547	5-13-101	2-7 ² .67	3-11-199	2 ² .821	6569	656
657	2-3 ² .5-73	6571	2 ² .31-53	3-7-313	2-19-173	5 ² .263	2 ⁴ .3-137	6577	2-11-13-23	3 ² .17-43	657
658	2 ² .5-7-47	6581	2-3-1097	29-227	2 ² .823	3-5-439	2-37-89	7-941	2 ² .3 ² .61	11-599	658
659	2-5-659	3-13 ²	2 ² .103	19-347	2-3-7-157	5-1319	2 ² .17-97	3 ² .733	2-3299	6599	659
660	2 ² .3-5 ² .11	7-23-41	2-3301	3-31-71	2 ² .13-127	5-1321	2-3 ² .367	6607	2 ⁴ .7-59	3-2203	660
661	2-5-661	11-601	2 ² .3-19-29	17-389	2-3307	3 ² .5-7 ²	2 ² .827	13-509	2-3-1103	6619	661
662	2 ² .5-331	3-2207	2-7-11-43	37-179	2 ² .3 ² .23	5 ² .53	2-3313	3-47 ²	2 ² .1657	7-947	662
663	2-3-5-13-17	19-349	2 ² .829	3 ² .11-67	2-31-107	5-1327	2 ² .3-7-79	6637	2-3319	3-2213	663
664	2 ⁴ .5-83	29-229	2-3 ⁴ .41	7-13-73	2 ² .11-151	3-5-443	2-3323	17 ² .23	2 ² .3-277	61-109	664
665	2-5 ² .7-19	3 ² .739	2 ² .1663	6653	2-3-1109	5-11 ²	2 ² .13	3-7-317	2-3329	6659	665
666	2 ² .3 ² .5-37	6661	2-3331	3-2221	2 ² .7 ² .17	5-31-43	2-3-11-101	59-113	2 ² .1667	3 ² .13-19	666
667	2-5-23-29	7-953	2 ⁴ .3-139	6673	2-47-71	3-5 ² .89	2 ² .1669	11-607	2-3 ² .7-53	6679	667
668	2 ² .5-167	3-17-131	2-13-257	41-163	2 ² .3-557	5-7-191	2-3343	3 ² .743	2 ² .11-19	6689	668
669	2-3-5-223	6691	2 ² .7-239	3-23-97	2-3347	5-13-103	2 ² .3 ² .31	37-181	2-17-197	3-7-11-29	669
670	2 ² .5 ² .67	6701	2-3-1117	6703	2 ⁴ .419	3 ² .5-149	2-7-479	19-353	2 ² .3-13-43	6709	670
671	2-5-11-61	3-2237	2 ² .839	7 ² .137	2-3 ² .373	5-17-79	2 ² .23-73	3-2239	2-3359	6719	671
672	2 ² .3-5-7	11-13-47	2-3361	3-483	2 ² .41 ²	5 ² .269	2-3-19-59	7-31 ²	2 ² .29 ²	3-2243	672
673	2-5-673	53-127	2 ² .3 ² .11-17	6733	2-7-13-37	3-5-449	2-421	6737	2-3-1123	23-293	673
674	2 ² .5-337	3 ² .7-107	2-3371	11-613	2 ² .3-281	5-19-71	2-3373	3-13-173	2 ² .7-241	17-397	674
675	2-3 ² .5 ²	43-157	2 ² .211	3-2251	2-11-307	5-7-193	2 ² .3-563	29-233	2-31-109	3 ² .751	675
676	2 ² .5-13 ²	6761	2-3-7 ² .23	6763	2 ² .19-89	3-5-11-41	2-17-199	67-101	2 ⁴ .3 ² .47	7-967	676
677	2-5-677	3-37-61	2 ² .1693	13-521	2-3-1129	5 ² .271	2 ² .7-11 ²	3 ² .251	2-3389	6779	677
678	2 ² .3-5-113	6781	2-3391	3-7-17-19	2 ² .53	5-23-59	2-3 ² .13-29	11-617	2 ² .1697	3-31-73	678
679	2-5-7-97	6791	2 ² .3-283	6793	2-43-79	3 ² .5-151	2 ² .1699	7-971	2-3-11-103	13-523	679
680	2 ⁴ .5 ² .17	3-2267	2-19-179	6803	2 ² .3 ² .7	5-1361	2-41-83	3-2269	2 ² .23-37	11-619	680
681	2-3-5-227	7 ² .139	2 ² .13-131	3 ² .757	2-3407	5-29-47	2 ² .3-71	17-401	2-7-487	3-2273	681
682	2 ² .5-11-31	19-359	2-3 ² .379	6823	2 ² .853	3-5 ² .7-13	2-3413	6827	2 ² .3-569	6829	682
683	2-5-683	3 ² .11-23	2 ⁴ .7-61	6833	2-3-17-67	5-1367	2 ² .1709	3-43-53	2-13-263	7-977	683
684	2 ² .3 ² .5-19	6841	2-11-311	3-2281	2 ² .29-59	5-37 ²	2-3-7-163	41-167	2 ² .107	3 ² .761	684
685	2-5 ² .137	13-17-31	2 ² .3-571	7-11-89	2-23-149	3-5-457	2 ² .857	6857	2-3 ² .127	19 ²	685
686	2 ² .5-7 ²	3-2287	2-47-73	6863	2 ⁴ .3-11-13	5-1373	2-3433	3 ² .7-109	2 ² .17-101	6869	686
687	2-3-5-229	6871	2 ² .859	3-29-79	2-7-491	5 ⁴ .11	2 ² .3 ² .191	13-23 ²	2-19-181	3-2293	687
688	2 ² .5-43	7-983	2-3-31-37	6883	2 ² .1721	3 ⁴ .5-17	2-11-313	71-97	2 ² .3-7-41	83 ²	688
689	2-5-13-53	3-2297	2 ² .1723	61-113	2-3 ² .383	5-7-197	2 ⁴ .431	3-11 ² .19	2-8449	6899	689
690	2 ² .3-5 ² .23	67-103	2-7-17-29	3 ² .13-59	2 ² .863	5-1381	2-3-1151	6907	2 ² .11-157	3-7 ² .47	690
691	2-5-691	6911	2 ² .3 ²	31-223	2-3457	3-5-461	2 ² .7-13-19	6917	2-3-1153	11-17-37	691
692	2 ² .5-173	3 ² .769	2-3461	7-23-43	2 ² .3-577	5 ² .277	2-3463	3-2309	2 ⁴ .433	13 ² .41	692
693	2-3 ² .5-7-11	29-239	2 ² .1733	3-2311	2-3467	5-19-73	2 ² .3-17 ²	7-991	2-3469	3 ² .257	693
694	2 ² .5-347	11-631	2-3-13-89	53-131	2 ² .7-31	3-5-463	2-23-151	6947	2 ² .3 ² .193	6949	694
695	2-5 ² .139	3-7-331	2 ² .11-79	17-409	2-3-19-61	5-13-107	2 ² .37-47	3 ² .773	2-7 ² .71	6959	695
696	2 ⁴ .3-5-29	6961	2-59 ²	3-11-211	2 ² .1741	5-7-199	2-3 ² .43	6967	2 ² .13-67	3-23-101	696
697	2-5-17-41	6971	2 ² .3-7-83	19-367	2-11-317	3 ² .5 ² .31	2 ² .109	6977	2-3-1163	7-997	697
698	2 ² .5-349	3-13-179	2-3491	6983	2 ² .3 ² .97	5-11-127	2-7-499	3-17-137	2 ² .1747	29-241	698
699	2-3-5-233	6991	2 ⁴ .19-23	3 ² .7-37	2-13-269	5-1399	2 ² .3-11-53	6997	2-3499	3-2333	699

N	0	1	2	3	4	5	6	7	8	9	N
700	2 ³ ·5 ³ ·7	7001	2·3 ² ·389	47·149	2 ² ·17·103	3·5·467	2·31·113	7 ² ·11·13	2 ⁵ ·3·73	43·163	700
701	2·5·701	3 ² ·19·41	2 ² ·1753	7013	2·3·7·167	5·23·61	2 ² ·877	3·2339	2·11 ² ·29	7019	701
702	2 ² ·3 ³ ·5·13	7·17·59	2·3511	3·2341	2 ⁴ ·439	5 ² ·281	2·3·1171	7027	2 ² ·7·251	3 ² ·11·71	702
703	2·5·19·37	79·89	2 ³ ·3·293	13·541	2·3517	3·5·7·67	2 ² ·1759	31·227	2·3 ² ·17·23	7039	703
704	2 ⁷ ·5·11	3·2347	2·7·503	7043	2 ² ·3·587	5·1409	2·13·271	3 ² ·29	2 ² ·881	7·19·53	704
705	2·3·5 ² ·47	11·641	2 ² ·41·43	3·2351	2·3527	5·17·83	2 ⁴ ·3 ² ·7 ²	7057	2·3529	3·13·181	705
706	2 ² ·5·353	23·307	2·3·11·107	7·1009	2 ² ·883	3 ² ·5·157	2·3533	37·191	2 ² ·3·19·31	7069	706
707	2·5·7·101	3·2357	2 ² ·13·17	11·643	2·3 ³ ·131	5 ² ·283	2 ² ·29·61	3·7·337	2·3539	7079	707
708	2 ² ·3·5·59	73·97	2·3541	3 ² ·787	2 ² ·7·11·23	5·13·109	2·3·1181	19·373	2 ² ·443	3·17·139	708
709	2·5·709	7·1013	2 ² ·3 ² ·197	41·173	2·3547	3·5·11·43	2 ² ·887	47·151	2·3·7·13 ²	31·229	709
710	2 ² ·5 ² ·71	3 ² ·263	2·53·67	7103	2 ² ·3·37	5·7 ² ·29	2·11·17·19	3·23·103	2 ² ·1777	7109	710
711	2·3 ² ·5·79	13·547	2 ² ·7·127	3·2371	2·3557	5·1423	2 ² ·3·593	11·647	2·3559	3 ² ·7·113	711
712	2 ⁴ ·5·89	7121	2·3·1187	17·419	2 ² ·13·137	3·5 ³ ·19	2·7·509	7127	2 ² ·3 ⁴ ·11	7129	712
713	2·5·23·31	3·2377	2 ² ·1783	7·1019	2·3·29·41	5·1427	2 ² ·223	3 ² ·13·61	2·43·83	11 ² ·59	713
714	2 ² ·3·5·7·17	37·193	2·3571	3·2381	2 ² ·19·47	5·1429	2·3 ² ·397	7·1021	2 ² ·1787	3·2383	714
715	2·5 ² ·11·13	7151	2 ⁴ ·3·149	23·311	2·7 ² ·73	3 ² ·5·53	2 ² ·1789	17·421	2·3·1193	7159	715
716	2 ² ·5·179	3·7·11·31	2·3581	13·19·29	2 ² ·3 ² ·199	5·1433	2·3583	3·2389	2 ¹⁰ ·7	67·107	716
717	2·3·5·239	71·101	2 ² ·11·163	3 ² ·797	2·17·211	5 ² ·7·41	2 ² ·3·13·23	7177	2·37·97	3·2393	717
718	2 ² ·5·359	43·167	2·3 ² ·7·19	11·653	2 ⁴ ·449	3·5·479	2·3593	7187	2 ² ·3·599	7·13·79	718
719	2·5·719	3 ² ·17·47	2 ² ·29·31	7193	2·3·11·109	5·1439	2 ² ·7·257	3·2399	2·59·61	23·313	719
720	2 ⁵ ·3 ² ·5 ²	19·379	2·13·277	3·7 ⁴	2 ² ·1801	5·11·131	2·3·1201	7207	2 ² ·17·53	3 ⁴ ·89	720
721	2·5·7·103	7211	2 ² ·3·601	7213	2·3607	3·5·13·37	2 ⁴ ·11·41	7·1031	2·3 ² ·401	7219	721
722	2 ² ·5·19 ²	3·29·83	2·23·157	31·233	2 ³ ·3·7·43	5 ² ·17 ²	2·3613	3 ² ·11·73	2 ² ·13·139	7229	722
723	2·3·5·241	7·1033	2 ⁶ ·113	3·2411	2·3617	5·1447	2 ² ·3 ² ·67	7237	2·7·11·47	3·19·127	723
724	2 ² ·5·181	13·557	2·3·17·71	7243	2 ² ·1811	3 ² ·5·7·23	2·3623	7247	2 ⁴ ·3·151	11·659	724
725	2·5 ² ·29	3·2417	2 ² ·7 ² ·37	7253	2·3 ² ·13·31	5·1451	2 ² ·907	3·41·59	2·19·191	7·17·61	725
726	2 ² ·3·5·11 ²	53·137	2·3631	3 ² ·269	2 ² ·227	5·1453	2·3·7·173	13 ² ·43	2 ² ·23·79	3·2423	726
727	2·5·727	11·661	2 ² ·3 ² ·101	7·1039	2·3637	3·5 ² ·97	2 ² ·17·107	19·383	2·3·1213	29·251	727
728	2 ⁴ ·5·7·13	3 ² ·809	2·11·331	7283	2 ² ·3·607	5·31·47	2·3643	3·7·347	2 ² ·911	37·197	728
729	2·3 ⁴ ·5	23·317	2 ² ·1823	3·11·13·17	2·7·521	5·1459	2 ² ·3·19	7297	2·41·89	3 ² ·811	729
730	2 ² ·5 ² ·73	7 ² ·149	2·3·1217	67·109	2 ² ·11·83	3·5·487	2·13·281	7307	2 ² ·3 ² ·7·29	7309	730
731	2·5·17·43	3·2437	2 ⁴ ·457	71·103	2·3·23·53	5·7·11·19	2 ² ·31·59	3 ² ·271	2·3659	13·563	731
732	2 ² ·3·5·61	7321	2·7·523	3·2441	2 ² ·1831	5 ² ·293	2·3 ² ·11·37	17·431	2 ² ·229	3·7·349	732
733	2·5·733	7331	2 ² ·3·13·47	7333	2·19·193	3 ² ·5·163	2 ² ·7·131	11·23·29	2·3·1223	41·179	733
734	2 ² ·5·367	3·2447	2·3671	7·1049	2 ⁴ ·3 ² ·17	5·13·113	2·3673	3·31·79	2 ² ·11·167	7349	734
735	2·3·5 ² ·7 ²	7351	2 ² ·919	3 ² ·19·43	2·3677	5·1471	2 ² ·3·613	7·1051	2·13·283	3·11·223	735
736	2 ² ·5·23	17·433	2·3 ² ·409	37·199	2 ² ·7·263	3·5·491	2·29·127	53·139	2 ² ·3·307	7369	736
737	2·5·11·67	3 ⁴ ·7·13	2 ² ·19·97	73·101	2·3·1229	5 ² ·59	2 ² ·461	3·2459	2·7·17·31	47·157	737
738	2 ² ·3 ² ·5·41	11 ² ·61	2·3691	3·23·107	2 ² ·13·71	5·7·211	2·3·1231	83·89	2 ² ·1847	3 ² ·821	738
739	2·5·739	19·389	2 ² ·3·7·11	7393	2·3697	3·5·17·29	2 ² ·43 ²	13·569	2·3 ² ·137	7 ² ·151	739
740	2 ² ·5 ² ·37	3·2467	2·3701	11·673	2 ² ·3·617	5·1481	2·7·23 ²	3 ² ·823	2 ⁴ ·463	31·239	740
741	2·3·5·13·19	7411	2 ² ·17·109	3·7·353	2·11·337	5·1483	2 ² ·3 ² ·103	7417	2·3709	3·2473	741
742	2 ² ·5·7·53	41·181	2·3·1237	13·571	2 ² ·29	3 ² ·5 ² ·11	2·47·79	7·1061	2 ² ·3·619	17·19·23	742
743	2·5·743	3·2477	2 ² ·929	7433	2·3 ² ·7·59	5·1487	2 ² ·11·13 ²	3·37·67	2·3719	43·173	743
744	2 ⁴ ·3·5·31	7·1063	2·61 ²	3 ² ·827	2 ² ·1861	5·1489	2·3·17·73	11·677	2 ² ·7 ² ·19	3·13·191	744
745	2·5 ² ·149	7451	2 ² ·3 ⁴ ·23	29·257	2·3727	3·5·7·71	2 ² ·233	7457	2·3·11·113	7459	745
746	2 ² ·5·373	3 ² ·829	2·7·13·41	17·439	2 ² ·3·311	5·1493	2·3733	3·19·131	2 ² ·1867	7·11·97	746
747	2·3 ² ·5·83	31·241	2 ⁴ ·467	3·47·53	2·37·101	5 ² ·13·23	2 ² ·3·7·89	7477	2·3739	3 ² ·277	747
748	2 ² ·5·11·17	7481	2·3·29·43	7·1069	2 ² ·1871	3·5·499	2·19·197	7487	2 ² ·3 ² ·13	7489	748
749	2·5·7·107	3·11·227	2 ² ·1873	59·127	2·3·1249	5·1499	2 ² ·937	3 ² ·7 ² ·17	2·23·163	7499	749

750	2 ² ·3·5 ⁴	13·577	2·11 ² ·31	3·41·61	2 ⁴ ·7·67	5·19·79	2 ³ ·139	7507	2 ² ·1877	3·2503	750
751	2 ⁵ ·751	7·29·37	2 ³ ·3·313	11·683	2·13·17 ²	3 ² ·5·167	2 ² ·1879	7517	2·3·7·179	73·103	751
752	2 ⁵ ·5·47	3·23·109	2·3761	7523	2 ² ·3 ² ·11·19	2·7·43	2·53·71	3·13·193	2 ³ ·941	7529	752
753	2·3·5·251	17·443	2 ² ·7·269	3 ⁵ ·31	2·3767	5·11·137	2 ⁴ ·3·157	7537	2·3769	3·7·359	753
754	2 ² ·5·13·29	7541	2·3 ² ·419	19·397	2 ² ·23·41	3·5·503	2·7 ² ·11	7547	2 ² ·3·17·37	7549	754
755	2 ⁵ ·151	3 ² ·839	2 ⁷ ·59	7·13·83	2·3·1259	5·1511	2 ² ·1889	3·11·229	2·3779	7559	755
756	2 ³ ·3 ² ·5·7	7561	2·19·199	3·2521	2 ² ·31·61	5·17·89	2·3·13·97	7·23·47	2 ⁴ ·11·43	3 ² ·29 ²	756
757	2·5·757	67·113	2 ² ·3·631	7573	2·7·541	3·5 ² ·101	2 ² ·947	7577	2 ³ ·421	11·13·53	757
758	2 ² ·5·379	3·7·19 ²	2·17·223	7583	2 ⁵ ·3·79	5·37·41	2·3793	3 ² ·281	2 ² ·7·271	7589	758
759	2·3·5·11·23	7591	2 ² ·13·73	3·2531	2·3797	5·7 ² ·31	2 ² ·3 ² ·211	71·107	2·29·131	3·17·149	759
760	2 ⁴ ·5 ² ·19	11·691	2·3·7·181	7603	2 ² ·1901	3 ² ·5·13 ²	2·3803	7607	2 ³ ·3·317	7·1087	760
761	2·5·761	3·43·59	2 ² ·11·173	23·331	2·3 ⁴ ·47	5·1523	2 ² ·7·17	3·2539	2·13·293	19·401	761
762	2 ² ·3·5·127	7621	2·37·103	3 ² ·7·11 ²	2 ² ·953	5 ² ·61	2·3·31·41	29·263	2 ² ·1907	3·2543	762
763	2·5·7·109	13·587	2 ⁴ ·3 ² ·53	17·449	2·11·347	3·5·509	2 ² ·23·83	7·1091	2·3·19·67	7639	763
764	2 ² ·5·191	3 ² ·283	2·3821	7643	2 ² ·3·7 ² ·13	5·11·139	2·3823	3·2549	2 ² ·239	7649	764
765	2·3 ² ·5 ² ·17	7·1093	2 ² ·1913	3·2551	2·43·89	5·1531	2 ² ·3·11·29	13·19·31	2·7·547	3 ² ·23·37	765
766	2 ² ·5·383	47·163	2·3·1277	79·97	2 ⁴ ·479	3·5·7·73	2·3833	11·17·41	2 ² ·3 ² ·71	7669	766
767	2·5·13·59	3·2557	2 ² ·7·137	7673	2·3·1279	5 ² ·307	2 ² ·19·101	3 ² ·853	2·11·349	7·1097	767
768	2 ² ·3·5	7681	2·23·167	3·13·197	2 ² ·17·113	5·29·53	2·3 ² ·7·61	7687	2 ² ·31 ²	3·11·233	768
769	2·5·769	7691	2 ² ·3·641	7 ² ·157	2·3847	3 ⁴ ·5·19	2 ⁴ ·13·37	43·179	2·3·1283	7699	769
770	2 ² ·5 ² ·7·11	3·17·151	2·3851	7703	2 ² ·3 ² ·107	5·23·67	2·3853	3·7·367	2 ² ·41·47	13·593	770
771	2·3·5·257	11·701	2 ² ·241	3 ² ·857	2·7·19·29	5·1543	2 ² ·3·643	7717	2·17·227	3·31·83	771
772	2 ² ·5·193	7·1103	2·3 ² ·11·13	7723	2 ² ·1931	3·5 ² ·103	2·3863	7727	2 ⁴ ·3·7·23	59·131	772
773	2·5·773	3 ² ·859	2 ² ·1933	11·19·37	2·3·1289	5·7·13·17	2 ² ·967	3·2579	2·53·73	71·109	773
774	2 ² ·3 ² ·5·43	7741	2·7 ² ·79	3·29·89	2 ² ·11 ²	5·1549	2·3·1291	61·127	2 ² ·13·149	3 ² ·7·41	774
775	2·5 ² ·31	23·337	2 ² ·3·17·19	7753	2·3877	3·5·11·47	2 ² ·7·277	7757	2·3 ² ·431	7759	775
776	2 ⁴ ·5·97	3·13·199	2·3881	7·1109	2 ² ·3·647	5·1553	2·11·353	3 ² ·863	2 ² ·971	17·457	776
777	2·3·5·7·37	19·409	2 ² ·29·67	3·2591	2·13 ² ·23	5 ² ·311	2 ² ·3 ⁵	7·11·101	2·3889	3·2593	777
778	2 ² ·5·389	31·251	2·3·1297	43·181	2 ² ·7·139	3 ² ·5·173	2·17·229	13·599	2 ² ·3·11·59	7789	778
779	2·5·19·41	3·7 ² ·53	2 ⁴ ·487	7793	2·3 ² ·433	5·1559	2 ² ·1949	3·23·113	2·7·557	11·709	779
780	2 ² ·3·5 ² ·13	29·269	2·47·83	3 ² ·17 ²	2 ² ·1951	5·7·223	2·3·1301	37·211	2 ⁷ ·61	3·19·137	780
781	2·5·11·71	73·107	2 ² ·3 ² ·7·31	13·601	2·3907	3·5·521	2 ² ·977	7817	2·3·1303	7·1117	781
782	2 ² ·5·17·23	3 ² ·11·79	2·3911	7823	2 ⁴ ·3·163	5 ² ·313	2·7·13·43	3·2609	2 ² ·19·103	7829	782
783	2·3 ² ·5·29	41·191	2 ² ·11·89	3·7·373	2·3917	5·1567	2 ² ·3·653	17·461	2·3919	3 ² ·13·67	783
784	2 ² ·5·7 ²	7841	2·3·1307	11·23·31	2 ² ·37·53	3·5·523	2·3923	7·19·59	2 ² ·3 ² ·109	47·167	784
785	2·5 ² ·157	3·2617	2 ² ·13·151	7853	2·3·7·11·17	5·1571	2 ⁴ ·491	3 ⁴ ·97	2·3929	29·271	785
786	2 ² ·3·5·131	7·1123	2·3931	3·2621	2 ² ·983	5·11 ² ·13	2·3 ² ·19·23	7867	2 ² ·7·281	3·43·61	786
787	2·5·787	17·463	2 ² ·3·41	7873	2·31·127	3 ² ·5 ² ·7	2 ² ·11·179	7877	2·3·13·101	7879	787
788	2 ² ·5·197	3·37·71	2·7·563	7883	2 ² ·3 ² ·73	5·19·83	2·3943	3·11·239	2 ⁴ ·17·29	7 ² ·23	788
789	2·3·5·263	13·607	2 ² ·1973	3 ² ·877	2·3947	5·1579	2 ² ·3·7·47	53·149	2·11·359	3·2633	789
790	2 ² ·5 ² ·79	7901	2·3 ² ·439	7·1129	2 ² ·13·19	3·5·17·31	2·59·67	7907	2 ² ·3·659	11·719	790
791	2·5·7·113	3 ² ·293	2 ² ·23·43	41·193	2·3·1319	5·1583	2 ² ·1979	3·7·13·29	2·37·107	7919	791
792	2 ⁴ ·3 ² ·5·11	89 ²	2·17·233	3·19·139	2 ² ·7·283	5 ² ·317	2·3·1321	7927	2 ² ·991	3 ² ·881	792
793	2·5·13·61	7·11·103	2 ² ·3·661	7933	2·3967	3·5·23 ²	2 ² ·31	7937	2·3 ⁴ ·7 ²	17·467	793
794	2 ² ·5·397	3·2647	2·11·19 ²	13 ² ·47	2 ² ·3·331	5·7·227	2·29·137	3 ² ·883	2 ² ·1987	7949	794
795	2·3·5 ² ·53	7951	2 ⁴ ·7·71	3·11·241	2·41·97	5·37·43	2 ² ·3 ² ·13·17	73·109	2·23·173	3·7·379	795
796	2 ² ·5·199	19·419	2·3·1327	7963	2 ² ·11·181	3 ² ·5·59	2·7·569	31·257	2 ² ·3·83	13·613	796
797	2·5·797	3·2657	2 ² ·1993	7·17·67	2·3 ² ·443	5 ² ·11·29	2 ² ·997	3·2659	2·3989	79·101	797
798	2 ² ·3·5·7·19	23·347	2·13·307	3 ² ·887	2 ⁴ ·499	5·1597	2·3·11 ³	7 ² ·163	2 ² ·1997	3·2663	798
799	2·5·17·47	61·131	2 ² ·3 ² ·37	7993	2·7·571	3·5·13·41	2 ² ·1999	11·727	2·3·31·43	19·421	799

Table 24.7
8000

Factorizations

8499

N	0	1	2	3	4	5	6	7	8	9	N
800	2 ⁵ ·5 ³	3 ² ·7·127	2·4001	53·151	2 ² ·3·23·29	5·1601	2·4003	3·17·157	2 ³ ·7·11·13	8009	800
801	2·3 ² ·5·89	8011	2 ² ·2003	3·2671	2·4007	5·7·229	2 ⁴ ·3·167	8017	2·19·211	3 ⁴ ·11	801
802	2 ² ·5·401	13·617	2·3·7·191	71·113	2 ³ ·17·59	3·5 ² ·107	2·4013	23·349	2 ² ·3 ² ·223	7·31·37	802
803	2·5·11·73	3·2677	2 ⁵ ·251	29·277	2·3·13·103	5·1607	2 ² ·7 ² ·41	3 ² ·19·47	2·4019	8039	803
804	2 ² ·3·5·67	11·17·43	2·4021	3·7·383	2 ² ·2011	5·1609	2·3 ² ·149	13·619	2 ⁴ ·503	3·2683	804
805	2·5 ² ·7·23	83·97	2 ² ·3·11·61	8053	2·4027	3 ² ·5·179	2 ³ ·19·53	7·1151	2·3·17·79	8059	805
806	2 ² ·5·13·31	3·2687	2·29·139	11·733	2 ⁷ ·3 ² ·7	5·1613	2·37·109	3·2689	2 ² ·2017	8069	806
807	2·3·5·269	7·1153	2 ³ ·1009	3 ³ ·13·23	2·11·367	5 ² ·17·19	2 ² ·3·673	41·197	2·7·577	3·2693	807
808	2 ⁴ ·5·101	8081	2·3 ² ·449	59·137	2 ² ·43·47	3·5·7 ² ·11	2·13·311	8087	2 ³ ·3·337	8089	808
809	2·5·809	3 ² ·29·31	2 ² ·7·17 ²	8093	2·3·19·71	5·1619	2 ⁵ ·11·23	3·2699	2·4049	7·13·89	809
810	2 ² ·3 ⁴ ·5 ²	8101	2·4051	3·37·73	2 ³ ·1013	5·1621	2·3·7·193	11 ² ·67	2 ² ·2027	3 ² ·17·53	810
811	2·5·811	8111	2 ⁴ ·3·13 ²	7·19·61	2·4057	3·5·541	2 ² ·2029	8117	2·3 ² ·11·41	23·353	811
812	2 ³ ·5·7·29	3·2707	2·31·131	8123	2 ² ·3·677	5 ⁴ ·13	2·17·239	3 ² ·7·43	2 ⁶ ·127	11·739	812
813	2·3·5·271	47·173	2 ² ·19·107	3·2711	2·7 ² ·83	5·1627	2 ² ·3 ² ·113	79·103	2·13·313	3·2713	813
814	2 ² ·5·11·37	7·1163	2·3·23·59	17·479	2 ⁴ ·509	3 ² ·5·181	2·4073	8147	2 ² ·3·7·97	29·281	814
815	2·5 ² ·163	3·11·13·19	2 ³ ·1019	31·263	2·3 ² ·151	5·7·233	2 ² ·2039	3·2719	2·4079	41·199	815
816	2 ⁵ ·3·5·17	8161	2·7·11·53	3 ² ·907	2 ² ·13·157	5·23·71	2·3·1361	8167	2 ³ ·1021	3·7·389	816
817	2·5·19·43	8171	2 ² ·3 ² ·227	11·743	2·61·67	3·5 ² ·109	2 ⁴ ·7·73	13·17·37	2·3·29·47	8179	817
818	2 ² ·5·409	3 ⁴ ·101	2·4091	7 ² ·167	2 ³ ·3·11·31	5·1637	2·4093	3·2729	2 ² ·23·89	19·431	818
819	2·3 ² ·5·7·13	8191	2 ¹³	3·2731	2·17·241	5·11·149	2 ² ·3·683	7·1171	2·4099	3 ² ·911	819
820	2 ³ ·5 ² ·41	59·139	2·3·1367	13·631	2 ² ·7·293	3·5·547	2·11·373	29·283	2 ⁴ ·3 ² ·19	8209	820
821	2·5·821	3·7·17·23	2 ² ·2053	43·191	2·3·37 ²	5·31·53	2 ³ ·13·79	3 ² ·11·83	2·7·587	8219	821
822	2 ² ·3·5·137	8221	2·4111	3·2741	2 ⁵ ·257	5 ² ·7·47	2·3 ² ·457	19·433	2 ² ·11 ² ·17	3·13·211	822
823	2·5·823	8231	2 ² ·3·7 ³	8233	2·23·179	3 ³ ·5·61	2 ² ·29·71	8237	2·3·1373	7·11·107	823
824	2 ⁴ ·5·103	3·41·67	2·13·317	8243	2 ² ·3 ² ·229	5·17·97	2·7·19·31	3·2749	2 ³ ·1031	73·113	824
825	2·3·5 ³ ·11	37·223	2 ² ·2063	3 ² ·7·131	2·4127	5·13·127	2 ² ·3·43	23·359	2·4129	3·2753	825
826	2 ² ·5·7·59	11·751	2·3 ² ·17	8263	2 ³ ·1033	3·5·19·29	2·4133	7·1181	2 ² ·3·13·53	8269	826
827	2·5·827	3 ² ·919	2 ⁴ ·11·47	8273	2·3·7·197	5 ² ·331	2 ² ·2069	3·31·89	2·4139	17·487	827
828	2 ³ ·3 ² ·5·23	7 ² ·13 ²	2·41·101	3·11·251	2 ² ·19·109	5·1657	2·3·1381	8287	2 ⁵ ·7·37	3 ² ·307	828
829	2·5·829	8291	2 ² ·3·691	8293	2·11·13·29	3·5·7·79	2 ² ·17·61	8297	2·3 ² ·461	43·193	829
830	2 ² ·5 ² ·83	3·2767	2·7·593	19 ² ·23	2 ⁴ ·3·173	5·11·151	2·4153	3 ² ·13·71	2 ² ·31·67	7·1187	830
831	2·3·5·277	8311	2 ³ ·1039	3·17·163	2·4157	5·1663	2 ² ·3 ² ·7·11	8317	2·4159	3·47·59	831
832	2 ² ·5·13	53·157	2·3·19·73	7·29·41	2 ² ·2081	3 ² ·5 ² ·37	2·23·181	11·757	2 ³ ·3·347	8329	832
833	2·5·7 ² ·17	3·2777	2 ² ·2083	13·641	2·3 ² ·463	5·1667	2 ⁴ ·521	3·7·397	2·11·379	31·269	833
834	2 ² ·3·5·139	19·439	2·43·97	3 ⁴ ·103	2 ³ ·7·149	5·1669	2·3·13·107	17·491	2 ² ·2087	3·11 ² ·23	834
835	2·5 ² ·167	7·1193	2 ⁵ ·3 ² ·29	8353	2·4177	3·5·557	2 ² ·2089	61·137	2·3·7·199	13·643	835
836	2 ² ·5·11·19	3 ² ·929	2·37·113	8363	2 ² ·3·17·41	5·7·239	2·47·89	3·2789	2 ⁴ ·523	8369	836
837	2·3 ² ·5·31	11·761	2 ² ·7·13·23	3·2791	2·53·79	5 ² ·67	2 ³ ·3·349	8377	2·59·71	3 ² ·7 ² ·19	837
838	2 ² ·5·419	17 ² ·29	2·3·11·127	83·101	2 ² ·131	3·5·13·43	2·7·599	8387	2 ² ·3 ² ·233	8389	838
839	2·5·839	3·2797	2 ³ ·1049	7·11·109	2·3·1399	5·23·73	2 ² ·2099	3 ² ·311	2·13·17·19	37·227	839
840	2 ⁴ ·3·5 ² ·7	31·271	2·4201	3·2801	2 ² ·11·191	5·41 ²	2·3 ² ·467	7·1201	2 ³ ·1051	3·2803	840
841	2·5·29 ²	13·647	2·3·701	47·179	2·7·601	3 ² ·5·11·17	2 ⁵ ·263	19·443	2·3·23·61	8419	841
842	2 ² ·5·421	3·7·401	2·4211	8423	2 ³ ·3·13	5 ² ·337	2·11·383	3·53 ²	2 ² ·7 ² ·43	8429	842
843	2·3·5·281	8431	2 ⁴ ·17·31	3 ² ·937	2·4217	5·7·241	2 ² ·3·19·37	11·13·59	2·4219	3·29·97	843
844	2 ² ·5·211	23·367	2·3 ² ·7·67	8443	2 ² ·2111	3·5·563	2·41·103	8447	2 ² ·3·11	7·17·71	844
845	2·5 ² ·13 ²	3 ² ·313	2 ² ·2113	79·107	2·3·1409	5·19·89	2 ² ·7·151	3·2819	2·4229	11·769	845
846	2 ² ·3 ² ·5·47	8461	2·4231	3·7·13·31	2 ⁴ ·23 ²	5·1693	2·3·17·83	8467	2 ² ·29·73	3 ² ·941	846
847	2·5·7·11 ²	43·197	2 ² ·3·353	37·229	2·19·223	3·5 ² ·113	2 ² ·13·163	7 ² ·173	2·3 ² ·157	61·139	847
848	2 ² ·5·53	3·11·257	2·4241	17·499	2 ² ·3·7·101	5·1697	2·4243	3 ² ·23·41	2 ³ ·1061	13·653	848
849	2·3·5·283	7·1213	2 ² ·11·193	3·19·149	2·31·137	5·1699	2 ⁴ ·3 ² ·59	29·293	2·7·607	3·2833	849

850	2 ³ ·5 ² ·17	8501	2·3·13·109	11·773	2 ³ ·1063	3 ² ·5·7	2·4253	47·181	2 ³ ·3·709	67·127	850
851	2·5·23·37	3·2837	2 ⁴ ·7·19	8513	2·3 ² ·11·43	5·13·131	2 ² ·2129	3·17·167	2·4259	7·1217	851
852	2 ³ ·3·5·71	8521	2·4261	3 ² ·947	2 ² ·2131	5 ² ·11·31	2·3·7 ² ·29	8527	2 ⁴ ·13·41	3·2843	852
853	2·5·853	19·449	2 ³ ·3 ² ·79	7·23·53	2·17·251	3·5·569	2 ³ ·11·97	8537	2·3·1423	8539	853
854	2 ² ·5·7·61	3 ² ·13·73	2·4271	8543	2 ⁵ ·3·89	5·1709	2·4273	3·7·11·37	2 ² ·2137	83·103	854
855	2·3 ² ·5 ² ·19	17·503	2 ³ ·1069	3·2851	2·7·13·47	5·29·59	2 ² ·3·23·31	43·199	2·11·389	3 ³ ·317	855
856	2 ⁴ ·5·107	7·1223	2·3·1427	8563	2 ² ·2141	3·5·571	2·4283	13·659	2 ³ ·3 ² ·7·17	11·19·41	856
857	2·5·857	3·2857	2 ² ·2143	8573	2·3·1429	5 ² ·7 ³	2·67	3 ² ·953	2·4289	23·373	857
858	2 ² ·3·5·11·13	8581	2·7·613	3·2861	2 ³ ·29·37	5·17·101	2·3 ⁴ ·53	31·277	2 ² ·19·113	3·7·409	858
859	2·5·859	11 ² ·71	2 ⁴ ·3·179	13·661	2·4297	3 ² ·5·191	2 ² ·7·307	8597	2·3·1433	8599	859
860	2 ³ ·5 ² ·43	3·47·61	2·11·17·23	7·1229	2 ² ·3 ² ·239	5·1721	2·13·331	3·19·151	2 ⁵ ·269	8609	860
861	2·3·5·7·41	79·109	2 ² ·2153	3 ³ ·11·29	2·59·73	5·1723	2 ³ ·3·359	7·1231	2·31·139	3·13 ² ·17	861
862	2 ⁵ ·431	37·233	2·3 ⁴ ·479	8623	2 ⁴ ·7 ² ·11	3·5 ² ·23	2·19·227	8627	2 ² ·3·719	8629	862
863	2·5·863	3 ² ·7·137	2 ³ ·13·83	89·97	2·3·1439	5·11·157	2 ² ·17·127	3·2879	2·7·617	53·163	863
864	2 ⁶ ·3 ² ·5	8641	2·29·149	3·43·67	2 ² ·2161	5·7·13·19	2·3·11·131	8647	2 ³ ·23·47	3 ² ·31 ²	864
865	2·5 ² ·173	41·211	2 ² ·3·7·103	17·509	2·4327	3·5·577	2 ⁴ ·541	11·787	2·3 ² ·13·37	7·1237	865
866	2 ² ·5·433	3·2887	2·61·71	8663	2 ³ ·3·19 ²	5·1733	2·7·619	3 ⁴ ·107	2 ² ·11·197	8669	866
867	2·3·5·17 ²	13·23·29	2 ⁶ ·271	3·7 ² ·59	2·4337	5 ² ·347	2 ² ·3 ² ·241	8677	2·4339	3·11·263	867
868	2 ³ ·5·7·31	8681	2·3·1447	19·457	2 ² ·13·167	3 ² ·5·193	2·43·101	7·17·73	2 ⁴ ·3·181	8689	868
869	2·5·11·79	3·2897	2 ² ·41·53	8693	2·3 ² ·7·23	5·37·47	2 ³ ·1087	3·13·223	2·4349	8699	869
870	2 ² ·3·5 ² ·29	7·11·113	2·19·229	3 ² ·967	2 ⁹ ·17	5·1741	2·3·1451	8707	2 ² ·7·311	3·2903	870
871	2·5·13·67	31·281	2 ³ ·3 ² ·11 ²	8713	2·4357	3·5·7·83	2 ² ·2179	23·379	2·3·1453	8719	871
872	2 ⁴ ·5·109	3 ³ ·17·19	2·7 ² ·89	11·13·61	2 ² ·3·727	5 ² ·349	2·4363	3·2909	2 ² ·1091	7·29·43	872
873	2·3 ² ·5·97	8731	2 ² ·37·59	3·41·71	2·11·397	5·1747	2 ⁵ ·3·7·13	8737	2·17·257	3 ² ·971	873
874	2 ² ·5·19·23	8741	2·3·31·47	7·1249	2 ³ ·1093	3·5·11·53	2·4373	8747	2 ² ·3 ⁷	13·673	874
875	2·5 ⁴ ·7	3·2917	2 ⁴ ·547	8753	2·3·1459	5·17·103	2 ² ·11·199	3 ² ·7·139	2·29·151	19·461	875
876	2 ³ ·3·5·73	8761	2·13·337	3·23·127	2 ² ·7·313	5·1753	2·3 ² ·487	11·797	2 ⁶ ·137	3·37·79	876
877	2·5·877	7 ² ·179	2 ² ·3·17·43	31·283	2·41·107	3 ³ ·5 ² ·13	2 ³ ·1097	67·131	2·3·7·11·19	8779	877
878	2 ² ·5·439	3·2927	2·4391	8783	2 ⁴ ·3 ² ·61	5·7·251	2·23·191	3·29·101	2 ² ·13 ³	11·17·47	878
879	2·3·5·293	59·149	2 ³ ·7·157	3 ² ·977	2·4397	5·1759	2 ² ·3·733	19·463	2·53·83	3·7·419	879
880	2 ³ ·5 ² ·11	13·677	2·3 ³ ·163	8803	2 ² ·31·71	3·5·587	2·7·17·37	8807	2 ³ ·3·367	23·383	880
881	2·5·881	3 ² ·11·89	2 ² ·2203	7·1259	2·3·13·113	5·41·43	2 ⁴ ·19·29	3·2939	2·4409	8819	881
882	2 ² ·3 ² ·5·7 ²	8821	2·11·401	3·17·173	2 ³ ·1103	5 ² ·353	2·3·1471	7·13·97	2 ² ·2207	3 ⁴ ·109	882
883	2·5·883	8831	2 ³ ·3·23	11 ² ·73	2·7·631	3·5·19·31	2 ⁴ ·7 ²	8837	2·3 ² ·491	8839	883
884	2 ³ ·5·13·17	3·7·421	2·4421	37·239	2 ² ·3·11·67	5·29·61	2·4423	3 ² ·983	2 ⁴ ·7·79	8849	884
885	2·3·5 ² ·59	53·167	2 ² ·2213	3·13·227	2·19·233	5·7·11·23	2 ³ ·3 ² ·41	17·521	2·43·103	3·2953	885
886	2 ² ·5·443	8861	2·3·7·211	8863	2 ⁶ ·277	3 ² ·5·197	2·11·13·31	8867	2 ² ·3·739	7 ² ·181	886
887	2·5·887	3·2957	2 ² ·1109	19·467	2·3 ² ·17·29	5 ² ·71	2 ² ·7·317	3·11·269	2·23·193	13·683	887
888	2 ² ·3·5·37	83·107	2·4441	3 ² ·7·47	2 ² ·2221	5·1777	2·3·1481	8887	2 ³ ·11·101	3·2963	888
889	2·5·7·127	17·523	2 ² ·3 ² ·13·19	8893	2·4447	3·5·593	2 ⁶ ·139	7·31·41	2·3·1483	11·809	889
890	2 ² ·5 ² ·89	3 ² ·23·43	2·4451	29·307	2 ² ·3·7·53	5·13·137	2·61·73	3·2969	2 ² ·17·131	59·151	890
891	2·3 ⁴ ·5·11	7·19·67	2 ⁴ ·557	3·2971	2·4457	5·1783	2 ² ·3·743	37·241	2·7 ³ ·13	3 ² ·991	891
892	2 ³ ·5·223	11·811	2·3·1487	8923	2 ² ·23·97	3·5 ² ·7·17	2·4463	79·113	2 ² ·3 ² ·31	8929	892
893	2·5·19·47	3·13·229	2 ² ·7·11·29	8933	2·3·1489	5·1787	2 ³ ·1117	3 ² ·331	2·41·109	7·1277	893
894	2 ² ·3·5·149	8941	2·17·263	3·11·271	2 ⁴ ·13·43	5·1789	2·3 ² ·7·71	23·389	2 ² ·2237	3·19·157	894
895	2·5 ² ·179	8951	2 ³ ·3·373	7·1279	2·11 ² ·37	3 ² ·5·199	2 ² ·2239	13 ² ·53	2·3·1493	17 ² ·31	895
896	2 ³ ·5·7	3·29·103	2·4481	8963	2 ² ·3 ² ·83	5·11·163	2·4483	3·7 ² ·61	2 ³ ·19·59	8969	896
897	2·3·5·13·23	8971	2 ² ·2243	3 ² ·997	2·7·641	5 ² ·359	2 ⁴ ·3·11·17	47·191	2·67 ²	3·41·73	897
898	2 ² ·5·449	7·1283	2·3 ² ·499	13·691	2 ³ ·1123	3·5·599	2·4493	11·19·43	2 ² ·3·7·107	89·101	898
899	2·5·29·31	3 ² ·37	2 ⁵ ·281	17·23 ²	2·3·1499	5·7·257	2 ² ·13·173	3·2999	2·11·409	8999	899

8500

COMBINATORIAL ANALYSIS
FactorizationsTable 24.7
8999

861

Table 24.7
9000

Factorizations

N	0	1	2	3	4	5	6	7	8	9	N
900	2 ³ ·3 ⁵	9001	2·7·643	3·3001	2 ² ·2251	5·1801	2·3·19·79	9007	2 ⁴ ·563	3 ² ·7·11·13	900
901	2 ⁵ ·17·53	9011	2 ² ·3·751	9013	2 ² ·4607	3·5·601	2 ³ ·7 ² ·23	71·127	2 ³ ·167	29·311	901
902	2 ² ·5·11·41	3·31·97	2·13·347	7·1289	2 ³ ·3·47	5 ² ·19 ²	2·4513	3 ² ·17·59	2 ² ·37·61	9029	902
903	2 ³ ·5·7·43	11·821	2 ² ·1129	3·3011	2·4517	5·13·139	2 ² ·3 ² ·251	7·1291	2 ² ·4519	3·23·131	903
904	2 ⁴ ·5·113	9041	2 ³ ·11·137	9043	2 ² ·7·17·19	3 ² ·5·67	2·4523	83·109	2 ² ·3·13·29	9049	904
905	2 ² ·5 ² ·181	3·7·431	2 ² ·31·73	11·823	2 ² ·3 ² ·503	5·1811	2 ² ·283	3·3019	2·7·647	9059	905
906	2 ² ·3·5·151	13·17·41	2 ² ·23·197	3 ² ·19·53	2 ² ·11·103	5·7·37	2·3·1511	9067	2 ² ·2267	3·3023	906
907	2 ² ·5·907	47·193	2 ⁴ ·3·7	43·211	3·3·49	2 ² ·2269	2 ² ·2269	29·313	2·3·17·89	7·1297	907
908	2 ² ·5·227	3 ² ·1009	2 ² ·19·239	31·293	2 ² ·3·757	5·23·79	2·7·11·59	3·13·233	2 ² ·71	61·149	908
909	2 ² ·3 ² ·5·101	9091	2 ² ·2273	3·7·433	2·4547	5·17·107	2 ² ·3·379	11·827	2·4549	3 ² ·337	909
910	2 ² ·5 ² ·7·13	19·479	2·3·37·41	9103	2 ² ·569	3·5·607	2·29·157	7·1301	2 ² ·3 ² ·11·23	9109	910
911	2 ² ·5·911	3·3037	2 ² ·17·67	13·701	2·3·7 ² ·31	5·1823	2 ² ·43·53	3 ² ·1013	2·47·97	11·829	911
912	2 ² ·3·5·19	7·1303	2·4561	3·3041	2 ² ·2281	5 ² ·73	2 ² ·3 ² ·13 ²	9127	2 ² ·1623	3·17·179	912
913	2 ² ·5·11·83	23·397	2 ² ·3·761	9133	2·4567	3 ² ·5·7·29	2 ² ·571	9137	2 ² ·3·1523	13·19·37	913
914	2 ² ·5·457	3·11·277	2·7·653	41·223	2 ² ·3 ² ·127	5·31·59	2 ² ·17·269	3·3049	2 ² ·2287	7·1307	914
915	2 ² ·3·5 ² ·61	9151	2 ² ·11·13	3 ² ·113	2·23·199	5·1831	2 ² ·3·7·109	9157	2·19·241	3·43·71	915
916	2 ² ·5·229	9161	2 ² ·3 ² ·509	7 ² ·11·17	2 ² ·29·79	3·5·13·47	2·4583	89·103	2 ² ·3·191	53·173	916
917	2 ² ·5·7·131	3 ² ·1019	2 ² ·2293	9173	2·3·11·139	5 ² ·367	2 ² ·31·37	3·7·19·23	2·13·353	67·137	917
918	2 ² ·3 ² ·5·17	9181	2·4591	3·3061	2 ² ·7·41	5·11·167	2 ² ·3·1531	9187	2 ² ·2997	3 ² ·1021	918
919	2 ² ·5·919	7·13·101	2 ² ·3·383	29·317	2·4597	3·5·613	2 ² ·11 ² ·19	17·541	2 ² ·3·7·73	9199	919
920	2 ² ·5 ² ·23	3·3067	2·43·107	9203	2 ² ·3·13·59	5·7·263	2·4603	3 ² ·11·31	2 ² ·1151	9209	920
921	2 ² ·3·5·307	61·151	2 ² ·7 ² ·47	3·37·83	2·17·271	5·19·97	2 ² ·10 ² ·3 ²	13·709	2·11·419	3·7·439	921
922	2 ² ·5·7·131	9221	2 ² ·29·53	23·401	2 ² ·1163	3 ² ·5 ² ·41	2·7·659	9227	2 ² ·3·769	11·839	922
923	2 ² ·5·13·71	3·17·181	2 ² ·577	7·1319	2 ² ·3 ² ·19	5·1847	2 ² ·2309	3·3079	2·31·149	9239	923
924	2 ² ·3·5·7·11	9241	2·4621	3 ² ·13·79	2 ² ·2311	5·43 ²	2·3·23·67	7·1321	2 ² ·17 ²	3·3083	924
925	2 ² ·5 ² ·37	11·29 ²	2 ² ·3 ² ·257	19·487	2·7·661	3·5·617	2 ² ·13·89	9257	2·3·1543	47·197	925
926	2 ² ·5·463	73 ²	2·11·421	59·157	2 ² ·3·193	5·17·109	2·41·113	3·3089	2 ² ·7·331	13·23·31	926
927	2 ² ·3·5·103	73·127	2 ² ·19·61	3·11·281	2·4637	3·7·53	2 ² ·3·773	9277	2 ² ·11·53	3 ² ·1031	927
928	2 ² ·5·29	9281	2·3·7·13·17	9283	2 ² ·11·211	3·5·619	2·4643	37·251	2 ² ·7·23·29	3·11·283	928
929	2 ² ·5·929	3·19·163	2 ² ·23·101	9293	2·3·1549	5·11·13 ²	2 ² ·7·83	3 ² ·1033	2·4649	17·547	929
930	2 ² ·3·5 ² ·31	71·131	2·4651	3·7·443	2 ² ·1163	5·1861	2 ² ·3 ² ·11·47	41·227	2 ² ·13·179	3·29·107	930
931	2 ² ·5·7 ² ·19	9311	2 ² ·3·97	67·139	2·4657	3 ² ·5·23	2 ² ·17·137	7·113	2·3·1553	9319	931
932	2 ² ·5·233	3·13·239	2·59·79	9323	2 ² ·3 ² ·7·37	5 ² ·373	2·4663	3·3109	2 ² ·11·53	19·491	932
933	2 ² ·3·5·311	7·31·43	2 ² ·2333	3 ² ·17·61	2·13·359	5·1867	2 ² ·3·389	9337	2·7·23·29	3·11·283	933
934	2 ² ·5·467	9341	2 ² ·3 ² ·173	9343	2 ² ·73	3·5·7·89	2·4673	13·719	2 ² ·3·19·41	9349	934
935	2 ² ·5·11·17	3 ² ·1039	2 ² ·7·167	47·199	2·3·1559	5·1871	2 ² ·2339	3·3119	2·4679	7 ² ·191	935
936	2 ² ·3 ² ·5·13	11·23·37	2·31·151	3·3121	2 ² ·2341	5·1873	2 ² ·3·7·223	17·19·29	2 ² ·1171	3 ² ·347	936
937	2 ² ·5·937	9371	2 ² ·3·11·71	7·13·103	2·43·109	3·5 ²	2 ² ·293	9377	2 ² ·3 ² ·521	83·113	937
938	2 ² ·5·7·67	3·53·59	2·4691	11·853	2 ² ·3·17·23	5·1877	2·13·19 ²	3 ² ·7·149	2 ² ·2347	41·229	938
939	2 ² ·3·5·313	9391	2 ² ·587	3·31·101	2·7·11·61	5·1879	2 ² ·3 ² ·29	9397	2·37·127	3·13·241	939
940	2 ² ·5 ² ·47	7·17·79	2·3·1567	9403	2 ² ·2351	3 ² ·5·11·19	2·4703	23·409	2 ² ·3·7 ²	97 ²	940
941	2 ² ·5·941	3·3137	2 ² ·13·181	9413	2 ² ·523	5·7·269	2 ² ·11·107	3·43·73	2·17·277	9419	941
942	2 ² ·3·5·157	9421	2·7·673	3 ² ·349	2 ² ·19·31	5 ² ·13·29	2·3·1571	11·857	2 ² ·2357	3·7·449	942
943	2 ² ·5·23·41	9431	2 ² ·3 ² ·131	9433	2·53·89	3·5·17·37	2 ² ·7·337	9437	2·3·11 ² ·13	9439	943
944	2 ² ·5·59	3 ² ·1049	2·4721	7·19·71	2 ² ·3·787	5·1889	2·4723	3·47·67	2 ² ·1181	11·859	944
945	2 ² ·3 ² ·5 ² ·7	13·727	2 ² ·17·139	3·23·137	2·29·163	5·31·61	2 ² ·3·197	7 ² ·193	2·4729	3 ² ·1051	945
946	2 ² ·5·11·43	9461	2·3·19·83	9463	2 ² ·7·13 ²	3·5·631	2·4733	9467	2 ² ·3 ² ·263	17·557	946
947	2 ² ·5·947	3·7·11·41	2 ² ·37	3 ² ·379	2·3·1579	5 ² ·379	2 ² ·23·103	3 ² ·13	2·7·677	9479	947
948	2 ² ·3·5·79	19·499	2·11·431	3·29·109	2 ² ·2371	5·7·271	2 ² ·17·31	53·179	2 ² ·593	3·3163	948
949	2 ² ·5·13·73	9491	2 ² ·3·7·113	11·863	2·47101	3 ² ·5·211	2 ² ·1187	9497	2·3·1583	7·23·59	949

950	2 ⁵ .5 ¹⁹	3-3167	2-4751	13-17-43	2 ⁵ .3 ¹¹	5-1901	2-7 ⁹ .97	3-3169	2 ² .2377	37-257	950
951	2-3-5-317	9511	2 ² .29-41	3 ² .7-151	2-67-71	5-11-173	2 ² .3-13-61	31-307	2-4759	3-19-167	951
952	2 ⁴ .5-7-17	9521	2-3 ² .23 ²	89-107	2 ² .2381	3-5 ² .127	2-11-433	7-1361	2 ² .3-397	13-733	952
953	2-5-953	3 ³ .353	2 ² .2383	9533	2-3-7-227	5-1907	2 ² .149	3-11-17 ²	2-19-251	9539	953
954	2 ² .3 ² .5-53	7-29-47	2-13-367	3-3181	2 ² .1193	5-23-83	2-3-37-43	9547	2 ² .7-11-31	3 ² .1061	954
955	2-5 ² .191	9551	2 ⁴ .3-199	41-233	2-17-281	3-5-7 ² .13	2 ² .2389	19-503	2-3 ⁴ .59	11 ² .79	955
956	2 ² .5-239	3-3187	2-7-683	73-131	2 ² .3-797	5-1913	2-4783	3 ² .1063	2 ² .13-23	7-1367	956
957	2-3-5-11-29	17-563	2 ² .2393	3-3191	2-4787	5 ² .383	2 ² .3 ² .7-19	61-157	2-4789	3-31-103	957
958	2 ² .5-479	11-13-67	2-3-1597	7-37 ²	2 ⁴ .599	3 ² .5-71	2-4793	9587	2 ² .3-17-47	43-223	958
959	2-5-7-137	3-23-139	2 ² .11-109	53-181	2-3 ² .13-41	5-19-101	2 ² .2399	3-7-457	2-4799	29-331	959
960	2 ² .3-5 ²	9601	2-4801	3 ² .11-97	2 ² .7 ⁴	5-17-113	2-3-1601	13-739	2 ² .1201	3-3203	960
961	2-5-31 ²	7-1373	2 ² .3 ² .89	9613	2-11-19-23	3-5-641	2 ⁴ .601	59-163	2-3-7-229	9619	961
962	2 ² .5-13-37	3 ² .1069	2-17-283	9623	2 ² .3-401	5 ² .7-11	2-4813	3-3209	2 ² .29-83	9629	962
963	2-3 ² .5-107	9631	2 ² .7-43	3-13 ² .19	2-4817	5-41-47	2 ² .3-11-73	23-419	2-61-79	3 ² .7-17	963
964	2 ² .5-241	31-311	2-3-1607	9643	2 ² .2411	3-5-643	2-7-13-53	11-877	2 ² .3 ² .67	9649	964
965	2-5 ² .193	3-3217	2 ² .19-127	7 ² .197	2-3-1609	5-1931	2 ² .17-71	3 ² .29-37	2-11-439	13-743	965
966	2 ² .3-5-7-23	9661	2-4831	3-3221	2 ² .151	5-1933	2-3 ² .179	7-1381	2 ² .2417	3-11-293	966
967	2-5-967	19-509	2 ² .3-13-31	17-569	2-7-691	3 ² .5 ² .43	2 ² .41-59	9677	2-3-1613	9679	967
968	2 ⁴ .5-11 ²	3-7-461	2-47-103	23-421	2 ² .3 ² .269	5-13-149	2-29-167	3-3229	2 ² .7-173	9689	968
969	2-3-5-17-19	11-881	2 ² .2423	3 ² .359	2-37-131	5-7-277	2 ² .3-101	9697	2-13-373	3-53-61	969
970	2 ² .5 ² .97	89-109	2-3 ² .7 ² .11	31-313	2 ² .1213	3-5-647	2-23-211	17-571	2 ² .3-809	7-19-73	970
971	2-5-971	3 ² .13-83	2 ⁴ .607	11-883	2-3-1619	5-29-67	2 ² .7-347	3-41-79	2-43-113	9719	971
972	2 ² .3 ² .5	9721	2-4861	3-7-463	2 ² .11-13-17	5 ² .389	2-3-1621	71-137	2 ² .19	3 ² .23-47	972
973	2-5-7-139	37-263	2 ² .3-811	9733	2-31-157	3-5-11-59	2 ² .1217	7-13-107	2-3 ² .541	9739	973
974	2 ² .5-487	3-17-191	2-4871	9743	2 ² .3-7-29	5-1949	2-11-443	3 ² .19 ²	2 ² .2437	9749	974
975	2-3-5 ² .13	7 ² .199	2 ² .23-53	3-3251	2-4877	5-1951	2 ² .3 ² .271	11-887	2-7-17-41	3-3253	975
976	2 ² .5-61	43-227	2-3-1627	13-751	2 ² .2441	3 ² .5-7-31	2-19-257	9767	2 ² .3-11-37	9769	976
977	2-5-977	3-3257	2 ² .7-349	29-337	2 ² .3 ² .181	5 ² .17-23	2 ² .13-47	3-3259	2-4889	7-11-127	977
978	2 ² .3-5-163	9781	2-67-73	3 ² .1087	2 ² .1223	5-19-103	2-3-7-233	9787	2 ² .2447	3-13-251	978
979	2-5-11-89	9791	2 ² .3 ² .17	7-1399	2-59-83	3-5-653	2 ² .31-79	97-101	2-3-23-71	41-239	979
980	2 ² .5 ² .7 ²	3 ⁴ .11 ²	2-13 ² .29	9803	2 ² .3-19-43	5-37-53	2-4903	3-7-467	2 ⁴ .613	17-577	980
981	2-3 ² .5-109	9811	2 ² .11-223	3-3271	2-7-701	5-13-151	2 ² .3-409	9817	2-4909	3 ² .1091	981
982	2 ² .5-491	7-23-61	2-3-1637	11-19-47	2 ² .307	3-5 ² .131	2-17 ²	31-317	2 ² .3 ² .7-13	9829	982
983	2-5-983	3-29-113	2 ² .1229	9833	2-3-11-149	5-7-281	2 ² .2459	3 ² .1093	2-4919	9839	983
984	2 ⁴ .3-5-41	13-757	2-7-19-37	3-17-193	2 ² .23-107	5-11-179	2-3 ² .547	43-229	2 ² .1231	3-7 ² .67	984
985	2-5 ² .197	9851	2 ² .3-821	59-167	2-13-379	3 ² .5-73	2 ² .7-11	9857	2-3-31-53	9859	985
986	2 ² .5-17-29	3-19-173	2-4931	7-1409	2 ² .3 ² .137	5-1973	2-4933	3-11-13-23	2 ² .2467	71-139	986
987	2-3-5-7-47	9871	2 ⁴ .617	3 ² .1097	2-4937	5 ² .79	2 ² .3-823	7-17-83	2-11-449	3-37-89	987
988	2 ² .5-13-19	41-241	2-3 ⁴ .61	9883	2 ² .7-353	3-5-659	2-4943	9887	2 ² .3-103	11-29-31	988
989	2-5-23-43	3 ² .7-157	2 ² .2473	13-761	2-3-17-97	5-1979	2 ² .1237	3-3299	2-7 ² .101	19-521	989
990	2 ² .3 ² .5 ² .11	9901	2-4951	3-3301	2 ⁴ .619	5-7-283	2-3-13-127	9907	2 ² .2477	3 ² .367	990
991	2-5-991	11-17-53	2 ² .3-7-59	23-431	2-4957	3-5-661	2 ² .37-67	47-211	2-3 ² .19-29	7-13-109	991
992	2 ² .5-31	3-3307	2-11 ² .41	9923	2 ² .3-827	5 ² .397	2-7-709	3 ² .1103	2 ² .17-73	9929	992
993	2-3-5-331	9931	2 ² .13-191	3-7-11-43	2-4967	5-1987	2 ² .3 ² .23	19-523	2-4969	3-3313	993
994	2 ² .5-7-71	9941	2-3-1657	61-163	2 ² .11-113	3 ² .5-13-17	2-4973	7 ² .29	2 ² .3-829	9949	994
995	2-5 ² .199	3-31-107	2 ² .311	37-269	2-3 ² .7-79	5-11-181	2 ² .19-131	3-3319	2-13-383	23-433	995
996	2 ² .3-5-83	7-1423	2-17-293	3 ² .41	2 ² .47-53	5-1993	2-3-11-151	9967	2 ⁴ .7-89	3-3323	996
997	2-5-997	13 ² .59	2 ² .3 ² .277	9973	2-4987	3-5 ² .7-19	2 ² .29-43	11-907	2-3-1663	17-587	997
998	2 ² .5-499	3 ² .1109	2-7-23-31	67-149	2 ² .3-13	5-1997	2-4993	3-3329	2 ² .11-227	7-1427	998
999	2-3 ² .5-37	97-103	2 ² .1249	3-3331	2-19-263	5-1999	2 ² .3-7 ² .17	13-769	2-4999	3 ² .11-101	999

Table 24.8 Primitive Roots, Factorization of $p-1$

g, G denote the least positive and least negative (respectively) primitive roots of p . ϵ denotes whether 10, -10 both or neither are primitive roots.

p	$p-1$	g	$-G$	ϵ	p	$p-1$	g	$-G$	ϵ	p	$p-1$	g	$-G$	ϵ
3	2	2	1	-10	359	2.179	7	2	-10	821	2 ² .5.41	2	2	± 10
5	2 ²	2	2	-----	367	2.3.61	6	2	10	823	2.3.137	3	2	10
7	2.3	3	2	10	373	2 ² .3.31	2	2	-----	827	2.7.59	2	3	-10
11	2.5	2	3	-----	379	2.3 ² .7	2	4	10	829	2 ² .3 ² .23	2	2	-----
13	2 ² .3	2	2	-----	383	2.191	5	2	10	839	2.419	11	2	-10
17	2 ⁴	3	3	± 10	389	2 ² .97	2	2	± 10	853	2 ² .3.71	2	2	-----
19	2.3 ²	2	4	10	397	2 ² .3 ² .11	5	5	-----	857	2 ³ .107	3	5	± 10
23	2.11	5	2	10	401	2 ⁴ .5 ²	3	3	-----	859	2.3.11.13	2	4	-----
29	2 ² .7	2	2	± 10	409	2 ³ .3.17	21	2	-----	863	2.431	5	2	10
31	2.3.5	3	7	-10	419	2.11.19	2	3	10	877	2 ² .3.73	2	2	-----
37	2 ² .3 ²	2	2	-----	421	2 ² .3.5.7	2	2	-----	881	2 ⁴ .5.11	3	3	-----
41	2 ³ .5	6	6	-----	431	2.5.43	7	5	-10	883	2.3 ² .7 ²	2	4	-10
43	2.3.7	3	9	-10	433	2 ⁴ .3 ³	5	5	± 10	887	2.443	5	2	10
47	2.23	5	2	10	439	2.3.73	15	5	-10	907	2.3.151	2	4	-----
53	2 ² .13	2	2	-----	443	2.13.17	2	3	-10	911	2.5.7.13	17	3	-10
59	2.29	2	3	10	449	2 ⁶ .7	3	3	-----	919	2.3 ³ .17	7	5	-10
61	2 ² .3.5	2	2	± 10	457	2 ³ .3.19	13	13	-----	929	2 ⁵ .29	3	3	-----
67	2.3.11	2	4	-10	461	2 ² .5.23	2	2	± 10	937	2 ³ .3 ² .13	5	5	± 10
71	2.5.7	7	2	-10	463	2.3.7.11	3	2	-----	941	2 ² .5.47	2	2	± 10
73	2 ³ .3 ²	5	5	-----	467	2.233	2	3	-10	947	2.11.43	2	3	-10
79	2.3.13	3	2	-----	479	2.239	13	2	-10	953	2 ³ .7.17	3	3	± 10
83	2.41	2	3	-10	487	2.3 ³	3	2	10	967	2.3.7.23	5	2	-----
89	2 ³ .11	3	3	-----	491	2.5.7 ²	2	4	10	971	2.5.97	6	3	10
97	2 ⁵ .3	5	5	± 10	499	2.3.83	7	5	10	977	2 ⁴ .61	3	3	± 10
101	2 ² .5 ²	2	2	-----	503	2.251	5	2	10	983	2.491	5	2	10
103	2.3.17	5	2	-----	509	2 ² .127	2	2	± 10	991	2.3 ² .5.11	6	2	-10
107	2.53	2	3	-10	521	2 ³ .5.13	3	3	-----	997	2 ² .3.83	7	7	-----
109	2 ² .3 ³	6	6	± 10	523	2.3 ² .29	2	4	-10	1009	2 ⁴ .3 ² .7	11	11	-----
113	2 ⁴ .7	3	3	± 10	541	2 ² .3 ³ .5	2	2	± 10	1013	2 ² .11.23	3	3	-----
127	2.3 ² .7	3	9	-----	547	2.3.7.13	2	4	-----	1019	2.509	2	3	10
131	2.5.13	2	3	10	557	2 ² .139	2	2	-----	1021	2 ² .3.5.17	10	10	± 10
137	2 ³ .17	3	3	-----	563	2.281	2	3	-10	1031	2.5.103	14	2	-----
139	2.3.23	2	4	-----	569	2 ³ .71	3	3	-----	1033	2 ³ .3.43	5	5	± 10
149	2 ² .37	2	2	± 10	571	2.3.5.19	3	5	10	1039	2.3.173	3	2	-10
151	2.3.5 ²	6	5	-10	577	2 ⁶ .3 ²	5	5	± 10	1049	2 ³ .131	3	3	-----
157	2 ² .3.13	5	5	-----	587	2.293	2	3	-10	1051	2.3.5 ² .7	7	5	10
163	2.3 ⁴	2	4	-10	593	2 ⁴ .37	3	3	± 10	1061	2 ² .5.53	2	2	-----
167	2.83	5	2	10	599	2.13.23	7	2	-10	1063	2.3 ² .59	3	2	10
173	2 ² .43	2	2	-----	601	2 ³ .3.5 ²	7	7	-----	1069	2 ² .3.89	6	6	± 10
179	2.89	2	3	10	607	2.3.101	3	2	-----	1087	2.3.181	3	2	10
181	2 ² .3 ² .5	2	2	± 10	613	2 ² .3 ² .17	2	2	-----	1091	2.5.109	2	4	10
191	2.5.19	19	2	-10	617	2 ³ .7.11	3	3	-----	1093	2 ² .3.7.13	5	5	-----
193	2 ⁴ .3	5	5	± 10	619	2.3.103	2	4	10	1097	2 ³ .137	3	3	± 10
197	2 ² .7 ²	2	2	-----	631	2.3 ² .5.7	3	9	-10	1103	2.19.29	5	3	10
199	2.3 ² .11	3	2	-10	641	2 ⁷ .5	3	3	-----	1109	2 ² .277	2	2	± 10
211	2.3.5.7	2	4	-----	643	2.3.107	11	7	-----	1117	2 ² .3 ² .31	2	2	-----
223	2.3.37	3	9	10	647	2.17.19	5	2	10	1123	2.3.11.17	2	4	-10
227	2.113	2	3	-10	653	2 ² .163	2	2	-----	1129	2 ³ .3.47	11	11	-----
229	2 ² .3.19	6	6	± 10	659	2.7.47	2	3	10	1151	2.5 ² .23	17	2	-10
233	2 ³ .29	3	3	± 10	661	2 ² .3.5.11	2	2	-----	1153	2 ⁷ .3 ²	5	5	± 10
239	2.7.17	7	2	-----	673	2 ⁵ .3.7	5	5	-----	1163	2.7.83	5	3	-10
241	2 ⁴ .3.5	7	7	-----	677	2 ² .13 ²	2	2	-----	1171	2.3 ² .5.13	2	4	10
251	2.5 ³	6	3	-----	683	2.11.31	5	10	-10	1181	2 ² .5.59	7	7	± 10
257	2 ⁸	3	3	± 10	691	2.3.5.23	3	6	-----	1187	2.593	2	3	-10
263	2.131	5	2	10	701	2 ² .5 ² .7	2	2	± 10	1193	2 ³ .149	3	3	± 10
269	2 ² .67	2	2	± 10	709	2 ² .3.5.9	2	2	± 10	1201	2 ⁴ .3.5 ³	11	11	-----
271	2.3 ³ .5	6	2	-----	719	2.3.59	11	2	-10	1213	2 ² .3.101	2	2	-----
277	2 ² .3.23	5	5	-----	727	2.3.11 ²	5	7	10	1217	2 ⁶ .19	3	3	± 10
281	2 ³ .5.7	3	3	-----	733	2 ² .3.61	6	6	-----	1223	2.13.47	5	2	10
283	2.3.47	3	6	-10	739	2.3 ² .41	3	6	-----	1229	2 ² .307	2	2	± 10
293	2 ² .73	2	2	-----	743	2.7.53	5	2	10	1231	2.3.5.41	3	2	-----
307	2.3 ² .17	5	7	-10	751	2.3.5 ³	3	2	-----	1237	2 ² .3.103	2	2	-----
311	2.5.31	17	2	-10	757	2 ² .3 ² .7	2	2	-----	1249	2 ³ .3.13	7	7	-----
313	2 ³ .3.13	10	10	± 10	761	2 ³ .5.19	6	6	-----	1259	2.17.37	2	3	10
317	2 ² .79	2	2	-----	769	2 ⁸ .3	11	11	-----	1277	2 ² .11.29	2	2	-----
331	2.3.5.11	3	5	-----	773	2 ² .193	2	2	-----	1279	2.3 ² .71	3	2	-10
337	2 ⁴ .3.7	10	10	± 10	787	2.3.131	2	4	-10	1283	2.641	2	3	-10
347	2.173	2	3	-10	797	2 ² .199	2	2	-----	1289	2 ³ .7.23	6	6	-----
349	2 ² .3.29	2	2	-----	809	2 ³ .101	3	3	-----	1291	2.3.5.43	2	4	10
353	2 ⁵ .11	3	3	-----	811	2.3 ⁴ .5	3	5	10	1297	2 ⁴ .3 ⁴	10	10	± 10

Primitive Roots, Factorization of $p-1$

Table 24.8

g, G denote the least positive and least negative (respectively) primitive roots of p . ϵ denotes whether 10, -10 both or neither are primitive roots.

p	$p-1$	g	$-G$	ϵ	p	$p-1$	g	$-G$	ϵ	p	$p-1$	g	$-G$	ϵ
1301	2 ² ·5 ² ·13	2	2	±10	1831	2·3·5·61	3	9	-----	2377	2 ³ ·3 ³ ·11	5	5	-----
1303	2·3·7·31	6	2	10	1847	2·13·71	5	2	10	2381	2 ² ·5·7·17	3	3	-----
1307	2·653	2	3	-10	1861	2 ² ·3·5·31	2	2	±10	2383	2·3·397	5	13	10
1319	2·659	13	2	-10	1867	2·3·311	2	4	-10	2389	2 ³ ·3·199	2	2	±10
1321	2 ³ ·3·5·11	13	13	-----	1871	2·5·11·17	14	2	-10	2393	2 ³ ·13·23	3	3	-----
1327	2·3·13·17	3	9	10	1873	2 ⁴ ·3 ² ·13	10	10	±10	2399	2·11·109	11	2	-10
1361	2 ⁴ ·5·17	3	3	-----	1877	2 ² ·7·67	2	2	-----	2411	2·5·241	6	3	10
1367	2·683	5	2	10	1879	2·3·313	6	2	-----	2417	2 ⁴ ·151	3	3	±10
1373	2 ² ·7 ²	2	2	-----	1889	2 ³ ·59	3	3	-----	2423	2·7·173	5	2	10
1381	2 ² ·3·5·23	2	2	±10	1901	2 ² ·5 ² ·19	2	2	-----	2437	2 ² ·3·7·29	2	2	-----
1399	2·3·233	13	5	-10	1907	2·953	2	3	-10	2441	2 ³ ·5·61	6	6	-----
1409	2 ⁷ ·11	3	3	-----	1913	2 ³ ·239	3	3	±10	2447	2·1223	5	2	10
1423	2·3 ² ·79	3	9	-----	1931	2·5·193	2	3	-----	2459	2·1229	2	3	10
1427	2·23·31	2	3	-10	1933	2 ² ·3·7·23	5	5	-----	2467	2·3 ² ·137	2	4	-----
1429	2 ² ·3·7·17	6	6	±10	1949	2 ² ·487	2	2	±10	2473	2 ³ ·3·103	5	5	±10
1433	2 ³ ·179	3	3	±10	1951	2·3·5 ² ·13	3	2	-----	2477	2 ² ·619	2	2	-----
1439	2·719	7	2	-10	1973	2 ² ·17·29	2	2	-----	2503	2·3 ² ·139	3	2	-----
1447	2·3·241	3	2	10	1979	2·23·43	2	3	10	2521	2 ³ ·3 ² ·5·7	17	17	-----
1451	2·5 ² ·29	2	3	-----	1987	2·3·331	2	4	-----	2531	2·5·11·23	2	3	-----
1453	2 ² ·3·11 ²	2	2	-----	1993	2 ³ ·3·83	5	5	-----	2539	2·3 ² ·47	2	4	10
1459	2·3 ⁶	3	6	-----	1997	2 ² ·499	2	2	-----	2543	2·31·41	5	2	10
1471	2·3·5·7 ²	6	5	-10	1999	2·3 ² ·37	3	5	-10	2549	2 ² ·7 ² ·13	2	2	±10
1481	2 ³ ·5·37	3	3	-----	2003	2·7·11·13	5	3	-10	2551	2·3·5 ² ·17	6	2	-----
1483	2·3·13·19	2	4	-----	2011	2·3·5·67	3	5	-----	2557	2 ² ·3 ² ·71	2	2	-----
1487	2·743	5	2	10	2017	2 ⁵ ·3 ² ·7	5	5	±10	2579	2·1289	2	3	10
1489	2 ⁴ ·3·31	14	14	-----	2027	2·1013	2	3	-10	2591	2·5·7·37	7	2	-----
1493	2 ² ·373	2	2	-----	2029	2 ² ·3·13 ²	2	2	±10	2593	2 ³ ·3 ⁴	7	7	±10
1499	2·7·107	2	3	-----	2039	2·1019	7	2	-10	2609	2 ⁴ ·163	3	3	-----
1511	2·5·151	11	2	-10	2053	2 ² ·3 ² ·19	2	2	-----	2617	2 ³ ·3·109	5	5	±10
1523	2·761	2	3	-10	2063	2·1031	5	2	10	2621	2 ² ·5·131	2	2	±10
1531	2·3 ² ·5·17	2	4	10	2069	2 ² ·11·47	2	2	±10	2633	2 ³ ·7·47	3	3	±10
1543	2·3·257	5	2	10	2081	2 ⁵ ·5·13	3	3	-----	2647	2·3 ³ ·7 ²	3	2	-----
1549	2 ² ·3 ² ·43	2	2	±10	2083	2·3·347	2	4	-10	2657	2 ³ ·83	3	3	±10
1553	2 ⁴ ·97	3	3	±10	2087	2·7·149	5	2	-----	2659	2·3·443	2	4	-----
1559	2·19·41	19	2	-10	2089	2 ³ ·3 ² ·29	7	7	-----	2663	2·11 ³	5	2	10
1567	2·3 ² ·29	3	2	10	2099	2·1049	2	3	10	2671	2·3·5·89	7	5	-10
1571	2·5·157	2	3	10	2111	2·5·211	7	2	-10	2677	2 ² ·3·223	2	2	-----
1579	2·3·263	3	5	10	2113	2 ⁶ ·3·11	5	5	±10	2683	2·3 ² ·149	2	4	-----
1583	2·7·113	5	2	10	2129	2 ⁴ ·7·19	3	3	-----	2687	2·17·79	5	3	10
1597	2 ² ·3·7·19	11	11	-----	2131	2·3·5·71	2	4	-----	2689	2 ² ·3·7	19	19	-----
1601	2 ³ ·5 ²	3	3	-----	2137	2 ³ ·3·89	10	10	±10	2693	2 ² ·673	2	2	-----
1607	2·11·73	5	2	10	2141	2 ² ·5·107	2	2	±10	2699	2·19·71	2	3	10
1609	2 ³ ·3·67	7	7	-----	2143	2·3 ² ·7·17	3	9	10	2707	2·3·11·41	2	4	-10
1613	2 ² ·13·31	3	3	-----	2153	2 ³ ·269	3	3	±10	2711	2·5·271	7	2	-10
1619	2·809	2	3	10	2161	2 ⁴ ·3 ³ ·5	23	23	-----	2713	2 ³ ·3·113	5	5	±10
1621	2 ² ·3 ⁴ ·5	2	2	±10	2179	2·3 ² ·11 ²	7	5	10	2719	2·3 ² ·151	3	2	-10
1627	2·3·271	3	6	-----	2203	2·3·367	5	7	-10	2729	2 ³ ·11·31	3	3	-----
1637	2 ² ·409	2	2	-----	2207	2·1103	5	2	10	2731	2·3·5·7·13	3	5	10
1657	2 ³ ·3 ² ·23	11	11	-----	2213	2 ² ·7·79	2	2	-----	2741	2 ² ·5·137	2	2	±10
1663	2·3·277	3	2	10	2221	2 ² ·3·5·37	2	2	±10	2749	2 ² ·3·229	6	6	-----
1667	2·7 ² ·17	2	3	-10	2237	2 ² ·13·43	2	2	-----	2753	2 ³ ·43	3	3	±10
1669	2 ² ·3·139	2	2	-----	2239	2·3·373	3	2	-10	2767	2·3·461	3	9	10
1693	2 ² ·3 ² ·47	2	2	-----	2243	2·19·59	2	3	-10	2777	2 ³ ·347	3	3	±10
1697	2 ⁵ ·53	3	3	±10	2251	2·3 ² ·5 ³	7	5	10	2789	2 ² ·17·41	2	2	±10
1699	2·3·283	3	6	-----	2267	2·11·103	2	3	-10	2791	2·3 ² ·5·31	6	7	-----
1709	2 ² ·7·61	3	3	±10	2269	2 ² ·3 ⁴ ·7	2	2	±10	2797	2 ² ·3·233	2	2	-----
1721	2 ³ ·5·43	3	3	-----	2273	2 ⁵ ·71	3	3	±10	2801	2 ⁴ ·5 ² ·7	3	3	-----
1723	2·3·7·41	3	6	-----	2281	2 ³ ·3·5·19	7	7	-----	2803	2·3·467	2	4	-10
1733	2 ² ·433	2	2	-----	2287	2·3 ² ·127	19	7	-----	2819	2·1409	2	3	10
1741	2 ² ·3·5·29	2	2	±10	2293	2 ² ·3·191	2	2	-----	2833	2 ⁴ ·3·59	5	5	±10
1747	2·3 ² ·97	2	4	-----	2297	2 ³ ·7·41	5	5	±10	2837	2 ² ·709	2	2	-----
1753	2 ³ ·3·73	7	7	-----	2309	2 ² ·577	2	2	±10	2843	2·7 ² ·29	2	4	-10
1759	2·3·293	6	2	-10	2311	2·3·5·7·11	3	2	-----	2851	2·3·5 ² ·19	2	4	10
1777	2 ⁴ ·3·37	5	5	±10	2333	2 ² ·11·53	2	2	-----	2857	2 ³ ·3·7·17	11	11	-----
1783	2·3 ⁴ ·11	10	2	10	2339	2·7·167	2	3	10	2861	2 ² ·5·11·13	2	2	±10
1787	2·19·47	10	3	-10	2341	2 ² ·3 ² ·5·13	7	7	±10	2879	2·1439	7	2	-10
1789	2 ² ·3·149	6	6	±10	2347	2·3·17·23	3	6	-10	2887	2·3·13·37	5	2	10
1801	2 ² ·3 ² ·5 ²	11	11	-----	2351	2 ² ·5 ² ·47	13	3	-10	2897	2 ⁴ ·181	3	3	±10
1811	2·5·181	6	3	10	2357	2 ² ·19·31	2	2	-----	2903	2·1451	5	2	10
1823	2·911	5	2	10	2371	2·3·5·79	2	4	10	2909	2 ² ·727	2	2	±10

Table 24.8

Primitive Roots, Factorization of $p-1$

g, G denote the least positive and least negative (respectively) primitive roots of p . ϵ denotes whether 10, -10 both or neither are primitive roots.

p	$p-1$	g	$-G$	ϵ	p	$p-1$	g	$-G$	ϵ	p	$p-1$	g	$-G$	ϵ
2917	2 ² ·3 ⁶	5	5	-----	3527	2·41·43	5	2	10	4079	2·2039	11	2	-10
2927	2·7·11·19	5	2	10	3529	2 ³ ·3 ² ·7 ²	17	17	-----	4091	2·5·409	2	3	10
2939	2·13·113	2	3	10	3533	2 ² ·883	2	2	-----	4093	2 ² ·3·11·31	2	2	-----
2953	2 ³ ·3 ² ·41	13	13	-----	3539	2·29·61	2	3	10	4099	2·3·683	2	4	10
2957	2 ² ·739	2	2	-----	3541	2 ² ·3·5·59	7	7	-----	4111	2·3·5·137	12	2	-10
2963	2·1481	2	3	-10	3547	2·3 ² ·197	2	4	-10	4127	2·2063	5	2	10
2969	2 ³ ·7·53	3	3	-----	3557	2 ² ·7·127	2	2	-----	4129	2 ² ·3·43	13	13	-----
2971	2 ² ·3 ² ·5·11	10	5	10	3559	2·3·593	3	2	-10	4133	2 ² ·1033	2	2	-----
2999	2·1499	17	2	-10	3571	2·3·5·7·17	2	4	10	4139	2·2069	2	3	10
3001	2 ³ ·3·5 ²	14	14	-----	3581	2 ² ·5·179	2	2	±10	4153	2 ² ·3·173	5	5	±10
3011	2·5·7·43	2	3	10	3583	2·3 ² ·199	3	2	-----	4157	2 ² ·1039	2	2	-----
3019	2·3·503	2	4	10	3593	2 ² ·449	3	3	±10	4159	2·3 ² ·7·11	3	2	-----
3023	2·1511	5	2	10	3607	2·3·601	5	11	10	4177	2 ² ·3 ² ·29	5	5	±10
3037	2 ² ·3·11·23	2	2	-----	3613	2 ² ·3·7·43	2	2	-----	4201	2 ² ·3·5 ² ·7	11	11	-----
3041	2 ⁵ ·5·19	3	3	-----	3617	2 ⁵ ·113	3	3	±10	4211	2·5·421	6	3	10
3049	2 ³ ·3·127	11	11	-----	3623	2·1811	5	2	10	4217	2 ² ·17·31	3	3	±10
3061	2 ² ·3 ² ·5·17	6	6	-----	3631	2·3·5·11 ²	15	10	-10	4219	2·3·19·37	2	4	10
3067	2·3·7·73	2	4	-10	3637	2 ² ·3 ² ·101	2	2	-----	4229	2 ² ·7·151	2	2	±10
3079	2·3 ⁴ ·19	6	2	-10	3643	2·3·607	2	4	-10	4231	2·3 ² ·5·47	3	2	-10
3083	2·23·67	2	3	-10	3659	2·31·59	2	3	10	4241	2 ⁴ ·5·53	3	3	-----
3089	2 ⁴ ·193	3	3	-----	3671	2·5·367	13	2	-----	4243	2·3·7·101	2	4	-10
3109	2 ² ·3·7·37	6	6	-----	3673	2 ² ·3 ² ·17	5	5	±10	4253	2 ² ·1063	2	2	-----
3119	2·1559	7	2	-10	3677	2 ² ·919	2	2	-----	4259	2·2129	2	3	10
3121	2 ⁴ ·3·5·13	7	7	-----	3691	2·3 ² ·5·41	2	4	-----	4261	2 ² ·3·5·71	2	2	±10
3137	2 ⁵ ·7 ²	3	3	±10	3697	2·43 ²	5	5	-----	4271	2·5·7·61	7	3	-10
3163	2·3·17·31	3	6	-10	3701	2 ² ·5 ² ·37	2	2	±10	4273	2 ⁴ ·3·89	5	5	-----
3167	2·1583	5	2	10	3709	2 ² ·3 ² ·103	2	2	±10	4283	2·2141	2	3	-10
3169	2 ² ·3 ² ·11	7	7	-----	3719	2·11·13 ²	7	2	-10	4289	2 ⁶ ·67	3	3	-----
3181	2 ² ·3·5·53	7	7	-----	3727	2·3 ² ·23	3	2	10	4297	2 ² ·3·179	5	5	-----
3187	2·3 ³ ·59	2	4	-----	3733	2 ² ·3·311	2	2	-----	4327	2·3·7·103	3	2	10
3191	2·5·11·29	11	5	-----	3739	2·3·7·89	7	5	-----	4337	2 ⁴ ·271	3	3	±10
3203	2·1601	2	3	-10	3761	2 ⁴ ·5·47	3	3	-----	4339	2·3 ² ·241	10	5	10
3209	2 ³ ·401	3	3	-----	3767	2·7·269	5	2	10	4349	2 ² ·1087	2	2	±10
3217	2 ⁴ ·3·67	5	5	-----	3769	2 ² ·3·157	7	7	-----	4357	2 ² ·3 ² ·11 ²	2	2	-----
3221	2 ² ·5·7·23	10	10	±10	3779	2·1889	2	3	10	4363	2·3·727	2	4	-10
3229	2 ² ·3·269	6	6	-----	3793	2 ⁴ ·3·79	5	5	-----	4373	2 ² ·1093	2	2	-----
3251	2·5 ³ ·13	6	3	10	3797	2 ² ·13·73	2	2	-----	4391	2·5·439	14	2	-10
3253	2 ² ·3·271	2	2	-----	3803	2·1901	2	3	-10	4397	2 ² ·7·157	2	2	-----
3257	2 ³ ·11·37	3	3	±10	3821	2 ² ·5·191	3	3	±10	4409	2 ² ·19·29	3	3	-----
3259	2·3 ² ·181	3	5	10	3823	2·3·7 ² ·13	3	9	-----	4421	2 ² ·5·13·17	3	3	±10
3271	2·3·5·109	3	5	-10	3833	2 ² ·479	3	3	±10	4423	2·3·11·67	3	7	10
3299	2·17·97	2	3	10	3847	2·3·641	5	2	10	4441	2 ² ·3·5·37	21	21	-----
3301	2 ² ·3·5 ² ·11	6	6	±10	3851	2·5 ² ·7·11	2	4	-----	4447	2·3 ² ·13·19	3	2	10
3307	2·3·19·29	2	4	-10	3853	2 ² ·3 ² ·107	2	2	-----	4451	2·5 ² ·89	2	3	10
3313	2 ⁴ ·3 ² ·23	10	10	±10	3863	2·1931	5	2	10	4457	2 ² ·557	3	3	±10
3319	2·3·7·79	6	2	-----	3877	2 ² ·3·17·19	2	2	-----	4463	2·23·97	5	2	10
3323	2·11·151	2	3	-10	3881	2 ² ·5·97	13	13	-----	4481	2 ² ·5·7	3	3	-----
3329	2 ² ·13	3	3	-----	3889	2 ⁴ ·3 ⁵	11	11	-----	4483	2·3 ² ·83	2	4	-----
3331	2·3 ² ·5·37	3	5	10	3907	2·3 ² ·7·31	2	4	-10	4493	2 ² ·1123	2	2	-----
3343	2·3·557	5	11	10	3911	2·5·17·23	13	2	-10	4507	2·3·751	2	4	-----
3347	2·7·239	2	3	-10	3917	2 ² ·11·89	2	2	-----	4513	2 ² ·3·47	7	7	-----
3359	2·23·73	11	2	-10	3919	2·3·653	3	2	-----	4517	2 ² ·1129	2	2	-----
3361	2 ³ ·3·5·7	22	22	-----	3923	2·37·53	2	3	-10	4519	2·3 ² ·251	3	9	-----
3371	2·5·337	2	3	10	3929	2 ² ·491	3	3	-----	4523	2·7·17·19	5	3	-10
3373	2 ² ·3·281	5	5	-----	3931	2·3·5·131	2	4	-----	4547	2·2273	2	3	-10
3389	2 ² ·7·11 ²	3	3	±10	3943	2·3 ² ·73	3	9	10	4549	2 ² ·3·379	6	6	-----
3391	2·3·5·113	3	5	-10	3947	2·1973	2	3	-10	4561	2 ² ·3·5·19	11	11	-----
3407	2·13·131	5	2	10	3967	2·3·661	6	2	10	4567	2·3·761	3	7	10
3413	2 ² ·853	2	2	-----	3989	2 ² ·997	2	2	±10	4583	2·29·79	5	2	10
3433	2 ² ·3·11·13	5	5	±10	4001	2 ⁵ ·5 ³	3	3	-----	4591	2·3 ² ·5·17	11	2	-10
3449	2 ² ·431	3	3	-----	4003	2·3·23·29	2	4	-----	4597	2 ² ·3·383	5	5	-----
3457	2 ⁷ ·3 ²	7	7	-----	4007	2·2003	5	2	10	4603	2·3·13·59	2	4	-10
3461	2 ² ·5·173	2	2	±10	4013	2 ² ·17·59	2	2	-----	4621	2 ² ·3·5·7·11	2	2	-----
3463	2·3·577	3	9	10	4019	2·7 ² ·41	2	4	10	4637	2 ² ·19·61	2	2	-----
3467	2·1733	2	3	-10	4021	2 ² ·3·5·67	2	2	-----	4639	2·3·773	3	2	-10
3469	2 ² ·3·17 ²	2	2	±10	4027	2·3·11·61	3	6	-10	4643	2·11·211	5	3	-10
3491	2·5·349	2	3	-----	4049	2 ⁴ ·11·23	3	3	-----	4649	2 ² ·7·83	3	3	-----
3499	2·3·11·53	2	4	-----	4051	2·3 ² ·5 ²	10	5	10	4651	2·3·5 ² ·31	3	5	10
3511	2·3 ² ·5·13	7	2	-10	4057	2 ² ·3·13 ²	5	5	±10	4657	2 ⁴ ·3·97	15	15	-----
3517	2 ² ·3·293	2	2	-----	4073	2 ² ·509	3	3	±10	4663	2·3 ² ·7·37	3	9	-----

Primitive Roots, Factorization of $p-1$

Table 24.8

g, G denote the least positive and least negative (respectively) primitive roots of p . ϵ denotes whether 10, -10 both or neither are primitive roots.

p	$p-1$	g	$-G$	ϵ	p	$p-1$	g	$-G$	ϵ	p	$p-1$	g	$-G$	ϵ
4673	2 ⁸ .73	3	3	±10	5297	2 ⁴ .331	3	3	±10	5867	2.7.419	5	3	-10
4679	2.2339	11	2	-10	5303	2.11.241	5	2	10	5869	2 ² .3 ² .163	2	2	±10
4691	2.5.7.67	2	3	10	5309	2 ² .1327	2	2	±10	5879	2.2939	11	2	-10
4703	2.2351	5	2	10	5323	2.3.887	5	10	-10	5881	2 ³ .3.5.7 ²	31	31	-----
4721	2 ⁴ .5.59	6	6	-----	5333	2 ² .31.43	2	2	-----	5897	2 ³ .11.67	3	3	±10
4723	2.3.787	2	4	-10	5347	2.3 ² .11	3	6	-10	5903	2.3.227	5	2	10
4729	2 ³ .3.197	17	17	-----	5351	2.5 ² .107	11	2	-10	5923	2.3 ² .7.47	2	4	-10
4733	2 ² .7.13 ²	5	5	-----	5381	2 ² .5.269	3	3	±10	5927	2.2963	5	2	10
4751	2.5 ³ .19	19	3	-10	5387	2.2693	2	3	-10	5939	2.2969	2	3	10
4759	2.3.13.61	3	5	-10	5393	2 ⁴ .337	3	3	±10	5953	2 ⁶ .3.31	7	7	-----
4783	2.3.797	6	2	10	5399	2.2699	7	2	-10	5981	2 ² .5.13.23	3	3	±10
4787	2.2393	2	3	-10	5407	2.3.17.53	3	2	-----	5987	2.41.73	2	3	-10
4789	2 ² .3 ² .7.19	2	2	-----	5413	2 ³ .3.11.41	5	5	-----	6007	2.3.7.11.13	3	9	-----
4793	2 ² .599	3	3	±10	5417	2 ² .677	3	3	±10	6011	2.5.601	2	4	10
4799	2.2399	7	2	-10	5419	2.3 ² .7.43	3	5	10	6029	2 ² .11.137	2	2	±10
4801	2 ⁶ .3.5 ²	7	7	-----	5431	2.3.5.181	3	2	-10	6037	2 ² .3.503	5	5	-----
4813	2 ² .3.401	2	2	-----	5437	2 ² .3 ² .151	5	5	-----	6043	2.3.19.53	5	6	-10
4817	2 ⁴ .7.43	3	3	±10	5441	2 ² .5.17	3	3	-----	6047	2.3023	5	2	10
4831	2.3.5.7.23	3	2	-----	5443	2.3.907	2	4	-----	6053	2 ² .17.89	2	2	-----
4861	2 ² .3 ⁵ .5	11	11	-----	5449	2 ² .3.227	7	7	-----	6067	2.3 ² .337	2	4	-10
4871	2.5.487	11	3	-10	5471	2.5.547	7	3	-----	6073	2 ³ .3.11.23	10	10	±10
4877	2 ² .23.53	2	2	-----	5477	2 ² .37 ²	2	2	-----	6079	2.3.1013	17	7	-----
4889	2 ³ .13.47	3	3	-----	5479	2.3.11.83	3	2	-10	6089	2 ² .761	3	3	-----
4903	2.3.19.43	3	2	-----	5483	2.2741	2	3	-10	6091	2.3.5.7.29	7	11	-----
4909	2 ² .3.409	6	6	-----	5501	2 ² .5 ³ .11	2	2	±10	6101	2 ² .5 ² .61	2	2	-----
4919	2.2459	13	2	-10	5503	2.3.7.131	3	9	10	6113	2 ⁵ .191	3	3	±10
4931	2.5.17.29	6	3	10	5507	2.2753	2	3	-10	6121	2 ³ .3 ² .5.17	7	7	-----
4933	2 ² .3 ² .137	2	2	-----	5519	2.31.89	13	2	-10	6131	2.5.613	2	3	10
4937	2 ³ .617	3	3	±10	5521	2 ⁴ .3.5.23	11	11	-----	6133	2 ² .3.7.73	5	5	-----
4943	2.7.353	7	2	10	5527	2.3 ² .307	5	2	10	6143	2.37.83	5	2	10
4951	2.3 ² .5 ² .11	6	2	-10	5531	2.5.7.79	10	5	10	6151	2.3.5 ² .41	3	7	-----
4957	2 ² .3.7.59	2	2	-----	5557	2 ² .3.463	2	2	-----	6163	2.3.13.79	3	6	-----
4967	2.13.191	5	2	10	5563	2.3 ² .103	2	4	-10	6173	2 ² .1543	2	2	-----
4969	2 ³ .3 ² .23	11	11	-----	5569	2 ⁴ .3.29	13	13	-----	6197	2 ² .1549	2	2	-----
4973	2 ² .11.113	2	2	-----	5573	2 ² .7.199	2	2	-----	6199	2.3.1033	3	2	-10
4987	2.3 ² .277	2	4	-10	5581	2 ² .3 ² .5.31	6	6	±10	6203	2.7.443	2	3	-----
4993	2 ² .3.13	5	5	-----	5591	2.5.13.43	11	2	-10	6211	2.3 ² .5.23	2	4	10
4999	2.3.7 ² .17	3	9	-----	5623	2.3.937	5	2	10	6217	2 ³ .3.7.37	5	5	±10
5003	2.41.61	2	3	-10	5639	2.2819	7	2	-10	6221	2 ² .5.311	3	3	±10
5009	2 ⁴ .313	3	3	-----	5641	2 ³ .3.5.47	14	14	-----	6229	2 ² .3 ² .173	2	2	-----
5011	2.3.5.167	2	4	-----	5647	2.3.941	3	2	-----	6247	2.3 ² .347	5	2	10
5021	2 ² .5.251	3	3	±10	5651	2.5 ² .113	2	3	10	6257	2 ⁴ .17.23	3	3	±10
5023	2.3 ⁴ .31	3	2	-----	5653	2 ² .3 ² .157	5	5	-----	6263	2.31.101	5	2	10
5039	2.11.229	11	2	-10	5657	2 ² .7.101	3	3	±10	6269	2 ² .1567	2	2	±10
5051	2.5 ² .101	2	3	-----	5659	2.3.23.41	2	4	10	6271	2.3.5.11.19	11	17	-----
5059	2.3 ² .281	2	4	10	5669	2 ² .13.109	3	3	±10	6277	2 ² .3.523	2	2	-----
5077	2 ² .3 ² .47	2	2	-----	5683	2.3.947	2	4	-10	6287	2.7.449	7	2	10
5081	2 ³ .5.127	3	3	-----	5689	2 ³ .3 ² .79	11	11	-----	6299	2.47.67	2	3	-----
5087	2.2543	5	2	10	5693	2 ² .1423	2	2	-----	6301	2 ² .3 ² .5 ² .7	10	10	±10
5099	2.2549	2	3	10	5701	2 ² .3.5 ² .19	2	2	±10	6311	2.5.631	7	2	-10
5101	2 ² .3.5 ² .17	6	6	-----	5711	2.5.571	19	3	-----	6317	2 ² .1579	2	2	-----
5107	2.3.23.37	2	4	-10	5717	2 ² .1429	2	2	-----	6323	2.29.109	2	3	-10
5113	2 ³ .3 ² .71	19	19	-----	5737	2 ³ .3.239	5	5	±10	6329	2 ³ .7.113	3	3	-----
5119	2.3.853	3	2	-----	5741	2 ² .5.7.41	2	2	±10	6337	2 ² .3 ² .11	10	10	±10
5147	2.31.83	2	3	-10	5743	2.3 ² .11.29	10	2	10	6343	2.3.7.151	3	2	10
5153	2 ⁵ .7.23	5	5	±10	5749	2 ² .3.479	2	2	±10	6353	2 ⁴ .397	3	3	±10
5167	2.3 ² .7.41	6	11	10	5779	2.3 ² .107	2	4	10	6359	2.11.17 ²	13	2	-10
5171	2.5.11.47	2	4	-----	5783	2.7 ² .59	7	2	10	6361	2 ² .3.5.53	19	19	-----
5179	2.3.863	2	4	10	5791	2.3.5.193	6	2	-----	6367	2.3.1061	3	2	10
5189	2 ² .1297	2	2	±10	5801	2 ² .5 ² .29	3	3	-----	6373	2 ² .3 ² .59	2	2	-----
5197	2 ² .3.433	7	7	-----	5807	2.2903	5	2	10	6379	2.3.1063	2	4	-----
5209	2 ³ .3.7.31	17	17	-----	5813	2 ² .1453	2	2	-----	6389	2 ² .1597	2	2	±10
5227	2.3.13.67	2	4	-10	5821	2 ² .3.5.97	6	6	±10	6397	2 ² .3.13.41	2	2	-----
5231	2.5.523	7	2	-10	5827	2.3.971	2	4	-10	6421	2 ² .3.5.107	6	6	-----
5233	2 ⁴ .3.109	10	10	±10	5839	2.3.7.139	6	2	-10	6427	2.3 ² .7.17	3	6	-----
5237	2 ² .7.11.17	3	3	-----	5843	2.23.127	2	4	-10	6449	2 ⁴ .13.31	3	3	-----
5261	2 ² .5.263	2	2	-----	5849	2 ² .17.43	3	3	-----	6451	2.3.5 ² .43	3	6	-----
5273	2 ³ .659	3	3	±10	5851	2.3 ² .5 ² .13	2	4	-----	6469	2 ² .3.7 ² .11	2	2	-----
5279	2.7.13.29	7	3	-10	5857	2 ² .3.61	7	7	±10	6473	2 ² .809	3	3	±10
5281	2 ² .3.5.11	7	7	-----	5861	2 ² .5.293	3	3	±10	6481	2 ⁴ .3 ⁴ .5	7	7	-----

Table 24.8

Primitive Roots, Factorization of $p-1$

g, G denote the least positive and least negative (respectively) primitive roots of p . ϵ denotes whether 10, -10 both or neither are primitive roots.

p	$p-1$	g	$-G$	ϵ	p	$p-1$	g	$-G$	ϵ	p	$p-1$	g	$-G$	ϵ
6491	2.5.11.59	2	3	-----	7121	2 ⁴ .5.89	3	3	-----	7741	2 ² .3 ² .5.43	7	7	-----
6521	2 ³ .5.163	6	6	-----	7127	2.7.509	5	2	-----	7753	2 ³ .3.17.19	10	10	±10
6529	2 ⁷ .3.17	7	7	-----	7129	2 ³ .3 ⁴ .11	7	7	-----	7757	2 ² .7.277	2	2	-----
6547	2.3.1091	2	4	-----	7151	2.5 ² .11.13	7	3	-----	7759	2.3 ² .431	3	2	-10
6551	2.5 ² .131	17	2	-10	7159	2.3.1193	3	2	-10	7789	2 ² .3.11.59	2	2	-----
6553	2 ³ .3 ² .7.13	10	10	±10	7177	2 ³ .3.13.23	10	10	±10	7793	2 ⁴ .487	3	3	±10
6563	2.17.193	5	10	-10	7187	2.3593	2	3	-10	7817	2 ² .977	3	3	±10
6569	2 ³ .821	3	3	-----	7193	2 ² .29.31	3	3	±10	7823	2.3911	5	2	10
6571	2.3 ² .5.73	3	7	10	7207	2.3.1201	3	2	10	7829	2 ² .19.103	2	2	±10
6577	2 ⁴ .3.137	5	5	-----	7211	2.5.7.103	2	3	-----	7841	2 ⁵ .5.7 ²	12	12	-----
6581	2 ² .5.7.47	14	14	-----	7213	2 ² .3.601	5	5	-----	7853	2 ² .13.151	2	2	-----
6599	2.3299	13	2	-10	7219	2.3 ² .401	2	4	10	7867	2.3 ² .19.23	3	6	-10
6607	2.3 ² .367	3	2	-----	7229	2 ² .13.139	2	2	±10	7873	2 ⁶ .3.41	5	5	±10
6619	2.3.1103	2	4	10	7237	2 ² .3 ² .67	2	2	-----	7877	2 ² .11.179	2	2	-----
6637	2 ² .3.7.79	2	2	-----	7243	2.3.17.71	2	4	-10	7879	2.3.13.101	3	2	-10
6653	2 ² .1663	2	2	-----	7247	2.3623	5	2	10	7883	2.7.563	2	3	-10
6659	2.3329	2	3	10	7253	2 ² .7 ² .37	2	2	-----	7901	2 ² .5 ² .79	2	2	±10
6661	2 ² .3 ² .5.37	6	6	±10	7283	2.11.331	2	3	-10	7907	2.59.67	2	3	-10
6673	2 ⁴ .3.139	5	5	±10	7297	2 ⁷ .3.19	5	5	-----	7919	2.37.107	7	2	-10
6679	2.3 ² .7.53	7	5	-10	7307	2.13.281	2	3	-10	7927	2.3.1321	3	7	10
6689	2 ⁵ .11.19	3	3	-----	7309	2 ² .3 ² .7.29	6	6	±10	7933	2 ² .3.661	2	2	-----
6691	2.3.5.223	2	4	10	7321	2 ² .3.5.61	7	7	-----	7937	2 ⁸ .31	3	3	±10
6701	2 ² .5.6 ² .7	2	2	±10	7331	2.5.733	2	4	-----	7949	2 ² .1987	2	2	±10
6703	2.3.1117	5	2	10	7333	2 ² .3.13.47	6	6	-----	7951	2.3.5 ² .53	6	2	-10
6709	2 ² .3.13.43	2	2	±10	7349	2 ² .11.167	2	2	±10	7963	2.3.1327	5	10	-10
6719	2.3359	11	2	-10	7351	2.3.5 ² .7 ²	6	5	-----	7993	2 ² .3 ² .37	5	5	-----
6733	2 ² .3 ² .11.17	2	2	-----	7369	2 ² .3.307	7	7	-----	8009	2 ² .7.11.13	3	3	-----
6737	2 ⁴ .421	3	3	±10	7393	2 ² .3.7.11	5	5	±10	8011	2.3 ² .5.89	14	7	-----
6761	2 ³ .5.13 ²	3	3	-----	7411	2.3.5.13.19	2	4	10	8017	2 ⁴ .3.167	5	5	±10
6763	2.3.7 ² .23	2	4	-----	7417	2 ² .3 ² .103	5	5	-----	8039	2.4019	11	2	-10
6779	2.3389	2	3	10	7433	2 ² .929	3	3	±10	8053	2.3.11.61	2	2	-----
6781	2 ² .3.5.113	2	2	-----	7451	2.5 ² .149	2	4	10	8059	2.3.17.79	3	5	10
6791	2.5.7.97	7	3	-----	7457	2 ⁵ .233	3	3	±10	8069	2 ² .2017	2	2	±10
6793	2 ² .3.283	10	10	±10	7459	2.3.11.113	2	4	10	8081	2 ² .5.101	3	3	-----
6803	2.19.179	2	3	-10	7477	2 ² .3.7.89	2	2	-----	8087	2.13.311	5	2	10
6823	2.3 ² .379	3	2	10	7481	2 ² .5.11.17	6	6	-----	8089	2 ² .3.337	17	17	-----
6827	2.3413	2	3	-10	7487	2.19.197	5	3	10	8093	2 ² .7.17 ²	2	2	-----
6829	2 ² .3.569	2	2	±10	7489	2 ⁶ .3 ² .13	7	7	-----	8101	2 ² .3 ⁴ .5 ²	6	6	-----
6833	2 ⁴ .7.61	3	3	±10	7499	2.23.163	2	3	10	8111	2.5.811	11	2	-----
6841	2 ² .3 ² .5.19	22	22	-----	7507	2.3 ² .139	2	4	-10	8117	2 ² .2029	2	2	-----
6857	2 ² .857	3	3	±10	7517	2 ² .1879	2	2	-----	8123	2.31.131	2	3	-10
6863	2.47.73	5	2	10	7523	2.3761	2	3	-10	8147	2.4073	2	3	-10
6869	2 ² .17.101	2	2	±10	7529	2 ² .941	3	3	-----	8161	2 ² .3.5.17	7	7	-----
6871	2.3.5.229	3	9	-10	7537	2 ² .3.157	7	7	-----	8167	2.3.1361	3	9	-----
6883	2.3.31.37	2	4	-10	7541	2 ² .5.13.29	2	2	±10	8171	2.5.19.43	2	3	10
6899	2.3449	2	3	10	7547	2.7 ² .11	2	3	-10	8179	2.3.29.47	2	4	10
6907	2.3.1151	2	4	-----	7549	2 ² .3.17.37	2	2	-----	8191	2.3 ² .5.7.13	17	11	-----
6911	2.5.691	7	2	-10	7559	2.3779	13	2	-10	8209	2 ⁴ .3 ² .19	7	7	-----
6917	2 ² .7.13.19	2	2	-----	7561	2 ² .3 ² .5.7	13	13	-----	8219	2.7.587	2	3	10
6947	2.23.151	2	3	-10	7573	2 ² .3.631	2	2	-----	8221	2 ² .3.5.137	2	2	-----
6949	2 ² .3 ² .193	2	2	±10	7577	2 ² .947	3	3	±10	8231	2.5.823	11	2	-10
6959	2.7 ² .71	7	3	-10	7583	2.17.223	5	2	10	8233	2 ² .3.7 ²	10	10	±10
6961	2 ⁴ .3.5.29	13	13	-----	7589	2 ² .7.271	2	2	-----	8237	2 ² .29.71	2	2	-----
6967	2.3 ⁴ .43	5	13	10	7591	2.3.5.11.23	6	2	-10	8243	2.13.317	2	3	-10
6971	2.5.17.41	2	4	10	7603	2.3.7.181	2	4	-----	8263	2.3 ² .17	3	2	10
6977	2 ⁶ .109	3	3	±10	7607	2.3803	5	2	10	8269	2 ² .3.13.53	2	2	±10
6983	2.3491	5	2	10	7621	2 ² .3.5.127	2	2	-----	8273	2 ² .11.47	3	3	±10
6991	2.3.5.233	6	2	-10	7639	2.3.19.67	7	5	-10	8287	2.3.1381	3	7	10
6997	2 ² .3.11.53	5	5	-----	7643	2.3821	2	3	-10	8291	2.5.829	2	3	10
7001	2 ² .5 ² .7	3	3	-----	7649	2 ² .239	3	3	-----	8293	2 ² .1049	2	2	-----
7013	2 ² .1753	2	2	-----	7669	2 ² .3 ² .71	2	2	-----	8297	2 ² .2099	3	3	±10
7019	2.11 ² .29	2	3	10	7673	2 ² .7.137	3	3	±10	8311	2.3.5.277	3	2	-10
7027	2.3.1171	2	4	-----	7681	2 ² .3.5	17	17	-----	8317	2 ² .3 ² .7.11	6	6	-----
7039	2.3 ² .17.23	3	2	-----	7687	2.3 ² .7.61	6	2	10	8329	2 ² .3.347	7	7	-----
7043	2.7.503	2	4	-----	7691	2.5.769	2	3	10	8353	2 ² .3 ² .29	5	5	±10
7057	2 ⁴ .3.7 ²	5	5	±10	7699	2.3.1283	3	5	10	8363	2.37.113	2	3	-10
7069	2 ² .3.19.31	2	2	±10	7703	2.3851	5	2	10	8369	2 ⁴ .523	3	3	-----
7079	2.3539	7	2	-10	7717	2 ² .3.643	2	2	-----	8377	2 ² .3.349	5	5	±10
7103	2.53.67	5	2	10	7723	2.3 ² .11.13	3	6	-----	8387	2.7.599	2	3	-----
7109	2 ² .1777	2	2	±10	7727	2.3863	5	2	10	8389	2 ² .3 ² .233	6	6	±10

Primitive Roots, Factorization of $p-1$

Table 24.8

g, G denote the least positive and least negative (respectively) primitive roots of p . ϵ denotes whether 10, -10 both or neither are primitive roots.

p	$p-1$	g	$-G$	ϵ	p	$p-1$	g	$-G$	ϵ	p	$p-1$	g	$-G$	ϵ
8419	2·3·23·61	3	6	-----	8941	2 ² ·3·5·149	6	6	-----	9463	2·3·19·83	3	9	-----
8423	2·4211	5	2	10	8951	2·5 ² ·179	13	2	-10	9467	2·4733	2	3	-10
8429	2 ² ·7 ² ·43	2	2	±10	8963	2·4481	2	3	-10	9473	2 ⁸ ·37	3	3	±10
8431	2·3·5·281	3	2	-10	8969	2 ³ ·19·59	3	3	-----	9479	2·7·677	7	2	-10
8443	2·3 ² ·7·67	2	4	-10	8971	2·3·5·13·23	2	4	10	9491	2·5·13·73	2	3	10
8447	2·41·103	5	2	10	8999	2·11·409	7	2	-10	9497	2 ⁸ ·1187	3	3	±10
8461	2 ² ·3 ² ·5·47	6	6	-----	9001	2 ³ ·3 ² ·5 ²	7	7	-----	9511	2·3·5·317	3	9	-----
8467	2·3·17·83	2	4	-10	9007	2·3·19·79	3	2	-----	9521	2 ⁴ ·5·7·17	3	3	-----
8501	2 ² ·5 ² ·17	7	7	±10	9011	2·5·17·53	2	4	10	9533	2 ² ·2383	2	2	-----
8513	2 ² ·7·19	5	5	±10	9013	2 ² ·3·751	5	5	-----	9539	2·19·251	2	3	10
8521	2 ² ·3·5·71	13	13	-----	9029	2 ² ·37·61	2	2	±10	9547	2·3·37·43	2	4	-10
8527	2·3·7 ² ·29	5	2	-----	9041	2 ⁴ ·5·113	3	3	-----	9551	2·5 ² ·191	11	2	-----
8537	2 ³ ·11·97	3	3	±10	9043	2·3·11·137	3	6	-10	9587	2·4793	2	3	-10
8539	2·3·1423	2	4	-----	9049	2 ³ ·3·13·29	7	7	-----	9601	2 ⁷ ·3·5 ²	13	13	-----
8543	2·4271	5	2	10	9059	2·7·647	2	4	10	9613	2 ² ·3 ³ ·89	2	2	-----
8563	2·3·1427	2	4	-10	9067	2·3·1511	3	6	-10	9619	2·3·7·229	2	4	-----
8573	2 ² ·2143	2	2	-----	9091	2·3 ² ·5·101	3	5	-----	9623	2·17·283	5	3	10
8581	2 ² ·3·5·11·13	6	6	-----	9103	2·3·37·41	6	2	10	9629	2 ² ·29·83	2	2	±10
8597	2 ² ·7·307	2	2	-----	9109	2 ² ·3 ² ·11·23	10	10	±10	9631	2·3 ² ·5·107	3	9	-10
8599	2·3·1433	3	2	-----	9127	2·3 ³ ·13 ²	3	2	-----	9643	2·3·1607	2	4	-10
8609	2 ⁵ ·269	3	3	-----	9133	2 ² ·3·761	6	6	-----	9649	2 ⁴ ·3 ² ·67	7	7	-----
8623	2·3 ² ·479	3	2	10	9137	2 ⁴ ·571	3	3	±10	9661	2 ² ·3·5·7·23	2	2	-----
8627	2·19·227	2	3	-10	9151	2·3·5 ² ·61	3	2	-----	9677	2 ² ·41·59	2	2	-----
8629	2 ² ·3·719	6	6	-----	9157	2 ² ·3·7·109	6	6	-----	9679	2·3·1613	3	2	-----
8641	2 ² ·3 ³ ·5	17	17	-----	9161	2 ³ ·5·229	3	3	-----	9689	2 ² ·7·173	3	3	-----
8647	2·3·11·131	3	2	10	9173	2 ² ·2293	2	2	-----	9697	2 ² ·3·101	10	10	±10
8663	2·61·71	5	2	10	9181	2 ² ·3 ³ ·5·17	2	2	-----	9719	2·43·113	17	3	-10
8669	2 ² ·11·197	2	2	±10	9187	2·3·1531	3	6	-10	9721	2 ³ ·3 ³ ·5	7	7	-----
8677	2 ² ·3 ² ·241	2	2	-----	9199	2·3 ² ·7·73	3	2	-10	9733	2 ² ·3·811	2	2	-----
8681	2 ³ ·5·7·31	15	15	-----	9203	2·43·107	2	3	-10	9739	2·3 ² ·541	3	5	10
8689	2 ⁴ ·3·181	13	13	-----	9209	2 ² ·1151	3	3	-----	9743	2·4871	5	2	10
8693	2 ² ·41·53	2	2	-----	9221	2 ² ·5·461	2	2	±10	9749	2 ² ·2437	2	2	±10
8699	2·4349	2	3	10	9227	2·7·659	2	3	-10	9767	2·19·257	5	2	10
8707	2·3·1451	5	7	-10	9239	2·31·149	19	2	-10	9769	2 ² ·3·11·37	13	13	-----
8713	2 ² ·3 ² ·11 ²	5	5	±10	9241	2 ² ·3·5·7·11	13	13	-----	9781	2 ² ·3·5·163	6	6	±10
8719	2·3·1453	3	5	-10	9257	2 ³ ·13·89	3	3	±10	9787	2·3·7·233	3	6	-10
8731	2·3 ² ·5·97	2	4	10	9277	2 ² ·3·773	5	5	-----	9791	2·5·11·89	11	2	-10
8737	2 ² ·3·7·13	5	5	-----	9281	2 ² ·5·29	3	3	-----	9803	2·13 ² ·29	2	3	-10
8741	2 ² ·5·19·23	2	2	±10	9283	2·3·7·13·17	2	4	-----	9811	2·3 ² ·5·109	3	5	10
8747	2·4373	2	3	-10	9293	2 ² ·23·101	2	2	-----	9817	2 ² ·3·409	5	5	±10
8753	2 ⁴ ·547	3	3	±10	9311	2·5·7 ² ·19	7	2	-10	9829	2 ² ·3 ² ·7·13	10	10	±10
8761	2 ² ·3·5·73	23	23	-----	9319	2·3·1553	3	2	-10	9833	2 ² ·1229	3	3	±10
8779	2·3·7·11·19	11	22	-----	9323	2·59·79	2	3	-10	9839	2·4919	7	2	-10
8783	2·4391	5	2	10	9337	2 ² ·3·389	5	5	-----	9851	2·5 ² ·197	2	4	10
8803	2·3 ² ·163	2	4	-----	9341	2 ² ·5·467	2	2	±10	9857	2 ⁷ ·7·11	5	5	±10
8807	2·7·17·37	5	2	10	9343	2 ² ·3 ² ·173	5	2	10	9859	2·3·31·53	2	4	-----
8819	2·4409	2	3	10	9349	2 ² ·3·19·41	2	2	-----	9871	2·3·5·7·47	3	2	-10
8821	2 ² ·3 ² ·5·7 ²	2	2	±10	9371	2·5·937	2	3	10	9883	2·3 ⁴ ·61	2	4	-10
8831	2·5·883	7	5	-10	9377	2 ² ·293	3	3	±10	9887	2·4943	5	2	10
8837	2 ² ·47 ²	2	2	-----	9391	2·3·5·313	3	2	-10	9901	2 ² ·3 ² ·5 ² ·11	2	2	-----
8839	2·3 ² ·491	3	2	-10	9397	2 ² ·3 ² ·29	2	2	-----	9907	2·3·13·127	2	4	-10
8849	2 ⁴ ·7·79	3	3	-----	9403	2·3·1567	3	6	-----	9923	2·11 ² ·41	2	3	-10
8861	2 ² ·5·443	2	2	±10	9413	2 ² ·13·181	3	3	-----	9929	2 ² ·17·73	3	3	-----
8863	2·3·7·211	3	9	10	9419	2·17·277	2	3	-----	9931	2·3·5·331	10	5	10
8867	2·11·13·31	2	3	-10	9421	2 ² ·3·5·157	2	2	±10	9941	2 ² ·5·7·71	2	2	-----
8887	2·3·1481	3	2	10	9431	2·5·23·41	7	3	-10	9949	2 ² ·3·829	2	2	±10
8893	2 ² ·3 ² ·13·19	5	5	-----	9433	2 ² ·3 ² ·131	5	5	-----	9967	2·3·11·151	3	2	10
8923	2·3·1487	2	4	-----	9437	2 ² ·7·337	2	2	-----	9973	2 ² ·3 ² ·277	11	11	-----
8929	2 ² ·3 ² ·31	11	11	-----	9439	2·3·11 ² ·13	22	7	-----					
8933	2 ² ·7·11·29	2	2	-----	9461	2 ² ·5·11·43	3	3	±10					

Table 24.9

PRIMES

Table with 24 columns (0-24) and 100 rows (1-100) containing prime numbers. The table lists prime numbers in a grid format, with some numbers appearing in multiple columns.

From D. N. Lehmer, List of prime numbers from 1 to 10,006,721, Carnegie Institution of Washington, Publication No. 165, Washington, D.C., 1914 (with permission).

COMBINATORIAL ANALYSIS

Table 24.9

Table with 49 columns (25-49) and 100 rows of numerical data. The title 'PRIMES' is centered above the columns. The table contains a grid of prime numbers.

Table 24.9

PRIMES

	50	51	52	53	54	55	56	57	58	59	60	61	62	63	64	65	66	67	68	69	70	71	72	73	74
1	48619	49667	50767	51817	52937	54001	55109	56197	57193	58243	59369	60509	61637	62791	63823	65071	66107	67247	68389	69497	70663	71719	72859	73999	75083
2	48623	49669	50773	51827	52951	54011	55117	56207	57203	58271	59377	60521	61643	62801	63839	65089	66109	67261	68399	69499	70667	71741	72869	74017	75109
3	48647	49681	50777	51829	52957	54013	55127	56209	57221	58309	59387	60527	61651	62819	63841	65099	66137	67271	68437	69539	70687	71761	72871	74021	75133
4	48649	49697	50789	51839	52963	54037	55147	56237	57223	58313	59399	60539	61657	62827	63853	65101	66161	67273	68443	69557	70709	71777	72883	74027	75149
5	48661	49711	50821	51853	52967	54049	55163	56239	57241	58321	59399	60539	61667	62851	63857	65111	66169	67289	68447	69593	70717	71789	72889	74027	75161
6	48673	49727	50833	51859	52973	54059	55171	56249	57251	58337	59407	60601	61673	62861	63863	65119	66173	67307	68449	69623	70729	71807	72893	74051	75167
7	48677	49739	50839	51869	52981	54063	55179	56253	57259	58363	59417	60607	61681	62869	63901	65123	66179	67339	68473	69653	70753	71807	72901	74071	75169
8	48679	49741	50849	51871	52999	54091	55207	56267	57269	58367	59419	60611	61687	62873	63907	65129	66191	67343	68477	69661	70769	71821	72907	74077	75181
9	48731	49747	50857	51893	53003	54101	55213	56269	57271	58369	59441	60617	61703	62897	63913	65141	66221	67349	68483	69677	70783	71837	72911	74093	75191
10	48733	49757	50867	51899	53017	54121	55217	56299	57283	58379	59443	60623	61717	62903	63929	65147	66239	67369	68489	69691	70793	71843	72923	74099	75209
11	48751	49783	50873	51907	53047	54133	55219	56311	57287	58391	59447	60631	61723	62921	63949	65167	66271	67391	68491	69697	70823	71849	72931	74101	75211
12	48757	49787	50881	51913	53051	54139	55229	56333	57301	58393	59453	60637	61729	62927	63977	65171	66293	67399	68501	69709	70841	71861	72937	74121	75217
13	48761	49789	50883	51929	53069	54151	55243	56359	57329	58403	59467	60647	61751	62929	63997	65173	66301	67409	68507	69737	70843	71867	72949	74143	75223
14	48776	49801	50909	51941	53077	54163	55249	56369	57331	58411	59471	60649	61757	62939	64007	65179	66337	67411	68521	69739	70849	71879	72953	74149	75227
15	48779	49807	50923	51949	53087	54167	55259	56377	57347	58417	59473	60659	61781	62969	64013	65183	66343	67421	68531	69761	70853	71879	72959	74159	75239
16	48781	49811	50929	51971	53089	54181	55291	56383	57349	58427	59497	60661	61813	62971	64019	65203	66347	67427	68539	69763	70867	71887	72973	74161	75253
17	48787	49823	50939	51973	53093	54193	55313	56393	57367	58439	59509	60679	61819	62981	64033	65213	66359	67429	68543	69767	70877	71889	72977	74167	75259
18	48789	49833	50967	51977	53101	54217	55313	56401	57373	58441	59513	60689	61837	62983	64037	65239	66361	67433	68567	69779	70879	71909	72997	74177	75279
19	48799	49843	50969	51991	53113	54251	55333	56417	57383	58451	59539	60709	61843	62987	64063	65257	66373	67447	68581	69809	70891	71917	73009	74189	75287
20	48817	49853	50971	52009	53117	54269	55337	56431	57389	58453	59557	60719	61861	62989	64067	65267	66377	67453	68597	69821	70901	71933	73013	74197	75307
21	48821	49871	50989	52021	53129	54277	55339	56437	57397	58477	59561	60727	61871	63009	64081	65269	66383	67477	68611	69827	70913	71941	73019	74201	75323
22	48823	49877	50993	52027	53147	54287	55343	56443	57413	58481	59567	60733	61879	63031	64091	65287	66403	67481	68633	69829	70919	71947	73037	74203	75327
23	48847	49893	51001	52051	53149	54293	55351	56453	57427	58511	59581	60737	61909	63039	64109	65293	66413	67489	68639	69833	70921	71967	73039	74209	75337
24	48857	49919	51031	52057	53161	54311	55373	56467	57457	58537	59611	60757	61927	63067	64123	65309	66431	67493	68659	69847	70937	71971	73043	74219	75347
25	48859	49921	51043	52067	53171	54319	55381	56473	57467	58543	59617	60761	61933	63073	64151	65323	66449	67499	68669	69857	70949	71983	73061	74231	75357
26	48869	49927	51047	52069	53173	54323	55399	56477	57487	58549	59621	60763	61949	63079	64153	65327	66457	67511	68683	69859	70951	71987	73063	74257	75367
27	48871	49937	51059	52081	53189	54331	55411	56479	57493	58567	59627	60773	61961	63097	64157	65333	66463	67523	68687	69877	70957	71993	73079	74279	75377
28	48883	49939	51061	52103	53197	54347	55439	56489	57503	58573	59629	60779	61967	63103	64171	65357	66467	67531	68699	69899	70969	71999	73091	74287	75389
29	48899	49943	51071	52121	53201	54361	55441	56491	57521	58579	59651	60793	61979	63113	64187	65371	66491	67537	68711	69911	70979	72019	73121	74293	75391
30	48907	49957	51109	52127	53221	54367	55457	56503	57529	58601	59659	60811	61981	63127	64189	65381	66499	67547	68713	69929	70981	72031	73127	74297	75401
31	48947	49991	51131	52147	53233	54373	55469	56509	57557	58603	59663	60827	61987	63131	64217	65397	66509	67559	68729	69931	70991	72043	73133	74311	75403
32	48953	49993	51133	52153	53239	54377	55469	56519	57559	58613	59669	60829	61991	63149	64223	65407	66523	67567	68737	69941	70997	72047	73141	74317	75407
33	48973	49999	51137	52163	53249	54401	55501	56527	57571	58631	59671	60869	62003	63179	64231	65413	66529	67577	68743	69959	70997	72053	73181	74323	75417
34	48989	50021	51151	52177	53269	54403	55511	56531	57587	58657	59693	60887	62011	63197	64237	65419	66533	67579	68749	69991	71011	72073	73189	74353	75437
35	48991	50023	51157	52181	53273	54409	55529	56533	57593	58663	59699	60889	62017	63199	64271	65423	66541	67589	68767	69997	71023	72077	73237	74357	75477
36	49003	50033	51169	52183	53281	54413	55541	56543	57601	58679	59707	60899	62039	63211	64279	65437	66553	67601	68771	70001	71039	72089	73243	74363	75503
37	49009	50047	51193	52189	53291	54419	55547	56569	57637	58713	59723	60901	62047	63241	64283	65447	66569	67607	68777	70003	71059	72091	73259	74371	75511
38	49019	50051	51197	52201	53309	54421	55579	56591	57641	58693	59729	60913	62053	63247	64301	65449	66571	67619	68811	70009	71069	72101	73277	74381	75521
39	49031	50053	51199	52223	53323	54431	55589	56597	57649	58699	59749	60917	62057	63247	64303	65479	66587	67613	68813	70019	71081	72103	73291	74383	75521
40	49033	50069	51203	52237	53327	54443	55603	56599	57653	58711	59747	60919	62071	63281	64319	65497	66593	67651	68819	70039	71089	72109	73303	74411	75533
41	49037	50077	51213	52249	53333	54449	55609	56611	57667	58727	59753	60923	62081	63289	64327	65519	66601	67679	68829	70051	71119	72139	73309	74413	75539
42	49043	50087	51229	52253	53359	54469	55619	56629	57679	58733	59771	60937	62099	63311	64333	65521	66617	67699	68863	70061	71129	72161	73327	74419	75541
43	49057	50093	51239	52259	53377	54493	55621	56633	57689	58741	59779	60943	62119	63313	64373	65537	66629	67709	68879	70067	71143	72167	73341	74441	75543
44	49069	50111	51241	52267	53381	54497	55631	56659	57697	58757	59791	60953	62129	63317	64381	65539	66643	67723	68881	70079	71147	72169	73351	74449	75557
45	49081	50111	51257	52289	53391	54499	55633	56663	57709	58763	59797	60959	62131	63317	64399	65543	66653	67733	68891	70099	71153	72173	73361	74453	75571
46	49103	50119	51263	52291	53407	54503	55639	56671	57713	58771	59809	61001	62137	63337	64403	65551	66683	67741	68897</						

PRIMES

Table 21.9

Table with 25 columns (75-99) and 100 rows of prime numbers. Each row contains 25 prime numbers in order. The table is a grid of prime numbers from 1 to 100, with columns labeled 75 through 99 and rows numbered 1 through 100.

25. Numerical Interpolation, Differentiation, and Integration

PHILIP J. DAVIS¹ AND IVAN POLONSKY²

Contents

Formulas	Page
25.1. Differences	877
25.2. Interpolation	878
25.3. Differentiation	882
25.4. Integration	885
25.5. Ordinary Differential Equations	896
References	898
Table 25.1. <i>n</i> -Point Lagrangian Interpolation Coefficients ($3 \leq n \leq 8$) . .	900
$n=3, 4, p = -\left[\frac{n-1}{2}\right] (.01) \left[\frac{n}{2}\right],$ Exact	
$n=5, 6, p = -\left[\frac{n-1}{2}\right] (.01) \left[\frac{n}{2}\right],$ 10D	
$n=7, 8, p = -\left[\frac{n-1}{2}\right] (.1) \left[\frac{n}{2}\right],$ 10D	
Table 25.2. <i>n</i> -Point Coefficients for <i>k</i> -th Order Differentiation ($1 \leq k \leq 5$)	914
$k=1, \quad n=3(1)6, \quad$ Exact	
$k=2(1)5, \quad n=k+1(1)6, \quad$ Exact	
Table 25.3. <i>n</i> -Point Lagrangian Integration Coefficients ($3 \leq n \leq 10$) . .	915
$n=3(1)10, \quad$ Exact	
Table 25.4. Abscissas and Weight Factors for Gaussian Integration ($2 \leq n \leq 96$).	916
$n=2(1)10, 12, \quad$ 15D	
$n=16(4)24(8)48(16)96, \quad$ 21D	
Table 25.5. Abscissas for Equal Weight Chebyshev Integration ($2 \leq n \leq 9$)	920
$n=2(1)7, 9, \quad$ 10D	
Table 25.6. Abscissas and Weight Factors for Lobatto Integration ($3 \leq n \leq 10$).	920
$n=3(1)10, \quad$ 8-10D	
Table 25.7. Abscissas and Weight Factors for Gaussian Integration for Integrand with a Logarithmic Singularity ($2 \leq n \leq 4$)	920
$n=2(1)4, \quad$ 6D	

¹ National Bureau of Standards.

² National Bureau of Standards. (Presently, Bell Tel. Labs., Whippany, N.J.)

Table 25.8. Abscissas and Weight Factors for Gaussian Integration of Moments ($1 \leq n \leq 8$)	Page 921
$k=0(1)5, n=1(1)8, 10D$	
Table 25.9. Abscissas and Weight Factors for Laguerre Integration ($2 \leq n \leq 15$)	923
$n=2(1)10, 12, 15, 12D$ or S	
Table 25.10. Abscissas and Weight Factors for Hermite Integration ($2 \leq n \leq 20$)	924
$n=2(1)10, 12, 16, 20, 13-15D$ or S	
Table 25.11. Coefficients for Filon's Quadrature Formula ($0 \leq \theta \leq 1$) . .	924
$\theta=0(.01).1(.1)1, 8D$	

25. Numerical Interpolation, Differentiation, and Integration

Numerical analysts have a tendency to accumulate a multiplicity of tools each designed for highly specialized operations and each requiring special knowledge to use properly. From the vast stock of formulas available we have culled the present selection. We hope that it will be useful. As with all such compendia, the reader may miss his favorites and find others whose utility he thinks is marginal.

We would have liked to give examples to illuminate the formulas, but this has not been feasible. Numerical analysis is partially a science and partially an art, and short of writing a text-book on the subject it has been impossible to indicate where and under what circumstances the various formulas are useful or accurate, or to elucidate the numerical difficulties to which one might be led by uncritical use. The formulas are therefore issued together with a caveat against their blind application.

Formulas

Notation: Abscissas: $x_0 < x_1 < \dots$; functions: f, g, \dots ; values: $f(x_i) = f_i, f'(x_i) = f'_i, f'', f^{(2)}, \dots$ indicate 1st, 2^d, . . . derivatives. If abscissas are equally spaced, $x_{i+1} - x_i = h$ and $f_p = f(x_0 + ph)$ (p not necessarily integral). R, R_n indicate remainders.

25.1. Differences

Forward Differences

25.1.1

$$\Delta(f_n) = \Delta_n = \Delta_n^1 = f_{n+1} - f_n$$

$$\Delta_n^2 = \Delta_{n+1}^1 - \Delta_n^1 = f_{n+2} - 2f_{n+1} + f_n$$

$$\Delta_n^3 = \Delta_{n+1}^2 - \Delta_n^2 = f_{n+3} - 3f_{n+2} + 3f_{n+1} - f_n$$

$$\Delta_n^k = \Delta_{n+1}^{k-1} - \Delta_n^{k-1} = \sum_{j=0}^k (-1)^j \binom{k}{j} f_{n+k-j}$$

Central Differences

25.1.2

$$\delta(f_{n+\frac{1}{2}}) = \delta_{n+\frac{1}{2}} = \delta_{n+\frac{1}{2}}^1 = f_{n+1} - f_n$$

$$\delta_n^2 = \delta_{n+\frac{1}{2}}^1 - \delta_{n-\frac{1}{2}}^1 = f_{n+1} - 2f_n + f_{n-1}$$

$$\delta_{n+\frac{1}{2}}^3 = \delta_{n+1}^2 - \delta_n^2 = f_{n+2} - 3f_{n+1} + 3f_n - f_{n-1}$$

$$\delta_n^{2k} = \sum_{j=0}^{2k} (-1)^j \binom{2k}{j} f_{n+k-j}$$

$$\delta_{n+\frac{1}{2}}^{2k+1} = \sum_{j=0}^{2k+1} (-1)^j \binom{2k+1}{j} f_{n+k+\frac{1}{2}-j}$$

$$\delta_{\frac{1}{2}n}^k = \Delta_{\frac{1}{2}(n-k)}^k \text{ if } n \text{ and } k \text{ are of same parity.}$$

Forward Differences

x_0	f_0			
		Δ_0		
x_1	f_1		Δ_0^2	
		Δ_1		Δ_0^3
x_2	f_2		Δ_1^2	
		Δ_2		
x_3	f_3			

Central Differences

x_{-1}	f_{-1}			
		$\delta_{-\frac{1}{2}}$		
x_0	f_0		δ_0^2	
		$\delta_{\frac{1}{2}}$		$\delta_{\frac{1}{2}}^3$
x_1	f_1		δ_1^2	
		$\delta_{3/2}$		
x_2	f_2			

Mean Differences

25.1.3

$$\mu(f_n) = \frac{1}{2}(f_{n+\frac{1}{2}} + f_{n-\frac{1}{2}})$$

Divided Differences

25.1.4

$$[x_0, x_1] = \frac{f_0 - f_1}{x_0 - x_1} = [x_1, x_0]$$

$$[x_0, x_1, x_2] = \frac{[x_0, x_1] - [x_1, x_2]}{x_0 - x_2}$$

$$[x_0, x_1, \dots, x_k] = \frac{[x_0, \dots, x_{k-1}] - [x_1, \dots, x_k]}{x_0 - x_k}$$

Divided Differences in Terms of Functional Values

25.1.5

$$[x_0, x_1, \dots, x_n] = \sum_{k=0}^n \frac{f_k}{\pi'_k(x_k)}$$

25.1.6 where $\pi_n(x) = (x-x_0)(x-x_1)\dots(x-x_n)$ and $\pi_n'(x)$ is its derivative:

25.1.7

$$\pi_n'(x_k) = (x_k-x_0)\dots(x_k-x_{k-1})(x_k-x_{k+1})\dots(x_k-x_n)$$

Let D be a simply connected domain with a piecewise smooth boundary C and contain the points z_0, \dots, z_n in its interior. Let $f(z)$ be analytic in D and continuous in $D+C$. Then,

25.1.8 $[z_0, z_1, \dots, z_n] = \frac{1}{2\pi i} \int_C \frac{f(z)}{\prod_{k=0}^n (z-z_k)} dz$

25.1.9 $\Delta_0^n = h^n f^{(n)}(\xi)$ ($x_0 < \xi < x_n$)

25.1.10

$$[x_0, x_1, \dots, x_n] = \frac{\Delta_0^n}{n! h^n} = \frac{f^{(n)}(\xi)}{n!} \quad (x_0 < \xi < x_n)$$

25.1.11

$$[x_{-n}, x_{-n+1}, \dots, x_0, \dots, x_n] = \frac{\delta_0^{2n}}{h^{2n}(2n)!}$$

Reciprocal Differences

25.1.12

$$\rho(x_0, x_1) = \frac{x_0 - x_1}{f_0 - f_1}$$

$$\rho_2(x_0, x_1, x_2) = \frac{x_0 - x_2}{\rho(x_0, x_1) - \rho(x_1, x_2)} + f_1$$

$$\rho_3(x_0, x_1, x_2, x_3) = \frac{x_0 - x_3}{\rho_2(x_0, x_1, x_2) - \rho_2(x_1, x_2, x_3)} + \rho(x_1, x_2)$$

$$\rho_n(x_0, x_1, \dots, x_n) = \frac{x_0 - x_n}{\rho_{n-1}(x_0, \dots, x_{n-1}) - \rho_{n-1}(x_1, \dots, x_n) + \rho_{n-2}(x_1, \dots, x_{n-1})}$$

25.2. Interpolation

Lagrange Interpolation Formulas

25.2.1 $f(x) = \sum_{i=0}^n l_i(x) f_i + R_n(x)$

25.2.2

$$l_i(x) = \frac{\pi_n(x)}{(x-x_i)\pi_n'(x_i)} = \frac{(x-x_0)\dots(x-x_{i-1})(x-x_{i+1})\dots(x-x_n)}{(x_i-x_0)\dots(x_i-x_{i-1})(x_i-x_{i+1})\dots(x_i-x_n)}$$

Remainder in Lagrange Interpolation Formula

25.2.3

$$R_n(x) = \pi_n(x) \cdot [x_0, x_1, \dots, x_n, x] = \pi_n(x) \cdot \frac{f^{(n+1)}(\xi)}{(n+1)!} \quad (x_0 < \xi < x_n)$$

25.2.4

$$|R_n(x)| \leq \frac{(x_n - x_0)^{n+1}}{(n+1)!} \max_{x_0 \leq x \leq x_n} |f^{(n+1)}(x)|$$

25.2.5

$$R_n(z) = \frac{\pi_n(z)}{2\pi i} \int_C \frac{f(t)}{(t-z)(t-z_0)\dots(t-z_n)} dt$$

The conditions of **25.1.8** are assumed here.

Lagrange Interpolation, Equally Spaced Abscissas

n Point Formula

25.2.6 $f(x_0 + ph) = \sum_k A_k^n(p) f_k + R_{n-1}$

For n even, $\left(-\frac{1}{2}(n-2) \leq k \leq \frac{1}{2}n\right)$.

For n odd, $\left(-\frac{1}{2}(n-1) \leq k \leq \frac{1}{2}(n-1)\right)$.

25.2.7

$$A_k^n(p) = \frac{(-1)^{\frac{1}{2}n+k}}{\left(\frac{n-2}{2}+k\right)! \left(\frac{1}{2}n-k\right)! (p-k)} \prod_{t=1}^n \left(p + \frac{1}{2}n - t\right)$$

n even.

$$A_k^n(p) = \frac{(-1)^{\frac{1}{2}(n-1)+k}}{\left(\frac{n-1}{2}+k\right)! \left(\frac{n-1}{2}-k\right)! (p-k)} \prod_{t=0}^{n-1} \left(p + \frac{n-1}{2} - t\right), \quad n \text{ odd.}$$

25.2.8

$$R_{n-1} = \frac{1}{n!} \prod_k (p-k) h^n f^{(n)}(\xi) \approx \frac{1}{n!} \prod_k (p-k) \Delta_0^n \quad (x_0 < \xi < x_n)$$

k has the same range as in **25.2.6**.

Lagrange Two Point Interpolation Formula (Linear Interpolation)

25.2.9 $f(x_0 + ph) = (1-p)f_0 + pf_1 + R_1$

25.2.10 $R_1(p) \approx .125h^2 f^{(2)}(\xi) \approx .125\Delta^2$

Lagrange Three Point Interpolation Formula

25.2.11

$$f(x_0+ph) = A_{-1}f_{-1} + A_0f_0 + A_1f_1 + R_2$$

$$\approx \frac{p(p-1)}{2}f_{-1} + (1-p^2)f_0 + \frac{p(p+1)}{2}f_1$$

25.2.12

$$R_2(p) \approx .065h^3f^{(3)}(\xi) \approx .065\Delta^3 \quad (|p| \leq 1)$$

Lagrange Four Point Interpolation Formula

25.2.13

$$f(x_0+ph) = A_{-1}f_{-1} + A_0f_0 + A_1f_1 + A_2f_2 + R_3$$

$$\approx \frac{-p(p-1)(p-2)}{6}f_{-1} + \frac{(p^2-1)(p-2)}{2}f_0$$

$$+ \frac{p(p+1)(p-2)}{2}f_1 + \frac{p(p^2-1)}{6}f_2$$

25.2.14

$$R_3(p) \approx$$

$$.024h^4f^{(4)}(\xi) \approx .024\Delta^4 \quad (0 < p < 1)$$

$$.042h^4f^{(4)}(\xi) \approx .042\Delta^4 \quad (-1 < p < 0, 1 < p < 2)$$

$$(x_{-1} < \xi < x_2)$$

Lagrange Five Point Interpolation Formula

25.2.15

$$f(x_0+ph) = \sum_{i=-2}^2 A_i f_i + R_4$$

$$\approx \frac{(p^2-1)p(p-2)}{24}f_{-2} - \frac{(p-1)p(p^2-4)}{6}f_{-1}$$

$$+ \frac{(p^2-1)(p^2-4)}{4}f_0 - \frac{(p+1)p(p^2-4)}{6}f_1$$

$$+ \frac{(p^2-1)p(p+2)}{24}f_2$$

25.2.16

$$R_4(p) \approx$$

$$.012h^5f^{(5)}(\xi) \approx .012\Delta^5 \quad (|p| < 1)$$

$$.031h^5f^{(5)}(\xi) \approx .031\Delta^5 \quad (1 < |p| < 2) \quad (x_{-2} < \xi < x_2)$$

Lagrange Six Point Interpolation Formula

25.2.17

$$f(x_0+ph) = \sum_{i=-2}^3 A_i f_i + R_5$$

$$\approx \frac{-p(p^2-1)(p-2)(p-3)}{120}f_{-2}$$

$$+ \frac{p(p-1)(p^2-4)(p-3)}{24}f_{-1}$$

$$- \frac{(p^2-1)(p^2-4)(p-3)}{12}f_0$$

$$+ \frac{p(p+1)(p^2-4)(p-3)}{12}f_1 - \frac{p(p^2-1)(p+2)(p-3)}{24}f_2$$

$$+ \frac{p(p^2-1)(p^2-4)}{120}f_3$$

25.2.18

$$R_5(p) \approx$$

$$.0049h^6f^{(6)}(\xi) \approx .0049\Delta^6 \quad (0 < p < 1)$$

$$.0071h^6f^{(6)}(\xi) \approx .0071\Delta^6 \quad (-1 < p < 0, 1 < p < 2)$$

$$.024h^6f^{(6)}(\xi) \approx .024\Delta^6 \quad (-2 < p < -1, 2 < p < 3)$$

$$(x_{-2} < \xi < x_3)$$

Lagrange Seven Point Interpolation Formula

25.2.19 $f(x_0+ph) = \sum_{i=-3}^3 A_i f_i + R_6$

25.2.20

$$R_6(p) \approx \begin{cases} .0025h^7f^{(7)}(\xi) \approx .0025\Delta^7 & (|p| < 1) \\ .0046h^7f^{(7)}(\xi) \approx .0046\Delta^7 & (1 < |p| < 2) \\ .019h^7f^{(7)}(\xi) \approx .019\Delta^7 & (2 < |p| < 3) \end{cases}$$

$$(x_{-3} < \xi < x_3)$$

Lagrange Eight Point Interpolation Formula

25.2.21 $f(x_0+ph) = \sum_{i=-3}^4 A_i f_i + R_7$

25.2.22

$$R_7(p) \approx \begin{cases} .0011h^8f^{(8)}(\xi) \approx .0011\Delta^8 & (0 < p < 1) \\ .0014h^8f^{(8)}(\xi) \approx .0014\Delta^8 & (-1 < p < 0) \\ & (1 < p < 2) \\ .0033h^8f^{(8)}(\xi) \approx .0033\Delta^8 & (-2 < p < -1) \\ & (2 < p < 3) \\ .016h^8f^{(8)}(\xi) \approx .016\Delta^8 & (-3 < p < -2) \\ & (3 < p < 4) \end{cases}$$

$$(x_{-3} < \xi < x_4)$$

Aitken's Iteration Method

Let $f(x|x_0, x_1, \dots, x_k)$ denote the unique polynomial of k^{th} degree which coincides in value with $f(x)$ at x_0, \dots, x_k .

25.2.23

$$f(x|x_0, x_1) = \frac{1}{x_1-x_0} \begin{vmatrix} f_0 & x_0-x \\ f_1 & x_1-x \end{vmatrix}$$

$$f(x|x_0, x_2) = \frac{1}{x_2-x_0} \begin{vmatrix} f_0 & x_0-x \\ f_2 & x_2-x \end{vmatrix}$$

$$f(x|x_0, x_1, x_2) = \frac{1}{x_2-x_1} \begin{vmatrix} f(x|x_0, x_1) & x_1-x \\ f(x|x_0, x_2) & x_2-x \end{vmatrix}$$

$$f(x|x_0, x_1, x_2, x_3) = \frac{1}{x_3-x_2} \begin{vmatrix} f(x|x_0, x_1, x_2) & x_2-x \\ f(x|x_0, x_1, x_3) & x_3-x \end{vmatrix}$$

Taylor Expansion

25.2.24

$$f(x) = f_0 + (x-x_0)f'_0 + \frac{(x-x_0)^2}{2!} f_0^{(2)} + \dots + \frac{(x-x_0)^n}{n!} f_0^{(n)} + R_n$$

25.2.25

$$R_n = \int_{x_0}^x f^{(n+1)}(t) \frac{(x-t)^n}{n!} dt = \frac{(x-x_0)^{n+1}}{(n+1)!} f^{(n+1)}(\xi) \quad (x_0 < \xi < x)$$

Newton's Divided Difference Interpolation Formula

25.2.26

$$f(x) = f_0 + \sum_{k=1}^n \pi_{k-1}(x) [x_0, x_1, \dots, x_k] + R_n$$

x_0	f_0		
x_1	f_1	$[x_0, x_1]$	
x_2	f_2	$[x_1, x_2]$	$[x_0, x_1, x_2]$
x_3	f_3	$[x_2, x_3]$	$[x_1, x_2, x_3]$

25.2.27

$$R_n(x) = \pi_n(x) [x_0, \dots, x_n] = \pi_n(x) \frac{f^{(n+1)}(\xi)}{(n+1)!} \quad (x_0 < \xi < x_n)$$

(For π_n see 25.1.6.)

Newton's Forward Difference Formula

25.2.28

$$f(x_0 + ph) = f_0 + p\Delta_0 + \binom{p}{2} \Delta_0^2 + \dots + \binom{p}{n} \Delta_0^n + R_n$$

x_0	f_0		
x_1	f_1	Δ_0	
x_2	f_2	Δ_1	Δ_0^2
x_3	f_3	Δ_2	Δ_1^2

25.2.29

$$R_n = h^{n+1} \binom{p}{n+1} f^{(n+1)}(\xi) \approx \binom{p}{n+1} \Delta_0^{n+1} \quad (x_0 < \xi < x_n)$$

Relation Between Newton and Lagrange Coefficients

25.2.30

$$\binom{p}{2} = A_{-1}^3(p) \quad \binom{p}{3} = -A_{-1}^4(p) \quad \binom{p}{4} = A_2^5(1-p) \quad \binom{p}{5} = A_3^6(2-p)$$

Everett's Formula

25.2.31

$$f(x_0 + ph) = (1-p)f_0 + pf_1 - \frac{p(p-1)(p-2)}{3!} \delta_0^2 + \frac{(p+1)p(p-1)}{3!} \delta_1^2 + \dots - \binom{p+n-1}{2n+1} \delta_0^{2n} + \binom{p+n}{2n+1} \delta_1^{2n} + R_{2n} = (1-p)f_0 + pf_1 + E_2\delta_0^2 + F_2\delta_1^2 + E_4\delta_0^4 + F_4\delta_1^4 + \dots + R_{2n}$$

x_0	f_0	δ_0^2	δ_0^4
		δ_1^2	δ_1^4
x_1	f_1	δ_1^2	δ_1^4

25.2.32

$$R_{2n} = h^{2n+2} \binom{p+n}{2n+2} f^{(2n+2)}(\xi) \approx \binom{p+n}{2n+2} \left[\frac{\Delta_{-n-1}^{2n+2} + \Delta_{-n}^{2n+2}}{2} \right] \quad (x_{-n} < \xi < x_{n+1})$$

Relation Between Everett and Lagrange Coefficients

25.2.33

$$E_2 = A_{-1}^4 \quad E_4 = A_{-2}^6 \quad E_6 = A_{-3}^8 \quad F_2 = A_2^4 \quad F_4 = A_3^6 \quad F_6 = A_4^8$$

Everett's Formula With Throwback (Modified Central Difference)

25.2.34

$$f(x_0 + ph) = (1-p)f_0 + pf_1 + E_2\delta_{m,0}^2 + F_2\delta_{m,1}^2 + R$$

25.2.35

$$\delta_m^2 = \delta^2 - .184\delta^4$$

25.2.36

$$R \approx .00045|\mu\delta_1^4| + .00061|\delta_1^5|$$

25.2.37

$$f(x_0 + ph) = (1-p)f_0 + pf_1 + E_2\delta_0^2 + F_2\delta_1^2 + E_4\delta_{m,0}^4 + F_4\delta_{m,1}^4 + R$$

25.2.38

$$\delta_m^4 = \delta^4 - .207\delta^6 + \dots$$

25.2.39

$$R \approx .000032|\mu\delta_1^6| + .000052|\delta_1^7|$$

25.2.40

$$f(x_0 + ph) = (1-p)f_0 + pf_1 + E_2\delta_0^2 + F_2\delta_1^2 + E_4\delta_0^4 + F_4\delta_1^4 + E_6\delta_{m,0}^6 + F_6\delta_{m,1}^6 + R$$

25.2.41

$$\delta_m^6 = \delta^6 - .218\delta^8 + .049\delta^{10} + \dots$$

25.2.42

$$R \approx .0000037|\mu\delta_1^8| + \dots$$

Simultaneous Throwback

25.2.43

$$f(x_0 + ph) = (1-p)f_0 + pf_1 + E_2\delta_{m,0}^2 + F_2\delta_{m,1}^2 + E_4\delta_{m,0}^4 + F_4\delta_{m,1}^4 + R$$

25.2.44 $\delta_m^2 = \delta^2 - .01312\delta^6 + .0043\delta^8 - .001\delta^{10}$

25.2.45 $\delta_m^4 = \delta^4 - .27827\delta^6 + .0685\delta^8 - .016\delta^{10}$

25.2.46 $R \approx .00000083|\mu\delta_1^6| + .0000094\delta^7$

Bessel's Formula With Throwback

25.2.47

$$f(x_0 + ph) = (1-p)f_0 + pf_1 + B_2(\delta_{m,0}^2 + \delta_{m,1}^2) + B_3\delta_1^3 + R, B_2 = \frac{p(p-1)}{4}, B_3 = \frac{p(p-1)(p-\frac{1}{2})}{6}$$

25.2.48 $\delta_m^2 = \delta^2 - .184\delta^4$

25.2.49 $R \approx .00045|\mu\delta_1^4| + .00087|\delta_1^5|$

Thiele's Interpolation Formula

25.2.50

$$f(x) = f(x_1) + \frac{x-x_1}{\rho(x_1, x_2) + x - x_2} \frac{\rho_2(x_1, x_2, x_3) - f(x_1) + x - x_3}{\left(\frac{\rho_3(x_1, x_2, x_3, x_4)}{-\rho(x_1, x_2) + \dots} \right)}$$

(For reciprocal differences, ρ , see 25.1.12.)

Trigonometric Interpolation

Gauss' Formula

25.2.51 $f(x) \approx \sum_{k=0}^{2n} f_k \zeta_k(x) = t_n(x)$

25.2.52

$$\zeta_k(x) = \frac{\sin \frac{1}{2}(x-x_0) \dots \sin \frac{1}{2}(x-x_{k-1})}{\sin \frac{1}{2}(x_k-x_0) \dots \sin \frac{1}{2}(x_k-x_{k-1})} \frac{\sin \frac{1}{2}(x-x_{k+1}) \dots \sin \frac{1}{2}(x-x_{2n})}{\sin \frac{1}{2}(x_k-x_{k+1}) \dots \sin \frac{1}{2}(x_k-x_{2n})}$$

$t_n(x)$ is a trigonometric polynomial of degree n such that $t_n(x_k) = f_k$ ($k=0, 1, \dots, 2n$)

Harmonic Analysis

Equally spaced abscissas

$$x_0 = 0, \quad x_1, \dots, x_{m-1}, x_m = 2\pi$$

25.2.53

$$f(x) \approx \frac{1}{2} a_0 + \sum_{k=1}^n (a_k \cos kx + b_k \sin kx)$$

25.2.54

$$m = 2n + 1$$

$$a_k = \frac{2}{2n+1} \sum_{r=0}^{2n} f_r \cos kx_r; \quad b_k = \frac{2}{2n+1} \sum_{r=0}^{2n} f_r \sin kx_r \quad (k=0, 1, \dots, n)$$

25.2.55

$$m = 2n$$

$$a_k = \frac{1}{n} \sum_{r=0}^{2n-1} f_r \cos kx_r; \quad b_k = \frac{1}{n} \sum_{r=0}^{2n-1} f_r \sin kx_r \quad (k=0, 1, \dots, n) \quad (k=0, 1, \dots, n-1)$$

b_n is arbitrary.

Subtabulation

Let $f(x)$ be tabulated initially in intervals of width h . It is desired to subtabulate $f(x)$ in intervals of width h/m . Let Δ and $\bar{\Delta}$ designate differences with respect to the original and the final intervals respectively. Thus $\bar{\Delta}_0 = f\left(x_0 + \frac{h}{m}\right) - f(x_0)$. Assuming that the original 5th order differences are zero,

25.2.56

$$\bar{\Delta}_0 = \frac{1}{m} \Delta_0 + \frac{1-m}{2m^2} \Delta_0^2 + \frac{(1-m)(1-2m)}{6m^3} \Delta_0^3 + \frac{(1-m)(1-2m)(1-3m)}{24m^4} \Delta_0^4$$

$$\bar{\Delta}_0^2 = \frac{1}{m^2} \Delta_0^2 + \frac{1-m}{m^3} \Delta_0^3 + \frac{(1-m)(7-11m)}{12m^4} \Delta_0^4$$

$$\bar{\Delta}_0^3 = \frac{1}{m^3} \Delta_0^3 + \frac{3(1-m)}{2m^4} \Delta_0^4$$

$$\bar{\Delta}_0^4 = \frac{1}{m^4} \Delta_0^4$$

From this information we may construct the final tabulation by addition. For $m=10$,

25.2.57

$$\bar{\Delta}_0 = .1\Delta_0 - .045\Delta_0^2 + .0285\Delta_0^3 - .02066\Delta_0^4$$

$$\bar{\Delta}_0^2 = .01\Delta_0^2 - .009\Delta_0^3 + .007725\Delta_0^4$$

$$\bar{\Delta}_0^3 = .001\Delta_0^3 - .00135\Delta_0^4$$

$$\bar{\Delta}_0^4 = .0001\Delta_0^4$$

Linear Inverse Interpolation

Find p , given $f_p (= f(x_0 + ph))$.

Linear

25.2.58
$$p \approx \frac{f_p - f_0}{f_1 - f_0}$$

Quadratic Inverse Interpolation

25.2.59

$$(f_1 - 2f_0 + f_{-1})p^2 + (f_1 - f_{-1})p + 2(f_0 - f_p) \approx 0$$

Inverse Interpolation by Reversion of Series

25.2.60 Given $f(x_0 + ph) = f_p = \sum_{k=0}^{\infty} a_k p^k$

25.2.61

$$p = \lambda + c_2 \lambda^2 + c_3 \lambda^3 + \dots, \lambda = (f_p - a_0) / a_1$$

25.2.62

$$c_2 = -a_2 / a_1$$

$$c_3 = \frac{-a_3}{a_1} + 2 \left(\frac{a_2}{a_1} \right)^2$$

$$c_4 = \frac{-a_4}{a_1} + \frac{5a_2 a_3}{a_1^2} - \frac{5a_2^3}{a_1^3}$$

$$c_5 = \frac{-a_5}{a_1} + \frac{6a_2 a_4}{a_1^2} + \frac{3a_3^2}{a_1^2} - \frac{21a_2^2 a_3}{a_1^3} + \frac{14a_2^4}{a_1^4}$$

Inversion of Newton's Forward Difference Formula

25.2.63

$$a_0 = f_0$$

$$a_1 = \Delta_0 - \frac{\Delta_0^2}{2} + \frac{\Delta_0^3}{3} - \frac{\Delta_0^4}{4} + \dots$$

$$a_2 = \frac{\Delta_0^2}{2} - \frac{\Delta_0^3}{2} + \frac{11\Delta_0^4}{24} + \dots$$

$$a_3 = \frac{\Delta_0^3}{6} - \frac{\Delta_0^4}{4} + \dots$$

$$a_4 = \frac{\Delta_0^4}{24} + \dots$$

(Used in conjunction with 25.2.62.)

Inversion of Everett's Formula

25.2.64

$$a_0 = f_0$$

$$a_1 = \delta_1 - \frac{\delta_0^2}{3} - \frac{\delta_1^2}{6} + \frac{\delta_0^4}{20} + \frac{\delta_1^4}{30} + \dots$$

$$a_2 = \frac{\delta_0^2}{2} - \frac{\delta_0^4}{24} + \dots$$

$$a_3 = \frac{-\delta_0^2 + \delta_1^2}{6} - \frac{\delta_0^4 + \delta_1^4}{24} + \dots$$

$$a_4 = \frac{\delta_0^4}{24} + \dots$$

$$a_5 = \frac{-\delta_0^4 + \delta_1^4}{120} + \dots$$

(Used in conjunction with 25.2.62.)

Bivariate Interpolation

Three Point Formula (Linear)

25.2.65

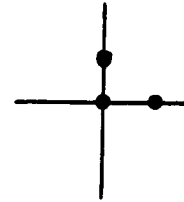

$$f(x_0 + ph, y_0 + qk) = (1 - p - q)f_{0,0} + pf_{1,0} + qf_{0,1} + O(h^2)$$

Four Point Formula

25.2.66

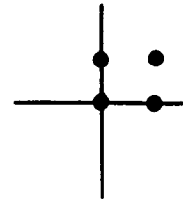

$$f(x_0 + ph, y_0 + qk) = (1 - p)(1 - q)f_{0,0} + p(1 - q)f_{1,0} + q(1 - p)f_{0,1} + pqf_{1,1} + O(h^2)$$

Six Point Formula

25.2.67

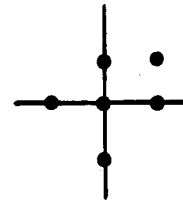

$$f(x_0 + ph, y_0 + qk) = \frac{q(q-1)}{2} f_{0,-1} + \frac{p(p-1)}{2} f_{-1,0} + (1 + pq - p^2 - q^2) f_{0,0} + \frac{p(p-2q+1)}{2} f_{1,0} + \frac{q(q-2p+1)}{2} f_{0,1} + pqf_{1,1} + O(h^3)$$

25.3. Differentiation

Lagrange's Formula

25.3.1

$$f'(x) = \sum_{k=0}^n l'_k(x) f_k + R'_n(x)$$

(See 25.2.1.)

25.3.2

$$l'_k(x) = \sum_{\substack{j=0 \\ j \neq k}}^n \frac{\pi_n(x)}{(x - x_k)(x - x_j) \pi'_n(x_k)}$$

25.3.3

$$R'_n(x) = \frac{f^{(n+1)}}{(n+1)!} (\xi) \pi'_n(x) + \frac{\pi_n(x)}{(n+1)!} \frac{d}{dx} f^{(n+1)}(\xi)$$

$$\xi = \xi(x) \quad (x_0 < \xi < x_n)$$

Equally Spaced Abscissas

Three Points

25.3.4

$$f'_p = f'(x_0 + ph)$$

$$= \frac{1}{h} \left\{ (p - \frac{1}{2}) f_{-1} - 2p f_0 + (p + \frac{1}{2}) f_1 \right\} + R'_2$$

Four Points

25.3.5

$$f'_p = f'(x_0 + ph) = \frac{1}{h} \left\{ -\frac{3p^2 - 6p + 2}{6} f_{-1} \right.$$

$$+ \frac{3p^2 - 4p - 1}{2} f_0 - \frac{3p^2 - 2p - 2}{2} f_1$$

$$\left. + \frac{3p^2 - 1}{6} f_2 \right\} + R'_3$$

Five Points

25.3.6

$$f'_p = f'(x_0 + ph) = \frac{1}{h} \left\{ \frac{2p^3 - 3p^2 - p + 1}{12} f_{-2} \right.$$

$$- \frac{4p^3 - 3p^2 - 8p + 4}{6} f_{-1} + \frac{2p^3 - 5p}{2} f_0$$

$$- \frac{4p^3 + 3p^2 - 8p - 4}{6} f_1$$

$$\left. + \frac{2p^3 + 3p^2 - p - 1}{12} f_2 \right\} + R'_4$$

For numerical values of differentiation coefficients see Table 25.2.

Markoff's Formulas

(Newton's Forward Difference Formula Differentiated)

25.3.7

$$f'(a_0 + ph) = \frac{1}{h} \left[\Delta_0 + \frac{2p-1}{2} \Delta_0^2 \right.$$

$$+ \frac{3p^2 - 6p + 2}{6} \Delta_0^3 + \dots + \frac{d}{dp} \binom{p}{n} \Delta_0^n \left. \right] + R'_n$$

25.3.8

$$R'_n = h^n f^{(n+1)}(\xi) \frac{d}{dp} \binom{p}{n+1} + h^{n+1} \binom{p}{n+1} \frac{d}{dx} f^{(n+1)}(\xi)$$

$$(a_0 < \xi < a_n)$$

25.3.9 $h f'_0 = \Delta_0 - \frac{1}{2} \Delta_0^2 + \frac{1}{3} \Delta_0^3 - \frac{1}{4} \Delta_0^4 + \dots$

25.3.10 $h^2 f''_0 = \Delta_0^2 - \Delta_0^3 + \frac{11}{12} \Delta_0^4 - \frac{5}{6} \Delta_0^5 + \dots$

25.3.11

$$h^3 f'''_0 = \Delta_0^3 - \frac{3}{2} \Delta_0^4 + \frac{7}{4} \Delta_0^5 - \frac{15}{8} \Delta_0^6 + \dots$$

25.3.12

$$h^4 f^{(4)}_0 = \Delta_0^4 - 2\Delta_0^5 + \frac{17}{6} \Delta_0^6 - \frac{7}{2} \Delta_0^7 + \dots$$

25.3.13

$$h^5 f^{(5)}_0 = \Delta_0^5 - \frac{5}{2} \Delta_0^6 + \frac{25}{6} \Delta_0^7 - \frac{35}{6} \Delta_0^8 + \dots$$

Everett's Formula

25.3.14

$$h f'(x_0 + ph) \approx -f_0 + f_1 - \frac{3p^2 - 6p + 2}{6} \delta_0^2 + \frac{3p^2 - 1}{6} \delta_1^2$$

$$- \frac{5p^4 - 20p^3 + 15p^2 + 10p - 6}{120} \delta_0^4 + \frac{5p^4 - 15p^2 + 4}{120} \delta_1^4$$

$$+ \dots - \left[\binom{p+n-1}{2n+1} \right]' \delta_0^{2n} + \left[\binom{p+n}{2n+1} \right]' \delta_1^{2n}$$

25.3.15

$$h f'_0 \approx -f_0 + f_1 - \frac{1}{3} \delta_0^2 - \frac{1}{6} \delta_1^2 + \frac{1}{20} \delta_0^4 + \frac{1}{30} \delta_1^4$$

Differences in Terms of Derivatives

25.3.16

$$\Delta_0 \approx h f'_0 + \frac{h^2}{2!} f''_0 + \frac{h^3}{3!} f'''_0 + \frac{h^4}{4!} f^{(4)}_0 + \frac{h^5}{5!} f^{(5)}_0$$

25.3.17

$$\Delta_0^2 \approx h^2 f''_0 + h^3 f'''_0 + \frac{7}{12} h^4 f^{(4)}_0 + \frac{1}{4} h^5 f^{(5)}_0$$

25.3.18

$$\Delta_0^3 \approx h^3 f'''_0 + \frac{3}{2} h^4 f^{(4)}_0 + \frac{5}{4} h^5 f^{(5)}_0$$

25.3.19

$$\Delta_0^4 \approx h^4 f^{(4)}_0 + 2h^5 f^{(5)}_0$$

25.3.20

$$\Delta_0^5 \approx h^5 f^{(5)}_0$$

Partial Derivatives

25.3.21

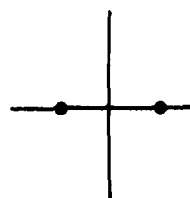

$$\frac{\partial f_{0,0}}{\partial x} = \frac{1}{2h} (f_{1,0} - f_{-1,0}) + O(h^2)$$

25.3.22

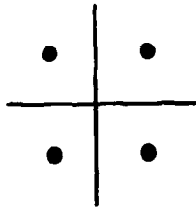

$$\frac{\partial f_{0,0}}{\partial x} = \frac{1}{4h} (f_{1,1} - f_{-1,1} + f_{1,-1} - f_{-1,-1}) + O(h^2)$$

25.3.23

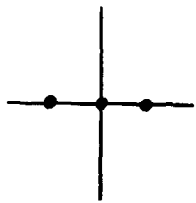

$$\frac{\partial^2 f_{0,0}}{\partial x^2} = \frac{1}{h^2} (f_{1,0} - 2f_{0,0} + f_{-1,0}) + O(h^2)$$

25.3.24

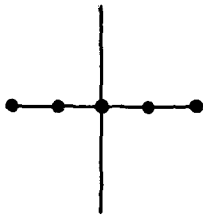

$$\frac{\partial^2 f_{0,0}}{\partial x^2} = \frac{1}{12h^2} (-f_{2,0} + 16f_{1,0} - 30f_{0,0} + 16f_{-1,0} - f_{-2,0}) + O(h^4)$$

25.3.25

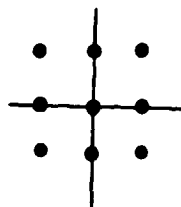

$$\frac{\partial^2 f_{0,0}}{\partial x^2} = \frac{1}{3h^2} (f_{1,1} - 2f_{0,1} + f_{-1,1} + f_{1,0} - 2f_{0,0} + f_{-1,0} + f_{1,-1} - 2f_{0,-1} + f_{-1,-1}) + O(h^2)$$

25.3.26

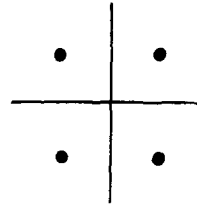

$$\frac{\partial^2 f_{0,0}}{\partial x \partial y} = \frac{1}{4h^2} (f_{1,1} - f_{1,-1} - f_{-1,1} + f_{-1,-1}) + O(h^2)$$

25.3.27

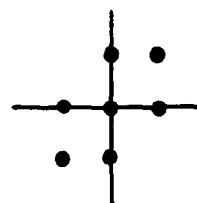

$$\frac{\partial^2 f_{0,0}}{\partial x \partial y} = \frac{-1}{2h^2} (f_{1,0} + f_{-1,0} + f_{0,1} + f_{0,-1} - 2f_{0,0} - f_{1,1} - f_{-1,-1}) + O(h^2)$$

25.3.28

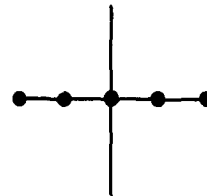

$$\frac{\partial^4 f_{0,0}}{\partial x^4} = \frac{1}{h^4} (f_{2,0} - 4f_{1,0} + 6f_{0,0} - 4f_{-1,0} + f_{-2,0}) + O(h^2)$$

25.3.29

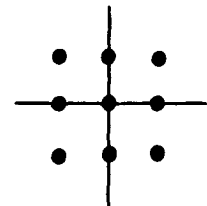

$$\frac{\partial^4 f_{0,0}}{\partial x^2 \partial y^2} = \frac{1}{h^4} (f_{1,1} + f_{-1,1} + f_{1,-1} + f_{-1,-1} - 2f_{1,0} - 2f_{-1,0} - 2f_{0,1} - 2f_{0,-1} + 4f_{0,0}) + O(h^2)$$

Laplacian

25.3.30

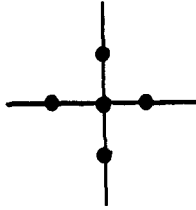

$$\begin{aligned} \nabla^2 u_{0,0} &= \left(\frac{\partial^2 u}{\partial x^2} + \frac{\partial^2 u}{\partial y^2} \right)_{0,0} \\ &= \frac{1}{h^2} (u_{1,0} + u_{0,1} + u_{-1,0} + u_{0,-1} - 4u_{0,0}) + O(h^2) \end{aligned}$$

25.3.31

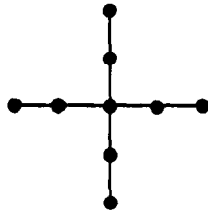

$$\begin{aligned} \nabla^4 u_{0,0} &= \frac{1}{12h^2} [-60u_{0,0} + 16(u_{1,0} + u_{0,1} + u_{-1,0} + u_{0,-1}) \\ &\quad - (u_{2,0} + u_{0,2} + u_{-2,0} + u_{0,-2})] + O(h^4) \end{aligned}$$

Biharmonic Operator

25.3.32

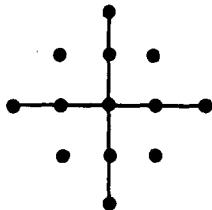

$$\begin{aligned} \nabla^4 u_{0,0} &= \left(\frac{\partial^4 u}{\partial x^4} + 2 \frac{\partial^4 u}{\partial x^2 \partial y^2} + \frac{\partial^4 u}{\partial y^4} \right)_{0,0} \\ &= \frac{1}{h^4} [20u_{0,0} - 8(u_{1,0} + u_{0,1} + u_{-1,0} + u_{0,-1}) \\ &\quad + 2(u_{1,1} + u_{1,-1} + u_{-1,1} + u_{-1,-1}) \\ &\quad + (u_{0,2} + u_{2,0} + u_{-2,0} + u_{0,-2})] + O(h^2) \end{aligned}$$

25.3.33

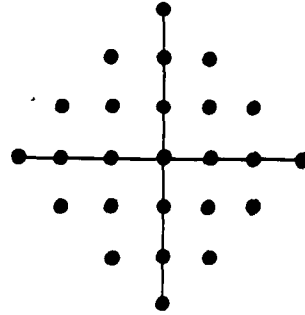

$$\begin{aligned} \nabla^4 u_{0,0} &= \frac{1}{6h^4} [- (u_{0,3} + u_{0,-3} + u_{3,0} + u_{-3,0}) \\ &\quad + 14(u_{0,2} + u_{0,-2} + u_{2,0} + u_{-2,0}) \\ &\quad - 77(u_{0,1} + u_{0,-1} + u_{1,0} + u_{-1,0}) \\ &\quad + 184u_{0,0} + 20(u_{1,1} + u_{1,-1} + u_{-1,1} + u_{-1,-1}) \\ &\quad - (u_{1,2} + u_{2,1} + u_{1,-2} + u_{2,-1} + u_{-1,2} + u_{-2,1} \\ &\quad \quad + u_{-1,-2} + u_{-2,-1})] + O(h^4) \end{aligned}$$

25.4. Integration

Trapezoidal Rule

25.4.1

$$\begin{aligned} \int_{x_0}^{x_1} f(x) dx &= \frac{h}{2} (f_0 + f_1) - \frac{1}{2} \int_{x_0}^{x_1} (t - x_0)(x_1 - t) f''(t) dt \\ &= \frac{h}{2} (f_0 + f_1) - \frac{h^3}{12} f''(\xi) \quad (x_0 < \xi < x_1) \end{aligned}$$

Extended Trapezoidal Rule

25.4.2

$$\begin{aligned} \int_{x_0}^{x_m} f(x) dx &= h \left[\frac{f_0}{2} + f_1 + \dots + f_{m-1} + \frac{f_m}{2} \right] \\ &\quad - \frac{mh^3}{12} f''(\xi) \end{aligned}$$

Error Term in Trapezoidal Formula for Periodic Functions

If $f(x)$ is periodic and has a continuous k^{th} derivative, and if the integral is taken over a period, then

$$25.4.3 \quad |\text{Error}| \leq \frac{\text{constant}}{m^k}$$

Modified Trapezoidal Rule

25.4.4

$$\begin{aligned} \int_{x_0}^{x_m} f(x) dx &= h \left[\frac{f_0}{2} + f_1 + \dots + f_{m-1} + \frac{f_m}{2} \right] \\ &\quad + \frac{h}{24} [-f_{-1} + f_1 + f_{m-1} - f_{m+1}] + \frac{11m}{720} h^5 f^{(4)}(\xi) \end{aligned}$$

Simpson's Rule

25.4.5

$$\int_{x_0}^{x_2} f(x) dx = \frac{h}{3} [f_0 + 4f_1 + f_2] \\ + \frac{1}{6} \int_{x_0}^{x_1} (x_0 - t)^2 (x_1 - t) f^{(3)}(t) dt \\ + \frac{1}{6} \int_{x_1}^{x_2} (x_2 - t)^2 (x_1 - t) f^{(3)}(t) dt \\ = \frac{h}{3} [f_0 + 4f_1 + f_2] - \frac{h^5}{90} f^{(4)}(\xi)$$

Extended Simpson's Rule

25.4.6

$$\int_{x_0}^{x_{2n}} f(x) dx = \frac{h}{3} [f_0 + 4(f_1 + f_3 + \dots + f_{2n-1}) \\ + 2(f_2 + f_4 + \dots + f_{2n-2}) + f_{2n}] - \frac{nh^5}{90} f^{(4)}(\xi)$$

Euler-Maclaurin Summation Formula

25.4.7

$$\int_{x_0}^{x_n} f(x) dx = h \left[\frac{f_0}{2} + f_1 + f_2 + \dots + f_{n-1} + \frac{f_n}{2} \right] \\ - \frac{B_2}{2!} h^2 (f'_n - f'_0) - \dots - \frac{B_{2k} h^{2k}}{(2k)!} [f^{(2k-1)}_n - f^{(2k-1)}_0] + R_{2k} \\ R_{2k} = \frac{\theta n B_{2k+2} h^{2k+3}}{(2k+2)!} \max_{x_0 \leq x \leq x_n} |f^{(2k+2)}(x)|, \quad (-1 \leq \theta \leq 1)$$

(For B_{2k} , Bernoulli numbers, see chapter 23.)

If $f^{(2k+2)}(x)$ and $f^{(2k+4)}(x)$ do not change sign for $x_0 < x < x_n$ then $|R_{2k}|$ is less than the first neglected term. If $f^{(2k+2)}(x)$ does not change sign for $x_0 < x < x_n$, $|R_{2k}|$ is less than twice the first neglected term.

Lagrange Formula

25.4.8

$$\int_a^b f(x) dx = \sum_{i=0}^n (L_i^{(n)}(b) - L_i^{(n)}(a)) f_i + R_n$$

(See 25.2.1.)

25.4.9

$$L_i^{(n)}(x) = \frac{1}{\pi'_n(x_i)} \int_{x_0}^x \frac{\pi_n(t)}{t - x_i} dt = \int_{x_0}^x l_i(t) dt$$

$$25.4.10 \quad R_n = \frac{1}{(n+1)!} \int_a^b \pi_n(x) f^{(n+1)}(\xi(x)) dx$$

Equally Spaced Abscissas

25.4.11

$$\int_{x_0}^{x_k} f(x) dx = \frac{1}{h^n} \sum_{i=0}^n f_i \frac{(-1)^{n-i}}{i!(n-i)!} \int_{x_0}^{x_k} \frac{\pi_n(x)}{x - x_i} dx + R_n$$

$$25.4.12 \quad \int_{x_m}^{x_{m+1}} f(x) dx = h \sum_{i=-\lfloor \frac{n-1}{2} \rfloor}^{\lfloor \frac{n}{2} \rfloor} A_i(m) f_i + R_n \quad *$$

(See Table 25.3 for $A_i(m)$.)

Newton-Cotes Formulas (Closed Type)

(For Trapezoidal and Simpson's Rules see 25.4.1-25.4.6.)

25.4.13 (Simpson's $\frac{3}{8}$ rule)

$$\int_{x_0}^{x_3} f(x) dx = \frac{3h}{8} (f_0 + 3f_1 + 3f_2 + f_3) - \frac{3f^{(4)}(\xi)h^5}{80}$$

25.4.14

(Bode's rule)

$$\int_{x_0}^{x_4} f(x) dx = \frac{2h}{45} (7f_0 + 32f_1 + 12f_2 \\ + 32f_3 + 7f_4) - \frac{8f^{(6)}(\xi)h^7}{945}$$

25.4.15

$$\int_{x_0}^{x_5} f(x) dx = \frac{5h}{288} (19f_0 + 75f_1 + 50f_2 + 50f_3 \\ + 75f_4 + 19f_5) - \frac{275f^{(6)}(\xi)h^7}{12096}$$

25.4.16

$$\int_{x_0}^{x_6} f(x) dx = \frac{h}{140} (41f_0 + 216f_1 + 27f_2 + 272f_3 \\ + 27f_4 + 216f_5 + 41f_6) - \frac{9f^{(8)}(\xi)h^9}{1400}$$

25.4.17

$$\int_{x_0}^{x_7} f(x) dx = \frac{7h}{17280} (751f_0 + 3577f_1 + 1323f_2 \\ + 2989f_3 + 2989f_4 + 1323f_5 + 3577f_6 \\ + 751f_7) - \frac{8183f^{(8)}(\xi)h^9}{518400}$$

25.4.18

$$\int_{x_0}^{x_8} f(x) dx = \frac{4h}{14175} (989f_0 + 5888f_1 - 928f_2 \\ + 10496f_3 - 4540f_4 + 10496f_5 - 928f_6 + 5888f_7 \\ + 989f_8) - \frac{2368}{467775} f^{(10)}(\xi)h^{11}$$

25.4.19

$$\int_{x_0}^{x_9} f(x) dx = \frac{9h}{89600} \{ 2857(f_0 + f_9) \\ + 15741(f_1 + f_8) + 1080(f_2 + f_7) + 19344(f_3 + f_6) \\ + 5778(f_4 + f_5) \} - \frac{173}{14620} f^{(10)}(\xi)h^{11}$$

*See page II.

25.4.20

$$\int_{x_0}^{x_{10}} f(x)dx = \frac{5h}{299376} \{16067(f_0+f_{10}) + 106300(f_1+f_9) - 48525(f_2+f_8) + 272400(f_3+f_7) - 260550(f_4+f_6) + 427368f_5\} - \frac{1346350}{326918592} f^{(12)}(\xi)h^{13}$$

Newton-Cotes Formulas (Open Type)

25.4.21

$$\int_{x_0}^{x_3} f(x)dx = \frac{3h}{2} (f_1+f_2) + \frac{f^{(2)}(\xi)h^3}{4}$$

25.4.22

$$\int_{x_0}^{x_4} f(x)dx = \frac{4h}{3} (2f_1-f_2+2f_3) + \frac{28f^{(4)}(\xi)h^5}{90}$$

25.4.23

$$\int_{x_0}^{x_5} f(x)dx = \frac{5h}{24} (11f_1+f_2+f_3+11f_4) + \frac{95f^{(4)}(\xi)h^5}{144}$$

25.4.24

$$\int_{x_0}^{x_6} f(x)dx = \frac{6h}{20} (11f_1-14f_2+26f_3-14f_4+11f_5) + \frac{41f^{(6)}(\xi)h^7}{140}$$

25.4.25

$$\int_{x_0}^{x_7} f(x)dx = \frac{7h}{1440} (611f_1-453f_2+562f_3+562f_4 - 453f_5+611f_6) + \frac{5257}{8640} f^{(8)}(\xi)h^7$$

25.4.26

$$\int_{x_0}^{x_8} f(x)dx = \frac{8h}{945} (460f_1-954f_2+2196f_3-2459f_4 + 2196f_5-954f_6+460f_7) + \frac{3956}{14175} f^{(8)}(\xi)h^9$$

Five Point Rule for Analytic Functions

25.4.27

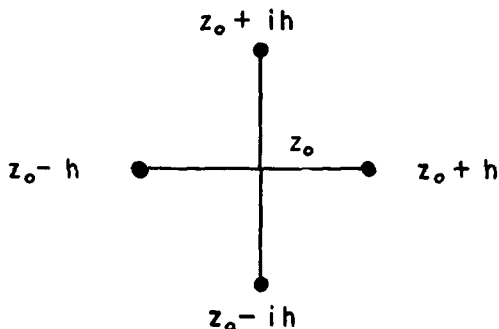

$$\int_{z_0-h}^{z_0+h} f(z)dz = \frac{h}{15} \{24f(z_0) + 4[f(z_0+h) + f(z_0-h)] - [f(z_0+ih) + f(z_0-ih)]\} + R$$

$|R| \leq \frac{|h|^7}{1890} \text{Max}_{z \in S} |f^{(6)}(z)|$, S designates the square with vertices $z_0 + i^k h$ ($k=0, 1, 2, 3$); h can be complex.

Chebyshev's Equal Weight Integration Formula

25.4.28
$$\int_{-1}^1 f(x)dx = \frac{2}{n} \sum_{i=1}^n f(x_i) + R_n$$

Abscissas: x_i is the i^{th} zero of the polynomial part of

$$x^n \exp \left[\frac{-n}{2 \cdot 3x^2} - \frac{n}{4 \cdot 5x^3} - \frac{n}{6 \cdot 7x^4} - \dots \right]$$

(See Table 25.5 for x_i .)

For $n=8$ and $n \geq 10$ some of the zeros are complex.

Remainder:

$$R_n = \int_{-1}^{+1} \frac{x^{n+1}}{(n+1)!} f^{(n+1)}(\xi)dx - \frac{2}{n(n+1)!} \sum_{i=1}^n x_i^{n+1} f^{(n+1)}(\xi_i)$$

where $\xi = \xi(x)$ satisfies $0 \leq \xi \leq x$ and $0 \leq \xi_i \leq x_i$

$$(i=1, \dots, n)$$

Integration Formulas of Gaussian Type

(For Orthogonal Polynomials see chapter 22)

Gauss' Formula

25.4.29
$$\int_{-1}^1 f(x)dx = \sum_{i=1}^n w_i f(x_i) + R_n$$

Related orthogonal polynomials: Legendre polynomials $P_n(x)$, $P_n(1) = 1$

Abscissas: x_i is the i^{th} zero of $P_n(x)$

Weights: $w_i = 2/(1-x_i^2) [P_n'(x_i)]^2$
(See Table 25.4 for x_i and w_i .)

$$R_n = \frac{2^{2n+1}(n!)^4}{(2n+1)[(2n)!]^3} f^{(2n)}(\xi) \quad (-1 < \xi < 1)$$

Gauss' Formula, Arbitrary Interval

25.4.30
$$\int_a^b f(y)dy = \frac{b-a}{2} \sum_{i=1}^n w_i f(y_i) + R_n$$

$$y_i = \left(\frac{b-a}{2}\right) x_i + \left(\frac{b+a}{2}\right)$$

*See page 11.

Related orthogonal polynomials: $P_n(x), P_n(1)=1$

Abscissas: x_i is the i^{th} zero of $P_n(x)$

* Weights: $w_i=2/(1-x_i) [P'_n(x_i)]^2$

$$R_n = \frac{(b-a)^{2n+1} (n!)^4}{(2n+1) [(2n)!]^3} f^{(2n)}(\xi)$$

Radau's Integration Formula

25.4.31

$$\int_{-1}^1 f(x) dx = \frac{2}{n^2} f_{-1} + \sum_{i=1}^{n-1} w_i f(x_i) + R_n$$

Related polynomials:

$$\frac{P_{n-1}(x) + P_n(x)}{x+1}$$

Abscissas: x_i is the i^{th} zero of

$$\frac{P_{n-1}(x) + P_n(x)}{x+1}$$

Weights:

$$w_i = \frac{1}{n^2} \frac{1-x_i}{[P_{n-1}(x_i)]^2} = \frac{1}{1-x_i} \frac{1}{[P'_{n-1}(x_i)]^2}$$

Remainder:

$$R_n = \frac{2^{2n-1} \cdot n}{[(2n-1)!]^3} [(n-1)!]^4 f^{(2n-1)}(\xi) \quad (-1 < \xi < 1)$$

Lobatto's Integration Formula

25.4.32

$$\int_{-1}^1 f(x) dx = \frac{2}{n(n-1)} [f(1) + f(-1)] + \sum_{i=2}^{n-1} w_i f(x_i) + R_n$$

Related polynomials: $P'_{n-1}(x)$

Abscissas: x_i is the $(i-1)^{\text{st}}$ zero of $P'_{n-1}(x)$

Weights:

$$w_i = \frac{2}{n(n-1) [P_{n-1}(x_i)]^2} \quad (x_i \neq \pm 1)$$

(See Table 25.6 for x_i and w_i .)

Remainder:

$$R_n = \frac{-n(n-1)^3 2^{2n-1} [(n-2)!]^4}{(2n-1) [(2n-2)!]^3} f^{(2n-2)}(\xi) \quad (-1 < \xi < 1)$$

*See page 11.

25.4.33
$$\int_0^1 x^k f(x) dx = \sum_{i=1}^n w_i f(x_i) + R_n$$

Related orthogonal polynomials:

$$q_n(x) = \sqrt{k+2n+1} P_n^{(k,0)}(1-2x)$$

(For the Jacobi polynomials $P_n^{(k,0)}$ see chapter 22.)

Abscissas:

x_i is the i^{th} zero of $q_n(x)$

Weights:

$$w_i = \left\{ \sum_{j=0}^{n-1} [q_j(x_i)]^2 \right\}^{-1} \quad *$$

(See Table 25.8 for x_i and w_i .)

Remainder:

$$R_n = \frac{f^{(2n)}(\xi)}{(k+2n+1)(2n)!} \left[\frac{n!(k+n)!}{(k+2n)!} \right]^2 \quad (0 < \xi < 1)$$

25.4.34

$$\int_0^1 f(x) \sqrt{1-x} dx = \sum_{i=1}^n w_i f(x_i) + R_n$$

Related orthogonal polynomials:

$$\frac{1}{\sqrt{1-x}} P_{2n+1}(\sqrt{1-x}), P_{2n+1}(1)=1$$

Abscissas: $x_i = 1 - \xi_i^2$ where ξ_i is the i^{th} positive zero of $P_{2n+1}(x)$.

Weights: $w_i = 2\xi_i^2 w_i^{(2n+1)}$ where $w_i^{(2n+1)}$ are the Gaussian weights of order $2n+1$.

Remainder:

$$R_n = \frac{2^{4n+3} [(2n+1)!]^4}{(2n)! (4n+3) [(4n+2)!]^2} f^{(2n)}(\xi) \quad (0 < \xi < 1)$$

25.4.35

$$\int_a^b f(y) \sqrt{b-y} dy = (b-a)^{3/2} \sum_{i=1}^n w_i f(y_i)$$

$$y_i = a + (b-a)x_i$$

Related orthogonal polynomials:

$$\frac{1}{\sqrt{1-x}} P_{2n+1}(\sqrt{1-x}), P_{2n+1}(1)=1$$

Abscissas: $x_i = 1 - \xi_i^2$ where ξ_i is the i^{th} positive zero of $P_{2n+1}(x)$.

Weights: $w_i = 2\xi_i^2 w_i^{(2n+1)}$ where $w_i^{(2n+1)}$ are the Gaussian weights of order $2n+1$.

25.4.36 $\int_0^1 \frac{f(x)}{\sqrt{1-x}} dx = \sum_{i=1}^n w_i f(x_i) + R_n$

Related orthogonal polynomials:

$$P_{2n}(\sqrt{1-x}), P_{2n}(1) = 1$$

Abscissas: $x_i = 1 - \xi_i^2$ where ξ_i is the i^{th} positive zero of $P_{2n}(x)$.

Weights: $w_i = 2w_i^{(2n)}$, $w_i^{(2n)}$ are the Gaussian weights of order $2n$.

Remainder:

$$R_n = \frac{2^{4n+1}}{4n+1} \frac{[(2n)!]^3}{[(4n)!]^2} f^{(2n)}(\xi) \quad (0 < \xi < 1)$$

25.4.37 $\int_a^b \frac{f(y)}{\sqrt{b-y}} dy = \sqrt{b-a} \sum_{i=1}^n w_i f(y_i) + R_n$
 $y_i = a + (b-a)x_i$

Related orthogonal polynomials:

$$P_{2n}(\sqrt{1-x}), P_{2n}(1) = 1$$

Abscissas:

$x_i = 1 - \xi_i^2$ where ξ_i is the i^{th} positive zero of $P_{2n}(x)$.

Weights: $w_i = 2w_i^{(2n)}$, $w_i^{(2n)}$ are the Gaussian weights of order $2n$.

25.4.38 $\int_{-1}^{+1} \frac{f(x)}{\sqrt{1-x^2}} dx = \sum_{i=1}^n w_i f(x_i) + R_n$

Related orthogonal polynomials: Chebyshev Polynomials of First Kind

$$T_n(x), T_n(1) = \frac{1}{2^{n-1}}$$

Abscissas:

$$x_i = \cos \frac{(2i-1)\pi}{2n}$$

Weights:

$$w_i = \frac{\pi}{n}$$

Remainder:

$$R_n = \frac{\pi}{(2n)! 2^{2n-1}} f^{(2n)}(\xi) \quad (-1 < \xi < 1)$$

25.4.39

$$\int_a^b \frac{f(y)dy}{\sqrt{(y-a)(b-y)}} = \sum_{i=1}^n w_i f(y_i) + R_n$$

$$y_i = \frac{b+a}{2} + \frac{b-a}{2} x_i$$

Related orthogonal polynomials:

$$T_n(x), T_n(1) = \frac{1}{2^{n-1}}$$

Abscissas:

$$x_i = \cos \frac{(2i-1)\pi}{2n}$$

Weights:

$$w_i = \frac{\pi}{n}$$

25.4.40

$$\int_{-1}^{+1} f(x) \sqrt{1-x^2} dx = \sum_{i=1}^n w_i f(x_i) + R_n$$

Related orthogonal polynomials: Chebyshev Polynomials of Second Kind

$$U_n(x) = \frac{\sin [(n+1) \arccos x]}{\sin (\arccos x)} \quad *$$

Abscissas:

$$x_i = \cos \frac{i}{n+1} \pi \quad *$$

Weights:

$$w_i = \frac{\pi}{n+1} \sin^2 \frac{i}{n+1} \pi \quad *$$

Remainder:

$$R_n = \frac{\pi}{(2n)! 2^{2n+1}} f^{(2n)}(\xi) \quad (-1 < \xi < 1)$$

25.4.41

$$\int_a^b \sqrt{(y-a)(b-y)} f(y) dy = \left(\frac{b-a}{2}\right)^2 \sum_{i=1}^n w_i f(y_i) + R_n$$

$$y_i = \frac{b+a}{2} + \frac{b-a}{2} x_i$$

Related orthogonal polynomials:

$$U_n(x) = \frac{\sin [(n+1) \arccos x]}{\sin (\arccos x)} \quad *$$

Abscissas:

$$x_i = \cos \frac{i}{n+1} \pi \quad *$$

Weights:

$$w_i = \frac{\pi}{n+1} \sin^2 \frac{i}{n+1} \pi \quad *$$

25.4.42 $\int_0^1 f(x) \sqrt{\frac{x}{1-x}} dx = \sum_{i=1}^n w_i f(x_i) + R_n$

Related orthogonal polynomials:

$$\frac{1}{\sqrt{x}} T_{2n+1}(\sqrt{x})$$

Abscissas:

$$x_i = \cos^2 \frac{2i-1}{2n+1} \cdot \frac{\pi}{2}$$

Weights:

$$w_i = \frac{2\pi}{2n+1} x_i$$

*See page 11.

Remainder:

$$R_n = \frac{\pi}{(2n)! 2^{4n+1}} f^{(2n)}(\xi) \quad (0 < \xi < 1)$$

25.4.43

$$\int_a^b f(x) \sqrt{\frac{x-a}{b-x}} dx = (b-a) \sum_{i=1}^n w_i f(y_i) + R_n$$

$$y_i = a + (b-a)x_i$$

Related orthogonal polynomials:

$$\frac{1}{\sqrt{x}} T_{2n+1}(\sqrt{x})$$

Abscissas:

$$x_i = \cos^2 \frac{2i-1}{2n+1} \frac{\pi}{2}$$

Weights:

$$w_i = \frac{2\pi}{2n+1} x_i$$

25.4.44 $\int_0^1 \ln x f(x) dx = \sum_{i=1}^n w_i f(x_i) + R_n$

Related orthogonal polynomials: polynomials orthogonal with respect to the weight function $-\ln x$

Abscissas: See Table 25.7

Weights: See Table 25.7

25.4.45

$$\int_0^\infty e^{-x} f(x) dx = \sum_{i=1}^n w_i f(x_i) + R_n$$

Related orthogonal polynomials: Laguerre polynomials $L_n(x)$.

Abscissas: x_i is the i^{th} zero of $L_n(x)$

Weights:

$$w_i = \frac{(n!)^2 x_i}{(n+1)^2 [L_{n+1}(x_i)]^2}$$

(See Table 25.9 for x_i and w_i .)

Remainder:

$$R_n = \frac{(n!)^2}{(2n)!} f^{(2n)}(\xi) \quad (0 < \xi < \infty)$$

25.4.46

$$\int_{-\infty}^{\infty} e^{-x^2} f(x) dx = \sum_{i=1}^n w_i f(x_i) + R_n$$

Related orthogonal polynomials: Hermite polynomials $H_n(x)$.

Abscissas: x_i is the i^{th} zero of $H_n(x)$

Weights:

$$\frac{2^{n-1} n! \sqrt{\pi}}{n^2 [H_{n-1}(x_i)]^2}$$

(See Table 25.10 for x_i and w_i .)

Remainder:

$$R_n = \frac{n! \sqrt{\pi}}{2^n (2n)!} f^{(2n)}(\xi) \quad (-\infty < \xi < \infty)$$

Filon's Integration Formula³

25.4.47

$$\int_{x_0}^{x_n} f(x) \cos tx dx = h \left[\alpha(th) (f_{2n} \sin tx_n - f_0 \sin tx_0) + \beta(th) \cdot C_{2n} + \gamma(th) \cdot C_{2n-1} + \frac{2}{45} th^4 S'_{2n-1} \right] - R_n$$

25.4.48

$$C_{2n} = \sum_{i=0}^n f_{2i} \cos(tx_{2i}) - \frac{1}{2} [f_{2n} \cos tx_{2n} + f_0 \cos tx_0]$$

25.4.49

$$C_{2n-1} = \sum_{i=1}^n f_{2i-1} \cos tx_{2i-1}$$

25.4.50

$$S'_{2n-1} = \sum_{i=1}^n f_{2i-1}^{(3)} \sin tx_{2i-1}$$

25.4.51

$$R_n = \frac{1}{90} nh^5 f^{(4)}(\xi) + O(th^7)$$

25.4.52

$$\alpha(\theta) = \frac{1}{\theta} + \frac{\sin 2\theta}{2\theta^2} - \frac{2 \sin^2 \theta}{\theta^3}$$

$$\beta(\theta) = 2 \left(\frac{1 + \cos^2 \theta}{\theta^2} - \frac{\sin 2\theta}{\theta^3} \right)$$

$$\gamma(\theta) = 4 \left(\frac{\sin \theta}{\theta^3} - \frac{\cos \theta}{\theta^2} \right)$$

For small θ we have

25.4.53

$$\alpha = \frac{2\theta^3}{45} - \frac{2\theta^5}{315} + \frac{2\theta^7}{4725} - \dots$$

$$\beta = \frac{2}{3} + \frac{2\theta^2}{15} - \frac{4\theta^4}{105} + \frac{2\theta^6}{567} - \dots$$

$$\gamma = \frac{4}{3} - \frac{2\theta^2}{15} + \frac{\theta^4}{210} - \frac{\theta^6}{11340} + \dots$$

25.4.54

$$\int_{x_0}^{x_{2n}} f(x) \sin tx dx = h \left[\alpha(th) (f_0 \cos tx_0 - f_{2n} \cos tx_{2n}) + \beta S_{2n} + \gamma S_{2n-1} + \frac{2}{45} th^4 C'_{2n-1} \right] - R_n$$

25.4.55

$$S_{2n} = \sum_{i=0}^n f_{2i} \sin(tx_{2i}) - \frac{1}{2} [f_{2n} \sin(tx_{2n}) + f_0 \sin(tx_0)]$$

³ For certain difficulties associated with this formula, see the article by J. W. Tukey, p. 400, "On Numerical Approximation," Ed. R. E. Langer, Madison, 1959.

25.4.56 $S_{2n-1} = \sum_{i=1}^n f_{2i-1} \sin(tx_{2i-1})$

25.4.57 $C'_{2n-1} = \sum_{i=1}^n f_{2i-1}^{(3)} \cos(tx_{2i-1})$

(See Table 25.11 for α, β, γ .)

Iterated Integrals

25.4.58

$$\int_0^x dt_n \int_0^{t_n} dt_{n-1} \dots \int_0^{t_3} dt_2 \int_0^{t_2} f(t_1) dt_1$$

$$= \frac{1}{(n-1)!} \int_0^x (x-t)^{n-1} f(t) dt$$

25.4.59

$$\int_a^x dt_n \int_a^{t_n} dt_{n-1} \dots \int_a^{t_3} dt_2 \int_a^{t_2} f(t_1) dt_1$$

$$= \frac{(x-a)^n}{(n-1)!} \int_0^1 t^{n-1} f(x-(x-a)t) dt$$

Multidimensional Integration

Circumference of Circle $\Gamma: x^2 + y^2 = h^2$.

25.4.60

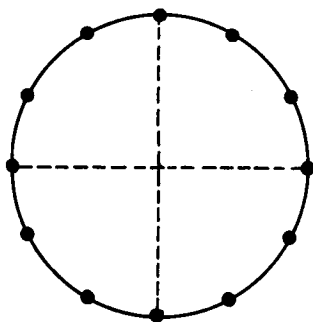

$$\frac{1}{2\pi h} \int_{\Gamma} f(x, y) ds = \frac{1}{2m} \sum_{n=1}^{2m} f\left(h \cos \frac{\pi n}{m}, h \sin \frac{\pi n}{m}\right) + O(h^{2m-2})$$

Circle $C: x^2 + y^2 \leq h^2$.

25.4.61

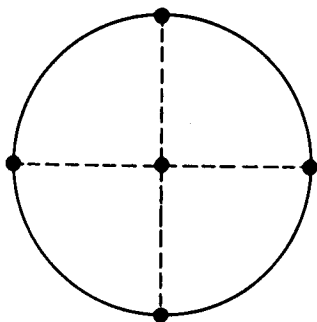

$$\frac{1}{\pi h^2} \iint_C f(x, y) dx dy = \sum_{i=1}^n w_i f(x_i, y_i) + R$$

(x_i, y_i)	w_i	
$(0, 0)$	$1/2$	$R = O(h^4)$
$(\pm h, 0), (0, \pm h)$	$1/8$	

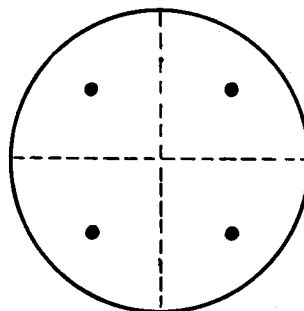

(x_i, y_i)	w_i	
$(\pm \frac{h}{2}, \pm \frac{h}{2})$	$1/4$	$R = O(h^4)$

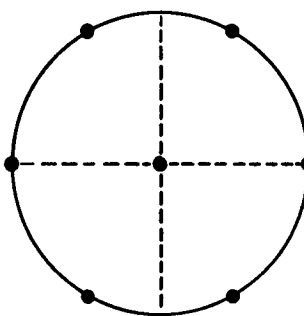

(x_i, y_i)	w_i	
$(0, 0)$	$1/2$	
$(\pm h, 0)$	$1/12$	$R = O(h^4)$
$(\pm \frac{h}{2}, \pm \frac{h}{2} \sqrt{3})$	$1/12$	

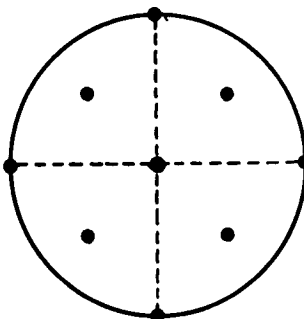

(x_i, y_i)	w_i	
$(0, 0)$	$1/6$	
$(\pm h, 0)$	$1/24$	$R = O(h^6)$
$(0, \pm h)$	$1/24$	
$(\pm \frac{h}{2}, \pm \frac{h}{2})$	$1/6$	

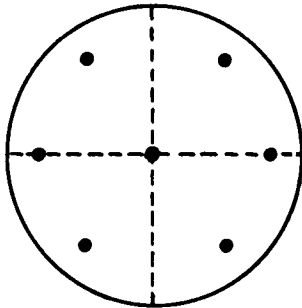

(x_i, y_i)	w_i	
$(0, 0)$	$1/4$	
$(\pm \sqrt{\frac{2}{3}}h, 0)$	$1/8$	$R = O(h^6)$
$(\pm \sqrt{\frac{1}{6}}h, \pm \frac{h}{2}\sqrt{2})$	$1/8$	

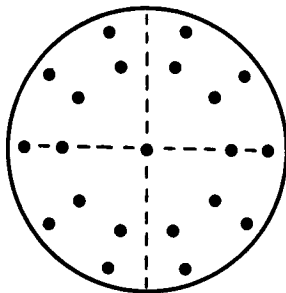

(x_i, y_i)	w_i
$(0, 0)$	$1/9$
$(\sqrt{\frac{6-\sqrt{6}}{10}}h \cos \frac{2\pi k}{10}, \sqrt{\frac{6-\sqrt{6}}{10}}h \sin \frac{2\pi k}{10})$	$\frac{16+\sqrt{6}}{360}$
	$(k=1, \dots, 10)$
$(\sqrt{\frac{6+\sqrt{6}}{10}}h \cos \frac{2\pi k}{10}, \sqrt{\frac{6+\sqrt{6}}{10}}h \sin \frac{2\pi k}{10})$	$\frac{16-\sqrt{6}}{360}$
	$R = O(h^{10})$

Square⁴ $S: |x| \leq h, |y| \leq h$

25.4.62

$$\frac{1}{4h^2} \iint_S f(x, y) dx dy = \sum_{i=1}^n w_i f(x_i, y_i) + R$$

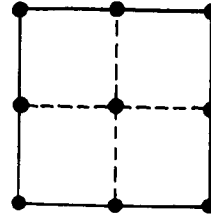

(x_i, y_i)	w_i	
$(0, 0)$	$4/9$	
$(\pm h, \pm h)$	$1/36$	$R = O(h^4)$
$(\pm h, 0)$	$1/9$	
$(0, \pm h)$	$1/9$	

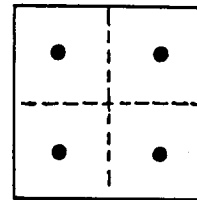

(x_i, y_i)	w_i	
$(\pm h\sqrt{\frac{1}{3}}, \pm h\sqrt{\frac{1}{3}})$	$1/4$	$R = O(h^4)$

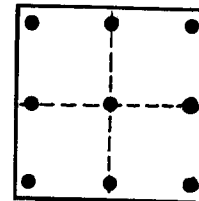

(x_i, y_i)	w_i
$(0, 0)$	$16/81$

⁴ For regions, such as the square, cube, cylinder, etc., which are the Cartesian products of lower dimensional regions, one may always develop integration rules by "multiplying together" the lower dimensional rules. Thus if

$$\int_0^1 f(x) dx \approx \sum_{i=1}^n w_i f(x_i)$$

is a one dimensional rule, then

$$\int_0^1 \int_0^1 f(x, y) dx dy \approx \sum_{i,j=1}^n w_i w_j f(x_i, y_j)$$

becomes a two dimensional rule. Such rules are not necessarily the most "economical".

$(\pm\sqrt{\frac{3}{5}}h, \pm\sqrt{\frac{3}{5}}h)$	25/324	$R=O(h^6)$
$(0, \pm\sqrt{\frac{3}{5}}h)$	10/81	
$(\pm\sqrt{\frac{3}{5}}h, 0)$	10/81	

Equilateral Triangle T

Radius of Circumscribed Circle= h

25.4.63

$$\frac{1}{\frac{3}{4}\sqrt{3}h^2} \iint_T f(x,y) dx dy = \sum_{i=1}^n w_i f(x_i, y_i) + R$$

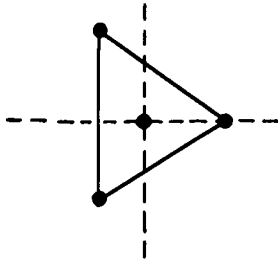

(x_i, y_i)	w_i	$R=O(h^3)$
$(0, 0)$	3/4	
$(h, 0)$	1/12	
$(-\frac{h}{2}, \pm\frac{h}{2}\sqrt{3})$	1/12	

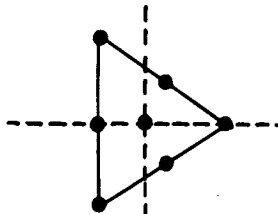

(x_i, y_i)	w_i	$R=O(h^4)$
$(0, 0)$	27/60	
$(h, 0)$	3/60	
$(-\frac{h}{2}, \pm\frac{h}{2}\sqrt{3})$	3/60	
$(-\frac{h}{2}, 0)$	8/60	
$(\frac{h}{4}, \pm\frac{h}{4}\sqrt{3})$	8/60	

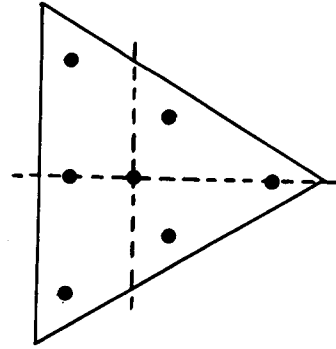

(x_i, y_i)	w_i	$R=O(h^6)$
$(0, 0)$	270/1200	
$(\frac{(\sqrt{15}+1)}{7}h, 0)$	$\frac{155-\sqrt{15}}{1200}$	
$(\frac{(-\sqrt{15}+1)}{14}h, \pm\frac{(\sqrt{15}+1)}{14}\sqrt{3}h)$		
$(\frac{(-\sqrt{15}-1)}{7}h, 0)$	$\frac{155+\sqrt{15}}{1200}$	
$(\frac{(\sqrt{15}-1)}{14}h, \pm\frac{(\sqrt{15}-1)}{14}\sqrt{3}h)$		

Regular Hexagon H

Radius of Circumscribed Circle= h

25.4.64

$$\frac{1}{\frac{3}{2}\sqrt{3}h^2} \iint_H f(x,y) dx dy = \sum_{i=1}^n w_i f(x_i, y_i) + R$$

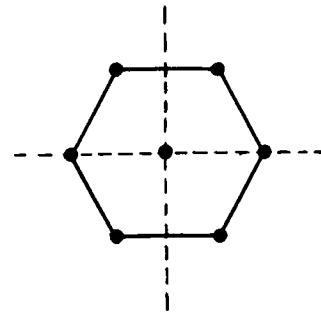

(x_i, y_i)	w_i	$R=O(h^4)$
$(0, 0)$	21/36	
$(\pm\frac{h}{2}, \pm\frac{h}{2}\sqrt{3})$	5/72	
$(\pm h, 0)$	5/72	

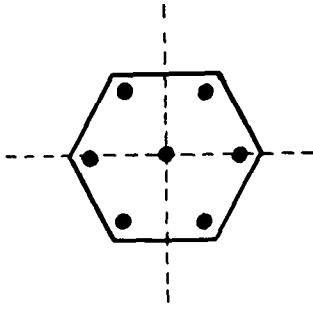

(x_i, y_i)	w_i	
$(0, 0)$	258/1008	
$(\pm \frac{h}{10} \sqrt{14}, \pm \frac{h}{10} \sqrt{42})$	125/1008	$R = O(h^6)$
$(\pm h \frac{\sqrt{14}}{5}, 0)$	125/1008	

Surface of Sphere $\Sigma: x^2 + y^2 + z^2 = h^2$

25.4.65

$$\frac{1}{4\pi h^2} \int_{\Sigma} f(x, y, z) d\sigma = \sum_{i=1}^n w_i f(x_i, y_i, z_i) + R$$

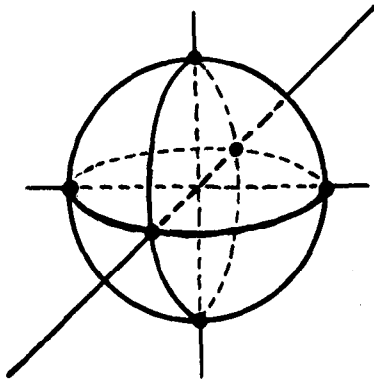

(x_i, y_i, z_i)	w_i	
$(\pm h, 0, 0)$	1/6	$R = O(h^4)$
$(0, \pm h, 0)$	1/6	
$(0, 0, \pm h)$	1/6	

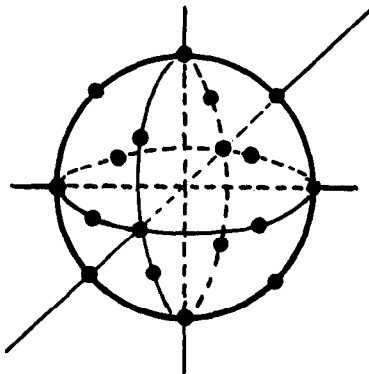

(x_i, y_i, z_i)	w_i
$(\pm \sqrt{\frac{1}{2}} h, \pm \sqrt{\frac{1}{2}} h, 0)$	
$(\pm \sqrt{\frac{1}{2}} h, 0, \pm \sqrt{\frac{1}{2}} h)$	1/15
$(0, \pm \sqrt{\frac{1}{2}} h, \pm \sqrt{\frac{1}{2}} h)$	
$(\pm h, 0, 0)$	$R = O(h^6)$

$(0, \pm h, 0)$	1/30
$(0, 0, \pm h)$	

(x_i, y_i, z_i)	w_i
$(\pm \sqrt{\frac{1}{3}} h, \pm \sqrt{\frac{1}{3}} h, \pm \sqrt{\frac{1}{3}} h)$	27/840

$(\pm \sqrt{\frac{1}{2}} h, \pm \sqrt{\frac{1}{2}} h, 0)$	
$(\pm \sqrt{\frac{1}{2}} h, 0, \pm \sqrt{\frac{1}{2}} h)$	32/840
$(0, \pm \sqrt{\frac{1}{2}} h, \pm \sqrt{\frac{1}{2}} h)$	$R = O(h^8)$

$(\pm h, 0, 0)$	
$(0, \pm h, 0)$	40/840
$(0, 0, \pm h)$	

Sphere $S: x^2 + y^2 + z^2 \leq h^2$

25.4.66

$$\frac{1}{\frac{4}{3} \pi h^3} \iiint_S f(x, y, z) dx dy dz = \sum_{i=1}^n w_i f(x_i, y_i, z_i) + R$$

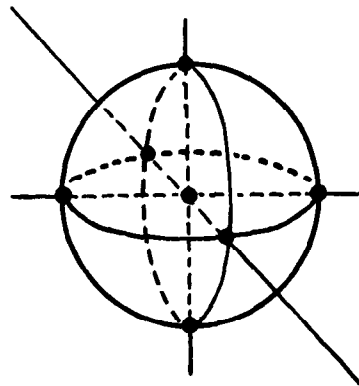

(x_i, y_i, z_i)	w_i	
$(0, 0, 0)$	$2/5$	
$(\pm h, 0, 0)$	$1/10$	$R = O(h^4)$
$(0, \pm h, 0)$	$1/10$	
$(0, 0, \pm h)$	$1/10$	

Cube⁵ C : $|x| \leq h$
 $|y| \leq h$
 $|z| \leq h$

25.4.67

$$\frac{1}{8h^3} \iiint_C f(x, y, z) dx dy dz = \sum_{i=1}^n w_i f(x_i, y_i, z_i) + R$$

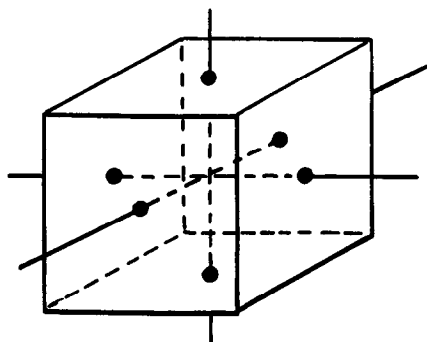

(x_i, y_i, z_i)	w_i	
$(\pm h, 0, 0)$	$1/6$	$R = O(h^4)$
$(0, \pm h, 0)$	$1/6$	
$(0, 0, \pm h)$	$1/6$	

25.4.68

$$\frac{1}{8h^3} \iiint_C f(x, y, z) dx dy dz = \frac{1}{360} [-496f_m + 128 \sum f_r + 8 \sum f_f + 5 \sum f_e] + O(h^6)$$

25.4.69

$$= \frac{1}{450} [91 \sum f_r - 40 \sum f_e + 16 \sum f_d] + O(h^6)$$

where $f_m = f(0, 0, 0)$.

⁵ See footnote to 25.4.62.

- $\sum f_r$ = sum of values of f at the 6 points midway from the center of C to the 6 faces.
- $\sum f_f$ = sum of values of f at the 6 centers of the faces of C .
- $\sum f_e$ = sum of values of f at the 8 vertices of C .
- $\sum f_d$ = sum of values of f at the 12 midpoints of edges of C .
- $\sum f_a$ = sum of values of f at the 4 points on the diagonals of each face at a distance of $\frac{1}{2}\sqrt{5}h$ from the center of the face.

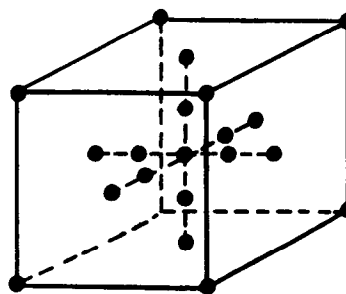

Tetrahedron: \mathcal{T}

25.4.70

$$\begin{aligned} \frac{1}{V} \iiint_{\mathcal{T}} f(x, y, z) dx dy dz &= \frac{1}{40} \sum f_e + \frac{9}{40} \sum f_r \\ &\quad + \text{terms of 4}^{\text{th}} \text{ order} \\ &= \frac{32}{60} f_m + \frac{1}{60} \sum f_e + \frac{4}{60} \sum f_r \\ &\quad + \text{terms of 4}^{\text{th}} \text{ order} \end{aligned}$$

where

V : Volume of \mathcal{T}

$\sum f_e$: Sum of values of the function at the vertices of \mathcal{T} .

$\sum f_r$: Sum of values of the function at midpoints of the edges of \mathcal{T} .

$\sum f_f$: Sum of values of the function at the center of gravity of the faces of \mathcal{T} .

f_m : Value of function at center of gravity of \mathcal{T} .

25.5. Ordinary Differential Equations⁶

First Order: $y' = f(x, y)$

Point Slope Formula

$$25.5.1 \quad y_{n+1} = y_n + hy'_n + O(h^2)$$

$$25.5.2 \quad y_{n+1} = y_{n-1} + 2hy'_n + O(h^3)$$

Trapezoidal Formula

$$25.5.3 \quad y_{n+1} = y_n + \frac{h}{2} (y'_{n+1} + y'_n) + O(h^3)$$

Adams' Extrapolation Formula

$$25.5.4 \quad y_{n+1} = y_n + \frac{h}{24} (55y'_n - 59y'_{n-1} + 37y'_{n-2} - 9y'_{n-3}) + O(h^5)$$

Adams' Interpolation Formula

$$25.5.5 \quad y_{n+1} = y_n + \frac{h}{24} (9y'_{n+1} + 19y'_n - 5y'_{n-1} + y'_{n-2}) + O(h^5)$$

Runge-Kutta Methods

Second Order

$$25.5.6 \quad y_{n+1} = y_n + \frac{1}{2} (k_1 + k_2) + O(h^3)$$

$$k_1 = hf(x_n, y_n), k_2 = hf(x_n + h, y_n + k_1)$$

25.5.7

$$y_{n+1} = y_n + k_2 + O(h^3)$$

$$k_1 = hf(x_n, y_n), k_2 = hf\left(x_n + \frac{1}{2}h, y_n + \frac{1}{2}k_1\right)$$

Third Order

25.5.8

$$y_{n+1} = y_n + \frac{1}{6}k_1 + \frac{2}{3}k_2 + \frac{1}{6}k_3 + O(h^4)$$

$$k_1 = hf(x_n, y_n), k_2 = hf\left(x_n + \frac{1}{2}h, y_n + \frac{1}{2}k_1\right)$$

$$k_3 = hf(x_n + h, y_n - k_1 + 2k_2)$$

⁶The reader is cautioned against possible instabilities especially in formulas 25.5.2 and 25.5.13. See, e.g. [25.11], [25.12].

25.5.9

$$y_{n+1} = y_n + \frac{1}{4}k_1 + \frac{3}{4}k_3 + O(h^4)$$

$$k_1 = hf(x_n, y_n), k_2 = hf\left(x_n + \frac{1}{3}h, y_n + \frac{1}{3}k_1\right)$$

$$k_3 = hf\left(x_n + \frac{2}{3}h, y_n + \frac{2}{3}k_2\right)$$

Fourth Order

25.5.10

$$y_{n+1} = y_n + \frac{1}{6}k_1 + \frac{1}{3}k_2 + \frac{1}{3}k_3 + \frac{1}{6}k_4 + O(h^5)$$

$$k_1 = hf(x_n, y_n), k_2 = hf\left(x_n + \frac{1}{2}h, y_n + \frac{1}{2}k_1\right)$$

$$k_3 = hf\left(x_n + \frac{1}{2}h, y_n + \frac{1}{2}k_2\right), k_4 = hf(x_n + h, y_n + k_3)$$

25.5.11

$$y_{n+1} = y_n + \frac{1}{8}k_1 + \frac{3}{8}k_2 + \frac{3}{8}k_3 + \frac{1}{8}k_4 + O(h^5)$$

$$k_1 = hf(x_n, y_n), k_2 = hf\left(x_n + \frac{1}{3}h, y_n + \frac{1}{3}k_1\right)$$

$$k_3 = hf\left(x_n + \frac{2}{3}h, y_n - \frac{1}{3}k_1 + k_2\right),$$

$$k_4 = hf(x_n + h, y_n + k_1 - k_2 + k_3)$$

Gill's Method

25.5.12

$$y_{n+1} = y_n + \frac{1}{6}\left(k_1 + 2\left(1 - \sqrt{\frac{1}{2}}\right)k_2 + 2\left(1 + \sqrt{\frac{1}{2}}\right)k_3 + k_4\right) + O(h^5)$$

$$k_1 = hf(x_n, y_n)$$

$$k_2 = hf\left(x_n + \frac{1}{2}h, y_n + \frac{1}{2}k_1\right)$$

$$k_3 = hf\left(x_n + \frac{1}{2}h, y_n + \left(-\frac{1}{2} + \sqrt{\frac{1}{2}}\right)k_1\right)$$

$$+ \left(1 - \sqrt{\frac{1}{2}}\right)k_2$$

$$k_4 = hf\left(x_n + h, y_n - \sqrt{\frac{1}{2}}k_2 + \left(1 + \sqrt{\frac{1}{2}}\right)k_3\right)$$

Predictor-Corrector Methods

Milne's Methods

25.5.13

$$P: y_{n+1} = y_{n-3} + \frac{4h}{3}(2y'_n - y'_{n-1} + 2y'_{n-2}) + O(h^5)$$

$$C: y_{n+1} = y_{n-1} + \frac{h}{3}(y'_{n-1} + 4y'_n + y'_{n+1}) + O(h^5)$$

25.5.14

P: $y_{n+1} = y_{n-5} + \frac{3h}{10} (11y'_n - 14y'_{n-1} + 26y'_{n-2} - 14y'_{n-3} + 11y'_{n-4}) + O(h^7)$

C: $y_{n+1} = y_{n-3} + \frac{2h}{45} (7y'_{n+1} + 32y'_n + 12y'_{n-1} + 32y'_{n-2} + 7y'_{n-3}) + O(h^7)$

Formulas Using Higher Derivatives

25.5.15

P: $y_{n+1} = y_{n-2} + 3(y_n - y_{n-1}) + h^2(y''_n - y''_{n-1}) + O(h^5)$

C: $y_{n+1} = y_n + \frac{h}{2}(y'_{n+1} + y'_n) - \frac{h^2}{12}(y''_{n+1} - y''_n) + O(h^5)$

25.5.16

P: $y_{n+1} = y_{n-2} + 3(y_n - y_{n-1}) + \frac{h^3}{2}(y'''_n + y'''_{n-1}) + O(h^7)$

C: $y_{n+1} = y_n + \frac{h}{2}(y'_{n+1} + y'_n) - \frac{h^2}{10}(y''_{n+1} - y''_n) + \frac{h^3}{120}(y'''_{n+1} + y'''_n) + O(h^7)$

Systems of Differential Equations

First Order: $y' = f(x, y, z), z' = g(x, y, z).$

Second Order Runge-Kutta

25.5.17

$y_{n+1} = y_n + \frac{1}{2}(k_1 + k_2) + O(h^3),$
 $z_{n+1} = z_n + \frac{1}{2}(l_1 + l_2) + O(h^3)$

$k_1 = hf(x_n, y_n, z_n), \quad l_1 = hg(x_n, y_n, z_n)$

$k_2 = hf(x_n + h, y_n + k_1, z_n + l_1),$

$l_2 = hg(x_n + h, y_n + k_1, z_n + l_1)$

Fourth Order Runge-Kutta

25.5.18

$y_{n+1} = y_n + \frac{1}{6}(k_1 + 2k_2 + 2k_3 + k_4) + O(h^5),$
 $z_{n+1} = z_n + \frac{1}{6}(l_1 + 2l_2 + 2l_3 + l_4) + O(h^5)$

$k_1 = hf(x_n, y_n, z_n) \quad l_1 = hg(x_n, y_n, z_n)$

$k_2 = hf\left(x_n + \frac{1}{2}h, y_n + \frac{1}{2}k_1, z_n + \frac{1}{2}l_1\right)$

$l_2 = hg\left(x_n + \frac{1}{2}h, y_n + \frac{1}{2}k_1, z_n + \frac{1}{2}l_1\right)$

$k_3 = hf\left(x_n + \frac{1}{2}h, y_n + \frac{1}{2}k_2, z_n + \frac{1}{2}l_2\right)$
 $l_3 = hg\left(x_n + \frac{1}{2}h, y_n + \frac{1}{2}k_2, z_n + \frac{1}{2}l_2\right)$
 $k_4 = hf(x_n + h, y_n + k_3, z_n + l_3)$
 $l_4 = hg(x_n + h, y_n + k_3, z_n + l_3)$

Second Order: $y'' = f(x, y, y')$

Milne's Method

25.5.19

P: $y'_{n+1} = y'_{n-3} + \frac{4h}{3}(2y''_{n-2} - y''_{n-1} + 2y''_n) + O(h^5)$

C: $y'_{n+1} = y'_{n-1} + \frac{h}{3}(y''_{n-1} + 4y''_n + y''_{n+1}) + O(h^5)$

Runge-Kutta Method

25.5.20

$y_{n+1} = y_n + h\left[y'_n + \frac{1}{6}(k_1 + k_2 + k_3)\right] + O(h^5)$

$y'_{n+1} = y'_n + \frac{1}{6}(k_1 + 2k_2 + 2k_3 + k_4)$

$k_1 = hf(x_n, y_n, y'_n)$

$k_2 = hf\left(x_n + \frac{1}{2}h, y_n + \frac{h}{2}y'_n + \frac{h}{8}k_1, y'_n + \frac{k_1}{2}\right)$

$k_3 = hf\left(x_n + \frac{1}{2}h, y_n + \frac{h}{2}y'_n + \frac{h}{8}k_1, y'_n + \frac{k_2}{2}\right)$ *

$k_4 = hf\left(x_n + h, y_n + hy'_n + \frac{h}{2}k_3, y'_n + k_3\right)$

Second Order: $y'' = f(x, y)$

Milne's Method

25.5.21

P: $y_{n+1} = y_n + y_{n-2} - y_{n-3} + \frac{h^2}{4}(5y''_n + 2y''_{n-1} + 5y''_{n-2}) + O(h^6)$

C: $y_n = 2y_{n-1} - y_{n-2} + \frac{h^2}{12}(y''_n + 10y''_{n-1} + y''_{n-2}) + O(h^6)$

Runge-Kutta Method

25.5.22 $y_{n+1} = y_n + h\left(y'_n + \frac{1}{6}(k_1 + 2k_2)\right) + O(h^4)$

$y'_{n+1} = y'_n + \frac{1}{6}k_1 + \frac{2}{3}k_2 + \frac{1}{6}k_3$

$k_1 = hf(x_n, y_n)$

$k_2 = hf\left(x_n + \frac{h}{2}, y_n + \frac{h}{2}y'_n + \frac{h}{8}k_1\right)$

$k_3 = hf\left(x_n + h, y_n + hy'_n + \frac{h}{2}k_2\right).$

*See page 11.

References

Texts

(For textbooks on numerical analysis, see texts in chapter 3)

- [25.1] J. Balbrecht and L. Collatz, Zur numerischen Auswertung mehrdimensionaler Integrale, *Z. Angew. Math. Mech.* **38**, 1-15 (1958).
- [25.2] Berthod-Zaborowski, Le calcul des intégrales de la forme: $\int_0^1 f(x) \log x \, dx$.
H. Mineur, *Techniques de calcul numérique*, pp. 555-556 (Librairie Polytechnique Ch. Béranger, Paris, France, 1952).
- [25.3] W. G. Bickley, Formulae for numerical integration, *Math. Gaz.* **23**, 352 (1939).
- [25.4] W. G. Bickley, Formulae for numerical differentiation, *Math. Gaz.* **25**, 19-27 (1941).
- [25.5] W. G. Bickley, Finite difference formulae for the square lattice, *Quart. J. Mech. Appl. Math.*, **1**, 35-42 (1948).
- [25.6] G. Birkhoff and D. Young, Numerical quadrature of analytic and harmonic functions, *J. Math. Phys.* **29**, 217-221 (1950).
- [25.7] L. Fox, The use and construction of mathematical tables, *Mathematical Tables vol. I*, National Physical Laboratory (Her Majesty's Stationery Office, London, England, 1956).
- [25.8] S. Gill, Process for the step-by-step integration of differential equations in an automatic digital computing machine, *Proc. Cambridge Philos. Soc.* **47**, 96-108 (1951).
- [25.9] P. C. Hammer and A. H. Stroud, Numerical evaluation of multiple integrals II, *Math. Tables Aids Comp.* **12**, 272-280 (1958).
- [25.10] P. C. Hammer and A. W. Wymore, Numerical evaluation of multiple integrals I, *Math. Tables Aids Comp.* **11**, 59-67 (1957).
- [25.11] P. Henrici, Discrete variable methods in ordinary differential equations (John Wiley & Sons, Inc., New York, N. Y., 1961).
- [25.12] F. B. Hildebrand, Introduction to numerical analysis (McGraw-Hill Book Co., Inc., New York, N.Y., 1956).
- [25.13] Z. Kopal, Numerical analysis (John Wiley & Sons, Inc., New York, N.Y., 1955).
- [25.14] A. A. Markoff, *Differenzenrechnung* (B. G. Teubner, Leipzig, Germany, 1896).
- [25.15] S. E. Mikeladze, Quadrature formulas for a regular function, *Soobšč. Akad. Nauk Gruzin. SSR.* **17**, 289-296 (1956).
- [25.16] W. E. Milne, A note on the numerical integration of differential equations, *J. Research NBS* **43**, 537-542 (1949) RP2046.
- [25.17] D. J. Panov, Formelsammlung zur numerischen Behandlung partieller Differentialgleichungen nach dem Differenzenverfahren (Akad. Verlag, Berlin, Germany, 1955).
- [25.18] R. Radau, Études sur les formules d'approximation qui servent à calculer la valeur d'une intégrale définie, *J. Math. Pures Appl.* (3) **6**, 283-336 (1880).
- [25.19] R. D. Richtmeyer, Difference methods for initial-value problems (Interscience Publishers, New York, N.Y., 1957).
- [25.20] M. Sadowsky, A formula for approximate computation of a triple integral, *Amer. Math. Monthly* **47**, 539-543 (1940).
- [25.21] H. E. Salzer, A new formula for inverse interpolation, *Bull. Amer. Math. Soc.* **50**, 513-516 (1944).
- [25.22] H. E. Salzer, Formulas for complex Cartesian interpolation of higher degree, *J. Math. Phys.* **28**, 200-203 (1949).
- [25.23] H. E. Salzer, Formulas for numerical integration of first and second order differential equations in the complex plane, *J. Math. Phys.* **29**, 207-216 (1950).
- [25.24] H. E. Salzer, Formulas for numerical differentiation in the complex plane, *J. Math. Phys.* **31**, 155-169 (1952).
- [25.25] A. Sard, Integral representations of remainders, *Duke Math. J.* **15**, 333-345 (1948).
- [25.26] A. Sard, Remainders: functions of several variables, *Acta Math.* **84**, 319-346 (1951).
- [25.27] G. Schulz, Formelsammlung zur praktischen Mathematik (DeGruyter and Co., Berlin, Germany, 1945).
- [25.28] A. H. Stroud, A bibliography on approximate integration, *Math. Comp.* **15**, 52-80 (1961).
- [25.29] G. J. Tranter, Integral transforms in mathematical physics (John Wiley & Sons, Inc., New York, N.Y., 1951).
- [25.30] G. W. Tyler, Numerical integration with several variables, *Canad. J. Math.* **5**, 393-412 (1953).

Tables

- [25.31] L. J. Comrie, Chambers' six-figure mathematical tables, vol. 2 (W. R. Chambers, Ltd., London, England, 1949).
- [25.32] P. Davis and P. Rabinowitz, Abscissas and weights for Gaussian quadratures of high order, *J. Research NBS* **56**, 35-37 (1956) RP2645.
- [25.33] P. Davis and P. Rabinowitz, Additional abscissas and weights for Gaussian quadratures of high order: Values for $n=64, 80$, and 96 , *J. Research NBS* **60**, 613-614 (1958) RP2875.
- [25.34] E. W. Dijkstra and A. van Wijngaarden, Table of Everett's interpolation coefficients (Elcelsior's Photo-offset, The Hague, Holland, 1955).
- [25.35] H. Fishman, Numerical integration constants, *Math. Tables Aids Comp.* **11**, 1-9 (1957).
- [25.36] H. J. Gawlik, Zeros of Legendre polynomials of orders 2-64 and weight coefficients of Gauss quadrature formulae, A.R.D.E. Memo (B) 77/58, Fort Halstead, Kent, England (1958).
- [25.37] Gt. Britain H.M. Nautical Almanac Office, Interpolation and allied tables (Her Majesty's Stationery Office, London, England, 1956).

- [25.38] I. M. Longman, Tables for the rapid and accurate numerical evaluation of certain infinite integrals involving Bessel functions, *Math. Tables Aids Comp.* **11**, 166-180 (1957).
- [25.39] A. N. Lowan, N. Davids, and A. Levenson, Table of the zeros of the Legendre polynomials of order 1-16 and the weight coefficients for Gauss' mechanical quadrature formula, *Bull. Amer. Math. Soc.* **48**, 739-743 (1942).
- [25.40] National Bureau of Standards, Tables of Lagrangian interpolation coefficients (Columbia Univ. Press, New York, N.Y., 1944).
- [25.41] National Bureau of Standards, Collected Short Tables of the Computation Laboratory, Tables of functions and of zeros of functions, *Applied Math. Series 37* (U.S. Government Printing Office, Washington, D.C., 1954).
- [25.42] P. Rabinowitz, Abscissas and weights for Lobatto quadrature of high order, *Math. Tables Aids Comp.* **69**, 47-52 (1960).
- [25.43] P. Rabinowitz and G. Weiss, Tables of abscissas and weights for numerical evaluation of integrals of the form
- $$\int_0^{\infty} e^{-x} x^n f(x) dx,$$
- Math. Tables Aids Comp.* **68**, 285-294 (1959).
- [25.44] H. E. Salzer, Tables for facilitating the use of Chebyshev's quadrature formula, *J. Math. Phys.* **26**, 191-194 (1947).
- [25.45] H. E. Salzer and R. Zucker, Table of the zeros and weight factors of the first fifteen Laguerre polynomials, *Bull. Amer. Math. Soc.* **55**, 1004-1012 (1949).
- [25.46] H. E. Salzer, R. Zucker, and R. Capuano, Table of the zeros and weight factors of the first twenty Hermite polynomials, *J. Research NBS* **48**, 111-116 (1952) RP2294.
- [25.47] H. E. Salzer, Table of coefficients for obtaining the first derivative without differences, *NBS Applied Math. Series 2* (U.S. Government Printing Office, Washington, D.C., 1948).
- [25.48] H. E. Salzer, Coefficients for facilitating trigonometric interpolation, *J. Math. Phys.* **27**, 274-278 (1949).
- [25.49] H. E. Salzer and P. T. Roberson, Table of coefficients for obtaining the second derivative without differences, *Convair-Astronautics*, San Diego, Calif. (1957).
- [25.50] H. E. Salzer, Tables of osculatory interpolation coefficients, *NBS Applied Math. Series 56* (U.S. Government Printing Office, Washington, D.C., 1958).

Table 25.1 THREE-POINT LAGRANGIAN INTERPOLATION COEFFICIENTS

$$A_k^3(p) = (-1)^{k+1} \frac{p(p^2-1)}{(1+k)!(1-k)!(p-k)}$$

p	A_{-1}	A_0	A_1	p	A_{-1}	A_0	A_1
0.00	-0.00000	1.00000	0.00000	0.50	-0.12500	0.75000	0.37500
0.01	-0.00495	0.99990	0.00505	0.51	-0.12495	0.73990	0.38505
0.02	-0.00980	0.99960	0.01020	0.52	-0.12480	0.72960	0.39520
0.03	-0.01455	0.99910	0.01545	0.53	-0.12455	0.71910	0.40545
0.04	-0.01920	0.99840	0.02080	0.54	-0.12420	0.70840	0.41580
0.05	-0.02375	0.99750	0.02625	0.55	-0.12375	0.69750	0.42625
0.06	-0.02820	0.99640	0.03180	0.56	-0.12320	0.68640	0.43680
0.07	-0.03255	0.99510	0.03745	0.57	-0.12255	0.67510	0.44745
0.08	-0.03680	0.99360	0.04320	0.58	-0.12180	0.66360	0.45820
0.09	-0.04095	0.99190	0.04905	0.59	-0.12095	0.65190	0.46905
0.10	-0.04500	0.99000	0.05500	0.60	-0.12000	0.64000	0.48000
0.11	-0.04895	0.98790	0.06105	0.61	-0.11895	0.62790	0.49105
0.12	-0.05280	0.98560	0.06720	0.62	-0.11780	0.61560	0.50220
0.13	-0.05655	0.98310	0.07345	0.63	-0.11655	0.60310	0.51345
0.14	-0.06020	0.98040	0.07980	0.64	-0.11520	0.59040	0.52480
0.15	-0.06375	0.97750	0.08625	0.65	-0.11375	0.57750	0.53625
0.16	-0.06720	0.97440	0.09280	0.66	-0.11220	0.56440	0.54780
0.17	-0.07055	0.97110	0.09945	0.67	-0.11055	0.55110	0.55945
0.18	-0.07380	0.96760	0.10620	0.68	-0.10880	0.53760	0.57120
0.19	-0.07695	0.96390	0.11305	0.69	-0.10695	0.52390	0.58305
0.20	-0.08000	0.96000	0.12000	0.70	-0.10500	0.51000	0.59500
0.21	-0.08295	0.95590	0.12705	0.71	-0.10295	0.49590	0.60705
0.22	-0.08580	0.95160	0.13420	0.72	-0.10080	0.48160	0.61920
0.23	-0.08855	0.94710	0.14145	0.73	-0.09855	0.46710	0.63145
0.24	-0.09120	0.94240	0.14880	0.74	-0.09620	0.45240	0.64380
0.25	-0.09375	0.93750	0.15625	0.75	-0.09375	0.43750	0.65625
0.26	-0.09620	0.93240	0.16380	0.76	-0.09120	0.42240	0.66880
0.27	-0.09855	0.92710	0.17145	0.77	-0.08855	0.40710	0.68145
0.28	-0.10080	0.92160	0.17920	0.78	-0.08580	0.39160	0.69420
0.29	-0.10295	0.91590	0.18705	0.79	-0.08295	0.37590	0.70705
0.30	-0.10500	0.91000	0.19500	0.80	-0.08000	0.36000	0.72000
0.31	-0.10695	0.90390	0.20305	0.81	-0.07695	0.34390	0.73305
0.32	-0.10880	0.89760	0.21120	0.82	-0.07380	0.32760	0.74620
0.33	-0.11055	0.89110	0.21945	0.83	-0.07055	0.31110	0.75945
0.34	-0.11220	0.88440	0.22780	0.84	-0.06720	0.29440	0.77280
0.35	-0.11375	0.87750	0.23625	0.85	-0.06375	0.27750	0.78625
0.36	-0.11520	0.87040	0.24480	0.86	-0.06020	0.26040	0.79980
0.37	-0.11655	0.86310	0.25345	0.87	-0.05655	0.24310	0.81345
0.38	-0.11780	0.85560	0.26220	0.88	-0.05280	0.22560	0.82720
0.39	-0.11895	0.84790	0.27105	0.89	-0.04895	0.20790	0.84105
0.40	-0.12000	0.84000	0.28000	0.90	-0.04500	0.19000	0.85500
0.41	-0.12095	0.83190	0.28905	0.91	-0.04095	0.17190	0.86905
0.42	-0.12180	0.82360	0.29820	0.92	-0.03680	0.15360	0.88320
0.43	-0.12255	0.81510	0.30745	0.93	-0.03255	0.13510	0.89745
0.44	-0.12320	0.80640	0.31680	0.94	-0.02820	0.11640	0.91180
0.45	-0.12375	0.79750	0.32625	0.95	-0.02375	0.09750	0.92625
0.46	-0.12420	0.78840	0.33580	0.96	-0.01920	0.07840	0.94080
0.47	-0.12455	0.77910	0.34545	0.97	-0.01455	0.05910	0.95545
0.48	-0.12480	0.76960	0.35520	0.98	-0.00980	0.03960	0.97020
0.49	-0.12495	0.75990	0.36505	0.99	-0.00495	0.01990	0.98505
0.50	-0.12500	0.75000	0.37500	1.00	-0.00000	0.00000	1.00000
$-p$	A_1	A_0	A_{-1}	$-p$	A_1	A_0	A_{-1}

See 25.2.6.

Compiled from National Bureau of Standards, Tables of Lagrangian interpolation coefficients. Columbia Univ. Press, New York, N.Y., 1944 (with permission).

FOUR-POINT LAGRANGIAN INTERPOLATION COEFFICIENTS Table 25.1

$$A_k^4(p) = (-1)^{k+2} \frac{p(p^2-1)(p-2)}{(1+k)!(2-k)!(p-k)}$$

p	A_{-1}	A_0	A_1	A_2	
0.00	0.00000 00	1.00000 00	0.00000 00	0.00000 00	1.00
0.01	-0.00328 35	0.99490 05	0.01004 95	-0.00166 65	0.99
0.02	-0.00646 80	0.98960 40	0.02019 60	-0.00333 20	0.98
0.03	-0.00955 45	0.98411 35	0.03043 65	-0.00499 55	0.97
0.04	-0.01254 40	0.97843 20	0.04076 80	-0.00665 60	0.96
0.05	-0.01543 75	0.97256 25	0.05118 75	-0.00831 25	0.95
0.06	-0.01823 60	0.96650 80	0.06169 20	-0.00996 40	0.94
0.07	-0.02094 05	0.96027 15	0.07227 85	-0.01160 95	0.93
0.08	-0.02355 20	0.95385 60	0.08294 40	-0.01324 80	0.92
0.09	-0.02607 15	0.94726 45	0.09368 55	-0.01487 85	0.91
0.10	-0.02850 00	0.94050 00	0.10450 00	-0.01650 00	0.90
0.11	-0.03083 85	0.93356 55	0.11538 45	-0.01811 15	0.89
0.12	-0.03308 80	0.92646 40	0.12633 60	-0.01971 20	0.88
0.13	-0.03524 95	0.91919 85	0.13735 15	-0.02130 05	0.87
0.14	-0.03732 40	0.91177 20	0.14842 80	-0.02287 60	0.86
0.15	-0.03931 25	0.90418 75	0.15956 25	-0.02443 75	0.85
0.16	-0.04121 60	0.89644 80	0.17075 20	-0.02598 40	0.84
0.17	-0.04303 55	0.88855 65	0.18199 35	-0.02751 45	0.83
0.18	-0.04477 20	0.88051 60	0.19328 40	-0.02902 80	0.82
0.19	-0.04642 65	0.87232 95	0.20462 05	-0.03052 35	0.81
0.20	-0.04800 00	0.86400 00	0.21600 00	-0.03200 00	0.80
0.21	-0.04949 35	0.85553 05	0.22741 95	-0.03345 65	0.79
0.22	-0.05090 80	0.84692 40	0.23887 60	-0.03489 20	0.78
0.23	-0.05224 45	0.83818 35	0.25036 65	-0.03630 55	0.77
0.24	-0.05350 40	0.82931 20	0.26188 80	-0.03769 60	0.76
0.25	-0.05468 75	0.82031 25	0.27343 75	-0.03906 25	0.75
0.26	-0.05579 60	0.81118 80	0.28501 20	-0.04040 40	0.74
0.27	-0.05683 05	0.80194 15	0.29660 85	-0.04171 95	0.73
0.28	-0.05779 20	0.79257 60	0.30822 40	-0.04300 80	0.72
0.29	-0.05868 15	0.78309 45	0.31985 55	-0.04426 85	0.71
0.30	-0.05950 00	0.77350 00	0.33150 00	-0.04550 00	0.70
0.31	-0.06024 85	0.76379 55	0.34315 45	-0.04670 15	0.69
0.32	-0.06092 80	0.75398 40	0.35481 60	-0.04787 20	0.68
0.33	-0.06153 95	0.74406 85	0.36648 15	-0.04901 05	0.67
0.34	-0.06208 40	0.73405 20	0.37814 80	-0.05011 60	0.66
0.35	-0.06256 25	0.72393 75	0.38981 25	-0.05118 75	0.65
0.36	-0.06297 60	0.71372 80	0.40147 20	-0.05222 40	0.64
0.37	-0.06332 55	0.70342 65	0.41312 35	-0.05322 45	0.63
0.38	-0.06361 20	0.69303 60	0.42476 40	-0.05418 80	0.62
0.39	-0.06383 65	0.68255 95	0.43639 05	-0.05511 35	0.61
0.40	-0.06400 00	0.67200 00	0.44800 00	-0.05600 00	0.60
0.41	-0.06410 35	0.66136 05	0.45958 95	-0.05684 65	0.59
0.42	-0.06414 80	0.65064 40	0.47115 60	-0.05765 20	0.58
0.43	-0.06413 45	0.63985 35	0.48269 65	-0.05841 55	0.57
0.44	-0.06406 40	0.62899 20	0.49420 80	-0.05913 60	0.56
0.45	-0.06393 75	0.61806 25	0.50568 75	-0.05981 25	0.55
0.46	-0.06375 60	0.60706 80	0.51713 20	-0.06044 40	0.54
0.47	-0.06352 05	0.59601 15	0.52853 85	-0.06102 95	0.53
0.48	-0.06323 20	0.58489 60	0.53990 40	-0.06156 80	0.52
0.49	-0.06289 15	0.57372 45	0.55122 55	-0.06205 85	0.51
0.50	-0.06250 00	0.56250 00	0.56250 00	-0.06250 00	0.50
	A_2	A_1	A_0	A_{-1}	p

Table 25.1 FOUR-POINT LAGRANGIAN INTERPOLATION COEFFICIENTS

$$A_k^4(p) = (-1)^{k+2} \frac{p(p^2-1)(p-2)}{(1+k)!(2-k)!(p-k)}$$

p	A_{-1}	A_0	A_1	A_2	
1.00	0.00000 00	0.00000 00	1.00000 00	0.00000 00	0.00
1.01	0.00166 65	-0.00994 95	1.00489 95	0.00338 35	0.01
1.02	0.00333 20	-0.01979 60	1.00959 60	0.00686 80	0.02
1.03	0.00499 55	-0.02953 65	1.01408 65	0.01045 45	0.03
1.04	0.00665 60	-0.03916 80	1.01836 80	0.01414 40	0.04
1.05	0.00831 25	-0.04868 75	1.02243 75	0.01793 75	0.05
1.06	0.00996 40	-0.05809 20	1.02629 20	0.02183 60	0.06
1.07	0.01160 95	-0.06737 85	1.02992 85	0.02584 05	0.07
1.08	0.01324 80	-0.07654 40	1.03334 40	0.02995 20	0.08
1.09	0.01487 85	-0.08558 55	1.03653 55	0.03417 15	0.09
1.10	0.01650 00	-0.09450 00	1.03950 00	0.03850 00	0.10
1.11	0.01811 15	-0.10328 45	1.04223 45	0.04293 85	0.11
1.12	0.01971 20	-0.11193 60	1.04473 60	0.04748 80	0.12
1.13	0.02130 05	-0.12045 15	1.04700 15	0.05214 95	0.13
1.14	0.02287 60	-0.12882 80	1.04902 80	0.05692 40	0.14
1.15	0.02443 75	-0.13706 25	1.05081 25	0.06181 25	0.15
1.16	0.02598 40	-0.14515 20	1.05235 20	0.06681 60	0.16
1.17	0.02751 45	-0.15309 35	1.05364 35	0.07193 55	0.17
1.18	0.02902 80	-0.16088 40	1.05468 40	0.07717 20	0.18
1.19	0.03052 35	-0.16852 05	1.05547 05	0.08252 65	0.19
1.20	0.03200 00	-0.17600 00	1.05600 00	0.08800 00	0.20
1.21	0.03345 65	-0.18331 95	1.05626 95	0.09359 35	0.21
1.22	0.03489 20	-0.19047 60	1.05627 60	0.09930 80	0.22
1.23	0.03630 55	-0.19746 65	1.05601 65	0.10514 45	0.23
1.24	0.03769 60	-0.20428 80	1.05548 80	0.11110 40	0.24
1.25	0.03906 25	-0.21093 75	1.05468 75	0.11718 75	0.25
1.26	0.04040 40	-0.21741 20	1.05361 20	0.12339 60	0.26
1.27	0.04171 95	-0.22370 85	1.05225 85	0.12973 05	0.27
1.28	0.04300 80	-0.22982 40	1.05062 40	0.13619 20	0.28
1.29	0.04426 85	-0.23575 55	1.04870 55	0.14278 15	0.29
1.30	0.04550 00	-0.24150 00	1.04650 00	0.14950 00	0.30
1.31	0.04670 15	-0.24705 45	1.04400 45	0.15634 85	0.31
1.32	0.04787 20	-0.25241 60	1.04121 60	0.16332 80	0.32
1.33	0.04901 05	-0.25758 15	1.03813 15	0.17043 95	0.33
1.34	0.05011 60	-0.26254 80	1.03474 80	0.17768 40	0.34
1.35	0.05118 75	-0.26731 25	1.03106 25	0.18506 25	0.35
1.36	0.05222 40	-0.27187 20	1.02707 20	0.19257 60	0.36
1.37	0.05322 45	-0.27622 35	1.02277 35	0.20022 55	0.37
1.38	0.05418 80	-0.28036 40	1.01816 40	0.20801 20	0.38
1.39	0.05511 35	-0.28429 05	1.01324 05	0.21593 65	0.39
1.40	0.05600 00	-0.28800 00	1.00800 00	0.22400 00	0.40
1.41	0.05684 65	-0.29148 95	1.00243 95	0.23220 35	0.41
1.42	0.05765 20	-0.29475 60	0.99655 60	0.24054 80	0.42
1.43	0.05841 55	-0.29779 65	0.99034 65	0.24903 45	0.43
1.44	0.05913 60	-0.30060 80	0.98380 80	0.25766 40	0.44
1.45	0.05981 25	-0.30318 75	0.97693 75	0.26643 75	0.45
1.46	0.06044 40	-0.30553 20	0.96973 20	0.27535 60	0.46
1.47	0.06102 95	-0.30763 85	0.96218 85	0.28442 05	0.47
1.48	0.06156 80	-0.30950 40	0.95430 40	0.29363 20	0.48
1.49	0.06205 85	-0.31112 55	0.94607 55	0.30299 15	0.49
1.50	0.06250 00	-0.31250 00	0.93750 00	0.31250 00	0.50
	A_2	A_1	A_0	A_{-1}	$-p$

FOUR-POINT LAGRANGIAN INTERPOLATION COEFFICIENTS

Table 25.1

$$A_k^4(p) = (-1)^{k+2} \frac{p(p^2-1)(p-2)}{(1+k)!(2-k)!(p-k)}$$

p	A_{-1}	A_0	A_1	A_2	
1.50	0.06250 00	-0.31250 00	0.93750 00	0.31250 00	0.50
1.51	0.06289 15	-0.31362 45	0.92857 45	0.32215 85	0.51
1.52	0.06323 20	-0.31449 60	0.91929 60	0.33196 80	0.52
1.53	0.06352 05	-0.31511 15	0.90966 15	0.34192 95	0.53
1.54	0.06375 60	-0.31546 80	0.89966 80	0.35204 40	0.54
1.55	0.06393 75	-0.31556 25	0.88931 25	0.36231 25	0.55
1.56	0.06406 40	-0.31539 20	0.87859 20	0.37273 60	0.56
1.57	0.06413 45	-0.31495 35	0.86750 35	0.38331 55	0.57
1.58	0.06414 80	-0.31424 40	0.85604 40	0.39405 20	0.58
1.59	0.06410 35	-0.31326 05	0.84421 05	0.40494 65	0.59
1.60	0.06400 00	-0.31200 00	0.83200 00	0.41600 00	0.60
1.61	0.06383 65	-0.31045 95	0.81940 95	0.42721 35	0.61
1.62	0.06361 20	-0.30863 60	0.80643 60	0.43858 80	0.62
1.63	0.06332 55	-0.30652 65	0.79307 65	0.45012 45	0.63
1.64	0.06297 60	-0.30412 80	0.77932 80	0.46182 40	0.64
1.65	0.06256 25	-0.30143 75	0.76518 75	0.47368 75	0.65
1.66	0.06208 40	-0.29845 20	0.75065 20	0.48571 60	0.66
1.67	0.06153 95	-0.29516 85	0.73571 85	0.49791 05	0.67
1.68	0.06092 80	-0.29158 40	0.72038 40	0.51027 20	0.68
1.69	0.06024 85	-0.28769 55	0.70464 55	0.52280 15	0.69
1.70	0.05950 00	-0.28350 00	0.68850 00	0.53550 00	0.70
1.71	0.05868 15	-0.27899 45	0.67194 45	0.54836 85	0.71
1.72	0.05779 20	-0.27417 60	0.65497 60	0.56140 80	0.72
1.73	0.05683 05	-0.26904 15	0.63759 15	0.57461 95	0.73
1.74	0.05579 60	-0.26358 80	0.61978 80	0.58800 40	0.74
1.75	0.05468 75	-0.25781 25	0.60156 25	0.60156 25	0.75
1.76	0.05350 40	-0.25171 20	0.58291 20	0.61529 60	0.76
1.77	0.05224 45	-0.24528 35	0.56383 35	0.62920 55	0.77
1.78	0.05090 80	-0.23852 40	0.54432 40	0.64329 20	0.78
1.79	0.04949 35	-0.23143 05	0.52438 05	0.65755 65	0.79
1.80	0.04800 00	-0.22400 00	0.50400 00	0.67200 00	0.80
1.81	0.04642 65	-0.21622 95	0.48317 95	0.68662 35	0.81
1.82	0.04477 20	-0.20811 60	0.46191 60	0.70142 80	0.82
1.83	0.04303 55	-0.19965 65	0.44020 65	0.71641 45	0.83
1.84	0.04121 60	-0.19084 80	0.41804 80	0.73158 40	0.84
1.85	0.03931 25	-0.18168 75	0.39543 75	0.74693 75	0.85
1.86	0.03732 40	-0.17217 20	0.37237 20	0.76247 60	0.86
1.87	0.03524 95	-0.16229 85	0.34884 85	0.77820 05	0.87
1.88	0.03308 80	-0.15206 40	0.32486 40	0.79411 20	0.88
1.89	0.03083 85	-0.14146 55	0.30041 55	0.81021 15	0.89
1.90	0.02850 00	-0.13050 00	0.27550 00	0.82650 00	0.90
1.91	0.02607 15	-0.11916 45	0.25011 45	0.84297 85	0.91
1.92	0.02355 20	-0.10745 60	0.22425 60	0.85964 80	0.92
1.93	0.02094 05	-0.09537 15	0.19792 15	0.87650 95	0.93
1.94	0.01823 60	-0.08290 80	0.17110 80	0.89356 40	0.94
1.95	0.01543 75	-0.07006 25	0.14381 25	0.91081 25	0.95
1.96	0.01254 40	-0.05683 20	0.11603 20	0.92825 60	0.96
1.97	0.00955 45	-0.04321 35	0.08776 35	0.94589 55	0.97
1.98	0.00646 80	-0.02920 40	0.05900 40	0.96373 20	0.98
1.99	0.00328 35	-0.01480 05	0.02975 05	0.98176 65	0.99
2.00	0.00000 00	0.00000 00	0.00000 00	1.00000 00	1.00
	A_2	A_1	A_0	A_{-1}	$-p$

Table 25.1 FIVE-POINT LAGRANGIAN INTERPOLATION COEFFICIENTS

$$A_k^5(p) = (-1)^{k+2} \frac{p(p^2-1)(p^2-4)}{(2+k)!(2-k)!(p-k)}$$

p	A_{-2}	A_{-1}	A_0	A_1	A_2				
0.00	0.00000 00000	0.00000 00000	1.00000 00000	0.00000 00000	0.00000 00000				0.00
0.01	0.00082 90838	-0.00659 98350	0.99987 50025	0.00673 31650	-0.00083 74163				0.01
0.02	0.00164 93400	-0.01306 53600	0.99950 00400	0.01359 86400	-0.00168 26600				0.02
0.03	0.00246 02838	-0.01939 56350	0.99887 52025	0.02059 53650	-0.00253 52163				0.03
0.04	0.00326 14400	-0.02558 97600	0.99800 06400	0.02772 22400	-0.00339 45600				0.04
0.05	0.00405 23438	-0.03164 68750	0.99687 65625	0.03497 81250	-0.00426 01563				0.05
0.06	0.00483 25400	-0.03756 61600	0.99550 32400	0.04236 18400	-0.00513 14600				0.06
0.07	0.00560 15838	-0.04334 68350	0.99388 10025	0.04987 21650	-0.00600 79163				0.07
0.08	0.00635 90400	-0.04898 81600	0.99201 02400	0.05750 78400	-0.00688 89600				0.08
0.09	0.00710 44838	-0.05448 94350	0.98989 14025	0.06526 75650	-0.00777 40163				0.09
0.10	0.00783 75000	-0.05985 00000	0.98752 50000	0.07315 00000	-0.00866 25000				0.10
0.11	0.00855 76838	-0.06506 92350	0.98491 16025	0.08115 37650	-0.00955 38163				0.11
0.12	0.00926 46400	-0.07014 65600	0.98205 18400	0.08927 74400	-0.01044 73600				0.12
0.13	0.00995 79838	-0.07508 14350	0.97894 64025	0.09751 95650	-0.01134 25163				0.13
0.14	0.01063 73400	-0.07987 33600	0.97559 60400	0.10587 86400	-0.01223 86600				0.14
0.15	0.01130 23438	-0.08452 18750	0.97200 15625	0.11435 31250	-0.01313 51563				0.15
0.16	0.01195 26400	-0.08902 65600	0.96816 38400	0.12294 14400	-0.01403 13600				0.16
0.17	0.01258 78838	-0.09338 70350	0.96408 38025	0.13164 19650	-0.01492 66163				0.17
0.18	0.01320 77400	-0.09760 29600	0.95976 24400	0.14045 30400	-0.01582 02600				0.18
0.19	0.01381 18838	-0.10167 40350	0.95520 08025	0.14937 29650	-0.01671 16163				0.19
0.20	0.01440 00000	-0.10560 00000	0.95040 00000	0.15840 00000	-0.01760 00000				0.20
0.21	0.01497 17838	-0.10938 06350	0.94536 12025	0.16753 23650	-0.01848 47163				0.21
0.22	0.01552 69400	-0.11301 57600	0.94008 56400	0.17676 82400	-0.01936 50600				0.22
0.23	0.01606 51838	-0.11650 52350	0.93457 46025	0.18610 57650	-0.02024 03163				0.23
0.24	0.01658 62400	-0.11984 89600	0.92882 94400	0.19554 30400	-0.02110 97600				0.24
0.25	0.01708 98438	-0.12304 68750	0.92285 15625	0.20507 81250	-0.02197 26563				0.25
0.26	0.01757 57400	-0.12609 89600	0.91664 24400	0.21470 90400	-0.02282 82600				0.26
0.27	0.01804 36838	-0.12900 52350	0.91020 36025	0.22443 37650	-0.02367 58163				0.27
0.28	0.01849 34400	-0.13176 57600	0.90353 66400	0.23425 02400	-0.02451 45600				0.28
0.29	0.01892 47838	-0.13438 06350	0.89664 32025	0.24415 63650	-0.02534 37163				0.29
0.30	0.01933 75000	-0.13685 00000	0.88952 50000	0.25415 00000	-0.02616 25000				0.30
0.31	0.01973 13838	-0.13917 40350	0.88218 38025	0.26422 89650	-0.02697 01163				0.31
0.32	0.02010 62400	-0.14135 29600	0.87462 14400	0.27439 10400	-0.02776 57600				0.32
0.33	0.02046 18838	-0.14338 70350	0.86683 98025	0.28463 39650	-0.02854 86163				0.33
0.34	0.02079 81400	-0.14527 65600	0.85884 08400	0.29495 54400	-0.02931 78600				0.34
0.35	0.02111 48438	-0.14702 18750	0.85062 65625	0.30535 31250	-0.03007 26563				0.35
0.36	0.02141 18400	-0.14862 33600	0.84219 90400	0.31582 46400	-0.03081 21600				0.36
0.37	0.02168 89838	-0.15008 14350	0.83356 04025	0.32636 75650	-0.03153 55163				0.37
0.38	0.02194 61400	-0.15139 65600	0.82471 28400	0.33697 94400	-0.03224 18600				0.38
0.39	0.02218 31838	-0.15256 92350	0.81565 86025	0.34765 77650	-0.03293 03163				0.39
0.40	0.02240 00000	-0.15360 00000	0.80640 00000	0.35840 00000	-0.03360 00000				0.40
0.41	0.02259 64838	-0.15448 94350	0.79693 94025	0.36920 35650	-0.03425 00163				0.41
0.42	0.02277 25400	-0.15523 81600	0.78727 92400	0.38006 58400	-0.03487 94600				0.42
0.43	0.02292 80838	-0.15584 68350	0.77742 20025	0.39098 41650	-0.03548 74163				0.43
0.44	0.02306 30400	-0.15631 61600	0.76737 02400	0.40195 58400	-0.03607 29600				0.44
0.45	0.02317 73438	-0.15664 68750	0.75712 65625	0.41297 81250	-0.03663 51563				0.45
0.46	0.02327 09400	-0.15683 97600	0.74669 36400	0.42404 82400	-0.03717 30600				0.46
0.47	0.02334 37838	-0.15689 56350	0.73607 42025	0.43516 33650	-0.03768 57163				0.47
0.48	0.02339 58400	-0.15681 53600	0.72527 10400	0.44632 06400	-0.03817 21600				0.48
0.49	0.02342 70838	-0.15659 98350	0.71428 70025	0.45751 71650	-0.03863 14163				0.49
0.50	0.02343 75000	-0.15625 00000	0.70312 50000	0.46875 00000	-0.03906 25000				0.50
	A_2	A_1	A_0	A_{-1}	A_{-2}				$-p$

FIVE-POINT LAGRANGIAN INTERPOLATION COEFFICIENTS

Table 25.1

$$A_k^5(p) = (-1)^{k+2} \frac{p(p^2-1)(p^2-4)}{(2+k)!(2-k)!(p-k)}$$

p	A_{-2}	A_{-1}	A_0	A_1	A_2	
0.50	0.02343 75000	-0.15625 00000	0.70312 50000	0.46875 00000	-0.03906 25000	0.50
0.51	0.02342 70838	-0.15576 68350	0.69178 80025	0.48001 61650	-0.03946 44163	0.51
0.52	0.02339 58400	-0.15515 13600	0.68027 90400	0.49131 26400	-0.03983 61600	0.52
0.53	0.02334 37838	-0.15440 46350	0.66860 12025	0.50263 63650	-0.04017 67163	0.53
0.54	0.02327 09400	-0.15352 77600	0.65675 76400	0.51398 42400	-0.04048 50600	0.54
0.55	0.02317 73438	-0.15252 18750	0.64475 15625	0.52535 31250	-0.04076 01563	0.55
0.56	0.02306 30400	-0.15138 81600	0.63258 62400	0.53673 98400	-0.04100 09600	0.56
0.57	0.02292 80838	-0.15012 78350	0.62026 50025	0.54814 11650	-0.04120 64163	0.57
0.58	0.02277 25400	-0.14874 21600	0.60779 12400	0.55955 38400	-0.04137 54600	0.58
0.59	0.02259 64838	-0.14723 24350	0.59516 84025	0.57097 45650	-0.04150 70163	0.59
0.60	0.02240 00000	-0.14560 00000	0.58240 00000	0.58240 00000	-0.04160 00000	0.60
0.61	0.02218 31838	-0.14384 62350	0.56948 96025	0.59382 67650	-0.04165 33163	0.61
0.62	0.02194 61400	-0.14197 25600	0.55644 08400	0.60525 14400	-0.04166 58600	0.62
0.63	0.02168 89838	-0.13998 04350	0.54325 74025	0.61667 05650	-0.04163 65163	0.63
0.64	0.02141 18400	-0.13787 13600	0.52994 30400	0.62808 06400	-0.04156 41600	0.64
0.65	0.02111 48438	-0.13564 68750	0.51650 15625	0.63947 81250	-0.04144 76563	0.65
0.66	0.02079 81400	-0.13330 85600	0.50293 68400	0.65085 94400	-0.04128 58600	0.66
0.67	0.02046 18838	-0.13085 80350	0.48925 28025	0.66222 09650	-0.04107 76163	0.67
0.68	0.02010 62400	-0.12829 69600	0.47545 34400	0.67355 90400	-0.04082 17600	0.68
0.69	0.01973 13838	-0.12562 70350	0.46154 28025	0.68486 99650	-0.04051 71163	0.69
0.70	0.01933 75000	-0.12285 00000	0.44752 50000	0.69615 00000	-0.04016 25000	0.70
0.71	0.01892 47838	-0.11996 76350	0.43340 42025	0.70739 53650	-0.03975 67163	0.71
0.72	0.01849 34400	-0.11698 17600	0.41918 46400	0.71860 22400	-0.03929 85600	0.72
0.73	0.01804 36838	-0.11389 42350	0.40487 06025	0.72976 67650	-0.03878 68163	0.73
0.74	0.01757 57400	-0.11070 69600	0.39046 64400	0.74088 50400	-0.03822 02600	0.74
0.75	0.01708 98438	-0.10742 18750	0.37597 65625	0.75195 31250	-0.03759 76563	0.75
0.76	0.01658 62400	-0.10404 09600	0.36140 54400	0.76296 70400	-0.03691 77600	0.76
0.77	0.01606 51838	-0.10056 62350	0.34675 76025	0.77392 27650	-0.03617 93163	0.77
0.78	0.01552 69400	-0.09699 97600	0.33203 76400	0.78481 62400	-0.03538 10600	0.78
0.79	0.01497 17838	-0.09334 36350	0.31725 02025	0.79564 33650	-0.03452 17163	0.79
0.80	0.01440 00000	-0.08960 00000	0.30240 00000	0.80640 00000	-0.03360 00000	0.80
0.81	0.01381 18838	-0.08577 10350	0.28749 18025	0.81708 19650	-0.03261 46163	0.81
0.82	0.01320 77400	-0.08185 89600	0.27253 04400	0.82768 50400	-0.03156 42600	0.82
0.83	0.01258 78838	-0.07786 60350	0.25752 08025	0.83820 49650	-0.03044 76163	0.83
0.84	0.01195 26400	-0.07379 45600	0.24246 78400	0.84863 74400	-0.02926 33600	0.84
0.85	0.01130 23438	-0.06964 68750	0.22737 65625	0.85897 81250	-0.02801 01563	0.85
0.86	0.01063 73400	-0.06542 53600	0.21225 20400	0.86922 26400	-0.02668 66600	0.86
0.87	0.00995 79838	-0.06113 24350	0.19709 94025	0.87936 65650	-0.02529 15163	0.87
0.88	0.00926 46400	-0.05677 05600	0.18192 38400	0.88940 54400	-0.02382 33600	0.88
0.89	0.00855 76838	-0.05234 22350	0.16673 06025	0.89933 47650	-0.02228 08163	0.89
0.90	0.00783 75000	-0.04785 00000	0.15152 50000	0.90915 00000	-0.02066 25000	0.90
0.91	0.00710 44838	-0.04329 64350	0.13631 24025	0.91884 65650	-0.01896 70163	0.91
0.92	0.00635 90400	-0.03868 41600	0.12109 82400	0.92841 98400	-0.01719 29600	0.92
0.93	0.00560 15838	-0.03401 58350	0.10588 80025	0.93786 51650	-0.01533 89163	0.93
0.94	0.00483 25400	-0.02929 41600	0.09068 72400	0.94717 78400	-0.01340 34600	0.94
0.95	0.00405 23438	-0.02452 18750	0.07550 15625	0.95635 31250	-0.01138 51563	0.95
0.96	0.00326 14400	-0.01970 17600	0.06033 66400	0.96538 62400	-0.00928 25600	0.96
0.97	0.00246 02838	-0.01483 66350	0.04519 82025	0.97427 23650	-0.00709 42163	0.97
0.98	0.00164 93400	-0.00992 93600	0.03009 20400	0.98300 66400	-0.00481 86600	0.98
0.99	0.00082 90838	-0.00498 28350	0.01502 40025	0.99158 41650	-0.00245 44163	0.99
1.00	0.00000 00000	0.00000 00000	0.00000 00000	1.00000 00000	0.00000 00000	1.00
	A_2	A_1	A_0	A_{-1}	A_{-2}	$-p$

Table 25.1

FIVE-POINT LAGRANGIAN INTERPOLATION COEFFICIENTS

$$A_k^5(p) = (-1)^{k+2} \frac{p(p^2-1)(p^2-4)}{(2+k)!(2-k)!(p-k)}$$

p	A_{-2}	A_{-1}	A_0	A_1	A_2						
1.00	0.00000	00000	0.00000	00000	0.00000	00000	1.00000	00000	0.00000	00000	1.00
1.01	-0.00083	74163	0.00501	61650	-0.01497	39975	1.00824	91650	0.00254	60838	1.01
1.02	-0.00168	26600	0.01006	26400	-0.02989	19600	1.01632	66400	0.00518	53400	1.02
1.03	-0.00253	52163	0.01513	63650	-0.04474	77975	1.02422	73650	0.00791	92838	1.03
1.04	-0.00339	45600	0.02023	42400	-0.05953	53600	1.03194	62400	0.01074	94400	1.04
1.05	-0.00426	01563	0.02535	31250	-0.07424	84375	1.03947	81250	0.01367	73438	1.05
1.06	-0.00513	14600	0.03048	98400	-0.08888	07600	1.04681	78400	0.01670	45400	1.06
1.07	-0.00600	79163	0.03564	11650	-0.10342	59975	1.05396	01650	0.01983	25838	1.07
1.08	-0.00688	89600	0.04080	38400	-0.11787	77600	1.06089	98400	0.02306	30400	1.08
1.09	-0.00777	40163	0.04597	45650	-0.13222	95975	1.06763	15650	0.02639	74838	1.09
1.10	-0.00866	25000	0.05115	00000	-0.14647	50000	1.07415	00000	0.02983	75000	1.10
1.11	-0.00955	38163	0.05632	67650	-0.16060	73975	1.08044	97650	0.03338	46838	1.11
1.12	-0.01044	73600	0.06150	14400	-0.17462	01600	1.08652	54400	0.03704	06400	1.12
1.13	-0.01134	25163	0.06667	05650	-0.18850	65975	1.09237	15650	0.04080	69838	1.13
1.14	-0.01223	86600	0.07183	06400	-0.20225	99600	1.09798	26400	0.04468	53400	1.14
1.15	-0.01313	51563	0.07697	81250	-0.21587	34375	1.10335	31250	0.04867	73438	1.15
1.16	-0.01403	13600	0.08210	94400	-0.22934	01600	1.10847	74400	0.05278	46400	1.16
1.17	-0.01492	66163	0.08722	09650	-0.24265	31975	1.11334	99650	0.05700	88838	1.17
1.18	-0.01582	02600	0.09230	90400	-0.25580	55600	1.11796	50400	0.06135	17400	1.18
1.19	-0.01671	16163	0.09736	99650	-0.26879	01975	1.12231	69650	0.06581	48838	1.19
1.20	-0.01760	00000	0.10240	00000	-0.28160	00000	1.12640	00000	0.07040	00000	1.20
1.21	-0.01848	47163	0.10739	53650	-0.29422	77975	1.13020	83650	0.07510	87838	1.21
1.22	-0.01936	50600	0.11235	22400	-0.30666	63600	1.13373	62400	0.07994	29400	1.22
1.23	-0.02024	03163	0.11726	67650	-0.31890	83975	1.13697	77650	0.08490	41838	1.23
1.24	-0.02110	97600	0.12213	50400	-0.33094	65600	1.13992	70400	0.08999	42400	1.24
1.25	-0.02197	26563	0.12695	31250	-0.34277	34375	1.14257	81250	0.09521	48438	1.25
1.26	-0.02282	82600	0.13171	70400	-0.35438	15600	1.14492	50400	0.10056	77400	1.26
1.27	-0.02367	58163	0.13642	27650	-0.36576	33975	1.14696	17650	0.10605	46838	1.27
1.28	-0.02451	45600	0.14106	62400	-0.37691	13600	1.14868	22400	0.11167	74400	1.28
1.29	-0.02534	37163	0.14564	33650	-0.38781	77975	1.15008	03650	0.11743	77838	1.29
1.30	-0.02616	25000	0.15015	00000	-0.39847	50000	1.15115	00000	0.12333	75000	1.30
1.31	-0.02697	01163	0.15458	19650	-0.40887	51975	1.15188	49650	0.12937	83838	1.31
1.32	-0.02776	57600	0.15893	50400	-0.41901	05600	1.15227	90400	0.13556	22400	1.32
1.33	-0.02854	86163	0.16320	49650	-0.42887	31975	1.15232	59650	0.14189	08838	1.33
1.34	-0.02931	78600	0.16738	74400	-0.43845	51600	1.15201	94400	0.14836	61400	1.34
1.35	-0.03007	26563	0.17147	81250	-0.44774	84375	1.15135	31250	0.15498	98438	1.35
1.36	-0.03081	21600	0.17547	26400	-0.45674	49600	1.15032	06400	0.16176	38400	1.36
1.37	-0.03153	55163	0.17936	65650	-0.46543	65975	1.14891	55650	0.16868	99838	1.37
1.38	-0.03224	18600	0.18315	54400	-0.47381	51600	1.14713	14400	0.17577	01400	1.38
1.39	-0.03293	03163	0.18683	47650	-0.48187	23975	1.14496	17650	0.18300	61838	1.39
1.40	-0.03360	00000	0.19040	00000	-0.48960	00000	1.14240	00000	0.19040	00000	1.40
1.41	-0.03425	00163	0.19384	65650	-0.49698	95975	1.13943	95650	0.19795	34838	1.41
1.42	-0.03487	94600	0.19716	98400	-0.50403	27600	1.13607	38400	0.20566	85400	1.42
1.43	-0.03548	74163	0.20036	51650	-0.51072	09975	1.13229	61650	0.21354	70838	1.43
1.44	-0.03607	29600	0.20342	78400	-0.51704	57600	1.12809	98400	0.22159	10400	1.44
1.45	-0.03663	51563	0.20635	31250	-0.52299	84375	1.12347	81250	0.22980	23438	1.45
1.46	-0.03717	30600	0.20913	62400	-0.52857	03600	1.11842	42400	0.23818	29400	1.46
1.47	-0.03768	57163	0.21177	23650	-0.53375	27975	1.11293	13650	0.24673	47838	1.47
1.48	-0.03817	21600	0.21425	66400	-0.53853	69600	1.10699	26400	0.25545	98400	1.48
1.49	-0.03863	14163	0.21658	41650	-0.54291	39975	1.10060	11650	0.26436	00838	1.49
1.50	-0.03906	25000	0.21875	00000	-0.54687	50000	1.09375	00000	0.27343	75000	1.50
	A_2		A_1		A_0		A_{-1}		A_{-2}	$-p$	

FIVE-POINT LAGRANGIAN INTERPOLATION COEFFICIENTS

Table 25.1

$$A_k^5(p) = (-1)^{k+2} \frac{p(p^2-1)(p^2-4)}{(2+k)!(2-k)!(p-k)}$$

p	A_{-2}	A_{-1}	A_0	A_1	A_2	
1.50	-0.03906 25000	0.21875 00000	-0.54687 50000	1.09375 00000	0.27343 75000	1.50
1.51	-0.03946 44163	0.22074 91650	-0.55041 09975	1.08643 21650	0.28269 40838	1.51
1.52	-0.03983 61600	0.22257 66400	-0.55351 29600	1.07864 06400	0.29213 18400	1.52
1.53	-0.04017 67163	0.22422 73650	-0.55617 17975	1.07036 83650	0.30175 27838	1.53
1.54	-0.04048 50600	0.22569 62400	-0.55837 83600	1.06160 82400	0.31155 89400	1.54
1.55	-0.04076 01563	0.22697 81250	-0.56012 34375	1.05235 31250	0.32155 23438	1.55
1.56	-0.04100 09600	0.22806 78400	-0.56139 77600	1.04259 58400	0.33173 50400	1.56
1.57	-0.04120 64163	0.22896 01650	-0.56219 19975	1.03232 91650	0.34210 90838	1.57
1.58	-0.04137 54600	0.22964 98400	-0.56249 67600	1.02154 58400	0.35267 65400	1.58
1.59	-0.04150 70163	0.23013 15650	-0.56230 25975	1.01023 85650	0.36343 94838	1.59
1.60	-0.04160 00000	0.23040 00000	-0.56160 00000	0.99840 00000	0.37440 00000	1.60
1.61	-0.04165 33163	0.23044 97650	-0.56037 93975	0.98602 27650	0.38556 01838	1.61
1.62	-0.04166 58600	0.23027 54400	-0.55863 11600	0.97309 94400	0.39692 21400	1.62
1.63	-0.04163 65163	0.22987 15650	-0.55634 55975	0.95962 25650	0.40848 79838	1.63
1.64	-0.04156 41600	0.22923 26400	-0.55351 29600	0.94558 46400	0.42025 98400	1.64
1.65	-0.04144 76563	0.22835 31250	-0.55012 34375	0.93097 81250	0.43223 98438	1.65
1.66	-0.04128 58600	0.22722 74400	-0.54616 71600	0.91579 54400	0.44443 01400	1.66
1.67	-0.04107 76163	0.22584 99650	-0.54163 41975	0.90002 89650	0.45683 28838	1.67
1.68	-0.04082 17600	0.22421 50400	-0.53651 45600	0.88367 10400	0.46945 02400	1.68
1.69	-0.04051 71163	0.22231 69650	-0.53079 81975	0.86671 39650	0.48228 43838	1.69
1.70	-0.04016 25000	0.22015 00000	-0.52447 50000	0.84915 00000	0.49533 75000	1.70
1.71	-0.03975 67163	0.21770 83650	-0.51753 47975	0.83097 13650	0.50861 17838	1.71
1.72	-0.03929 85600	0.21498 62400	-0.50996 73600	0.81217 02400	0.52210 94400	1.72
1.73	-0.03878 68163	0.21197 77650	-0.50176 23975	0.79273 87650	0.53583 26838	1.73
1.74	-0.03822 02600	0.20867 70400	-0.49290 95600	0.77266 90400	0.54978 37400	1.74
1.75	-0.03759 76563	0.20507 81250	-0.48339 84375	0.75195 31250	0.56396 48438	1.75
1.76	-0.03691 77600	0.20117 50400	-0.47321 85600	0.73058 30400	0.57837 82400	1.76
1.77	-0.03617 93163	0.19696 17650	-0.46235 93975	0.70855 07650	0.59302 61838	1.77
1.78	-0.03538 10600	0.19243 22400	-0.45081 03600	0.68584 82400	0.60791 09400	1.78
1.79	-0.03452 17163	0.18758 03650	-0.43856 07975	0.66246 73650	0.62303 47838	1.79
1.80	-0.03360 00000	0.18240 00000	-0.42560 00000	0.63840 00000	0.63840 00000	1.80
1.81	-0.03261 46163	0.17688 49650	-0.41191 71975	0.61363 79650	0.65400 88838	1.81
1.82	-0.03156 42600	0.17102 90400	-0.39750 15600	0.58817 30400	0.66986 37400	1.82
1.83	-0.03044 76163	0.16482 59650	-0.38234 21975	0.56199 69650	0.68596 68838	1.83
1.84	-0.02926 33600	0.15826 94400	-0.36642 81600	0.53510 14400	0.70232 06400	1.84
1.85	-0.02801 01563	0.15135 31250	-0.34974 84375	0.50747 81250	0.71892 73438	1.85
1.86	-0.02668 66600	0.14407 06400	-0.33229 19600	0.47911 86400	0.73578 93400	1.86
1.87	-0.02529 15163	0.13641 55650	-0.31404 75975	0.45001 45650	0.75290 89838	1.87
1.88	-0.02382 33600	0.12838 14400	-0.29500 41600	0.42015 74400	0.77028 86400	1.88
1.89	-0.02228 08163	0.11996 17650	-0.27515 03975	0.38953 87650	0.78793 06838	1.89
1.90	-0.02066 25000	0.11115 00000	-0.25447 50000	0.35815 00000	0.80583 75000	1.90
1.91	-0.01896 70163	0.10193 95650	-0.23296 65975	0.32598 25650	0.82401 14838	1.91
1.92	-0.01719 29600	0.09232 38400	-0.21061 37600	0.29302 78400	0.84245 50400	1.92
1.93	-0.01533 89163	0.08229 61650	-0.18740 49975	0.25927 71650	0.86117 05838	1.93
1.94	-0.01340 34600	0.07184 98400	-0.16332 87600	0.22472 18400	0.88016 05400	1.94
1.95	-0.01138 51563	0.06097 81250	-0.13837 34375	0.18935 31250	0.89942 73438	1.95
1.96	-0.00928 25600	0.04967 42400	-0.11252 73600	0.15316 22400	0.91897 34400	1.96
1.97	-0.00709 42163	0.03793 13650	-0.08577 87975	0.11614 03650	0.93880 12838	1.97
1.98	-0.00481 86600	0.02574 26400	-0.05811 59600	0.07827 86400	0.95891 33400	1.98
1.99	-0.00245 44163	0.01310 11650	-0.02952 69975	0.03956 81650	0.97931 20838	1.99
2.00	0.00000 00000	0.00000 00000	0.00000 00000	0.00000 00000	1.00000 00000	2.00
	A_2	A_1	A_0	A_{-1}	A_{-2}	$-p$

Table 25.1

SIX-POINT LAGRANGIAN INTERPOLATION COEFFICIENTS

$$A_k^6(p) = (-1)^{k+3} \frac{p(p^2-1)(p^2-4)(p-3)}{(2+k)!(3-k)!(p-k)}$$

p	A_{-2}	A_{-1}	A_0	A_1	A_2	A_3							
0.00	0.00000	00000	0.00000	00000	1.00000	00000	0.00000	00000	1.00				
0.01	0.00049	57921	-0.00493	33767	0.99654	20858	0.01006	60817	-0.00250	38746	0.00033	32917	0.99
0.02	0.00098	30066	-0.00973	36932	0.99283	67064	0.02026	19736	-0.00501	43268	0.00066	63334	0.98
0.03	0.00146	14085	-0.01440	12590	0.98888	64505	0.03058	41170	-0.00752	95922	0.00099	88752	0.97
0.04	0.00193	07725	-0.01893	64224	0.98469	39648	0.04102	89152	-0.01004	78976	0.00133	06675	0.96
0.05	0.00239	08828	-0.02333	95703	0.98026	19531	0.05159	27344	-0.01256	74609	0.00166	14609	0.95
0.06	0.00284	15335	-0.02761	11276	0.97559	31752	0.06227	19048	-0.01508	64924	0.00199	10065	0.94
0.07	0.00328	25281	-0.03175	15567	0.97069	04458	0.07306	27217	-0.01760	31946	0.00231	90557	0.93
0.08	0.00371	36794	-0.03576	13568	0.96555	66336	0.08396	14464	-0.02011	57632	0.00264	53606	0.92
0.09	0.00413	48096	-0.03964	10640	0.96019	46604	0.09496	43071	-0.02262	23873	0.00296	96742	0.91
0.10	0.00454	57500	-0.04339	12500	0.95460	75000	0.10606	75000	-0.02512	12500	0.00329	17500	0.90
0.11	0.00494	63412	-0.04701	25223	0.94879	81771	0.11726	71904	-0.02761	05290	0.00361	13426	0.89
0.12	0.00533	64326	-0.05050	55232	0.94276	97664	0.12855	95136	-0.03008	83968	0.00392	82074	0.88
0.13	0.00571	58827	-0.05387	09296	0.93652	53917	0.13994	05758	-0.03255	30217	0.00424	21011	0.87
0.14	0.00608	45585	-0.05710	94524	0.93006	82248	0.15140	64552	-0.03500	25676	0.00455	27815	0.86
0.15	0.00644	23359	-0.06022	18359	0.92340	14844	0.16295	32031	-0.03743	51953	0.00486	00078	0.85
0.16	0.00678	90995	-0.06320	88576	0.91652	84352	0.17457	68448	-0.03984	90624	0.00516	35405	0.84
0.17	0.00712	47422	-0.06607	13273	0.90945	23870	0.18627	33805	-0.04224	23240	0.00546	31416	0.83
0.18	0.00744	91654	-0.06881	00868	0.90217	66936	0.19803	87864	-0.04461	31332	0.00575	85746	0.82
0.19	0.00776	22787	-0.07142	60096	0.89470	47517	0.20986	90158	-0.04695	96417	0.00604	96051	0.81
0.20	0.00806	40000	-0.07392	00000	0.88704	00000	0.22176	00000	-0.04928	00000	0.00633	60000	0.80
0.21	0.00835	42553	-0.07629	29929	0.87918	59183	0.23370	76492	-0.05157	23583	0.00661	75284	0.79
0.22	0.00863	29786	-0.07854	59532	0.87114	60264	0.24570	78536	-0.05383	48668	0.00689	39614	0.78
0.23	0.00890	01118	-0.08067	98752	0.86292	38830	0.25775	64845	-0.05606	56760	0.00716	50719	0.77
0.24	0.00915	56045	-0.08269	57824	0.85452	30848	0.26984	93952	-0.05826	29376	0.00743	06355	0.76
0.25	0.00939	94141	-0.08459	47266	0.84594	72656	0.28198	24219	-0.06042	48047	0.00769	04297	0.75
0.26	0.00963	15055	-0.08637	77876	0.83720	00952	0.29415	13848	-0.06254	94324	0.00794	42345	0.74
0.27	0.00985	18513	-0.08804	60729	0.82828	52783	0.30635	20892	-0.06463	49783	0.00819	18324	0.73
0.28	0.01006	04314	-0.08960	07168	0.81920	65536	0.31858	03264	-0.06667	96032	0.00843	30086	0.72
0.29	0.01025	72328	-0.09104	28802	0.80996	76929	0.33083	18746	-0.06868	14711	0.00866	75510	0.71
0.30	0.01044	22500	-0.09237	37500	0.80057	25000	0.34310	25000	-0.07063	87500	0.00889	52500	0.70
0.31	0.01061	54844	-0.09359	45385	0.79102	48096	0.35538	79579	-0.07254	96127	0.00911	58993	0.69
0.32	0.01077	69446	-0.09470	64832	0.78132	84864	0.36768	39936	-0.07441	22368	0.00932	92954	0.68
0.33	0.01092	66459	-0.09571	08458	0.77148	74242	0.37998	63433	-0.07622	48054	0.00953	52378	0.67
0.34	0.01106	46105	-0.09660	89124	0.76150	55448	0.39229	07352	-0.07798	55076	0.00973	35295	0.66
0.35	0.01119	08672	-0.09740	19922	0.75138	67969	0.40459	28906	-0.07969	25391	0.00992	39766	0.65
0.36	0.01130	54515	-0.09809	14176	0.74113	51552	0.41688	85248	-0.08134	41024	0.01010	63885	0.64
0.37	0.01140	84054	-0.09867	85435	0.73075	46195	0.42917	33480	-0.08293	84077	0.01028	05783	0.63
0.38	0.01149	97774	-0.09916	47468	0.72024	92136	0.44144	30664	-0.08447	36732	0.01044	63626	0.62
0.39	0.01157	96219	-0.09955	14258	0.70962	29842	0.45369	33833	-0.08594	81254	0.01060	35618	0.61
0.40	0.01164	80000	-0.09984	00000	0.69888	00000	0.46592	00000	-0.08736	00000	0.01075	20000	0.60
0.41	0.01170	49786	-0.10003	19092	0.68802	43508	0.47811	86167	-0.08870	75421	0.01089	15052	0.59
0.42	0.01175	06306	-0.10012	86132	0.67706	01464	0.49028	49336	-0.08998	90068	0.01102	19094	0.58
0.43	0.01178	50351	-0.10013	15915	0.66599	15155	0.50241	46520	-0.09120	26598	0.01114	30487	0.57
0.44	0.01180	82765	-0.10004	23424	0.65482	26048	0.51450	34752	-0.09234	67776	0.01125	47635	0.56
0.45	0.01182	04453	-0.09986	23828	0.64355	75781	0.52654	71094	-0.09341	96484	0.01135	68984	0.55
0.46	0.01182	16375	-0.09959	32476	0.63220	06152	0.53854	12648	-0.09441	95724	0.01144	93025	0.54
0.47	0.01181	19546	-0.09923	64892	0.62075	59108	0.55048	16567	-0.09534	48621	0.01153	18292	0.53
0.48	0.01179	15034	-0.09879	36768	0.60922	76736	0.56236	40064	-0.09619	38432	0.01160	43366	0.52
0.49	0.01176	03961	-0.09826	63965	0.59762	01254	0.57418	40421	-0.09696	48548	0.01166	66877	0.51
0.50	0.01171	87500	-0.09765	62500	0.58593	75000	0.58593	75000	-0.09765	62500	0.01171	87500	0.50
	A_3		A_2		A_1		A_0		A_{-1}		A_{-2}		p

SIX-POINT LAGRANGIAN INTERPOLATION COEFFICIENTS

Table 25.1

$$A_k^6(p) = (-1)^{k+3} \frac{p(p^2-1)(p^2-4)(p-3)}{(2+k)!(3-k)!(p-k)}$$

<i>p</i>	<i>A</i> ₋₂		<i>A</i> ₋₁		<i>A</i> ₀		<i>A</i> ₁		<i>A</i> ₂		<i>A</i> ₃		
1.00	0.00000	00000	0.00000	00000	0.00000	00000	1.00000	00000	0.00000	00000	0.00000	00000	0.00
1.01	-0.00033	32917	0.00249	55421	-0.00993	27517	1.00320	79192	0.00506	67067	-0.00050	41246	0.01
1.02	-0.00066	63334	0.00498	10068	-0.01972	86936	1.00616	33736	0.01026	69732	-0.00101	63266	0.02
1.03	-0.00099	88752	0.00745	46597	-0.02938	43870	1.00886	39545	0.01560	09890	-0.00153	63410	0.03
1.04	-0.00133	06675	0.00991	47776	-0.03889	64352	1.01130	73152	0.02106	89024	-0.00206	38925	0.04
1.05	-0.00166	14609	0.01235	96484	-0.04826	14844	1.01349	11719	0.02667	08203	-0.00259	86953	0.05
1.06	-0.00199	10065	0.01478	75724	-0.05747	62248	1.01541	33048	0.03240	68076	-0.00314	04535	0.06
1.07	-0.00231	90556	0.01719	68621	-0.06653	73917	1.01707	15592	0.03827	68866	-0.00368	88606	0.07
1.08	-0.00264	53606	0.01958	58432	-0.07544	17664	1.01846	38464	0.04428	10368	-0.00424	35994	0.08
1.09	-0.00296	96742	0.02195	28547	-0.08418	61771	1.01958	81446	0.05041	91940	-0.00480	43420	0.09
1.10	-0.00329	17500	0.02429	62500	-0.09276	75000	1.02044	25000	0.05669	12500	-0.00537	07500	0.10
1.11	-0.00361	13426	0.02661	43965	-0.10118	26604	1.02102	50279	0.06309	70523	-0.00594	24737	0.11
1.12	-0.00392	82074	0.02890	56768	-0.10942	86336	1.02133	39136	0.06963	64032	-0.00651	91526	0.12
1.13	-0.00424	21011	0.03116	84892	-0.11750	24458	1.02136	74133	0.07630	90596	-0.00710	04152	0.13
1.14	-0.00455	27815	0.03340	12476	-0.12540	11752	1.02112	38552	0.08311	47324	-0.00768	58785	0.14
1.15	-0.00486	00078	0.03560	23828	-0.13312	19531	1.02060	16406	0.09005	30859	-0.00827	51484	0.15
1.16	-0.00516	35405	0.03777	03424	-0.14066	19648	1.01979	92448	0.09712	37376	-0.00886	78195	0.16
1.17	-0.00546	31415	0.03990	35915	-0.14801	84505	1.01871	52180	0.10432	62572	-0.00946	34747	0.17
1.18	-0.00575	85746	0.04200	06132	-0.15518	87064	1.01734	81864	0.11166	01668	-0.01006	16854	0.18
1.19	-0.00604	96051	0.04405	99092	-0.16217	00858	1.01569	68533	0.11912	49396	-0.01066	20112	0.19
1.20	-0.00633	60000	0.04608	00000	-0.16896	00000	1.01376	00000	0.12672	00000	-0.01126	40000	0.20
1.21	-0.00661	75284	0.04805	94258	-0.17555	59192	1.01153	64867	0.13444	47229	-0.01186	71878	0.21
1.22	-0.00689	39614	0.04999	67468	-0.18195	53736	1.00902	52536	0.14229	84332	-0.01247	10986	0.22
1.23	-0.00716	50719	0.05189	05435	-0.18815	59545	1.00622	53220	0.15028	04052	-0.01307	52443	0.23
1.24	-0.00743	06355	0.05373	94176	-0.19415	53152	1.00313	57952	0.15838	98624	-0.01367	91245	0.24
1.25	-0.00769	04297	0.05554	19922	-0.19995	11719	0.99975	58594	0.16662	59766	-0.01428	22266	0.25
1.26	-0.00794	42345	0.05729	69124	-0.20554	13048	0.99608	47848	0.17498	78676	-0.01488	40255	0.26
1.27	-0.00819	18324	0.05900	28458	-0.21092	35592	0.99212	19267	0.18347	46029	-0.01548	39838	0.27
1.28	-0.00843	30086	0.06065	84832	-0.21609	58464	0.98786	67264	0.19208	51968	-0.01608	15514	0.28
1.29	-0.00866	75509	0.06226	25385	-0.22105	61446	0.98331	87121	0.20081	86102	-0.01667	61653	0.29
1.30	-0.00889	52500	0.06381	37500	-0.22580	25000	0.97847	75000	0.20967	37500	-0.01726	72500	0.30
1.31	-0.00911	58993	0.06531	08802	-0.23033	30279	0.97334	27954	0.21864	94685	-0.01785	42169	0.31
1.32	-0.00932	92954	0.06675	27168	-0.23464	59136	0.96791	43936	0.22774	45632	-0.01843	64646	0.32
1.33	-0.00953	52378	0.06813	80729	-0.23873	94133	0.96219	21808	0.23695	77758	-0.01901	33784	0.33
1.34	-0.00973	35295	0.06946	57876	-0.24261	18552	0.95617	61352	0.24628	77924	-0.01958	43305	0.34
1.35	-0.00992	39766	0.07073	47266	-0.24626	16406	0.94986	63281	0.25573	32422	-0.02014	86797	0.35
1.36	-0.01010	63885	0.07194	37824	-0.24968	72448	0.94326	29248	0.26529	26976	-0.02070	57715	0.36
1.37	-0.01028	05783	0.07309	18752	-0.25288	72180	0.93636	61855	0.27496	46735	-0.02125	49379	0.37
1.38	-0.01044	63626	0.07417	79532	-0.25586	01864	0.92917	64664	0.28474	76268	-0.02179	54974	0.38
1.39	-0.01060	35618	0.07520	09929	-0.25860	48533	0.92169	42208	0.29463	99558	-0.02232	67544	0.39
1.40	-0.01075	20000	0.07616	00000	-0.26112	00000	0.91392	00000	0.30464	00000	-0.02284	80000	0.40
1.41	-0.01089	15052	0.07705	40096	-0.26340	44867	0.90585	44542	0.31474	60392	-0.02335	85111	0.41
1.42	-0.01102	19094	0.07788	20868	-0.26545	72536	0.89749	83336	0.32495	62932	-0.02385	75506	0.42
1.43	-0.01114	30487	0.07864	33273	-0.26727	73220	0.88885	24895	0.33526	89215	-0.02434	43676	0.43
1.44	-0.01125	47635	0.07933	68576	-0.26886	37952	0.87991	78752	0.34568	20224	-0.02481	81965	0.44
1.45	-0.01135	68984	0.07996	18359	-0.27021	58594	0.87069	55469	0.35619	36328	-0.02527	82578	0.45
1.46	-0.01144	93025	0.08051	74524	-0.27133	27848	0.86118	66648	0.36680	17276	-0.02572	37575	0.46
1.47	-0.01153	18292	0.08100	29296	-0.27221	39267	0.85139	24942	0.37750	42192	-0.02615	38871	0.47
1.48	-0.01160	43366	0.08141	75232	-0.27285	87264	0.84131	44064	0.38829	89568	-0.02656	78234	0.48
1.49	-0.01166	66877	0.08176	05223	-0.27326	67121	0.83095	38796	0.39918	37265	-0.02696	47286	0.49
1.50	-0.01171	87500	0.08203	12500	-0.27343	75000	0.82031	25000	0.41015	62500	-0.02734	37500	0.50

*A*₃ *A*₂ *A*₁ *A*₀ *A*₋₁ *A*₋₂ -*p*

Table 25.1

SIX-POINT LAGRANGIAN INTERPOLATION COEFFICIENTS

$$A_k^p = (-1)^{k+3} \frac{p(p^2-1)(p^2-4)(p-3)}{(2+k)!(3-k)!(p-k)}$$

p	A_{-2}	A_{-1}	A_0	A_1	A_2	A_3	
1.50	-0.01171 87500	0.08203 12500	-0.27343 75000	0.82031 25000	0.41015 62500	-0.02734 37500	0.50
1.51	-0.01176 03961	0.08222 90640	-0.27337 07954	0.80939 19629	0.42121 41848	-0.02770 40202	0.51
1.52	-0.01179 15034	0.08235 33568	-0.27306 63936	0.79819 40736	0.43235 51232	-0.02804 46566	0.52
1.53	-0.01181 19546	0.08240 35567	-0.27252 41808	0.78672 07483	0.44357 65921	-0.02836 47617	0.53
1.54	-0.01182 16375	0.08237 91276	-0.27174 41352	0.77497 40152	0.45487 60524	-0.02866 34225	0.54
1.55	-0.01182 04453	0.08227 95703	-0.27072 63281	0.76295 60156	0.46625 08984	-0.02893 97109	0.55
1.56	-0.01180 82765	0.08210 44224	-0.26947 09248	0.75066 90048	0.47769 84576	-0.02919 26835	0.56
1.57	-0.01178 50350	0.08185 32590	-0.26797 81855	0.73811 53530	0.48921 59897	-0.02942 13812	0.57
1.58	-0.01175 06306	0.08152 56932	-0.26624 84664	0.72529 75464	0.50080 06868	-0.02962 48294	0.58
1.59	-0.01170 49786	0.08112 13767	-0.26428 22208	0.71221 81883	0.51244 96721	-0.02980 20377	0.59
1.60	-0.01164 80000	0.08064 00000	-0.26208 00000	0.69888 00000	0.52416 00000	-0.02995 20000	0.60
1.61	-0.01157 96219	0.08008 12933	-0.25964 24542	0.68528 58217	0.53592 86554	-0.03007 36943	0.61
1.62	-0.01149 97774	0.07944 50268	-0.25697 03336	0.67143 86136	0.54775 25532	-0.03016 60826	0.62
1.63	-0.01140 84054	0.07873 10110	-0.25406 44895	0.65734 14570	0.55962 85377	-0.03022 81108	0.63
1.64	-0.01130 54515	0.07793 90976	-0.25092 58752	0.64299 75552	0.57155 33824	-0.03025 87085	0.64
1.65	-0.01119 08672	0.07706 91797	-0.24755 55469	0.62841 02344	0.58352 37891	-0.03025 67891	0.65
1.66	-0.01106 46105	0.07612 11924	-0.24395 46648	0.61358 29448	0.59553 63876	-0.03022 12495	0.66
1.67	-0.01092 66459	0.07509 51133	-0.24012 44942	0.59851 92617	0.60758 77354	-0.03015 09703	0.67
1.68	-0.01077 69446	0.07399 09632	-0.23606 64064	0.58322 28864	0.61967 43168	-0.03004 48154	0.68
1.69	-0.01061 54845	0.07280 88061	-0.23178 18796	0.56769 76471	0.63179 25427	-0.02990 16318	0.69
1.70	-0.01044 22500	0.07154 87500	-0.22727 25000	0.55194 75000	0.64393 87500	-0.02972 02500	0.70
1.71	-0.01025 72328	0.07021 09477	-0.22253 99629	0.53597 65304	0.65610 92010	-0.02949 94834	0.71
1.72	-0.01006 04314	0.06879 55968	-0.21758 60736	0.51978 89536	0.66830 00832	-0.02923 81286	0.72
1.73	-0.00985 18513	0.06730 29404	-0.21241 27483	0.50338 91158	0.68050 75083	-0.02893 49649	0.73
1.74	-0.00963 15055	0.06573 32676	-0.20702 20152	0.48678 14952	0.69272 75124	-0.02858 87545	0.74
1.75	-0.00939 94141	0.06408 69141	-0.20141 60156	0.46997 07031	0.70495 60547	-0.02819 82422	0.75
1.76	-0.00915 56045	0.06236 42624	-0.19559 70048	0.45296 14848	0.71718 90176	-0.02776 21555	0.76
1.77	-0.00890 01118	0.06056 57427	-0.18956 73530	0.43575 87205	0.72942 22061	-0.02727 92045	0.77
1.78	-0.00863 29786	0.05869 18332	-0.18332 95464	0.41836 74264	0.74165 13468	-0.02674 80814	0.78
1.79	-0.00835 42553	0.05674 30604	-0.17688 61883	0.40079 27558	0.75387 20883	-0.02616 74609	0.79
1.80	-0.00806 40000	0.05472 00000	-0.17024 00000	0.38304 00000	0.76608 00000	-0.02553 60000	0.80
1.81	-0.00776 22787	0.05262 32771	-0.16339 38217	0.36511 45892	0.77827 05717	-0.02485 23376	0.81
1.82	-0.00744 91654	0.05045 35668	-0.15635 06136	0.34702 20936	0.79043 92132	-0.02411 50946	0.82
1.83	-0.00712 47422	0.04821 15948	-0.14911 34570	0.32876 82245	0.80258 12540	-0.02332 28741	0.83
1.84	-0.00678 90995	0.04589 81376	-0.14168 55552	0.31035 88352	0.81469 19424	-0.02247 42605	0.84
1.85	-0.00644 23359	0.04351 40234	-0.13407 02344	0.29179 99219	0.82676 64453	-0.02156 78203	0.85
1.86	-0.00608 45585	0.04106 01324	-0.12627 09448	0.27309 76248	0.83879 98476	-0.02060 21015	0.86
1.87	-0.00571 58826	0.03853 73971	-0.11829 12617	0.25425 82292	0.85078 71516	-0.01957 56336	0.87
1.88	-0.00533 64326	0.03594 68032	-0.11013 48864	0.23528 81664	0.86272 32768	-0.01848 69274	0.88
1.89	-0.00494 63412	0.03328 93898	-0.10180 56471	0.21619 40145	0.87460 30590	-0.01733 44750	0.89
1.90	-0.00454 57500	0.03056 62500	-0.09330 75000	0.19698 25000	0.88642 12500	-0.01611 67500	0.90
1.91	-0.00413 48096	0.02777 85315	-0.08464 45304	0.17766 04979	0.89817 25173	-0.01483 22067	0.91
1.92	-0.00371 36794	0.02492 74368	-0.07582 09536	0.15823 50336	0.90985 14432	-0.01347 92806	0.92
1.93	-0.00328 25281	0.02201 42242	-0.06684 11158	0.13871 32833	0.92145 25246	-0.01205 63882	0.93
1.94	-0.00284 15335	0.01904 02076	-0.05770 94952	0.11910 25752	0.93297 01724	-0.01056 19265	0.94
1.95	-0.00239 08828	0.01600 67578	-0.04843 07031	0.09941 03906	0.94439 87109	-0.00899 42734	0.95
1.96	-0.00193 07725	0.01291 53024	-0.03900 94848	0.07964 43648	0.95573 23776	-0.00735 17875	0.96
1.97	-0.00146 14086	0.00976 73265	-0.02945 07205	0.05981 22880	0.96696 53223	-0.00563 28077	0.97
1.98	-0.00098 30066	0.00656 43732	-0.01975 94264	0.03992 21064	0.97809 16068	-0.00383 56534	0.98
1.99	-0.00049 57921	0.00330 80442	-0.00994 07558	0.01998 19233	0.98910 52046	-0.00195 86242	0.99
2.00	0.00000 00000	0.00000 00000	0.00000 00000	0.00000 00000	1.00000 00000	0.00000 00000	1.00
	A_3	A_2	A_1	A_0	A_{-1}	A_{-2}	$-p$

SIX-POINT LAGRANGIAN INTERPOLATION COEFFICIENTS

Table 25.1

$$A_k^{(p)} = (-1)^{k+3} \frac{p(p^2-1)(p^2-4)(p-3)}{(2+k)!(3-k)!(p-k)}$$

p	A_{-2}	A_{-1}	A_0	A_1	A_2	A_3			
2.00	0.00000	00000	0.00000	00000	0.00000	00000	0.00000	00000	1.00
2.01	0.00050	41246	-0.00335	80392	0.01005	74108	-0.02001	52433	1.01
2.02	0.00101	63266	-0.00676	42932	0.02022	59064	-0.04005	52264	1.02
2.03	0.00153	63410	-0.01021	69214	0.03049	97755	-0.06011	12080	1.03
2.04	0.00206	38925	-0.01371	40224	0.04087	31648	-0.08017	42848	1.04
2.05	0.00259	86953	-0.01725	36328	0.05134	00781	-0.10023	53906	1.05
2.06	0.00314	04535	-0.02083	37276	0.06189	43752	-0.12028	52952	1.06
2.07	0.00368	88605	-0.02445	22191	0.07252	97708	-0.14031	46033	1.07
2.08	0.00424	35994	-0.02810	69568	0.08323	98336	-0.16031	37536	1.08
2.09	0.00480	43420	-0.03179	57264	0.09401	79854	-0.18027	30179	1.09
2.10	0.00537	07500	-0.03551	62500	0.10485	75000	-0.20018	25000	1.10
2.11	0.00594	24737	-0.03926	61847	0.11575	15021	-0.22003	21346	1.11
2.12	0.00651	91526	-0.04304	31232	0.12669	29664	-0.23981	16864	1.12
2.13	0.00710	04151	-0.04684	45921	0.13767	47167	-0.25951	07492	1.13
2.14	0.00768	58785	-0.05066	80524	0.14868	94248	-0.27911	87448	1.14
2.15	0.00827	51484	-0.05451	08984	0.15972	96094	-0.29862	49219	1.15
2.16	0.00886	78195	-0.05837	04576	0.17078	76352	-0.31801	83552	1.16
2.17	0.00946	34747	-0.06224	39898	0.18185	57120	-0.33728	79445	1.17
2.18	0.01006	16854	-0.06612	86868	0.19292	58936	-0.35642	24136	1.18
2.19	0.01066	20112	-0.07002	16721	0.20399	00767	-0.37541	03092	1.19
2.20	0.01126	40000	-0.07392	00000	0.21504	00000	-0.39424	00000	1.20
2.21	0.01186	71878	-0.07782	06554	0.22606	72433	-0.41289	96758	1.21
2.22	0.01247	10986	-0.08172	05532	0.23706	32264	-0.43137	73464	1.22
2.23	0.01307	52443	-0.08561	65377	0.24801	92080	-0.44966	08405	1.23
2.24	0.01367	91245	-0.08950	53824	0.25892	62848	-0.46773	78048	1.24
2.25	0.01428	22266	-0.09338	37891	0.26977	53906	-0.48559	57031	1.25
2.26	0.01488	40255	-0.09724	83876	0.28055	72952	-0.50322	18152	1.26
2.27	0.01548	39838	-0.10109	57353	0.29126	26033	-0.52060	32358	1.27
2.28	0.01608	15514	-0.10492	23168	0.30188	17536	-0.53772	68736	1.28
2.29	0.01667	61653	-0.10872	45427	0.31240	50179	-0.55457	94504	1.29
2.30	0.01726	72500	-0.11249	87500	0.32282	25000	-0.57114	75000	1.30
2.31	0.01785	42169	-0.11624	12010	0.33312	41346	-0.58741	73671	1.31
2.32	0.01843	64646	-0.11994	80832	0.34329	96864	-0.60337	52064	1.32
2.33	0.01901	33784	-0.12361	55083	0.35333	87492	-0.61900	69817	1.33
2.34	0.01958	43305	-0.12723	95124	0.36323	07448	-0.63429	84648	1.34
2.35	0.02014	86797	-0.13081	60547	0.37296	49219	-0.64923	52344	1.35
2.36	0.02070	57715	-0.13434	10176	0.38253	03552	-0.66380	26752	1.36
2.37	0.02125	49379	-0.13781	02060	0.39191	59445	-0.67798	59770	1.37
2.38	0.02179	54974	-0.14121	93468	0.40111	04136	-0.69177	01336	1.38
2.39	0.02232	67544	-0.14456	40883	0.41010	23092	-0.70513	99417	1.39
2.40	0.02284	80000	-0.14784	00000	0.41888	00000	-0.71808	00000	1.40
2.41	0.02335	85111	-0.15104	25717	0.42743	16758	-0.73057	47083	1.41
2.42	0.02385	75506	-0.15416	72132	0.43574	53464	-0.74260	82664	1.42
2.43	0.02434	43676	-0.15720	92540	0.44380	88405	-0.75416	46730	1.43
2.44	0.02481	81965	-0.16016	39424	0.45160	98048	-0.76522	77248	1.44
2.45	0.02527	82578	-0.16302	64453	0.45913	57031	-0.77578	10156	1.45
2.46	0.02572	37575	-0.16579	18476	0.46637	38152	-0.78580	79352	1.46
2.47	0.02615	38870	-0.16845	51516	0.47331	12358	-0.79529	16683	1.47
2.48	0.02656	78234	-0.17101	12768	0.47993	48736	-0.80421	51936	1.48
2.49	0.02696	47286	-0.17345	50590	0.48623	14504	-0.81256	12829	1.49
2.50	0.02734	37500	-0.17578	12500	0.49218	75000	-0.82031	25000	1.50
	A_3	A_2	A_1	A_0	A_{-1}	A_{-2}	$-p$		

Table 25.1 SIX-POINT LAGRANGIAN INTERPOLATION COEFFICIENTS

$$A_k^6(p) = (-1)^{k+3} \frac{p(p^2-1)(p^2-4)(p-3)}{(2+k)!(3-k)!(p-k)}$$

p	A_{-2}	A_{-1}	A_0	A_1	A_2	A_3							
2.50	0.02734	37500	-0.17578	12500	0.49218	75000	-0.82031	25000	1.23046	87500	0.24609	37500	1.50
2.51	0.02770	40203	-0.17798	45173	0.49778	93671	-0.82745	11996	1.22495	22660	0.25499	00635	1.51
2.52	0.02804	46566	-0.18005	94432	0.50302	32064	-0.83395	95264	1.21886	39232	0.26408	71834	1.52
2.53	0.02836	47616	-0.18200	05246	0.50787	49817	-0.83981	94142	1.21219	21734	0.27338	80221	1.53
2.54	0.02866	34225	-0.18380	21724	0.51233	04648	-0.84501	25848	1.20492	53524	0.28289	55175	1.54
2.55	0.02893	97109	-0.18545	87109	0.51637	52344	-0.84952	05469	1.19705	16797	0.29261	26328	1.55
2.56	0.02919	26835	-0.18696	43776	0.51999	46752	-0.85332	45952	1.18855	92576	0.30254	23565	1.56
2.57	0.02942	13812	-0.18831	33223	0.52317	39770	-0.85640	58095	1.17943	60710	0.31268	77026	1.57
2.58	0.02962	48294	-0.18949	96068	0.52589	81336	-0.85874	50536	1.16966	99868	0.32305	17106	1.58
2.59	0.02980	20377	-0.19051	72046	0.52815	19417	-0.86032	29742	1.15924	87533	0.33363	74461	1.59
2.60	0.02995	20000	-0.19136	00000	0.52992	00000	-0.86112	00000	1.14816	00000	0.34444	80000	1.60
2.61	0.03007	36943	-0.19202	17879	0.53118	67083	-0.86111	63408	1.13639	12367	0.35548	64894	1.61
2.62	0.03016	60826	-0.19249	62732	0.53193	62664	-0.86029	19864	1.12392	98532	0.36675	60574	1.62
2.63	0.03022	81107	-0.19277	70702	0.53215	26730	-0.85862	67055	1.11076	31190	0.37825	98730	1.63
2.64	0.03025	87085	-0.19285	77024	0.53181	97248	-0.85610	00448	1.09687	81824	0.39000	11315	1.64
2.65	0.03025	67891	-0.19273	16016	0.53092	10156	-0.85269	13281	1.08226	20703	0.40198	30547	1.65
2.66	0.03022	12495	-0.19239	21076	0.52943	99352	-0.84837	96552	1.06690	16676	0.41420	88905	1.66
2.67	0.03015	09704	-0.19183	24679	0.52735	96683	-0.84314	39008	1.05078	38166	0.42668	19134	1.67
2.68	0.03004	48154	-0.19104	58368	0.52466	31936	-0.83696	27136	1.03389	51168	0.43940	54246	1.68
2.69	0.02990	16317	-0.19002	52752	0.52133	32829	-0.82981	45154	1.01622	21240	0.45238	27520	1.69
2.70	0.02972	02500	-0.18876	37500	0.51735	25000	-0.82167	75000	0.99775	12500	0.46561	72500	1.70
2.71	0.02949	94834	-0.18725	41335	0.51270	31996	-0.81252	96321	0.97846	87823	0.47911	23003	1.71
2.72	0.02923	81286	-0.18548	92032	0.50736	75264	-0.80234	86464	0.95836	08832	0.49287	13114	1.72
2.73	0.02893	49650	-0.18346	16409	0.50132	74142	-0.79111	20467	0.93741	35896	0.50689	77188	1.73
2.74	0.02858	87545	-0.18116	40324	0.49456	45848	-0.77879	71048	0.91561	28124	0.52119	49855	1.74
2.75	0.02819	82422	-0.17858	88672	0.48706	05469	-0.76538	08594	0.89294	43359	0.53576	66016	1.75
2.76	0.02776	21555	-0.17572	85376	0.47879	65952	-0.75084	01152	0.86939	38176	0.55061	60845	1.76
2.77	0.02727	92044	-0.17257	53385	0.46975	38095	-0.73515	14420	0.84494	67873	0.56574	69793	1.77
2.78	0.02674	80814	-0.16912	14668	0.45991	30536	-0.71829	11736	0.81958	86468	0.58116	28586	1.78
2.79	0.02616	74609	-0.16535	90208	0.44925	49742	-0.70023	54067	0.79330	46696	0.59686	73228	1.79
2.80	0.02553	60000	-0.16128	00000	0.43776	00000	-0.68096	00000	0.76608	00000	0.61286	40000	1.80
2.81	0.02485	23376	-0.15687	63042	0.42540	83408	-0.66044	05733	0.73789	96529	0.62915	65462	1.81
2.82	0.02411	50946	-0.15213	97332	0.41217	99864	-0.63865	25064	0.70874	85132	0.64574	86454	1.82
2.83	0.02332	28741	-0.14706	19865	0.39805	47055	-0.61557	09380	0.67861	13352	0.66264	40097	1.83
2.84	0.02247	42605	-0.14163	46624	0.38301	20448	-0.59117	07648	0.64747	27424	0.67984	63795	1.84
2.85	0.02156	78203	-0.13584	92578	0.36703	13281	-0.56542	66406	0.61531	72266	0.69735	95234	1.85
2.86	0.02060	21015	-0.12969	71676	0.35009	16552	-0.53831	29752	0.58212	91476	0.71518	72385	1.86
2.87	0.01957	56335	-0.12316	96841	0.33217	19008	-0.50980	39333	0.54789	27329	0.73333	33502	1.87
2.88	0.01848	69274	-0.11625	79968	0.31325	07136	-0.47987	34336	0.51259	20768	0.75180	17126	1.88
2.89	0.01733	44751	-0.10895	31915	0.29330	65154	-0.44849	51479	0.47621	11402	0.77059	62087	1.89
2.90	0.01611	67500	-0.10124	62500	0.27231	75000	-0.41564	25000	0.43873	37500	0.78972	07500	1.90
2.91	0.01483	22068	-0.09312	80498	0.25026	16321	-0.38128	86646	0.40014	35985	0.80917	92770	1.91
2.92	0.01347	92806	-0.08458	93632	0.22711	66464	-0.34540	65664	0.36042	42432	0.82897	57594	1.92
2.93	0.01205	63881	-0.07562	08571	0.20286	00467	-0.30796	88792	0.31955	91059	0.84911	41956	1.93
2.94	0.01056	19265	-0.06621	30924	0.17746	91048	-0.26894	80248	0.27753	14724	0.86959	86135	1.94
2.95	0.00899	42734	-0.05635	65234	0.15092	08594	-0.22831	61719	0.23432	44922	0.89043	30703	1.95
2.96	0.00735	17875	-0.04604	14976	0.12319	21152	-0.18604	52352	0.18992	11776	0.91162	16525	1.96
2.97	0.00563	28077	-0.03525	82547	0.09425	94420	-0.14210	68745	0.14430	44035	0.93316	84760	1.97
2.98	0.00383	56534	-0.02399	69268	0.06409	91736	-0.09647	24936	0.09745	69068	0.95507	76866	1.98
2.99	0.00195	86242	-0.01224	75371	0.03268	74067	-0.04911	32392	0.04936	12858	0.97735	34596	1.99
3.00	0.00000	00000	0.00000	00000	0.00000	00000	0.00000	00000	0.00000	00000	1.00000	00000	2.00
	A_3		A_2		A_1		A_0		A_{-1}		A_{-2}		$-p$

SEVEN-POINT LAGRANGIAN INTERPOLATION COEFFICIENTS Table 25.1

$$A_k^7(p) = (-1)^{k+3} \frac{p(p^2-1)(p^2-4)(p^2-9)}{(3+k)!(3-k)!(p-k)}$$

<i>p</i>	<i>A</i> ₋₃	<i>A</i> ₋₂	<i>A</i> ₋₁	<i>A</i> ₀	<i>A</i> ₁	<i>A</i> ₂	<i>A</i> ₃	<i>p</i>
0.0	0.00000	0.00000	0.00000	1.00000	0.00000	0.00000	0.00000	0.0
0.1	-0.00159	0.01409	-0.06725	0.98642	0.08220	-0.01557	0.00170	0.1
0.2	-0.00295	0.02580	-0.11827	0.94617	0.17740	-0.03153	0.00337	0.2
0.3	-0.00400	0.03445	-0.15241	0.88062	0.28305	-0.04662	0.00489	0.3
0.4	-0.00465	0.03960	-0.16972	0.79206	0.39603	-0.05940	0.00609	0.4
0.5	-0.00488	0.04101	-0.17089	0.68359	0.51269	-0.06835	0.00683	0.5
0.6	-0.00465	0.03870	-0.15724	0.55910	0.62899	-0.07188	0.00698	0.6
0.7	-0.00400	0.03291	-0.13068	0.42315	0.74052	-0.06835	0.00643	0.7
0.8	-0.00295	0.02407	-0.09363	0.28089	0.84268	-0.05617	0.00510	0.8
0.9	-0.00159	0.01283	-0.04898	0.13788	0.93074	-0.03384	0.00295	0.9
1.0	0.00000	0.00000	0.00000	0.00000	1.00000	0.00000	0.00000	1.0
1.1	0.00170	-0.01349	0.04980	-0.12678	1.04595	0.04648	-0.00367	1.1
1.2	0.00337	-0.02661	0.09676	-0.23654	1.06444	0.10644	-0.00788	1.2
1.3	0.00489	-0.03824	0.13719	-0.32365	1.05186	0.18031	-0.01237	1.3
1.4	0.00609	-0.04730	0.16755	-0.38297	1.00531	0.26808	-0.01675	1.4
1.5	0.00683	-0.05273	0.18457	-0.41015	0.92285	0.36914	-0.02050	1.5
1.6	0.00698	-0.05358	0.18547	-0.40185	0.80371	0.48222	-0.02296	1.6
1.7	0.00643	-0.04907	0.16813	-0.23566	0.64853	0.60530	-0.02328	1.7
1.8	0.00510	-0.03870	0.13132	-0.27238	0.45964	0.73543	-0.02042	1.8
1.9	0.00295	-0.02227	0.07488	-0.15240	0.24130	0.86869	-0.01316	1.9
2.0	0.00000	0.00000	0.00000	0.00000	0.00000	1.00000	0.00000	2.0
2.1	-0.00367	0.02739	-0.09056	0.17825	-0.25523	1.12302	0.02079	2.1
2.2	-0.00788	0.05857	-0.19219	0.37273	-0.51251	1.23002	0.05125	2.2
2.3	-0.01237	0.09151	-0.29812	0.57031	-0.75677	1.31173	0.09369	2.3
2.4	-0.01675	0.12337	-0.39916	0.75398	-0.96940	1.35717	0.15079	2.4
2.5	-0.02050	0.15039	-0.48339	0.90234	-1.12792	1.35351	0.22558	2.5
2.6	-0.02296	0.16773	-0.53580	0.98918	-1.20556	1.28593	0.32148	2.6
2.7	-0.02328	0.16940	-0.53797	0.98296	-1.17089	1.13743	0.44233	2.7
2.8	-0.02042	0.14810	-0.46771	0.84633	-0.98739	0.88865	0.59243	2.8
2.9	-0.01316	0.09508	-0.29867	0.53555	-0.61307	0.51770	0.77655	2.9
3.0	0.00000	0.00000	0.00000	0.00000	0.00000	0.00000	1.00000	3.0
	<i>A</i> ₃	<i>A</i> ₂	<i>A</i> ₁	<i>A</i> ₀	<i>A</i> ₋₁	<i>A</i> ₋₂	<i>A</i> ₋₃	<i>p</i>

EIGHT-POINT LAGRANGIAN INTERPOLATION COEFFICIENTS

$$A_k^8(p) = (-1)^{k+4} \frac{p(p^2-1)(p^2-4)(p^2-9)(p-4)}{(3+k)!(4-k)!(p-k)}$$

<i>p</i>	<i>A</i> ₋₃	<i>A</i> ₋₂	<i>A</i> ₋₁	<i>A</i> ₀	<i>A</i> ₁	<i>A</i> ₂	<i>A</i> ₃	<i>A</i> ₄	<i>p</i>
0.0	0.00000	0.00000	0.00000	1.00000	0.00000	0.00000	0.00000	0.00000	0.0
0.1	-0.00088	0.00915	-0.05246	0.96176	0.10686	-0.03037	0.00663	-0.00070	0.1
0.2	-0.00160	0.01634	-0.08988	0.89886	0.22471	-0.05992	0.01284	-0.00135	0.2
0.3	-0.00211	0.02124	-0.11278	0.81458	0.34910	-0.08624	0.01810	-0.00188	0.3
0.4	-0.00239	0.02376	-0.12220	0.71285	0.47523	-0.10692	0.02193	-0.00226	0.4
0.5	-0.00244	0.02392	-0.11962	0.59814	0.59814	-0.11962	0.02392	-0.00244	0.5
1.0	0.00000	0.00000	0.00000	0.00000	1.00000	0.00000	0.00000	0.00000	1.0
1.1	0.00070	-0.00652	0.02888	-0.09191	1.01108	0.06740	-0.01064	0.00099	1.1
1.2	0.00135	-0.01241	0.05419	-0.16558	0.99348	0.14902	-0.02207	0.00202	1.2
1.3	0.00188	-0.01721	0.23088	-0.21846	0.94667	0.24343	-0.03341	0.00300	1.3
1.4	0.00226	-0.02050	0.08712	-0.24893	0.87127	0.34850	-0.04356	0.00382	1.4
1.5	0.00244	-0.02197	0.09228	-0.25634	0.76904	0.46142	-0.05126	0.00439	1.5
1.6	0.00239	-0.02143	0.08902	-0.24111	0.64296	0.57867	-0.05511	0.00459	1.6
1.7	0.00211	-0.01881	0.07734	-0.20473	0.49721	0.69609	-0.05354	0.00432	1.7
1.8	0.00160	-0.01419	0.05778	-0.14981	0.33707	0.80898	-0.04494	0.00350	1.8
1.9	0.00088	-0.00779	0.03145	-0.08001	0.16891	0.91212	-0.02764	0.00206	1.9
2.0	0.00000	0.00000	0.00000	0.00000	0.00000	1.00000	0.00000	0.00000	2.0
2.1	-0.00099	0.00867	-0.03441	0.08467	-0.16164	1.06687	0.03951	-0.00267	2.1
2.2	-0.00202	0.01757	-0.06918	0.16773	-0.30750	1.10702	0.09225	-0.00585	2.2
2.3	-0.00300	0.02592	-0.10136	0.24238	-0.42883	1.11497	0.15928	-0.00936	2.3
2.4	-0.00382	0.03290	-0.12773	0.30159	-0.51701	1.08573	0.24127	-0.01292	2.4
2.5	-0.00439	0.03759	-0.14501	0.33837	-0.56396	1.01513	0.33837	-0.01611	2.5
2.6	-0.00459	0.03913	-0.15002	0.34621	-0.56259	0.90015	0.45007	-0.01837	2.6
2.7	-0.00432	0.03670	-0.13987	0.31946	-0.50738	0.73933	0.57503	-0.01895	2.7
2.8	-0.00350	0.02962	-0.11225	0.25390	-0.39495	0.53319	0.71092	-0.01692	2.8
2.9	-0.00206	0.01743	-0.06570	0.14727	-0.22479	0.28473	0.85421	-0.01109	2.9
3.0	0.00000	0.00000	0.00000	0.00000	0.00000	0.00000	1.00000	0.00000	3.0
3.1	0.00267	-0.02238	0.08354	-0.18415	0.27184	-0.31138	1.14174	0.01812	3.1
3.2	0.00585	-0.04888	0.18157	-0.39719	0.57774	-0.63551	1.27102	0.04539	3.2
3.3	0.00936	-0.07796	0.28827	-0.62605	0.89825	-0.95353	1.37732	0.08432	3.3
3.4	0.01292	-0.10723	0.39481	-0.85155	1.20637	-1.24084	1.44764	0.13787	3.4
3.5	0.01611	-0.13330	0.48876	-1.04736	1.46630	-1.46630	1.46630	0.20947	3.5
3.6	0.01837	-0.15155	0.55351	-1.17877	1.63215	-1.59134	1.41453	0.30311	3.6
3.7	0.01895	-0.15598	0.56750	-1.20148	1.64647	-1.56899	1.27013	0.42337	3.7
3.8	0.01692	-0.13891	0.50356	-1.06014	1.43877	-1.34285	1.00713	0.57550	3.8
3.9	0.01109	-0.09081	0.32805	-0.68695	0.92383	-0.84604	0.59536	0.76546	3.9
4.0	0.00000	0.00000	0.00000	0.00000	0.00000	0.00000	0.00000	1.00000	4.0
	<i>A</i> ₄	<i>A</i> ₃	<i>A</i> ₂	<i>A</i> ₁	<i>A</i> ₀	<i>A</i> ₋₁	<i>A</i> ₋₂	<i>A</i> ₋₃	<i>p</i>

Table 25.2

COEFFICIENTS FOR DIFFERENTIATION

$$\text{Differentiation Formula: } \frac{dkf(y)}{dx^k} \Big|_{x=x_j} \approx \frac{k!}{m!h^k} \sum_{i=0}^m A_i f(x_i)$$

FIRST DERIVATIVE (k=1)							THIRD DERIVATIVE (k=3)									
* j	A ₀	A ₁	A ₂	A ₃	A ₄	A ₅	$\frac{h^k}{k!}$ Error	j	A ₀	A ₁	A ₂	A ₃	A ₄	A ₅	$\frac{h^k}{k!}$ Error	*
Three Point (m=2)								Four Point (m=3)								
0	-3	4	-1				1/3	0	-1	3	-3	1			-1/4	
1	-1	0	1				-1/6 h ³ f ⁽³⁾	1	-1	3	-3	1			-1/12 h ⁴ f ⁽⁴⁾	
2	1	-4	3				1/3	2	-1	3	-3	1			1/12 h ⁴ f ⁽⁴⁾	
								3	-1	3	-3	1			1/4	
Four Point (m=3)								Five Point (m=4)								
0	-11	18	-9	2			-1/4	0	-10	36	-48	28	-6		7/24	
1	-2	-3	6	-1			1/12 h ⁴ f ⁽⁴⁾	1	-6	20	-24	12	-2		1/24	
2	1	-6	3	2			-1/12 h ⁴ f ⁽⁴⁾	2	-2	4	0	-4	2		-1/24 h ⁵ f ⁽⁵⁾	
3	-2	9	-18	11			1/4	3	2	-12	24	-20	6		1/24	
								4	6	-28	48	-36	10		7/24	
Five Point (m=4)								Six Point (m=5)								
0	-50	96	-72	32	-6		1/5	0	-85	355	-590	490	-205	35	-5/16	
1	-6	-20	36	-12	2		-1/20	1	-35	125	-170	110	-35	5	-1/48	
2	2	-16	0	16	-2		1/30 h ⁵ f ⁽⁵⁾	2	-5	-5	50	-70	35	-5	1/48 h ⁶ f ⁽⁶⁾	
3	-2	12	-36	20	6		-1/20	3	5	-35	70	-50	5	5	-1/48 h ⁶ f ⁽⁶⁾	
4	6	-32	72	-96	50		1/5	4	-5	35	-110	170	-125	35	1/48	
								5	-35	205	-490	590	-355	85	5/16	
Six Point (m=5)								FOURTH DERIVATIVE (k=4)								
0	-274	600	-600	400	-150	24	-1/6	j	A ₀	A ₁	A ₂	A ₃	A ₄	A ₅	$\frac{h^k}{k!}$ Error	*
1	-24	-130	240	-120	40	-6	1/30	Five Point (m=4)								
2	6	-60	-40	120	-30	4	-1/60 h ⁶ f ⁽⁶⁾	0	1	-4	6	-4	1		-1/12 h ⁵ f ⁽⁵⁾	
3	-4	30	-120	40	60	-6	1/60 h ⁶ f ⁽⁶⁾	1	1	-4	6	-4	1		-1/24 h ⁶ f ⁽⁶⁾	
4	6	-40	120	-240	130	24	-1/30	2	1	-4	6	-4	1		-1/24 h ⁶ f ⁽⁶⁾	
5	-24	150	-400	600	-600	274	1/6	3	1	-4	6	-4	1		1/24 h ⁵ f ⁽⁵⁾	
								4	1	-4	6	-4	1		1/12 h ⁵ f ⁽⁵⁾	
SECOND DERIVATIVE (k=2)								Six Point (m=5)								
* j	A ₀	A ₁	A ₂	A ₃	A ₄	A ₅	$\frac{h^k}{k!}$ Error	0	15	-70	130	-120	55	-10	17/144	
Three Point (m=2)								Five Point (m=4)								
0	1	-2	1				-1/2 h ³ f ⁽³⁾	1	10	-45	80	-70	30	-5	5/144	
1	1	-2	1				-1/24 h ⁴ f ⁽⁴⁾	2	5	-20	30	-20	5	0	-1/144 h ⁶ f ⁽⁶⁾	
2	1	-2	1				1/2 h ³ f ⁽³⁾	3	0	5	-20	30	-20	5	-1/144 h ⁶ f ⁽⁶⁾	
								4	-5	30	-70	80	-45	10	5/144	
Four Point (m=3)								Six Point (m=5)								
0	6	-15	12	-3			11/24	5	-10	55	-120	130	-70	15	17/144	
1	3	-6	3	0			-1/24 h ⁴ f ⁽⁴⁾									
2	0	3	-6	3			-1/24 h ⁴ f ⁽⁴⁾									
3	-3	12	-15	6			11/24									
Five Point (m=4)								FIFTH DERIVATIVE (k=5)								
0	35	-104	114	-56	11		-5/12 h ⁵ f ⁽⁵⁾	j	A ₀	A ₁	A ₂	A ₃	A ₄	A ₅	$\frac{h^k}{k!}$ Error	*
1	11	-20	6	4	-1		1/24 h ⁶ f ⁽⁶⁾	Six Point (m=5)								
2	-1	16	-30	16	-1		1/180 h ⁶ f ⁽⁶⁾	0	-1	5	-10	10	-5	1	-1/48	
3	-1	4	6	-20	11		-1/24 h ⁵ f ⁽⁵⁾	1	-1	5	-10	10	-5	1	-1/80	
4	11	-56	114	-104	35		5/12	2	-1	5	-10	10	-5	1	-1/240 h ⁶ f ⁽⁶⁾	
								3	-1	5	-10	10	-5	1	1/240 h ⁶ f ⁽⁶⁾	
Six Point (m=5)								Six Point (m=5)								
0	225	-770	1070	-780	305	-50	137/360	0	-1	5	-10	10	-5	1	-1/48	
1	50	-75	-20	70	-30	5	-13/360	1	-1	5	-10	10	-5	1	-1/80	
2	-5	80	-150	80	-5	0	1/180 h ⁶ f ⁽⁶⁾	2	-1	5	-10	10	-5	1	-1/240 h ⁶ f ⁽⁶⁾	
3	0	-5	80	-150	80	-5	1/180 h ⁶ f ⁽⁶⁾	3	-1	5	-10	10	-5	1	1/240 h ⁶ f ⁽⁶⁾	
4	5	-30	70	-20	-75	50	-13/360	4	-1	5	-10	10	-5	1	1/80	
5	-50	305	-780	1070	-770	225	137/360	5	-1	5	-10	10	-5	1	1/48	

Compiled from W. G. Bickley, Formulae for numerical differentiation, Math. Gaz. 25, 19-27, 1941 (with permission).

*See page II.

LAGRANGIAN INTEGRATION COEFFICIENTS

Table 25.3

$$\int_{x_m}^{x_{m+1}} f(x) dx \approx h \sum_k A_k(m) f(x_k) \quad *$$

$$DA_k^n(m)$$

$n = \text{odd}$

n	$m \setminus k$	-4	-3	-2	-1	0	1	2	3	4	D	
3	-1				5	8	-1				0	12
5	-2			251	646	-264	106	-19			1	720
	-1			-19	346	456	-74	11			0	
7	-3	19087	65112	-46461	37504	-20211	6312	-863			2	60480
	-2	-863	25128	46989	-16256	7299	-2088	271			1	
	-1	271	-2760	30819	37504	-6771	1608	-191			0	
9	-4	1070017	4467094	-4604594	5595358	-5033120	3146338	-1291214	312874	-33953	3	3628800
	-3	-33953	1375594	3244786	-1752542	1317280	-755042	294286	-68906	7297	2	
	-2	7297	-99626	1638286	2631838	-833120	397858	-142094	31594	-3233	1	
	-1	-3233	36394	-216014	1909858	2224480	-425762	126286	-25706	2497	0	
		4	3	2	1	0	-1	-2	-3	-4	$k \setminus m$	

$n = \text{even}$

n	$m \setminus k$	-4	-3	-2	-1	0	1	2	3	4	5	D	
4	-1				9	19	-5	1				24	
	0				-1	13	13	-1			1		
6	-2			475	1427	-798	482	-173	27			2	1440
	-1			-27	637	1022	-258	77	-11			1	
	0			11	-93	802	802	-93	11			0	
8	-3	36799	139849	-121797	123133	-88547	41499	-11351	1375			3	120960
	-2	-1375	47799	101349	-44797	26883	-11547	2999	-351			2	
	-1	351	-4183	57627	81693	-20227	7227	-1719	191			1	
	0	-191	1879	-9531	68323	68323	-9531	1879	-191			0	
10	-4	2082753	9449717	-11271304	16002320	-17283646	13510082	-7394032	2687864	-583435	57281	4	7257600
	-3	-57281	2655563	6872072	-4397584	3973310	-2848834	1481072	-520312	110219	-10625	3	
	-2	10625	-163531	3133688	5597072	-2166334	1295810	-617584	206072	-42187	3969	2	
	-1	-3969	50315	-342136	3609968	4763582	-1166146	462320	-141304	27467	-2497	1	
	0	2497	-28939	162680	-641776	4134338	4134338	-641776	162680	-28939	2497	0	
		5	4	3	2	1	0	-1	-2	-3	-4	$k \setminus m$	

Compiled from National Bureau of Standards, Tables of Lagrangian interpolation coefficients. Columbia Univ. Press, New York, N.Y., 1944 (with permission).

*See page II.

Table 25.4 ABSCISSAS AND WEIGHT FACTORS FOR GAUSSIAN INTEGRATION

$$\int_{-1}^{+1} f(x)dx \approx \sum_{i=1}^n w_i f(x_i)$$

Abcissas = ±x _i (Zeros of Legendre Polynomials)			Weight Factors = w _i		
±x _i	w _i		±x _i	w _i	
n = 2			n = 8		
0.57735 02691 89626	1.00000 00000 00000		0.18343 46424 95650	0.36268 37833 78362	
			0.52553 24099 16329	0.31370 66458 77887	
			0.79666 64774 13627	0.22238 10344 53374	
			0.96028 98564 97536	0.10122 85362 90376	
n = 3			n = 9		
0.00000 00000 00000	0.88888 88888 88889		0.00000 00000 00000	0.33023 93550 01260	
0.77459 66692 41483	0.55555 55555 55556		0.32425 34234 03809	0.31234 70770 40003	
			0.61337 14327 00590	0.26061 06964 02935	
			0.83603 11073 26636	0.18064 81606 94857	
			0.96816 02395 07626	0.08127 43883 61574	
n = 4			n = 10		
0.33998 10435 84856	0.65214 51548 62546		0.14887 43389 81631	0.29552 42247 14753	
0.86113 63115 94053	0.34785 48451 37454		0.43339 53941 29247	0.26926 67193 09996	
			0.67940 95682 99024	0.21908 63625 15982	
			0.86506 33666 88985	0.14945 13491 50581	
			0.97390 65285 17172	0.06667 13443 08688	
n = 5			n = 12		
0.00000 00000 00000	0.56888 88888 88889		0.12523 34085 11469	0.24914 70458 13403	
0.53846 93101 05683	0.47862 86704 99366		0.36783 14989 98180	0.23349 25365 38355	
0.90617 98459 38664	0.23692 68850 56189		0.58731 79542 86617	0.20316 74267 23066	
			0.76990 26741 94305	0.16007 83285 43346	
			0.90411 72563 70475	0.10693 93259 95318	
			0.98156 06342 46719	0.04717 53363 86512	
n = 6			n = 16		
0.23861 91860 83197	0.46791 39345 72691		0.18945 06104 55068 496285		
0.66120 93864 66265	0.36076 15730 48139		0.18260 34150 44923 588867		
0.93246 95142 03152	0.17132 44923 79170		0.16915 65193 95002 538189		
			0.14959 59888 16576 732081		
			0.12462 89712 55533 872052		
			0.09515 85116 82492 784810		
			0.06225 35239 38647 892863		
			0.02715 24594 11754 094852		
n = 7			n = 20		
0.00000 00000 00000	0.41795 91836 73469		0.15275 33871 30725 850698		
0.40584 51513 77397	0.38183 00505 05119		0.14917 29864 72603 746788		
0.74153 11855 99394	0.27970 53914 89277		0.14209 61093 18382 051329		
0.94910 79123 42759	0.12948 49661 68870		0.13168 86384 49176 626898		
			0.11819 45319 61518 417312		
			0.10193 01198 17240 435037		
			0.08327 67415 76704 748725		
			0.06267 20483 34109 063570		
			0.04060 14298 00386 941331		
			0.01761 40071 39152 118312		
n = 16			n = 24		
0.09501 25098 37637 440185			0.12793 81953 46752 156974		
0.28160 35507 79258 913230			0.12583 74563 46828 296121		
0.45801 67776 57227 386342			0.12167 04729 27803 391204		
0.61787 62444 02643 748447			0.11550 56680 53725 601353		
0.75540 44083 55003 033895			0.10744 42701 15965 634783		
0.86563 12023 87831 743880			0.09761 86521 04113 888270		
0.94457 50230 73232 576078			0.08619 01615 31953 275917		
0.98940 09349 91649 932596			0.07334 64814 11080 305734		
			0.05929 85849 15436 780746		
			0.04427 74388 17419 806169		
			0.02853 13886 28933 663181		
			0.01234 12297 99987 199547		

Compiled from P. Davis and P. Rabinowitz, Abcissas and weights for Gaussian quadratures of high order, J. Research NBS 56, 35-37, 1956, RP2645; P. Davis and P. Rabinowitz, Additional abcissas and weights for Gaussian quadratures of high order. Values for n=64, 80, and 96, J. Research NBS 60, 613-614, 1958, RP2875; and A. N. Lowan, N. Davids, and A. Levenson, Table of the zeros of the Legendre polynomials of order 1-16 and the weight coefficients for Gauss' mechanical quadrature formula, Bull. Amer. Math. Soc. 48, 739-743, 1942 (with permission).

Table 25.4

ABSCISSAS AND WEIGHT FACTORS FOR GAUSSIAN INTEGRATION

$$\int_{-1}^{+1} f(x)dx \approx \sum_{i=1}^n w_i f(x_i)$$

Abscissas= $\pm x_i$ (Zeros of Legendre Polynomials) Weight Factors= w_i

$\pm x_i$	$n=32$				w_i			
0.04830	76656	87738	316235	0.09654	00885	14727	800567	
0.14447	19615	82796	493485	0.09563	87200	79274	859419	
0.23928	73622	52137	074545	0.09384	43990	80804	565639	
0.33186	86022	82127	649780	0.09117	38786	95763	884713	
0.42135	12761	30635	345364	0.08765	20930	04403	811143	
0.50689	99089	32229	390024	0.08331	19242	26946	755222	
0.58771	57572	40762	329041	0.07819	38957	87070	306472	
0.66304	42669	30215	200975	0.07234	57941	08848	506225	
0.73218	21187	40289	680387	0.06582	22227	76361	846838	
0.79448	37959	67942	406963	0.05868	40934	78535	547145	
0.84936	76137	32569	970134	0.05099	80592	62376	176196	
0.89632	11557	66052	123965	0.04283	58980	22226	680657	
0.93490	60759	37739	689171	0.03427	38629	13021	433103	
0.96476	22555	87506	430774	0.02539	20653	09262	059456	
0.98561	15115	45268	335400	0.01627	43947	30905	670605	
0.99726	38618	49481	563545	0.00701	86100	09470	096600	
$n=40$								
0.03877	24175	06050	821933	0.07750	59479	78424	811264	
0.11608	40706	75255	208483	0.07703	98181	64247	965588	
0.19269	75807	01371	099716	0.07611	03619	00626	242372	
0.26815	21850	07253	681141	0.07472	31690	57968	264200	
0.34199	40908	25758	473007	0.07288	65823	95804	059061	
0.41377	92043	71605	001525	0.07061	16473	91286	779695	
0.48307	58016	86178	712909	0.06791	20458	15233	903826	
0.54946	71250	95128	202076	0.06480	40134	56601	038075	
0.61255	38896	67980	237953	0.06130	62424	92928	939167	
0.67195	66846	14179	548379	0.05743	97690	99391	551367	
0.72731	82551	89927	103281	0.05322	78469	83936	824355	
0.77830	56514	26519	387695	0.04869	58076	35072	232061	
0.82461	22308	33311	663196	0.04387	09081	85673	271992	
0.86595	95032	12259	503821	0.03878	21679	74472	017640	
0.90209	88069	68874	296728	0.03346	01952	82547	847393	
0.93281	28082	78676	533361	0.02793	70069	80023	401098	
0.95791	68192	13791	655805	0.02224	58491	94166	957262	
0.97725	99499	83774	262663	0.01642	10583	81907	888713	
0.99072	62386	99457	006453	0.01049	82845	31152	813615	
0.99823	77097	10559	200350	0.00452	12770	98533	191258	
$n=48$								
0.03238	01709	62869	362033	0.06473	76968	12683	922503	
0.09700	46992	09462	698930	0.06446	61644	35950	082207	
0.16122	23560	68891	718056	0.06392	42385	84648	186624	
0.22476	37903	94689	061225	0.06311	41922	86254	025657	
0.28736	24873	55455	576736	0.06203	94231	59892	663904	
0.34875	58862	92160	738160	0.06070	44391	65893	880053	
0.40868	64819	90716	729916	0.05911	48396	98395	635746	
0.46690	29047	50958	404545	0.05727	72921	00403	215705	
0.52316	09747	22233	033678	0.05519	95036	99984	162868	
0.57722	47260	83972	703818	0.05289	01894	85193	667096	
0.62886	73967	76513	623995	0.05035	90355	53854	474958	
0.67787	23796	32663	905212	0.04761	66584	92490	474826	
0.72403	41309	23814	654674	0.04467	45608	56694	280419	
0.76715	90325	15740	339254	0.04154	50829	43464	749214	
0.80706	62040	29442	627083	0.03824	13510	65830	706317	
0.84358	82616	24393	530711	0.03477	72225	64770	438893	
0.87657	20202	74247	885906	0.03116	72278	32798	088902	
0.90587	91367	15569	672822	0.02742	65097	08356	948200	
0.93138	66907	06554	333114	0.02357	07608	39324	379141	
0.95298	77031	60430	860723	0.01961	61604	57355	527814	
0.97059	15925	46247	250461	0.01557	93157	22943	848728	
0.98412	45837	22826	857745	0.01147	72345	79234	539490	
0.99353	01722	66350	757548	0.00732	75539	01276	262102	
0.99877	10072	52426	118601	0.00315	33460	52305	838633	

Table 25.4

ABSCISSAS AND WEIGHT FACTORS FOR GAUSSIAN INTEGRATION

$$\int_{-1}^{+1} f(x) dx \approx \sum_{i=1}^n w_i f(x_i)$$

Abscissas = $\pm x_i$ (Zeros of Legendre Polynomials) Weight Factors = w_i

$\pm x_i$				w_i			
$n=64$							
0.02435	0.02926	0.03424	0.032509	0.04869	0.09570	0.09139	0.0720383
0.07299	0.1217	0.17799	0.039450	0.04857	0.054674	0.041503	0.0426935
0.12146	0.28192	0.96120	0.054470	0.04834	0.47622	0.34802	0.957170
0.16964	0.44204	0.23992	0.0818037	0.04799	0.93885	0.96458	0.307728
0.21742	0.36437	0.40007	0.084150	0.04754	0.01657	0.14830	0.308662
0.26468	0.71622	0.08767	0.416374	0.04696	0.81828	0.16210	0.017325
0.31132	0.28719	0.90210	0.956158	0.04628	0.47965	0.81314	0.417296
0.35722	0.01583	0.37668	0.115950	0.04549	0.16279	0.27418	0.144480
0.40227	0.01579	0.63991	0.603696	0.04459	0.05581	0.63756	0.563060
0.44636	0.60172	0.53464	0.087985	0.04358	0.37245	0.29323	0.453377
0.48940	0.31457	0.07052	0.957479	0.04247	0.35151	0.23653	0.589007
0.53127	0.94640	0.19894	0.545658	0.04126	0.25632	0.42623	0.528610
0.57189	0.56462	0.02634	0.034284	0.03995	0.37411	0.32720	0.341387
0.61115	0.53551	0.72393	0.250249	0.03855	0.01531	0.78615	0.629129
0.64896	0.54712	0.54657	0.339858	0.03705	0.51285	0.40240	0.046040
0.68523	0.63130	0.54233	0.242564	0.03547	0.22132	0.56882	0.383811
0.71988	0.18501	0.71610	0.826849	0.03380	0.51618	0.37141	0.609392
0.75281	0.99072	0.60531	0.896612	0.03205	0.79283	0.54851	0.553585
0.78397	0.23589	0.43341	0.407610	0.03023	0.46570	0.72402	0.478868
0.81326	0.53151	0.22797	0.559742	0.02833	0.96726	0.14259	0.483228
0.84062	0.92962	0.52580	0.362752	0.02637	0.74697	0.15054	0.658672
0.86599	0.93981	0.54092	0.819761	0.02435	0.27025	0.68710	0.873338
0.88931	0.54459	0.95114	0.105853	0.02227	0.01738	0.08383	0.254159
0.91052	0.21370	0.78502	0.805756	0.02013	0.48231	0.53530	0.209372
0.92956	0.91721	0.31939	0.575821	0.01795	0.17157	0.75697	0.343085
0.94641	0.13748	0.58402	0.816062	0.01572	0.60304	0.76024	0.719322
0.96100	0.87996	0.52053	0.718919	0.01346	0.30478	0.96718	0.642598
0.97332	0.68277	0.89910	0.963742	0.01116	0.81394	0.60131	0.128819
0.98333	0.62538	0.84625	0.956931	0.00884	0.67598	0.26363	0.947723
0.99101	0.33714	0.76744	0.320739	0.00650	0.44579	0.68978	0.362856
0.99634	0.01167	0.71955	0.279347	0.00414	0.70332	0.60562	0.467635
0.99930	0.50417	0.35772	0.139457	0.00178	0.32807	0.21696	0.432947
$n=80$							
0.01951	0.13832	0.56793	0.997654	0.03901	0.78136	0.56306	0.654811
0.05850	0.44371	0.52420	0.668629	0.03895	0.83959	0.62769	0.531199
0.09740	0.83984	0.41584	0.599063	0.03883	0.96510	0.59051	0.968932
0.13616	0.40228	0.09143	0.886559	0.03866	0.17597	0.74076	0.463327
0.17471	0.22918	0.32646	0.812559	0.03842	0.49930	0.06959	0.423185
0.21299	0.45028	0.57666	0.132572	0.03812	0.97113	0.14477	0.638344
0.25095	0.23583	0.92272	0.120493	0.03777	0.63643	0.62001	0.397490
0.28852	0.80548	0.84511	0.853109	0.03736	0.54902	0.38730	0.490027
0.32566	0.43707	0.47701	0.914619	0.03689	0.77146	0.38276	0.008839
0.36230	0.47534	0.99487	0.315619	0.03637	0.37499	0.05835	0.978044
0.39839	0.34058	0.81969	0.227024	0.03579	0.43939	0.53416	0.054603
0.43387	0.53708	0.31756	0.093062	0.03516	0.05290	0.44747	0.593496
0.46869	0.66151	0.70544	0.477036	0.03447	0.31204	0.51753	0.928794
0.50280	0.41118	0.88784	0.987594	0.03373	0.32149	0.84611	0.522817
0.53614	0.59208	0.97131	0.932020	0.03294	0.19393	0.97645	0.401383
0.56867	0.12681	0.22709	0.784725	0.03210	0.04986	0.73487	0.773148
0.60033	0.06228	0.29751	0.743155	0.03121	0.01741	0.88114	0.701642
0.63107	0.57730	0.46871	0.966248	0.03027	0.23217	0.59557	0.980661
0.66085	0.98989	0.86119	0.801736	0.02928	0.83695	0.83267	0.847693
0.68963	0.76443	0.42027	0.600771	0.02825	0.98160	0.57276	0.862397
0.71736	0.51853	0.62099	0.880254	0.02718	0.82275	0.00486	0.380674
0.74400	0.02975	0.83597	0.272317	0.02607	0.52357	0.67565	0.117903
0.76950	0.24201	0.35041	0.373866	0.02492	0.25357	0.64115	0.491105
0.79383	0.27175	0.04605	0.449949	0.02373	0.18828	0.65930	0.101293
0.81695	0.41386	0.81463	0.470371	0.02250	0.50902	0.46332	0.461926
0.83883	0.14735	0.80255	0.275617	0.02124	0.40261	0.15782	0.006389
0.85943	0.14066	0.63111	0.096977	0.01995	0.06108	0.78141	0.998929
0.87872	0.25676	0.78213	0.828704	0.01862	0.68142	0.08299	0.031429
0.89667	0.55794	0.38770	0.683194	0.01727	0.46520	0.56269	0.306359
0.91326	0.31025	0.71757	0.654165	0.01589	0.61835	0.83725	0.688045
0.92845	0.98771	0.72445	0.795953	0.01449	0.35080	0.40509	0.076117
0.94224	0.27613	0.09872	0.674752	0.01306	0.87615	0.92401	0.339294
0.95459	0.07663	0.43634	0.905493	0.01162	0.41141	0.20797	0.826916
0.96548	0.50890	0.43799	0.251452	0.01016	0.17660	0.41103	0.064521
0.97490	0.91405	0.85727	0.793386	0.00868	0.39452	0.69260	0.858426
0.98284	0.85727	0.38629	0.070418	0.00719	0.29047	0.68117	0.312753
0.98929	0.13024	0.99755	0.531027	0.00569	0.09224	0.51403	0.198649
0.99422	0.75409	0.65688	0.277892	0.00418	0.03131	0.24694	0.895237
0.99764	0.98643	0.98237	0.688900	0.00266	0.35335	0.89512	0.681669
0.99955	0.38226	0.51630	0.629880	0.00114	0.49500	0.03186	0.941534

Table 25.4

ABSCISSAS AND WEIGHT FACTORS FOR GAUSSIAN INTEGRATION

$$\int_{-1}^{+1} f(x)dx \approx \sum_{i=1}^n w_i f(x_i)$$

Abscissas= $\pm x_i$ (Zeros of Legendre Polynomials)				Weight Factors= w_i				
$\pm x_i$				$n = 96$	w_i			
0.01627	67448	49602	969579		0.03255	06144	92363	166242
0.04881	29851	36049	731112		0.03251	61187	13868	835987
0.08129	74954	64425	558994		0.03244	71637	14064	269364
0.11369	58501	10665	920911		0.03234	38225	68575	928429
0.14597	37146	54896	941989		0.03220	62047	94030	250669
0.17809	68823	67618	602759		0.03203	44562	31992	663218
0.21003	13104	60567	203603		0.03182	87588	94411	006535
0.24174	31561	63840	012328		0.03158	93307	70727	168558
0.27319	88125	91049	141487		0.03131	64255	96861	355813
0.30436	49443	54496	353024		0.03101	03325	86313	837423
0.33520	85228	92625	422616		0.03067	13761	23669	149014
0.36569	68614	72313	635031		0.03029	99154	20827	593794
0.39579	76498	28908	603285		0.02989	63441	36328	385984
0.42547	89884	07300	545365		0.02946	10899	58167	905970
0.45470	94221	67743	008636		0.02899	46141	50555	236543
0.48345	79739	20596	359768		0.02849	74110	65085	385646
0.51169	41771	54667	673586		0.02797	00076	16848	334440
0.53938	81083	24357	436227		0.02741	29627	26029	242823
0.56651	04185	61397	168404		0.02682	68667	25591	762198
0.59303	23647	77572	080684		0.02621	23407	35672	413913
0.61892	58401	25468	570386		0.02557	00360	05349	361499
0.64416	34037	84967	106798		0.02490	06332	22483	610288
0.66871	83100	43916	153953		0.02420	48417	92364	691282
0.69256	45366	42171	561344		0.02348	33990	85926	219842
0.71567	68123	48967	626225		0.02273	70696	58329	374001
0.73803	06437	44400	132851		0.02196	66444	38744	349195
0.75960	23411	76647	498703		0.02117	29398	92191	298988
0.78036	90438	67433	217604		0.02035	67971	54333	324595
0.80030	87441	39140	817229		0.01951	90811	40145	022410
0.81940	03107	37931	675539		0.01866	06796	27411	467385
0.83762	35112	28187	121494		0.01778	25023	16045	260838
0.85495	90334	34601	455463		0.01688	54798	64245	172450
0.87138	85059	09296	502874		0.01597	05629	02562	291381
0.88689	45174	02420	416057		0.01503	87210	26994	938006
0.90146	06353	15852	341319		0.01409	09417	72314	860916
0.91507	14231	20898	074206		0.01312	82295	66961	572637
0.92771	24567	22308	690965		0.01215	16046	71088	319635
0.93937	03397	52755	216932		0.01116	21020	99838	498591
0.95003	27177	84437	635756		0.01016	07705	35008	415758
0.95968	82914	48742	539300		0.00914	86712	30783	386633
0.96832	68284	63264	212174		0.00812	68769	25698	759217
0.97593	91745	85136	466453		0.00709	64707	91153	865269
0.98251	72635	63014	677447		0.00605	85455	04235	961683
0.98805	41263	29623	799481		0.00501	42027	42927	517693
0.99254	39003	23762	624572		0.00396	45543	38444	686674
0.99598	18429	87209	290650		0.00291	07318	17934	946408
0.99836	43758	63181	677724		0.00185	39607	88946	921732
0.99968	95038	83230	766828		0.00079	67920	65552	012429

Table 25.5 ABSCISSAS FOR EQUAL WEIGHT CHEBYSHEV INTEGRATION

$$\int_{-1}^{+1} f(x) dx \approx \frac{2}{n} \sum_{i=1}^n f(x_i)$$

Abscissas = $\pm x_i$

<i>n</i>	$\pm x_i$	<i>n</i>	$\pm x_i$	<i>n</i>	$\pm x_i$
2	0, 57735 02692	5	0, 83249 74870 0, 37454 14096 0, 00000 00000	7	0, 88386 17008 0, 52965 67753 0, 32391 18105 0, 00000 00000
3	0, 70710 67812 0, 00000 00000	6	0, 86624 68181 0, 42251 86538 0, 26663 54015	9	0, 91158 93077 0, 60101 86554 0, 52876 17831 0, 16790 61842 0, 00000 00000
4	0, 79465 44723 0, 18759 24741				

Compiled from H. E. Salzer, Tables for facilitating the use of Chebyshev's quadrature formula, J. Math. Phys. 26, 191-194, 1947 (with permission).

Table 25.6 ABSCISSAS AND WEIGHT FACTORS FOR LOBATTO INTEGRATION

$$\int_{-1}^{+1} f(x) dx \approx w_1 f(-1) + \sum_{i=2}^{n-1} w_i f(x_i) + w_n f(1)$$

Abscissas = $\pm x_i$			Weight Factors = w_i		
<i>n</i>	$\pm x_i$	w_i	<i>n</i>	$\pm x_i$	w_i
3	1, 00000 000 0, 00000 000	0, 33333 333 1, 33333 333	7	1, 00000 000 0, 83022 390 0, 46884 879 0, 00000 000	0, 04761 904 0, 27682 604 0, 43174 538 0, 48761 904
4	1, 00000 000 0, 44721 360	0, 16666 667 0, 83333 333	8	1, 00000 000 0, 87174 015 0, 59170 018 0, 20929 922	0, 03571 428 0, 21070 422 0, 34112 270 0, 41245 880
5	1, 00000 000 0, 65465 367 0, 00000 000	0, 10000 000 0, 54444 444 0, 71111 111	9	1, 00000 00000 0, 89975 79954 0, 67718 62795 0, 36311 74638 0, 00000 00000	0, 02777 77778 0, 16549 53616 0, 27453 87126 0, 34642 85110 0, 37151 92744
6	1, 00000 000 0, 76505 532 0, 28523 152	0, 06666 667 0, 37847 496 0, 55485 838	10	1, 00000 00000 0, 91953 39082 0, 73877 38651 0, 47792 49498 0, 16527 89577	0, 02222 22222 0, 13330 59908 0, 22488 93420 0, 29204 26836 0, 32753 97612

Compiled from Z. Kopal, Numerical analysis, John Wiley & Sons, Inc., New York, N.Y., 1955 (with permission).

Table 25.7 ABSCISSAS AND WEIGHT FACTORS FOR GAUSSIAN INTEGRATION FOR INTEGRANDS WITH A LOGARITHMIC SINGULARITY

$$\int_0^1 f(x) \ln x dx = \sum_{i=1}^n w_i f(x_i) + \frac{f^{(2n)}(\xi)}{(2n)!} K_n$$

Abscissas = x_i				Weight Factors = w_i			
<i>n</i>	x_i	$-w_i$	K_n	<i>n</i>	x_i	$-w_i$	K_n
2	0,112009 0,602277	0,718539 0,281461	0,00285	3	0,063891 0,368997 0,766880	0,513405 0,391980 0,094615	0,00017
				4	0,041448 0,245275 0,556165 0,848982	0,383464 0,386875 0,190435 0,039225	0,00001

Compiled from Berthod-Zaborowski, Le calcul des intégrales de la forme $\int_0^1 f(x) \log x dx$. H. Mineur, Techniques de calcul numérique, pp. 555-556. Librairie Polytechnique Ch. Béranger, Paris, France, 1952 (with permission).

*See page 11.

ABSCISSAS AND WEIGHT FACTORS FOR GAUSSIAN INTEGRATION OF MOMENTS Table 25.8

$$\int_0^1 x^k f(x) dx \approx \sum_{i=1}^n w_i f(x_i)$$

n	Abscissas = x_i				Weight Factors = w_i			
	k=0		k=1		k=1		k=2	
	x_i	w_i	x_i	w_i	x_i	w_i	x_i	w_i
1	0.50000 00000	1.00000 00000	0.66666 66667	0.50000 00000	0.75000 00000	0.33333 33333		
2	0.21132 48654 0.78867 51346	0.50000 00000 0.50000 00000	0.35505 10257 0.84494 89743	0.18195 86183 0.31804 13817	0.45584 81560 0.87748 51773	0.10078 58821 0.23254 74513		
3	0.11270 16654 0.50000 00000 0.88729 83346	0.27777 77778 0.44444 44444 0.27777 77778	0.21234 05382 0.59053 31356 0.91141 20405	0.06982 69799 0.22924 11064 0.20093 19137	0.29499 77901 0.65299 62340 0.92700 59759	0.02995 07030 0.14624 62693 0.15713 63611		
4	0.06943 18442 0.33000 94782 0.66999 05218 0.93056 81558	0.17392 74226 0.32607 25774 0.32607 25774 0.17392 74226	0.13975 98643 0.41640 95676 0.72315 69864 0.94289 58039	0.03118 09710 0.12984 75476 0.20346 45680 0.13550 69134	0.20414 85821 0.48295 27049 0.76139 92624 0.95149 94506	0.01035 22408 0.06863 38872 0.14345 87898 0.11088 84156		
5	0.04691 00770 0.23076 53449 0.50000 00000 0.76923 46551 0.95308 99230	0.11846 34425 0.23931 43352 0.28444 44444 0.23931 43352 0.11846 34425	0.09853 50858 0.30453 57266 0.56202 51898 0.80198 65821 0.96019 01429	0.01574 79145 0.07390 88701 0.14638 69871 0.16717 46381 0.09678 15902	0.14894 57871 0.36566 65274 0.61011 36129 0.82651 96792 0.96542 10601	0.00411 38252 0.03205 56007 0.08920 01612 0.12619 89619 0.08176 47843		
6	0.03376 52429 0.16939 53068 0.38069 04070 0.61930 95930 0.83060 46932 0.96623 47571	0.08566 22462 0.18038 07865 0.23395 69673 0.23395 69673 0.18038 07865 0.08566 22462	0.07305 43287 0.23076 61380 0.44132 84812 0.66301 53097 0.85192 14003 0.97068 35728	0.00873 83018 0.04395 51656 0.09866 11509 0.14079 25538 0.13554 24972 0.07231 03307	0.11319 43838 0.28431 88727 0.49096 35868 0.69756 30820 0.86843 60583 0.97409 54449	0.00183 10758 0.01572 02972 0.05128 95711 0.09457 71867 0.10737 64997 0.06253 87027		
7	0.02544 60438 0.12923 44072 0.29707 74243 0.50000 00000 0.70292 25757 0.87076 55928 0.97455 39562	0.06474 24831 0.13985 26957 0.19091 50253 0.20897 95918 0.19091 50253 0.13985 26957 0.06474 24831	0.05626 25605 0.18024 06917 0.35262 47171 0.54715 36263 0.73421 01772 0.88532 09468 0.97752 06136	0.00521 43622 0.02740 83567 0.06638 46965 0.10712 50657 0.12739 08973 0.11050 92582 0.05596 73634	0.08881 68334 0.22648 27534 0.39997 84867 0.58599 78554 0.75944 58740 0.89691 09709 0.97986 72262	0.00089 26880 0.00816 29256 0.02942 22113 0.06314 63787 0.09173 38033 0.09069 88246 0.04927 65018		
8	0.01985 50718 0.10166 67613 0.23723 37950 0.40828 26788 0.59171 73212 0.76276 62050 0.89833 32387 0.98014 49282	0.05061 42681 0.11119 05172 0.15685 33229 0.18134 18917 0.18134 18917 0.15685 33229 0.11119 05172 0.05061 42681	0.04463 39553 0.14436 62570 0.28682 47571 0.45481 33152 0.62806 78354 0.78569 15206 0.90867 63921 0.98222 00849	0.00329 51914 0.01784 29027 0.04543 93195 0.07919 95995 0.10604 73594 0.11250 57995 0.09111 90236 0.04455 08044	0.07149 10350 0.18422 82964 0.33044 77282 0.49440 29218 0.65834 80085 0.80452 48315 0.91709 93825 0.98390 22404	0.00046 85178 0.00447 45217 0.01724 68638 0.04081 44264 0.06844 71834 0.08528 47692 0.07681 80933 0.03977 89578		

Compiled from H. Fishman, Numerical integration constants, Math. Tables Aids Comp. 11, 1-9, 1957 (with permission).

Table 25.8 ABSCISSAS AND WEIGHT FACTORS FOR GAUSSIAN INTEGRATION OF MOMENTS

$$\int_0^1 x^k f(x) dx \approx \sum_{i=1}^n w_i f(x_i)$$

n	Abscissas = x_i				Weight Factors = w_i							
	k=3		k=4		k=4		k=5					
	x_i	w_i	x_i	w_i	x_i	w_i	x_i	w_i				
1	0.80000	00000	0.25000	00000	0.83333	33333	0.20000	00000	0.85714	28571	0.16666	66667
2	0.52985	79359	0.06690	52498	0.58633	65823	0.04908	24923	0.63079	15938	0.03833	75627
	0.89871	34927	0.18309	47502	0.91366	34177	0.15091	75077	0.92476	39617	0.12832	91039
3	0.36326	46302	0.01647	90593	0.42011	30593	0.01046	90422	0.46798	32355	0.00729	70036
	0.69881	12692	0.10459	98976	0.73388	93552	0.08027	66735	0.76162	39697	0.06459	66123
	0.93792	41006	0.12892	10432	0.94599	75855	0.10925	42844	0.95221	09767	0.09477	30507
4	0.26147	77888	0.00465	83671	0.31213	54928	0.00251	63516	0.35689	37290	0.00153	44797
	0.53584	64461	0.04254	17241	0.57891	56596	0.02916	93822	0.61466	93899	0.02142	84046
	0.79028	32300	0.10900	43689	0.81289	15166	0.08706	77121	0.83107	90039	0.07205	63642
	0.95784	70806	0.09379	55399	0.96272	39976	0.08124	65541	0.96658	86465	0.07164	74181
5	0.19621	20074	0.00152	06894	0.23979	20448	0.00069	69771	0.27969	31248	0.00036	97155
	0.41710	02118	0.01695	73249	0.46093	36745	0.01021	05417	0.49870	98270	0.00672	96904
	0.64857	00042	0.06044	49532	0.68005	92327	0.04402	44695	0.70633	38189	0.03376	77450
	0.84560	51500	0.10031	65045	0.86088	63437	0.08271	27131	0.87340	27279	0.07007	13397
	0.96943	57035	0.07076	05281	0.97261	44185	0.06235	52986	0.97519	38347	0.05572	81761
6	0.15227	31618	0.00056	17109	0.18946	95839	0.00021	94140	0.22446	89954	0.00010	13258
	0.33130	04570	0.00708	53159	0.37275	11560	0.00372	67844	0.40953	33505	0.00218	79257
	0.53241	15667	0.03052	61922	0.56757	23729	0.01995	62647	0.59778	90484	0.01396	96531
	0.72560	27783	0.06844	32818	0.74883	64975	0.05223	99543	0.76841	36046	0.04148	63470
	0.88161	66844	0.08830	09912	0.89238	51584	0.07464	91503	0.90135	07338	0.06445	88592
	0.97679	53517	0.05508	25080	0.97898	52313	0.04920	84323	0.98079	72084	0.04446	25560
7	0.12142	71288	0.00022	99041	0.15324	14389	0.00007	70737	0.18382	87683	0.00003	11046
	0.26836	34403	0.00314	75964	0.30632	65225	0.00144	70088	0.34080	75951	0.00075	53838
	0.44086	64606	0.01531	21671	0.47654	00930	0.00892	69676	0.50794	05240	0.00566	04137
	0.61860	40284	0.04099	51686	0.64638	93025	0.02854	78428	0.67036	34101	0.02095	92982
	0.78025	35520	0.06975	00981	0.79771	66898	0.05522	48742	0.81258	84660	0.04510	49816
	0.90636	25341	0.07655	65614	0.91421	99006	0.06602	18459	0.92085	64173	0.05790	76135
	0.98176	99145	0.04400	85043	0.98334	38305	0.03975	43870	0.98466	74508	0.03624	78712
8	0.09900	17577	0.00010	24601	0.12637	29744	0.00002	97092	0.15315	06616	0.00001	05316
	0.22124	35074	0.00148	56841	0.25552	90521	0.00059	89500	0.28726	44039	0.00027	83586
	0.36912	39000	0.00785	50738	0.40364	12989	0.00407	79241	0.43462	74067	0.00233	53415
	0.52854	54312	0.02363	15807	0.55831	66758	0.01490	99334	0.58451	85666	0.01004	46144
	0.68399	32484	0.04745	43798	0.70600	95429	0.03471	99507	0.72512	64097	0.02648	53011
	0.82028	39497	0.06736	18394	0.83367	15420	0.05491	00973	0.84518	94879	0.04588	56532
	0.92409	37129	0.06618	20353	0.92999	57161	0.05800	05653	0.93504	35075	0.05153	42238
	0.98529	34401	0.03592	69468	0.98646	31979	0.03275	28699	0.98746	05085	0.03009	26424

ABSCISSAS AND WEIGHT FACTORS FOR LAGUERRE INTEGRATION

Table 25.9

$$\int_0^\infty e^{-x} f(x) dx \approx \sum_{i=1}^n w_i f(x_i)$$

$$\int_0^\infty g(x) dx \approx \sum_{i=1}^n w_i e^{x_i} g(x_i)$$

Abscissas = x_i (Zeros of Laguerre Polynomials)

Weight Factors = w_i

x_i	w_i	$w_i e^{x_i}$	x_i	w_i	$w_i e^{x_i}$
n=2					
0.58578 64376 27	(-1) 8.53553 390593	1.53332 603312	0.15232 22277 32	(-1) 3.36126 421798	0.39143 11243 16
3.41421 35623 73	(-1) 1.46446 609407	4.45095 733505	0.80722 00227 42	(-1) 4.11213 980424	0.92180 50285 29
n=3					
0.41577 45567 83	(-1) 7.11093 009929	1.07769 285927	2.00513 51556 19	(-1) 1.99287 525371	1.48012 790994
2.29428 03602 79	(-1) 2.78517 733569	2.76214 296190	3.78347 39733 31	(-2) 4.74605 627657	2.08677 080755
6.28994 50829 37	(-2) 1.03892 565016	5.60109 462543	6.20495 67778 77	(-3) 5.59962 661079	2.77292 138971
n=4					
0.32254 76896 19	(-1) 6.03154 104342	0.83273 91238 38	9.37298 52516 88	(-4) 3.05249 767093	3.59162 606809
1.74576 11011 58	(-1) 3.57418 692438	2.04810 243845	13.46623 69110 92	(-6) 6.59212 302608	4.64876 600214
4.53662 02969 21	(-2) 3.88879 085150	3.63114 630582	18.83359 77889 92	(-8) 4.11076 933035	6.21227 541975
9.39507 09123 01	(-4) 5.39294 705561	6.48714 508441	26.37407 18909 27	(-11) 3.29087 403035	9.36321 823771
n=5					
0.26356 03197 18	(-1) 5.21755 610583	0.67909 40422 08	0.13779 34705 40	(-1) 3.08441 115765	0.35400 97386 07
1.41340 30591 07	(-1) 3.98666 811083	1.63848 787360	0.72945 45495 03	(-1) 4.01119 929155	0.83190 23010 44
3.59642 57710 41	(-2) 7.59424 496817	2.76944 324237	1.80834 29017 40	(-1) 2.18068 287612	1.33028 856175
7.08581 00058 59	(-3) 3.61175 867992	4.31565 690092	3.40143 36978 55	(-2) 6.20874 560987	1.86306 390311
12.64080 08442 76	(-5) 2.33699 723858	7.21918 635435	5.55249 61400 64	(-3) 9.50151 697518	2.45025 555808
n=6					
0.22284 66041 79	(-1) 4.58964 673950	0.57353 55074 23	8.33015 27467 64	(-4) 7.53008 388588	3.12276 415514
1.18893 21016 73	(-1) 4.17000 830772	1.36925 259071	11.84378 58379 00	(-5) 2.82592 334960	3.93415 269556
2.99273 63260 59	(-1) 1.13373 382074	2.26068 459338	16.27925 78313 78	(-7) 4.24931 398496	4.99241 487219
5.77514 35691 05	(-2) 1.03991 974531	3.35052 458236	21.99658 58119 81	(-9) 1.83956 482398	6.57220 248513
9.83746 74183 83	(-4) 2.61017 202815	4.88682 680021	29.92069 70122 74	(-13) 9.91182 721961	9.78469 584037
15.98287 39806 02	(-7) 8.98547 906430	7.84901 594560			
n=7					
0.19304 36765 60	(-1) 4.09318 951701	0.49647 75975 40	0.11572 21173 58	(-1) 2.64731 371055	0.29720 96360 44
1.02666 48953 39	(-1) 4.21831 277862	1.17764 306086	0.61175 74845 15	(-1) 3.77759 275873	0.69646 29804 31
2.56787 67449 51	(-1) 1.47126 348658	1.91824 978166	1.51261 02697 76	(-1) 2.44082 011320	1.10778 139462
4.90035 30845 26	(-2) 2.06335 144687	2.77184 863623	2.83375 13377 44	(-2) 9.04492 222117	1.53846 423904
8.18215 34445 63	(-3) 1.07401 014328	3.84124 912249	4.59922 76394 18	(-2) 2.01023 811546	1.99832 760627
12.73418 02917 98	(-5) 1.58654 643486	5.38067 820792	6.84452 54531 15	(-3) 2.66397 354187	2.50074 576910
19.39572 78622 63	(-8) 3.17031 547900	8.40543 248683	9.62131 68424 57	(-4) 2.03231 592663	3.06532 151828
n=8					
0.17027 96323 05	(-1) 3.69188 589342	0.43772 34104 93	13.00605 49933 06	(-6) 8.36505 585682	3.72328 911078
0.90370 17767 99	(-1) 4.18786 780814	1.03386 934767	17.11685 51874 62	(-7) 1.66849 387654	4.52981 402998
2.25108 66298 66	(-1) 1.75794 986637	1.66970 976566	22.15109 03793 97	(-9) 1.34239 103052	5.59725 846184
4.26670 01702 88	(-2) 3.33434 922612	2.37692 470176	28.48796 72509 84	(-12) 3.06160 163504	7.21299 546093
7.04590 54023 93	(-3) 2.79453 623523	3.20854 091335	37.09912 10444 67	(-16) 8.14807 746743	10.54383 74619
10.75851 60101 81	(-5) 9.07650 877336	4.26857 551083			
15.74067 86412 78	(-7) 8.48574 671627	5.81808 336867			
22.86313 17368 89	(-9) 1.04800 117487	8.90622 621529			
n=9					
0.15232 22277 32	(-1) 3.36126 421798	0.39143 11243 16	0.09330 78120 17	(-1) 2.18234 885940	0.23957 81703 11
0.80722 00227 42	(-1) 4.11213 980424	0.92180 50285 29	0.49269 17403 02	(-1) 3.42210 177923	0.56010 08427 93
2.00513 51556 19	(-1) 1.99287 525371	1.48012 790994	1.21559 54120 71	(-1) 2.63027 577942	0.88700 82629 19
3.78347 39733 31	(-2) 4.74605 627657	2.08677 080755	2.26994 95262 04	(-1) 1.26425 818106	1.22366 440215
6.20495 67778 77	(-3) 5.59962 661079	2.77292 138971	3.66762 27217 51	(-2) 4.02068 649210	1.57444 872163
9.37298 52516 88	(-4) 3.05249 767093	3.59162 606809	5.42533 66274 14	(-3) 8.56387 780361	1.94475 197653
13.46623 69110 92	(-6) 6.59212 302608	4.64876 600214	7.56591 62266 13	(-3) 1.21243 614721	2.34150 205664
18.83359 77889 92	(-8) 4.11076 933035	6.21227 541975	10.12022 85680 19	(-4) 1.11674 392344	2.77404 192683
26.37407 18909 27	(-11) 3.29087 403035	9.36321 823771	13.13028 24821 76	(-6) 6.45992 676202	3.25564 334640
			16.65440 77083 30	(-7) 2.22631 690710	3.80631 171423
			20.77647 88994 49	(-9) 4.22743 038498	4.45847 775384
			25.62389 42267 29	(-11) 3.92189 726704	5.27001 778443
			31.40751 91697 54	(-13) 1.45651 526407	6.35956 346973
			38.53068 33064 86	(-16) 1.48302 705111	8.03178 763212
			48.02608 55726 86	(-20) 1.60059 490621	11.52777 21009

Compiled from H. E. Salzer and R. Zucker, Table of the zeros and weight factors of the first fifteen Laguerre polynomials, Bull. Amer. Math. Soc. 55, 1004-1012, 1949 (with permission).

Table 25.10 ABSCISSAS AND WEIGHT FACTORS FOR HERMITE INTEGRATION

$\int_{-\infty}^{\infty} e^{-x^2} f(x) dx \approx \sum_{i=1}^n w_i f(x_i)$			$\int_{-\infty}^{\infty} g(x) dx \approx \sum_{i=1}^n w_i e^{x_i^2} g(x_i)$		
Abscissas = $\pm x_i$ (Zeros of Hermite Polynomials)			Weight Factors = w_i		
$\pm x_i$	w_i	$w_i e^{x_i^2}$	$\pm x_i$	w_i	$w_i e^{x_i^2}$
n=2			n=10		
0.70710 67811 86548	(-1)8.86226 92545 28	1.46114 11826 611	0.34290 13272 23705	(-1)6.10862 63373 53	0.68708 18539 513
n=3			n=12		
0.00000 00000 00000	(0)1.18163 59006 04	1.18163 59006 037	1.03661 08297 89514	(-1)2.40138 61108 23	0.70329 63231 049
1.22474 48713 91589	(-1)2.95408 97515 09	1.32393 11752 136	1.75668 36492 99882	(-2)3.38743 94455 48	0.74144 19319 436
n=4			n=16		
0.52464 76232 75290	(-1)8.04914 09000 55	1.05996 44828 950	0.31424 03762 54359	(-1)5.70135 23626 25	0.62930 78743 695
1.65068 01238 85785	(-2)8.13128 35447 25	1.24022 58176 958	0.94778 83912 40164	(-1)2.60492 31026 42	0.63962 12320 203
n=5			n=18		
0.00000 00000 00000	(-1)9.45308 72048 29	0.94530 87204 829	1.59768 26351 52605	(-2)5.16079 85615 88	0.66266 27732 669
0.95857 24646 13819	(-1)3.93619 32315 22	0.98658 09967 514	2.27950 70805 01060	(-3)3.90539 05846 29	0.70522 03661 122
2.02018 28704 56086	(-2)1.99532 42059 05	1.18148 86255 360	3.02063 70251 20890	(-5)8.57368 70435 88	0.78664 39394 633
n=6			n=20		
0.43607 74119 27617	(-1)7.24629 59522 44	0.87640 13344 362	0.27348 10461 3815	(-1)5.07929 47901 66	0.54737 52050 378
1.33584 90740 13697	(-1)1.57067 32032 29	0.93558 05576 312	0.82295 14491 4466	(-1)2.80647 45852 85	0.55244 19573 675
2.35060 49736 74492	(-3)4.53000 99055 09	1.13690 83326 745	1.38025 85391 9888	(-2)8.38100 41398 99	0.56321 78290 882
n=7			n=22		
0.00000 00000 00000	(-1)8.10264 61755 68	0.81026 46175 568	1.95178 79909 1625	(-2)1.28803 11535 51	0.58124 72754 009
0.81628 78828 58965	(-1)4.25607 25261 01	0.82868 73032 836	2.54620 21578 4748	(-4)9.32284 00862 42	0.60973 69582 560
1.67355 16287 67471	(-2)5.45155 82819 13	0.89718 46002 252	3.17699 91619 7996	(-5)2.71186 00925 38	0.65575 56728 761
2.65196 13568 35233	(-4)9.71781 24509 95	1.10133 07296 103	3.86944 79048 6012	(-7)2.32098 08448 65	0.73824 56222 777
n=8			n=24		
0.38118 69902 07322	(-1)6.61147 01255 82	0.76454 41286 517	0.24534 07083 009	(-1)4.62243 66960 06	0.49092 15006 667
1.15719 37124 46780	(-1)2.07802 32581 49	0.79289 00483 864	0.73747 37285 454	(-1)2.86675 50536 28	0.49384 33852 721
1.98165 67566 95843	(-2)1.70779 83007 41	0.86675 26065 634	1.23407 62153 953	(-1)1.09017 20602 00	0.49992 08713 363
2.93063 74202 57244	(-4)1.99604 07221 14	1.07193 01442 480	1.73853 77121 166	(-2)2.48105 20887 46	0.50967 90271 175
n=9			n=26		
0.00000 00000 00000	(-1)7.20235 21560 61	0.72023 52156 061	2.25497 40020 893	(-3)3.24377 33422 38	0.52408 03509 486
0.72355 10187 52838	(-1)4.32651 55900 26	0.73030 24527 451	2.78880 60584 281	(-4)2.28338 63601 63	0.54485 17423 644
1.46855 32892 16668	(-2)8.84745 27394 38	0.76460 81250 946	3.34785 45673 832	(-6)7.80255 64785 32	0.57526 24428 525
2.26658 05845 31843	(-3)4.94362 42755 37	0.84175 27014 787	3.94476 40401 156	(-7)1.08606 93707 69	0.62227 86961 914
3.19099 32017 81528	(-5)3.96069 77263 26	1.04700 35809 767	4.60368 24495 507	(-10)4.39934 09922 73	0.70433 29611 769
			5.38748 08900 112	(-13)2.22939 36455 34	0.89859 19614 532

Compiled from H. E. Salzer, R. Zucker, and R. Capuano, Table of the zeros and weight factors of the first twenty Hermite polynomials, J. Research NBS 48, 111-116, 1952, RP2294 (with permission).

Table 25.11 COEFFICIENTS FOR FILON'S QUADRATURE FORMULA

θ	α	β	γ
0.00	0.00000 000	0.66666 667	1.33333 333
0.01	0.00000 004	0.66668 000	1.33332 000
0.02	0.00000 036	0.66671 999	1.33328 000
0.03	0.00000 120	0.66678 664	1.33321 334
0.04	0.00000 284	0.66687 990	1.33312 001
0.05	0.00000 555	0.66699 976	1.33300 003
0.06	0.00000 961	0.66714 617	1.33285 340
0.07	0.00001 524	0.66731 909	1.33268 012
0.08	0.00002 274	0.66751 844	1.33248 020
0.09	0.00003 237	0.66774 417	1.33225 365
0.1	0.00004 438	0.66799 619	1.33200 048
0.2	0.00035 354	0.67193 927	1.32800 761
0.3	0.00118 467	0.67836 065	1.32137 184
0.4	0.00278 012	0.68703 909	1.31212 154
0.5	0.00536 042	0.69767 347	1.30029 624
0.6	0.00911 797	0.70989 111	1.28594 638
0.7	0.01421 151	0.72325 813	1.26913 302
0.8	0.02076 156	0.73729 136	1.24992 752
0.9	0.02884 683	0.75147 168	1.22841 118
1.0	0.03850 188	0.76525 831	1.20467 472

See 25.4.47.

26. Probability Functions

MARVIN ZELEN¹ AND NORMAN C. SEVERO²

Contents

	Page
Mathematical Properties	927
26.1. Probability Functions: Definitions and Properties	927
26.2. Normal or Gaussian Probability Function	931
26.3. Bivariate Normal Probability Function	936
26.4. Chi-Square Probability Function	940
26.5. Incomplete Beta Function	944
26.6. <i>F</i> -(Variance-Ratio) Distribution Function	946
26.7. Student's <i>t</i> -Distribution	948
Numerical Methods	949
26.8. Methods of Generating Random Numbers and Their Applications	949
26.9. Use and Extension of the Tables	953
References	961
Table 26.1. Normal Probability Function and Derivatives ($0 \leq x \leq 5$).	966
$P(x)$, $Z(x)$, $Z^{(1)}(x)$, 15D	
$Z^{(2)}(x)$, 10D; $Z^{(n)}(x)$, $n=3(1)6$, 8D	
$x=0(.02)3$	
$P(x)$, 10D; $Z(x)$, 10S; $Z^{(n)}(x)$, $n=1(1)6$, 8S	
$x=3(.05)5$	
Table 26.2. Normal Probability Function for Large Arguments ($5 \leq x \leq 500$)	972
$-\log Q(x)$, $x=5(1)50(10)100(50)500$, 5D	
Table 26.3. Higher Derivatives of the Normal Probability Function ($0 \leq x \leq 5$)	974
$Z^{(n)}(x)$, $n=7(1)12$, $x=0(.1)5$, 8S	
Table 26.4. Normal Probability Function—Values of $Z(x)$ in Terms of $P(x)$ and $Q(x)$	975
$Q(x)=0(.001).5$, 5D	
Table 26.5. Normal Probability Function—Values of x in Terms of $P(x)$ and $Q(x)$	976
$Q(x)=0(.001).5$, 5D	

¹ National Bureau of Standards. (Presently, National Institutes of Health.)

² National Bureau of Standards. (Presently, University of Buffalo.)

Table 26.6. Normal Probability Function—Values of x for Extreme Values of $P(x)$ and $Q(x)$	Page 977
$Q(x)=0(.0001).025, 5D$	
$Q(x)=10^{-m}, m=4(1)23, 5D$	
Table 26.7. Probability Integral of χ^2 -Distribution, Incomplete Gamma Function, Cumulative Sums of the Poisson Distribution	978
$\chi^2=.001(.001).01(.01).1(.1)2(.2)10(.5)20(1)40(2)76$	
$\nu=1(1)30, 5D$	
Table 26.8. Percentage Points of the χ^2 -Distribution—Values of χ^2 in Terms of Q and ν	984
$Q(\chi^2 \nu)=.995, .99, .975, .95, .9, .75, .5, .25, .1, .05, .025, .01, .005, .001, .0005, .0001$	
$\nu=1(1)30(10)100, 5-6S$	
Table 26.9. Percentage Points of the F -Distribution—Values of F in Terms of Q, ν_1, ν_2	986
$Q(F \nu_1, \nu_2)=.5, .25, .1, .05, .025, .01, .005, .001$	
$\nu_1=1(1)6, 8, 12, 15, 20, 30, 60, \infty$	
$\nu_2=1(1)30, 40, 60, 120, \infty, 3-5S$	
Table 26.10. Percentage Points of the t -Distribution—Values of t in Terms of A and ν	990
$A(t \nu)=.2, .5, .8, .9, .95, .98, .99, .995, .998, .999, .9999, .99999, .999999$	
$\nu=1(1)30, 40, 60, 120, \infty, 2D$	
Table 26.11. 2500 Five Digit Random Numbers	991

The authors gratefully acknowledge the assistance of David S. Liepman in the preparation and checking of the tables and graphs and the many helpful comments received from members of the Committee on Mathematical Tables of the Institute of Mathematical Statistics.

26. Probability Functions

Mathematical Properties³

26.1. Probability Functions: Definitions and Properties

Univariate Cumulative Distribution Functions

A real-valued function $F(x)$ is termed a (univariate) cumulative distribution function (c.d.f.) or simply distribution function if

- i) $F(x)$ is non-decreasing, i.e., $F(x_1) \leq F(x_2)$ for $x_1 \leq x_2$
- ii) $F(x)$ is everywhere continuous from the right, i.e., $F(x) = \lim_{\epsilon \rightarrow 0^+} F(x + \epsilon)$
- iii) $F(-\infty) = 0, F(\infty) = 1.$

The function $F(x)$ signifies the probability of the event " $X \leq x$ " where X is a random variable, i.e., $Pr\{X \leq x\} = F(x)$, and thus describes the c.d.f. of X . The two principal types of distribution functions are termed *discrete* and *continuous*.

Discrete Distributions: Discrete distributions are characterized by the random variable X taking on an enumerable number of values . . . , x_{-1}, x_0, x_1, \dots with point probabilities

$$p_n = Pr\{X = x_n\} \geq 0$$

which need only be subject to the restriction

$$\sum_n p_n = 1.$$

The corresponding distribution function can then be written

$$26.1.1 \quad F(x) = Pr\{X \leq x\} = \sum_{x_n \leq x} p_n$$

³ Comment on notation and conventions.

a. We follow the customary convention of denoting a random variable by a capital letter, i.e., X , and using the corresponding lower case letter, i.e., x , for a particular value that the random variable assumes.

b. For statistical applications it is often convenient to have tabulated the "upper tail area," $1 - F(x)$, or the c.d.f. for $|X|$, $F(x) - F(-x)$, instead of simply the c.d.f. $F(x)$. We use the notation P to indicate the c.d.f. of X , $Q = 1 - P$ to indicate the "upper tail area" and $A = P - Q$ to denote the c.d.f. of $|X|$. In particular we use $P(x)$, $Q(x)$, and $A(x)$ to denote the corresponding functions for the normal or Gaussian probability function, see 26.2.2-26.2.4. When these distributions depend on other parameters, say θ_1 and θ_2 , we indicate this by writing $P(x|\theta_1, \theta_2)$, $Q(x|\theta_1, \theta_2)$, or $A(x|\theta_1, \theta_2)$. For example the chi-square distribution 26.4 depends on the parameter ν and the tabulated function is written $Q(\chi^2|\nu)$.

*See page 11.

where the summation is over all values of x for which $x_n \leq x$. The set $\{x_n\}$ of values for which $p_n > 0$ is termed the domain of the random variable X . A discrete distribution of a random variable is called a *lattice distribution* if there exist numbers a and $b \neq 0$ such that every possible value of X can be represented in the form $a + bn$ where n takes on only integral values. A summary of some properties of certain discrete distributions is presented in 26.1.19-26.1.24.

Continuous Distributions. Continuous distributions are characterized by $F(x)$ being absolutely continuous. Hence $F(x)$ possesses a derivative $F'(x) = f(x)$ and the c.d.f. can be written

$$26.1.2 \quad F(x) = Pr\{X \leq x\} = \int_{-\infty}^x f(t) dt.$$

The derivative $f(x)$ is termed the *probability density function* (p.d.f.) or *frequency function*, and the values of x for which $f(x) > 0$ make up the domain of the random variable X . A summary of some properties of certain selected continuous distributions is presented in 26.1.25-26.1.34.

Multivariate Probability Functions

The real-valued function $F(x_1, x_2, \dots, x_n)$ defines an n -variate cumulative distribution function if

- i) $F(x_1, x_2, \dots, x_n)$ is a non-decreasing function for each x_i
- ii) $F(x_1, x_2, \dots, x_n)$ is continuous from the right in each x_i ; i.e., $F(x_1, x_2, \dots, x_n) = \lim_{\epsilon \rightarrow 0^+} F(x_1, \dots, x_i + \epsilon, \dots, x_n)$
- iii) $F(x_1, x_2, \dots, x_n) = 0$ when any $x_i = -\infty$; $F(\infty, \infty, \dots, \infty) = 1.$ *
- iv) $F(x_1, x_2, \dots, x_n)$ assigns nonnegative probability to the event $x_1 < X_1 \leq x_1 + h_1, x_2 < X_2 \leq x_2 + h_2, \dots, x_n < X_n \leq x_n + h_n$ for all x_1, x_2, \dots, x_n and all nonnegative h_1, h_2, \dots, h_n , e.g., for $n=2$, $F(x_1 + h_1, x_2 + h_2) - F(x_1, x_2 + h_2) - F(x_1 + h_1, x_2) + F(x_1, x_2) \geq 0$ and in general for $x_i < X_i \leq x_i + h_i$ ($i=1, 2, \dots, n$), the k th order difference $\Delta_k F(x_1, x_2, \dots, x_n) > 0$ for $k=1, 2, \dots, n$.

The joint probability of the event $X_1 \leq x_1, X_2 \leq x_2, \dots, X_n \leq x_n$ is $F(x_1, x_2, \dots, x_n)$. Analogous to the one-dimensional case, *discrete* distributions assign all probability to an enumerable set of vectors (x_1, x_2, \dots, x_n) and *continuous* distributions are characterized by absolute continuity of $F(x_1, x_2, \dots, x_n)$.

Characteristics of distribution functions: Moments, characteristic functions, cumulants

		Continuous distributions	Discrete distributions
26.1.3	n^{th} moment about origin	$\mu'_n = \int_{-\infty}^{\infty} x^n f(x) dx$	$\mu'_n = \sum_g x_g^n p_g$
26.1.4	mean	$m = \mu'_1 = \int_{-\infty}^{\infty} x f(x) dx$	$m = \mu'_1 = \sum_g x_g p_g$
26.1.5	variance	$\sigma^2 = \mu'_2 - m^2 = \int_{-\infty}^{\infty} (x-m)^2 f(x) dx$	$\sigma^2 = \mu'_2 - m^2 = \sum_g (x_g - m)^2 p_g$
26.1.6	n^{th} central moment	$\mu_n = \int_{-\infty}^{\infty} (x-m)^n f(x) dx$	$\mu_n = \sum_g (x_g - m)^n p_g$
26.1.7	expected value operator for the function $g(x)$	$E[g(X)] = \int_{-\infty}^{\infty} g(x) f(x) dx$	$E[g(X)] = \sum_g g(x_g) p_g$
26.1.8	characteristic function of X	$\phi(t) = E(e^{itX}) = \int_{-\infty}^{\infty} e^{itx} f(x) dx$	$\phi(t) = E(e^{itX}) = \sum_g e^{itx_g} p_g$
26.1.9	characteristic function of $g(X)$	$\phi_g(t) = E(e^{itg(X)}) = \int_{-\infty}^{\infty} e^{itg(x)} f(x) dx$	$\phi_g(t) = E(e^{itg(X)}) = \sum_g e^{itg(x_g)} p_g$
26.1.10	inversion formula	$f(x) = \frac{1}{2\pi} \int_{-\infty}^{\infty} e^{-itx} \phi(t) dt$	$p_n = \frac{b}{2\pi} \int_{-\pi/b}^{\pi/b} e^{-itx_n} \phi(t) dt$ (lattice distributions only)

Relation of the Characteristic Function to Moments About the Origin

26.1.11 $\phi^{(n)}(0) = \left[\frac{d^n}{dt^n} \phi(t) \right]_{t=0} = i^n \mu'_n$

Cumulant Function

26.1.12 $\ln \phi(t) = \sum_{n=0}^{\infty} \kappa_n \frac{(it)^n}{n!}$

κ_n is called the n^{th} cumulant.

26.1.13 $\kappa_1 = m, \kappa_2 = \sigma^2, \kappa_3 = \mu_3, \kappa_4 = \mu_4 - 3\mu_2^2$

Relation of Central Moments to Moments About the Origin

26.1.14 $\mu_n = \sum_{j=0}^n \binom{n}{j} (-1)^{n-j} \mu'_j m^{n-j}$

Coefficients of Skewness and Excess

26.1.15 $\gamma_1 = \frac{\kappa_3}{\kappa_2^{3/2}} = \frac{\mu_3}{\sigma^3}$ (skewness)

26.1.16 $\gamma_2 = \frac{\kappa_4}{\kappa_2^2} = \frac{\mu_4}{\sigma^4} - 3$ (excess)

Occasionally coefficients of skewness and excess (or kurtosis) are given by

26.1.17 $\beta_1 = \gamma_1^2 = \left(\frac{\mu_3}{\sigma^3} \right)^2$ (skewness)

26.1.18 $\beta_2 = \gamma_2 + 3 = \frac{\mu_4}{\sigma^4}$ (excess or kurtosis)

Some one-dimensional discrete distribution functions

Name	Domain	Point Probabilities	Restrictions on Parameters	Mean	Variance	Skewness γ_1	Excess γ_2	Characteristic function	Cumulants
26.1.19 Single point or degenerate	$x=c$ (c a constant)	$p=1$	$-\infty < c < +\infty$	c	0			e^{cx}	$\kappa_1 = \lambda, \kappa_r = 0$ for $r > 1$
26.1.20 Binomial	$x_r = r$, for $r=0, 1, 2, \dots, n$	$\binom{n}{r} p^r (1-p)^{n-r}$	$0 < p < 1$ ($q=1-p$)	np	npq	$\frac{q-p}{\sqrt{npq}}$	$\frac{1-6pq}{npq}$	$(q+pe^{it})^n$	$\kappa_1 = np$ $\kappa_{r+1} = pq \frac{d^r}{dp^r}$ for $r \geq 1$
26.1.21 Hypergeometric	$x_r = r$, for $r=0, 1, \dots, \min(n, N_1)$	$\frac{\binom{N_1}{r} \binom{N_2}{n-r}}{\binom{N_1+N_2}{n}}$	N_1 and N_2 integers, and $n \leq N_1 + N_2$ ($N=N_1+N_2$) $p=N_1/N$ and $q=1-p=N_2/N$	np	$npq \left(\frac{N-n}{N-1}\right)$	$\frac{q-p}{\sqrt{npq}} \left(\frac{N-1}{N-n}\right) \left(\frac{N-2n}{N-2}\right)$	Complicated	$\frac{\binom{N_1}{n}}{\binom{N}{n}} F(-n, -N; N_1; N_1 - n + 1; e^{it})$	Complicated
26.1.22 Poisson	$x_r = r$, for $r=0, 1, 2, \dots, \infty$	$\frac{e^{-m} m^r}{r!}$	$0 < m < \infty$	m	m	$m^{-\frac{1}{2}}$	m^{-1}	$e^m (e^{it}-1)$	$\kappa_r = m$ for $r=1, 2, \dots$
26.1.23 Negative binomial	$x_r = r$, for $r=0, 1, 2, \dots, \infty$	$\binom{n+r-1}{r} p^n (1-p)^r$	$n \geq 0$ and $0 < p < 1$ ($q=1-p$) and $1-p=p/Q$	n/p	n/pq	$\frac{q+p}{\sqrt{npq}}$	$\frac{1+6pQ}{n/pq}$	$(Q - Pe^{it})^{-n}$	$\kappa_1 = n/p$ $\kappa_{r+1} = PQ \frac{d^r}{dQ^r}$ for $r \geq 1$
26.1.24 Geometric	$x_r = r$, for $r=0, 1, 2, \dots, \infty$	$p(1-p)^r$	$0 < p < 1$	$\frac{1-p}{p}$	$\frac{1-p}{p^2}$	$\frac{2-p}{\sqrt{1-p}}$	$6 + \frac{p^2}{1-p}$	$p[1-(1-p)e^{it}]^{-1}$	$\kappa_1 = \frac{1-p}{p}$ $\kappa_{r+1} = -(1-p) \frac{d^r}{dp^r}$ $r \geq 1$

Some one-dimensional continuous distribution functions

	Name	Domain	Probability Density Function $f(x)$	Restrictions on Parameters	Mean	Variance	Skewness γ_1	Excess γ_2	Characteristic function	Cumulants
26.1.25	Error function	$-\infty < x < \infty$	$\frac{h}{\sqrt{\pi}} e^{-h^2 x^2}$	$0 < h < \infty$	0	$\frac{1}{2h^2}$	0	0	$\frac{-t^2}{e^{4h^2}}$	$\kappa_1=0, \kappa_2=\frac{1}{2h^2}$ $\kappa_n=0$ for $n>2$
26.1.26	Normal	$-\infty < x < \infty$	$\frac{1}{\sigma\sqrt{2\pi}} e^{-\frac{1}{2}\left(\frac{x-m}{\sigma}\right)^2}$	$-\infty < m < \infty$ $0 < \sigma < \infty$	m	σ^2	0	0	$e^{imt - \frac{\sigma^2 t^2}{2}}$	$\kappa_1=m, \kappa_2=\sigma^2, \kappa_n=0$ for $n>2$
26.1.27	Cauchy	$-\infty < x < \infty$	$\frac{1}{\pi\beta} \frac{1}{1+\left(\frac{x-\alpha}{\beta}\right)^2}$	$-\infty < \alpha < \infty$ $0 < \beta < \infty$	not defined	not defined	not defined	not defined	$e^{iat - \beta t }$	not defined
26.1.28	Exponential	$\alpha \leq x < \infty$	$\frac{1}{\beta} e^{-\left(\frac{x-\alpha}{\beta}\right)}$	$-\infty < \alpha < \infty$ $0 < \beta < \infty$	$\alpha + \beta$	β^2	2	6	$e^{iat}(1-i\beta t)^{-1}$	$\kappa_1=\alpha + \beta, \kappa_n = \beta^n \Gamma(n)$ for $n>1$
26.1.29	Laplace, or double exponential	$-\infty < x < \infty$	$\frac{1}{2\beta} e^{-\left \frac{x-\alpha}{\beta}\right }$	$-\infty < \alpha < \infty$ $0 < \beta < \infty$	α	$2\beta^2$	0	3	$e^{iat}(1+\beta^2 t^2)^{-1}$	$\kappa_1=\alpha, \kappa_2=2\beta^2$ $\kappa_{2n+1}=0, \kappa_{2n}=\frac{(2n)!}{n} \beta^{2n}$ for $n=1, 2, \dots$
26.1.30	Extreme-Value, ⁴ (Fisher-Tippett Type I or doubly exponential)	$-\infty < x < \infty$	$\frac{1}{\beta} \exp(-y - e^{-y})$ with $y = \frac{x-\alpha}{\beta}$	$-\infty < \alpha < \infty$ $0 < \beta < \infty$	$\alpha + \gamma\beta$	$\frac{(\pi\beta)^2}{6}$	1.3	2.4	$\Gamma(1-i\beta t) e^{iat}$	$\kappa_1=\gamma, \kappa_2=\frac{(\pi\beta)^2}{6}$ $\kappa_n = \beta^n \Gamma(n) \sum_{r=1}^{\infty} \frac{1}{r^n}$ for $n>2$
26.1.31	Pearson Type III	$\alpha \leq x < \infty$	$\frac{1}{\beta\Gamma(p)} y^{p-1} e^{-y}$ with $y = \frac{x-\alpha}{\beta}$	$-\infty < \alpha < \infty$ $0 < \beta < \infty$ $0 < p < \infty$	$\alpha + p\beta$	$p\beta^2$	$\frac{2}{\sqrt{p}}$	$6/p$	$e^{iat}(1-i\beta t)^{-p}$	$\kappa_1=\alpha + p\beta, \kappa_n = \beta^n p \Gamma(n)$ for $n>1$
26.1.32	Gamma distribution	$0 \leq x < \infty$	$\frac{1}{\Gamma(p)} x^{p-1} e^{-x}$	$0 < p < \infty$	p	p	$\frac{2}{\sqrt{p}}$	$6/p$	$(1-it)^{-p}$	$\kappa_1=p, \kappa_n = p \Gamma(n)$ for $n>1$
26.1.33	Beta distribution	$0 \leq x \leq 1$	$\frac{1}{B(a,b)} x^{a-1} (1-x)^{b-1}$	$1 \leq a < \infty$ $1 \leq b < \infty$	$\frac{a}{a+b}$	$\frac{ab}{(a+b)^2(a+b+1)}$	$\frac{2(a-b)}{(a+b+2)}$	See footnote 5.	$M(a, a+b, it)$	
26.1.34	Rectangular, or uniform	$m - \frac{h}{2} \leq x \leq m + \frac{h}{2}$	$\frac{1}{h}$	$-\infty < m < \infty$ $0 < h < \infty$	m	$\frac{h^2}{12}$	0	-1.2	$\frac{2}{ht} \sin\left(\frac{ht}{2}\right) e^{imt}$	$\kappa_1=m, \kappa_{2n+1}=0$ $\kappa_{2n} = \frac{h^{2n} B_{2n}}{2n}$ B_{2n} (Bernoulli numbers), $B_2 = \frac{1}{6}, B_4 = -\frac{1}{30}, \dots$

⁴ γ (Euler's constant) = .57721 56649

⁵ $\gamma_2 = \sqrt{\frac{a+b+1}{ab}} \left\{ \frac{3(a+b+1)[2(a+b)^2 + ab(a+b-6)]}{ab(a+b+2)(a+b+3)} - 3 \right\}$.

* See page II.

Inequalities for distribution functions

($F(x)$ denotes the c.d.f. of the random variable X and t denotes a positive constant; further m is always assumed to be finite and all expectations are assumed to exist.)

Inequality	Conditions
26.1.35 $Pr\{g(X) \geq t\} \leq E[g(X)]/t$	(i) $g(X) \geq 0$
26.1.36 $Pr\{X \geq t\} \leq m/t$ $F(t) \geq 1 - \frac{m}{t}$	(i) $Pr\{X < 0\} = 0$ (ii) $E(X) = m$
26.1.37 $Pr\{ X - m \geq t\} \leq 1/t^2$ $F(m+t\sigma) - F(m-t\sigma) \geq 1 - \frac{1}{t^2}$	(i) $E(X) = m$ (ii) $E(X - m)^2 = \sigma^2$ *
26.1.38 $Pr\{ \bar{X} - \bar{m} \geq t\sigma\} \leq \frac{1}{nt^2}$	(i) $E(X_i) = m_i$ (ii) $E(X_i - m_i)^2 = \sigma_i^2$ (iii) $E\{(X_i - m_i)(X_j - m_j)\} = 0 (i \neq j)$ (iv) $\bar{X} = \sum_{i=1}^n \frac{X_i}{n}$ $\bar{m} = \sum_{i=1}^n \frac{m_i}{n}, \bar{\sigma} = \left[\sum_{i=1}^n \frac{\sigma_i^2}{n} \right]^{1/2}$
26.1.39 $Pr\{ X - m \geq t\sigma\} \leq \frac{4}{9} \left\{ \frac{1 + \left(\frac{m-x_0}{\sigma}\right)^2}{\left(t - \left \frac{m-x_0}{\sigma}\right \right)^2} \right\}$ $F(m+t\sigma) - F(m-t\sigma) \geq 1 - \frac{4}{9} \left\{ \frac{1 + \left(\frac{m-x_0}{\sigma}\right)^2}{\left(t - \left \frac{m-x_0}{\sigma}\right \right)^2} \right\}$	(i) $E(X - m)^2 = \sigma^2$ (ii) $F(x)$ is a continuous c.d.f. (iii) $F(x)$ is unimodal at x_0^0
26.1.40 $Pr\{ X - m \geq t\sigma\} \leq 4/9t^2$ $F(m+t\sigma) - F(m-t\sigma) \geq 1 - \frac{4}{9t^2}$	(i) $E(X - m)^2 = \sigma^2$ (ii) $F(x)$ is a continuous c.d.f. (iii) $F(x)$ is unimodal at x_0^0 (iv) $m = x_0$
26.1.41 $Pr\{ X - m \geq t\sigma\} \leq \frac{\mu_4 - \sigma^4}{\mu_4 + t^4\sigma^4 - 2t^2\sigma^4}$ $F(m+t\sigma) - F(m-t\sigma) \geq 1 - \frac{\mu_4 - \sigma^4}{\mu_4 + t^4\sigma^4 - 2t^2\sigma^4}$	(i) $E(X - m)^2 = \sigma^2$ (ii) $E(X - m)^4 = \mu_4$

* x_0 is such that $F'(x_0) > F'(x)$ for $x \neq x_0$.

26.2. Normal or Gaussian Probability Function

- 26.2.1 $Z(x) = \frac{1}{\sqrt{2\pi}} e^{-x^2/2}$
- 26.2.2 $P(x) = \frac{1}{\sqrt{2\pi}} \int_{-\infty}^x e^{-t^2/2} dt = \int_{-\infty}^x Z(t) dt$
- 26.2.3 $Q(x) = \frac{1}{\sqrt{2\pi}} \int_x^{\infty} e^{-t^2/2} dt = \int_x^{\infty} Z(t) dt$
- 26.2.4 $A(x) = \frac{1}{\sqrt{2\pi}} \int_{-x}^x e^{-t^2/2} dt = \int_{-x}^x Z(t) dt$
- 26.2.5 $P(x) + Q(x) = 1$
- 26.2.6 $P(-x) = Q(x)$
- 26.2.7 $A(x) = 2P(x) - 1$

Probability Integral with Mean m and Variance σ^2

A random variable X is said to be normally distributed with mean m and variance σ^2 if the probability that X is less than or equal to x is given by

26.2.8

$$Pr\{X \leq x\} = \frac{1}{\sigma\sqrt{2\pi}} \int_{-\infty}^x e^{-\frac{(t-m)^2}{2\sigma^2}} dt$$

$$= \frac{1}{\sqrt{2\pi}} \int_{-\infty}^{(x-m)/\sigma} e^{-t^2/2} dt = P\left(\frac{x-m}{\sigma}\right).$$

The corresponding probability density function is

26.2.9

$$\frac{\partial}{\partial x} P\left(\frac{x-m}{\sigma}\right) = \frac{1}{\sigma} Z\left(\frac{x-m}{\sigma}\right) = \frac{1}{\sigma\sqrt{2\pi}} e^{-\frac{(x-m)^2}{2\sigma^2}}$$

and is symmetric around m , i.e.

$$Z\left(\frac{m+x}{\sigma}\right) = Z\left(\frac{m-x}{\sigma}\right).$$

The inflexion points of the probability density function are at $m \pm \sigma$.

*See page II.

Power Series ($x \geq 0$)

26.2.10
$$P(x) = \frac{1}{2} + \frac{1}{\sqrt{2\pi}} \sum_{n=0}^{\infty} \frac{(-1)^n x^{2n+1}}{n! 2^n (2n+1)}$$

26.2.11
$$P(x) = \frac{1}{2} + Z(x) \sum_{n=0}^{\infty} \frac{x^{2n+1}}{1 \cdot 3 \cdot 5 \dots (2n+1)}$$

Asymptotic Expansions ($x > 0$)

26.2.12
$$Q(x) = \frac{Z(x)}{x} \left\{ 1 - \frac{1}{x^2} + \frac{1 \cdot 3}{x^4} + \dots + \frac{(-1)^{n+1} \cdot 3 \cdot \dots \cdot (2n-1)}{x^{2n}} \right\} + R_n$$

where

$$R_n = (-1)^{n+1} \cdot 3 \cdot \dots \cdot (2n+1) \int_x^{\infty} \frac{Z(t)}{t^{2n+2}} dt$$

which is less in absolute value than the first neglected term.

26.2.13

$$Q(x) \sim \frac{Z(x)}{x} \left\{ 1 - \frac{a_1}{x^2+2} + \frac{a_2}{(x^2+2)(x^2+4)} - \frac{a_3}{(x^2+2)(x^2+4)(x^2+6)} + \dots \right\}$$

where $a_1=1, a_2=1, a_3=5, a_4=9, a_5=129$ and the general term is

$$a_n = c_0 \cdot 1 \cdot 3 \cdot \dots \cdot (2n-1) + 2c_1 \cdot 1 \cdot 3 \cdot \dots \cdot (2n-3) + 2^2 c_2 \cdot 1 \cdot 3 \cdot \dots \cdot (2n-5) + \dots + 2^{n-1} c_{n-1}$$

and c_s is the coefficient of t^{n-s} in the expansion of $t(t-1) \dots (t-n+1)$.

Continued Fraction Expansions

26.2.14
$$Q(x) = Z(x) \left\{ \frac{1}{x+} \frac{1}{x+} \frac{2}{x+} \frac{3}{x+} \frac{4}{x+} \dots \right\} \quad (x > 0)$$

26.2.15
$$Q(x) = \frac{1}{2} - Z(x) \left\{ \frac{x}{1-} \frac{x^2}{3+} \frac{2x^2}{5-} \frac{3x^2}{7+} \frac{4x^2}{9-} \dots \right\} \quad (x \geq 0)$$

Polynomial and Rational Approximations⁷ for $P(x)$ and $Z(x)$

$$0 \leq x < \infty$$

26.2.16

$$P(x) = 1 - Z(x)(a_1 t + a_2 t^2 + a_3 t^3) + \epsilon(x), \quad t = \frac{1}{1+px}$$

$$|\epsilon(x)| < 1 \times 10^{-5}$$

$$p = .33267 \quad a_1 = .43618 \ 36$$

$$a_2 = -.12016 \ 76$$

$$a_3 = .93729 \ 80$$

26.2.17

$$P(x) = 1 - Z(x)(b_1 t + b_2 t^2 + b_3 t^3 + b_4 t^4 + b_5 t^5) + \epsilon(x), \quad t = \frac{1}{1+px}$$

$$|\epsilon(x)| < 7.5 \times 10^{-8}$$

$$p = .23164 \ 19$$

$$b_1 = .31938 \ 1530 \quad b_4 = -1.82125 \ 5978$$

$$b_2 = -.35656 \ 3782 \quad b_5 = 1.33027 \ 4429$$

$$b_3 = 1.78147 \ 7937$$

26.2.18

$$P(x) = 1 - \frac{1}{2} (1 + c_1 x + c_2 x^2 + c_3 x^3 + c_4 x^4)^{-4} + \epsilon(x)$$

$$|\epsilon(x)| < 2.5 \times 10^{-4}$$

$$c_1 = .196854 \quad c_3 = .000344$$

$$c_2 = .115194 \quad c_4 = .019527$$

26.2.19

$$P(x) = 1 - \frac{1}{2} (1 + d_1 x + d_2 x^2 + d_3 x^3 + d_4 x^4 + d_5 x^5 + d_6 x^6)^{-16} + \epsilon(x)$$

$$|\epsilon(x)| < 1.5 \times 10^{-7}$$

$$d_1 = .04986 \ 73470 \quad d_4 = .00003 \ 80036$$

$$d_2 = .02114 \ 10061 \quad d_5 = .00004 \ 88906$$

$$d_3 = .00327 \ 76263 \quad d_6 = .00000 \ 53830$$

26.2.20
$$Z(x) = (a_0 + a_2 x^2 + a_4 x^4 + a_6 x^6)^{-1} + \epsilon(x)$$

$$|\epsilon(x)| < 2.7 \times 10^{-3}$$

$$a_0 = 2.490895 \quad a_4 = -.024393$$

$$a_2 = 1.466003 \quad a_6 = .178257$$

⁷ Based on approximations in C. Hastings, Jr., Approximations for digital computers. Princeton Univ. Press, Princeton, N.J., 1955 (with permission).

26.2.21

$$Z(x) = (b_0 + b_2x^2 + b_4x^4 + b_6x^6 + b_8x^8 + b_{10}x^{10})^{-1} + \epsilon(x)$$

$$|\epsilon(x)| < 2.3 \times 10^{-4}$$

$$\begin{aligned} b_0 &= 2.50523 \ 67 & b_6 &= .13064 \ 69 \\ b_2 &= 1.28312 \ 04 & b_8 &= -.02024 \ 90 \\ b_4 &= .22647 \ 18 & b_{10} &= .00391 \ 32 \end{aligned}$$

Rational Approximations for x_p where $Q(x_p) = p$

$$0 < p \leq .5$$

26.2.22

$$x_p = t - \frac{a_0 + a_1 t}{1 + b_1 t + b_2 t^2} + \epsilon(p), \quad t = \sqrt{\ln \frac{1}{p}}$$

$$|\epsilon(p)| < 3 \times 10^{-3}$$

$$\begin{aligned} a_0 &= 2.30753 & b_1 &= .99229 \\ a_1 &= .27061 & b_2 &= .04481 \end{aligned}$$

26.2.23

$$x_p = t - \frac{c_0 + c_1 t + c_2 t^2}{1 + d_1 t + d_2 t^2 + d_3 t^3} + \epsilon(p), \quad t = \sqrt{\ln \frac{1}{p}}$$

$$|\epsilon(p)| < 4.5 \times 10^{-4}$$

$$\begin{aligned} c_0 &= 2.515517 & d_1 &= 1.432788 \\ c_1 &= .802853 & d_2 &= .189269 \\ c_2 &= .010328 & d_3 &= .001308 \end{aligned}$$

Bounds Useful as Approximations to the Normal Distribution Function

26.2.24

$$P(x) \leq \begin{cases} P_1(x) = \frac{1}{2} + \frac{1}{2} (1 - e^{-2x^2/\pi})^{\frac{1}{2}} & (x > 0) \\ P_2(x) = 1 - \frac{(4+x^2)^{\frac{1}{2}} - x}{2} (2\pi)^{-\frac{1}{2}} e^{-x^2/2} & (x > 1.4) \end{cases}$$

26.2.25

$$P(x) \geq \begin{cases} P_3(x) = \frac{1}{2} + \frac{1}{2} \left(1 - e^{-2x^2/\pi} - \frac{2(\pi-3)}{3\pi^2} x^4 e^{-x^2/2} \right)^{\frac{1}{2}} & (x > 0) \\ P_4(x) = 1 - \frac{1}{x} (2\pi)^{-\frac{1}{2}} e^{-x^2/2} & (x > 2.2) \end{cases}$$

See Figure 26.1 for error curves.

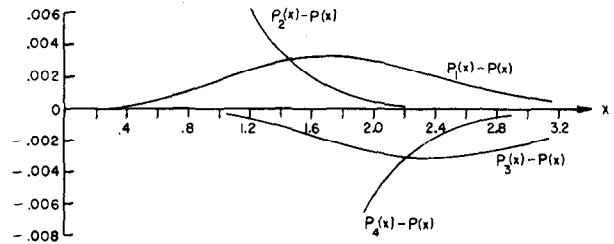

FIGURE 26.1. Error curves for bounds on normal distribution.

Derivatives of the Normal Probability Density Function

26.2.26 $Z^{(m)}(x) = \frac{d^m}{dx^m} Z(x)$

Differential Equation

26.2.27 $Z^{(m+2)}(x) + xZ^{(m+1)}(x) + (m+1)Z^{(m)}(x) = 0$

Value at $x=0$

26.2.28

$$Z^{(m)}(0) = \begin{cases} \frac{(-1)^{m/2} m!}{\sqrt{2\pi} 2^{m/2} \left(\frac{m}{2}\right)!} & \text{for } m=2r, r=0, 1, \dots \\ 0 & \text{for odd } m > 0 \end{cases}$$

Relation of $P(x)$ and $Z^{(m)}(x)$ to Other Functions

<i>Function</i>	<i>Relation</i>	
26.2.29 Error function	$\operatorname{erf} x = 2P(x\sqrt{2}) - 1$	$(x \geq 0)$
26.2.30 Incomplete gamma function (special case)	$\frac{\gamma\left(\frac{1}{2}, x\right)}{\Gamma\left(\frac{1}{2}\right)} = [2P(\sqrt{2x}) - 1]$	$(x \geq 0)$
26.2.31 Hermite polynomial	$He_n(x) = (-1)^n \frac{Z^{(n)}(x)}{Z(x)}$	
26.2.32 “	$H_n(x) = (-1)^{n/2} \frac{Z^{(n)}(x\sqrt{2})}{Z(x\sqrt{2})}$	
26.2.33 <i>Hh</i> function	$Hh_{-n}(x) = (-1)^{n-1} \sqrt{2\pi} Z^{(n-1)}(x)$	$(n > 0)$
26.2.34 “	$Hh_n(x) = \frac{(-1)^n}{n!} Hh_{-1}(x) \frac{d^n}{dx^n} \left(\frac{Q(x)}{Z(x)} \right)$	$(n > 0)$
26.2.35 Tetrachoric function	$\tau_n(x) = \frac{(-1)^{n-1}}{\sqrt{n!}} Z^{(n-1)}(x)$	
26.2.36 Confluent hypergeometric function (special case)	$M\left(\frac{1}{2}, \frac{3}{2}, -\frac{x^2}{2}\right) = \frac{\sqrt{2\pi}}{x} \left\{ P(x) - \frac{1}{2} \right\}$	$(x > 0)$
26.2.37 “	$M\left(1, \frac{3}{2}, \frac{x^2}{2}\right) = \frac{1}{xZ(x)} \left\{ P(x) - \frac{1}{2} \right\}$	$(x > 0)$
26.2.38 “	$M\left(\frac{2m+1}{2}, \frac{1}{2}, -\frac{x^2}{2}\right) = \frac{Z^{(2m)}(x)}{Z^{(2m)}(0)}$	$(x \geq 0)$
26.2.39 “	$M\left(\frac{2m+2}{2}, \frac{3}{2}, -\frac{x^2}{2}\right) = \frac{Z^{(2m-1)}(x)}{xZ^{(2m)}(0)}$	$(x \geq 0)$
26.2.40 Parabolic cylinder function	$U\left(-n - \frac{1}{2}, x\right) = e^{-\frac{1}{2}x^2} (-1)^n \frac{Z^{(n)}(x)}{Z(x)}$	$(n > 0)$

Repeated Integrals of the Normal Probability Integral

$$26.2.41 \quad I_n(x) = \int_x^\infty I_{n-1}(t) dt \quad (n \geq 0)$$

$$\text{where } I_{-1}(x) = Z(x)$$

26.2.42

$$I_{-n}(x) = \left(-\frac{d}{dx}\right)^{n-1} Z(x) = (-1)^{n-1} Z^{(n-1)}(x) \quad (n \geq -1)$$

$$26.2.43 \quad \left(\frac{d^2}{dx^2} + x \frac{dx}{dn} - n\right) I_n(x) = 0$$

26.2.44

$$(n+1)I_{n+1}(x) + xI_n(x) - I_{n-1}(x) = 0 \quad (n > -1)$$

26.2.45

$$I_n(x) = \int_x^\infty \frac{(t-x)^n}{n!} Z(t) dt = e^{-x^2/2} \int_0^\infty \frac{t^n}{n!} Z(t) dt \quad (n > -1)$$

26.2.46 $I_n(0) = I_{-n}(0) = \frac{1}{\left(\frac{n}{2}\right)! 2^{\frac{n+2}{2}}} \quad (n \text{ even})$

Asymptotic Expansions of an Arbitrary Probability Density Function and Distribution Function

Let $Y_i (i=1, 2, \dots, n)$ be n

independent random variables with mean m_i , variance σ_i^2 , and higher cumulants $\kappa_{r,i}$. Then asymptotic expansions with respect to n for the probability density and cumulative distribution function of

$$X = \frac{\sum_{i=1}^m (Y_i - m_i)}{\left(\sum_{i=1}^m \sigma_i^2\right)^{1/2}} \text{ are}$$

26.2.47

$$f(x) \sim Z(x) - \left[\frac{\gamma_1}{6} Z^{(3)}(x)\right] + \left[\frac{\gamma_2}{24} Z^{(4)}(x) + \frac{\gamma_1^2}{72} Z^{(6)}(x)\right] - \left[\frac{\gamma_3}{120} Z^{(5)}(x) + \frac{\gamma_1\gamma_2}{144} Z^{(7)}(x) + \frac{\gamma_1^3}{1296} Z^{(9)}(x)\right] + \left[\frac{\gamma_4}{720} Z^{(6)}(x) + \frac{\gamma_2^2}{1152} Z^{(8)}(x) + \frac{\gamma_1\gamma_3}{720} Z^{(8)}(x) + \frac{\gamma_1^2\gamma_2}{1728} Z^{(10)}(x) + \frac{\gamma_1^4}{31104} Z^{(12)}(x)\right] + \dots$$

26.2.48

$$F(x) \sim P(x) - \left[\frac{\gamma_1}{6} Z^{(2)}(x)\right] + \left[\frac{\gamma_2}{24} Z^{(3)}(x) + \frac{\gamma_1^2}{72} Z^{(5)}(x)\right] - \left[\frac{\gamma_3}{120} Z^{(4)}(x) + \frac{\gamma_1\gamma_2}{144} Z^{(6)}(x) + \frac{\gamma_1^3}{1296} Z^{(8)}(x)\right] + \left[\frac{\gamma_4}{720} Z^{(5)}(x) + \frac{\gamma_2^2}{1152} Z^{(7)}(x) + \frac{\gamma_1\gamma_3}{720} Z^{(7)}(x) + \frac{\gamma_1^2\gamma_2}{1728} Z^{(9)}(x) + \frac{\gamma_1^4}{31104} Z^{(11)}(x)\right] + \dots$$

where

$$\gamma_{r-2} = \frac{1}{n^{\frac{r}{2}-1}} \frac{\left(\frac{1}{n} \sum_{i=1}^n \kappa_{r,i}\right)}{\left(\frac{1}{n} \sum_{i=1}^n \sigma_i^2\right)^{r/2}}$$

Terms in brackets are terms of the same order with respect to n . When the Y_i have the same distribution, then $m_i = m$, $\sigma_i^2 = \sigma^2$, $\kappa_{r,i} = \kappa_r$ and

$$\gamma_{r-2} = \frac{1}{n^{\frac{r}{2}-1}} \left(\frac{\kappa_r}{\sigma^r}\right)$$

Asymptotic Expansion for the Inverse Function of an Arbitrary Distribution Function

Let the cumulative distribution function of $Y = \sum_{i=1}^n Y_i$ be denoted by $F(y)$. Then the (Cornish-Fisher) asymptotic expansion with respect to n for the value of y_p such that $F(y_p) = 1-p$ is

26.2.49 $y_p \sim m + \sigma w$

where

$$w = x + [\gamma_1 h_1(x)] + [\gamma_2 h_2(x) + \gamma_1^2 h_{11}(x)] + [\gamma_3 h_3(x) + \gamma_1\gamma_2 h_{12}(x) + \gamma_1^3 h_{111}(x)] + [\gamma_4 h_4(x) + \gamma_2^2 h_{22}(x) + \gamma_1\gamma_3 h_{13}(x) + \gamma_1^2\gamma_2 h_{112}(x) + \gamma_1^4 h_{1111}(x)] + \dots$$

and

$$Q(x) = p, \quad \gamma_{r-2} = \frac{\kappa_r}{\kappa_2^{r/2}}, \quad r = 3, 4, \dots$$

26.2.50

$$h_1(x) = \frac{1}{6} He_2(x)$$

$$h_2(x) = \frac{1}{24} He_3(x)$$

$$h_{11}(x) = -\frac{1}{36} [2He_3(x) + He_1(x)]$$

$$h_3(x) = \frac{1}{120} [He_4(x)]$$

$$h_{12}(x) = -\frac{1}{24} [He_4(x) + He_2(x)]$$

$$h_{111}(x) = \frac{1}{324} [12He_4(x) + 19He_2(x)]$$

$$h_4(x) = \frac{1}{720} He_5(x)$$

$$h_{22}(x) = -\frac{1}{384} [3He_5(x) + 6He_3(x) + 2He_1(x)]$$

$$h_{13}(x) = -\frac{1}{180} [2He_5(x) + 3He_3(x)]$$

$$h_{112}(x) = \frac{1}{288} [14He_5(x) + 37He_3(x) + 8He_1(x)]$$

$$h_{1111}(x) = -\frac{1}{7776} [252He_5(x) + 832He_3(x) + 227He_1(x)]$$

Terms in brackets in 26.2.49 are terms of the same order with respect to n . The $He_n(x)$ are the Hermite polynomials. (See chapter 22.)

26.2.51
$$He_n(x) = (-1)^n \frac{Z^{(n)}(x)}{Z(x)} = n! \sum_{m=0}^{\lfloor \frac{n}{2} \rfloor} \frac{(-1)^m}{2^m m! (n-2m)!} x^{n-2m}$$

In the following auxiliary table, the polynomial functions $h_1(x), h_2(x) \dots h_{1111}(x)$ are tabulated for

$\rho = .25, .1, .05, .025, .01, .005, .0025, .001, .0005.$

Auxiliary coefficients⁸ for use with Cornish-Fisher asymptotic expansion. 26.2.49

	ρ									
	.25	.10	.05	.025	.01	.005	.0025	.001	.0005	
x	.67449	1.28155	1.64485	1.95996	2.32635	2.57583	2.80703	3.09022	3.29053	
$h_1(x)$	-.09084	-.10706	-.28426	-.47358	-.73532	-.93915	1.14657	1.42491	1.63793	
$h_2(x)$	-.07153	-.07249	-.02018	-.06872	-.23379	-.39012	-.57070	-.84331	-1.07320	
$h_{11}(x)$.07663	.06106	-.01878	-.14607	-.37634	-.59171	-.83890	-1.21025	-1.52234	
$h_3(x)$.00398	-.03464	-.04928	-.04410	-.00152	-.06010	-.14841	-.30746	-.46059	
$h_{12}(x)$.00282	.14644	-.17532	-.10210	-.17621	-.53531	-1.02868	-1.89355	-2.71243	
$h_{111}(x)$	-.01428	-.11900	-.11900	-.02937	-.25195	-.59757	-.66301	1.86787	2.62337	
$h_4(x)$.00998	.00227	-.01082	-.02357	-.03176	-.02621	-.00666	-.04591	.10950	
$h_{22}(x)$	-.03285	.00776	.05985	.09659	.07888	-.01226	-.59060	-.19116	-1.03555	
$h_{112}(x)$	-.05126	.01086	.09462	.16106	.16058	.05366	-.17498	-.70464	-1.30531	
$h_{1111}(x)$.14764	-.10858	-.39517	-.55856	-.32821	.35696	1.60445	4.29304	7.23307	
$h_{11111}(x)$	-.06898	.09585	.25623	.31624	.07286	-.46534	-1.39199	-3.32708	-5.40702	

⁸ From R. A. Fisher, Contributions to mathematical statistics, Paper 30 (with E. A. Cornish) Extrait de la Revue de l'Institut International de Statistique 4, 1-14 (1937) (with permission).

26.3. Bivariate Normal Probability Function

26.3.1

$$g(x, y, \rho) = [2\pi\sqrt{1-\rho^2}]^{-1} \exp\left\{-\frac{1}{2} \left(\frac{x^2 - 2\rho xy + y^2}{1-\rho^2} \right)\right\}$$

26.3.2
$$g(x, y, \rho) = (1-\rho^2)^{-1/2} Z(x) Z\left(\frac{y-\rho x}{\sqrt{1-\rho^2}}\right)$$

26.3.3

$$L(h, k, \rho) = \int_h^\infty dx \int_k^\infty g(x, y, \rho) dy$$

$$= \int_h^\infty Z(x) dx \int_w^\infty Z(w) dw, \quad w = \left(\frac{k-\rho x}{\sqrt{1-\rho^2}} \right)$$

26.3.4
$$L(-h, -k, \rho) = \int_{-\infty}^h dx \int_{-\infty}^k g(x, y, \rho) dy$$

26.3.5
$$L(-h, k, -\rho) = \int_{-\infty}^h dx \int_k^\infty g(x, y, \rho) dy$$

26.3.6
$$L(h, -k, -\rho) = \int_h^\infty dx \int_{-\infty}^k g(x, y, \rho) dy$$

26.3.7
$$L(h, k, \rho) = L(k, h, \rho)$$

26.3.8
$$L(-h, k, \rho) + L(h, k, -\rho) = Q(k)$$

26.3.9
$$L(-h, -k, \rho) - L(h, k, \rho) = P(k) - Q(h)$$

26.3.10

*
$$2[L(h, k, \rho) + L(h, k, -\rho) + P(h) - Q(k)] - 1$$

$$= \int_{-h}^h dx \int_{-k}^k g(x, y, \rho) dy$$

Probability Function With Means m_x, m_y , Variances σ_x^2, σ_y^2 , and Correlation ρ

The random variables X, Y are said to be distributed as a bivariate Normal distribution with

^{*} See page 11.

means and variances (m_x, m_y) and (σ_x^2, σ_y^2) and correlation ρ if the joint probability that X is less than or equal to h and Y less than or equal to k is given by

26.3.11

$$Pr\{X \leq h, Y \leq k\} = \frac{1}{\sigma_x \sigma_y} \int_{-\infty}^{\frac{h-m_x}{\sigma_x}} \int_{-\infty}^{\frac{k-m_y}{\sigma_y}} g(s, t, \rho) ds dt$$

$$= L\left(-\left(\frac{h-m_x}{\sigma_x}\right), -\left(\frac{k-m_y}{\sigma_y}\right), \rho\right)$$

The probability density function is

26.3.12

$$\frac{1}{2\pi\sigma_x\sigma_y\sqrt{1-\rho^2}} \exp\left\{-\frac{Q}{2(1-\rho^2)}\right\} = \frac{1}{\sigma_x\sigma_y} g\left(\frac{x-m_x}{\sigma_x}, \frac{y-m_y}{\sigma_y}, \rho\right)$$

where

$$Q = \frac{(x-m_x)^2}{\sigma_x^2} - \frac{2\rho(x-m_x)(y-m_y)}{\sigma_x\sigma_y} + \frac{(y-m_y)^2}{\sigma_y^2}$$

Circular Normal Probability Density Function

26.3.13

$$\frac{1}{\sigma^2} g\left(\frac{x-m_x}{\sigma}, \frac{y-m_y}{\sigma}, 0\right) =$$

$$\frac{1}{2\pi\sigma^2} \exp\left\{-\frac{(x-m_x)^2 + (y-m_y)^2}{2\sigma^2}\right\}$$

NEW

Special Values of $L(h, k, \rho)$

- 26.3.14 $L(h, k, 0) = Q(h)Q(k)$
- 26.3.15 $L(h, k, -1) = 0 \quad (h+k \geq 0)$
- 26.3.16 $L(h, k, -1) = P(h) - Q(k) \quad (h+k \leq 0)$
- 26.3.17 $L(h, k, 1) = Q(h) \quad (k \leq h)$
- 26.3.18 $L(h, k, 1) = Q(k) \quad (k \geq h)$
- 26.3.19 $L(0, 0, \rho) = \frac{1}{4} + \frac{\arcsin \rho}{2\pi}$

$L(h, k, \rho)$ as a Function of $L(h, 0, \rho)$

26.3.20

$$L(h, k, \rho) = L\left(h, 0, \frac{(\rho h - k)(\operatorname{sgn} h)}{\sqrt{h^2 - 2\rho h k + k^2}}\right) + L\left(k, 0, \frac{(\rho k - h)(\operatorname{sgn} k)}{\sqrt{h^2 - 2\rho h k + k^2}}\right) - \begin{cases} 0 & \text{if } hk > 0 \text{ or } hk = 0 \\ & \text{and } h+k \geq 0 \\ \frac{1}{2} & \text{otherwise} \end{cases}$$

where $\operatorname{sgn} h = 1$ if $h \geq 0$ and $\operatorname{sgn} h = -1$ if $h < 0$.

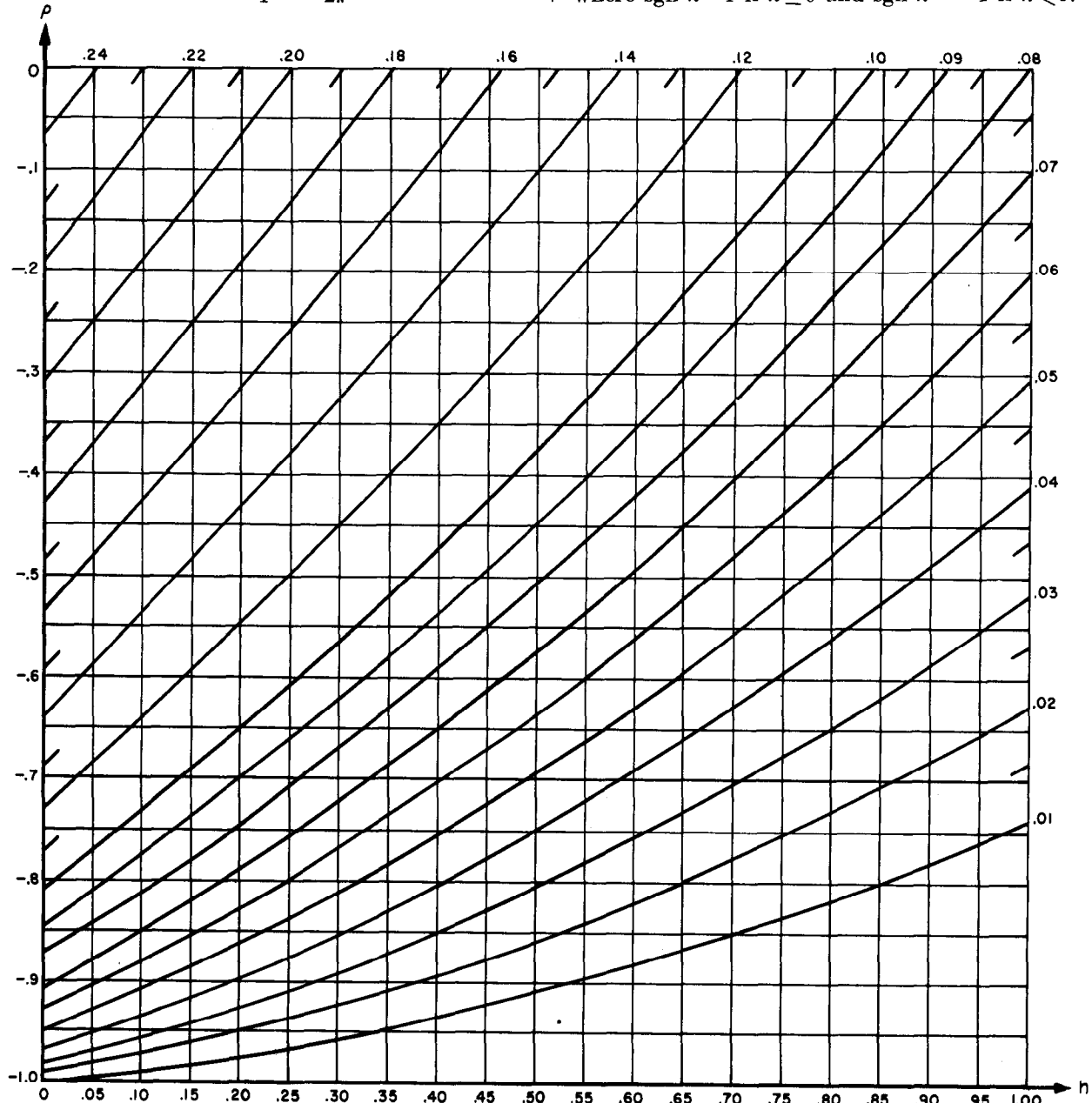

FIGURE 26.2. $L(h, 0, \rho)$ for $0 \leq h \leq 1$ and $-1 \leq \rho \leq 0$.

Values for $h < 0$ can be obtained using $L(h, 0, -\rho) = \frac{1}{2} - L(-h, 0, \rho)$.

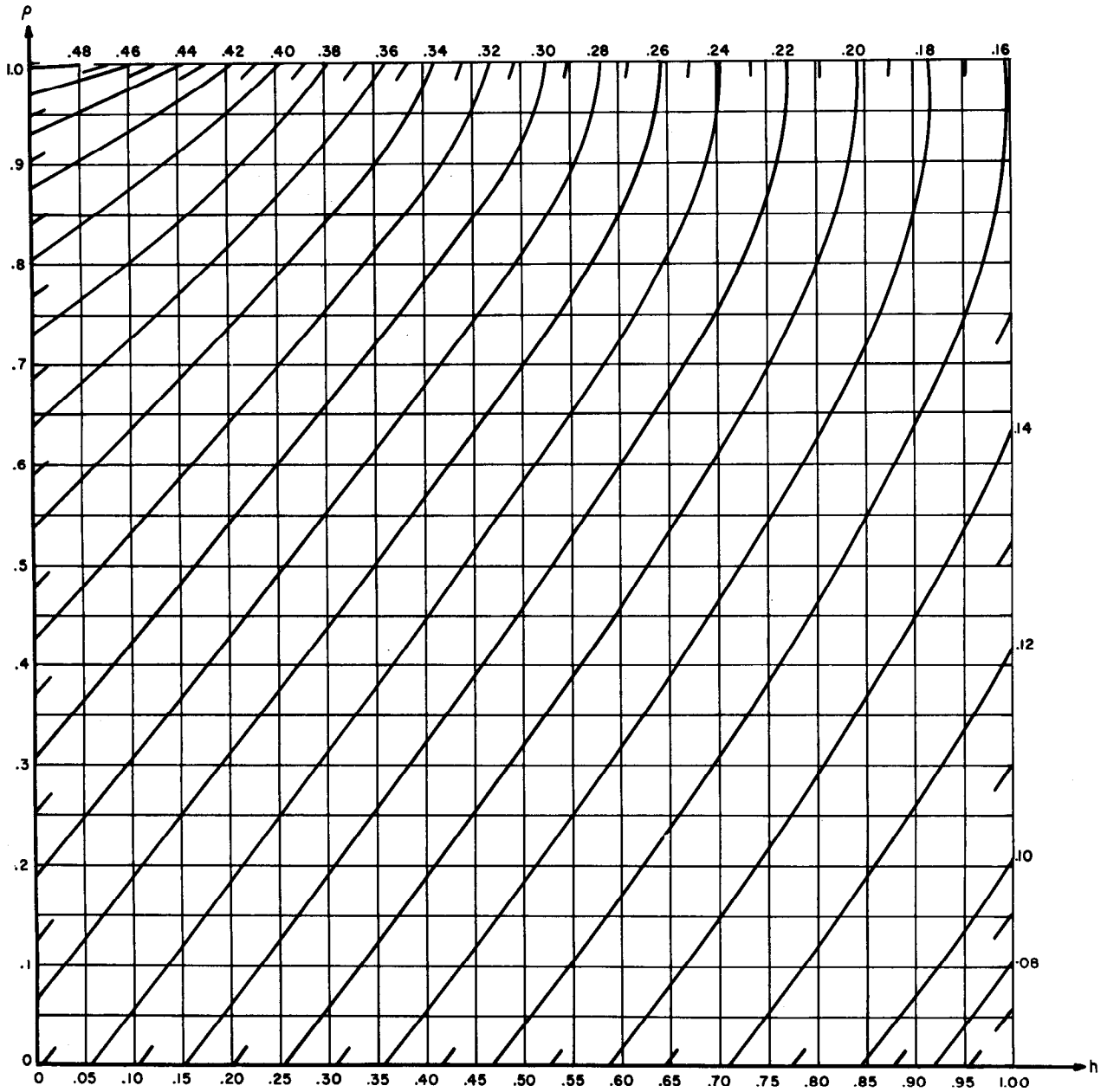

FIGURE 26.3. $L(h, 0, \rho)$ for $0 \leq h \leq 1$ and $0 \leq \rho \leq 1$.

Values for $h < 0$ can be obtained using $L(h, 0, -\rho) = \frac{1}{2} - L(-h, 0, \rho)$.

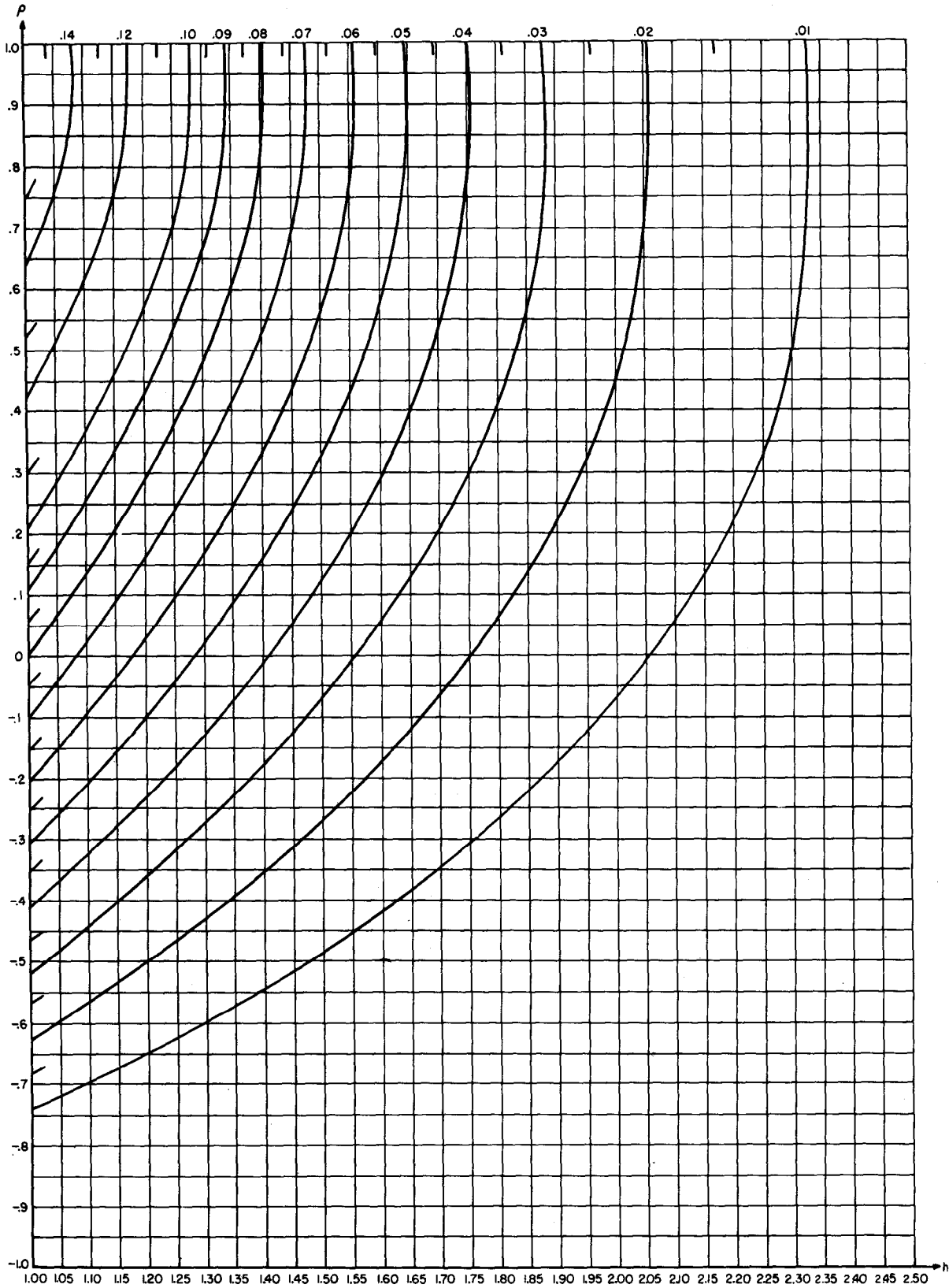

FIGURE 26.4. $L(h, 0, \rho)$ for $h \geq 1$ and $-1 \leq \rho \leq 1$.

Values for $h < 0$ can be obtained using $L(h, 0, -\rho) = \frac{1}{2} - L(-h, 0, \rho)$

Integral Over an Ellipse With Center at (m_x, m_y)

26.3.21

$$\iint_A (\sigma_x \sigma_y)^{-1} g\left(\frac{x-m_x}{\sigma_x}, \frac{y-m_y}{\sigma_y}, \rho\right) dx dy = 1 - e^{-a^2/2}$$

where A is the area enclosed by the ellipse

$$\left(\frac{x-m_x}{\sigma_x}\right)^2 - \frac{2\rho(x-m_x)(y-m_y)}{\sigma_x \sigma_y} + \left(\frac{y-m_y}{\sigma_y}\right)^2 = a^2(1-\rho^2)$$

Integral Over an Arbitrary Region

26.3.22

$$\iint_{A(x,y)} (\sigma_x \sigma_y)^{-1} g\left(\frac{x-m_x}{\sigma_x}, \frac{y-m_y}{\sigma_y}, \rho\right) dx dy = \iint_{A^*(s,t)} g(s, t, \rho) ds dt$$

where $A^*(s, t)$ is the transformed region obtained from the transformation

$$s = \frac{1}{\sqrt{2+2\rho}} \left(\frac{x-m_x}{\sigma_x} + \frac{y-m_y}{\sigma_y}\right)$$

$$t = \frac{-1}{\sqrt{2-2\rho}} \left(\frac{x-m_x}{\sigma_x} - \frac{y-m_y}{\sigma_y}\right)$$

Integral of the Circular Normal Probability Function With Parameters $m_x=m_y=0, \sigma=1$ Over the Triangle Bounded by $y=0, y=ax, x=h$

26.3.23

$$V(h, ah) = \frac{1}{2\pi} \int_0^h \int_0^{ax} e^{-\frac{1}{2}(x^2+y^2)} dx dy$$

$$= \frac{1}{4} + L(h, 0, \rho) - L(0, 0, \rho) - \frac{1}{2} Q(h)$$

where

$$\rho = -\frac{a}{\sqrt{1+a^2}}$$

Integral of Circular Normal Distribution Over an Offset Circle With Radius $R\sigma$ and Center a Distance $r\sigma$ From (m_x, m_y)

26.3.24

$$\int_A \int \sigma^{-2} g\left(\frac{x-m_x}{\sigma}, \frac{y-m_y}{\sigma}, 0\right) dx dy = P(R^2|2, r^2)$$

where $P(R^2|2, r^2)$ is the c.d.f. of the non-central χ^2 distribution (see 26.4.25) with $\nu=2$ degrees of freedom and noncentrality parameter r^2 .

Approximation to $P(R^2|2, r^2)$

26.3.25

Approximation	Condition
$\frac{2R^2}{4+R^2} \exp\left(-\frac{2r^2}{4+R^2}\right)$	$R < 1$

26.3.26 $P(x_1)$

$R > 1$

26.3.27 $P(x_2)$

$R > 5$

$$x_1 = \frac{[R^2/(2+r^2)]^{1/3} - \left[1 - \frac{2}{9} \frac{2+2r^2}{(2+r^2)^2}\right]}{\left[\frac{2}{9} \frac{2+2r^2}{(2+r^2)^2}\right]^{1/2}}$$

$$x_2 = R - \sqrt{r^2 - 1} \quad R, r \text{ both large} \quad *$$

Inequality

26.3.28

$$Q(h) - \frac{1-\rho^2}{\rho h - k} Z(k) \left[Q\left(\frac{h-\rho k}{\sqrt{1-\rho^2}}\right) \right] < L(h, k, \rho) < Q(h)$$

where

$$\rho h - k > 0, \quad 0 < \rho < 1.$$

Series Expansion

26.3.29

$$L(h, k, \rho) = Q(h)Q(k) + \sum_{n=0}^{\infty} \frac{Z^{(n)}(h)Z^{(n)}(k)}{(n+1)!} \rho^{n+1}$$

26.4. Chi-Square Probability Function

26.4.1

$$P(\chi^2|\nu) = \left[2^{\nu/2} \Gamma\left(\frac{\nu}{2}\right)\right]^{-1} \int_0^{\chi^2} (t)^{\frac{\nu}{2}-1} e^{-\frac{t}{2}} dt \quad (0 \leq \chi^2 < \infty)$$

26.4.2

$$Q(\chi^2|\nu) = 1 - P(\chi^2|\nu) = \left[2^{\nu/2} \Gamma\left(\frac{\nu}{2}\right)\right]^{-1} \int_{\chi^2}^{\infty} (t)^{\frac{\nu}{2}-1} e^{-\frac{t}{2}} dt \quad (0 \leq \chi^2 < \infty)$$

Relation to Normal Distribution

Let X_1, X_2, \dots, X_n be independent and identically distributed random variables each following a normal distribution with mean zero and unit variance. Then $X^2 = \sum_{i=1}^n X_i^2$ is said to follow the chi-square distribution with ν degrees of freedom and the probability that $X^2 \leq \chi^2$ is given by $P(\chi^2|\nu)$.

Cumulants

26.4.3 $\kappa_{n+1} = 2^n n! \nu \quad (n=0, 1, \dots)$

*See page II.

Series Expansions

26.4.4

$$Q(\chi^2|\nu) = 2Q(x) + 2Z(x) \sum_{r=1}^{\frac{\nu-1}{2}} \frac{\chi^{2r-1}}{1 \cdot 3 \cdot 5 \dots (2r-1)}$$

(ν odd) and $x = \sqrt{\chi^2}$

26.4.5

$$Q(\chi^2|\nu) = \sqrt{2\pi} Z(x) \left\{ 1 + \sum_{r=1}^{\frac{\nu-2}{2}} \frac{\chi^{2r}}{2 \cdot 4 \dots (2r)} \right\}$$

(ν even)

26.4.6

$$P(\chi^2|\nu) = \left(\frac{1}{2}\chi^2\right)^{\nu/2} \frac{e^{-\chi^2/2}}{\Gamma\left(\frac{\nu+2}{2}\right)}$$

$$* \left\{ 1 + \sum_{r=1}^{\infty} \frac{\chi^{2r}}{(\nu+2)(\nu+4)\dots(\nu+2r)} \right\}$$

26.4.7 $P(\chi^2|\nu) = \frac{1}{\Gamma\left(\frac{\nu}{2}\right)} \sum_{n=0}^{\infty} \frac{(-1)^n (\chi^2/2)^{\frac{\nu}{2}+n}}{n! \left(\frac{\nu}{2}+n\right)}$

Recurrence and Differential Relations

26.4.8 $Q(\chi^2|\nu+2) = Q(\chi^2|\nu) + \frac{(\chi^2/2)^{\nu/2} e^{-\chi^2/2}}{\Gamma\left(\frac{\nu}{2}+1\right)}$

26.4.9 $\frac{\partial^m Q(\chi^2|\nu)}{\partial (\chi^2)^m} = \frac{1}{2^m} \sum_{j=0}^m \binom{m}{j} (-1)^{m+j} Q(\chi^2|\nu-2j)$

Continued Fraction

26.4.10 $*Q(\chi^2|\nu) = \frac{(\chi^2)^{\nu/2} e^{-\chi^2/2}}{2^{\nu/2} \Gamma(\nu/2)}$

$$\left\{ \frac{1}{\chi^2/2+} \frac{1-\nu/2}{1+} \frac{1}{\chi^2/2+} \frac{2-\nu/2}{1+} \frac{2}{\chi^2/2+} \dots \right\}$$

Asymptotic Distribution for Large ν

26.4.11 $P(\chi^2|\nu) \sim P(x)$ where $x = \frac{\chi^2 - \nu}{\sqrt{2\nu}}$

Asymptotic Expansions for Large χ^2

26.4.12

$$Q(\chi^2|\nu) \sim \frac{(\chi^2)^{\frac{\nu}{2}-1} e^{-\chi^2/2}}{2^{\nu/2} \Gamma(\nu/2)} \sum_{j=0}^{\infty} (-1)^j \frac{\Gamma\left(1 - \frac{\nu}{2} + j\right)}{\Gamma\left(1 - \frac{\nu}{2}\right)} \frac{2^{j+1}}{(\chi^2)^j}$$

*See page II.

Approximations to the Chi-Square Distribution for Large ν

26.4.13

Approximation $Q(\chi^2|\nu) \approx Q(x_1)$, $x_1 = \sqrt{2\chi^2} - \sqrt{2\nu-1}$ Condition ($\nu > 100$)

26.4.14

Approximation $Q(\chi^2|\nu) \approx Q(x_2)$, $x_2 = \frac{(\chi^2/\nu)^{1/3} - \left(1 - \frac{2}{9\nu}\right)}{\sqrt{2/9\nu}}$ Condition ($\nu > 30$)

26.4.15

Approximation $Q(\chi^2|\nu) \approx Q(x_2 + h_\nu)$, $h_\nu = \frac{60}{\nu} h_{60}$ Condition ($\nu > 30$)

Values of h_{60}

x	h_{60}	x	h_{60}	x	h_{60}
-3.5	-.0118	-1.0	+.0006	+1.5	-.0005
-3.0	-.0087	-.5	+.0006	2.0	+.0002
-2.5	-.0053	0	+.0002	2.5	.0017
-2.0	-.0010	+.5	-.0003	3.0	.0043
-1.5	+.0001	1.0	-.0006	3.5	.0082

Approximations for the Inverse Function for Large ν

If $Q(\chi_p^2|\nu) = p$ and $Q(x_p) = 1 - P(x_p) = p$, then

26.4.16 Approximation $\chi_p^2 \approx \frac{1}{2} \left\{ x_p + \sqrt{2\nu-1} \right\}^2$ Condition ($\nu > 100$)

26.4.17 $\chi_p^2 \approx \nu \left\{ 1 - \frac{2}{9\nu} + x_p \sqrt{\frac{2}{9\nu}} \right\}^3$ Condition ($\nu > 30$)

26.4.18 $\chi_p^2 \approx \nu \left\{ 1 - \frac{2}{9\nu} + (x_p - h_\nu) \sqrt{\frac{2}{9\nu}} \right\}^3$ Condition ($\nu > 30$)

where h_ν is given by 26.4.15.

Relation to Other Functions

26.4.19 Incomplete gamma function

$$\frac{\gamma(a, x)}{\Gamma(a)} = P(\chi^2|\nu), \quad \nu = 2a, \chi^2 = 2x$$

$$\frac{\Gamma(a, x)}{\Gamma(a)} = Q(\chi^2|\nu)$$

26.4.20 Pearson's incomplete gamma function

$$I(u, p) = \frac{1}{\Gamma(p+1)} \int_0^{u\sqrt{p+1}} t^p e^{-t} dt = P(\chi^2|\nu)$$

$$\nu = 2(p+1), \chi^2 = 2u\sqrt{p+1}$$

26.4.21 Poisson distribution

$$Q(\chi^2|\nu) = \sum_{j=0}^{c-1} e^{-m} \frac{m^j}{j!}, \quad c = \frac{\nu}{2}, m = \frac{\chi^2}{2}, (\nu \text{ even})$$

$$Q(\chi^2|\nu) - Q(\chi^2|\nu-2) = e^{-m} \frac{m^{c-1}}{(c-1)!}$$

26.4.22 Pearson Type III

$$\left[\frac{ab}{e}\right]^{ab} \int_{-a}^x \left(1 + \frac{t}{a}\right)^{ab} e^{-bt} dt = P(\chi^2|\nu)$$

$$\nu = 2ab + 2, \chi^2 = 2b(x+a)$$

26.4.23 Incomplete moments of Normal distribution

$$\int_0^x t^n Z(t) dt = \begin{cases} (n-1)!! \frac{P(\chi^2|\nu)}{2} & (n \text{ even}) \\ \frac{(n-1)!!}{\sqrt{2\pi}} P(\chi^2|\nu) & (n \text{ odd}) \end{cases}$$

$$\chi^2 = x^2, \nu = n+1$$

26.4.24 Generalized Laguerre Polynomials

$$n! L_n^{(\alpha)}(x) = \frac{\sum_{j=0}^{n-1} (-1)^{n+j} \binom{n+1}{j} Q(\chi^2|\nu+2-2j)}{2^n [Q(\chi^2|\nu+2) - Q(\chi^2|\nu)]}$$

$$x = \chi^2/2, \alpha = \nu/2$$

Non-Central χ^2 Distribution Function

26.4.25

$$P(\chi'^2|\nu, \lambda) = \sum_{j=0}^{\infty} e^{-\lambda/2} \frac{(\lambda/2)^j}{j!} P(\chi'^2|\nu+2j)$$

where $\lambda \geq 0$ is termed the non-centrality parameter.

Relation of Non-Central χ^2 Distribution With $\nu=2$ to the Integral of Circular Normal Distribution ($\sigma^2=1$) Over an Offset Circle Having Radius R and Center a Distance $r=\sqrt{\lambda}$ From the Origin. (See 26.3.24-26.3.27.)

26.4.26

$$\iint_A g(x, y, 0) dx dy = P(\chi^2 = R^2|\nu=2, \lambda)$$

$$= 1 - \sum_{j=0}^{\infty} \frac{e^{-\lambda/2} \lambda^j}{2^j j!} Q(R^2|2+2j)$$

Approximations to the Non-Central χ^2 Distribution

$$a = \nu + \lambda \quad b = \frac{\lambda}{\nu + \lambda}$$

Approximating Function

Approximation

26.4.27 χ^2 distribution $P(\chi'^2|\nu, \lambda) \approx P\left(\frac{\chi^2}{1+b} \middle| \nu^*\right), \quad \nu^* = \frac{a}{1+b}$

26.4.28 Normal distribution $P(\chi'^2|\nu, \lambda) \approx P(x), \quad x = \frac{(\chi'^2/a)^{1/3} - \left[1 - \frac{2}{9} \left(\frac{1+b}{a}\right)\right]}{\sqrt{\frac{2}{9} \left(\frac{1+b}{a}\right)}}$

26.4.29 Normal distribution $P(\chi'^2|\nu, \lambda) \approx P(x), \quad x = \left[\frac{2\chi'^2}{1+b}\right]^{1/2} - \left[\frac{2a}{1+b} - 1\right]^{1/2}$

Approximations to the Inverse Function of Non-Central χ^2 Distribution

If $Q(\chi_p'^2|\nu, \lambda) = p$, $Q(\chi_p^2|\nu^*) = p$, and $Q(x_p) = p$ then

Approximating Variable

Approximation to the Inverse Function

26.4.30 χ^2 $\chi_p'^2 \approx (1+b)\chi_p^2$

26.4.31 Normal $\chi_p'^2 \approx \frac{1+b}{2} \left[x_p + \sqrt{\frac{2a}{1+b} - 1} \right]^2$

26.4.32 Normal $\chi_p'^2 \approx a \left[x_p \sqrt{\frac{2(1+b)}{a}} + 1 - \frac{2}{9} \left(\frac{1+b}{a}\right) \right]^3$

Properties of Chi-Square, Non-Central Chi-Square, and Related Quantities

		$a = r + \lambda$ $b = \frac{\lambda}{r + \lambda}$			
		$\psi(z) = \frac{d}{dz} \ln \Gamma(z)$ $\psi'(z) = \frac{d^2}{dz^2} \psi(z)$			
Variable	Mean	Variance	Coefficient of skewness (γ_1)	Coefficient of excess (γ_2)	
26.4.33 x^2	$2r$	$\frac{2r^2}{\sqrt{r}}$		$12r^{-1}$	
26.4.34 $\sqrt{2}x^2$	$(2r-1)^{\frac{1}{2}}[1 + (16r(r-1))^{-1}] + O(r^{-1/2})$	$1 - \frac{1}{4r} + \frac{1}{8r^2} + \frac{5}{64r^3} - O(r^{-4})$	$\frac{1}{\sqrt{2r}} \left[1 + \frac{5}{8r} + \frac{1}{128r^2} \right] + O(r^{-3/2})$	$\frac{3}{2r^2} \left[1 + \frac{3}{2r} \right] + O(r^{-3})$	
26.4.35 $(x^2/r)^{1/2}$	$1 - \frac{2}{3r} + \frac{80}{3^2 r^2} + O(r^{-3})$	$\frac{2}{3^2 r} - \frac{104}{3^3 r^2} + O(r^{-3})$	$\frac{2^{7/2}}{3^2 r^{3/2}} \left[1 + \frac{8}{3r} \right] + O(r^{-1/2})$	$-\frac{4}{9r} \left[1 + \frac{16}{9r} \right] + O(r^{-2})$	
26.4.36 $\ln(x^2/r)$	$\psi\left(\frac{r}{2}\right) - \ln\left(\frac{r}{2}\right) - \frac{1}{r} + \frac{1}{3r^2} + O(r^{-3})$	$\psi'\left(\frac{r}{2}\right) = \frac{2}{r-1} \left[1 - \frac{1}{3(r-1)^2} \right] + O((r-1)^{-3})$	$\frac{\psi''\left(\frac{r}{2}\right)}{\psi'\left(\frac{r}{2}\right)^{3/2}} = -\sqrt{\frac{2}{r-1}} \left[1 - \frac{1}{2(r-1)^2} \right] + O((r-1)^{-3/2})$	$\frac{\psi^{(3)}\left(\frac{r}{2}\right)}{\psi'\left(\frac{r}{2}\right)^3} = \frac{4}{r-1} \left[1 + \frac{4}{3(r-1)^2} \right] + O((r-1)^{-3})$	
26.4.37 x'^2	a	$2a(1+b)$	$\left(\frac{2}{1+b}\right)^{1/2} (1+2b)a^{-\frac{1}{2}}$	$\frac{12}{a} \frac{(1+3b)}{(1+b)^2}$	
26.4.38 $\sqrt{2}x'^2$	$[2a - (1+b)]^{\frac{1}{2}} + O(a^{-1/2})$	$(1+b) - \frac{a^{-1}}{4} [8b + (1+b)(1-7b)] + O(a^{-2})$	$\frac{a^{-\frac{1}{2}}(1-b)(1+3b)}{2^{\frac{1}{2}}(1+b)^{3/2}} + O(a^{-1})$	$\frac{3b(2+b)}{(1+b)^2} + O(a^{-2})$	
26.4.39 $(x'^2/a)^{1/2}$	$1 - \frac{2}{3} \frac{1+b}{a} + \frac{40}{3^2} \frac{b^2}{a^2} + O(a^{-3})$	$\frac{2}{9} a^{-1}(1+b) + \frac{16}{27} a^{-2}b^2 + O(a^{-3})$	$\left(\frac{2}{1+b}\right)^{1/2} b a^{-\frac{1}{2}} + O(a^{-1/2})$	$-\frac{4}{3^2} \frac{(1+3b+12b^2-44b^3)}{a(1+b)^2} - O(a^{-2})$	

26.5. Incomplete Beta Function

26.5.1

$$I_x(a, b) = \frac{1}{B(a, b)} \int_0^x t^{a-1}(1-t)^{b-1} dt \quad (0 \leq x \leq 1)$$

26.5.2

$$I_x(a, b) = 1 - I_{1-x}(b, a)$$

Relation to the Chi-Square Distribution

If X_1^2 and X_2^2 are independent random variables following chi-square distributions 26.4.1 with ν_1 and ν_2 degrees of freedom respectively, then $\frac{X_1^2}{X_1^2 + X_2^2}$ is said to follow a beta distribution with ν_1 and ν_2 degrees of freedom and has the distribution function

26.5.3

$$P\left\{\frac{X_1^2}{X_1^2 + X_2^2} \leq x\right\} = \frac{1}{B(a, b)} \int_0^x t^{a-1}(1-t)^{b-1} dt = I_x(a, b) \quad a = \frac{\nu_1}{2}, b = \frac{\nu_2}{2}$$

Series Expansions ($0 < x < 1$)

26.5.4

$$* I_x(a, b) = \frac{x^a(1-x)^b}{aB(a, b)} \left\{ 1 + \sum_{n=0}^{\infty} \frac{B(a+1, n+1)}{B(a+b, n+1)} x^{n+1} \right\}$$

26.5.5

$$I_x(a, b) = \frac{x^a(1-x)^{b-1}}{aB(a, b)} \left\{ 1 + \sum_{n=0}^{\infty} \frac{B(a+1, n+1)}{B(b-n-1, n+1)} \left(\frac{x}{1-x}\right)^{n+1} \right\} = \frac{x^a(1-x)^{b-1}}{aB(a, b)} \left\{ 1 + \sum_{n=0}^{s-2} \frac{B(a+1, n+1)}{B(b-n-1, n+1)} \left(\frac{x}{1-x}\right)^{n+1} \right\} + I_x(a+s, b-s)$$

26.5.6

$$1 - I_x(a, b) = I_{1-x}(b, a) = \frac{(1-x)^b}{B(a, b)} \sum_{i=0}^{a-1} (-1)^i \binom{a-1}{i} \frac{(1-x)^i}{b+i} \quad (\text{integer } a)$$

26.5.7

$$1 - I_x(a, b) = I_{1-x}(b, a) = (1-x)^{a+b-1} \sum_{i=0}^{a-1} \binom{a+b-1}{i} \left(\frac{x}{1-x}\right)^i \quad (\text{integer } a)$$

Continued Fractions

26.5.8

$$I_x(a, b) = \frac{x^a(1-x)^b}{aB(a, b)} \left\{ \frac{1}{1 + \frac{d_1}{1 + \frac{d_2}{\dots}}} \right\} *$$

$$d_{2m+1} = -\frac{(a+m)(a+b+m)}{(a+2m)(a+2m+1)} x$$

$$d_{2m} = \frac{m(b-m)}{(a+2m-1)(a+2m)} x$$

Best results are obtained when $x < \frac{a-1}{a+b-2}$.

Also the $4m$ and $4m+1$ convergents are less than $I_x(a, b)$ and the $4m+2, 4m+3$ convergents are greater than $I_x(a, b)$.

26.5.9

$$I_x(a, b) = \frac{x^a(1-x)^{b-1}}{aB(a, b)} \left[\frac{e_1}{1 + \frac{e_2}{1 + \frac{e_3}{\dots}}} \right]$$

$$* \quad x < 1 \quad e_1 = 1$$

$$e_{2m} = -\frac{(a+m-1)(b-m)}{(a+2m-2)(a+2m-1)} \frac{x}{1-x}$$

$$e_{2m+1} = \frac{m(a+b-1+m)}{(a+2m-1)(a+2m)} \frac{x}{1-x}$$

Recurrence Relations

26.5.10

$$I_x(a, b) = xI_x(a-1, b) + (1-x)I_x(a, b-1)$$

26.5.11

$$I_x(a, b) = \frac{1}{x} \{ I_x(a+1, b) - (1-x)I_x(a+1, b-1) \}$$

26.5.12

$$[I_x(a, b)] = \frac{1}{a(1-x) + b} \{ bI_x(a, b+1) + a(1-x)I_x(a+1, b-1) \} *$$

26.5.13

$$I_x(a, b) = \frac{1}{a+b} \{ aI_x(a+1, b) + bI_x(a, b+1) \}$$

26.5.14

$$I_x(a, a) = \frac{1}{2} I_{1-x'}\left(a, \frac{1}{2}\right), \quad x' = 4\left(x - \frac{1}{2}\right)^2 \left[x \leq \frac{1}{2} \right]$$

26.5.15

$$I_x(a, b) = \frac{\Gamma(a+b)}{\Gamma(a+1)\Gamma(b)} x^a(1-x)^{b-1} + I_x(a+1, b-1)$$

26.5.16

$$I_x(a, b) = \frac{\Gamma(a+b)}{\Gamma(a+1)\Gamma(b)} x^a(1-x)^b + I_x(a+1, b)$$

*See page II.

Asymptotic Expansions

26.5.17

$$1 - I_x(a, b) = I_{1-x}(b, a) \sim \frac{\Gamma(b, y)}{\Gamma(b)} - \frac{1}{24N^2} \left\{ \frac{y^3 e^{-y}}{(b-2)!} (b+1+y) \right\} + \frac{1}{5760N^4} \left\{ \frac{y^5 e^{-y}}{(b-2)!} [(b-3)(b-2)(5b+7)(b+1+y) - (5b-7)(b+3+y)y^2] \right\}$$

$$y = -N \ln x, \quad N = a + \frac{b}{2} - \frac{1}{2}$$

26.5.18

$$I_x(a, b) \sim \frac{\Gamma(a, w)}{\Gamma(a)} + \frac{e^{-w} w^a}{\Gamma(a)} \left\{ \frac{(a-1-w)}{2b} + \frac{1}{(2b)^2} \left(\frac{a^3}{2} - \frac{5}{3} a^2 + \frac{3}{2} a - \frac{1}{3} - w \left[\frac{3}{2} a^2 - \frac{11}{6} a + \frac{1}{3} \right] + w^2 \left(\frac{3}{2} a - \frac{1}{6} \right) - \frac{1}{2} w^3 \right) \right\}$$

$$w = b \left(\frac{x}{1-x} \right)$$

26.5.19

$$I_x(a, b) \sim P(y) - Z(y) \left[a_1 + \frac{a_2(y-a_1)}{1+a_2} + \frac{a_3(1+y^2/2)}{1+a_2} + \dots \right]$$

$$a_1 = \frac{2}{3} (b-a) [(a+b-2)(a-1)(b-1)]^{-1/2}$$

$$a_2 = \frac{1}{12} \left[\frac{1}{a-1} + \frac{1}{b-1} - \frac{13}{a+b-1} \right]$$

$$a_3 = -\frac{8}{15} \left[a_1 \left(a_2 + \frac{3}{a+b-2} \right) \right]$$

$$y^2 = 2 \left[(a+b-1) \ln \frac{a+b-1}{a+b-2} + (a-1) \ln \frac{a-1}{(a+b-1)x} + (b-1) \ln \frac{b-1}{(a+b-1)(1-x)} \right]$$

and y is taken negative when $x < \frac{a-1}{a+b-2}$

Approximations

26.5.20 If $(a+b-1)(1-x) \leq .8$

$$I_x(a, b) = Q(x^2 | \nu) + \epsilon, \quad |\epsilon| < 5 \times 10^{-3} \text{ if } a+b > 6$$

$$x^2 = (a+b-1)(1-x)(3-x) - (1-x)(b-1), \quad \nu = 2b$$

26.5.21 If $(a+b-1)(1-x) \geq .8$

$$I_x(a, b) = P(y) + \epsilon, \quad |\epsilon| < 5 \times 10^{-3} \text{ if } a+b > 6$$

$$y = \frac{3 \left[w_1 \left(1 - \frac{1}{9b} \right) - w_2 \left(1 - \frac{1}{9a} \right) \right]}{\left[\frac{w_1^2}{b} + \frac{w_2^2}{a} \right]^{1/2}}$$

$$w_1 = (bx)^{1/3}, \quad w_2 = [a(1-x)]^{1/3}$$

Approximation to the Inverse Function

26.5.22 If $I_{x_p}(a, b) = p$ and $Q(y_p) = p$ then

$$x_p \approx \frac{a}{a + b e^{2w}}$$

$$w = \frac{y_p(h+\lambda)^{1/2}}{h} - \left(\frac{1}{2b-1} - \frac{1}{2a-1} \right) \left(\lambda + \frac{5}{6} - \frac{2}{3h} \right)$$

$$h = 2 \left(\frac{1}{2a-1} + \frac{1}{2b-1} \right)^{-1}, \quad \lambda = \frac{y_p^2 - 3}{6}$$

Relations to Other Functions and Distributions

Function

Relation

26.5.23 Hypergeometric function

$$\frac{1}{B(a, b)} \frac{x^a}{a} F(a, 1-b; a+1; x) = I_x(a, b)$$

26.5.24 Binomial distribution

$$\sum_{s=0}^n \binom{n}{s} p^s (1-p)^{n-s} = I_p(a, n-a+1)$$

26.5.25 “

$$\binom{n}{a} p^a (1-p)^{n-a} = I_p(a, n-a+1) - I_p(a+1, n-a) *$$

26.5.26 Negative binomial distribution

$$\sum_{s=0}^n \binom{n+s-1}{s} p^n q^s = I_q(a, n)$$

26.5.27 Student's distribution

$$\frac{1}{2} [1 - A(t|\nu)] = \frac{1}{2} I_x \left(\frac{\nu}{2}, \frac{1}{2} \right), \quad x = \frac{\nu}{\nu + t^2} *$$

26.5.28 F -(variance-ratio) distribution

$$Q(F|\nu_1, \nu_2) = I_x \left(\frac{\nu_2}{2}, \frac{\nu_1}{2} \right), \quad x = \frac{\nu_2}{\nu_2 + \nu_1 F}$$

*See page 11.

26.6. *F*-(Variance-Ratio) Distribution Function

26.6.1

$$P(F|v_1, v_2) = \frac{v_1^{v_1} v_2^{v_2}}{B\left(\frac{1}{2}v_1, \frac{1}{2}v_2\right)} \int_0^F t^{v_1-2} (v_2+v_1t)^{-v_1-v_2} dt \quad (F \geq 0)$$

26.6.2

$$Q(F|v_1, v_2) = 1 - P(F|v_1, v_2) = I_x\left(\frac{v_2}{2}, \frac{v_1}{2}\right)$$

where

$$x = \frac{v_2}{v_2 + v_1 F}$$

Relation to the Chi-Square Distribution

If X_1^2 and X_2^2 are independent random variables following chi-square distributions 26.4.1 with v_1 and v_2 degrees of freedom respectively, then the distribution of $F = \frac{X_1^2/v_1}{X_2^2/v_2}$ is said to follow the variance ratio or *F*-distribution with v_1 and v_2 degrees of freedom. The corresponding distribution function is $P(F|v_1, v_2)$.

Statistical Properties

26.6.3

mean: $m = \frac{v_2}{v_2 - 2} \quad (v_2 > 2)$

variance: $\sigma^2 = \frac{2v_2^2(v_1 + v_2 - 2)}{v_1(v_2 - 2)^2(v_2 - 4)} \quad (v_2 > 4)$

third central moment:

$$\mu_3 = \left(\frac{v_2}{v_1}\right)^3 \frac{8v_1(v_1 + v_2 - 2)(2v_1 + v_2 - 2)}{(v_2 - 2)^3(v_2 - 4)(v_2 - 6)} \quad (v_2 > 6)$$

moments about the origin:

$$\mu'_n = \left(\frac{v_2}{v_1}\right)^n \frac{\Gamma\left(\frac{v_1 + 2n}{2}\right) \Gamma\left(\frac{v_1 - 2n}{2}\right)}{\Gamma\left(\frac{v_1}{2}\right) \Gamma\left(\frac{v_2}{2}\right)} \quad (v_2 > 2n)$$

characteristic function:

$$\phi(t) = E(e^{iFt}) = M\left(\frac{v_1}{2}, -\frac{v_2}{2}, -\frac{v_2}{v_1} it\right)$$

Series Expansions

$$x = \frac{v_2}{v_2 + v_1 F}$$

26.6.4

$$* Q(F|v_1, v_2) = x^{v_2/2} \left[1 + \frac{v_2}{2}(1-x) + \frac{v_2(v_2+2)}{2 \cdot 4}(1-x)^2 + \dots + \frac{v_2(v_2+2) \dots (v_2+v_1-4)}{2 \cdot 4 \dots (v_1-2)} (1-x)^{\frac{v_1-2}{2}} \right] \quad (v_1 \text{ even})$$

26.6.5

$$Q(F|v_1, v_2) = 1 - (1-x)^{v_1/2} \left[1 + \frac{v_1}{2}x + \frac{v_1(v_1+2)}{2 \cdot 4}x^2 + \dots + \frac{v_1(v_1+2) \dots (v_2+v_1-4)}{2 \cdot 4 \dots (v_2-2)} x^{\frac{v_2-2}{2}} \right] \quad (v_2 \text{ even})$$

26.6.6

$$Q(F|v_1, v_2) = x^{\frac{v_1+v_2-2}{2}} \left[1 + \frac{v_1+v_2-2}{2} \left(\frac{1-x}{x}\right) + \frac{(v_1+v_2-2)(v_1+v_2-4)}{2 \cdot 4} \left(\frac{1-x}{x}\right)^2 + \dots + \frac{(v_1+v_2-2) \dots (v_2+2)}{2 \cdot 4 \dots (v_1-2)} \left(\frac{1-x}{x}\right)^{\frac{v_1-2}{2}} \right] \quad (v_1 \text{ even})$$

26.6.7

$$Q(F|v_1, v_2) = 1 - (1-x)^{\frac{v_1+v_2-2}{2}} \left[1 + \frac{v_1+v_2-2}{2} \left(\frac{x}{1-x}\right) + \dots + \frac{(v_1+v_2-2) \dots (v_1+2)}{2 \cdot 4 \dots (v_2-2)} \left(\frac{x}{1-x}\right)^{\frac{v_2-2}{2}} \right] \quad (v_2 \text{ even})$$

26.6.8

$$Q(F|v_1, v_2) = 1 - A(t|v_2) + \beta(v_1, v_2) \quad (v_1, v_2 \text{ odd})$$

$$A(t|v_2) = \begin{cases} \frac{2}{\pi} \left\{ \theta + \sin \theta \left[\cos \theta + \frac{2}{3} \cos^3 \theta + \dots + \frac{2 \cdot 4 \dots (v_2-3)}{3 \cdot 5 \dots (v_2-2)} \cos^{v_2-2} \theta \right] \right\} & \text{for } v_2 > 1 \\ \frac{2\theta}{\pi} & \text{for } v_2 = 1 \end{cases}$$

$$\beta(v_1, v_2) = \begin{cases} \frac{2 \left(\frac{v_2-1}{2}\right)!}{\sqrt{\pi} \left(\frac{v_2-2}{2}\right)!} \sin \theta \cos^{v_2} \theta \left\{ 1 + \frac{v_2+1}{3} \sin^2 \theta + \dots + \frac{(v_2+1)(v_2+3) \dots (v_1+v_2-4) \sin^{v_1-3} \theta}{3 \cdot 5 \dots (v_1-2)} \right\} & \\ 0 & \text{for } v_1 = 1 \quad * \end{cases} \quad \text{for } v_2 > 1$$

where

$$\theta = \arctan \sqrt{\frac{v_1}{v_2} F}$$

Reflexive Relation

If $F_p(v_1, v_2)$ and $F_{1-p}(v_2, v_1)$ satisfy

$$Q(F_p(v_1, v_2)|v_1, v_2) = p$$

$$Q(F_{1-p}(v_2, v_1)|v_2, v_1) = 1 - p$$

*See page II.

26.6.9 then

$$F_p(\nu_1, \nu_2) = \frac{1}{F_{1-p}(\nu_2, \nu_1)}$$

Relation to Student's *t*-Distribution Function (See 26.7)

26.6.10 $Q(F|\nu_1=1, \nu_2) = 1 - A(t|\nu_2) \quad t = \sqrt{F}$

Limiting Forms

26.6.11

$$\lim_{\nu_2 \rightarrow \infty} Q(F|\nu_1, \nu_2) = Q(\chi^2|\nu_1), \quad \chi^2 = \nu_1 F$$

26.6.12

$$\lim_{\nu_1 \rightarrow \infty} Q(F|\nu_1, \nu_2) = P(\chi^2|\nu_2), \quad \chi^2 = \frac{\nu_2}{F}$$

Approximations

26.6.13

$$Q(F|\nu_1, \nu_2) \approx Q(x), \quad x = \frac{F - \frac{\nu_2}{\nu_2 - 2}}{\frac{\nu_2}{\nu_2 - 2} \sqrt{\frac{2(\nu_1 + \nu_2 - 2)}{\nu_1(\nu_2 - 4)}}}$$

(ν_1 and ν_2 large)

26.6.14

$$Q(F|\nu_1, \nu_2) \approx Q(x), \quad x = \frac{\sqrt{(2\nu_2 - 1) \frac{\nu_1}{\nu_2} F - \sqrt{2\nu_1 - 1}}}{\sqrt{1 + \frac{\nu_1}{\nu_2} F}}$$

26.6.15

$$Q(F|\nu_1, \nu_2) \approx Q(x), \quad x = \frac{F^{1/3} \left(1 - \frac{2}{9\nu_2}\right) - \left(1 - \frac{2}{9\nu_1}\right)}{\sqrt{\frac{2}{9\nu_1} + F^{2/3} \frac{2}{9\nu_2}}}$$

Approximation to the Inverse Function

26.6.16 If $Q(F_p|\nu_1, \nu_2) = p$, then

$$F_p \approx e^{2w} \text{ where } w \text{ is given by 26.5.22, with } \nu_1 = 2b, \nu_2 = 2a$$

Non-Central *F*-Distribution Function

26.6.17

$$P(F'|\nu_1, \nu_2, \lambda) = \int_0^{F'} p(t|\nu_1, \nu_2, \lambda) dt = 1 - Q(F'|\nu_1, \nu_2, \lambda)$$

where

$$p(t|\nu_1, \nu_2, \lambda) = \sum_{j=0}^{\infty} e^{-\lambda/2} \frac{(\lambda/2)^j}{j!} \frac{t^{\nu_1+2j} (1-t)^{\nu_2/2}}{B\left(\frac{\nu_1+2j}{2}, \frac{\nu_2}{2}\right)} \times t^{\frac{\nu_1+2j-2}{2}} [\nu_2 + (\nu_1+2j)t]^{-(\nu_1+2j+\nu_2)/2}$$

and $\lambda \geq 0$ is termed the non-centrality parameter.

Relation of Non-Central *F*-Distribution Function to Other Functions

Function

Relation

26.6.18 *F*-distribution

$$P(F'|\nu_1, \nu_2, \lambda) = \sum_{j=0}^{\infty} e^{-\lambda/2} \frac{(\lambda/2)^j}{j!} P(F'|\nu_1+2j, \nu_2)$$

$$P(F'|\nu_1, \nu_2, \lambda=0) = P(F'|\nu_1, \nu_2)$$

26.6.19 Non-central *t*-distribution

$$P(F'|\nu_1=1, \nu_2, \lambda) = P(t'|\nu, \delta), \quad t' = \sqrt{F'}, \nu = \nu_2, \delta = \sqrt{\lambda}$$

26.6.20 Incomplete Beta function

$$P(F'|\nu_1, \nu_2) = \sum_{j=0}^{\infty} e^{-\lambda/2} \frac{(\lambda/2)^j}{j!} I_x\left(\frac{\nu_1}{2} + j, \frac{\nu_2}{2}\right), \quad x = \frac{\nu_1 F'}{\nu_1 F' + \nu_2} *$$

26.6.21 Confluent hypergeometric function

$$P(F'|\nu_1, \nu_2, \lambda) = \sum_{i=0}^{\frac{\nu_2}{2}-1} \frac{2e^{-\lambda/2}}{(\nu_1 + \nu_2) B\left(\frac{\nu_1}{2} + i + 1, \frac{\nu_2}{2} - i\right)} \times x^{\frac{\nu_1}{2}+1} (1-x)^{\frac{\nu_2}{2}-i-1} M\left(\frac{\nu_1 + \nu_2}{2}, \frac{\nu_1}{2} + i + 1, \frac{\lambda x}{2}\right) \left(\nu_2 \text{ even and } x = \frac{\nu_2}{\nu_1 F' + \nu_2}\right)$$

*See page II.

Series Expansion

26.6.22

$$P(F'|v_1, v_2, \lambda) = e^{-\frac{\lambda}{2}(1-x)} x^{\frac{1}{2}(v_1+v_2-2)} \sum_{i=0}^{\frac{v_2-1}{2}} T_i \quad (v_2 \text{ even})$$

where

$$T_0 = 1$$

$$T_1 = \frac{1}{2} (v_1 + v_2 - 2 + \lambda x) \frac{1-x}{x}$$

$$T_i = \frac{1-x}{2i} [(v_1 + v_2 - 2i + \lambda x) T_{i-1} + \lambda(1-x) T_{i-2}]$$

$$x = \frac{v_2}{v_1 F' + v_2}$$

Limiting Forms

26.6.23

$$\lim_{v_2 \rightarrow \infty} P(F'|v_1, v_2, \lambda) = P(\chi'^2|v, \lambda), \quad \chi'^2 = v_1 F', \quad v = v_1$$

26.6.24

$$\lim_{v_1 \rightarrow \infty} P(F'|v_1, v_2, \lambda) = Q(\chi^2|v), \quad \chi^2 = \frac{v_2(1+c^2)}{F'}$$

where $\lambda/v_1 \rightarrow c^2$ as $v_1 \rightarrow \infty$.

Approximations to the Non-Central F-Distribution

26.6.25 $P(F'|v_1, v_2, \lambda) \approx P(x_1),$ (v_1 and v_2 large)

where

$$x_1 = \frac{F' - \frac{v_2(v_1 + \lambda)}{v_1(v_2 - 2)}}{\frac{v_2}{v_1} \left[\frac{2}{(v_2 - 2)(v_2 - 4)} \left\{ \frac{(v_1 + \lambda)^2}{v_2 - 2} + v_1 + 2\lambda \right\} \right]^{\frac{1}{2}}}$$

26.6.26

$$P(F'|v_1, v_2, \lambda) \approx P(F|v_1^*, v_2),$$

$$F = \frac{v_1}{v_1 + \lambda} F', \quad v_1^* = \frac{(v_1 + \lambda)^2}{v_1 + 2\lambda}$$

26.6.27

$$P(F'|v_1, v_2, \lambda) \approx P(x_2),$$

$$x_2 = \frac{\left[\frac{v_1 F'}{(v_1 + \lambda)} \right]^{1/3} \left[1 - \frac{2}{9v_2} \right] - \left[1 - \frac{2(v_1 + 2\lambda)}{9(v_1 + \lambda)^2} \right]}{\left[\frac{2}{9} \frac{v_1 + 2\lambda}{(v_1 + \lambda)^2} + \frac{2}{9v_2} \left(\frac{v_1}{v_1 + \lambda} F' \right)^{2/3} \right]^{\frac{1}{2}}}$$

26.7. Student's *t*-Distribution

If X is a random variable following a normal distribution with mean zero and variance unity, and χ^2 is a random variable following an independent chi-square distribution with ν degrees of freedom, then the distribution of the ratio $\frac{X}{\sqrt{\chi^2/\nu}}$

is called Student's *t*-distribution with ν degrees of freedom. The probability that $\frac{X}{\sqrt{\chi^2/\nu}}$ will be less in absolute value than a fixed constant t is

26.7.1

$$A(t|\nu) = P_r \left\{ \left| \frac{X}{\sqrt{\chi^2/\nu}} \right| \leq t \right\}$$

$$= \left[\sqrt{\nu} B \left(\frac{1}{2}, \frac{\nu}{2} \right) \right]^{-1} \int_{-t}^t \left(1 + \frac{x^2}{\nu} \right)^{-\frac{\nu+1}{2}} dx$$

$$= 1 - I_x \left(\frac{\nu}{2}, \frac{1}{2} \right), \quad (0 \leq t < \infty) \quad *$$

where

$$x = \frac{\nu}{\nu + t^2}$$

Statistical Properties

26.7.2

mean: $m = 0$

variance: $\sigma^2 = \frac{\nu}{\nu - 2}$ ($\nu > 2$)

skewness: $\gamma_1 = 0$

excess: $\gamma_2 = \frac{6}{\nu - 4}$ ($\nu > 4$)

moments:

$$\mu_{2n} = \frac{1 \cdot 3 \dots (2n-1) \nu^n}{(\nu-2)(\nu-4) \dots (\nu-2n)} \quad (\nu > 2n)$$

$$\mu_{2n+1} = 0$$

characteristic function:

$$\phi(t) = E \left[\exp \left(it \frac{X}{\sqrt{\chi^2/\nu}} \right) \right] = \frac{\left(\frac{|t|}{2\sqrt{\nu}} \right)^{\nu/2}}{\pi \Gamma(\nu/2)} Y_{\nu/2} \left(\frac{|t|}{\sqrt{\nu}} \right)$$

Series Expansions

$$\left(\theta = \arctan \frac{t}{\sqrt{\nu}} \right)$$

26.7.3

$$A(t|\nu) = \begin{cases} \frac{2}{\pi} \left\{ \theta + \sin \theta \left[\cos \theta + \frac{2}{3} \cos^3 \theta + \dots \right. \right. \\ \left. \left. + \frac{2 \cdot 4 \dots (\nu-3)}{1 \cdot 3 \dots (\nu-2)} \cos^{\nu-2} \theta \right] \right\} & (\nu > 1 \text{ and odd}) \\ \frac{2}{\pi} \theta & (\nu = 1) \end{cases} \quad *$$

26.7.4

$$A(t|\nu) = \sin \theta \left\{ 1 + \frac{1}{2} \cos^2 \theta + \frac{1 \cdot 3}{2 \cdot 4} \cos^4 \theta + \dots \right. \\ \left. + \frac{1 \cdot 3 \cdot 5 \dots (\nu-3)}{2 \cdot 4 \cdot 6 \dots (\nu-2)} \cos^{\nu-2} \theta \right\} \quad (\nu \text{ even}) \quad *$$

*See page II.

Asymptotic Expansion for the Inverse Function

If $A(t_p|\nu) = 1 - 2p$ and $Q(x_p) = p$, then

26.7.5

$$t_p \sim x_p + \frac{g_1(x_p)}{\nu} + \frac{g_2(x_p)}{\nu^2} + \frac{g_3(x_p)}{\nu^3} + \dots$$

$$g_1(x) = \frac{1}{4}(x^3 + x)$$

$$g_2(x) = \frac{1}{96}(5x^5 + 16x^3 + 3x)$$

$$g_3(x) = \frac{1}{384}(3x^7 + 19x^5 + 17x^3 - 15x)$$

$$g_4(x) = \frac{1}{92160}(79x^9 + 776x^7 + 1482x^5 - 1920x^3 - 945x)$$

Limiting Distribution

26.7.6

$$\lim_{\nu \rightarrow \infty} A(t|\nu) = \frac{1}{\sqrt{2\pi}} \int_{-t}^t e^{-x^2/2} dx = A(t)$$

Approximation for Large Values of t and $\nu \leq 5$

26.7.7 $A(t|\nu) \approx 1 - 2 \left\{ \frac{a_\nu}{t^\nu} + \frac{b_\nu}{t^{\nu+1}} \right\}$

ν	1	2	3	4	5
a_ν	.3183	.4991	1.1094	3.0941	9.948
b_ν	.0000	.0518	-.0460	-2.756	-14.05

Approximation for Large ν

26.7.8 $A(t|\nu) \approx 2P(x) - 1, \quad x = \frac{t \left(1 - \frac{1}{4\nu}\right)}{\sqrt{1 + \frac{t^2}{2\nu}}}$

Non-Central t-Distribution

26.7.9

$$P(t'|\nu, \delta) = \frac{1}{\sqrt{\nu} B\left(\frac{1}{2}, \frac{\nu}{2}\right)} \int_{-\infty}^{t'} \left(\frac{\nu}{\nu+x^2}\right)^{\frac{\nu+1}{2}} e^{-\frac{1}{2} \frac{\delta^2}{\nu+x^2}} H_h \left(\frac{-\delta x}{\sqrt{\nu+x^2}}\right) dx$$

$$= 1 - \sum_{j=0}^{\infty} e^{-\delta^2/2} \frac{(\delta^2/2)^j}{2j!} I_x \left(\frac{\nu}{2}, \frac{1}{2} + j\right), \quad x = \frac{\nu}{\nu+t'^2} *$$

where δ is termed the non-centrality parameter.

Approximation to the Non-Central t-Distribution

26.7.10

$$P(t'|\nu, \delta) \approx P(x) \quad \text{where } x = \frac{t' \left(1 - \frac{1}{4\nu}\right) - \delta}{\left(1 + \frac{t'^2}{2\nu}\right)^{1/2}}$$

Numerical Methods

26.8. Methods of Generating Random Numbers and Their Applications ⁹

Random digits are digits generated by repeated independent drawings from the population 0, 1, 2, . . . , 9 where the probability of selecting any digit is one-tenth. This is equivalent to putting 10 balls, numbered from 0 to 9, into an urn and drawing one ball at a time, replacing the ball after each drawing. The recorded set of numbers forms a collection of random digits. Any group of n successive random digits is known as a *random number*.

Several lengthy tables of random digits are available (see references). However, the use of random numbers in electronic computers has resulted in a need for random numbers to be generated in a completely deterministic way. The numbers so generated are termed pseudo-random numbers. The quality of pseudo-random numbers is determined by subjecting the numbers to several statistical tests, see [26.55], [26.56]. The purpose of these statistical tests is to detect any properties of the pseudo-random numbers which are different from the (conceptual) properties of random numbers.

Experience has shown that the congruence method is the most preferable device for generating random numbers on a computer. Let the sequence of pseudo-random numbers be denoted by $\{X_n\}$, $n=0, 1, 2, \dots$. Then the congruence method of generating pseudo-random numbers is

$$X_{n+1} = aX_n + b \pmod{T}$$

where b and T are relatively prime. The choice of T is determined by the capacity and base of the computer; a and b are chosen so that: (1) the resulting sequence $\{X_n\}$ possesses the desired statistical properties of random numbers, (2) the period of the sequence is as long as possible, and (3) the speed of generation is fast. A guide for choosing a and b is to make the correlation between the numbers be near zero, e.g., the correlation between X_n and X_{n+s} is

$$\rho_s = \frac{1 - 6 \frac{b_s}{T} \left(1 - \frac{b_s}{T}\right)}{a_s} + e$$

where

$$a_s = a^s \pmod{T}$$

$$b_s = (1 + a + a^2 + \dots + a^{s-1})b \pmod{T}$$

$$|e| < a_s/T$$

⁹ The authors wish to express their appreciation to Professor J. W. Tukey who made many penetrating and helpful suggestions in this section.

*See page 11.

which occur in

$$X_{n+s} = a_s X_n + b_s \pmod{T}$$

When a is chosen so that $a \approx T^{1/2}$, the correlation $\rho_1 \approx T^{-1/2}$.

The sequence defined by the multiplicative congruence method will have a full period of T numbers if

- (i) b is relatively prime to T
- (ii) $a \equiv 1 \pmod{p}$ if p is a prime factor of T
- (iii) $a \equiv 1 \pmod{4}$ if 4 is a factor of T .

Consequently if $T=2^s$, b need only be odd, and

$a \equiv 1 \pmod{4}$. When $T=10^s$, b need only be not divisible by 2 or 5, and $a \equiv 1 \pmod{20}$. The most convenient choices for a are of the form $a=2^s+1$ (for binary computers) and $a=10^s+1$ (for decimal computers). This results in the fastest generation of random numbers as the operations only require a shift operation plus two additions. Also any number can serve as the starting point to generate a sequence of random digits. A good summary of generating pseudo-random numbers is [26.51].

Below are listed various congruence schemes and their properties.

Congruence methods for generating random numbers

$$X_{n+1} = aX_n + b \pmod{T}, \quad T \text{ and } b \text{ relatively prime}$$

	a	b	T	Period	X_0	Special cases for which random numbers have passed statistical tests for randomness ¹⁰
26.8.1	$1+t^s$	odd	$T=t^s$	t^s	$0 \leq X_0 < T$	$T=2^{24}$, X_0 unknown; $a=2^7+1$, $b=1$; $T=2^{47}$, $a=2^8+1$, $b=29741\ 09625\ 8473$, $X_0=76293\ 94531\ 25$.
26.8.2	$r2^s \pm 1$ (r odd, $s \geq 2$)	0	$T=t^s$	t^{s-1}	relatively prime to T	$T=2^{24}$, 2^{24} , $X_0=1$; $a=5^{17}(s=2)$
26.8.3	$r2^s \pm 1$ (r odd, $s \geq 2$)	0	$T=t^s \pm 1$	(varies)	relatively prime to T	$T=2^{26}$, $X_0=1$; $T=2^{26}$, $X_0=1-2^{-26}$, .5478126193; $a=5^{19}(s=2)$
26.8.4	7^{4s+1}	0	$T=10^s$	$5 \cdot 10^{s-2}$	relatively prime to T	$T=2^{28}+1$, $X_0=10,987,654,321$; $a=23$; period $\approx 10^8$ $T=10^8+1$, $X_0=47,594,118$; $a=23$; period $\approx 5.8 \times 10^8$
26.8.5	3^{4s+1} ($s=0, 2, 3, 4$)	0	$T=10^s$	$5 \cdot 10^{s-2}$	relatively prime to T	$T=10^{10}$, $X_0=1$; $a=7$ $T=10^{11}$, $X_0=1$; $a=7^{13}$

¹⁰ X_0 given is the starting point for random numbers when statistical tests were made.

When the numbers are generated using a congruence scheme, the least significant digits have short periods. Hence the entire word length cannot be used. If one desired random numbers with as many digits as possible, one would have to modify the congruence schemes. One way is to generate the numbers mod $T \pm 1$. This unfortunately reduces the period.

Generation of Random Deviates

Let $\{X\}$ be a generated sequence of independent random numbers having the domain $(0, T)$. Then $\{U\} = \{T^{-1}X\}$ is a sequence of random deviates (numbers) from a uniform distribution on the interval $(0, 1)$. This is usually a necessary preliminary step in the generation of random deviates having a given cumulative distribution function $F(y)$ or probability density function $f(y)$. Below are summarized some general techniques

for producing arbitrary random deviates. (In what follows $\{U\}$ will always denote a sequence of random deviates from a uniform distribution on the interval $(0, 1)$.)

1. Inverse Method

The solutions $\{y\}$ of the equations $\{u=F(y)\}$ form a sequence of independent random deviates with cumulative distribution function $F(y)$. (If $F(y)$ has a discontinuity at $y=y_0$, then whenever u is such that $F(y_0-0) < u < F(y_0)$, select y_0 as the corresponding deviate.) Generally the inverse method is not practical unless the inverse function $y=F^{-1}(u)$ can be obtained explicitly or can be conveniently approximated.

2. Generating a Discrete Random Variable

Let Y be a discrete random variable with point probabilities $p_i = Pr\{Y=y_i\}$ for $i=1, 2, \dots$

*See page II.

The direct way to generate Y is to generate $\{U\}$ and put $Y=y_1$ if

$$p_1 + p_2 + \dots + p_{i-1} < U < p_1 + p_2 + \dots + p_i.$$

However, this method requires complicated machine programs that take too long.

An alternative way due to Marsaglia [26.53] is simple, fast, and seems to be well suited to high-speed computations. Let p_i for $i=1, 2, \dots, n$ be expressed by k decimal digits as $p_i = .\delta_{i1}\delta_{i2} \dots \delta_{ik}$ where the δ 's are the decimal digits. (If the domain of the random variable is infinite, it is necessary to truncate the probability distribution at p_n .) Define

$$P_0=0, P_r=10^{-r} \sum_{i=1}^n \delta_{ri} \text{ for } r=1, 2, \dots, k, \text{ and}$$

$$\Pi_s = \sum_{r=0}^{s-1} 10^r P_r, s=1, 2, \dots, k.$$

Number the computer memory locations by 0, 1, 2, . . . , Π_k-1 . The memory locations are divided into k mutually exclusive sets such that the s th set consists of memory locations $\Pi_{s-1}, \Pi_{s-1}+1, \dots, \Pi_s-1$. The information stored in the memory locations of the s th set consists of y_1 in δ_{s1} locations, y_2 in δ_{s2} locations, . . . , y_n in δ_{sn} locations.

Denote the decimal expansion of the uniform deviates generated by the computer by $u = .d_1d_2d_3 \dots$ and finally let $\sigma\{m\}$ be the contents of memory location m . Then if

$$\sum_{i=0}^{s-1} P_i \leq U < \sum_{i=0}^s P_i$$

put

$$y = a \left\{ d_1 d_2 \dots d_s + \Pi_{s-1} - 10^s \sum_{i=1}^{s-1} P_i \right\}.$$

This method is perhaps the best all-around method for generating random deviates from a discrete distribution. In order to illustrate this method consider the problem of generating deviates from the binomial distribution with point probabilities

$$p_i = \binom{n}{i} p^i (1-p)^{n-i}$$

for $n=5$ and $p=.20$. The point probabilities to 4 D are

Value of Random Variable	Point Probabilities
0	$p_0=0.3277$
1	$p_1=.4096$
2	$p_2=.2048$
3	$p_3=.0512$
4	$p_4=.0064$
5	$p_5=.0003$

and thus $P_0=0, P_1=.9, P_2=.07, P_3=.027, P_4=.0030$ from which $\Pi_0=0, \Pi_1=9, \Pi_2=16, \Pi_3=43, \Pi_4=73$. The 73 memory locations are divided into 4 mutually exclusive sets such that

Set	Memory Locations
1	0, 1, . . . , 8
2	9, 10, . . . , 15
3	16, . . . , 42
4	43, . . . , 72

Among the nine memory locations of set 1, zero is stored $\delta_{10}=3$ times, 1 is stored $\delta_{11}=4$ times, 2 is stored $\delta_{12}=2$ times; the seven locations of set 2 store 0 $\delta_{20}=2$ times and 3 $\delta_{23}=5$ times; etc. A summary of the memory locations is set out below:

	Value of Random Variable					
	0	1	2	3	4	5
Frequency (set 1)	3	4	2	0	0	0
Frequency (set 2)	2	0	0	5	0	0
Frequency (set 3)	7	9	4	1	6	0
Frequency (set 4)	7	6	8	2	4	3

Then to generate the random variables if

$0 \leq u < .9$	put	$y = a \{ d_1 \}$
$.9 \leq u < .97$		$y = a \{ d_1 d_2 - 81 \}$
$.97 \leq u < .997$		$y = a \{ d_1 d_2 d_3 - 954 \}$
$.997 \leq u < 1.000$		$y = a \{ d_1 d_2 d_3 d_4 - 9927 \}$

3. Generating a Continuous Random Variable

The method for generating deviates from a discrete distribution can be adapted to random variables having a continuous distribution. Let $F(y)$ be the cumulative distribution function and assume that the domain of the random variable is (a, b) where the interval is finite. (If the domain is infinite, it must be truncated at (say) the points a and b .) Divide the interval $(b-a)$ into n sub-intervals of length Δ ($n\Delta=b-a$) such that the boundary of the i th interval is (y_{i-1}, y_i) where $y_i = a + i\Delta$ for $i=0, 1, \dots, n$. Now define a discrete distribution having domain

$$\left\{ z_i = \frac{y_i + y_{i-1}}{2} \right\}$$

with point probabilities $p_i = F(y_i) - F(y_{i-1})$. Finally, let W be a random variable having a uniform distribution on $\left(-\frac{\Delta}{2}, \frac{\Delta}{2}\right)$. This can be done by setting $W = \Delta \left(U - \frac{1}{2}\right)$. Then random

deviates from the distribution function $F(y)$, can be generated (approximately) by setting $y = z + w = z + \Delta \left(u - \frac{1}{2}\right)$. This is simply an approximate decomposition of the continuous random variable into the sum of a discrete and continuous random variable. The discrete variable can be generated quickly by the method described previously. The smaller the value of Δ the better will be the approximation. Each number can be generated by using the leading digits of U to generate the discrete random variable Z and the remaining digits forming a uniformly distributed deviate having $(0,1)$ domain.

4. Acceptance-Rejection Methods

In what follows the random variable Y will be assumed to have finite domain (a, b) . If the domain is infinite, it must be truncated for computational purposes at (say) the points a and b . Then the resulting random deviates will only have this truncated domain.

a) Let f be the maximum of $f(y)$. Then the procedure for generating random deviates is: (1) generate a pair of uniform deviates U_1, U_2 ; (2) compute a point $y = a + (b - a)u_2$ in (a, b) ; (3) if $u_1 < f(y)/f$ accept y as the random deviate, otherwise reject the pair (u_1, u_2) and start again. The acceptance ratio of deviates actually produced is $[(b - a)f]^{-1}$. Hence the acceptance ratio decreases as the domain increases. One way to increase the acceptance ratio is to divide the interval (a, b) into mutually exclusive sub-intervals and then carry out the acceptance-rejection process. For this purpose let the interval (a, b) be divided into k sub-intervals such that the end points of the j th interval are (ξ_{j-1}, ξ_j) with $\xi_0 = a, \xi_k = b$ and $\int_{\xi_{j-1}}^{\xi_j} f(y)dy = p_j$; further let the maximum of $f(y)$ in the j th interval be f_j . Then to generate random deviates from $f(y)$, generate n pairs of deviates $(u_{1s}, u_{2s}) s = 1, 2, \dots, n$. Assign $[np_j]$ such pairs to the j th interval and compute $y_j = \xi_{j-1} + (\xi_j - \xi_{j-1})u_{2s}$. If $u_{1s} < f(y_j)/f_j$ accept y_j as a deviate. The acceptance ratio of this method is

$$\sum_{j=1}^k p_j [(\xi_j - \xi_{j-1}) f_j]^{-1}$$

b) Let $F(y)$ be such that $f(y) = f_1(y)f_2(y)$ where the domain of y is (a, b) . Let f_1 and f_2 be the maximum of $f_1(y)$ and $f_2(y)$ respectively. Then the procedure for generating random de-

viates having the probability density function $f(y)$ is: (1) generate U_1, U_2, U_3 ; (2) define $z = a + (b - a)u_3$; (3) if both $u_1 < \frac{f_1(z)}{f_1}$ and $u_2 < \frac{f_2(z)}{f_2}$, take z as the random deviate; otherwise take another sample of three uniform deviates. The acceptance ratio of this method is $[(b - a)f_1f_2]^{-1}$ and can be increased by dividing (a, b) into sub-intervals as in the previous case.

c) Let the probability density function of Y be

$$f(y) = \int_{\alpha}^{\beta} g(y, t)dt, (\alpha \leq t \leq \beta), (a \leq y \leq b).$$

Let g be the maximum of $g(y, t)$. Then the procedure for generating random deviates having the probability density function $f(y)$ is: (1) generate U_1, U_2, U_3 ; (2) define $s = \alpha + (\beta - \alpha)u_2$; $z = a + (b - a)u_3$; (3) if $u_1 < \frac{g(z, s)}{g}$, take z as the random deviate; otherwise take another sample of three. The acceptance ratio for this method is $[(b - a)g]^{-1}$ and can be increased by dividing the domain of t and y into sub-domains.

5. Composition Method

Let $g_z(y)$ be a probability density function which depends on the parameter z ; further let $H(z)$ be the cumulative distribution function for z . In order to generate random deviates Y having the frequency function

$$f(y) = \int_{-\infty}^{\infty} g_z(y)dH(z)$$

one draws a deviate having the cumulative distribution function $H(z)$; then draws a second sample having the probability density function $g_z(y)$.

6. Generation of Random Deviates From Well Known Distributions

a. Normal distribution

(1) *Inverse method:* The inverse method depends on having a convenient approximation to the inverse function $x = P^{-1}(u)$ where

$$u = (2\pi)^{-1/2} \int_{-\infty}^x e^{-t^2/2} dt.$$

Two ways of performing this operation are to (i) use 26.2.23 with $t = \left(\ln \frac{1}{u^2}\right)^{1/2}$ or (ii) approximate $x = P^{-1}(u)$ piecewise using Chebyshev polynomials, see [26.54].

(2) *Sum of uniform deviates:* Let U_1, U_2, \dots, U_n be a sequence of n uniform deviates. Then

$$X_n = \left(\sum_{i=1}^n U_i - \frac{n}{2} \right) \left(\frac{n}{12} \right)^{-1/2}$$

will be distributed asymptotically as a normal random deviate. When $n=12$, the maximum errors made in the normal deviate are 9×10^{-3} for $|X| < 2$, 9×10^{-1} for $2 < |X| < 3$. An improvement can be made by taking a polynomial function of X_n (say)

$$X_n^* = X_n \sum_{s=0}^k a_{2s} X_n^{2s}$$

as the normal deviate where a_{2s} are suitable coefficients. These coefficients may be calculated using (say) Chebyshev polynomials or simply by making the asymptotic random deviate agree with the correct normal deviate at certain specified points. When $n=12$, the maximum error in the normal deviate is 8×10^{-4} using the coefficients

$$\begin{aligned} * a_0 &= 9.8746 & * a_6 &= (-7) - 5.102 \\ * a_2 &= (-3)3.9439 & * a_8 &= (-7)1.141 \\ * a_4 &= (-5)7.474 \end{aligned}$$

(3) *Direct method*: Generate a pair of uniform deviates (U_1, U_2) . Then

$$X_1 = (-2 \ln U_1)^{1/2} \cos 2\pi U_2,$$

$X_2 = (-2 \ln U_1)^{1/2} \sin 2\pi U_2$ will be a pair of independent normal random deviates with mean zero and unit variance. This procedure can be modified by calculating $\cos 2\pi U$ and $\sin 2\pi U$ using an acceptance rejection method; e.g., (1) generate (U_1, U_2) ; (2) if $(2U_1 - 1)^2 + (2U_2 - 1)^2 \leq 1$ generate a third uniform deviate U_3 , otherwise reject the pair and start over; (3) calculate $y_1 = (-\ln u_3)^{1/2} \frac{u_1^2 - u_2^2}{u_1^2 + u_2^2}$, $y_2 = \pm 2(-\ln u_3)^{1/2} \frac{u_1 u_2}{u_1^2 + u_2^2}$ (\pm random). Both y_1 and y_2 are the desired random deviates.

(4) *Acceptance-rejection method*: 1) Generate a pair of uniform deviates (U_1, U_2) ; 2) compute $x = -\ln u_1$; 3) if $e^{-1/2(x-1)^2} \geq u_2$ (or equivalently $(x-1)^2 \leq -2(\ln u_2)$) accept x , otherwise reject the

pair and start over. The quantity will be the required normal deviate with mean zero and unit variance.

b. Bivariate normal distribution

Let $\{X_1, X_2\}$ be a pair of independent normal deviates with mean zero and unit variance. Then $\{X_1, \rho X_1 + (1 - \rho^2)^{1/2} X_2\}$ represent a pair of deviates from a bivariate normal distribution with zero means, unit variances, and correlation coefficient ρ .

c. Exponential distribution

(1) *Inverse method*: Since $F(x) = e^{-x/\theta}$, $X = -\theta \ln U$ will be a deviate from the exponential distribution with parameter θ .

(2) *Acceptance-rejection method*: 1) Generate a pair of independent uniform deviates (U_0, U_1) ; 2) if $U_1 < U_0$ generate a third value U_2 ; 3) if $U_1 + U_2 < U_0$ generate a fourth value U_3 , etc.; 4) continue generating uniform deviates until an n is obtained such that $U_1 + U_2 + \dots + U_{n-1} < U_0 < U_1 + \dots + U_n$; 5) if n is even reject the procedure and start a fresh trial with a new value of U_0 , otherwise if n is odd take $X = \theta U_0$ as the desired deviate; 6) in general if t is the number of trials until an acceptable sequence is obtained $X = \theta(t + U_0)$. The random deviates produced in this way follow an exponential distribution with parameter θ . One can expect to generate approximately six uniform deviates for every exponential deviate.

(3) *Discrete Distribution Method*: Let Y and n be discrete random variables with point probabilities

$$* Pr\{Y=r\} = (e-1)e^{-(r+1)} \quad r=0, 1, 2, \dots$$

$$Pr\{n=s\} = [s!(e-1)]^{-1} \quad s=1, 2, 3, \dots$$

Then $X = Y + \min(U_1, U_2, \dots, U_n)$ will follow an exponential distribution. The average value of n is 1.58 so that one needs, on the average, only 1.58 u 's from which the minimum is selected.

26.9. Use and Extension of the Tables

Use of Probability Function Inequalities

Example 1. Let X be a random variable with finite mean and variance equal to m and σ^2 , respectively. Use the inequalities for probability functions 26.1.37, 40, 41 to place lower bounds on

$$A(t) = F(t) - F(-t) = P \left\{ \frac{|X-m|}{\sigma} \leq t \right\}$$

for $t=1(1)4$.

*See page 11.

Lower bounds on $A(t) = F(t) - F(-t)$				Remarks
$t=1$	2	3	4	
0	.7500	.8889	.9375	no knowledge of $F(t)$; 26.1.37
.5556	.8889	.9506	.9722	$F(t)$ is unimodal and continuous; 26.1.40
0	.8182	.9697	.9912	$F(t)$ is such that $\mu_4=3$; 26.1.41

It is of interest to note that the standard normal distribution is unimodal, has mean zero, unit variance $\mu_4=3$, is continuous, and such that

$$A(t) = P(t) - P(-t) = .6827, .9545, .9973, \text{ and } .9999$$

for $t=1, 2, 3$ and 4 respectively.

Interpolation for $P(x)$ in Table 26.1

Example 2. Compute $P(x)$ for $x=2.576$ to fifteen decimal places using a Taylor expansion.

Writing $x=x_0+\theta$ we have

$$P(x) = P(x_0) + Z(x_0)\theta + Z^{(1)}(x_0)\frac{\theta^2}{2!} + Z^{(2)}(x_0)\frac{\theta^3}{3!} + Z^{(3)}(x_0)\frac{\theta^4}{4!} + \dots$$

Taking $x_0=2.58$ and $\theta=-4 \times 10^{-3}$ we calculate the successive terms to 16D

+.99505	99842	42230		
-	5	72204	35976	6
-		2952	57449	6
-		8	63097	8
-			1439	4
-				9
.99500	24676	84265		7

The result correct to 17D is

$$P(2.576) = .99500 \quad 24676 \quad 84264 \quad 98$$

Calculation for Arbitrary Mean and Variance

Example 3. Find the value to 5D of

$$P\{X \leq .50\} = \frac{1}{2\sqrt{2\pi}} \int_{-\infty}^{.5} e^{-1/2(\frac{t-1}{2})^2} dt$$

using 26.2.8 and Table 26.1.

This represents the probability of the random variable being less than or equal to .5 for a normal distribution with mean $m=1$ and variance $\sigma^2=4$. Using 26.2.8 we have

$$P\{X \leq .5\} = P\left(\frac{.5-1}{2}\right) = P(-.25)$$

Since $P(-x) = 1 - P(x)$, we have

$$P(-.25) = 1 - P(.25) = 1 - .59871 = .40129$$

where a two-term Taylor series was used for interpolation. Note that when interpolating for $P(x)$ for a value of x midway between the tabulated

values we can write $x=x_0+.01$ and a two-term Taylor series is $P(x) = P(x_0) + Z(x_0)10^{-2}$. Thus one need only multiply $Z(x_0)$ by 10^{-2} and add the result to $P(x_0)$.

Calculation of $P(x)$ for x Approximate

Example 4. Using Table 26.1, find $P(x)$ for $x=1.96$, when there is a possible error in x of $\pm 5 \times 10^{-3}$.

This is an example where the argument is only known approximately. The question arises as to how many decimal places one should retain in $P(x)$. If Δx and $\Delta P(x)$ denote the error in x and the resulting error in $P(x)$, respectively, then

$$\Delta P(x) \approx Z(x)\Delta x$$

Hence $\Delta P(1.960) = 3 \times 10^{-4}$ which indicates that $P(1.960)$ need only be calculated to 4D. Therefore $P(1.960) = .9750$.

Inverse Interpolation for $P(x)$

Example 5. Find the value of x for which $P(x) = .97500 \quad 00000 \quad 00000$ using Table 26.1 and determining as many decimal places as is consistent with the tabulated function.

For inverse interpolation the tabulated function $P(x)$ may be regarded as having a possible error of $.5 \times 10^{-15}$. Hence

$$\Delta x \approx \frac{\Delta P(x)}{Z(x)} = \frac{.5 \times 10^{-15}}{Z(x)}$$

Let $P(x_0)$ correspond to the closest tabulated value of $P(x)$. Then a convenient formula for inverse interpolation is

$$x = x_0 + t + \frac{x_0 t^2}{2} + \frac{2x_0^2 + 1}{6} t^3$$

where

$$t = \frac{P(x) - P(x_0)}{Z(x_0)}$$

If only the first two terms (i.e., $x=x_0+t$) are used, the error in x will be bounded by $\frac{x}{8} \times 10^{-4}$ and the true value will always be greater than the value thus calculated.

With respect to this example, $\Delta x \approx 10^{-14}$ and thus the interpolated value of x may be in error by one unit in the fourteenth place. The closest value to $P(x) = .97500 \quad 00000 \quad 00000$ is $P(x_0) = .97500 \quad 21048 \quad 51780$ with $x_0=1.96$. Hence using the preceding inverse interpolation formulas with

$$t = -.00003 \ 60167 \ 31129$$

and carrying fifteen decimals we have the successive terms

+1.96000	00000	00000
- .00003	60167	31129
+	12	71261
-		68
		0
+1.95996	39845	40064

Edgeworth Asymptotic Expansion

Example 6. Find the Edgeworth asymptotic expansion 26.2.49 for the c.d.f. of chi-square.

Method 1. Expansion for χ^2

Let

$$Q(\chi^2|\nu) = 1 - F(t)$$

where

$$t = \frac{\chi^2 - \nu}{(2\nu)^{1/2}}$$

Since the values of γ_1 and γ_2 26.4.33 are

$$\gamma_1 = 2\sqrt{2/\nu^3}$$

$$\gamma_2 = 12/\nu$$

we obtain, by using the first two bracketed terms of 26.2.49

$$F(t) \sim P(t) - \frac{1}{\nu^3} \left[\frac{\sqrt{2}}{3} Z^{(2)}(t) \right] + \frac{1}{\nu} \left[\frac{1}{2} Z^{(3)}(t) + \frac{1}{9} Z^{(5)}(t) \right]$$

The Edgeworth expansion is an asymptotic expansion in terms of derivatives of the normal distribution function. It is often possible to transform a random variable so that the distribution of the transformed random variable more closely approximates the normal distribution function than does the distribution of the original random variable. Hence for the same number of terms, greater accuracy may be achieved by using the transformed variable in the expansion. Since the distribution of $\sqrt{2\chi^2}$ is more closely approximated by a normal distribution than χ^2 itself (as judged by a comparison of the values of γ_1 and γ_2), we would expect that the Edgeworth asymptotic expansion of $\sqrt{2\chi^2}$ would be superior to that of χ^2 .

Method 2. Expansion for $\sqrt{2\chi^2}$. Let

$$Q(\chi^2|\nu) = 1 - F(t) = 1 - F\left(\frac{\sqrt{2\chi^2} - (2\nu - 1)^{1/2}}{\left(1 - \frac{1}{4\nu}\right)^{1/2}}\right)$$

where $(2\nu - 1)^{1/2}$ and $1 - \frac{1}{4\nu}$ are the mean and variance to terms of order ν^{-2} of $\sqrt{2\chi^2}$ (see 26.4.34). The values of γ_1 and γ_2 for $\sqrt{2\chi^2}$ are

$$\gamma_1 \approx \frac{1}{\sqrt{2\nu}} \left[1 + \frac{5}{8\nu} \right] \quad \gamma_2 \approx \frac{3}{4\nu^2}$$

Thus we obtain

$$F(t) \sim P(t) - \frac{1}{\nu^3} \left[\frac{\sqrt{2}}{12} \left(1 + \frac{5}{8\nu} \right) Z^{(2)}(t) \right] + \frac{1}{\nu} \left[\frac{1}{32\nu} Z^{(3)}(t) + \frac{1}{144} \left(1 + \frac{5}{8\nu} \right)^2 Z^{(5)}(t) \right]$$

For numerical examples using these expansions see Example 12.

Calculation of $L(h, k, \rho)$

Example 7. Find $L(.5, .4, .8)$. Using 26.3.20

$$\sqrt{h^2 - 2\rho hk + k^2} = \sqrt{.09} = .3$$

$$L(.5, .4, .8) = L(.5, 0, 0) + L(.4, 0, -.6)$$

Reference to Figure 26.2 yields

$$L(.5, 0, 0) + L(.4, 0, -.6) = .16 + .08 = .24$$

The answer to 3D is $L(.5, .4, .8) = .250$.

Calculation of the Bivariate Normal Probability Function

Example 8. Let X and Y follow a bivariate normal distribution with parameters $m_x = 3$, $m_y = 2$, $\sigma_x = 4$, $\sigma_y = 2$, and $\rho = -.125$. Find the value of $P_r\{X \geq 2, Y \geq 4\}$ using 26.3.20 and Figures 26.2, 26.3.

Since $P_r\{X \geq h, Y \geq k\} = L\left(\frac{h - m_x}{\sigma_x}, \frac{k - m_y}{\sigma_y}, \rho\right)$ we have $P\{X \geq 2, Y \geq 4\} = L(-.25, 1, -.125)$. Using 26.3.20

$$L(-.25, 1, -.125) = L(-.25, 0, .969) + L(1, 0, .125) - \frac{1}{2}$$

Figure 26.2 only gives values for $h > 0$, however, using the relationship 26.3.3 with $k = 0$, $L(-h, 0, \rho) = \frac{1}{2} - L(h, 0, -\rho)$ and thus $L(-.25, 0, .969) = \frac{1}{2} - L(.25, 0, -.969)$. Therefore $L(-.25, 1, -.125) = -L(.25, 0, -.969) + L(1, 0, .125) = -.01 + .09 = .08$. The answer to 3D is $L(-.25, 1, -.125) = .080$.

Integral of a Bivariate Normal Distribution Over a Polygon

Example 9. Let the random variables X and Y have a bivariate normal distribution with parameters $m_x=5$, $\sigma_x=2$, $m_y=9$, $\sigma_y=4$, and $\rho=.5$. Find the probability that the point (X, Y) be inside the triangle whose vertices are $A=(7, 8)$, $B=(9, 13)$, and $C=(2, 9)$.

When obtaining the integral of a bivariate normal distribution over a polygon, it is first necessary to use 26.3.22 in order to transform the variates so that one deals with a circular normal distribution. The polygon in the region of the transformed variables is then divided into configurations such that the integral over any selected configuration can be easily obtained. Below are listed some of the most useful configurations.

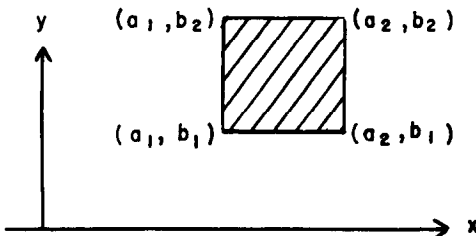

FIGURE 26.5

$$\int_{a_1}^{a_2} \int_{b_1}^{b_2} g(x, y, 0) dx dy = [P(a_2) - P(a_1)][P(b_2) - P(b_1)]$$

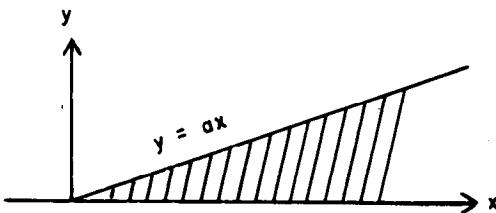

FIGURE 26.6

$$\int_0^\infty \int_0^{ax} g(x, y, 0) dx dy = \frac{\arctan a}{2\pi}$$

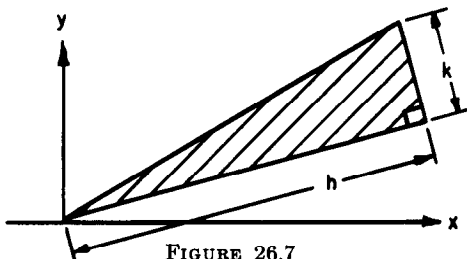

FIGURE 26.7

$$\int_0^h \int_0^{\frac{k}{h}x} g(x, y, 0) dx dy = V(h, k)^{11}$$

¹¹ See 26.3.23 for definition of $V(h, k)$.

For the following two configurations we define

$$h = \frac{|t_2 s_1 - t_1 s_2|}{[(s_2 - s_1)^2 + (t_2 - t_1)^2]^{\frac{1}{2}}}$$

$$k_1 = \frac{|s_1(s_2 - s_1) + t_1(t_2 - t_1)|}{[(s_2 - s_1)^2 + (t_2 - t_1)^2]^{\frac{1}{2}}}$$

$$k_2 = \frac{|s_2(s_2 - s_1) + t_2(t_2 - t_1)|}{[(s_2 - s_1)^2 + (t_2 - t_1)^2]^{\frac{1}{2}}}$$

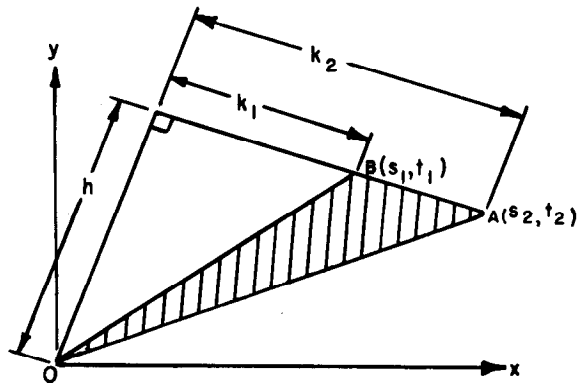

FIGURE 26.8

$$\iint_{\Delta AOB} g(x, y, 0) dx dy = V(h, k_2) - V(h, k_1)$$

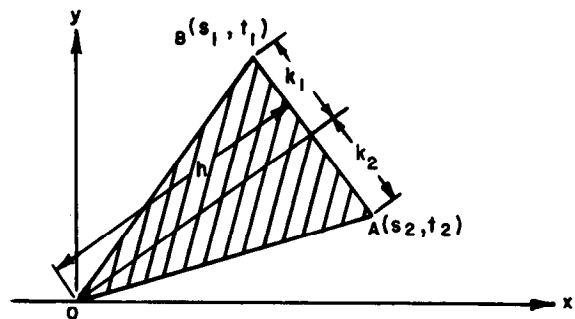

FIGURE 26.9

$$\iint_{\Delta AOB} g(x, y, 0) dx dy = V(h, k_2) + V(h, k_1)$$

Using the circularizing transformation 26.3.22 for our example results in

$$s = \frac{1}{\sqrt{3}} \left(\frac{x-5}{2} + \frac{y-9}{4} \right)$$

$$t = -\frac{1}{1} \left(\frac{x-5}{2} - \frac{y-9}{4} \right)$$

The vertices of the triangle in the (s, t) coordinates become $A=(\sqrt{3}/4, -5/4)$, $B=(\sqrt{3}, -1)$ and $C=(-\sqrt{3}/2, 3/2)$. These points are plotted below. From the figure it is seen that the desired probability is the sum of the probabilities that the point having the transformed variables as coordinates is inside the triangles AOB , AOC , and BOC .

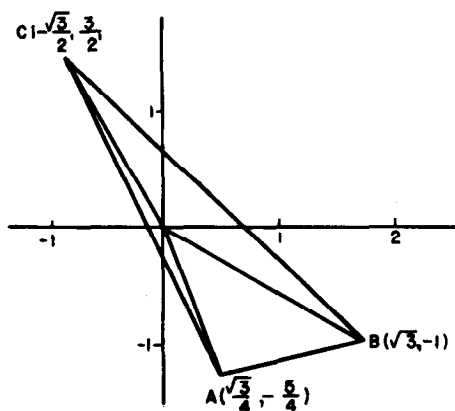

FIGURE 26.10

For these three triangles we have

	h	k_1	k_2
ΔAOB	$\frac{2}{7}\sqrt{21}$	$\sqrt{7}/14$	$\frac{4}{7}\sqrt{7}$
ΔAOC	$\frac{1}{74}\sqrt{111}$	$\frac{8}{37}\sqrt{37}$	$\frac{21}{74}\sqrt{37}$
ΔBOC	$\frac{1}{13}\sqrt{39}$	$\frac{7}{13}\sqrt{13}$	$\frac{6}{13}\sqrt{13}$

From the graph it is seen that the probability over AOB may be found in the same manner as that over Figure 26.8, and over AOC and BOC the probabilities may be found as that over Figure 26.9.

Hence

$$\begin{aligned} \iint_{\Delta} g(x, y, .5) dx dy &= \iint_{\Delta ABC} g(s, t, 0) ds dt \\ &= \iint_{\Delta AOB} g(s, t, 0) ds dt + \iint_{\Delta AOC} g(s, t, 0) ds dt \\ &\quad + \iint_{\Delta BOC} g(s, t, 0) ds dt \end{aligned}$$

and consequently using 26.3.23 and Figure 26.2

$$\begin{aligned} \iint_{\Delta AOB} g(s, t, 0) ds dt &= V\left(\frac{2}{7}\sqrt{21}, \frac{4\sqrt{7}}{7}\right) - V\left(\frac{2}{7}\sqrt{21}, \frac{\sqrt{7}}{14}\right) \\ &= \left[\frac{1}{4} + L(1.31, 0, -.76) - L(0, 0, -.76) - \frac{1}{2} Q(1.31)\right] \\ &\quad - \left[\frac{1}{4} + L(1.31, 0, -.14) - L(0, 0, -.14) - \frac{1}{2} Q(1.31)\right] \\ &= L(1.31, 0, -.76) - L(0, 0, -.76) \\ &\quad - L(1.31, 0, -.14) + L(0, 0, -.14) \\ &= .00 - .11 - .04 + .23 = .08 \end{aligned}$$

$$\begin{aligned} \iint_{\Delta AOC} g(s, t, 0) ds dt &= V\left(\frac{\sqrt{111}}{74}, \frac{8\sqrt{37}}{37}\right) + V\left(\frac{\sqrt{111}}{74}, \frac{21\sqrt{37}}{74}\right) \\ &= \left[\frac{1}{4} + L(.14, 0, -.99) - L(0, 0, -.99) - \frac{1}{2} Q(.14)\right] \\ &\quad + \left[\frac{1}{4} + L(.14, 0, -1) - L(0, 0, -1) - \frac{1}{2} Q(.14)\right] \\ &= .01 + .02 = .03 \end{aligned}$$

$$\begin{aligned} \iint_{\Delta BOC} g(s, t, 0) ds dt &= V\left(\frac{\sqrt{39}}{13}, \frac{7\sqrt{13}}{13}\right) + V\left(\frac{\sqrt{39}}{13}, \frac{6\sqrt{13}}{13}\right) \\ &= \left[\frac{1}{4} + L(.48, 0, -.97) - L(0, 0, -.97) - \frac{1}{2} Q(.48)\right] \\ &\quad + \left[\frac{1}{4} + L(.48, 0, -.96) - L(0, 0, -.96) - \frac{1}{2} Q(.48)\right] \\ &= .05 + .04 = .09 \end{aligned}$$

Thus adding all parts, the probability that X and Y are in triangle ABC is $=.08 + .03 + .09 = .20$. The answer to 3D is .211.

Calculation of a Circular Normal Distribution Over an Offset Circle

Example 10. Let X and Y have a circular normal distribution with $\sigma=1000$. Find the probability that the point (X, Y) falls within a circle having a radius equal to 540 whose center is displaced 1210 from the mean of the circular normal distribution.

In units of σ , the radius and displacement from the center are, respectively, $R = \frac{540}{1000} = .54$ and $r = \frac{1210}{1000} = 1.21$. The problem is thus reduced to finding the probability of X and Y falling in a circle of radius $R = .54$ displaced $r = 1.21$ from the center of the distribution where $\sigma = 1$.

Since $R < 1$, the approximation 26.3.25 is used. This results in

$$P(R^2|2, r^2) = \frac{2(.54)^2}{4 + (.54)^2} \exp \frac{-2(1.21)^2}{4 + (.54)^2} = (.1359)e^{-.6823} = .06869$$

The answer to 5D is .06870.

Interpolation for $Q(x^2|\nu)$

Example 11. Find $Q(25.298|20)$ using the interpolation formula given with Table 26.7.

Taking $x^2 = 25$, $\theta = .298$ and applying the interpolation formula results in

$$\begin{aligned} Q(25.298|20) &= \frac{1}{8} \{ Q(25|16)\theta^2 + Q(25|18)(4\theta - 2\theta^2) \\ &\quad + Q(25|20)(8 - 4\theta + \theta^2) \} \\ &= \frac{1}{8} \{ (.06982)(.088804) \\ &\quad + (.12492)(1.014392) \\ &\quad + (.20143)(6.896804) \} \\ &= .19027 \end{aligned}$$

A less accurate interpolate may be obtained by setting θ^2 equal to zero in the above formula. This results in the value .19003. The correct value to 6D is $Q(25.298|20) = .190259$.

On the other hand if $x^2 = 25.298$ is assumed to have an error of $\pm 5 \times 10^{-4}$, then how large an error arises in $Q(x^2|\nu)$? Denoting the error in x^2 by Δx^2 and the resulting error in $Q(x^2|\nu)$ by $\Delta Q(x^2|\nu)$, we then have the approximate relationship

$$\Delta Q(x^2|\nu) \approx \frac{\partial Q(x^2|\nu)}{\partial x^2} \Delta x^2$$

Using 26.4.8 we can write

$$\frac{\partial Q(x^2|\nu)}{\partial x^2} = \frac{1}{2} [Q(x^2|\nu - 2) - Q(x^2|\nu)]$$

and

$$\Delta Q(x^2|\nu) \approx \frac{1}{2} [Q(x^2|\nu - 2) - Q(x^2|\nu)] \Delta x^2$$

For practical purposes it is sufficient to evaluate the derivative to one or two significant figures. Consequently we can write

$$\frac{\partial Q(x^2|\nu)}{\partial x^2} \approx \frac{\partial Q(x_0^2|\nu)}{\partial x^2}$$

where x_0^2 is the closest value to x^2 for which Q is tabulated. Hence

$$\Delta Q(x^2|\nu) \approx \frac{1}{2} [Q(x_0^2|\nu - 2) - Q(x_0^2|\nu)] \Delta x^2$$

For this example $\Delta x^2 = \pm 5 \times 10^{-4}$ and $x_0^2 = 25$. This results in

$$\Delta Q(x^2|\nu) = \frac{1}{2} (-.076)(\pm 5)10^{-4} = \pm 2 \times 10^{-5}$$

as the possible error in $Q(x^2|\nu)$.

Calculation of $Q(x^2|\nu)$ Outside the Range of Table 26.7

Example 12. Find the value of $Q(84|72)$.

Since this value is outside the range of Table 26.7 we can approximate $Q(84|72)$ by (1) using the Edgeworth expansion for $Q(x^2|\nu)$ given in Example 6, (2) the cube root approximation 26.4.14, (3) the improved cube root approximation 26.4.15 or (4) the square root approximation 26.4.13. The results of using all four methods are presented below:

1. Edgeworth expansion

The successive terms of the Edgeworth expansion for the distribution of chi-square result in

$$\begin{aligned} 1 - Q(84|72) &= .841345 \\ &\quad .000000 \\ &\quad .001120 \\ &\quad \hline &= .842465 \end{aligned}$$

Hence $Q(84|72) = .15754$.

The successive terms of the Edgeworth expansion for the distribution of $\sqrt{2}x^2$ result in

$$\begin{aligned} 1 - Q(84|72) &= .842544 \\ &\quad - .000034 \\ &\quad - .000138 \\ &\quad \hline &= .842372 \end{aligned}$$

Hence $Q(84|72) = .15764$.

2. Cube root approximation 26.4.14

Using the cube root approximation we have

$$Q(84|72) = Q(x)$$

where

$$x = \frac{\left(\frac{84}{72}\right)^{1/3} \left[1 - \frac{2}{9(72)}\right]}{\left[\frac{2}{9(72)}\right]^{1/2}} = 1.0046$$

This results in $Q(84|72) = Q(1.0046) = 1 - P(1.0046) = .15754$.

3. Improved cube root approximation 26.4.15

The improved cube root approximation involves calculating a correction factor h_ν to x . Linearly interpolating for h_{80} (which appears below 26.4.15) with $x = 1.0046$ results in $h_{80} = -.0006$ and hence

$$h_{72} = \frac{60}{72}(-.0006) = -.00049$$

Thus

$$Q(84|72) = Q(1.0046 - .0005) = Q(1.0041) \\ = 1 - P(1.0041) = .15766$$

4. Square root approximation 26.4.13

Using the square root approximation we have $Q(84|72) = Q(x)$ where

$$x = \sqrt{2(84)} - \sqrt{2(72) - 1} = 1.0032.$$

This results in

$$Q(84|72) = Q(1.0032) = 1 - P(1.0032) = .15788$$

The value correct to 6D is $Q(84|72) = .157653$. Generally the improved cube root approximation will be correct with a maximum error of a few units in the fifth decimal and is recommended for calculations which are outside the range of **Table 26.7**.

Calculation of χ^2 for $Q(\chi^2|\nu)$ Outside the Range of **Table 26.8**

Example 13. Find the value of χ^2 for which $Q(\chi^2|144) = .01$.

Since $\nu = 144$ is outside the range of **Table 26.8**, we can compute it by using (1) the Cornish-Fisher asymptotic expansion **26.2.50**, for χ^2 , (2) the cube approximation **26.4.17**, (3) the improved cube approximation **26.4.18**, or (4) the square approximation **26.4.16**. We shall compute the value by all four methods.

1. Cornish-Fisher asymptotic expansion 26.2.50

The Cornish-Fisher asymptotic expansion for χ^2 with $\nu = 144$ can be written as

$$\chi^2 \sim 144 + 12\sqrt{2}x + 4h_1(x) + \frac{4\sqrt{2}}{12}[3h_2(x) + 2h_{11}(x)] \\ + \frac{8}{12^2}[6h_3(x) + 3h_{12}(x) + 2h_{111}(x)] + \frac{16\sqrt{2}}{12^3}[30h_4(x) \\ + 9h_{22}(x) + 12h_{13}(x) + 6h_{112}(x) + 4h_{1111}(x)]$$

Hence using the auxiliary table following **26.2.51** with $p = .01$ we have

144. 0000
39. 4794
2. 9413
-. 0242
-. 0019
+. 0002

$\chi^2 = 186. 395$

2. Cube approximation 26.4.17

Taking $\chi_{.01} = 2.32635$ we have

$$\chi^2 = 144 \left\{ \left[1 - \frac{2}{9(144)} \right] + (2.32635) \sqrt{\frac{2}{9(144)}} \right\}^3 = 186.405$$

3. Improved cube approximation 26.4.18

From the table for h_{60} we obtain using linear interpolation with $x = 2.33$ (approximately)

$$h_{60} = .0012 \text{ and thus } h_{144} = \frac{60}{144}(.0012) = .00049$$

Hence

$$\chi^2 = 144 \left[1 - \frac{2}{9(144)} + (2.32635 - .00049) \sqrt{\frac{2}{9(144)}} \right]^3 = 186.394$$

4. Square approximation 26.4.16

$$\chi^2 = \frac{1}{2} [2.32635 + \sqrt{2(144) - 1}]^2 = 185.616$$

The correct answer to 3D is $\chi^2 = 186.394$. Generally the improved cube approximation will give results correct in the second or third decimal for $\nu > 30$.

Calculation of the Incomplete Gamma Function

Example 14. Find the value of

$$\gamma(2.5, .9) = \int_0^9 t^{1.5} e^{-t} dt$$

making use of **26.4.19** and **Table 26.7**.

Using **26.4.19** we have

$$\gamma(2.5, .9) = \Gamma(2.5)P(1.8|5) = \Gamma(2.5)[1 - Q(1.8|5)]$$

$$\gamma(2.5, .9) = \frac{3}{4} \sqrt{\pi} [1 - .87607] = .16475$$

Poisson Distribution

Example 15. Find the value of m for which

$$\sum_{i=0}^3 e^{-m} \frac{m^i}{i!} = .99$$

using **26.4.21** and **Table 26.8**.

From **Table 26.8** with $\nu = 2c = 8$ and $Q = .99$ we have $\chi^2 = 1.646482$. Hence $m = \chi^2/2 = .823241$.

Inverse of the Incomplete Beta Function

Example 16. Find the value of x for which $I_x(10, 6) = .10$ using **Table 26.9** and **26.5.28**. *
Using **26.5.28** we have

*See page II.

$$I_z(10, 6) = Q(F|12, 20) = .10 \text{ where } x = \frac{20}{20+12F}$$

From **Table 26.9** the upper 10 percent point of F with 12 and 20 degrees of freedom is $F=1.89$. Hence

$$x = \frac{20}{20+12(1.89)} = .469$$

The correct value to 4D is $x=.4683$.

Calculation of $I_z(a, b)$ for a or b Small Integers

Example 17. Calculate $I_{.10}(3, 20)$.

Values of $I_z(a, b)$ for small integral a or b can conveniently be calculated using **26.5.6** or **26.5.7**. Using **26.5.6** we have

$$1 - I_{.90}(20, 3) = \frac{(.9)^{20}}{B(3, 20)} \left\{ \sum_{i=0}^2 (-1)^i \binom{2}{i} \frac{.9^i}{20+i} \right\}$$

$$= \frac{.121576}{.216450 \times 10^{-3}} (.110390 \times 10^{-2}) = .620040$$

Binomial Distribution

Example 18. Find the value of p which satisfies

$$\sum_{s=0}^{20} \binom{50}{s} p^s q^{50-s} = .95, \quad q = 1 - p$$

using **26.5.24** and **Table 26.9**.

* Combining **26.5.24** and **26.5.28** we have

$$\sum_{s=a}^n \binom{n}{s} p^s q^{n-s} = Q(F|v_1, v_2)$$

where

$$v_1 = 2(n - a + 1), v_2 = 2(a), \text{ and } p = \frac{a}{a + (n - a + 1)F}$$

Hence

$$\sum_{s=0}^{20} \binom{50}{s} p^s q^{50-s} = 1 - \sum_{s=21}^{50} \binom{50}{s} p^s q^{50-s}$$

$$= 1 - Q(F|60, 42) = .95$$

Harmonic interpolation on v_2 in the table for which $Q(F|v_1, v_2) = .05$ results in $F=1.624$ for $v_1=60, v_2=42$, and thus $p = \frac{42}{42+60(1.624)} = .301$.

The correct answer to 4D is $p = .3003$.

Approximating the Incomplete Beta Function

Example 19. Find $I_{.60}(16, 10.5)$ using **26.5.21**.

Values of $I_z(a, b)$ can conveniently be calculated with good accuracy using the approximation given by **26.5.20** or **26.5.21**. For this example $(a+b-1)(1-x) = 10.20$ which is greater than .8 and hence **26.5.21** will be used. Thus

$$w_1 = [(10.5)(.60)]^{1/3} = 1.8469, w_2 = [16(.4)]^{1/3} = 1.8566$$

$$y = \frac{3[(1.8469)(.98942) - (1.8566)(.99306)]}{\left[\frac{(1.8469)^2}{10.5} + \frac{(1.8566)^2}{16} \right]^{3/2}} = -.0668$$

and interpolating in **Table 26.1** gives

$$P(-.0668) = 1 - P(.0668) = .47336$$

The answer correct to 5D is $I_{.60}(16, 10.5) = .47332$.

Interpolation for F in Table 26.9

Example 20. Find the value of F for which

$$Q(F|7, 20) = .05 \text{ using Table 26.9.}$$

Interpolation in **Table 26.9** is approximately linear when the reciprocals of the degrees of freedom (v_1, v_2) are used as the interpolating variable. For this example it is only necessary to interpolate with respect to $1/v_1$. Thus linear interpolation on $1/v_1$ results in $F=2.51$ which is the correct interpolate.

Calculation of F for $Q(F|v_1, v_2) > .50$

Example 21. Find the value of F for which $Q(F|4, 8) = .90$ using **26.6.9** and **Table 26.9**.

Table 26.9 only tabulates values of F for which $Q(F|v_1, v_2) = p$ where $p = .500, .250, .100, .050, .025, .010, .005, .001$. However making use of **Table 26.9** we can find the values of F_p for which $p = .75, .9, .95, .975, .99, .995, .999$. For this example we have

$$F_{.90}(4, 8) = \frac{1}{F_{.10}(8, 4)}$$

and referring to the table for which $Q(F|v_1, v_2) = .10$ gives $F_{.10}(8, 4) = 3.95$ and thus $F_{.90}(4, 8) = \frac{1}{3.95} = .253$.

Calculation of $Q(F|v_1, v_2)$ for Small Integral v_1 or v_2

Example 22. Compute $Q(2.5|4, 15)$ using **26.6.4**.

Values of $Q(F|v_1, v_2)$ can be readily computed for small v_1 or v_2 using the expansions **26.6.4** to **26.6.8** inclusive. We have using **26.6.4**

$$x = \frac{15}{15+4(2.50)} = .60$$

and

$$Q(2.50|4, 15) = (.6)^{7.5} \left[1 + \frac{15}{2} (.4) \right] = .086735$$

*See page 11.

Approximating $Q(F|\nu_1, \nu_2)$

Example 23. Calculate $Q(1.714|10, 40)$ using 26.6.15.

The approximation given by 26.6.15 will result in a maximum error of .0005. For this example we have

$$x = \frac{(1.714)^{1/3} \left(1 - \frac{2}{9(40)}\right) - \left(1 - \frac{2}{9(10)}\right)}{\left[\frac{2}{9(10)} + (1.714)^{2/3} \frac{2}{9(40)}\right]^{1/2}} = 1.2222$$

Interpolating in Table 26.1 results in

$$Q(1.714|10, 40) \approx Q(1.2222) = 1 - P(1.2222) = .1108$$

The correct value to 5D is $Q(1.714|10, 40) = .11108$.

On the other hand the approximation given by 26.6.14 which is usually less accurate results in

$$x = \frac{\sqrt{[2(40) - 1] \left(\frac{10}{40}\right) (1.714) - \sqrt{2(10) - 1}}}{\sqrt{1 + \frac{10}{40} (1.714)}} = 1.2210$$

and interpolating in Table 26.1 gives

$$Q(1.714|10, 40) \approx Q(1.2210) = 1 - P(1.2210) = .1112$$

Calculation of F Outside the Range of Table 26.9

Example 24. Find the value of F for which $Q(F|10, 20) \approx .0001$ using 26.6.16 and 26.5.22.

For this problem we have $a = \frac{\nu_2}{2} = 10$, $b = \frac{\nu_1}{2} = 5$, $p = .0001$. The value of the normal deviate which cuts off .0001 in the tail of the distribution is

$y = 3.7190$ (i.e., $Q(3.7190) = .0001$). Hence substituting in 26.5.22 gives

$$h = 2 \left[\frac{1}{19} + \frac{1}{9} \right]^{-1} = 12.2143$$

$$\lambda = \frac{3.7190^2 - 3}{6} = 1.8052$$

$$w = 3.7190 \frac{(12.2143 + 1.8052)^{1/2}}{12.2143}$$

$$- \left(\frac{1}{9} - \frac{1}{19} \right) \left[1.8052 + .8333 - \frac{2}{3(12.2143)} \right]$$

$$w = .9889$$

and thus $F \approx e^{2w} = 7.23$. The correct answer is $F = 7.180$.

Approximating the Non-Central F -Distribution

Example 25. Compute $P(3.71|3, 10, 4)$ using the approximation 26.6.27 to the non-central F -distribution.

Using 26.6.27 with $\nu_1 = 3$, $\nu_2 = 10$, $\lambda = 4$, $F' = 3.71$ we have

$$x = \frac{\left[\left(\frac{3}{3+4} \right) (3.71) \right]^{1/3} \left[1 - \frac{2}{9(10)} \right] - \left[1 - \frac{2(3+8)}{9(3+4)^2} \right]}{\left[\frac{2}{9} \frac{3+8}{(3+4)^2} + \frac{2}{9(10)} \left[\left(\frac{3}{3+4} \right) (3.71) \right]^{2/3} \right]^{1/2}} = .675$$

and interpolating in Table 26.1 gives

$$P(3.71|3, 10, 4) \approx P(.675) = .750$$

The exact answer is $P(3.71|3, 10, 4) = .745$.

References

Texts

[26.1] H. Cramér, *Mathematical methods of statistics* (Princeton Univ. Press, Princeton, N.J., 1951).
 [26.2] A. Erdélyi et al., *Higher transcendental functions*, vols. I, II, III. (McGraw-Hill Book Co., Inc., New York, N.Y., 1955).
 [26.3] W. Feller, *Probability theory and its applications*, 2d ed. (John Wiley & Sons, Inc., New York, N.Y., 1957).
 [26.4] R. A. Fisher, *Contributions to mathematical statistics*, Paper 30 (with E. A. Cornish), *Moments and cumulants in the specification of distributions* (John Wiley & Sons, Inc., New York, N.Y., 1950).
 [26.5] C. Hastings, Jr., *Approximations for digital computers* (Princeton Univ. Press, Princeton, N.J., 1955).
 [26.6] M. G. Kendall and A. Stuart, *The advanced theory of statistics*, vol. I, *Distribution theory* (Charles Griffin and Co. Ltd., London, England, 1958).

Tables

General Collections

[26.7] R. A. Fisher and F. Yates, *Statistical tables for biological, agricultural and medical research* (Oliver and Boyd, London, England, 1949).
 [26.8] J. Arthur Greenwood and H. O. Hartley, *Guide to tables in mathematical statistics* (Princeton Univ. Press, Princeton, N.J., 1962). (Catalogues a large selection of tables used in mathematical statistics).
 [26.9] A. Hald, *Statistical tables and formulas* (John Wiley & Sons, Inc., New York, N.Y., 1952).
 [26.10] D. B. Owen, *Handbook of statistical tables* (Addison-Wesley Publishing Co., Inc., Reading, Mass., 1962).
 [26.11] E. S. Pearson and H. O. Hartley (Editors). *Biometrika tables for statisticians*, vol. I (Cambridge Univ. Press, Cambridge, England, 1954).

[26.12] K. Pearson (Editor), Tables for statisticians and biometricians, parts I and II (Cambridge Univ. Press, Cambridge, England, 1914, 1931).

Normal Probability Integral and Derivatives

[26.13] J. R. Airey, Table of Hh functions, British Association for the Advancement of Science, Mathematical Tables I (Cambridge Univ. Press, Cambridge, England, 1931).

[26.14] Harvard University, Tables of the error function and of its first twenty derivatives (Harvard Univ. Press, Cambridge, Mass., 1952). $P(x) - \frac{1}{2}$, $Z(x)$, $Z^{(n)}(x)$, $n=1(1)4$ for $x=0(.004)$ 6.468, 6D; $Z^{(n)}(x)$, $n=5(1)10$ for $x=0(.004)$ 8.236, 6D; $Z^{(n)}(x)$, $n=11(1)15$ for $x=0(.002)$ 9.61, 7S; $Z^{(n)}(x)$, $n=16(1)20$ for $x=0(.002)$ 10.902, 7S or 6D.

[26.15] T. L. Kelley, The Kelley Statistical Tables (Harvard Univ. Press, Cambridge, Mass., 1948). x for $P(x)=.5(.0001)$.9999 and corresponding values of $Z(x)$, 8D.

[26.16] National Bureau of Standards, A guide to tables of the normal probability integral, Applied Math. Series 21 (U.S. Government Printing Office, Washington, D.C., 1951).

[26.17] National Bureau of Standards, Tables of normal probability functions, Applied Math. Series 23 (U.S. Government Printing Office, Washington, D.C., 1953). $Z(x)$ and $A(x)$ for $x=0(.0001)$ 1(.001)7.8, 15D; $Z(x)$ and $2[1-P(x)]$ for $x=6(.01)10$, 7S.

[26.18] W. F. Sheppard, The probability integral, British Association for the Advancement of Science, Mathematical Tables VII (Cambridge Univ. Press, Cambridge, England, 1939). $A(x)/Z(x)$ for $x=0(.01)10$, 12D; $x=0(.1)10$, 24D.

Bivariate Normal Probability Integral

[26.19] Bell Aircraft Corporation, Table of circular normal probabilities, Report No. 02-949-106 (1956). Tabulates the integral of the circular normal distribution over an off-set circle having its center a distance r from the origin with radius R ; $R=0(.01)4.59$, $r=0(.01)3$, 5D.

[26.20] National Bureau of Standards, Tables of the bivariate normal distribution function and related functions, Applied Math. Series 50 (U.S. Government Printing Office, Washington, D.C., 1959). $L(h, k, \rho)$ for $h, k=0(.1)4$, $\rho=0(.05).95(.01)1$, 6D; $L(h, k, -\rho)$ for $h, k=0(.1)A$, $\rho=0(.05).95(.01)1$ where A is such that $L < .5 \cdot 10^{-7}$, 7D; $V(h, ah)$ for $h=0(.01)4(.02)4.6(1)5.6$, ∞ , 7D; $V(ah, h)$ for $a=.1(.1)1$, $h=0(.01)4(.02)5.6$, ∞ , 7D.

[26.21] C. Nicholson, The probability integral for two variables, Biometrika 33, 59-72 (1943). $V(h, ah)$ for $h=.1(.1)3$, $ah=.1(.1)3$, ∞ , 6D.

[26.22] D. B. Owen, Tables for computing bivariate normal probabilities, Ann. Math. Statist. 27, 1075-1090 (1956). $T(h, a) = \frac{1}{2\pi} \arctan a - V(h, ah)$ for $a=.25(.25)1$, $h=0(.01)2(.02)3$; $a=0(.01)1$, ∞ , $h=0(.25)3$; $a=.1, .2(.05).5(1).8, 1, \infty$, $h=3(.05)3.5(1)4.7$, 6D.

[26.23] D. B. Owen, The bivariate normal probability function, Office of Technical Services, U.S. Department of Commerce (1957). $T(h, a) = \frac{1}{2\pi} \arctan a - V(h, ah)$ for $a=0(.025)1, \infty$; $h=0(.01)3.5(.05)4.75$, 6D.

[26.24] Tables VIII and IX, Part II of [26.12]. $L(h, k, \rho)$ for $h, k=0(.1)2.6$, $\rho=-1(.05)1$, 6D for $\rho > 0$ and 7D for $\rho < 0$.

Chi-Square, Non-Central Chi-Square, Probability Integral, Incomplete Gamma Function, Poisson Distribution

[26.25] G. A. Campbell, Probability curves showing Poisson's exponential summation, Bell System Technical Journal, 95-113 (1923). Tabulates values of $m = \frac{\chi^2}{2}$ for which $Q(\chi^2|\nu) = .000001$, 2D; .0001, .01, 3D; .1, .25, .5, .75, .9, 4D; .99, .9999, 3D; .999999, 2D for $c = \frac{\nu}{2} = 1(1)101$.

[26.26] Table IV of [26.7]. Tabulates values of χ^2 for $Q(\chi^2|\nu) = .001, .01, .02, .05, .1, .2, .3, .5, .7, .8, .9, .95, .98, .99$ and $\nu = 1(1)30$, 3D or 3S.

[26.27] E. Fix, Tables of noncentral χ^2 , Univ. of California Publications in Statistics 1, 15-19 (1949). Tabulates λ for $P(\chi^2|\nu, \lambda) = .1(.1).9$, $Q(\chi^2|\nu) = .01, .05$; $\nu = 1(1)20(2)40(5)60(10)100$, 3D or 3S.

[26.28] H. O. Hartley and E. S. Pearson, Tables of the χ^2 integral and of the cumulative Poisson distribution, Biometrika 37, 313-325 (1950). Also reproduced as Table 7 in [26.11]. $P(\chi^2|\nu)$ for $\nu = 1(1)20(2)70$, $\chi^2 = 0(.001).01(.01).1(.1)2(.2)10(.5)20(1)40(2)134$, 5D.

[26.29] T. Kitagawa, Tables of Poisson distribution (Baifukan, Tokyo, Japan, 1951). $e^{-mm^s}/s!$ for $m = .001(.001)1(.01)5$, 8D; $m = 5(.01)10$, 7D.

[26.30] E. C. Molina, Poisson's exponential binomial limit (D. Van Nostrand Co., Inc., New York, N.Y., 1940). $e^{-mm^s}/s!$ and $P(\chi^2|\nu) = \sum_{j=c}^{\infty} e^{-mm^j}/j!$ for $m = \chi^2/2 = 0(.1)16(1)100$, 6D; $m = 0(.001).01(.01)3$, 7D.

[26.31] K. Pearson (Editor), Tables of the incomplete Γ -function, Biometrika Office, University College (Cambridge Univ. Press, Cambridge, England, 1934). $I(u, p)$ for $p = -1(.05)0(.1)5(.2)50$, $u = 0(.1)$ $I(u, p) = 1$ to 7D; $p = -1(.01) -.75$, $u = 0(.1)6$, 5D; $\ln[I(u, p)]u^{p+1}$, $p = -1(.05)0(.1)10$, $u = 0(.1)1.5$, 8D; $[x^{p+1} \Gamma(p+1)]^{-1} \gamma(p, x)$, $p = -1(.01) -.9$, $x = 0(.01)3$, 7D.

[26.32] E. E. Sluckii, Tablitsy dlya vychisleniya nepolno Γ -funktsii i funktsii veroyatnosti χ^2 . (Izdat. Akad. Nauk SSSR, Moscow-Leningrad, U.S.S.R., 1950). $\Gamma(\chi^2, \nu) = \left(\frac{1}{2} \chi^2\right)^{-\nu/2} P(\chi^2|\nu)$, $\mathcal{P}(t, \nu) = Q(\chi^2|\nu)$, $\Pi(t, x) = Q(\chi^2|\nu)$ where $t = (2\chi^2)^{1/2} - (2\nu)^{1/2}$, $x = (\nu/2)^{-1/2}$. $\Gamma(\chi^2, \nu)$, $\chi^2 = 0(.05)2(.1)10$, $\nu = 0(.05)2(.1)6$; $Q(\chi^2|\nu)$, $\chi^2 = 0(.1)3.2$, $\nu = 0(.05)2(.1)6$; $\chi^2 = 3.2(.2)7(.5)10(1)35$, $\nu = 0(.1).4(.2)6$; $\mathcal{P}(t, \nu)$, $t = -4(.1)4.8$, $\nu = 6(.5)11(1)32$; $\Pi(t, x)$: $t = -4.5(.1)4.8$, $x = 0(.02).22(.01).25$, 5D.

Incomplete Beta Function, Binomial Distribution

- [26.33] Harvard University, Tables of the cumulative binomial probability distribution (Harvard Univ. Press, Cambridge, Mass., 1955).

$$\sum_{s=c}^n \binom{n}{s} p^s (1-p)^{n-s}$$
 for $p = .01(.01).5, 1/16, 1/12, 1/8, 1/6, 3/16, 5/16, 1/3, 3/8, 5/12, 7/16, n = 1(1)50(2)100(10)200(20)500(50)1000, 5D$.
- [26.34] National Bureau of Standards, Tables of the binomial probability distribution, Applied Math. Series 6 (U.S. Government Printing Office, Washington, D.C., 1950). $\binom{n}{s} p^s (1-p)^{n-s}$ and

$$\sum_{s=c}^n \binom{n}{s} p^s (1-p)^{n-s}$$
 for $p = .01(.01).5, n = 2(1)49, 7D$.
- [26.35] K. Pearson (Editor), Tables of the incomplete beta function, Biometrika Office, University College (Cambridge Univ. Press, Cambridge, England, 1948). $I_x(a, b)$ for $x = .01(.01)1; a, b = .5(.5)11(1)50, a \geq b, 7D$.
- [26.36] W. H. Robertson, Tables of the binomial distribution function for small values of p , Office of Technical Services, U.S. Department of Commerce (1960).

$$\sum_{s=0}^c \binom{n}{s} p^s (1-p)^{n-s}$$
 for $p = .001(.001).02, n = 2(1)100(2)200(10)500(20)1000; p = .021(.001).05, n = 2(1)50(2)100(5)200(10)300(20)600(50)1000, 5D$.
- [26.37] H. G. Romig, 50-100 Binomial tables (John Wiley & Sons, Inc., New York, N.Y., 1953).

$$\binom{n}{s} p^s (1-p)^{n-s}$$
 and
$$\sum_{s=0}^c \binom{n}{s} p^s (1-p)^{n-s}$$
 for $p = .01(.01).5$ and $n = 50(5)100, 6D$.
- [26.38] C. M. Thompson, Tables of percentage points of the incomplete beta function, Biometrika **32**, 151-181 (1941). Also reproduced as Table 16 in [26.11]. Tabulates values of x for which
 $I_x(a, b) = .005, .01, .025, .05, .1, .25, .5; 2a = 1(1)30, 40, 60, 120, \infty; 2b = 1(1)10, 12, 15, 20, 24, 30, 40, 60, 120, 5D$.
- [26.39] U.S. Ordnance Corps, Tables of the cumulative binomial probabilities, ORDP 20-1, Office of Technical Services, Washington, D.C. (1952).

$$\sum_{s=c}^n \binom{n}{s} p^s (1-p)^{n-s}$$
 for $p = .01(.01).5$ and $n = 1(1)150, 7D$.

F (Variance-Ratio) and Non-Central F Distribution

- [26.40] Table V of [26.7]. Tabulates values of F and
 $Z = \frac{1}{2} \ln F$ for $Q(F|\nu_1, \nu_2) = .2, .1, .05, .01, .001; \nu_1 = 1(1)6, 8, 12, 24, \infty; \nu_2 = 1(1)30, 40, 60, 120, \infty, 2D$ for $F, 4D$ for Z .
- [26.41] E. Lehmer, Inverse tables of probabilities of errors of the second kind, Ann. Math. Statist. **15**, 388-398 (1944). $\phi = \sqrt{\lambda/(\nu_1 + 1)}$ for $\nu_1 = 1(1)10, 12, 15, 20, 24, 30, 40, 60, 120, \infty; \nu_2 = 2(2)20, 24, 30, 40, 60, 80, 120, 240, \infty$ and $P(F'|\nu_1, \nu_2, \phi) = .2, .3$ where $Q(F'|\nu_1, \nu_2) = .01, .05, 3D$ or $3S$.

- [26.42] M. Merrington and C. M. Thompson, Tables of percentage points of the inverted beta (F) distribution, Biometrika **33**, 73-88 (1943). Tabulates values of F for which $Q(F|\nu_1, \nu_2) = .5, .25, .1, .05, .025, .01, .005; \nu_1 = 1(1)10, 12, 15, 20, 24, 30, 40, 60, 120, \infty; \nu_2 = 1(1)30, 40, 60, 120, \infty$.
- [26.43] P. C. Tang, The power function of the analysis of variance tests with tables and illustrations of their use, Statistical Research Memoirs II, 126-149 and tables (1938). $P(F'|\nu_1, \nu_2, \phi)$ for $\nu_1 = 1(1)8, \nu_2 = 2(2)6(1)30, 60, \infty$ and $\phi = \sqrt{\lambda/(\nu_1 + 1)} = 1(.5)3(1)8$ where $Q(F'|\nu_1, \nu_2) = .01, .05, 3D$.

Student's t and Non-Central t-Distributions

- [26.44] E. T. Federighi, Extended tables of the percentage points of Student's t -distribution, J. Amer. Statist. Assoc. **54**, 683-688 (1959). Values of t for which $Q(t|\nu) = \frac{1}{2} [1 - A(t|\nu)] = .25 \times 10^{-n}, .1 \times 10^{-n}, n = 0(1)6, .05 \times 10^{-n}, n = 0(1)5, \nu = 1(1)30(5)60(10)100, 200, 500, 1000, 2000, 10000, \infty; 3D$.
- [26.45] Table III of [26.7]. Values of t for which $A(t|\nu) = .1(.1).9, .95, .98, .99, .999$ and $\nu = 1(1)30, 40, 60, 120, \infty; 3D$.
- [26.46] N. L. Johnson and B. L. Welch, Applications of the noncentral t -distribution, Biometrika **31**, 362-389 (1939). Tabulates an auxiliary function which enables calculation of δ for given t' and p , or t' for given δ and p where $P(t'|\nu, \delta) = p = .005, .01, .025, .05, .1(.1).9, .95, .975, .99, .995$.
- [26.47] J. Neyman and B. Tokarska, Errors of the second kind in testing Student's hypothesis, J. Amer. Statist. Assoc. **31**, 318-326 (1936). Tabulates δ for $P(t'|\nu, \delta) = .01, .05, .1(.1).9; \nu = 1(1)30, \infty; Q(t'|\nu) = .01, .05$.
- [26.48] Table 9 of [26.11]. $P(t|\nu) = \frac{1}{2} [1 + A(t|\nu)]$ for $t = 0(.1)4(.2)8; \nu = 1(1)20, 5D; t = 0(.05)2(.1)4, 5; \nu = 20(1)24, 30, 40, 60, 120, \infty, 5D$.
- [26.49] G. S. Resnikoff and G. J. Lieberman, Tables of the noncentral t -distribution (Stanford Univ. Press, Stanford, Calif., 1957). $\partial P(t'|\nu, \delta) / \partial t'$ and $P(t'|\nu, \delta)$ for $\nu = 2(1)24(5)49, \delta = \sqrt{\nu + 1} x_p$ where $Q(x_p) = p = .25, .15, .1, .065, .04, .025, .01, .004, .0025, .001$ and $t'/\sqrt{\nu}$ covers the range of values such that throughout most of the table the entries lie between 0 and 1, 4D.

Random Numbers and Normal Deviates

- [26.50] E. C. Fieller, T. Lewis and E. S. Pearson, Correlated random normal deviates, Tracts for Computers 26 (Cambridge Univ. Press, Cambridge, England, 1955).
- [26.51] T. E. Hull and A. R. Dobell, Random number generators, Soc. Ind. App. Math. **4**, 230-254 (1962).
- [26.52] M. G. Kendall and B. Babington Smith, Random sampling numbers (Cambridge Univ. Press, Cambridge, England, 1939).

*See page II.

- [26.53] G. Marsaglia, Random variables and computers, Proc. Third Prague Conference in Probability Theory 1962. (Also as Math. Note No. 260, Boeing Scientific Research Laboratories, 1962).
- [26.54] M. E. Muller, An inverse method for the generation of random normal deviates on large scale computers, Math. Tables Aids Comp. **63**. 167-174 (1958).
- [26.55] Rand Corporation, A million random digits with 100,000 normal deviates (The Free Press, Glencoe, Ill. 1955).
- [26.56] H. Wold, Random normal deviates, Tracts for Computers 25 (Cambridge Univ. Press, Cambridge, England, 1948).

Table 26.1 NORMAL PROBABILITY FUNCTION AND DERIVATIVES

x	$P(x)$			$Z(x)$			$Z^{(1)}(x)$		
0.00	0.50000	00000	00000	0.39894	22804	01433	0.00000	00000	00000
0.02	0.50797	83137	16902	0.39886	24999	23666	-0.00797	72499	98473
0.04	0.51595	34368	52831	0.39862	32542	04605	-0.01594	49301	68184
0.06	0.52392	21826	54107	0.39822	48301	95607	-0.02389	34898	11736
0.08	0.53188	13720	13988	0.39766	77055	11609	-0.03181	34164	40929
0.10	0.53982	78372	77029	0.39695	25474	77012	-0.03969	52547	47701
0.12	0.54775	84260	20584	0.39608	02117	93656	-0.04752	96254	15239
0.14	0.55567	00048	05907	0.39505	17408	34611	-0.05530	72437	16846
0.16	0.56355	94628	91433	0.39386	83615	68541	-0.06301	89378	50967
0.18	0.57142	37159	00901	0.39253	14831	20429	-0.07065	56669	61677
0.20	0.57925	97094	39103	0.39104	26939	75456	-0.07820	85387	95091
0.22	0.58706	44226	48215	0.38940	37588	33790	-0.08566	88269	43434
0.24	0.59483	48716	97796	0.38761	66151	25014	-0.09302	79876	30003
0.26	0.60256	81132	01761	0.38568	33691	91816	-0.10027	76759	89872
0.28	0.61026	12475	55797	0.38360	62921	53479	-0.10740	97618	02974
0.30	0.61791	14221	88953	0.38138	78154	60524	-0.11441	63446	38157
0.32	0.62551	58347	23320	0.37903	05261	52702	-0.12128	97683	68865
0.34	0.63307	17360	36028	0.37653	71618	33254	-0.12802	26350	23306
0.36	0.64057	64332	17991	0.37391	06053	73128	-0.13460	78179	34326
0.38	0.64802	72924	24163	0.37115	38793	59466	-0.14103	84741	56597
0.40	0.65542	17416	10324	0.36827	01403	03323	-0.14730	80561	21329
0.42	0.66275	72731	51751	0.36526	26726	22154	-0.15341	03225	01305
0.44	0.67003	14463	39407	0.36213	48824	13092	-0.15933	93482	61761
0.46	0.67724	18897	49653	0.35889	02910	33545	-0.16508	95338	75431
0.48	0.68438	63034	83778	0.35553	25285	05997	-0.17065	56136	82879
0.50	0.69146	24612	74013	0.35206	53267	64299	-0.17603	26633	82150
0.52	0.69846	82124	53034	0.34849	25127	58974	-0.18121	61066	34667
0.54	0.70540	14837	84302	0.34481	80014	39333	-0.18620	17207	77240
0.56	0.71226	02811	50973	0.34104	57886	30353	-0.19098	56416	32997
0.58	0.71904	26911	01436	0.33717	99438	22381	-0.19556	43674	16981
0.60	0.72574	68822	49927	0.33322	46028	91800	-0.19993	47617	35080
0.62	0.73237	11065	31017	0.32918	39607	70765	-0.20409	40556	77874
0.64	0.73891	37003	07139	0.32506	22640	84082	-0.20803	98490	13813
0.66	0.74537	30853	28664	0.32086	38037	71172	-0.21177	01104	88974
0.68	0.75174	77695	46430	0.31659	29077	10893	-0.21528	31772	43407
0.70	0.75803	63477	76927	0.31225	39333	66761	-0.21857	77533	56733
0.72	0.76423	75022	20749	0.30785	12604	69853	-0.22165	29075	38294
0.74	0.77035	00028	35210	0.30338	92837	56300	-0.22450	80699	79662
0.76	0.77637	27075	62401	0.29887	24057	75953	-0.22714	30283	89724
0.78	0.78230	45624	14267	0.29430	50297	88325	-0.22955	79232	34894
0.80	0.78814	46014	16604	0.28969	15527	61483	-0.23175	32422	09186
0.82	0.79389	19464	14187	0.28503	63584	89007	-0.23372	98139	60986
0.84	0.79954	58067	39551	0.28034	38108	39621	-0.23548	88011	05281
0.86	0.80510	54787	48192	0.27561	82471	53457	-0.23703	16925	51973
0.88	0.81057	03452	23288	0.27086	39717	98338	-0.23836	02951	82537
0.90	0.81593	98746	53241	0.26608	52498	98755	-0.23947	67249	08879
0.92	0.82121	36203	85629	0.26128	63012	49553	-0.24038	33971	49589
0.94	0.82639	12196	61376	0.25647	12944	25620	-0.24108	30167	60083
0.96	0.83147	23925	33162	0.25164	43410	98117	-0.24157	85674	54192
0.98	0.83645	69406	72308	0.24680	94905	67043	-0.24187	33007	55702
1.00	0.84134	47460	68543	0.24197	07245	19143	-0.24197	07245	19143
		$\begin{bmatrix} (-5)1 \\ 10 \end{bmatrix}$			$\begin{bmatrix} (-5)2 \\ 10 \end{bmatrix}$			$\begin{bmatrix} (-5)3 \\ 10 \end{bmatrix}$	

$$Z(x) = \frac{1}{\sqrt{2\pi}} e^{-\frac{1}{2}x^2} \quad P(x) = \int_{-\infty}^x Z(t) dt \quad Z^{(n)}(x) = \frac{d^n}{dx^n} Z(x) \quad He_n(x) = (-1)^n Z^{(n)}(x) / Z(x)$$

NORMAL PROBABILITY FUNCTION AND DERIVATIVES

Table 26.1

x	$Z^{(2)}(x)$	$Z^{(3)}(x)$	$Z^{(4)}(x)$	$Z^{(5)}(x)$	$Z^{(6)}(x)$
0.00	-0.39894 22804	0.00000 000	1.19682 684	0.00000 000	-5.98413 421
0.02	-0.39870 29549	0.02392 856	1.19563 029	-0.11962 684	-5.97575 893
0.04	-0.39798 54570	0.04780 928	1.19204 400	-0.23891 887	-5.95066 325
0.06	-0.39679 12208	0.07159 445	1.18607 800	-0.35754 249	-5.90893 742
0.08	-0.39512 26322	0.09523 664	1.17774 897	-0.47516 649	-5.85073 151
0.10	-0.39298 30220	0.11868 881	1.16708 019	-0.59146 327	-5.77625 460
0.12	-0.39037 66567	0.14190 445	1.15410 144	-0.70610 997	-5.68577 399
0.14	-0.38730 87267	0.16483 771	1.13884 890	-0.81878 968	-5.57961 395
0.16	-0.38378 53315	0.18744 353	1.12136 503	-0.92919 252	-5.45815 435
0.18	-0.37981 34631	0.20967 776	1.10169 839	-1.03701 674	-5.32182 895
0.20	-0.37540 09862	0.23149 727	1.07990 350	-1.14196 980	-5.17112 356
0.22	-0.37055 66169	0.25286 011	1.05604 063	-1.24376 938	-5.00657 387
0.24	-0.36528 98981	0.27372 555	1.03017 556	-1.34214 434	-4.82876 317
0.26	-0.35961 11734	0.29405 426	1.00237 941	-1.43683 568	-4.63831 979
0.28	-0.35353 15588	0.31380 836	0.97272 834	-1.52759 737	-4.43591 441
0.30	-0.34706 29121	0.33295 156	0.94130 327	-1.61419 723	-4.22225 716
0.32	-0.34021 78003	0.35144 923	0.90818 965	-1.69641 762	-3.99809 459
0.34	-0.33300 94659	0.36926 849	0.87347 711	-1.77405 617	-3.76420 646
0.36	-0.32545 17909	0.38637 828	0.83725 919	-1.84692 643	-3.52140 244
0.38	-0.31755 92592	0.40274 947	0.79963 298	-1.91485 840	-3.27051 871
0.40	-0.30934 69179	0.41835 488	0.76069 880	-1.97769 904	-3.01241 439
0.42	-0.30083 03372	0.43316 939	0.72055 987	-2.03531 269	-2.74796 802
0.44	-0.29202 55692	0.44716 995	0.67932 193	-2.08758 144	-2.47807 382
0.46	-0.28294 91055	0.46033 566	0.63709 291	-2.13440 537	-2.20363 810
0.48	-0.27361 78339	0.47264 779	0.59398 256	-2.17570 278	-1.92557 548
0.50	-0.26404 89951	0.48408 982	0.55010 207	-2.21141 033	-1.64480 520
0.52	-0.25426 01373	0.49464 748	0.50556 372	-2.24148 307	-1.36224 740
0.54	-0.24426 90722	0.50430 874	0.46048 050	-2.26589 443	-1.07881 949
0.56	-0.23409 38293	0.51306 383	0.41496 574	-2.28463 613	-0.79543 249
0.58	-0.22375 26107	0.52090 525	0.36913 279	-2.29771 801	-0.51298 749
0.60	-0.21326 37459	0.52782 777	0.32309 457	-2.30516 783	-0.23237 218
0.62	-0.20264 56463	0.53382 841	0.27696 332	-2.30703 091	+0.04554 255
0.64	-0.19191 67607	0.53890 643	0.23085 017	-2.30336 981	0.31990 583
0.66	-0.18109 55308	0.54306 327	0.18486 483	-2.29426 388	0.58988 999
0.68	-0.17020 03472	0.54630 259	0.13911 528	-2.27980 875	0.85469 355
0.70	-0.15924 95060	0.54863 016	0.09370 741	-2.26011 583	1.11354 405
0.72	-0.14826 11670	0.55005 386	0.04874 473	-2.23531 162	1.36570 074
0.74	-0.13725 33120	0.55058 359	+0.00432 808	-2.20553 714	1.61045 709
0.76	-0.12624 37042	0.55023 127	-0.03944 465	-2.17094 715	1.84714 311
0.78	-0.11524 98497	0.54901 073	-0.08247 882	-2.13170 944	2.07512 746
0.80	-0.10428 89590	0.54693 765	-0.12468 324	-2.08800 401	2.29381 943
0.82	-0.09337 79110	0.54402 952	-0.16597 047	-2.04002 228	2.50267 061
0.84	-0.08253 32179	0.54030 551	-0.20625 697	-1.98796 617	2.70117 643
0.86	-0.07177 09916	0.53578 644	-0.24546 336	-1.93204 726	2.88887 745
0.88	-0.06110 69120	0.53049 467	-0.28351 458	-1.87248 587	3.06536 044
0.90	-0.05055 61975	0.52445 403	-0.32034 003	-1.80951 008	3.23025 923
0.92	-0.04013 35759	0.51768 968	-0.35587 378	-1.74335 486	3.38325 538
0.94	-0.02985 32587	0.51022 310	-0.39005 463	-1.67426 103	3.52407 854
0.96	-0.01972 89163	0.50209 689	-0.42282 627	-1.60247 436	3.65250 673
0.98	-0.00977 36558	0.49332 478	-0.45413 732	-1.52824 456	3.76836 628

1.00	0.00000 00000	0.48394 145	-0.48394 145	-1.45182 435	3.87153 159
	$\begin{bmatrix} (-5)6 \\ 6 \end{bmatrix}$	$\begin{bmatrix} (-4)1 \\ 6 \end{bmatrix}$	$\begin{bmatrix} (-4)3 \\ 6 \end{bmatrix}$	$\begin{bmatrix} (-4)7 \\ 6 \end{bmatrix}$	$\begin{bmatrix} (-3)2 \\ 7 \end{bmatrix}$

$P(-x) = 1 - P(x)$

$Z(-x) = -Z(x)$

$Z^{(n)}(-x) = (-1)^n Z^{(n)}(x)$

Table 26.1 NORMAL PROBABILITY FUNCTION AND DERIVATIVES

x	$P(x)$			$Z(x)$			$Z^{(n)}(x)$		
1.00	0.84134	47460	68543	0.24197	07245	19143	-0.24197	07245	19143
1.02	0.84613	57696	27265	0.23713	19520	19380	-0.24187	45910	59767
1.04	0.85083	00496	69019	0.23229	70047	43366	-0.24158	88849	33101
1.06	0.85542	77003	36091	0.22746	96324	57386	-0.24111	78104	04829
1.08	0.85992	89099	11231	0.22265	34987	51761	-0.24046	57786	51902
1.10	0.86433	39390	53618	0.21785	21770	32551	-0.23963	73947	35806
1.12	0.86864	31189	57270	0.21306	91467	75718	-0.23863	74443	88804
1.14	0.87285	68494	37202	0.20830	77900	47108	-0.23747	08806	53704
1.16	0.87697	55969	48657	0.20357	13882	90759	-0.23614	28104	17281
1.18	0.88099	98925	44800	0.19886	31193	87276	-0.23465	84808	76986
1.20	0.88493	03297	78292	0.19418	60549	83213	-0.23302	32659	79856
1.22	0.88876	75625	52166	0.18954	31580	91640	-0.23124	26528	71801
1.24	0.89251	23029	25413	0.18493	72809	63305	-0.22932	22283	94499
1.26	0.89616	53188	78700	0.18037	11632	27080	-0.22726	76656	66121
1.28	0.89972	74320	45558	0.17584	74302	97662	-0.22508	47107	81008
1.30	0.90319	95154	14390	0.17136	85920	47807	-0.22277	91696	62150
1.32	0.90658	24910	06528	0.16693	70417	41714	-0.22035	68950	99062
1.34	0.90987	73275	35548	0.16255	50552	25534	-0.21782	37740	02216
1.36	0.91308	50380	52915	0.15822	47903	70383	-0.21518	57149	03721
1.38	0.91620	66775	84986	0.15394	82867	62634	-0.21244	86357	32434
1.40	0.91924	33407	66229	0.14972	74656	35745	-0.20961	84518	90043
1.42	0.92219	61594	73454	0.14556	41300	37348	-0.20670	10646	53034
1.44	0.92506	63004	65673	0.14145	99652	24839	-0.20370	23499	23768
1.46	0.92785	49630	34106	0.13741	65392	82282	-0.20062	81473	52131
1.48	0.93056	33766	66669	0.13343	53039	51002	-0.19748	42498	47483
1.50	0.93319	27987	31142	0.12951	75956	65892	-0.19427	63934	98838
1.52	0.93574	45121	81064	0.12566	46367	89088	-0.19101	02479	19414
1.54	0.93821	98232	88188	0.12187	75370	32402	-0.18769	14070	29899
1.56	0.94062	00594	05207	0.11815	72950	59582	-0.18432	53802	92948
1.58	0.94294	65667	62246	0.11450	48002	59292	-0.18091	75844	09682
1.60	0.94520	07083	00442	0.11092	08346	79456	-0.17747	33354	87129
1.62	0.94738	38615	45748	0.10740	60751	13484	-0.17399	78416	83844
1.64	0.94949	74165	25897	0.10396	10953	28764	-0.17049	61963	39173
1.66	0.95154	27737	33277	0.10058	63684	27691	-0.16697	33715	89966
1.68	0.95352	13421	36280	0.09728	22693	31467	-0.16343	42124	76865
1.70	0.95543	45372	41457	0.09404	90773	76887	-0.15988	34315	40708
1.72	0.95728	37792	08671	0.09088	69790	16283	-0.15632	56039	08007
1.74	0.95907	04910	21193	0.08779	60706	10906	-0.15276	51628	62976
1.76	0.96079	60967	12518	0.08477	63613	08022	-0.14920	63959	02119
1.78	0.96246	20196	51483	0.08182	77759	92143	-0.14565	34412	66014
1.80	0.96406	96808	87074	0.07895	01583	00894	-0.14211	02849	41609
1.82	0.96562	04975	54110	0.07614	32736	96207	-0.13858	07581	27097
1.84	0.96711	58813	40836	0.07340	68125	81657	-0.13506	85351	50249
1.86	0.96855	72370	19248	0.07074	03934	56983	-0.13157	71318	29989
1.88	0.96994	59610	38800	0.06814	35661	01045	-0.12810	99042	69964
1.90	0.97128	34401	83998	0.06561	58147	74677	-0.12467	00480	71886
1.92	0.97257	10502	96163	0.06315	65614	35199	-0.12126	05979	55581
1.94	0.97381	01550	59548	0.06076	51689	54565	-0.11788	44277	71856
1.96	0.97500	21048	51780	0.05844	09443	33451	-0.11454	42508	93565
1.98	0.97614	82356	58492	0.05618	31419	03868	-0.11124	26209	69659
2.00	0.97724	98680	51821	0.05399	09665	13188	-0.10798	19330	26376
		$\left[\begin{smallmatrix} (-5)1 \\ 10 \end{smallmatrix} \right]$			$\left[\begin{smallmatrix} (-6)9 \\ 10 \end{smallmatrix} \right]$			$\left[\begin{smallmatrix} (-5)2 \\ 10 \end{smallmatrix} \right]$	

$$Z(x) = \frac{1}{\sqrt{2\pi}} e^{-\frac{1}{2}x^2} \quad P(x) = \int_{-\infty}^x Z(t) dt \quad Z^{(n)}(x) = \frac{d^n}{dx^n} Z(x) \quad He_n(x) = (-1)^n Z^{(n)}(x) / Z(x)$$

NORMAL PROBABILITY FUNCTION AND DERIVATIVES

Table 26.1

x	$Z^{(2)}(x)$	$Z^{(3)}(x)$	$Z^{(4)}(x)$	$Z^{(5)}(x)$	$Z^{(6)}(x)$
1.00	0.00000 00000	0.48394 145	-0.48394 145	-1.45182 435	3.87153 159
1.02	0.00958 01309	0.47397 745	-0.51219 739	-1.37346 846	3.96192 478
1.04	0.01895 54356	0.46346 412	-0.53886 899	-1.29343 272	4.03951 497
1.06	0.02811 52466	0.45243 346	-0.56392 521	-1.21197 312	4.10431 754
1.08	0.03704 95422	0.44091 805	-0.58734 012	-1.12934 487	4.15639 308
1.10	0.04574 89572	0.42895 094	-0.60909 290	-1.04580 155	4.19584 622
1.12	0.05420 47909	0.41656 552	-0.62916 776	-0.96159 420	4.22282 430
1.14	0.06240 90139	0.40379 549	-0.64755 390	-0.87697 050	4.23751 585
1.16	0.07035 42718	0.39067 467	-0.66424 543	-0.79217 397	4.24014 894
1.18	0.07803 38880	0.37723 697	-0.67924 129	-0.70744 317	4.23098 941
1.20	0.08544 18642	0.36351 629	-0.69254 515	-0.62301 100	4.21033 894
1.22	0.09257 28784	0.34954 639	-0.70416 524	-0.53910 399	4.17853 305
1.24	0.09942 22822	0.33536 083	-0.71411 427	-0.45594 161	4.13593 896
1.26	0.10598 60955	0.32099 285	-0.72240 928	-0.37373 571	4.08295 339
1.28	0.11226 09995	0.30647 534	-0.72907 143	-0.29268 993	4.02000 029
1.30	0.11824 43285	0.29184 071	-0.73412 591	-0.21299 916	3.94752 847
1.32	0.12393 40598	0.27712 083	-0.73760 168	-0.13484 911	3.86600 921
1.34	0.12932 88019	0.26234 695	-0.73953 132	-0.05841 584	3.77593 384
1.36	0.13442 77819	0.24754 965	-0.73995 087	+0.01613 459	3.67781 128
1.38	0.13923 08305	0.23275 873	-0.73889 953	0.08864 645	3.57216 556
1.40	0.14373 83670	0.21800 319	-0.73641 957	0.15897 463	3.45953 335
1.42	0.14795 13818	0.20331 117	-0.73255 600	0.22698 486	3.34046 152
1.44	0.15187 14187	0.18870 986	-0.72735 645	0.29255 386	3.21550 469
1.46	0.15550 05559	0.17422 548	-0.72087 087	0.35556 954	3.08522 283
1.48	0.15884 13858	0.15988 325	-0.71315 137	0.41593 103	2.95017 891
1.50	0.16189 69946	0.14570 730	-0.70425 193	0.47354 871	2.81093 657
1.52	0.16467 09400	0.13172 067	-0.69422 823	0.52834 425	2.66805 791
1.54	0.16716 72298	0.11794 528	-0.68313 742	0.58025 051	2.52210 132
1.56	0.16939 02982	0.10440 190	-0.67103 785	0.62921 147	2.37361 937
1.58	0.17134 49831	0.09111 010	-0.65798 890	0.67518 208	2.22315 681
1.60	0.17303 65021	0.07808 827	-0.64405 073	0.71812 810	2.07124 871
1.62	0.17447 04284	0.06535 359	-0.62928 410	0.75802 588	1.91841 857
1.64	0.17565 26667	0.05292 202	-0.61375 011	0.79486 211	1.76517 671
1.66	0.17658 94284	0.04080 829	-0.59751 005	0.82863 352	1.61201 862
1.68	0.17728 72076	0.02902 592	-0.58062 516	0.85934 661	1.45942 351
1.70	0.17775 27562	0.01758 718	-0.56315 647	0.88701 729	1.30785 296
1.72	0.17799 30597	+0.00650 315	-0.54516 459	0.91167 051	1.15774 966
1.74	0.17801 53128	-0.00421 632	-0.52670 954	0.93333 988	1.00953 633
1.76	0.17782 68955	-0.01456 254	-0.50785 061	0.95206 725	0.86361 469
1.78	0.17743 53495	-0.02452 804	-0.48864 614	0.96790 228	0.72036 463
1.80	0.17684 83546	-0.03410 647	-0.46915 342	0.98090 203	0.58014 345
1.82	0.17607 37061	-0.04329 263	-0.44942 853	0.99113 045	0.44328 526
1.84	0.17511 92921	-0.05208 243	-0.42952 621	0.99865 794	0.31010 045
1.86	0.17399 30717	-0.06047 285	-0.40949 971	1.00356 087	0.18087 536
1.88	0.17270 30539	-0.06846 193	-0.38940 073	1.00592 110	+0.05587 197
1.90	0.17125 72766	-0.07604 873	-0.36927 924	1.00582 548	-0.06467 219
1.92	0.16966 37866	-0.08323 327	-0.34918 347	1.00336 537	-0.18054 414
1.94	0.16793 06209	-0.09001 655	-0.32915 976	0.99863 613	-0.29155 530
1.96	0.16606 57874	-0.09640 044	-0.30925 250	0.99173 666	-0.39754 137
1.98	0.16407 72476	-0.10238 771	-0.28950 408	0.98276 891	-0.49836 204
2.00	0.16197 28995	-0.10798 193	-0.26995 483	0.97183 740	-0.59390 063

$$\left[\begin{matrix} (-5)4 \\ 6 \end{matrix} \right]$$

$$\left[\begin{matrix} (-5)7 \\ 6 \end{matrix} \right]$$

$$\left[\begin{matrix} (-4)2 \\ 6 \end{matrix} \right]$$

$$\left[\begin{matrix} (-4)4 \\ 6 \end{matrix} \right]$$

$$\left[\begin{matrix} (-3)1 \\ 7 \end{matrix} \right]$$

$$P(-x) = 1 - P(x)$$

$$Z(-x) = Z(x)$$

$$Z^{(n)}(-x) = (-1)^n Z^{(n)}(x)$$

Table 26.1 NORMAL PROBABILITY FUNCTION AND DERIVATIVES

x	$P(x)$			$Z(x)$			$Z^{(1)}(x)$		
2.00	0.97724	98680	51821	0.05399	09665	13188	-0.10798	19330	26376
2.02	0.97830	83062	32353	0.05186	35766	82821	-0.10476	44248	99298
2.04	0.97932	48371	33930	0.04980	00877	35071	-0.10159	21789	79544
2.06	0.98030	07295	90623	0.04779	95748	82077	-0.09846	71242	57079
2.08	0.98123	72335	65062	0.04586	10762	71055	-0.09539	10386	43794
2.10	0.98213	55794	37184	0.04398	35959	80427	-0.09236	55515	58897
2.12	0.98299	69773	52367	0.04216	61069	61770	-0.08939	21467	58953
2.14	0.98382	26166	27834	0.04040	75539	22860	-0.08647	21653	94921
2.16	0.98461	36652	16075	0.03870	68561	47456	-0.08360	68092	78504
2.18	0.98537	12692	24011	0.03706	29102	47806	-0.08079	71443	40218
2.20	0.98609	65524	86502	0.03547	45928	46231	-0.07804	41042	61709
2.22	0.98679	06161	92744	0.03394	07631	82449	-0.07534	84942	65037
2.24	0.98745	45385	64054	0.03246	02656	43697	-0.07271	09950	41882
2.26	0.98808	93745	81453	0.03103	19322	15008	-0.07013	21668	05919
2.28	0.98869	61557	61447	0.02965	45848	47341	-0.06761	24534	51938
2.30	0.98927	58899	78324	0.02832	70377	41601	-0.06515	21868	05683
2.32	0.98982	95613	31281	0.02704	80995	46882	-0.06275	15909	48766
2.34	0.99035	81300	54642	0.02581	65754	71588	-0.06041	07866	03515
2.36	0.99086	25324	69428	0.02463	12693	06382	-0.05812	97955	63063
2.38	0.99134	36809	74484	0.02349	09853	58201	-0.05590	85451	52519
2.40	0.99180	24640	75404	0.02239	45302	94843	-0.05374	68727	07623
2.42	0.99223	97464	49447	0.02134	07148	99923	-0.05164	45300	57813
2.44	0.99265	63690	44652	0.02032	83557	38226	-0.04960	11880	01271
2.46	0.99305	31492	11376	0.01935	62767	31737	-0.04761	64407	60073
2.48	0.99343	08808	64453	0.01842	33106	46862	-0.04568	98104	04218
2.50	0.99379	03346	74224	0.01752	83004	93569	-0.04382	07512	33921
2.52	0.99413	22582	84668	0.01667	01008	37381	-0.04200	86541	10200
2.54	0.99445	73765	56918	0.01584	75790	25361	-0.04025	28507	24416
2.56	0.99476	63918	36444	0.01505	96163	27377	-0.03855	26177	98086
2.58	0.99505	99842	42230	0.01430	51089	94150	-0.03690	71812	04906
2.60	0.99533	88119	76281	0.01358	29692	33686	-0.03531	57200	07583
2.62	0.99560	35116	51879	0.01289	21261	07895	-0.03377	73704	02686
2.64	0.99585	46986	38964	0.01223	15263	51278	-0.03229	12295	67374
2.66	0.99609	29674	25147	0.01160	01351	13703	-0.03085	63594	02449
2.68	0.99631	88919	90825	0.01099	69366	29406	-0.02947	17901	66807
2.70	0.99653	30261	96960	0.01042	09348	14423	-0.02813	65239	98941
2.72	0.99673	59041	84109	0.00987	11537	94751	-0.02684	95383	21723
2.74	0.99692	80407	81350	0.00934	66383	67612	-0.02560	97891	27258
2.76	0.99710	99319	23774	0.00884	64543	98237	-0.02441	62141	39135
2.78	0.99728	20550	77299	0.00836	96891	54653	-0.02326	77358	49935
2.80	0.99744	48696	69572	0.00791	54515	82980	-0.02216	32644	32344
2.82	0.99759	88175	25811	0.00748	28725	25781	-0.02110	17005	22701
2.84	0.99774	43233	08458	0.00707	11048	86019	-0.02008	19378	76295
2.86	0.99788	17949	59596	0.00667	93237	39203	-0.01910	28658	94119
2.88	0.99801	16241	45106	0.00630	67263	96266	-0.01816	33720	21246
2.90	0.99813	41866	99616	0.00595	25324	19776	-0.01726	23440	17350
2.92	0.99824	98430	71324	0.00561	59835	95991	-0.01639	86721	00294
2.94	0.99835	89387	65843	0.00529	63438	65311	-0.01557	12509	64014
2.96	0.99846	18047	88262	0.00499	28992	13612	-0.01477	89816	72293
2.98	0.99855	87580	82660	0.00470	49575	26934	-0.01402	07734	30263
3.00	0.99865	01019	68370	0.00443	18484	11938	-0.01329	55452	35814

$$Z(x) = \frac{1}{\sqrt{2\pi}} e^{-\frac{1}{2}x^2} \quad P(x) = \int_{-\infty}^x Z(t) dt \quad Z^{(n)}(x) = \frac{d^n}{dx^n} Z(x) \quad H e_n(x) = (-1)^n Z^{(n)}(x)/Z(x)$$

NORMAL PROBABILITY FUNCTION AND DERIVATIVES

Table 26.1

x	$Z^{(2)}(x)$	$Z^{(3)}(x)$	$Z^{(4)}(x)$	$Z^{(5)}(x)$	$Z^{(6)}(x)$
2.00	0.16197 28995	-0.10798 193	-0.26995 483	0.97183 740	-0.59390 063
2.02	0.15976 05616	-0.11318 748	-0.25064 297	0.95904 873	-0.68406 360
2.04	0.15744 79574	-0.11800 948	-0.23160 454	0.94451 117	-0.76878 007
2.06	0.15504 27011	-0.12245 372	-0.21287 345	0.92833 417	-0.84800 114
2.08	0.15255 22841	-0.12652 667	-0.19448 137	0.91062 795	-0.92169 927
2.10	0.14998 40623	-0.13023 543	-0.17645 779	0.89150 307	-0.98986 750
2.12	0.14734 52442	-0.13358 762	-0.15882 997	0.87107 003	-1.05251 862
2.14	0.14464 28800	-0.13659 143	-0.14162 297	0.84943 890	-1.10968 436
2.16	0.14188 38519	-0.13925 550	-0.12485 967	0.82671 890	-1.16141 446
2.18	0.13907 48644	-0.14158 892	-0.10856 076	0.80301 811	-1.20777 570
2.20	0.13622 24365	-0.14360 115	-0.09274 478	0.77844 311	-1.24885 097
2.22	0.13333 28941	-0.14530 204	-0.07742 816	0.75309 866	-1.28473 823
2.24	0.13041 23633	-0.14670 170	-0.06262 527	0.72708 743	-1.31554 947
2.26	0.12746 67648	-0.14781 055	-0.04834 844	0.70050 969	-1.34140 971
2.28	0.12450 18090	-0.14863 922	-0.03460 801	0.67346 314	-1.36245 589
2.30	0.12152 29919	-0.14919 851	-0.02141 241	0.64604 257	-1.37883 587
2.32	0.11853 55915	-0.14949 939	-0.00876 819	0.61833 976	-1.39070 730
2.34	0.11554 46652	-0.14955 294	+0.00331 989	0.59044 323	-1.39823 661
2.36	0.11255 50482	-0.14937 032	0.01484 882	0.56243 808	-1.40159 796
2.38	0.10957 13521	-0.14896 273	0.02581 724	0.53440 589	-1.40097 220
2.40	0.10659 79642	-0.14834 137	0.03622 539	0.50642 453	-1.39654 584
2.42	0.10363 90478	-0.14751 744	0.04607 505	0.47856 812	-1.38851 010
2.44	0.10069 85430	-0.14650 207	0.05536 942	0.45090 689	-1.37705 991
2.46	0.09778 01675	-0.14530 633	0.06411 307	0.42350 717	-1.36239 299
2.48	0.09488 74192	-0.14394 118	0.07231 187	0.39643 129	-1.34470 892
2.50	0.09202 35776	-0.14241 744	0.07997 287	0.36973 759	-1.32420 833
2.52	0.08919 17075	-0.14074 579	0.08710 428	0.34348 039	-1.30109 199
2.54	0.08639 46618	-0.13893 674	0.09371 533	0.31771 001	-1.27556 010
2.56	0.08363 50852	-0.13700 058	0.09981 624	0.29247 277	-1.24781 146
2.58	0.08091 54185	-0.13494 742	0.10541 808	0.26781 102	-1.21804 284
2.60	0.07823 79028	-0.13278 711	0.11053 277	0.24376 323	-1.18644 824
2.62	0.07560 45843	-0.13052 927	0.11517 293	0.22036 399	-1.15321 833
2.64	0.07301 73197	-0.12818 326	0.11935 186	0.19764 415	-1.11853 985
2.66	0.07047 77809	-0.12575 818	0.12308 341	0.17563 084	-1.08259 509
2.68	0.06798 74610	-0.12326 282	0.12638 196	0.15434 760	-1.04556 139
2.70	0.06554 76800	-0.12070 569	0.12926 232	0.13381 449	-1.00761 072
2.72	0.06315 95904	-0.11809 501	0.13173 965	0.11404 817	-0.96890 932
2.74	0.06082 41838	-0.11543 869	0.13382 945	0.09506 206	-0.92961 727
2.76	0.05854 22966	-0.11274 431	0.13554 741	0.07686 640	-0.88988 829
2.78	0.05631 46165	-0.11001 916	0.13690 942	0.05946 846	-0.84986 942
2.80	0.05414 16888	-0.10727 020	0.13793 149	0.04287 262	-0.80970 080
2.82	0.05202 39229	-0.10450 406	0.13862 969	0.02708 053	-0.76951 553
2.84	0.04996 15987	-0.10172 706	0.13902 007	+0.01209 127	-0.72943 954
2.86	0.04795 48727	-0.09894 520	0.13911 867	-0.00209 857	-0.68959 143
2.88	0.04600 37850	-0.09616 416	0.13894 142	-0.01549 465	-0.65008 248
2.90	0.04410 82652	-0.09338 928	0.13850 412	-0.02810 482	-0.61101 661
2.92	0.04226 81389	-0.09062 562	0.13782 240	-0.03993 892	-0.57249 036
2.94	0.04048 31340	-0.08787 791	0.13691 166	-0.05100 863	-0.53459 292
2.96	0.03875 28865	-0.08515 058	0.13578 706	-0.06132 737	-0.49740 627
2.98	0.03707 69473	-0.08244 776	0.13446 347	-0.07091 012	-0.46100 520
3.00	0.03545 47873	-0.07977 327	0.13295 545	-0.07977 327	-0.42545 745

$$P(-x) = 1 - P(x) \quad Z(-x) = Z(x) \quad Z^{(n)}(-x) = (-1)^n Z^{(n)}(x)$$

Table 26.1 NORMAL PROBABILITY FUNCTION AND DERIVATIVES

x	$P(x)$	$Z(x)$	$Z^{(1)}(x)$
3.00	0.99865 01020	(-3) 4.43184 8412	(-2) -1.32955 45
3.05	0.99885 57932	(-3) 3.80976 2098	(-2) -1.16197 74
3.10	0.99903 23968	(-3) 3.26681 9056	(-2) -1.01271 39
3.15	0.99918 36477	(-3) 2.79425 8415	(-3) -8.80191 40
3.20	0.99931 28621	(-3) 2.38408 8201	(-3) -7.62908 22
3.25	0.99942 29750	(-3) 2.02904 8057	(-3) -6.59440 62
3.30	0.99951 65759	(-3) 1.72256 8939	(-3) -5.68447 75
3.35	0.99959 59422	(-3) 1.45873 0805	(-3) -4.88674 82
3.40	0.99966 30707	(-3) 1.23221 9168	(-3) -4.18954 52
3.45	0.99971 97067	(-3) 1.03828 1296	(-3) -3.58207 05
3.50	0.99976 73709	(-4) 8.72682 6950	(-3) -3.05438 94
3.55	0.99980 73844	(-4) 7.31664 4628	(-3) -2.59740 88
3.60	0.99984 08914	(-4) 6.11901 9301	(-3) -2.20284 69
3.65	0.99986 88798	(-4) 5.10464 9743	(-3) -1.86319 72
3.70	0.99989 22003	(-4) 4.24780 2706	(-3) -1.57168 70
3.75	0.99991 15827	(-4) 3.52595 6824	(-3) -1.32223 38
3.80	0.99992 76520	(-4) 2.91946 9258	(-3) -1.10939 83
3.85	0.99994 09411	(-4) 2.41126 5802	(-4) -9.28337 33
3.90	0.99995 19037	(-4) 1.98655 4714	(-4) -7.74756 34
3.95	0.99996 09244	(-4) 1.63256 4088	(-4) -6.44862 81
4.00	0.99996 83288	(-4) 1.33830 2258	(-4) -5.35320 90
4.05	0.99997 43912	(-4) 1.09434 0434	(-4) -4.43207 88
4.10	0.99997 93425	(-5) 8.92616 5718	(-4) -3.65972 79
4.15	0.99998 33762	(-5) 7.26259 3030	(-4) -3.01397 61
4.20	0.99998 66543	(-5) 5.89430 6776	(-4) -2.47560 88
4.25	0.99998 93115	(-5) 4.77186 3654	(-4) -2.02804 21
4.30	0.99999 14601	(-5) 3.85351 9674	(-4) -1.65701 35
4.35	0.99999 31931	(-5) 3.10414 0706	(-4) -1.35030 12
4.40	0.99999 45875	(-5) 2.49424 7129	(-4) -1.09746 87
4.45	0.99999 57065	(-5) 1.99917 9671	(-5) -8.89634 95
4.50	0.99999 66023	(-5) 1.59837 4111	(-5) -7.19268 35
4.55	0.99999 73177	(-5) 1.27473 3238	(-5) -5.80003 62
4.60	0.99999 78875	(-5) 1.01408 5207	(-5) -4.66479 20
4.65	0.99999 83403	(-6) 8.04718 2456	(-5) -3.74193 98
4.70	0.99999 86992	(-6) 6.36982 5179	(-5) -2.99381 78
4.75	0.99999 89829	(-6) 5.02950 7289	(-5) -2.38901 60
4.80	0.99999 92067	(-6) 3.96129 9091	(-5) -1.90142 36
4.85	0.99999 93827	(-6) 3.11217 5579	(-5) -1.50940 52
4.90	0.99999 95208	(-6) 2.43896 0746	(-5) -1.19509 08
4.95	0.99999 96289	(-6) 1.90660 0903	(-6) -9.43767 45
5.00	0.99999 97133	(-6) 1.48671 9515	(-6) -7.43359 76
	$\left[\begin{smallmatrix} (-6)3 \\ 7 \end{smallmatrix} \right]$		

Table 26.2 NORMAL PROBABILITY FUNCTION FOR LARGE ARGUMENTS

x	$-\log Q(x)$	x	$-\log Q(x)$	x	$-\log Q(x)$
5	6.54265	15	50.43522	25	137.51475
6	9.00586	16	57.19458	26	148.60624
7	11.89285	17	64.38658	27	160.13139
8	15.20614	18	72.01140	28	172.09024
9	18.94746	19	80.06919	29	184.48283
10	23.11805	20	88.56010	30	197.30921
11	27.71882	21	97.48422	31	210.56940
12	32.75044	22	106.84167	32	224.26344
13	38.21345	23	116.63253	33	238.39135
14	44.10827	24	126.85686	34	252.95315
	$\left[\begin{smallmatrix} (-2)5 \\ 5 \end{smallmatrix} \right]$		$\left[\begin{smallmatrix} (-2)5 \\ 4 \end{smallmatrix} \right]$		$\left[\begin{smallmatrix} (-2)5 \\ 3 \end{smallmatrix} \right]$

From E. S. Pearson and H. O. Hartley (editors), Biometrika tables for statisticians, vol. I. Cambridge Univ. Press, Cambridge, England, 1954 (with permission). Known error has been corrected.

NORMAL PROBABILITY FUNCTION AND DERIVATIVES Table 26.1

x	$Z^{(2)}(x)$	$Z^{(3)}(x)$	$Z^{(4)}(x)$	$Z^{(5)}(x)$	$Z^{(6)}(x)$
3.00	(-2) 3.54547 87	(-2) -7.97732 71	(-1) 1.32955 45	(-2) -7.97732 71	(-1) -4.25457 45
3.05	(-2) 3.16305 50	(-2) -7.32336 28	(-1) 1.28470 92	(-2) -9.89017 82	(-1) -3.40704 15
3.10	(-2) 2.81273 12	(-2) -6.69403 89	(-1) 1.23133 27	(-1) -1.13951 58	(-1) -2.62416 45
3.15	(-2) 2.49317 71	(-2) -6.09312 50	(-1) 1.17138 12	(-1) -1.25260 09	(-1) -1.91121 33
3.20	(-2) 2.20289 75	(-2) -5.52345 55	(-1) 1.10663 65	(-1) -1.33185 47	(-1) -1.27124 77
3.25	(-2) 1.94027 72	(-2) -4.98701 97	(-1) 1.03869 82	(-1) -1.38096 14	(-2) -7.05366 66
3.30	(-2) 1.70362 07	(-2) -4.48505 27	(-2) 9.68981 20	(-1) -1.40361 69	(-2) -2.12970 34
3.35	(-2) 1.49118 76	(-2) -4.01812 87	(-2) 8.98716 85	(-1) -1.40345 00	(-2) +2.07973 11
3.40	(-2) 1.30122 34	(-2) -3.58625 07	(-2) 8.28958 19	(-1) -1.38395 76	(-2) 5.60664 85
3.45	(-2) 1.13198 62	(-2) -3.18893 82	(-2) 7.60587 84	(-1) -1.34845 27	(-2) 8.49222 78
3.50	(-3) 9.81768 03	(-2) -2.82531 02	(-2) 6.94328 17	(-1) -1.30002 45	(-1) 1.07844 49
3.55	(-3) 8.48913 69	(-2) -2.49416 18	(-2) 6.30753 35	(-1) -1.24150 96	(-1) 1.25359 25
3.60	(-3) 7.31834 71	(-2) -2.19403 56	(-2) 5.70302 39	(-1) -1.17547 44	(-1) 1.38019 58
3.65	(-3) 6.29020 46	(-2) -1.92328 53	(-2) 5.13292 98	(-1) -1.10420 53	(-1) 1.46388 44
3.70	(-3) 5.39046 16	(-2) -1.68013 34	(-2) 4.59935 51	(-1) -1.02970 80	(-1) 1.51024 21
3.75	(-3) 4.60578 11	(-2) -1.46272 12	(-2) 4.10347 00	(-2) -9.53712 78	(-1) 1.52468 79
3.80	(-3) 3.92376 67	(-2) -1.26915 17	(-2) 3.64564 64	(-2) -8.77684 95	(-1) 1.51237 96
3.85	(-3) 3.33297 22	(-2) -1.09752 68	(-2) 3.22558 66	(-2) -8.02840 11	(-1) 1.47814 11
3.90	(-3) 2.82289 42	(-3) -9.45977 49	(-2) 2.84244 39	(-2) -7.30162 14	(-1) 1.42641 04
3.95	(-3) 2.38395 17	(-3) -8.12688 36	(-2) 2.49493 35	(-2) -6.60423 39	(-1) 1.36120 56
4.00	(-3) 2.00745 34	(-3) -6.95917 17	(-2) 2.18143 27	(-2) -5.94206 20	(-1) 1.28610 85
4.05	(-3) 1.68555 79	(-3) -5.94009 36	(-2) 1.90007 05	(-2) -5.31924 82	(-1) 1.20426 03
4.10	(-3) 1.41122 68	(-3) -5.05408 43	(-2) 1.64880 65	(-2) -4.73847 30	(-1) 1.11837 07
4.15	(-3) 1.17817 42	(-3) -4.28662 75	(-2) 1.42549 82	(-2) -4.20116 64	(-1) 1.03073 50
4.20	(-4) 9.80812 65	(-3) -3.62429 14	(-2) 1.22795 86	(-2) -3.70770 95	(-2) 9.43258 69
4.25	(-4) 8.14199 24	(-3) -3.05473 83	(-2) 1.05400 40	(-2) -3.25762 18	(-2) 8.57487 24
4.30	(-4) 6.73980 59	(-3) -2.56671 38	(-3) 9.01492 78	(-2) -2.84973 34	(-2) 7.74638 98
4.35	(-4) 5.56339 62	(-3) -2.15001 71	(-3) 7.68355 55	(-2) -2.48233 98	(-2) 6.95640 04
4.40	(-4) 4.57943 77	(-3) -1.79545 89	(-3) 6.52618 76	(-2) -2.15333 90	(-2) 6.21159 79
4.45	(-4) 3.75895 76	(-3) -1.49480 91	(-3) 5.52421 34	(-2) -1.86035 13	(-2) 5.51645 66
4.50	(-4) 3.07687 02	(-3) -1.24073 79	(-3) 4.66025 95	(-2) -1.60082 16	(-2) 4.87356 75
4.55	(-4) 2.51154 32	(-3) -1.02675 14	(-3) 3.91825 60	(-2) -1.37210 59	(-2) 4.28395 39
4.60	(-4) 2.04439 58	(-4) -8.47126 22	(-3) 3.28346 19	(-2) -1.17154 20	(-2) 3.74736 21
4.65	(-4) 1.65953 02	(-4) -6.96842 75	(-3) 2.74245 97	(-3) -9.96506 67	(-2) 3.26252 61
4.70	(-4) 1.34339 61	(-4) -5.71519 82	(-3) 2.28312 43	(-3) -8.44460 51	(-2) 2.82740 22
4.75	(-4) 1.08448 75	(-4) -4.67351 25	(-3) 1.89457 22	(-3) -7.12981 28	(-2) 2.43937 50
4.80	(-5) 8.73070 32	(-4) -3.81045 28	(-3) 1.56709 63	(-3) -5.99788 09	(-2) 2.09543 47
4.85	(-5) 7.00939 74	(-4) -3.09767 67	(-3) 1.29209 13	(-3) -5.02757 21	(-2) 1.79232 68
4.90	(-5) 5.61204 87	(-4) -2.51088 57	(-3) 1.06197 25	(-3) -4.19931 11	(-2) 1.52667 62
4.95	(-5) 4.48098 88	(-4) -2.02933 60	(-4) 8.70091 63	(-3) -3.49521 92	(-2) 1.29508 77
5.00	(-5) 3.56812 68	(-4) -1.63539 15	(-4) 7.10651 93	(-3) -2.89910 31	(-2) 1.09422 56

NORMAL PROBABILITY FUNCTION FOR LARGE ARGUMENTS Table 26.2

x	$-\log Q(x)$	x	$-\log Q(x)$	x	$-\log Q(x)$
35	267.94888	45	441.77568	100	2173.87154
36	283.37855	46	461.54561	150	4888.38812
37	299.24218	47	481.74964	200	8688.58977
38	315.53979	48	502.38776	250	13574.49960
39	332.27139	49	523.45999	300	19546.12790
40	349.43701	50	544.96634	350	26603.48018
41	367.03664	60	783.90743	400	34746.55970
42	385.07032	70	1066.26576	450	43975.36860
43	403.53804	80	1392.04459	500	54289.90830
44	422.43983	90	1761.24604		$\left[\begin{matrix} (+2)1 \\ 9 \end{matrix} \right]$
	$\left[\begin{matrix} (-2)5 \\ 3 \end{matrix} \right]$		$\left[\begin{matrix} (0)5 \\ 5 \end{matrix} \right]$		

$$Q(x) = 1 - P(x) = \frac{1}{\sqrt{2\pi}} \int_x^\infty e^{-\frac{1}{2}t^2} dt \quad Z(x) = \frac{1}{\sqrt{2\pi}} e^{-\frac{1}{2}x^2} \quad P(x) = \int_{-\infty}^x Z(t) dt \quad Z^{(n)}(x) = \frac{d^n}{dx^n} Z(x)$$

$$He_n(x) = (-1)^n Z^{(n)}(x) / Z(x) \quad P(-x) = 1 - P(x) \quad Z(-x) = Z(x) \quad Z^{(n)}(-x) = (-1)^n Z^{(n)}(x)$$

Table 26.3 HIGHER DERIVATIVES OF THE NORMAL PROBABILITY FUNCTION

x	$Z^{(7)}(x)$	$Z^{(8)}(x)$	$Z^{(9)}(x)$	$Z^{(10)}(x)$	$Z^{(11)}(x)$	$Z^{(12)}(x)$
0.0	0.00000 00	(1) 4.18889 39	0.00000 00	(2) -3.77000 46	0.00000 00	(3) 4.14700 50
0.1	(0) 4.12640 51	(1) 4.00211 42	(1) -3.70133 55	(2) -3.56488 94	(2) 4.05782 44	(3) 3.88080 01
0.2	(0) 7.88604 35	(1) 3.46206 56	(1) -7.00124 79	(2) -2.97583 41	(2) 7.59641 48	(3) 3.12148 92
0.3	(1) 1.09518 61	(1) 2.62702 42	(1) -9.54959 57	(2) -2.07783 39	(3) 1.01729 46	(3) 1.98042 89
0.4	(1) 1.30711 60	(1) 1.58584 37	(2) -1.10912 65	(1) -9.83608 69	(3) 1.14847 09	(2) +6.22581 20
0.5	(1) 1.40908 65	(0) +4.46820 41	(2) -1.14961 02	(1) +1.72666 73	(3) 1.14097 69	(2) -7.60421 83
0.6	(1) 1.39704 30	(0) -6.75565 29	(2) -1.07710 05	(2) 1.25426 91	(3) 1.00184 44	(3) -1.98080 26
0.7	(1) 1.27812 14	(1) -1.67416 58	(1) -9.05305 52	(2) 2.14046 31	(2) 7.55473 11	(3) -2.88334 06
0.8	(1) 1.06929 69	(1) -2.46111 11	(1) -6.58548 60	(2) 2.74183 89	(2) 4.39201 49	(3) -3.36738 39
0.9	(0) 7.94982 72	(1) -2.97666 59	(1) -3.68086 24	(2) 3.01027 69	(1) +9.71613 18	(3) -3.39874 98
1.0	(0) 4.83941 45	(1) -3.19401 36	(0) -6.77518 03	(2) 2.94236 40	(2) -2.26484 60	(3) -3.01011 58
1.1	(0) +1.65937 85	(1) -3.11962 40	(1) +2.10408 36	(2) 2.57621 24	(2) -4.93791 72	(3) -2.29066 27
1.2	(0) -1.31434 07	(1) -2.78951 64	(1) 4.39889 22	(2) 1.98269 77	(2) -6.77812 94	(3) -1.36759 19
1.3	(0) -3.85379 20	(1) -2.26227 70	(1) 6.02399 37	(2) 1.25293 01	(2) -7.65280 28	(2) -3.83358 74
1.4	(0) -5.79719 45	(1) -1.61006 61	(1) 6.89184 82	(1) +4.84200 76	(2) -7.56972 92	(2) +5.27141 25
1.5	(0) -7.05769 71	(0) -9.09001 03	(1) 7.00965 92	(1) -2.33347 96	(2) -6.65963 73	(3) 1.25562 83
1.6	(0) -7.62276 66	(0) -2.30231 44	(1) 6.46658 36	(1) -8.27445 07	(2) -5.14267 14	(3) 1.73301 70
1.7	(0) -7.54545 38	(0) +3.67230 07	(1) 5.41207 19	(2) -1.25055 93	(2) -3.28612 11	(3) 1.93425 58
1.8	(0) -6.92967 04	(0) 8.41240 26	(1) 4.02950 39	(2) -1.48242 69	(2) -1.36113 54	(3) 1.87567 40
1.9	(0) -5.91207 57	(1) 1.16856 49	(1) 2.50938 72	(2) -1.52849 20	(1) +3.94747 58	(3) 1.60633 92
2.0	(0) -4.64322 31	(1) 1.34437 51	(1) +1.02582 84	(2) -1.41510 32	(2) 1.80437 81	(3) 1.19573 79
2.1	(0) -3.27029 67	(1) 1.37966 95	(0) -2.81068 72	(2) -1.18267 82	(2) 2.76469 29	(2) 7.20360 48
2.2	(0) -1.92318 65	(1) 1.29729 67	(1) -1.31550 35	(1) -8.78156 27	(2) 3.24744 73	(2) +2.51533 48
2.3	(-1) -7.04932 91	(1) 1.12731 97	(1) -2.02888 89	(1) -5.47943 26	(2) 3.28915 84	(2) -1.53768 85
2.4	(-1) +3.13162 82	(0) 9.02423 01	(1) -0.21634 55	(1) -2.32257 79	(2) 2.97376 42	(2) -4.58219 83
2.5	(0) 1.09209 53	(0) 6.53922 01	(1) -2.50848 12	(0) +3.85905 05	(2) 2.41200 50	(2) -6.45450 80
2.6	(0) 1.62218 61	(0) 4.08745 39	(1) -2.36048 69	(1) 2.45855 73	(2) 1.72126 20	(2) -7.17969 42
2.7	(0) 1.91766 20	(0) 1.87558 77	(1) -2.04053 83	(1) 3.82142 44	(2) 1.00875 37	(2) -6.92720 18
2.8	(0) 2.00992 65	(-2) +4.01113 24	(1) -1.61917 24	(1) 4.49758 25	(1) +3.59849 29	(2) -5.95491 88
2.9	(0) 1.94057 71	(0) -1.35055 73	(1) -1.16080 01	(1) 4.58182 18	(1) -1.67928 25	(2) -4.55301 20
3.0	(0) 1.75501 20	(0) -2.28683 38	(0) -7.17959 44	(1) 4.21202 87	(1) -5.45649 18	(2) -2.99628 41
3.1	(0) 1.49720 05	(0) -2.80440 64	(0) -3.28394 42	(1) 3.54198 84	(1) -7.69621 99	(2) -1.51035 91
3.2	(0) 1.20591 21	(0) -2.96904 52	(-1) -1.46351 84	(1) 2.71897 33	(1) -8.55436 26	(1) -2.53474 56
3.3	(-1) 9.12450 33	(0) -2.86200 69	(0) +2.14502 00	(1) 1.86794 96	(1) -8.30925 36	(1) +6.87309 15
3.4	(-1) 6.39748 51	(0) -2.56761 03	(0) 3.61188 70	(1) 1.08280 77	(1) -7.29343 32	(2) 1.28867 88
3.5	(-1) 4.02558 98	(0) -2.16386 79	(0) 4.35306 57	(0) +4.23908 09	(1) -5.83674 40	(2) 1.57656 15
3.6	(-1) 2.08414 13	(0) -1.71642 80	(0) 4.51182 76	(-1) -7.94727 62	(1) -4.22572 56	(2) 1.60868 13
3.7	(-2) +5.90352 21	(0) -1.27559 98	(0) 4.24743 76	(0) -4.23512 06	(1) -2.68044 29	(2) 1.45762 72
3.8	(-2) -4.80932 87	(-1) -8.75911 24	(0) 3.71320 90	(0) -6.22699 31	(1) -1.34695 16	(2) 1.19681 09
3.9	(-1) -1.18202 76	(-1) -5.37496 49	(0) 3.04185 84	(0) -7.02577 94	(0) -3.01804 44	(1) 8.90539 46
4.0	(-1) -1.57919 67	(-1) -2.68597 26	(0) 2.33774 64	(0) -6.93361 02	(0) +4.35697 68	(1) 5.88418 05
4.1	(-1) -1.74223 60	(-2) -6.85427 28	(0) 1.67481 40	(0) -6.24985 27	(0) 8.87625 64	(1) 3.23557 28
4.2	(-1) -1.73706 08	(-2) +6.92844 60	(0) 1.09865 39	(0) -5.23790 66	(1) 1.10126 69	(1) +1.13637 65
4.3	(-1) -1.62110 76	(-1) 1.54828 96	(-1) 6.31121 50	(0) -4.10728 31	(1) 1.13501 02	(0) -3.62532 62
4.4	(-1) -1.44109 96	(-1) 1.99272 00	(-1) 2.76082 94	(0) -3.00821 29	(1) 1.04753 07	(1) -1.30010 10
4.5	(-1) -1.23261 24	(-1) 2.13525 86	(-2) +2.52235 61	(0) -2.03523 88	(0) 8.90633 89	(1) -1.76908 98
4.6	(-1) -1.02086 14	(-1) 2.07280 89	(-1) 1.36802 99	(0) -1.23623 43	(0) 7.05470 76	(1) -1.88530 78
4.7	(-2) -8.22202 74	(-1) 1.88517 13	(-1) -2.28268 33	(-1) -6.23793 04	(0) 5.21451 06	(1) -1.76464 76
4.8	(-2) -6.45935 81	(-1) 1.63368 76	(-1) -2.67421 39	(-1) -1.86696 14	(0) 3.57035 54	(1) -1.50840 48
4.9	(-2) -4.96112 66	(-1) 1.36227 87	(-1) -2.70626 44	(-1) +1.00018 72	(0) 2.21617 27	(1) -1.19594 52
5.0	(-2) -3.73166 60	(-1) 1.09987 51	(-1) -2.51404 27	(-1) 2.67133 76	(0) 1.17837 39	(0) -8.83034 08

$$Z(x) = \frac{1}{\sqrt{2\pi}} e^{-\frac{1}{2}x^2} \quad Z^{(n)}(x) = \frac{d^n}{dx^n} Z(x) \quad H_n(x) = (-1)^n Z^{(n)}(x) / Z(x) \quad Z^{(n)}(-x) = (-1)^n Z^{(n)}(x)$$

NORMAL PROBABILITY FUNCTION—VALUES OF $Z(x)$ IN TERMS OF $P(x)$ AND $Q(x)$ Table 26.4

$Q(x)$	0.000	0.001	0.002	0.003	0.004	0.005	0.006	0.007	0.008	0.009	0.010	
0.00	0.00000	0.00337	0.00634	0.00915	0.01185	0.01446	0.01700	0.01949	0.02192	0.02431	0.02665	0.99
0.01	0.02665	0.02896	0.03123	0.03348	0.03569	0.03787	0.04003	0.04216	0.04427	0.04635	0.04842	0.98
0.02	0.04842	0.05046	0.05249	0.05449	0.05648	0.05845	0.06040	0.06233	0.06425	0.06615	0.06804	0.97
0.03	0.06804	0.06992	0.07177	0.07362	0.07545	0.07727	0.07908	0.08087	0.08265	0.08442	0.08617	0.96
0.04	0.08617	0.08792	0.08965	0.09137	0.09309	0.09479	0.09648	0.09816	0.09983	0.10149	0.10314	0.95
0.05	0.10314	0.10478	0.10641	0.10803	0.10964	0.11124	0.11284	0.11442	0.11600	0.11756	0.11912	0.94
0.06	0.11912	0.12067	0.12222	0.12375	0.12528	0.12679	0.12830	0.12981	0.13130	0.13279	0.13427	0.93
0.07	0.13427	0.13574	0.13720	0.13866	0.14011	0.14156	0.14299	0.14442	0.14584	0.14726	0.14867	0.92
0.08	0.14867	0.15007	0.15146	0.15285	0.15423	0.15561	0.15698	0.15834	0.15970	0.16105	0.16239	0.91
0.09	0.16239	0.16373	0.16506	0.16639	0.16770	0.16902	0.17033	0.17163	0.17292	0.17421	0.17550	0.90
0.10	0.17550	0.17678	0.17805	0.17932	0.18057	0.18184	0.18309	0.18433	0.18557	0.18681	0.18804	0.89
0.11	0.18804	0.18926	0.19048	0.19169	0.19290	0.19410	0.19530	0.19649	0.19768	0.19886	0.20004	0.88
0.12	0.20004	0.20121	0.20238	0.20354	0.20470	0.20585	0.20700	0.20814	0.20928	0.21042	0.21155	0.87
0.13	0.21155	0.21267	0.21379	0.21490	0.21601	0.21712	0.21822	0.21932	0.22041	0.22149	0.22258	0.86
0.14	0.22258	0.22365	0.22473	0.22580	0.22686	0.22792	0.22898	0.23003	0.23108	0.23212	0.23316	0.85
0.15	0.23316	0.23419	0.23522	0.23625	0.23727	0.23829	0.23930	0.24031	0.24131	0.24232	0.24331	0.84
0.16	0.24331	0.24430	0.24529	0.24628	0.24726	0.24823	0.24921	0.25017	0.25114	0.25210	0.25305	0.83
0.17	0.25305	0.25401	0.25495	0.25590	0.25684	0.25778	0.25871	0.25964	0.26056	0.26148	0.26240	0.82
0.18	0.26240	0.26331	0.26422	0.26513	0.26603	0.26693	0.26782	0.26871	0.26960	0.27049	0.27137	0.81
0.19	0.27137	0.27224	0.27311	0.27398	0.27485	0.27571	0.27657	0.27742	0.27827	0.27912	0.27996	0.80
0.20	0.27996	0.28080	0.28164	0.28247	0.28330	0.28413	0.28495	0.28577	0.28658	0.28739	0.28820	0.79
0.21	0.28820	0.28901	0.28981	0.29060	0.29140	0.29219	0.29298	0.29376	0.29454	0.29532	0.29609	0.78
0.22	0.29609	0.29686	0.29763	0.29840	0.29916	0.29991	0.30067	0.30142	0.30216	0.30291	0.30365	0.77
0.23	0.30365	0.30439	0.30512	0.30585	0.30658	0.30730	0.30802	0.30874	0.30945	0.31016	0.31087	0.76
0.24	0.31087	0.31158	0.31228	0.31298	0.31367	0.31436	0.31505	0.31574	0.31642	0.31710	0.31778	0.75
0.25	0.31778	0.31845	0.31912	0.31979	0.32045	0.32111	0.32177	0.32242	0.32307	0.32372	0.32437	0.74
0.26	0.32437	0.32501	0.32565	0.32628	0.32691	0.32754	0.32817	0.32879	0.32941	0.33003	0.33065	0.73
0.27	0.33065	0.33126	0.33187	0.33247	0.33307	0.33367	0.33427	0.33486	0.33545	0.33604	0.33662	0.72
0.28	0.33662	0.33720	0.33778	0.33836	0.33893	0.33950	0.34007	0.34063	0.34119	0.34175	0.34230	0.71
0.29	0.34230	0.34286	0.34341	0.34395	0.34449	0.34503	0.34557	0.34611	0.34664	0.34717	0.34769	0.70
0.30	0.34769	0.34822	0.34874	0.34925	0.34977	0.35028	0.35079	0.35129	0.35180	0.35230	0.35279	0.69
0.31	0.35279	0.35329	0.35378	0.35427	0.35475	0.35524	0.35572	0.35620	0.35667	0.35714	0.35761	0.68
0.32	0.35761	0.35808	0.35854	0.35900	0.35946	0.35991	0.36037	0.36082	0.36126	0.36171	0.36215	0.67
0.33	0.36215	0.36259	0.36302	0.36346	0.36389	0.36431	0.36474	0.36516	0.36558	0.36600	0.36641	0.66
0.34	0.36641	0.36682	0.36723	0.36764	0.36804	0.36844	0.36884	0.36923	0.36962	0.37001	0.37040	0.65
0.35	0.37040	0.37078	0.37116	0.37154	0.37192	0.37229	0.37266	0.37303	0.37340	0.37376	0.37412	0.64
0.36	0.37412	0.37447	0.37483	0.37518	0.37553	0.37588	0.37622	0.37656	0.37690	0.37724	0.37757	0.63
0.37	0.37757	0.37790	0.37823	0.37855	0.37888	0.37920	0.37951	0.37983	0.38014	0.38045	0.38076	0.62
0.38	0.38076	0.38106	0.38136	0.38166	0.38196	0.38225	0.38254	0.38283	0.38312	0.38340	0.38368	0.61
0.39	0.38368	0.38396	0.38423	0.38451	0.38478	0.38504	0.38531	0.38557	0.38583	0.38609	0.38634	0.60
0.40	0.38634	0.38659	0.38684	0.38709	0.38734	0.38758	0.38782	0.38805	0.38829	0.38852	0.38875	0.59
0.41	0.38875	0.38897	0.38920	0.38942	0.38964	0.38985	0.39007	0.39028	0.39049	0.39069	0.39089	0.58
0.42	0.39089	0.39109	0.39129	0.39149	0.39168	0.39187	0.39206	0.39224	0.39243	0.39261	0.39279	0.57
0.43	0.39279	0.39296	0.39313	0.39330	0.39347	0.39364	0.39380	0.39396	0.39411	0.39427	0.39442	0.56
0.44	0.39442	0.39457	0.39472	0.39486	0.39501	0.39514	0.39528	0.39542	0.39555	0.39568	0.39580	0.55
0.45	0.39580	0.39593	0.39605	0.39617	0.39629	0.39640	0.39651	0.39662	0.39673	0.39683	0.39694	0.54
0.46	0.39694	0.39703	0.39713	0.39723	0.39732	0.39741	0.39749	0.39758	0.39766	0.39774	0.39781	0.53
0.47	0.39781	0.39789	0.39796	0.39803	0.39809	0.39816	0.39822	0.39828	0.39834	0.39839	0.39844	0.52
0.48	0.39844	0.39849	0.39854	0.39858	0.39862	0.39866	0.39870	0.39873	0.39876	0.39879	0.39882	0.51
0.49	0.39882	0.39884	0.39886	0.39888	0.39890	0.39891	0.39892	0.39893	0.39894	0.39894	0.39894	0.50
0.010	0.009	0.008	0.007	0.006	0.005	0.004	0.003	0.002	0.001	0.000		$P(x)$

Linear interpolation yields an error no greater than 5 units in the fifth decimal place.

$$Z(x) = \frac{1}{\sqrt{2\pi}} e^{-\frac{1}{2}x^2} \quad P(x) = 1 - Q(x) = \int_{-\infty}^x Z(t) dt$$

Compiled from T. L. Kelley, The Kelley Statistical Tables. Harvard Univ. Press, Cambridge, Mass., 1948 (with permission).

Table 26.5 NORMAL PROBABILITY FUNCTION—VALUES OF x IN TERMS OF $P(x)$ AND $Q(x)$

$Q(x)$	0.000	0.001	0.002	0.003	0.004	0.005	0.006	0.007	0.008	0.009	0.010	
0.00	∞	3.09023	2.87816	2.74778	2.65207	2.57583	2.51214	2.45726	2.40892	2.36562	2.32635	0.99
0.01	2.32635	2.29037	2.25713	2.22621	2.19729	2.17009	2.14441	2.12007	2.09693	2.07485	2.05375	0.98
0.02	2.05375	2.03352	2.01409	1.99539	1.97737	1.95996	1.94313	1.92684	1.91104	1.89570	1.88079	0.97
0.03	1.88079	1.86630	1.85218	1.83842	1.82501	1.81191	1.79912	1.78661	1.77438	1.76241	1.75069	0.96
0.04	1.75069	1.73920	1.72793	1.71689	1.70604	1.69540	1.68494	1.67466	1.66456	1.65463	1.64485	0.95
0.05	1.64485	1.63523	1.62576	1.61644	1.60725	1.59819	1.58927	1.58047	1.57179	1.56322	1.55477	0.94
0.06	1.55477	1.54643	1.53820	1.53007	1.52204	1.51410	1.50626	1.49851	1.49085	1.48328	1.47579	0.93
0.07	1.47579	1.46838	1.46106	1.45381	1.44663	1.43953	1.43250	1.42554	1.41865	1.41183	1.40507	0.92
0.08	1.40507	1.39838	1.39174	1.38517	1.37866	1.37220	1.36581	1.35946	1.35317	1.34694	1.34076	0.91
0.09	1.34076	1.33462	1.32854	1.32251	1.31652	1.31058	1.30469	1.29884	1.29303	1.28727	1.28155	0.90
0.10	1.28155	1.27587	1.27024	1.26464	1.25908	1.25357	1.24808	1.24264	1.23723	1.23186	1.22653	0.89
0.11	1.22653	1.22123	1.21596	1.21072	1.20553	1.20036	1.19522	1.19012	1.18504	1.18000	1.17499	0.88
0.12	1.17499	1.17000	1.16505	1.16012	1.15522	1.15035	1.14551	1.14069	1.13590	1.13113	1.12639	0.87
0.13	1.12639	1.12168	1.11699	1.11232	1.10768	1.10306	1.09847	1.09390	1.08935	1.08482	1.08032	0.86
0.14	1.08032	1.07584	1.07138	1.06694	1.06252	1.05812	1.05374	1.04939	1.04505	1.04073	1.03643	0.85
0.15	1.03643	1.03215	1.02789	1.02365	1.01943	1.01522	1.01103	1.00686	1.00271	0.99858	0.99446	0.84
0.16	0.99446	0.99036	0.98627	0.98220	0.97815	0.97411	0.97009	0.96609	0.96210	0.95812	0.95416	0.83
0.17	0.95416	0.95022	0.94629	0.94238	0.93848	0.93458	0.93072	0.92686	0.92301	0.91918	0.91537	0.82
0.18	0.91537	0.91156	0.90777	0.90399	0.90023	0.89647	0.89273	0.88901	0.88529	0.88159	0.87790	0.81
0.19	0.87790	0.87422	0.87055	0.86689	0.86325	0.85962	0.85600	0.85239	0.84879	0.84520	0.84162	0.80
0.20	0.84162	0.83805	0.83450	0.83095	0.82742	0.82390	0.82038	0.81687	0.81338	0.80990	0.80642	0.79
0.21	0.80642	0.80296	0.79950	0.79606	0.79262	0.78919	0.78577	0.78237	0.77897	0.77557	0.77219	0.78
0.22	0.77219	0.76882	0.76546	0.76210	0.75875	0.75542	0.75208	0.74876	0.74545	0.74214	0.73885	0.77
0.23	0.73885	0.73556	0.73228	0.72900	0.72574	0.72248	0.71923	0.71599	0.71275	0.70952	0.70630	0.76
0.24	0.70630	0.70309	0.69988	0.69668	0.69349	0.69031	0.68713	0.68396	0.68080	0.67764	0.67449	0.75
0.25	0.67449	0.67135	0.66821	0.66508	0.66196	0.65884	0.65573	0.65262	0.64952	0.64643	0.64335	0.74
0.26	0.64335	0.64027	0.63719	0.63412	0.63106	0.62801	0.62496	0.62191	0.61887	0.61584	0.61281	0.73
0.27	0.61281	0.60979	0.60678	0.60376	0.60076	0.59776	0.59477	0.59178	0.58879	0.58581	0.58284	0.72
0.28	0.58284	0.57987	0.57691	0.57395	0.57100	0.56805	0.56511	0.56217	0.55924	0.55631	0.55338	0.71
0.29	0.55338	0.55047	0.54755	0.54464	0.54174	0.53884	0.53594	0.53305	0.53016	0.52728	0.52440	0.70
0.30	0.52440	0.52153	0.51866	0.51579	0.51293	0.51007	0.50722	0.50437	0.50153	0.49869	0.49585	0.69
0.31	0.49585	0.49302	0.49019	0.48736	0.48454	0.48173	0.47891	0.47610	0.47330	0.47050	0.46770	0.68
0.32	0.46770	0.46490	0.46211	0.45933	0.45654	0.45376	0.45099	0.44821	0.44544	0.44268	0.43991	0.67
0.33	0.43991	0.43715	0.43440	0.43164	0.42889	0.42615	0.42340	0.42066	0.41793	0.41519	0.41246	0.66
0.34	0.41246	0.40974	0.40701	0.40429	0.40157	0.39886	0.39614	0.39343	0.39073	0.38802	0.38532	0.65
0.35	0.38532	0.38262	0.37993	0.37723	0.37454	0.37186	0.36917	0.36649	0.36381	0.36113	0.35846	0.64
0.36	0.35846	0.35579	0.35312	0.35045	0.34779	0.34513	0.34247	0.33981	0.33716	0.33450	0.33185	0.63
0.37	0.33185	0.32921	0.32656	0.32392	0.32128	0.31864	0.31600	0.31337	0.31074	0.30811	0.30548	0.62
0.38	0.30548	0.30286	0.30023	0.29761	0.29499	0.29237	0.28976	0.28715	0.28454	0.28193	0.27932	0.61
0.39	0.27932	0.27671	0.27411	0.27151	0.26891	0.26631	0.26371	0.26112	0.25853	0.25594	0.25335	0.60
0.40	0.25335	0.25076	0.24817	0.24559	0.24301	0.24043	0.23785	0.23527	0.23269	0.23012	0.22754	0.59
0.41	0.22754	0.22497	0.22240	0.21983	0.21727	0.21470	0.21214	0.20957	0.20701	0.20445	0.20189	0.58
0.42	0.20189	0.19934	0.19678	0.19422	0.19167	0.18912	0.18657	0.18402	0.18147	0.17892	0.17637	0.57
0.43	0.17637	0.17383	0.17128	0.16874	0.16620	0.16366	0.16112	0.15858	0.15604	0.15351	0.15097	0.56
0.44	0.15097	0.14843	0.14590	0.14337	0.14084	0.13830	0.13577	0.13324	0.13072	0.12819	0.12566	0.55
0.45	0.12566	0.12314	0.12061	0.11809	0.11556	0.11304	0.11052	0.10799	0.10547	0.10295	0.10043	0.54
0.46	0.10043	0.09791	0.09540	0.09288	0.09036	0.08784	0.08533	0.08281	0.08030	0.07778	0.07527	0.53
0.47	0.07527	0.07276	0.07024	0.06773	0.06522	0.06271	0.06020	0.05768	0.05517	0.05266	0.05015	0.52
0.48	0.05015	0.04764	0.04513	0.04263	0.04012	0.03761	0.03510	0.03259	0.03008	0.02758	0.02507	0.51
0.49	0.02507	0.02256	0.02005	0.01755	0.01504	0.01253	0.01003	0.00752	0.00501	0.00251	0.00000	0.50
0.010	0.009	0.008	0.007	0.006	0.005	0.004	0.003	0.002	0.001	0.000		$P(x)$

For $Q(x) > 0.007$, linear interpolation yields an error of one unit in the third decimal place; five-point interpolation is necessary to obtain full accuracy.

$$P(x) = 1 - Q(x) = \int_{-\infty}^x Z(t) dt$$

Compiled from T. L. Kelley, The Kelley Statistical Tables. Harvard Univ. Press, Cambridge, Mass., 1948 (with permission).

PROBABILITY FUNCTIONS

NORMAL PROBABILITY FUNCTION—VALUES OF x FOR EXTREME VALUES OF $P(x)$ AND $Q(x)$ Table 26.6

$Q(x)$	0.0000	0.0001	0.0002	0.0003	0.0004	0.0005	0.0006	0.0007	0.0008	0.0009	0.0010	
0.000	∞	3.71902	3.54008	3.43161	3.35279	3.29053	3.23888	3.19465	3.15591	3.12139	3.09023	0.999
0.001	3.09023	3.06181	3.03567	3.01145	2.98888	2.96774	2.94784	2.92905	2.91124	2.89430	2.87816	0.998
0.002	2.87816	2.86274	2.84796	2.83379	2.82016	2.80703	2.79438	2.78215	2.77033	2.75888	2.74778	0.997
0.003	2.74778	2.73701	2.72655	2.71638	2.70648	2.69684	2.68745	2.67829	2.66934	2.66061	2.65207	0.996
0.004	2.65207	2.64372	2.63555	2.62756	2.61973	2.61205	2.60453	2.59715	2.58991	2.58281	2.57583	0.995
0.005	2.57583	2.56897	2.56224	2.55562	2.54910	2.54270	2.53640	2.53019	2.52408	2.51807	2.51214	0.994
0.006	2.51214	2.50631	2.50055	2.49488	2.48929	2.48377	2.47833	2.47296	2.46765	2.46243	2.45726	0.993
0.007	2.45726	2.45216	2.44713	2.44215	2.43724	2.43238	2.42758	2.42283	2.41814	2.41350	2.40891	0.992
0.008	2.40891	2.40437	2.39989	2.39545	2.39106	2.38671	2.38240	2.37814	2.37392	2.36975	2.36562	0.991
0.009	2.36562	2.36152	2.35747	2.35345	2.34947	2.34553	2.34162	2.33775	2.33392	2.33012	2.32635	0.990
0.010	2.32635	2.32261	2.31891	2.31524	2.31160	2.30798	2.30440	2.30085	2.29733	2.29383	2.29037	0.989
0.011	2.29037	2.28693	2.28352	2.28013	2.27677	2.27343	2.27013	2.26684	2.26358	2.26034	2.25713	0.988
0.012	2.25713	2.25394	2.25077	2.24763	2.24450	2.24140	2.23832	2.23526	2.23223	2.22921	2.22621	0.987
0.013	2.22621	2.22323	2.22028	2.21734	2.21442	2.21152	2.20864	2.20577	2.20293	2.20010	2.19729	0.986
0.014	2.19729	2.19449	2.19172	2.18896	2.18621	2.18349	2.18078	2.17808	2.17540	2.17274	2.17009	0.985
0.015	2.17009	2.16746	2.16484	2.16224	2.15965	2.15707	2.15451	2.15197	2.14943	2.14692	2.14441	0.984
0.016	2.14441	2.14192	2.13944	2.13698	2.13452	2.13208	2.12966	2.12724	2.12484	2.12245	2.12007	0.983
0.017	2.12007	2.11771	2.11535	2.11301	2.11068	2.10836	2.10605	2.10375	2.10147	2.09919	2.09693	0.982
0.018	2.09693	2.09467	2.09243	2.09020	2.08798	2.08576	2.08356	2.08137	2.07919	2.07702	2.07485	0.981
0.019	2.07485	2.07270	2.07056	2.06843	2.06630	2.06419	2.06208	2.05998	2.05790	2.05582	2.05375	0.980
0.020	2.05375	2.05169	2.04964	2.04759	2.04556	2.04353	2.04151	2.03950	2.03750	2.03551	2.03352	0.979
0.021	2.03352	2.03154	2.02957	2.02761	2.02566	2.02371	2.02177	2.01984	2.01792	2.01600	2.01409	0.978
0.022	2.01409	2.01219	2.01029	2.00841	2.00653	2.00465	2.00279	2.00093	1.99908	1.99723	1.99539	0.977
0.023	1.99539	1.99356	1.99174	1.98992	1.98811	1.98630	1.98450	1.98271	1.98092	1.97914	1.97737	0.976
0.024	1.97737	1.97560	1.97384	1.97208	1.97033	1.96859	1.96685	1.96512	1.96340	1.96168	1.95996	0.975
	0.0010	0.0009	0.0008	0.0007	0.0006	0.0005	0.0004	0.0003	0.0002	0.0001	0.0000	$P(x)$

For $Q(x) > 0.0007$, linear interpolation yields an error of one unit in the third decimal place; five-point interpolation is necessary to obtain full accuracy.

$Q(x)$	x	$Q(x)$	x	$Q(x)$	x	$Q(x)$	x
(-4) 1.0	3.71902	(-9) 1.0	5.99781	(-14) 1.0	7.65063	(-19) 1.0	9.01327
(-5) 1.0	4.26489	(-10) 1.0	6.36134	(-15) 1.0	7.94135	(-20) 1.0	9.26234
(-6) 1.0	4.75342	(-11) 1.0	6.70602	(-16) 1.0	8.22208	(-21) 1.0	9.50502
(-7) 1.0	5.19934	(-12) 1.0	7.03448	(-17) 1.0	8.49379	(-22) 1.0	9.74179
(-8) 1.0	5.61200	(-13) 1.0	7.34880	(-18) 1.0	8.75729	(-23) 1.0	9.97305

$$P(x) = 1 - Q(x) = \int_{-\infty}^x Z(t) dt$$

Compiled from T. L. Kelley, The Kelley Statistical Tables. Harvard Univ. Press, Cambridge, Mass., 1948 (with permission) for $Q(x) > (-9)1$.

Table 26.7 PROBABILITY INTEGRAL OF χ^2 -DISTRIBUTION, INCOMPLETE GAMMA FUNCTION CUMULATIVE SUMS OF THE POISSON DISTRIBUTION

ν	$\chi^2=0.001$ $m=0.0005$	0.002	0.003	0.004	0.005	0.006	0.007	0.008	0.009	0.010
1	0.97477	0.96433	0.95632	0.94957	0.94363	0.93826	0.93332	0.92873	0.92442	0.92034
2	0.99950	0.99900	0.99850	0.99800	0.99750	0.99700	0.99651	0.99601	0.99551	0.99501
3	0.99999	0.99998	0.99996	0.99993	0.99991	0.99988	0.99984	0.99981	0.99977	0.99973
4							0.99999	0.99999	0.99999	0.99999
ν	$\chi^2=0.01$ $m=0.005$	0.02	0.03	0.04	0.05	0.06	0.07	0.08	0.09	0.10
1	0.92034	0.88754	0.86249	0.84148	0.82306	0.80650	0.79134	0.77730	0.76418	0.75183
2	0.99501	0.99005	0.98511	0.98020	0.97531	0.97045	0.96561	0.96079	0.95600	0.95123
3	0.99973	0.99925	0.99863	0.99790	0.99707	0.99616	0.99518	0.99412	0.99301	0.99184
4	0.99999	0.99995	0.99989	0.99980	0.99969	0.99956	0.99940	0.99922	0.99902	0.99879
5			0.99999	0.99998	0.99997	0.99995	0.99993	0.99991	0.99987	0.99984
6							0.99999	0.99999	0.99999	0.99998
ν	$\chi^2=0.1$ $m=0.05$	0.2	0.3	0.4	0.5	0.6	0.7	0.8	0.9	1.0
1	0.75183	0.65472	0.58388	0.52709	0.47950	0.43858	0.40278	0.37109	0.34278	0.31731
2	0.95123	0.90484	0.86071	0.81873	0.77880	0.74082	0.70469	0.67032	0.63763	0.60653
3	0.99184	0.97759	0.96003	0.94024	0.91889	0.89643	0.87320	0.84947	0.82543	0.80125
4	0.99879	0.99532	0.98981	0.98248	0.97350	0.96306	0.95133	0.93845	0.92456	0.90980
5	0.99984	0.99911	0.99764	0.99533	0.99212	0.98800	0.98297	0.97703	0.97022	0.96257
6	0.99998	0.99985	0.99950	0.99885	0.99784	0.99640	0.99449	0.99207	0.98912	0.98561
7		0.99997	0.99990	0.99974	0.99945	0.99899	0.99834	0.99744	0.99628	0.99483
8			0.99998	0.99994	0.99987	0.99973	0.99953	0.99922	0.99880	0.99825
9				0.99999	0.99997	0.99993	0.99987	0.99978	0.99964	0.99944
10					0.99999	0.99998	0.99997	0.99994	0.99989	0.99983
11							0.99999	0.99998	0.99997	0.99995
12								0.99999	0.99999	0.99999
ν	$\chi^2=1.1$ $m=0.55$	1.2	1.3	1.4	1.5	1.6	1.7	1.8	1.9	2.0
1	0.29427	0.27332	0.25421	0.23672	0.22067	0.20590	0.19229	0.17971	0.16808	0.15730
2	0.57695	0.54881	0.52205	0.49659	0.47237	0.44933	0.42741	0.40657	0.38674	0.36788
3	0.77707	0.75300	0.72913	0.70553	0.68227	0.65939	0.63693	0.61493	0.59342	0.57241
4	0.89427	0.87810	0.86138	0.84420	0.82664	0.80879	0.79072	0.77248	0.75414	0.73576
5	0.95410	0.94488	0.93493	0.92431	0.91307	0.90125	0.88890	0.87607	0.86280	0.84915
6	0.98154	0.97689	0.97166	0.96586	0.95949	0.95258	0.94512	0.93714	0.92866	0.91970
7	0.99305	0.99093	0.98844	0.98557	0.98231	0.97864	0.97457	0.97008	0.96517	0.95984
8	0.99753	0.99664	0.99555	0.99425	0.99271	0.99092	0.98887	0.98654	0.98393	0.98101
9	0.99917	0.99882	0.99838	0.99782	0.99715	0.99633	0.99537	0.99425	0.99295	0.99147
10	0.99973	0.99961	0.99944	0.99921	0.99894	0.99859	0.99817	0.99766	0.99705	0.99634
11	0.99992	0.99987	0.99981	0.99973	0.99962	0.99948	0.99930	0.99908	0.99882	0.99850
12	0.99998	0.99996	0.99994	0.99991	0.99987	0.99982	0.99975	0.99966	0.99954	0.99941
13	0.99999	0.99999	0.99998	0.99997	0.99996	0.99994	0.99991	0.99988	0.99983	0.99977
14			0.99999	0.99999	0.99999	0.99998	0.99997	0.99996	0.99994	0.99992
15						0.99999	0.99999	0.99999	0.99998	0.99997
16								0.99999	0.99999	0.99999

$$Q(\chi^2|\nu) = 1 - P(\chi^2|\nu) = \left[2^{\frac{\nu}{2}} \Gamma\left(\frac{\nu}{2}\right) \right]^{-1} \int_{\chi^2}^{\infty} t^{-\frac{\nu}{2}} e^{-\frac{t}{2}} dt = \left[\Gamma\left(\frac{\nu}{2}\right) \right]^{-1} \int_{\frac{\chi^2}{2}}^{\infty} e^{-t} t^{\frac{\nu}{2}-1} dt = \sum_{j=0}^{c-1} e^{-m} m^j / j! \quad (\nu \text{ even, } c = \frac{1}{2}\nu, m = \frac{1}{2}\chi^2)$$

Compiled from E. S. Pearson and H. O. Hartley (editors), *Biometrika tables for statisticians*, vol. I. Cambridge Univ. Press, Cambridge, England, 1954 (with permission).

PROBABILITY INTEGRAL OF χ^2 -DISTRIBUTION, INCOMPLETE GAMMA FUNCTION Table 26.7
CUMULATIVE SUMS OF THE POISSON DISTRIBUTION

ν	$x^2=2.2$	2.4	2.6	2.8	3.0	3.2	3.4	3.6	3.8	4.0
	$m=1.1$	1.2	1.3	1.4	1.5	1.6	1.7	1.8	1.9	2.0
1	0.13801	0.12134	0.10686	0.09426	0.08327	0.07364	0.06520	0.05778	0.05125	0.04550
2	0.33287	0.30119	0.27253	0.24660	0.22313	0.20190	0.18268	0.16530	0.14957	0.13534
3	0.53195	0.49363	0.45749	0.42350	0.39163	0.36181	0.33397	0.30802	0.28389	0.26146
4	0.69903	0.66263	0.62682	0.59183	0.55783	0.52493	0.49325	0.46284	0.43375	0.40601
5	0.82084	0.79147	0.76137	0.73079	0.69999	0.66918	0.63857	0.60831	0.57856	0.54942
6	0.90042	0.87949	0.85711	0.83350	0.80885	0.78336	0.75722	0.73062	0.70372	0.67668
7	0.94795	0.93444	0.91938	0.90287	0.88500	0.86590	0.84570	0.82452	0.80250	0.77978
8	0.97426	0.96623	0.95691	0.94628	0.93436	0.92119	0.90681	0.89129	0.87470	0.85712
9	0.98790	0.98345	0.97807	0.97170	0.96430	0.95583	0.94631	0.93572	0.92408	0.91141
10	0.99457	0.99225	0.98934	0.98575	0.98142	0.97632	0.97039	0.96359	0.95592	0.94735
11	0.99766	0.99652	0.99503	0.99311	0.99073	0.98781	0.98431	0.98019	0.97541	0.96992
12	0.99903	0.99850	0.99777	0.99680	0.99554	0.99396	0.99200	0.98962	0.98678	0.98344
13	0.99961	0.99938	0.99903	0.99856	0.99793	0.99711	0.99606	0.99475	0.99314	0.99119
14	0.99985	0.99975	0.99960	0.99938	0.99907	0.99866	0.99813	0.99743	0.99655	0.99547
15	0.99994	0.99990	0.99984	0.99974	0.99960	0.99940	0.99913	0.99878	0.99832	0.99774
16	0.99998	0.99996	0.99994	0.99989	0.99983	0.99974	0.99961	0.99944	0.99921	0.99890
17	0.99999	0.99999	0.99998	0.99996	0.99993	0.99989	0.99983	0.99975	0.99964	0.99948
18			0.99999	0.99998	0.99997	0.99995	0.99993	0.99989	0.99984	0.99976
19				0.99999	0.99999	0.99998	0.99997	0.99995	0.99993	0.99989
20					0.99999	0.99999	0.99999	0.99998	0.99997	0.99995
21								0.99999	0.99999	0.99998
22										0.99999
ν	$x^2=4.2$	4.4	4.6	4.8	5.0	5.2	5.4	5.6	5.8	6.0
	$m=2.1$	2.2	2.3	2.4	2.5	2.6	2.7	2.8	2.9	3.0
1	0.04042	0.03594	0.03197	0.02846	0.02535	0.02259	0.02014	0.01796	0.01603	0.01431
2	0.12246	0.11080	0.10026	0.09072	0.08209	0.07427	0.06721	0.06081	0.05502	0.04979
3	0.24066	0.22139	0.20354	0.18704	0.17180	0.15772	0.14474	0.13278	0.12176	0.11161
4	0.37962	0.35457	0.33085	0.30844	0.28730	0.26739	0.24866	0.23108	0.21459	0.19915
5	0.52099	0.49337	0.46662	0.44077	0.41588	0.39196	0.36904	0.34711	0.32617	0.30622
6	0.64963	0.62271	0.59604	0.56971	0.54381	0.51843	0.49363	0.46945	0.44596	0.42319
7	0.75647	0.73272	0.70864	0.68435	0.65996	0.63557	0.61127	0.58715	0.56329	0.53975
8	0.83864	0.81935	0.79935	0.77872	0.75758	0.73600	0.71409	0.69194	0.66962	0.64723
9	0.89776	0.88317	0.86769	0.85138	0.83431	0.81654	0.79814	0.77919	0.75976	0.73992
10	0.93787	0.92750	0.91625	0.90413	0.89118	0.87742	0.86291	0.84768	0.83178	0.81526
11	0.96370	0.95672	0.94898	0.94046	0.93117	0.92109	0.91026	0.89868	0.88637	0.87337
12	0.97955	0.97509	0.97002	0.96433	0.95798	0.95096	0.94327	0.93489	0.92583	0.91608
13	0.98887	0.98614	0.98298	0.97934	0.97519	0.97052	0.96530	0.95951	0.95313	0.94615
14	0.99414	0.99254	0.99064	0.98841	0.98581	0.98283	0.97943	0.97559	0.97128	0.96649
15	0.99701	0.99610	0.99501	0.99369	0.99213	0.99029	0.98816	0.98571	0.98291	0.97975
16	0.99851	0.99802	0.99741	0.99666	0.99575	0.99467	0.99338	0.99187	0.99012	0.98810
17	0.99928	0.99902	0.99869	0.99828	0.99777	0.99715	0.99639	0.99550	0.99443	0.99319
18	0.99966	0.99953	0.99936	0.99914	0.99886	0.99851	0.99809	0.99757	0.99694	0.99620
19	0.99985	0.99978	0.99969	0.99958	0.99943	0.99924	0.99901	0.99872	0.99836	0.99793
20	0.99993	0.99990	0.99986	0.99980	0.99972	0.99962	0.99950	0.99934	0.99914	0.99890
21	0.99997	0.99995	0.99993	0.99991	0.99987	0.99982	0.99975	0.99967	0.99956	0.99943
22	0.99999	0.99998	0.99997	0.99996	0.99994	0.99991	0.99988	0.99984	0.99978	0.99971
23	0.99999	0.99999	0.99999	0.99998	0.99997	0.99996	0.99994	0.99992	0.99989	0.99986
24			0.99999	0.99999	0.99999	0.99998	0.99997	0.99996	0.99995	0.99993
25				0.99999	0.99999	0.99999	0.99999	0.99998	0.99998	0.99997
26					$\phi^{-\frac{1}{2}}(x^2-x_0^2)$	$w=\nu-\nu_0>0$		0.99999	0.99999	0.99998
27								0.99999	0.99999	0.99999

Interpolation on x^2

$$Q(x^2|\nu) = Q(x_0^2|\nu_0-4) \left[\frac{1}{2} \phi^2 \right] + Q(x_0^2|\nu_0-2) \left[\phi - \phi^2 \right] + Q(x_0^2|\nu_0) \left[1 - \phi + \frac{1}{2} \phi^2 \right]$$

Double Entry Interpolation

$$Q(x^2|\nu) = Q(x_0^2|\nu_0-4) \left[\frac{1}{2} \phi^2 \right] + Q(x_0^2|\nu_0-2) \left[\phi - \phi^2 - w\phi \right] + Q(x_0^2|\nu_0-1) \left[\frac{1}{2} w^2 - \frac{1}{2} w + w\phi \right] \\ + Q(x_0^2|\nu_0) \left[1 - w^2 - \phi + \frac{1}{2} \phi^2 + w\phi \right] + Q(x_0^2|\nu_0+1) \left[\frac{1}{2} w^2 + \frac{1}{2} w - w\phi \right]$$

Table 26.7 PROBABILITY INTEGRAL OF χ^2 -DISTRIBUTION, INCOMPLETE GAMMA FUNCTION
CUMULATIVE SUMS OF THE POISSON DISTRIBUTION

ν	χ^2									
	6.2	6.4	6.6	6.8	7.0	7.2	7.4	7.6	7.8	8.0
	$m=3.1$	3.2	3.3	3.4	3.5	3.6	3.7	3.8	3.9	4.0
1	0.01278	0.01141	0.01020	0.00912	0.00815	0.00729	0.00652	0.00584	0.00522	0.00468
2	0.04505	0.04076	0.03688	0.03337	0.03020	0.02732	0.02472	0.02237	0.02024	0.01832
3	0.10228	0.09369	0.08580	0.07855	0.07190	0.06579	0.06018	0.05504	0.05033	0.04601
4	0.18470	0.17120	0.15860	0.14684	0.13589	0.12569	0.11620	0.10738	0.09919	0.09158
5	0.28724	0.26922	0.25213	0.23595	0.22064	0.20619	0.19255	0.17970	0.16761	0.15624
6	0.40116	0.37990	0.35943	0.33974	0.32085	0.30275	0.28543	0.26890	0.25313	0.23810
7	0.51660	0.49390	0.47168	0.45000	0.42888	0.40836	0.38845	0.36918	0.35056	0.33259
8	0.62484	0.60252	0.58034	0.55836	0.53663	0.51522	0.49415	0.47349	0.45325	0.43347
9	0.71975	0.69931	0.67869	0.65793	0.63712	0.61631	0.59555	0.57490	0.55442	0.53415
10	0.79819	0.78061	0.76259	0.74418	0.72544	0.70644	0.68722	0.66784	0.64837	0.62884
11	0.85969	0.84539	0.83049	0.81504	0.79908	0.78266	0.76583	0.74862	0.73110	0.71330
12	0.90567	0.89459	0.88288	0.87054	0.85761	0.84412	0.83009	0.81556	0.80056	0.78513
13	0.93857	0.93038	0.92157	0.91216	0.90215	0.89155	0.88038	0.86865	0.85638	0.84360
14	0.96120	0.95538	0.94903	0.94215	0.93471	0.92673	0.91819	0.90911	0.89948	0.88933
15	0.97619	0.97222	0.96782	0.96296	0.95765	0.95186	0.94559	0.93882	0.93155	0.92378
16	0.98579	0.98317	0.98022	0.97693	0.97326	0.96921	0.96476	0.95989	0.95460	0.94887
17	0.99174	0.99007	0.98816	0.98599	0.98355	0.98081	0.97775	0.97437	0.97064	0.96655
18	0.99532	0.99429	0.99309	0.99171	0.99013	0.98833	0.98630	0.98402	0.98147	0.97864
19	0.99741	0.99679	0.99606	0.99521	0.99421	0.99307	0.99176	0.99026	0.98857	0.98667
20	0.99860	0.99824	0.99781	0.99729	0.99669	0.99598	0.99515	0.99420	0.99311	0.99187
21	0.99926	0.99905	0.99880	0.99850	0.99814	0.99771	0.99721	0.99662	0.99594	0.99514
22	0.99962	0.99950	0.99936	0.99919	0.99898	0.99873	0.99843	0.99807	0.99765	0.99716
23	0.99981	0.99974	0.99967	0.99957	0.99945	0.99931	0.99913	0.99892	0.99867	0.99837
24	0.99990	0.99987	0.99983	0.99978	0.99971	0.99963	0.99953	0.99941	0.99926	0.99908
25	0.99995	0.99994	0.99991	0.99989	0.99985	0.99981	0.99975	0.99968	0.99960	0.99949
26	0.99998	0.99997	0.99996	0.99994	0.99992	0.99990	0.99987	0.99983	0.99978	0.99973
27	0.99999	0.99999	0.99998	0.99997	0.99996	0.99995	0.99993	0.99991	0.99989	0.99985
28		0.99999	0.99999	0.99999	0.99998	0.99998	0.99997	0.99996	0.99994	0.99992
29			0.99999	0.99999	0.99999	0.99999	0.99998	0.99998	0.99997	0.99996
30				0.99999	0.99999	0.99999	0.99999	0.99999	0.99999	0.99998
	$\chi^2=8.2$	8.4	8.6	8.8	9.0	9.2	9.4	9.6	9.8	10.0
	$m=4.1$	4.2	4.3	4.4	4.5	4.6	4.7	4.8	4.9	5.0
1	0.00419	0.00375	0.00336	0.00301	0.00270	0.00242	0.00217	0.00195	0.00175	0.00157
2	0.01657	0.01500	0.01357	0.01228	0.01111	0.01005	0.00910	0.00823	0.00745	0.00674
3	0.04205	0.03843	0.03511	0.03207	0.02929	0.02675	0.02442	0.02229	0.02034	0.01857
4	0.08452	0.07798	0.07191	0.06630	0.06110	0.05629	0.05184	0.04773	0.04394	0.04043
5	0.14555	0.13553	0.12612	0.11731	0.10906	0.10135	0.09413	0.08740	0.08110	0.07524
6	0.22381	0.21024	0.19736	0.18514	0.17358	0.16264	0.15230	0.14254	0.13333	0.12465
7	0.31529	0.29865	0.28266	0.26734	0.25266	0.23861	0.22520	0.21240	0.20019	0.18857
8	0.41418	0.39540	0.37715	0.35945	0.34230	0.32571	0.30968	0.29423	0.27935	0.26503
9	0.51412	0.49439	0.47499	0.45594	0.43727	0.41902	0.40120	0.38383	0.36692	0.35049
10	0.60931	0.58983	0.57044	0.55118	0.53210	0.51323	0.49461	0.47626	0.45821	0.44049
11	0.69528	0.67709	0.65876	0.64035	0.62189	0.60344	0.58502	0.56669	0.54846	0.53039
12	0.76931	0.75314	0.73666	0.71991	0.70293	0.68576	0.66844	0.65101	0.63350	0.61596
13	0.83033	0.81660	0.80244	0.78788	0.77294	0.75768	0.74211	0.72627	0.71020	0.69393
14	0.87865	0.86746	0.85579	0.84365	0.83105	0.81803	0.80461	0.79081	0.77666	0.76218
15	0.91551	0.90675	0.89749	0.88774	0.87752	0.86683	0.85569	0.84412	0.83213	0.81974
16	0.94269	0.93606	0.92897	0.92142	0.91341	0.90495	0.89603	0.88667	0.87686	0.86663
17	0.96208	0.95723	0.95198	0.94633	0.94026	0.93378	0.92687	0.91954	0.91179	0.90361
18	0.97551	0.97207	0.96830	0.96420	0.95974	0.95493	0.94974	0.94418	0.93824	0.93191
19	0.98454	0.98217	0.97955	0.97666	0.97348	0.97001	0.96623	0.96213	0.95771	0.95295
20	0.99046	0.98887	0.98709	0.98511	0.98291	0.98047	0.97779	0.97486	0.97166	0.96817
21	0.99424	0.99320	0.99203	0.99070	0.98921	0.98755	0.98570	0.98365	0.98139	0.97891
22	0.99659	0.99593	0.99518	0.99431	0.99333	0.99222	0.99098	0.98958	0.98803	0.98630
23	0.99802	0.99761	0.99714	0.99659	0.99596	0.99524	0.99442	0.99349	0.99245	0.99128
24	0.99888	0.99863	0.99833	0.99799	0.99760	0.99714	0.99661	0.99601	0.99532	0.99455
25	0.99937	0.99922	0.99905	0.99884	0.99860	0.99831	0.99798	0.99760	0.99716	0.99665
26	0.99966	0.99957	0.99947	0.99934	0.99919	0.99902	0.99882	0.99858	0.99830	0.99798
27	0.99981	0.99977	0.99971	0.99963	0.99955	0.99944	0.99932	0.99917	0.99900	0.99880
28	0.99990	0.99987	0.99984	0.99980	0.99975	0.99969	0.99962	0.99953	0.99942	0.99930
29	0.99995	0.99993	0.99991	0.99989	0.99986	0.99983	0.99979	0.99973	0.99967	0.99960
30	0.99997	0.99997	0.99996	0.99994	0.99993	0.99991	0.99988	0.99985	0.99982	0.99977

$$Q(\chi^2|\nu) = 1 - P(\chi^2|\nu) = \left[2^{\frac{\nu}{2}} \Gamma\left(\frac{\nu}{2}\right) \right]^{-1} \int_{\chi^2}^{\infty} e^{-t/2} t^{\frac{\nu}{2}-1} dt = \left[\Gamma\left(\frac{\nu}{2}\right) \right]^{-1} \int_{\frac{\chi^2}{2}}^{\infty} e^{-t} t^{\frac{\nu}{2}-1} dt = \sum_{j=0}^{c-1} e^{-m} m^j / j! \quad (\nu \text{ even}, c = \frac{1}{2}\nu, m = \frac{1}{2}\chi^2)$$

Table 26.7

PROBABILITY INTEGRAL OF χ^2 -DISTRIBUTION, INCOMPLETE GAMMA FUNCTION
CUMULATIVE SUMS OF THE POISSON DISTRIBUTION

		$\chi^2=10.5$	11.0	11.5	12.0	12.5	13.0	13.5	14.0	14.5	15.0
ν	$m =$	5.25	5.5	5.75	6.0	6.25	6.5	6.75	7.0	7.25	7.5
1		0.00119	0.00091	0.00070	0.00053	0.00041	0.00031	0.00024	0.00018	0.00014	0.00011
2		0.00525	0.00409	0.00318	0.00248	0.00193	0.00150	0.00117	0.00091	0.00071	0.00055
3		0.01476	0.01173	0.00931	0.00738	0.00585	0.00464	0.00367	0.00291	0.00230	0.00182
4		0.03280	0.02656	0.02148	0.01735	0.01400	0.01128	0.00907	0.00730	0.00586	0.00470
5		0.06225	0.05138	0.04232	0.03479	0.02854	0.02338	0.01912	0.01561	0.01273	0.01036
6		0.10511	0.08838	0.07410	0.06197	0.05170	0.04304	0.03575	0.02964	0.02452	0.02026
7		0.16196	0.13862	0.11825	0.10056	0.08527	0.07211	0.06082	0.05118	0.04297	0.03600
8		0.23167	0.20170	0.17495	0.15120	0.13025	0.11185	0.09577	0.08177	0.06963	0.05915
9		0.31154	0.27571	0.24299	0.21331	0.18657	0.16261	0.14126	0.12233	0.10562	0.09094
10		0.39777	0.35752	0.31991	0.28506	0.25299	0.22367	0.19704	0.17299	0.15138	0.13206
11		0.48605	0.44326	0.40237	0.36364	0.32726	0.29333	0.26190	0.23299	0.20655	0.18250
12		0.57218	0.52892	0.48662	0.44568	0.40640	0.36904	0.33377	0.30071	0.26992	0.24144
13		0.65263	0.61082	0.56901	0.52764	0.48713	0.44781	0.40997	0.37384	0.33960	0.30735
14		0.72479	0.68604	0.64639	0.60630	0.56622	0.52652	0.48759	0.44971	0.41316	0.37815
15		0.78717	0.75259	0.71641	0.67903	0.64086	0.60230	0.56374	0.52553	0.48800	0.45142
16		0.83925	0.80949	0.77762	0.74398	0.70890	0.67276	0.63591	0.59871	0.56152	0.52464
17		0.88135	0.85656	0.82942	0.80014	0.76896	0.73619	0.70212	0.66710	0.63145	0.59548
18		0.91436	0.89436	0.87195	0.84724	0.82038	0.79157	0.76106	0.72909	0.69596	0.66197
19		0.93952	0.92384	0.90587	0.88562	0.86316	0.83857	0.81202	0.78369	0.75380	0.72260
20		0.95817	0.94622	0.93221	0.91608	0.89779	0.87738	0.85492	0.83050	0.80427	0.77641
21		0.97166	0.96279	0.95214	0.93962	0.92513	0.90862	0.89010	0.86960	0.84718	0.82295
22		0.98118	0.97475	0.96686	0.95738	0.94618	0.93316	0.91827	0.90148	0.88279	0.86224
23		0.98773	0.98319	0.97748	0.97047	0.96201	0.95199	0.94030	0.92687	0.91165	0.89463
24		0.99216	0.98901	0.98498	0.97991	0.97367	0.96612	0.95715	0.94665	0.93454	0.92076
25		0.99507	0.99295	0.99015	0.98657	0.98206	0.97650	0.96976	0.96173	0.95230	0.94138
26		0.99696	0.99555	0.99366	0.99117	0.98798	0.98397	0.97902	0.97300	0.96581	0.95733
27		0.99815	0.99724	0.99598	0.99429	0.99208	0.98925	0.98567	0.98125	0.97588	0.96943
28		0.99890	0.99831	0.99749	0.99637	0.99487	0.99290	0.99037	0.98719	0.98324	0.97844
29		0.99935	0.99899	0.99846	0.99773	0.99672	0.99538	0.99363	0.99138	0.98854	0.98502
30		0.99963	0.99940	0.99907	0.99860	0.99794	0.99704	0.99585	0.99428	0.99227	0.98974
		$\chi^2=15.5$	16.0	16.5	17.0	17.5	18.0	18.5	19.0	19.5	20.0
ν	$m =$	7.75	8.0	8.25	8.5	8.75	9.0	9.25	9.5	9.75	10.0
1		0.00008	0.00006	0.00005	0.00004	0.00003	0.00002	0.00002	0.00001	0.00001	0.00001
2		0.00043	0.00034	0.00026	0.00020	0.00016	0.00012	0.00010	0.00008	0.00006	0.00005
3		0.00144	0.00113	0.00090	0.00071	0.00056	0.00044	0.00035	0.00027	0.00022	0.00017
4		0.00377	0.00302	0.00242	0.00193	0.00154	0.00123	0.00099	0.00079	0.00063	0.00050
5		0.00843	0.00684	0.00555	0.00450	0.00364	0.00295	0.00238	0.00192	0.00155	0.00125
6		0.01670	0.01375	0.01131	0.00928	0.00761	0.00623	0.00510	0.00416	0.00340	0.00277
7		0.03010	0.02512	0.02092	0.01740	0.01444	0.01197	0.00991	0.00819	0.00676	0.00557
8		0.05012	0.04238	0.03576	0.03011	0.02530	0.02123	0.01777	0.01486	0.01240	0.01034
9		0.07809	0.06688	0.05715	0.04872	0.04144	0.03517	0.02980	0.02519	0.02126	0.01791
10		0.11487	0.09963	0.08619	0.07436	0.06401	0.05496	0.04709	0.04026	0.03435	0.02925
11		0.16073	0.14113	0.12356	0.10788	0.09393	0.08158	0.07068	0.06109	0.05269	0.04534
12		0.21522	0.19124	0.16939	0.14960	0.13174	0.11569	0.10133	0.08853	0.07716	0.06709
13		0.27719	0.24913	0.22318	0.19930	0.17744	0.15752	0.13944	0.12310	0.10840	0.09521
14		0.34485	0.31337	0.28380	0.25618	0.23051	0.20678	0.18495	0.16495	0.14671	0.13014
15		0.41604	0.38205	0.34962	0.31886	0.28986	0.26267	0.23729	0.21373	0.19196	0.17193
16		0.48837	0.45296	0.41864	0.38560	0.35398	0.32390	0.29544	0.26866	0.24359	0.22022
17		0.55951	0.52383	0.48871	0.45437	0.42102	0.38884	0.35797	0.32853	0.30060	0.27423
18		0.62740	0.59255	0.55770	0.52311	0.48902	0.45565	0.42320	0.39182	0.36166	0.33282
19		0.69033	0.65728	0.62370	0.58987	0.55603	0.52244	0.48931	0.45684	0.42521	0.39458
20		0.74712	0.71662	0.68516	0.65297	0.62031	0.58741	0.55451	0.52183	0.48957	0.45793
21		0.79705	0.76965	0.74093	0.71111	0.68039	0.64900	0.61718	0.58514	0.55310	0.52126
22		0.83990	0.81589	0.79032	0.76336	0.73519	0.70599	0.67597	0.64533	0.61428	0.58304
23		0.87582	0.85272	0.83304	0.80925	0.78402	0.75749	0.72983	0.70122	0.67185	0.64191
24		0.90527	0.88808	0.86919	0.84866	0.82657	0.80301	0.77810	0.75199	0.72483	0.69678
25		0.92891	0.91483	0.89912	0.88179	0.86287	0.84239	0.82044	0.79712	0.77254	0.74683
26		0.94749	0.93620	0.92341	0.90908	0.89320	0.87577	0.85683	0.83643	0.81464	0.79156
27		0.96182	0.95295	0.94274	0.93112	0.91806	0.90352	0.88750	0.87000	0.85107	0.83076
28		0.97266	0.96582	0.95782	0.94859	0.93805	0.92615	0.91285	0.89814	0.88200	0.86446
29		0.98071	0.97554	0.96939	0.96218	0.95383	0.94427	0.93344	0.92129	0.90779	0.89293
30		0.98659	0.98274	0.97810	0.97258	0.96608	0.95853	0.94986	0.94001	0.92891	0.91654

$$\phi = \frac{1}{2}(\chi^2 - \chi_0^2) \quad w = \nu - \nu_0 > 0$$

Interpolation on χ^2

$$Q(\chi^2|\nu) = Q(\chi_0^2|\nu_0-4)\left[\frac{1}{2}\phi^2\right] + Q(\chi_0^2|\nu_0-2)\left[\phi - \phi^2\right] + Q(\chi_0^2|\nu_0)\left[1 - \phi + \frac{1}{2}\phi^2\right]$$

Double Entry Interpolation

$$Q(\chi^2|\nu) = Q(\chi_0^2|\nu_0-4)\left[\frac{1}{2}\phi^2\right] + Q(\chi_0^2|\nu_0-2)\left[\phi - \phi^2 - w\phi\right] + Q(\chi_0^2|\nu_0-1)\left[\frac{1}{2}w^2 - \frac{1}{2}w + w\phi\right] \\ + Q(\chi_0^2|\nu_0)\left[1 - w^2 - \phi + \frac{1}{2}\phi^2 + w\phi\right] + Q(\chi_0^2|\nu_0+1)\left[\frac{1}{2}w^2 + \frac{1}{2}w - w\phi\right]$$

Table 26.7 PROBABILITY INTEGRAL OF χ^2 -DISTRIBUTION, INCOMPLETE GAMMA FUNCTION
CUMULATIVE SUMS OF THE POISSON DISTRIBUTION

	$\chi^2 = 21$	22	23	24	25	26	27	28	29	30
ν	$m = 10.5$	11.0	11.5	12.0	12.5	13.0	13.5	14.0	14.5	15.0
1	0.00001									
2	0.00003	0.00002	0.00001	0.00001						
3	0.00011	0.00007	0.00004	0.00003	0.00002	0.00001	0.00001			
4	0.00032	0.00020	0.00013	0.00008	0.00005	0.00003	0.00002	0.00001	0.00001	0.00001
5	0.00081	0.00052	0.00034	0.00022	0.00014	0.00009	0.00006	0.00004	0.00002	0.00002
6	0.00184	0.00121	0.00080	0.00052	0.00034	0.00022	0.00015	0.00009	0.00006	0.00004
7	0.00377	0.00254	0.00171	0.00114	0.00076	0.00050	0.00033	0.00022	0.00015	0.00010
8	0.00715	0.00492	0.00336	0.00229	0.00155	0.00105	0.00071	0.00047	0.00032	0.00021
9	0.01265	0.00888	0.00620	0.00430	0.00297	0.00204	0.00140	0.00095	0.00065	0.00044
10	0.02109	0.01511	0.01075	0.00760	0.00535	0.00374	0.00260	0.00181	0.00125	0.00086
11	0.03337	0.02437	0.01768	0.01273	0.00912	0.00649	0.00460	0.00324	0.00227	0.00159
12	0.05038	0.03752	0.02773	0.02034	0.01482	0.01073	0.00773	0.00553	0.00394	0.00279
13	0.07293	0.05536	0.04168	0.03113	0.02308	0.01700	0.01244	0.00905	0.00655	0.00471
14	0.10163	0.07861	0.06027	0.04582	0.03457	0.02589	0.01925	0.01423	0.01045	0.00763
15	0.13683	0.10780	0.08414	0.06509	0.04994	0.03802	0.02874	0.02157	0.01609	0.01192
16	0.17851	0.14319	0.11374	0.08950	0.06982	0.05403	0.04148	0.03162	0.02394	0.01800
17	0.22629	0.18472	0.14925	0.11944	0.09471	0.07446	0.05807	0.04494	0.03453	0.02635
18	0.27941	0.23199	0.19059	0.15503	0.12492	0.09976	0.07900	0.06206	0.04838	0.03745
19	0.33680	0.28426	0.23734	0.19615	0.16054	0.13019	0.10465	0.08343	0.06599	0.05180
20	0.39713	0.34051	0.28880	0.24239	0.20143	0.16581	0.13526	0.10940	0.08776	0.06985
21	0.45894	0.39951	0.34398	0.29306	0.24716	0.20645	0.17085	0.14015	0.11400	0.09199
22	0.52074	0.45989	0.40173	0.34723	0.29707	0.25168	0.21123	0.17568	0.14486	0.11846
23	0.58109	0.52025	0.46077	0.40381	0.35029	0.30087	0.25597	0.21578	0.18031	0.14940
24	0.63873	0.57927	0.51980	0.46160	0.40576	0.35317	0.30445	0.26004	0.22013	0.18475
25	0.69261	0.63574	0.57756	0.51937	0.46237	0.40760	0.35588	0.30785	0.26392	0.22429
26	0.74196	0.68870	0.63295	0.57597	0.51898	0.46311	0.40933	0.35846	0.31108	0.26761
27	0.78629	0.73738	0.68501	0.63032	0.57446	0.51860	0.46379	0.41097	0.36090	0.31415
28	0.82535	0.78129	0.73304	0.68154	0.62784	0.57305	0.51825	0.46445	0.41253	0.36322
29	0.85915	0.82019	0.77654	0.72893	0.67825	0.62549	0.57171	0.51791	0.46507	0.41400
30	0.88789	0.85404	0.81526	0.77203	0.72503	0.67513	0.62327	0.57044	0.51760	0.46565
	$\chi^2 = 31$	32	33	34	35	36	37	38	39	40
ν	$m = 15.5$	16.0	16.5	17.0	17.5	18.0	18.5	19.0	19.5	20.0
5	0.00001	0.00001								
6	0.00003	0.00002	0.00001	0.00001						
7	0.00006	0.00004	0.00003	0.00002	0.00001	0.00001				
8	0.00014	0.00009	0.00006	0.00004	0.00003	0.00002	0.00001	0.00001		
9	0.00030	0.00020	0.00013	0.00009	0.00006	0.00004	0.00003	0.00002	0.00001	0.00001
10	0.00059	0.00040	0.00027	0.00019	0.00012	0.00008	0.00006	0.00004	0.00003	0.00002
11	0.00110	0.00076	0.00053	0.00036	0.00025	0.00017	0.00012	0.00008	0.00005	0.00004
12	0.00197	0.00138	0.00097	0.00068	0.00047	0.00032	0.00022	0.00015	0.00011	0.00007
13	0.00337	0.00240	0.00170	0.00120	0.00085	0.00059	0.00041	0.00029	0.00020	0.00014
14	0.00554	0.00401	0.00288	0.00206	0.00147	0.00104	0.00074	0.00052	0.00036	0.00026
15	0.00878	0.00644	0.00469	0.00341	0.00246	0.00177	0.00127	0.00090	0.00064	0.00045
16	0.01346	0.01000	0.00739	0.00543	0.00397	0.00289	0.00210	0.00151	0.00109	0.00078
17	0.01997	0.01505	0.01127	0.00840	0.00622	0.00459	0.00337	0.00246	0.00179	0.00129
18	0.02879	0.02199	0.01669	0.01260	0.00945	0.00706	0.00524	0.00387	0.00285	0.00209
19	0.04037	0.03125	0.02404	0.01838	0.01397	0.01056	0.00793	0.00593	0.00442	0.00327
20	0.05519	0.04330	0.03374	0.02613	0.02010	0.01538	0.01170	0.00886	0.00667	0.00500
21	0.07366	0.05855	0.04622	0.03624	0.02824	0.02187	0.01683	0.01289	0.00981	0.00744
22	0.09612	0.07740	0.06187	0.04912	0.03875	0.03037	0.02366	0.01832	0.01411	0.01081
23	0.12279	0.10014	0.08107	0.06516	0.05202	0.04125	0.03251	0.02547	0.01984	0.01537
24	0.15378	0.12699	0.10407	0.08467	0.06840	0.05489	0.04376	0.03467	0.02731	0.02139
25	0.18902	0.15801	0.13107	0.10791	0.08820	0.07160	0.05774	0.04626	0.03684	0.02916
26	0.22827	0.19312	0.16210	0.13502	0.11165	0.09167	0.07475	0.06056	0.04875	0.03901
27	0.27114	0.23208	0.19707	0.16605	0.13887	0.11530	0.09507	0.07786	0.06336	0.05124
28	0.31708	0.27451	0.23574	0.20087	0.16987	0.14260	0.11886	0.09840	0.08092	0.06613
29	0.36542	0.31987	0.27774	0.23926	0.20454	0.17356	0.14622	0.12234	0.10166	0.08394
30	0.41541	0.36753	0.32254	0.28083	0.24264	0.20808	0.17714	0.14975	0.12573	0.10486

PROBABILITY INTEGRAL OF χ^2 -DISTRIBUTION, INCOMPLETE GAMMA FUNCTION Table 26.7
CUMULATIVE SUMS OF THE POISSON DISTRIBUTION

ν	$\chi^2=42$ $m=21$	44 22	46 23	48 24	50 25	52 26	54 27	56 28	58 29	60 30
10	0.00001									
11	0.00002	0.00001								
12	0.00003	0.00002	0.00001							
13	0.00006	0.00003	0.00001	0.00001						
14	0.00012	0.00006	0.00003	0.00001	0.00001					
15	0.00023	0.00011	0.00005	0.00003	0.00001	0.00001				
16	0.00040	0.00020	0.00010	0.00005	0.00002	0.00001	0.00001			
17	0.00067	0.00034	0.00017	0.00009	0.00004	0.00002	0.00001	0.00001		
18	0.00111	0.00058	0.00030	0.00015	0.00008	0.00004	0.00002	0.00001		
19	0.00177	0.00094	0.00050	0.00026	0.00013	0.00007	0.00003	0.00002	0.00001	
20	0.00277	0.00151	0.00081	0.00043	0.00022	0.00011	0.00006	0.00003	0.00001	0.00001
21	0.00421	0.00234	0.00128	0.00069	0.00036	0.00019	0.00010	0.00005	0.00003	0.00001
22	0.00625	0.00355	0.00198	0.00109	0.00059	0.00031	0.00016	0.00009	0.00004	0.00002
23	0.00908	0.00526	0.00299	0.00167	0.00092	0.00050	0.00027	0.00014	0.00007	0.00004
24	0.01291	0.00763	0.00443	0.00252	0.00142	0.00078	0.00043	0.00023	0.00012	0.00006
25	0.01797	0.01085	0.00642	0.00373	0.00213	0.00120	0.00066	0.00036	0.00020	0.00011
26	0.02455	0.01512	0.00912	0.00540	0.00314	0.00180	0.00102	0.00056	0.00031	0.00017
27	0.03292	0.02068	0.01272	0.00768	0.00455	0.00265	0.00152	0.00086	0.00048	0.00026
28	0.04336	0.02779	0.01743	0.01072	0.00647	0.00384	0.00224	0.00129	0.00073	0.00041
29	0.05616	0.03670	0.02346	0.01470	0.00903	0.00545	0.00324	0.00189	0.00109	0.00062
30	0.07157	0.04769	0.03107	0.01983	0.01240	0.00762	0.00460	0.00273	0.00160	0.00092

ν	$\chi^2=62$ $m=31$	64 32	66 33	68 34	70 35	72 36	74 37	76 38
21	0.00001							
22	0.00001	0.00001						
23	0.00002	0.00001	0.00001					
24	0.00003	0.00002	0.00001					
25	0.00006	0.00003	0.00002	0.00001				
26	0.00009	0.00005	0.00003	0.00001	0.00001			
27	0.00014	0.00008	0.00004	0.00002	0.00001	0.00001		
28	0.00023	0.00012	0.00007	0.00004	0.00002	0.00001	0.00001	
29	0.00035	0.00019	0.00011	0.00006	0.00003	0.00002	0.00001	
30	0.00052	0.00029	0.00016	0.00009	0.00005	0.00003	0.00001	0.00001

$$Q(\chi^2|\nu) = 1 - P(\chi^2|\nu) = \left[2^{\frac{\nu}{2}} \Gamma\left(\frac{\nu}{2}\right) \right]^{-1} \int_{\chi^2}^{\infty} e^{-\frac{t}{2}} t^{\frac{\nu}{2}-1} dt = \left[\Gamma\left(\frac{\nu}{2}\right) \right]^{-1} \int_{\frac{1}{2}\chi^2}^{\infty} e^{-t} t^{\frac{\nu}{2}-1} dt = \sum_{j=0}^{c-1} e^{-mj} / j! \quad (\nu \text{ even, } c = \frac{1}{2}\nu, m = \frac{1}{2}\chi^2)$$

$$\phi = \frac{1}{2}(\chi^2 - \chi_0^2) \quad w = \nu - \nu_0 > 0$$

Interpolation on χ^2

$$Q(\chi^2|\nu) = Q(\chi_0^2|\nu_0 - 4) \left[\frac{1}{2} \phi^2 \right] + Q(\chi_0^2|\nu_0 - 2) [\phi - \phi^2] + Q(\chi_0^2|\nu_0) \left[1 - \phi + \frac{1}{2} \phi^2 \right]$$

Double Entry Interpolation

$$Q(\chi^2|\nu) = Q(\chi_0^2|\nu_0 - 4) \left[\frac{1}{2} \phi^2 \right] + Q(\chi_0^2|\nu_0 - 2) [\phi - \phi^2 - w\phi] + Q(\chi_0^2|\nu_0 - 1) \left[\frac{1}{2} w^2 - \frac{1}{2} w + w\phi \right]$$

$$+ Q(\chi_0^2|\nu_0) \left[1 - w^2 - \phi + \frac{1}{2} \phi^2 + w\phi \right] + Q(\chi_0^2|\nu_0 + 1) \left[\frac{1}{2} w^2 + \frac{1}{2} w - w\phi \right]$$

Table 26.8 PERCENTAGE POINTS OF THE χ^2 -DISTRIBUTION—VALUES OF χ^2 IN TERMS OF Q AND ν

$\nu \backslash Q$	0.995	0.99	0.975	0.95	0.9	0.75	0.5	0.25
1 (-5)	3.92704	(-4)1.57088	(-4)9.82069	(-3)3.93214	0.0157908	0.101531	0.454937	1.32330
2 (-2)	1.00251	(-2)2.01007	(-2)5.06356	0.102587	0.210720	0.575364	1.38629	2.77259
3 (-2)	7.17212	0.114832	0.215795	0.351846	0.584375	1.212534	2.36597	4.10835
4	0.206990	0.297110	0.484419	0.710721	1.063623	1.92255	3.35670	5.38527
5	0.411740	0.554300	0.831211	1.145476	1.61031	2.67460	4.35146	6.62568
6	0.675727	0.872085	1.237347	1.63539	2.20413	3.45460	5.34812	7.84080
7	0.989265	1.239043	1.68987	2.16735	2.83311	4.25485	6.34581	9.03715
8	1.344419	1.646482	2.17973	2.73264	3.48954	5.07064	7.34412	10.2188
9	1.734926	2.087912	2.70039	3.32511	4.16816	5.89883	8.34283	11.3887
10	2.15585	2.55821	3.24697	3.94030	4.86518	6.73720	9.34182	12.5489
11	2.60321	3.05347	3.81575	4.57481	5.57779	7.58412	10.3410	13.7007
12	3.07382	3.57056	4.40379	5.22603	6.30380	8.43842	11.3403	14.8454
13	3.56503	4.10691	5.00874	5.89186	7.04150	9.29906	12.3398	15.9839
14	4.07468	4.66043	5.62872	6.57063	7.78953	10.1653	13.3393	17.1170
15	4.60094	5.22935	6.26214	7.26094	8.54675	11.0365	14.3389	18.2451
16	5.14224	5.81221	6.90766	7.96164	9.31223	11.9122	15.3385	19.3688
17	5.69724	6.40776	7.56418	8.67176	10.0852	12.7919	16.3381	20.4887
18	6.26481	7.01491	8.23075	9.39046	10.8649	13.6753	17.3379	21.6049
19	6.84398	7.63273	8.90655	10.1170	11.6509	14.5620	18.3376	22.7178
20	7.43386	8.26040	9.59083	10.8508	12.4426	15.4518	19.3374	23.8277
21	8.03366	8.89720	10.28293	11.5913	13.2396	16.3444	20.3372	24.9348
22	8.64272	9.54249	10.9823	12.3380	14.0415	17.2396	21.3370	26.0393
23	9.26042	10.19567	11.6885	13.0905	14.8479	18.1373	22.3369	27.1413
24	9.88623	10.8564	12.4011	13.8484	15.6587	19.0372	23.3367	28.2412
25	10.5197	11.5240	13.1197	14.6114	16.4734	19.9393	24.3366	29.3389
26	11.1603	12.1981	13.8439	15.3791	17.2919	20.8434	25.3364	30.4345
27	11.8076	12.8786	14.5733	16.1513	18.1138	21.7494	26.3363	31.5284
28	12.4613	13.5648	15.3079	16.9279	18.9392	22.6572	27.3363	32.6205
29	13.1211	14.2565	16.0471	17.7083	19.7677	23.5666	28.3362	33.7109
30	13.7867	14.9535	16.7908	18.4926	20.5992	24.4776	29.3360	34.7998
40	20.7065	22.1643	24.4331	26.5093	29.0505	33.6603	39.3354	45.6160
50	27.9907	29.7067	32.3574	34.7642	37.6886	42.9421	49.3349	56.3336
60	35.5346	37.4848	40.4817	43.1879	46.4589	52.2938	59.3347	66.9814
70	43.2752	45.4418	48.7576	51.7393	55.3290	61.6983	69.3344	77.5766
80	51.1720	53.5400	57.1532	60.3915	64.2778	71.1445	79.3343	88.1303
90	59.1963	61.7541	65.6466	69.1260	73.2912	80.6247	89.3342	98.6499
100	67.3276	70.0648	74.2219	77.9295	82.3581	90.1332	99.3341	109.141
X	-2.5758	-2.3263	-1.9600	-1.6449	-1.2816	-0.6745	0.0000	0.6745

$$Q(\chi^2 | \nu) = \left[2^{\frac{\nu}{2}} \Gamma\left(\frac{\nu}{2}\right) \right]^{-1} \int_{\chi^2}^{\infty} e^{-\frac{t}{2}} t^{\frac{\nu}{2}-1} dt$$

From E. S. Pearson and H. O. Hartley (editors), *Biometrika tables for statisticians*, vol. I. Cambridge Univ. Press, Cambridge, England, 1954 (with permission) for $Q > 0.0005$.

PERCENTAGE POINTS OF THE χ^2 -DISTRIBUTION—VALUES OF χ^2 IN TERMS OF Q AND ν Table 26.8

$\nu \backslash Q$	0.1	0.05	0.025	0.01	0.005	0.001	0.0005	0.0001
1	2.70554	3.84146	5.02389	6.63490	7.87944	10.828	12.116	15.137
2	4.60517	5.99147	7.37776	9.21034	10.5966	13.816	15.202	18.421
3	6.25139	7.81473	9.34840	11.3449	12.8381	16.266	17.730	21.108
4	7.77944	9.48773	11.1433	13.2767	14.8602	18.467	19.997	23.513
5	9.23635	11.0705	12.8325	15.0863	16.7496	20.515	22.105	25.745
6	10.6446	12.5916	14.4494	16.8119	18.5476	22.458	24.103	27.856
7	12.0170	14.0671	16.0128	18.4753	20.2777	24.322	26.018	29.877
8	13.3616	15.5073	17.5346	20.0902	21.9550	26.125	27.868	31.828
9	14.6837	16.9190	19.0228	21.6660	23.5893	27.877	29.666	33.720
10	15.9871	18.3070	20.4831	23.2093	25.1882	29.588	31.420	35.564
11	17.2750	19.6751	21.9200	24.7250	26.7569	31.264	33.137	37.367
12	18.5494	21.0261	23.3367	26.2170	28.2995	32.909	34.821	39.134
13	19.8119	22.3621	24.7356	27.6883	29.8194	34.528	36.478	40.871
14	21.0642	23.6848	26.1190	29.1413	31.3193	36.123	38.109	42.579
15	22.3072	24.9958	27.4884	30.5779	32.8013	37.697	39.719	44.263
16	23.5418	26.2962	28.8454	31.9999	34.2672	39.252	41.308	45.925
17	24.7690	27.5871	30.1910	33.4087	35.7185	40.790	42.879	47.566
18	25.9894	28.8693	31.5264	34.8053	37.1564	42.312	44.434	49.189
19	27.2036	30.1435	32.8523	36.1908	38.5822	43.820	45.973	50.796
20	28.4120	31.4104	34.1696	37.5662	39.9968	45.315	47.498	52.386
21	29.6151	32.6705	35.4789	38.9321	41.4010	46.797	49.011	53.962
22	30.8133	33.9244	36.7807	40.2894	42.7956	48.268	50.511	55.525
23	32.0069	35.1725	38.0757	41.6384	44.1813	49.728	52.000	57.075
24	33.1963	36.4151	39.3641	42.9798	45.5585	51.179	53.479	58.613
25	34.3816	37.6525	40.6465	44.3141	46.9278	52.620	54.947	60.140
26	35.5631	38.8852	41.9232	45.6417	48.2899	54.052	56.407	61.657
27	36.7412	40.1133	43.1944	46.9630	49.6449	55.476	57.858	63.164
28	37.9159	41.3372	44.4607	48.2782	50.9933	56.892	59.300	64.662
29	39.0875	42.5569	45.7222	49.5879	52.3356	58.302	60.735	66.152
30	40.2560	43.7729	46.9792	50.8922	53.6720	59.703	62.162	67.633
40	51.8050	55.7585	59.3417	63.6907	66.7659	73.402	76.095	82.062
50	63.1671	67.5048	71.4202	76.1539	79.4900	86.661	89.560	95.969
60	74.3970	79.0819	83.2976	88.3794	91.9517	99.607	102.695	109.503
70	85.5271	90.5312	95.0231	100.425	104.215	112.317	115.578	122.755
80	96.5782	101.879	106.629	112.329	116.321	124.839	128.261	135.783
90	107.565	113.145	118.136	124.116	128.299	137.208	140.782	148.627
100	118.498	124.342	129.561	135.807	140.169	149.449	153.167	161.319
X	1.2816	1.6449	1.9600	2.3263	2.5758	3.0902	3.2905	3.7190

$$Q(\chi^2 | \nu) = \left[2^{\frac{\nu}{2}} \Gamma\left(\frac{\nu}{2}\right) \right]^{-1} \int_{\chi^2}^{\infty} e^{-\frac{t}{2}} t^{\frac{\nu}{2}-1} dt$$

Table 26.9 PERCENTAGE POINTS OF THE F-DISTRIBUTION—VALUES OF F IN TERMS OF Q, ν_1 , ν_2

$Q(F \nu_1, \nu_2)=0.5$													
$\frac{1}{2}\nu_1$	1	2	3	4	5	6	8	12	15	20	30	60	∞
1	1.00	1.50	1.71	1.82	1.89	1.94	2.00	2.07	2.09	2.12	2.15	2.17	2.20
2	0.667	1.00	1.13	1.21	1.25	1.28	1.32	1.36	1.38	1.39	1.41	1.43	1.44
3	0.585	0.881	1.00	1.06	1.10	1.13	1.16	1.20	1.21	1.23	1.24	1.25	1.27
4	0.549	0.828	0.941	1.00	1.04	1.06	1.09	1.13	1.14	1.15	1.16	1.18	1.19
5	0.528	0.799	0.907	0.965	1.00	1.02	1.05	1.09	1.10	1.11	1.12	1.14	1.15
6	0.515	0.780	0.886	0.942	0.977	1.00	1.03	1.06	1.07	1.08	1.10	1.11	1.12
7	0.506	0.767	0.871	0.926	0.960	0.983	1.01	1.04	1.05	1.07	1.08	1.09	1.10
8	0.499	0.757	0.860	0.915	0.948	0.971	1.00	1.03	1.04	1.05	1.07	1.08	1.09
9	0.494	0.749	0.852	0.906	0.939	0.962	0.990	1.02	1.03	1.04	1.05	1.07	1.08
10	0.490	0.743	0.845	0.899	0.932	0.954	0.983	1.01	1.02	1.03	1.05	1.06	1.07
11	0.486	0.739	0.840	0.893	0.926	0.948	0.977	1.01	1.02	1.03	1.04	1.05	1.06
12	0.484	0.735	0.835	0.888	0.921	0.943	0.972	1.00	1.01	1.02	1.03	1.05	1.06
13	0.481	0.731	0.832	0.885	0.917	0.939	0.967	0.996	1.01	1.02	1.03	1.04	1.05
14	0.479	0.729	0.828	0.881	0.914	0.936	0.964	0.992	1.00	1.01	1.03	1.04	1.05
15	0.478	0.726	0.826	0.878	0.911	0.933	0.960	0.989	1.00	1.01	1.02	1.03	1.05
16	0.476	0.724	0.823	0.876	0.908	0.930	0.958	0.986	0.997	1.01	1.02	1.03	1.04
17	0.475	0.722	0.821	0.874	0.906	0.928	0.955	0.983	0.995	1.01	1.02	1.03	1.04
18	0.474	0.721	0.819	0.872	0.904	0.926	0.953	0.981	0.992	1.00	1.02	1.03	1.04
19	0.473	0.719	0.818	0.870	0.902	0.924	0.951	0.979	0.990	1.00	1.01	1.02	1.04
20	0.472	0.718	0.816	0.868	0.900	0.922	0.950	0.977	0.989	1.00	1.01	1.02	1.03
21	0.471	0.716	0.815	0.867	0.899	0.921	0.948	0.976	0.987	0.998	1.01	1.02	1.03
22	0.470	0.715	0.814	0.866	0.898	0.919	0.947	0.974	0.986	0.997	1.01	1.02	1.03
23	0.470	0.714	0.813	0.864	0.896	0.918	0.945	0.973	0.984	0.996	1.01	1.02	1.03
24	0.469	0.714	0.812	0.863	0.895	0.917	0.944	0.972	0.983	0.994	1.01	1.02	1.03
25	0.468	0.713	0.811	0.862	0.894	0.916	0.943	0.971	0.982	0.993	1.00	1.02	1.03
26	0.468	0.712	0.810	0.861	0.893	0.915	0.942	0.970	0.981	0.992	1.00	1.01	1.03
27	0.467	0.711	0.809	0.861	0.892	0.914	0.941	0.969	0.980	0.991	1.00	1.01	1.03
28	0.467	0.711	0.808	0.860	0.892	0.913	0.940	0.968	0.979	0.990	1.00	1.01	1.02
29	0.466	0.710	0.808	0.859	0.891	0.912	0.940	0.967	0.978	0.990	1.00	1.01	1.02
30	0.466	0.709	0.807	0.858	0.890	0.912	0.939	0.966	0.978	0.989	1.00	1.01	1.02
40	0.463	0.705	0.802	0.854	0.885	0.907	0.934	0.961	0.972	0.983	0.994	1.01	1.02
60	0.461	0.701	0.798	0.849	0.880	0.901	0.928	0.956	0.967	0.978	0.989	1.00	1.01
120	0.458	0.697	0.793	0.844	0.875	0.896	0.923	0.950	0.961	0.972	0.983	0.994	1.01
∞	0.455	0.693	0.789	0.839	0.870	0.891	0.918	0.945	0.956	0.967	0.978	0.989	1.00
$Q(F \nu_1, \nu_2)=0.25$													
$\frac{1}{2}\nu_1$	1	2	3	4	5	6	8	12	15	20	30	60	∞
1	5.83	7.50	8.20	8.58	8.82	8.98	9.19	9.41	9.49	9.58	9.67	9.76	9.85
2	2.57	3.00	3.15	3.23	3.28	3.31	3.35	3.39	3.41	3.43	3.44	3.46	3.48
3	2.02	2.28	2.36	2.39	2.41	2.42	2.44	2.45	2.46	2.46	2.47	2.47	2.47
4	1.81	2.00	2.05	2.06	2.07	2.08	2.08	2.08	2.08	2.08	2.08	2.08	2.08
5	1.69	1.85	1.88	1.89	1.89	1.89	1.89	1.89	1.89	1.88	1.88	1.87	1.87
6	1.62	1.76	1.78	1.79	1.79	1.78	1.78	1.77	1.76	1.76	1.75	1.74	1.74
7	1.57	1.70	1.72	1.72	1.71	1.71	1.70	1.68	1.68	1.67	1.66	1.65	1.65
8	1.54	1.66	1.67	1.66	1.66	1.65	1.64	1.62	1.62	1.61	1.60	1.59	1.58
9	1.51	1.62	1.63	1.63	1.62	1.61	1.60	1.58	1.57	1.56	1.55	1.54	1.53
10	1.49	1.60	1.60	1.59	1.59	1.58	1.56	1.54	1.53	1.52	1.51	1.50	1.48
11	1.47	1.58	1.58	1.57	1.56	1.55	1.53	1.51	1.50	1.49	1.48	1.47	1.45
12	1.46	1.56	1.56	1.55	1.54	1.53	1.51	1.49	1.48	1.47	1.45	1.44	1.42
13	1.45	1.55	1.55	1.53	1.52	1.51	1.49	1.47	1.46	1.45	1.43	1.42	1.40
14	1.44	1.53	1.53	1.52	1.51	1.50	1.48	1.45	1.44	1.43	1.41	1.40	1.38
15	1.43	1.52	1.52	1.51	1.49	1.48	1.46	1.44	1.43	1.41	1.40	1.38	1.36
16	1.42	1.51	1.51	1.50	1.48	1.47	1.45	1.43	1.41	1.40	1.38	1.36	1.34
17	1.42	1.51	1.50	1.49	1.47	1.46	1.44	1.41	1.40	1.39	1.37	1.35	1.33
18	1.41	1.50	1.49	1.48	1.46	1.45	1.43	1.40	1.39	1.38	1.36	1.34	1.32
19	1.41	1.49	1.49	1.47	1.46	1.44	1.42	1.40	1.38	1.37	1.35	1.33	1.30
20	1.40	1.49	1.48	1.47	1.45	1.44	1.42	1.39	1.37	1.36	1.34	1.32	1.29
21	1.40	1.48	1.48	1.46	1.44	1.43	1.41	1.38	1.37	1.35	1.33	1.31	1.28
22	1.40	1.48	1.47	1.45	1.44	1.42	1.40	1.37	1.36	1.34	1.32	1.30	1.28
23	1.39	1.47	1.47	1.45	1.43	1.42	1.40	1.37	1.35	1.34	1.32	1.30	1.27
24	1.39	1.47	1.46	1.44	1.43	1.41	1.39	1.36	1.35	1.33	1.31	1.29	1.26
25	1.39	1.47	1.46	1.44	1.42	1.41	1.39	1.36	1.34	1.33	1.31	1.28	1.25
26	1.38	1.46	1.45	1.44	1.42	1.41	1.38	1.35	1.34	1.32	1.30	1.28	1.25
27	1.38	1.46	1.45	1.43	1.42	1.40	1.38	1.35	1.33	1.32	1.30	1.27	1.24
28	1.38	1.46	1.45	1.43	1.41	1.40	1.38	1.34	1.33	1.31	1.29	1.27	1.24
29	1.38	1.45	1.45	1.43	1.41	1.40	1.37	1.34	1.32	1.31	1.29	1.26	1.23
30	1.38	1.45	1.44	1.42	1.41	1.39	1.37	1.34	1.32	1.30	1.28	1.26	1.23
40	1.36	1.44	1.42	1.40	1.39	1.37	1.35	1.31	1.30	1.28	1.25	1.22	1.19
60	1.35	1.42	1.41	1.38	1.37	1.35	1.32	1.29	1.27	1.25	1.22	1.19	1.15
120	1.34	1.40	1.39	1.37	1.35	1.33	1.30	1.26	1.24	1.22	1.19	1.16	1.10
∞	1.32	1.39	1.37	1.35	1.33	1.31	1.28	1.24	1.22	1.19	1.16	1.12	1.00

Compiled from E. S. Pearson and H. O. Hartley (editors), Biometrika tables for statisticians, vol. I. Cambridge Univ. Press, Cambridge, England, 1954 (with permission).

PERCENTAGE POINTS OF THE F-DISTRIBUTION—VALUES Table 26.9

OF F IN TERMS OF Q, ν_1, ν_2

$Q(F|\nu_1, \nu_2)=0.1$

$\nu_2 \backslash \nu_1$	1	2	3	4	5	6	8	12	15	20	30	60	∞
1	39.86	49.50	53.59	55.83	57.24	58.20	59.44	60.71	61.22	61.74	62.26	62.79	63.33
2	8.53	9.00	9.16	9.24	9.29	9.33	9.37	9.41	9.42	9.44	9.46	9.47	9.49
3	5.54	5.46	5.39	5.34	5.31	5.28	5.25	5.22	5.20	5.18	5.17	5.15	5.13
4	4.54	4.32	4.19	4.11	4.05	4.01	3.95	3.90	3.87	3.84	3.82	3.79	3.76
5	4.06	3.78	3.62	3.52	3.45	3.40	3.34	3.27	3.24	3.21	3.17	3.14	3.10
6	3.78	3.46	3.29	3.18	3.11	3.05	2.98	2.90	2.87	2.84	2.80	2.76	2.72
7	3.59	3.26	3.07	2.96	2.88	2.83	2.75	2.67	2.63	2.59	2.56	2.51	2.47
8	3.46	3.11	2.92	2.81	2.73	2.67	2.59	2.50	2.46	2.42	2.38	2.34	2.29
9	3.36	3.01	2.81	2.69	2.61	2.55	2.47	2.38	2.34	2.30	2.25	2.21	2.16
10	3.29	2.92	2.73	2.61	2.52	2.46	2.38	2.28	2.24	2.20	2.16	2.11	2.06
11	3.23	2.86	2.66	2.54	2.45	2.39	2.30	2.21	2.17	2.12	2.08	2.03	1.97
12	3.18	2.81	2.61	2.48	2.39	2.33	2.24	2.15	2.10	2.06	2.01	1.96	1.90
13	3.14	2.76	2.56	2.43	2.35	2.28	2.20	2.10	2.05	2.01	1.96	1.90	1.85
14	3.10	2.73	2.52	2.39	2.31	2.24	2.15	2.05	2.01	1.96	1.91	1.86	1.80
15	3.07	2.70	2.49	2.36	2.27	2.21	2.12	2.02	1.97	1.92	1.87	1.82	1.76
16	3.05	2.67	2.46	2.33	2.24	2.18	2.09	1.99	1.94	1.89	1.84	1.78	1.72
17	3.03	2.64	2.44	2.31	2.22	2.15	2.06	1.96	1.91	1.86	1.81	1.75	1.69
18	3.01	2.62	2.42	2.29	2.20	2.13	2.04	1.93	1.89	1.84	1.78	1.72	1.66
19	2.99	2.61	2.40	2.27	2.18	2.11	2.02	1.91	1.86	1.81	1.76	1.70	1.63
20	2.97	2.59	2.38	2.25	2.16	2.09	2.00	1.89	1.84	1.79	1.74	1.68	1.61
21	2.96	2.57	2.36	2.23	2.14	2.08	1.98	1.87	1.83	1.78	1.72	1.66	1.59
22	2.95	2.56	2.35	2.22	2.13	2.06	1.97	1.86	1.81	1.76	1.70	1.64	1.57
23	2.94	2.55	2.34	2.21	2.11	2.05	1.95	1.84	1.80	1.74	1.69	1.62	1.55
24	2.93	2.54	2.33	2.19	2.10	2.04	1.94	1.83	1.78	1.73	1.67	1.61	1.53
25	2.92	2.53	2.32	2.18	2.09	2.02	1.93	1.82	1.77	1.72	1.66	1.59	1.52
26	2.91	2.52	2.31	2.17	2.08	2.01	1.92	1.81	1.76	1.71	1.65	1.58	1.50
27	2.90	2.51	2.30	2.17	2.07	2.00	1.91	1.80	1.75	1.70	1.64	1.57	1.49
28	2.89	2.50	2.29	2.16	2.06	2.00	1.90	1.79	1.74	1.69	1.63	1.56	1.48
29	2.89	2.50	2.28	2.15	2.06	1.99	1.89	1.78	1.73	1.68	1.62	1.55	1.47
30	2.88	2.49	2.28	2.14	2.05	1.98	1.88	1.77	1.72	1.67	1.61	1.54	1.46
40	2.84	2.44	2.23	2.09	2.00	1.93	1.83	1.71	1.66	1.61	1.54	1.47	1.38
60	2.79	2.39	2.18	2.04	1.95	1.87	1.77	1.66	1.60	1.54	1.48	1.40	1.29
120	2.75	2.35	2.13	1.99	1.90	1.82	1.72	1.60	1.55	1.48	1.41	1.32	1.19
∞	2.71	2.30	2.08	1.94	1.85	1.77	1.67	1.55	1.49	1.42	1.34	1.24	1.00

$Q(F|\nu_1, \nu_2)=0.05$

$\nu_2 \backslash \nu_1$	1	2	3	4	5	6	8	12	15	20	30	60	∞
1	161.4	199.5	215.7	224.6	230.2	234.0	238.9	243.9	245.9	248.0	250.1	252.2	254.3
2	18.51	19.00	19.16	19.25	19.30	19.33	19.37	19.41	19.43	19.45	19.46	19.48	19.50
3	10.13	9.55	9.28	9.12	9.01	8.94	8.85	8.74	8.70	8.66	8.62	8.57	8.53
4	7.71	6.94	6.59	6.39	6.26	6.16	6.04	5.91	5.86	5.80	5.75	5.69	5.63
5	6.61	5.79	5.41	5.19	5.05	4.95	4.82	4.68	4.62	4.56	4.50	4.43	4.36
6	5.99	5.14	4.76	4.53	4.39	4.28	4.15	4.00	3.94	3.87	3.81	3.74	3.67
7	5.59	4.74	4.35	4.12	3.97	3.87	3.73	3.57	3.51	3.44	3.38	3.30	3.23
8	5.32	4.46	4.07	3.84	3.69	3.58	3.44	3.28	3.22	3.15	3.08	3.01	2.93
9	5.12	4.26	3.86	3.63	3.48	3.37	3.23	3.07	3.01	2.94	2.86	2.79	2.71
10	4.96	4.10	3.71	3.48	3.33	3.22	3.07	2.91	2.85	2.77	2.70	2.62	2.54
11	4.84	3.98	3.59	3.36	3.20	3.09	2.95	2.79	2.72	2.65	2.57	2.49	2.40
12	4.75	3.89	3.49	3.26	3.11	3.00	2.85	2.69	2.62	2.54	2.47	2.38	2.30
13	4.67	3.81	3.41	3.18	3.03	2.92	2.77	2.60	2.53	2.46	2.38	2.30	2.21
14	4.60	3.74	3.34	3.11	2.96	2.85	2.70	2.53	2.46	2.39	2.31	2.22	2.13
15	4.54	3.68	3.29	3.06	2.90	2.79	2.64	2.48	2.40	2.33	2.25	2.16	2.07
16	4.49	3.63	3.24	3.01	2.85	2.74	2.59	2.42	2.35	2.28	2.19	2.11	2.01
17	4.45	3.59	3.20	2.96	2.81	2.70	2.55	2.38	2.31	2.23	2.15	2.06	1.96
18	4.41	3.55	3.16	2.93	2.77	2.66	2.51	2.34	2.27	2.19	2.11	2.02	1.92
19	4.38	3.52	3.13	2.90	2.74	2.63	2.48	2.31	2.23	2.16	2.07	1.98	1.88
20	4.35	3.49	3.10	2.87	2.71	2.60	2.45	2.28	2.20	2.12	2.04	1.95	1.84
21	4.32	3.47	3.07	2.84	2.68	2.57	2.42	2.25	2.18	2.10	2.01	1.92	1.81
22	4.30	3.44	3.05	2.82	2.66	2.55	2.40	2.23	2.15	2.07	1.98	1.89	1.78
23	4.28	3.42	3.03	2.80	2.64	2.53	2.37	2.20	2.13	2.05	1.96	1.86	1.76
24	4.26	3.40	3.01	2.78	2.62	2.51	2.36	2.18	2.11	2.03	1.94	1.84	1.73
25	4.24	3.39	2.99	2.76	2.60	2.49	2.34	2.16	2.09	2.01	1.92	1.82	1.71
26	4.23	3.37	2.98	2.74	2.59	2.47	2.32	2.15	2.07	1.99	1.90	1.80	1.69
27	4.21	3.35	2.96	2.73	2.57	2.46	2.31	2.13	2.06	1.97	1.88	1.79	1.67
28	4.20	3.34	2.95	2.71	2.56	2.45	2.29	2.12	2.04	1.96	1.87	1.77	1.65
29	4.18	3.33	2.93	2.70	2.55	2.43	2.28	2.10	2.03	1.94	1.85	1.75	1.64
30	4.17	3.32	2.92	2.69	2.53	2.42	2.27	2.09	2.01	1.93	1.84	1.74	1.62
40	4.08	3.23	2.84	2.61	2.45	2.34	2.18	2.00	1.92	1.84	1.74	1.64	1.51
60	4.00	3.15	2.76	2.53	2.37	2.25	2.10	1.92	1.84	1.75	1.65	1.53	1.39
120	3.92	3.07	2.68	2.45	2.29	2.17	2.02	1.83	1.75	1.66	1.55	1.43	1.25
∞	3.84	3.00	2.60	2.37	2.21	2.10	1.94	1.75	1.67	1.57	1.46	1.32	1.00

Table 26.9 PERCENTAGE POINTS OF THE F-DISTRIBUTION—VALUES OF F IN TERMS OF Q, ν_1, ν_2

$Q(F|\nu_1, \nu_2)=0.025$

$\nu_2 \backslash \nu_1$	1	2	3	4	5	6	8	12	15	20	30	60	∞
1	647.8	799.5	864.2	899.6	921.8	937.1	956.7	976.7	984.9	993.1	1001	1010	1018
2	38.51	39.00	39.17	39.25	39.30	39.33	39.37	39.41	39.43	39.45	39.46	39.48	39.50
3	17.44	16.04	15.44	15.10	14.88	14.73	14.54	14.34	14.25	14.17	14.08	13.99	13.90
4	12.22	10.65	9.98	9.60	9.36	9.20	8.98	8.75	8.66	8.56	8.46	8.36	8.26
5	10.01	8.43	7.76	7.39	7.15	6.98	6.76	6.52	6.43	6.33	6.23	6.12	6.02
6	8.81	7.26	6.60	6.23	5.99	5.82	5.60	5.37	5.27	5.17	5.07	4.96	4.85
7	8.07	6.54	5.89	5.52	5.29	5.12	4.90	4.67	4.57	4.47	4.36	4.25	4.14
8	7.57	6.06	5.42	5.05	4.82	4.65	4.43	4.20	4.10	4.00	3.89	3.78	3.67
9	7.21	5.71	5.08	4.72	4.48	4.32	4.10	3.87	3.77	3.67	3.56	3.45	3.33
10	6.94	5.46	4.83	4.47	4.24	4.07	3.85	3.62	3.52	3.42	3.31	3.20	3.08
11	6.72	5.26	4.63	4.28	4.04	3.88	3.66	3.43	3.33	3.23	3.12	3.00	2.88
12	6.55	5.10	4.47	4.12	3.89	3.73	3.51	3.28	3.18	3.07	2.96	2.85	2.72
13	6.41	4.97	4.35	4.00	3.77	3.60	3.39	3.15	3.05	2.95	2.84	2.72	2.60
14	6.30	4.86	4.24	3.89	3.66	3.50	3.29	3.05	2.95	2.84	2.73	2.61	2.49
15	6.20	4.77	4.15	3.80	3.58	3.41	3.20	2.96	2.86	2.76	2.64	2.52	2.40
16	6.12	4.69	4.08	3.73	3.50	3.34	3.12	2.89	2.79	2.68	2.57	2.45	2.32
17	6.04	4.62	4.01	3.66	3.44	3.28	3.06	2.82	2.72	2.62	2.50	2.38	2.25
18	5.98	4.56	3.95	3.61	3.38	3.22	3.01	2.77	2.67	2.56	2.44	2.32	2.19
19	5.92	4.51	3.90	3.56	3.33	3.17	2.96	2.72	2.62	2.51	2.39	2.27	2.13
20	5.87	4.46	3.86	3.51	3.29	3.13	2.91	2.68	2.57	2.46	2.35	2.22	2.09
21	5.83	4.42	3.82	3.48	3.25	3.09	2.87	2.64	2.53	2.42	2.31	2.18	2.04
22	5.79	4.38	3.78	3.44	3.22	3.05	2.84	2.60	2.50	2.39	2.27	2.14	2.00
23	5.75	4.35	3.75	3.41	3.18	3.02	2.81	2.57	2.47	2.36	2.24	2.11	1.97
24	5.72	4.32	3.72	3.38	3.15	2.99	2.78	2.54	2.44	2.33	2.21	2.08	1.94
25	5.69	4.29	3.69	3.35	3.13	2.97	2.75	2.51	2.41	2.30	2.18	2.05	1.91
26	5.66	4.27	3.67	3.33	3.10	2.94	2.73	2.49	2.39	2.28	2.16	2.03	1.88
27	5.63	4.24	3.65	3.31	3.08	2.92	2.71	2.47	2.36	2.25	2.13	2.00	1.85
28	5.61	4.22	3.63	3.29	3.06	2.90	2.69	2.45	2.34	2.23	2.11	1.98	1.83
29	5.59	4.20	3.61	3.27	3.04	2.88	2.67	2.43	2.32	2.21	2.09	1.96	1.81
30	5.57	4.18	3.59	3.25	3.03	2.87	2.65	2.41	2.31	2.20	2.07	1.94	1.79
40	5.42	4.05	3.46	3.13	2.90	2.74	2.53	2.29	2.18	2.07	1.94	1.80	1.64
60	5.29	3.93	3.34	3.01	2.79	2.63	2.41	2.17	2.06	1.94	1.82	1.67	1.48
120	5.15	3.80	3.23	2.89	2.67	2.52	2.30	2.05	1.94	1.82	1.69	1.53	1.31
∞	5.02	3.69	3.12	2.79	2.57	2.41	2.19	1.94	1.83	1.71	1.57	1.39	1.00

$Q(F|\nu_1, \nu_2)=0.01$

$\nu_2 \backslash \nu_1$	1	2	3	4	5	6	8	12	15	20	30	60	∞
1	4052	4999.5	5403	5625	5764	5859	5982	6106	6157	6209	6261	6313	6366
2	98.50	99.00	99.17	99.25	99.30	99.33	99.37	99.42	99.43	99.45	99.47	99.48	99.50
3	34.12	30.82	29.46	28.71	28.24	27.91	27.49	27.05	26.87	26.69	26.50	26.32	26.13
4	21.20	18.00	16.69	15.98	15.52	15.21	14.80	14.37	14.20	14.02	13.84	13.65	13.46
5	16.26	13.27	12.06	11.39	10.97	10.67	10.29	9.89	9.72	9.55	9.38	9.20	9.02
6	13.75	10.92	9.78	9.15	8.75	8.47	8.10	7.72	7.56	7.40	7.23	7.06	6.88
7	12.25	9.55	8.45	7.85	7.46	7.19	6.84	6.47	6.31	6.16	5.99	5.82	5.65
8	11.26	8.65	7.59	7.01	6.63	6.37	6.03	5.67	5.52	5.36	5.20	5.03	4.86
9	10.56	8.02	6.99	6.42	6.06	5.80	5.47	5.11	4.96	4.81	4.65	4.48	4.31
10	10.04	7.56	6.55	5.99	5.64	5.39	5.06	4.71	4.56	4.41	4.25	4.08	3.91
11	9.65	7.21	6.22	5.67	5.32	5.07	4.74	4.40	4.25	4.10	3.94	3.78	3.60
12	9.33	6.93	5.95	5.41	5.06	4.82	4.50	4.16	4.01	3.86	3.70	3.54	3.36
13	9.07	6.70	5.74	5.21	4.86	4.62	4.30	3.96	3.82	3.66	3.51	3.34	3.17
14	8.86	6.51	5.56	5.04	4.69	4.46	4.14	3.80	3.66	3.51	3.35	3.18	3.00
15	8.68	6.36	5.42	4.89	4.56	4.32	4.00	3.67	3.52	3.37	3.21	3.05	2.87
16	8.53	6.23	5.29	4.77	4.44	4.20	3.89	3.55	3.41	3.26	3.10	2.93	2.75
17	8.40	6.11	5.18	4.67	4.34	4.10	3.79	3.46	3.31	3.16	3.00	2.83	2.65
18	8.29	6.01	5.09	4.58	4.25	4.01	3.71	3.37	3.23	3.08	2.92	2.75	2.57
19	8.18	5.93	5.01	4.50	4.17	3.94	3.63	3.30	3.15	3.00	2.84	2.67	2.49
20	8.10	5.85	4.94	4.43	4.10	3.87	3.56	3.23	3.09	2.94	2.78	2.61	2.42
21	8.02	5.78	4.87	4.37	4.04	3.81	3.51	3.17	3.03	2.88	2.72	2.55	2.36
22	7.95	5.72	4.82	4.31	3.99	3.76	3.45	3.12	2.98	2.83	2.67	2.50	2.31
23	7.88	5.66	4.76	4.26	3.94	3.71	3.41	3.07	2.93	2.78	2.62	2.45	2.26
24	7.82	5.61	4.72	4.22	3.90	3.67	3.36	3.03	2.89	2.74	2.58	2.40	2.21
25	7.77	5.57	4.68	4.18	3.85	3.63	3.32	2.99	2.85	2.70	2.54	2.36	2.17
26	7.72	5.53	4.64	4.14	3.82	3.59	3.29	2.96	2.81	2.66	2.50	2.33	2.13
27	7.68	5.49	4.60	4.11	3.78	3.56	3.26	2.93	2.78	2.63	2.47	2.29	2.10
28	7.64	5.45	4.57	4.07	3.75	3.53	3.23	2.90	2.75	2.60	2.44	2.26	2.06
29	7.60	5.42	4.54	4.04	3.73	3.50	3.20	2.87	2.73	2.57	2.41	2.23	2.03
30	7.56	5.39	4.51	4.02	3.70	3.47	3.17	2.84	2.70	2.55	2.39	2.21	2.01
40	7.31	5.18	4.31	3.83	3.51	3.29	2.99	2.66	2.52	2.37	2.20	2.02	1.80
60	7.08	4.98	4.13	3.65	3.34	3.12	2.82	2.50	2.35	2.20	2.03	1.84	1.60
120	6.85	4.79	3.95	3.48	3.17	2.96	2.66	2.34	2.19	2.03	1.86	1.66	1.38
∞	6.63	4.61	3.78	3.32	3.02	2.80	2.51	2.18	2.04	1.88	1.70	1.47	1.00

PERCENTAGE POINTS OF THE F-DISTRIBUTION—VALUES

Table 26.9

OF F IN TERMS OF Q, ν_1, ν_2

$$Q(F|\nu_1, \nu_2) = 0.005$$

$\nu_2 \backslash \nu_1$	1	2	3	4	5	6	8	12	15	20	30	60	∞
1	16211	20000	21615	22500	23056	23437	23925	24426	24630	24836	25044	25253	25465
2	198.5	199.0	199.2	199.2	199.3	199.3	199.4	199.4	199.4	199.4	199.5	199.5	199.5
3	55.55	49.80	47.47	46.19	45.35	44.84	44.13	43.39	43.08	42.78	42.47	42.15	41.83
4	31.33	26.28	24.26	23.15	22.46	21.97	21.35	20.70	20.44	20.17	19.89	19.61	19.32
5	22.78	18.31	16.53	15.56	14.94	14.51	13.96	13.38	13.15	12.90	12.66	12.40	12.14
6	18.63	14.54	12.92	12.03	11.46	11.07	10.57	10.03	9.81	9.59	9.36	9.12	8.88
7	16.24	12.40	10.88	10.05	9.52	9.16	8.68	8.18	7.97	7.75	7.53	7.31	7.08
8	14.69	11.04	9.60	8.81	8.30	7.95	7.50	7.01	6.81	6.61	6.40	6.18	5.95
9	13.61	10.11	8.72	7.96	7.47	7.13	6.69	6.23	6.03	5.83	5.62	5.41	5.19
10	12.83	9.43	8.08	7.34	6.87	6.54	6.12	5.66	5.47	5.27	5.07	4.86	4.64
11	12.23	8.91	7.60	6.88	6.42	6.10	5.68	5.24	5.05	4.86	4.65	4.44	4.23
12	11.75	8.51	7.23	6.52	6.07	5.76	5.35	4.91	4.72	4.53	4.33	4.12	3.90
13	11.37	8.19	6.93	6.23	5.79	5.48	5.08	4.64	4.46	4.27	4.07	3.87	3.65
14	11.06	7.92	6.68	6.00	5.56	5.26	4.86	4.43	4.25	4.06	3.86	3.66	3.44
15	10.80	7.70	6.48	5.80	5.37	5.07	4.67	4.25	4.07	3.88	3.69	3.48	3.26
16	10.58	7.51	6.30	5.64	5.21	4.91	4.52	4.10	3.92	3.73	3.54	3.33	3.11
17	10.38	7.35	6.16	5.50	5.07	4.78	4.39	3.97	3.79	3.61	3.41	3.21	2.98
18	10.22	7.21	6.03	5.37	4.94	4.66	4.28	3.86	3.68	3.50	3.30	3.10	2.87
19	10.07	7.09	5.92	5.27	4.85	4.56	4.18	3.76	3.59	3.40	3.21	3.00	2.78
20	9.94	6.99	5.82	5.17	4.76	4.47	4.09	3.68	3.50	3.32	3.12	2.92	2.69
21	9.83	6.89	5.73	5.09	4.68	4.39	4.01	3.60	3.43	3.24	3.05	2.84	2.61
22	9.73	6.81	5.65	5.02	4.61	4.32	3.94	3.54	3.36	3.18	2.98	2.77	2.55
23	9.63	6.73	5.58	4.95	4.54	4.26	3.88	3.47	3.30	3.12	2.92	2.71	2.48
24	9.55	6.66	5.52	4.89	4.49	4.21	3.83	3.42	3.25	3.06	2.87	2.66	2.43
25	9.48	6.60	5.46	4.84	4.43	4.15	3.78	3.37	3.20	3.01	2.82	2.61	2.38
26	9.41	6.54	5.41	4.79	4.38	4.10	3.73	3.33	3.15	2.97	2.77	2.56	2.33
27	9.34	6.49	5.36	4.74	4.34	4.06	3.69	3.28	3.11	2.93	2.73	2.52	2.29
28	9.28	6.44	5.32	4.70	4.30	4.02	3.65	3.25	3.07	2.89	2.69	2.48	2.25
29	9.23	6.40	5.28	4.66	4.26	3.98	3.61	3.21	3.04	2.86	2.66	2.45	2.21
30	9.18	6.35	5.24	4.62	4.23	3.95	3.58	3.18	3.01	2.82	2.63	2.42	2.18
40	8.83	6.07	4.98	4.37	3.99	3.71	3.35	2.95	2.78	2.60	2.40	2.18	1.93
60	8.49	5.79	4.73	4.14	3.76	3.49	3.13	2.74	2.57	2.39	2.19	1.96	1.69
120	8.18	5.54	4.50	3.92	3.55	3.28	2.93	2.54	2.37	2.19	1.98	1.75	1.43
∞	7.88	5.30	4.28	3.72	3.35	3.09	2.74	2.36	2.19	2.00	1.79	1.55	1.00

$$Q(F|\nu_1, \nu_2) = 0.001$$

$\nu_2 \backslash \nu_1$	1	2	3	4	5	6	8	12	15	20	30	60	∞
1	(5)4.053	(5)5.000	(5)5.404	(5)5.625	(5)5.764	(5)5.859	(5)5.981	(5)6.107	(5)6.158	(5)6.209	(5)6.261	(5)6.313	(5)6.366
2	998.5	999.0	999.2	999.2	999.3	999.3	999.4	999.4	999.4	999.5	999.5	999.5	999.5
3	167.0	148.5	141.1	137.1	134.6	132.8	130.6	128.3	127.4	126.4	125.4	124.5	123.5
4	74.14	61.25	56.18	53.44	51.71	50.53	49.00	47.41	46.76	46.10	45.43	44.75	44.05
5	47.18	37.12	33.20	31.09	29.75	28.84	27.64	26.42	25.91	25.39	24.87	24.33	23.79
6	35.51	27.00	23.70	21.92	20.81	20.03	19.03	17.99	17.56	17.12	16.67	16.21	15.75
7	29.25	21.69	18.77	17.19	16.21	15.52	14.63	13.71	13.32	12.93	12.53	12.12	11.70
8	25.42	18.49	15.83	14.39	13.49	12.86	12.04	11.19	10.84	10.48	10.11	9.73	9.33
9	22.86	16.39	13.90	12.56	11.71	11.13	10.37	9.57	9.24	8.90	8.55	8.19	7.81
10	21.04	14.91	12.55	11.28	10.48	9.92	9.20	8.45	8.13	7.80	7.47	7.12	6.76
11	19.69	13.81	11.56	10.35	9.58	9.05	8.35	7.63	7.32	7.01	6.68	6.35	6.00
12	18.64	12.97	10.80	9.63	8.89	8.38	7.71	7.00	6.71	6.40	6.09	5.76	5.42
13	17.81	12.31	10.21	9.07	8.35	7.86	7.21	6.52	6.23	5.93	5.63	5.30	4.97
14	17.14	11.78	9.73	8.62	7.92	7.43	6.80	6.13	5.85	5.56	5.25	4.94	4.60
15	16.59	11.34	9.34	8.25	7.57	7.09	6.47	5.81	5.54	5.25	4.95	4.64	4.31
16	16.12	10.97	9.00	7.94	7.27	6.81	6.19	5.55	5.27	4.99	4.70	4.39	4.06
17	15.72	10.66	8.73	7.68	7.02	6.56	5.96	5.32	5.05	4.78	4.48	4.18	3.85
18	15.38	10.39	8.49	7.46	6.81	6.35	5.76	5.13	4.87	4.59	4.30	4.00	3.67
19	15.08	10.16	8.28	7.26	6.62	6.18	5.59	4.97	4.70	4.43	4.14	3.84	3.51
20	14.82	9.95	8.10	7.10	6.46	6.02	5.44	4.82	4.56	4.29	4.00	3.70	3.38
21	14.59	9.77	7.94	6.95	6.32	5.88	5.31	4.70	4.44	4.17	3.88	3.58	3.26
22	14.38	9.61	7.80	6.81	6.19	5.76	5.19	4.58	4.33	4.06	3.78	3.48	3.15
23	14.19	9.47	7.67	6.69	6.08	5.65	5.09	4.48	4.23	3.96	3.68	3.38	3.05
24	14.03	9.34	7.55	6.59	5.98	5.55	4.99	4.39	4.14	3.87	3.59	3.29	2.97
25	13.88	9.22	7.45	6.49	5.88	5.46	4.91	4.31	4.06	3.79	3.52	3.22	2.89
26	13.74	9.12	7.36	6.41	5.80	5.38	4.83	4.24	3.99	3.72	3.44	3.15	2.82
27	13.61	9.02	7.27	6.33	5.73	5.31	4.76	4.17	3.92	3.66	3.38	3.08	2.75
28	13.50	8.93	7.19	6.25	5.66	5.24	4.69	4.11	3.86	3.60	3.32	3.02	2.69
29	13.39	8.85	7.12	6.19	5.59	5.18	4.64	4.05	3.80	3.54	3.27	2.97	2.64
30	13.29	8.77	7.05	6.12	5.53	5.12	4.58	4.00	3.75	3.49	3.22	2.92	2.59
40	12.61	8.25	6.60	5.70	5.13	4.73	4.21	3.64	3.40	3.15	2.87	2.57	2.23
60	11.97	7.76	6.17	5.31	4.76	4.37	3.87	3.31	3.08	2.83	2.55	2.25	1.89
120	11.38	7.32	5.79	4.95	4.42	4.04	3.55	3.02	2.78	2.53	2.26	1.95	1.54
∞	10.83	6.91	5.42	4.62	4.10	3.74	3.27	2.74	2.51	2.27	1.99	1.66	1.00

*See page II.

Table 26.10 (BILATÉRAL)
 PERCENTAGE POINTS OF THE *t*-DISTRIBUTION—VALUES OF *t* IN TERMS OF *A* AND *ν*

<i>ν</i> \ <i>A</i>	0.2	0.5	0.8	0.9	0.95	0.98	0.99	0.995	0.998	0.999	0.9999	0.99999	0.999999
1	0.325	1.000	3.078	6.314	12.706	31.821	63.657	127.321	318.309	636.619	6366.198	63661.977	636619.772
2	0.289	0.816	1.886	2.920	4.303	6.965	9.925	14.089	22.327	31.598	99.992	316.225	999.999
3	0.277	0.765	1.638	2.353	3.182	4.541	5.841	7.453	10.214	12.924	28.000	60.397	130.155
4	0.271	0.741	1.533	2.132	2.776	3.747	4.604	5.598	7.173	8.610	15.544	27.771	49.459
5	0.267	0.727	1.476	2.015	2.571	3.365	4.032	4.773	5.893	6.869	11.178	17.897	28.477
6	0.265	0.718	1.440	1.943	2.447	3.143	3.707	4.317	5.208	5.959	9.082	13.555	20.047
7	0.263	0.711	1.415	1.895	2.365	2.998	3.499	4.029	4.785	5.408	7.885	11.215	15.764
8	0.262	0.706	1.397	1.860	2.306	2.896	3.355	3.833	4.501	5.041	7.120	9.782	13.257
9	0.261	0.703	1.383	1.833	2.262	2.821	3.250	3.690	4.297	4.781	6.594	8.827	11.637
10	0.260	0.700	1.372	1.812	2.228	2.764	3.169	3.581	4.144	4.587	6.211	8.150	10.516
11	0.260	0.697	1.363	1.796	2.201	2.718	3.106	3.497	4.025	4.437	5.921	7.648	9.702
12	0.259	0.695	1.356	1.782	2.179	2.681	3.055	3.428	3.930	4.318	5.694	7.261	9.085
13	0.259	0.694	1.350	1.771	2.160	2.650	3.012	3.372	3.852	4.221	5.513	6.955	8.604
14	0.258	0.692	1.345	1.761	2.145	2.624	2.977	3.326	3.787	4.140	5.363	6.706	8.218
15	0.258	0.691	1.341	1.753	2.131	2.602	2.947	3.286	3.733	4.073	5.239	6.502	7.903
16	0.258	0.690	1.337	1.746	2.120	2.583	2.921	3.252	3.686	4.015	5.134	6.330	7.642
17	0.257	0.689	1.333	1.740	2.110	2.567	2.898	3.223	3.646	3.965	5.044	6.184	7.421
18	0.257	0.688	1.330	1.734	2.101	2.552	2.878	3.197	3.610	3.922	4.966	6.059	7.232
19	0.257	0.688	1.328	1.729	2.093	2.539	2.861	3.174	3.579	3.883	4.897	5.949	7.069
20	0.257	0.687	1.325	1.725	2.086	2.528	2.845	3.153	3.552	3.850	4.837	5.854	6.927
21	0.257	0.686	1.323	1.721	2.080	2.518	2.831	3.135	3.527	3.819	4.784	5.769	6.802
22	0.256	0.686	1.321	1.717	2.074	2.508	2.819	3.119	3.505	3.792	4.736	5.694	6.692
23	0.256	0.685	1.319	1.714	2.069	2.500	2.807	3.104	3.485	3.768	4.693	5.627	6.593
24	0.256	0.685	1.318	1.711	2.064	2.492	2.797	3.090	3.467	3.745	4.654	5.566	6.504
25	0.256	0.684	1.316	1.708	2.060	2.485	2.787	3.078	3.450	3.725	4.619	5.511	6.424
26	0.256	0.684	1.315	1.706	2.056	2.479	2.779	3.067	3.435	3.707	4.587	5.461	6.352
27	0.256	0.684	1.314	1.703	2.052	2.473	2.771	3.057	3.421	3.690	4.558	5.415	6.286
28	0.256	0.683	1.313	1.701	2.048	2.467	2.763	3.047	3.408	3.674	4.530	5.373	6.225
29	0.256	0.683	1.311	1.699	2.045	2.462	2.756	3.038	3.396	3.659	4.506	5.335	6.170
30	0.256	0.683	1.310	1.697	2.042	2.457	2.750	3.030	3.385	3.646	4.482	5.299	6.119
40	0.255	0.681	1.303	1.684	2.021	2.423	2.704	2.971	3.307	3.551	4.321	5.053	5.768
60	0.254	0.679	1.296	1.671	2.000	2.390	2.660	2.915	3.232	3.460	4.169	4.825	5.449
120	0.254	0.677	1.289	1.658	1.980	2.358	2.617	2.860	3.160	3.373	4.025	4.613	5.158
∞	0.253	0.674	1.282	1.645	1.960	2.326	2.576	2.807	3.090	3.291	3.891	4.417	4.892

$$A = A(t; \nu) = \left[\sqrt{\nu} B \left(\frac{1}{2}, \frac{\nu}{2} \right) \right]^{-1} \int_{-t}^t (1+x^2)^{-\frac{(\nu+1)}{2}} dx$$

From E. S. Pearson and H. O. Hartley (editors), *Biometrika tables for statisticians*, vol. I. Cambridge Univ. Press, Cambridge, England, 1954 for *A* 0.999, from E. T. Federighi, *Extended tables of the percentage points of Student's *t*-distribution*, *J. Amer. Statist. Assoc.* 54, 683-688 (1959) for *A* 0.999 (with permission).

*See page 11.

2500 FIVE DIGIT RANDOM NUMBERS

Table 26.11

53479	81115	98036	12217	59526	40238	40577	39351	43211	69255
97344	70328	58116	91964	26240	44643	83287	97391	92823	77578
66023	38277	74523	71118	84892	13956	98899	92315	65783	59640
99776	75723	03172	43112	83086	81982	14538	26162	24899	20551
30176	48979	92153	38416	42436	26636	83903	44722	69210	69117
81874	83339	14988	99937	13213	30177	47967	93793	86693	98854
19839	90630	71863	95053	55532	60908	84108	55342	48479	63799
09337	33435	53869	52769	18801	25820	96198	66518	78314	97013
31151	58295	40823	41330	21093	93882	49192	44876	47185	81425
67619	52515	03037	81699	17106	64982	60834	85319	47814	08075
61946	48790	11602	83043	22257	11832	04344	95541	20366	55937
04811	64892	96346	79065	26999	43967	63485	93572	80753	96582
05763	39601	56140	25513	86151	78657	02184	29715	04334	15678
73260	56877	40794	13948	96289	90185	47111	66807	61849	44686
54909	09976	76580	02645	35795	44537	64428	35441	28318	99001
42583	36335	60068	04044	29678	16342	48592	25547	63177	75225
27266	27403	97520	23334	36453	33699	23672	45884	41515	04756
49843	11442	66682	36055	32002	78600	36924	59962	68191	62580
29316	40460	27076	69232	51423	58515	49920	03901	26597	33068
30463	27856	67798	16837	74273	05793	02900	63498	00782	35097
28708	84088	65535	44258	33869	82530	98399	26387	02836	36838
13183	50652	94872	28257	78547	55286	33591	61965	51723	14211
60796	76639	30157	40295	99476	28334	15368	42481	60312	42770
13486	46918	64683	07411	77842	01908	47796	65796	44230	77230
34914	94502	39374	34185	57500	22514	04060	94511	44612	10485
28105	04814	85170	86490	35695	03483	57315	63174	71902	71182
59231	45028	01173	08848	81925	71494	95401	34049	04851	65914
87437	82758	71093	36833	53582	25986	46005	42840	81683	21459
29046	01301	55343	65732	78714	43644	46248	53205	94868	48711
62035	71886	94506	15263	61435	10369	42054	68257	14385	79436
38856	80048	59973	73368	52876	47673	41020	82295	26430	87377
40666	43328	87379	86418	95841	25590	54137	94182	42308	07361
40588	90087	37729	08667	37256	20317	53316	50982	32900	32097
78237	86556	50276	20431	00243	02303	71029	49932	23245	00862
98247	67474	71455	69540	01169	03320	67017	92543	97977	52728
69977	78558	65430	32627	28312	61815	14598	79728	55699	91348
39843	23074	40814	03713	21891	96353	96806	24595	26203	26009
62880	87277	99895	99965	34374	42556	11679	99605	98011	48867
56138	64927	29454	52967	86624	62422	30163	76181	95317	39264
90804	56026	48994	64569	67465	60180	12972	03848	62582	93855
09665	44672	74762	33357	67301	80546	97659	11348	78771	45011
34756	50403	76634	12767	32220	34545	18100	53513	14521	72120
12157	73327	74196	26668	78087	53636	52304	00007	05708	63538
69384	07734	94451	76428	16121	09300	67417	68587	87932	38840
93358	64565	43766	45041	44930	69970	16964	08277	67752	60292
38879	35544	99563	85404	04913	62547	78406	01017	86187	22072
58314	60298	72394	69668	12474	93059	02053	29807	63645	12792
83568	10227	99471	74729	22075	10233	21575	20325	21317	57124
28067	91152	40568	33705	64510	07067	64374	26336	79652	31140
05730	75557	93161	80921	55873	54103	34801	83157	04534	81368

Compiled from Rand Corporation, A million random digits with 100,000 normal deviates. The Free Press, Glencoe, Ill., 1955 (with permission).

Table 26.11 2500 FIVE DIGIT RANDOM NUMBERS

26687	74223	43546	45699	94469	82125	37370	23966	68926	37664
60675	75169	24510	15100	02011	14375	65187	10630	64421	66745
45418	98635	83123	98558	09953	60255	42071	40930	97992	93085
69872	48026	89755	28470	44130	59979	91063	28766	85962	77173
03765	86366	99539	44183	23886	89977	11964	51581	18033	56239
84686	57636	32326	19867	71345	42002	96997	84379	27991	21459
91512	49670	32556	85189	28023	88151	62896	95498	29423	38138
10737	49307	18307	22246	22461	10003	93157	66984	44919	30467
54870	19676	58367	20905	38324	00026	98440	37427	22896	37637
48967	49579	65369	74305	62085	39297	10309	23173	74212	32272
91430	79112	03685	05411	23027	54735	91550	06250	18705	18909
92564	29567	47476	62804	73428	04535	86395	12162	59647	97726
41734	12199	77441	92415	63542	42115	84972	12454	33133	48467
25251	78110	54178	78241	09226	87529	35376	90690	54178	08561
91657	11563	66036	28523	83705	09956	76610	88116	78351	50877
00149	84745	63222	50533	50159	60433	04822	49577	89049	16162
53250	73200	84066	59620	61009	38542	05758	06178	80193	26466
25587	17481	56716	49749	70733	32733	60365	14108	52573	39391
01176	12182	06882	27562	75456	54261	38564	89054	96911	88906
83531	15544	40834	20296	88576	47815	96540	79462	78666	25353
19902	98866	32805	61091	91587	30340	84909	64047	67750	87638
96516	78705	25556	35181	29064	49005	29843	68949	50506	45862
99417	56171	19848	24352	51844	03791	72127	57958	08366	43190
77699	57853	93213	27342	28906	31052	65815	21637	49385	75406
32245	83794	99528	05150	27246	48263	62156	62469	97048	16511
12874	72753	66469	13782	64330	00056	73324	03920	13193	19466
63899	41910	45484	55461	66518	82486	74694	07865	09724	76490
16255	43271	26540	41298	35095	32170	70625	66407	01050	44225
75553	30207	41814	74985	40223	91223	64238	73012	83100	92041
41772	18441	34685	13892	38843	69007	10362	84125	08814	66785
09270	01245	81765	06809	10561	10080	17482	05471	82273	06902
85058	17815	71551	36356	97519	54144	51132	83169	27373	68609
80222	87572	62758	14858	36350	23304	70453	21065	63812	29860
83901	88028	56743	25598	79349	47880	77912	52020	84305	02897
36303	57833	77622	02238	53285	77316	40106	38456	92214	54278
91543	63886	60539	96334	20804	72692	08944	02870	74892	22598
14415	33816	78231	87674	96473	44451	25098	29296	50679	07798
82465	07781	09938	66874	72128	99685	84329	14530	08410	45953
27306	39843	05634	96368	72022	01278	92830	40094	31776	41822
91960	82766	02331	08797	33858	21847	17391	53755	58079	48498
59284	96108	91610	07483	37943	96832	15444	12091	36690	58317
10428	96003	71223	21352	78685	55964	35510	94805	23422	04492
65527	41039	79574	05105	59588	02115	33446	56780	18402	36279
59688	43078	93275	31978	08768	84805	50661	18523	83235	50602
44452	10188	43565	46531	93023	07618	12910	60934	53403	18401
87275	82013	59804	78595	60553	14038	12096	95472	42736	08573
94155	93110	49964	27753	85090	77677	69303	66323	77811	22791
26488	76394	91282	03419	68758	89575	66469	97835	66681	03171
37073	34547	88296	68638	12976	50896	10023	27220	05785	77538
83835	89575	55956	93957	30361	47679	83001	35056	07103	63072

2500 FIVE DIGIT RANDOM NUMBERS

Table 26.11

55034	81217	90564	81943	11241	84512	12288	89862	00760	76159
25521	99536	43233	48786	49221	06960	31564	21458	88199	06312
85421	72744	97242	66383	00132	05661	96442	37388	57671	27916
61219	48390	47344	30413	39392	91365	56203	79204	05330	31196
20230	03147	58854	11650	28415	12821	58931	30508	65989	26675
95776	83206	56144	55953	89787	64426	08448	45707	80364	60262
07603	17344	01148	83300	96955	65027	31713	89013	79557	49755
00645	17459	78742	39005	36027	98807	72666	54484	68262	38827
62950	83162	61504	31557	80590	47893	72360	72720	08396	33674
79350	10276	81933	26347	08068	67816	06659	87917	74166	85519
48339	69834	59047	82175	92010	58446	69591	56205	95700	86211
05842	08439	79836	50957	32059	32910	15842	13918	41365	80115
25855	02209	07307	59942	71389	76159	11263	38787	61541	22606
25272	16152	82323	70718	98081	38631	91956	49909	76253	33970
73003	29058	17605	49298	47675	90445	68919	05676	23823	84892
81310	94430	22663	06584	38142	00146	17496	51115	61458	65790
10024	44713	59832	80721	63711	67882	25100	45345	55743	67618
84671	52806	89124	37691	20897	82339	22627	06142	05773	03547
29296	58162	21858	33732	94056	88806	54603	00384	66340	69232
51771	94074	70630	41286	90583	87680	13961	55627	23670	35109
42166	56251	60770	51672	36031	77273	85218	14812	90758	23677
78355	67041	22492	51522	31164	30450	27600	44428	96380	26772
09552	51347	33864	89018	73418	81538	77399	30448	97740	18158
15771	63127	34847	05660	06156	48970	55699	61818	91763	20821
13231	99058	93754	36730	44286	44326	15729	37500	47269	13333
50583	03570	38472	73236	67613	72780	78174	18718	99092	64114
99485	57330	10634	74905	90671	19643	69903	60950	17968	37217
54676	39524	73785	48864	69835	62798	65205	69187	05572	74741
99343	71549	10248	76036	31702	76868	88909	69574	27642	00336
35492	40231	34868	55356	12847	68093	52643	32732	67016	46784
98170	25384	03841	23920	47954	10359	70114	11177	63298	99903
02670	86155	56860	02592	01646	42200	79950	37764	82341	71952
36934	42879	81637	79952	07066	41625	96804	92388	88860	68580
56851	12778	24309	73660	84264	24668	16686	02239	66022	64133
05464	28892	14271	23778	88599	17081	33884	88783	39015	57118
15025	20237	63386	71122	06620	07415	94982	32324	79427	70387
95610	08030	81469	91066	88857	56583	01224	28097	19726	71465
09026	40378	05731	55128	74298	49196	31669	42605	30368	96424
81431	99955	52462	67667	97322	69808	21240	65921	12629	92896
21431	59335	58627	94822	65484	09641	41018	85100	16110	32077
95832	76145	11636	80284	17787	97934	12822	73890	66009	27521
99813	44631	43746	99790	86823	12114	31706	05024	28156	04202
77210	31148	50543	11603	50934	02498	09184	95875	85840	71954
13268	02609	79833	66058	80277	08533	28676	37532	70535	82356
44285	71735	26620	54691	14909	52132	81110	74548	78853	31996
70526	45953	79637	57374	05053	31965	33376	13232	85666	86615
88386	11222	25080	71462	09818	46001	19065	68981	18310	74178
83161	73994	17209	79441	64091	49790	11936	44864	86978	34538
50214	71721	33851	45144	05696	29935	12823	01594	08453	52825
97689	29341	67747	80643	13620	23943	49396	83686	37302	95350

PROBABILITY FUNCTIONS

Table 26.11 2500 FIVE DIGIT RANDOM NUMBERS

12367	23891	31506	90721	18710	89140	58595	99425	22840	08267
38890	30239	34237	22578	74420	22734	26930	40604	10782	80128
80788	55410	39770	93317	18270	21141	52085	78093	85638	81140
02395	77585	08854	23562	33544	45796	10976	44721	24781	09690
73720	70184	69112	71887	80140	72876	38984	23409	63957	44751
61383	17222	55234	18963	39006	93504	18273	49815	52802	69675
39161	44282	14975	97498	25973	33605	60141	30030	77677	49294
80907	74484	39884	19885	37311	04209	49675	39596	01052	43999
09052	65670	63660	34035	06578	87837	28125	48883	50482	55735
33425	24226	32043	60082	20418	85047	53570	32554	64099	52326
72651	69474	73648	71530	55454	19576	15552	20577	12124	50038
04142	32092	83586	61825	35482	32736	63403	91499	37196	02762
85226	14193	52213	60746	24414	57858	31884	51266	82293	73553
54888	03579	91674	59502	08619	33790	29011	85193	62262	28684
33258	51516	82032	45233	39351	33229	59464	65545	76809	16982
75973	15957	32405	82081	02214	57143	33526	47194	94526	73253
90638	75314	35381	34451	49246	11465	25102	71489	89883	99708
65061	15498	93348	33566	19427	66826	03044	97361	08159	47485
64420	07427	82233	97812	39572	07766	65844	29980	15533	90114
27175	17389	76963	75117	45580	99904	47160	55364	25666	25405
32215	30094	87276	56896	15625	32594	80663	08082	19422	80717
54209	58043	72350	89828	02706	16815	89985	37380	44032	59366
59286	66964	84843	71549	67553	33867	83011	66213	69372	23903
83872	58167	01221	95558	22196	65905	38785	01355	47489	28170
83310	57080	03366	80017	39601	40698	56434	64055	02495	50880
64545	29500	13351	78647	92628	19354	60479	57338	52133	07114
39269	00076	55489	01524	76568	22571	20328	84623	30188	43904
29763	05675	28193	65514	11954	78599	63902	21346	19219	90286
06310	02998	01463	27738	90288	17697	64511	39552	34694	03211
97541	47607	57655	59102	21851	44446	07976	54295	84671	78755
82968	85717	11619	97721	53513	53781	98941	38401	70939	11319
76878	34727	12524	90642	16921	13669	17420	84483	68309	85241
87394	78884	87237	92086	95633	66841	22906	64989	86952	54700
74040	12731	59616	33697	12592	44891	67982	72972	89795	10587
47896	41413	66431	70046	50793	45920	96564	67958	56369	44725
87778	71697	64148	54363	92114	34037	59061	62051	62049	33526
96977	63143	72219	80040	11990	47698	95621	72990	29047	85893
43820	13285	77811	81697	29937	70750	02029	32377	00556	86687
57203	83960	40096	39234	65953	59911	91411	55573	88427	45573
49065	72171	80939	06017	90323	63687	07932	99587	49014	26452
94250	84270	95798	13477	80139	26335	55169	73417	40766	45170
68148	81382	82383	18674	40453	92828	30042	37412	43423	45138
12208	97809	33619	28868	41646	16734	88860	32636	41985	84615
88317	89705	26119	12416	19438	65665	60989	59766	11418	18250
56728	80359	29613	63052	15251	44684	64681	42354	51029	77680
07138	12320	01073	19304	87042	58920	28454	81069	93978	66659
21188	64554	55618	36088	24331	84390	16022	12200	77559	75661
02154	12250	88738	43917	03655	21099	60805	63246	26842	35816
90953	85238	32771	07305	36181	47420	19681	33184	41386	03249
80103	91308	12858	41293	00325	15013	19579	91132	12720	92603

2500 FIVE DIGIT RANDOM NUMBERS

Table 26.11

92630	78240	19267	95457	53497	23894	37708	79862	76471	66418
79445	78735	71549	44843	26104	67318	00701	34986	66751	99723
59654	71966	27386	50004	05358	94031	29281	18544	52429	06080
31524	49587	76612	39789	13537	48086	59483	60680	84675	53014
06348	76938	90379	51392	55887	71015	09209	79157	24440	30244
28703	51709	94456	48396	73780	06436	86641	69239	57662	80181
68108	89266	94730	95761	75023	48464	65544	96583	18911	16391
99938	90704	93621	66330	33393	95261	95349	51769	91616	33238
91543	73196	34449	63513	83834	99411	58826	40456	69268	48562
42103	02781	73920	56297	72678	12249	25270	36678	21313	75767
17138	27584	25296	28387	51350	61664	37893	05363	44143	42677
28297	14280	54524	21618	95320	38174	60579	08089	94999	78460
09331	56712	51333	06289	75345	08811	82711	57392	25252	30333
31295	04204	93712	51287	05754	79396	87399	51773	33075	97061
36146	15560	27592	42089	99281	59640	15221	96079	09961	05371
29553	18432	13630	05529	02791	81017	49027	79031	50912	09399
23501	22642	63081	08191	89420	67800	55137	54707	32945	64522
57888	85846	67967	07835	11314	01545	48535	17142	08552	67457
55336	71264	88472	04334	63919	36394	11196	92470	70543	29776
10087	10072	55980	64688	68239	20461	89381	93809	00796	95945
34101	81277	66090	88872	37818	72142	67140	50785	21380	16703
53362	44940	60430	22834	14130	96593	23298	56203	92671	15925
82975	66158	84731	19436	55790	69229	28661	13675	99318	76873
54827	84673	22898	08094	14326	87038	42892	21127	30712	48489
25464	59098	27436	89421	80754	89924	19097	67737	80368	08795
67609	60214	41475	84950	40133	02546	09570	45682	50165	15609
44921	70924	61295	51137	47596	86735	35561	76649	18217	63446
33170	30972	98130	95828	49786	13301	36081	80761	33985	68621
84687	85445	06208	17654	51333	02878	35010	67578	61574	20749
71886	56450	36567	09395	96951	35507	17555	35212	69106	01679
00475	02224	74722	14721	40215	21351	08596	45625	83981	63748
25993	38881	68361	59560	41274	69742	40703	37993	03435	18873
92882	53178	99195	93803	56985	53089	15305	50522	55900	43026
25138	26810	07093	15677	60688	04410	24505	37890	67186	62829
84631	71882	12991	83028	82484	90339	91950	74579	03539	90122
34003	92326	12793	61453	48121	74271	28363	66561	75220	35908
53775	45749	05734	86169	42762	70175	97310	73894	88606	19994
59316	97885	72807	54966	60859	11932	35265	71601	55577	67715
20479	66557	50705	26999	09854	52591	14063	30214	19890	19292
86180	84931	25455	26044	02227	52015	21820	50599	51671	65411
21451	68001	72710	40261	61281	13172	63819	48970	51732	54113
98062	68375	80089	24135	72355	95428	11808	29740	81644	86610
01788	64429	14430	94575	75153	94576	61393	96192	03227	32258
62465	04841	43272	68702	01274	05437	22953	18946	99053	41690
94324	31089	84159	92933	99989	89500	91586	02802	69471	68274
05797	43984	21575	09908	70221	19791	51578	36432	33494	79888
10395	14289	52185	09721	25789	38562	54794	04897	59012	89251
35177	56986	25549	59730	64718	52630	31100	62384	49483	11409
25633	89619	75882	98256	02126	72099	57183	55887	09320	73463
16464	48280	94254	45777	45150	68865	11382	11782	22695	41988

27. Miscellaneous Functions

IRENE A. STEGUN¹

Contents

	Page
27.1. Debye Functions $\int_0^x \frac{t^n dt}{e^t - 1}$	998
$n=1(1)4, x=0(.1)1.4(.2)5(.5)10, \quad 6D$	
27.2. Planck's Radiation Function $x^{-5}(e^{1/x} - 1)^{-1}$	999
$x=.05(.005).1(.01).2(.02).4(.05).9(.1)1.5(.5)3.5, \quad 3D$ $x_{\max}, f(x_{\max}), \quad 9-10S$	
27.3. Einstein Functions	999
$\frac{x^2 e^x}{(e^x - 1)^2}, \quad \frac{x}{e^x - 1}, \quad \ln(1 - e^{-x}), \quad \frac{x}{e^x - 1} - \ln(1 - e^{-x})$ $x=0(.05)1.5(.1)3(.2)6, \quad 5D$	
27.4. Sievert Integral $\int_0^\theta e^{-x \sec \phi} d\phi$	1000
$x=0(.1)1(.2)3(.5)10, \theta=10^\circ(10^\circ)60^\circ(15^\circ)90^\circ, \quad 6D$	
27.5. $f_m(x) = \int_0^\infty t^m e^{-t^2 - \frac{x}{t}} dt$ and Related Integrals	1001
$f_m(x), \quad m=1, 2, 3; x=0(.01).05, .1(.1)1, \quad 4D$ $f_3(ix), \quad x=0(.2)8(.5)15(1)20, \quad 4-5D$	
27.6. $f(x) = \int_0^\infty \frac{e^{-t^2}}{t+x} dt$	1003
$f(x) + \ln x, \quad x=0(.05)1$ $f(x), \quad x=1(.1)3(.5)8, \quad 4D$	
27.7. Dilogarithm (Spence's Integral) $f(x) = -\int_1^x \frac{\ln t}{t-1} dt$	1004
$x=0(.01).5, \quad 9D$	
27.8. Clausen's Integral and Related Summations	1005
$f(\theta) = -\int_0^\theta \ln\left(2 \sin \frac{t}{2}\right) dt = \sum_{n=1}^\infty \frac{\sin n\theta}{n^2}$ $f(\theta) + \theta \ln \theta, \quad \theta=0^\circ(1^\circ)15^\circ$ $f(\theta), \quad \theta=15^\circ(1^\circ)30^\circ(2^\circ)90^\circ(5^\circ)180^\circ, \quad 6D$	
27.9. Vector-Addition Coefficients $(j_1 j_2 m_1 m_2 j_1 j_2 j m)$	1006
Algebraic Expressions for $j_2=1/2, 1, 3/2, 2$ Decimal Values for $j_2=1/2, 1, 3/2, \quad 5D$	

¹ National Bureau of Standards.

27. Miscellaneous Functions

27.1. Debye Functions

Series Representations

27.1.1

$$\int_0^x \frac{t^n dt}{e^t - 1} = x^n \left[\frac{1}{n} - \frac{x}{2(n+1)} + \sum_{k=1}^{\infty} \frac{B_{2k} x^{2k}}{(2k+n)(2k)!} \right]$$

(|x| < 2π, n ≥ 1)

(For Bernoulli numbers B_{2k} , see chapter 23.)

27.1.2

$$\int_x^{\infty} \frac{t^n dt}{e^t - 1} = \sum_{k=1}^{\infty} e^{-kx} \left[\frac{x^n}{k} + \frac{nx^{n-1}}{k^2} + \frac{(n)(n-1)x^{n-2}}{k^3} + \dots + \frac{n!}{k^{n+1}} \right] (x > 0, n \geq 1)$$

Relation to Riemann Zeta Function (see chapter 23)

27.1.3 $\int_0^{\infty} \frac{t^n dt}{e^t - 1} = n! \zeta(n+1).$

[27.1] J. A. Beattie, Six-place tables of the Debye energy and specific heat functions, *J. Math. Phys.* **6**, 1-32 (1926).

$$\frac{3}{x^2} \int_0^x \frac{y^3 dy}{e^y - 1}, \frac{12}{x^3} \left[\int_0^x \frac{y^3 dy}{e^y - 1} - \frac{3x}{e^x - 1} \right], x=0(.01)24, \quad 6S.$$

[27.2] E. Grüneisen, Die Abhängigkeit des elektrischen Widerstandes reiner Metalle von der Temperatur, *Ann. Physik.* (5) **16**, 530-540 (1933).

$$\frac{20}{x^4} \int_0^x \frac{t^4 dt}{e^t - 1} - \frac{4x}{e^x - 1},$$

x=0(.1)13(.2)18(1)20(2)52(4)80, \quad 4S.

Table 27.1

Debye Functions

x	1 ∫₀ˣ t dt / (eᵗ - 1)	2 ∫₀ˣ t² dt / (eᵗ - 1)	3 ∫₀ˣ t³ dt / (eᵗ - 1)	4 ∫₀ˣ t⁴ dt / (eᵗ - 1)
0.0	1.000000	1.000000	1.000000	1.000000
0.1	0.975278	0.967083	0.963000	0.960555
0.2	0.951111	0.934999	0.926999	0.922221
0.3	0.927498	0.903746	0.891995	0.884994
0.4	0.904437	0.873322	0.857985	0.848871
0.5	0.881927	0.843721	0.824963	0.813846
0.6	0.859964	0.814940	0.792924	0.779911
0.7	0.838545	0.786973	0.761859	0.747057
0.8	0.817665	0.759813	0.731759	0.715275
0.9	0.797320	0.733451	0.702615	0.684551
1.0	0.777505	0.707878	0.674416	0.654874
1.1	0.758213	0.683086	0.647148	0.626228
1.2	0.739438	0.659064	0.620798	0.598598
1.3	0.721173	0.635800	0.595351	0.571967
1.4	0.703412	0.613281	0.570793	0.546317
1.6	0.669366	0.570431	0.524275	0.497882
1.8	0.637235	0.530404	0.481103	0.453131
2.0	0.606947	0.493083	0.441129	0.411893
2.2	0.578427	0.458343	0.404194	0.373984
2.4	0.551596	0.426057	0.370137	0.339218
2.6	0.526375	0.396095	0.338793	0.307405
2.8	0.502682	0.368324	0.309995	0.278355
3.0	0.480435	0.342614	0.283580	0.251879
3.2	0.459555	0.318834	0.259385	0.227792
3.4	0.439962	0.296859	0.237252	0.205915
3.6	0.421580	0.276565	0.217030	0.186075
3.8	0.404332	0.257835	0.198571	0.168107
4.0	0.388148	0.240554	0.181737	0.151855
4.2	0.372958	0.224615	0.166396	0.137169
4.4	0.358696	0.209916	0.152424	0.123913
4.6	0.345301	0.196361	0.139704	0.111957
4.8	0.332713	0.183860	0.128129	0.101180
5.0	0.320876	0.172329	0.117597	0.091471
5.5	0.294240	0.147243	0.095241	0.071228
6.0	0.271260	0.126669	0.077581	0.055677
6.5	0.251331	0.109727	0.063604	0.043730
7.0	0.233948	0.095707	0.052506	0.034541
7.5	0.218698	0.084039	0.043655	0.027453
8.0	0.205239	0.074269	0.036560	0.021968
8.5	0.193294	0.066036	0.030840	0.017702
9.0	0.182633	0.059053	0.026200	0.014368
9.5	0.173068	0.053092	0.022411	0.011747
10.0	0.164443	0.047971	0.019296	0.009674

$$\left[\begin{matrix} (-4)5 \\ 5 \end{matrix} \right]$$

$$\left[\begin{matrix} (-4)6 \\ 5 \end{matrix} \right]$$

$$\left[\begin{matrix} (-4)6 \\ 5 \end{matrix} \right]$$

$$\left[\begin{matrix} (-4)6 \\ 5 \end{matrix} \right]$$

Planck's Radiation Function

Table 27.2

$$f(x) = x^{-5}(e^{1/x} - 1)^{-1}$$

x	$f(x)$	x	$f(x)$	x	$f(x)$	x	$f(x)$	x	$f(x)$
0.050	0.007	0.10	4.540	0.20	21.199	0.40	8.733	0.9	0.831
0.055	0.025	0.11	6.998	0.22	20.819	0.45	6.586	1.0	0.582
0.060	0.074	0.12	9.662	0.24	19.777	0.50	5.009	1.1	0.419
0.065	0.179	0.13	12.296	0.26	18.372	0.55	3.850	1.2	0.309
0.070	0.372	0.14	14.710	0.28	16.809	0.60	2.995	1.3	0.233
0.075	0.682	0.15	16.780	0.30	15.224	0.65	2.356	1.4	0.178
0.080	1.137	0.16	18.446	0.32	13.696	0.70	1.875	1.5	0.139
0.085	1.752	0.17	19.692	0.34	12.270	0.75	1.508	2.0	0.048
0.090	2.531	0.18	20.539	0.36	10.965	0.80	1.225	2.5	0.021
0.095	3.466	0.19	21.025	0.38	9.787	0.85	1.005	3.0	0.010
0.100	4.540	0.20	21.199	0.40	8.733	0.90	0.831	3.5	0.006

$$x_{\max} = .20140\ 52353 \quad f(x_{\max}) = 21.20143\ 58.$$

[27.3] Miscellaneous Physical Tables, Planck's radiation functions and electronic functions, MT 17 (U.S. Government Printing Office, Washington, D.C., 1941).

Table I: $\frac{R_\lambda}{R_{\lambda \max}}, \frac{R_{0-\lambda}}{R_{0-\infty}}, \frac{N_\lambda}{N_{\lambda \max}}, \frac{N_{0-\lambda}}{N_{0-\infty}}$ for $\lambda T = [.05(.001).1(.005).4(.01).6(.02)1(.05)2] \text{ cm } K^\circ$.

$$R_\lambda = c_1 \lambda^{-5} (e^{c_2/\lambda T} - 1)^{-1}, \quad R_{0-\lambda} = \int_0^\lambda R_\lambda d\lambda,$$

Table II: $R_\lambda, R_{0-\lambda}, N_\lambda, N_{0-\lambda}$ ($T = 1000^\circ \text{ K}$) for $\lambda = [.5(.01)1(.05)4(.1)6(.2)10(.5)20] \text{ microns}$.

$$N_\lambda = 2\pi c \lambda^{-4} (e^{c_2/\lambda T} - 1)^{-1}, \quad N_{0-\lambda} = \int_0^\lambda N_\lambda d\lambda$$

Table III: N_λ for $\lambda = [.25(.05)1.6(.2)3(1)10] \text{ microns}$, $T = [1000^\circ(500^\circ)3500^\circ \text{ K and } 6000^\circ \text{ K}]$.

Einstein Functions

Table 27.3

x	$\frac{x^2 e^x}{(e^x - 1)^2}$	$\frac{x}{e^x - 1}$	$\ln(1 - e^{-x})$	$\frac{x}{e^x - 1} - \ln(1 - e^{-x})$
0.00	1.00000	1.00000	$-\infty$	∞
0.05	0.99979	0.97521	-3.02063	3.99584
0.10	0.99917	0.95083	-2.35217	3.30300
0.15	0.99813	0.92687	-1.97118	2.89806
0.20	0.99667	0.90333	-1.70777	2.61110
0.25	0.99481	0.88020	-1.50869	2.38888
0.30	0.99253	0.85749	-1.35023	2.20771
0.35	0.98985	0.83519	-1.21972	2.05491
0.40	0.98677	0.81330	-1.10963	1.92293
0.45	0.98329	0.79182	-1.01508	1.80690
0.50	0.97942	0.77075	-0.93275	1.70350
0.55	0.97517	0.75008	-0.86026	1.61035
0.60	0.97053	0.72982	-0.79587	1.52569
0.65	0.96552	0.70996	-0.73824	1.44820
0.70	0.96015	0.69050	-0.68634	1.37684
0.75	0.95441	0.67144	-0.63935	1.31079
0.80	0.94833	0.65277	-0.59662	1.24939
0.85	0.94191	0.63450	-0.55759	1.19209
0.90	0.93515	0.61661	-0.52184	1.13844
0.95	0.92807	0.59910	-0.48897	1.08809
1.00	0.92067	0.58198	-0.45868	1.04065
1.05	0.91298	0.56523	-0.43069	0.99592
1.10	0.90499	0.54886	-0.40477	0.95363
1.15	0.89671	0.53285	-0.38073	0.91358
1.20	0.88817	0.51722	-0.35838	0.87560
1.25	0.87937	0.50194	-0.33758	0.83952
1.30	0.87031	0.48702	-0.31818	0.80520
1.35	0.86102	0.47245	-0.30008	0.77253
1.40	0.85151	0.45824	-0.28315	0.74139
1.45	0.84178	0.44436	-0.26732	0.71168
1.50	0.83185	0.43083	-0.25248	0.68331

$$\left[\begin{matrix} (-5)5 \\ 3 \end{matrix} \right] \quad \left[\begin{matrix} (-5)5 \\ 3 \end{matrix} \right]$$

Table 27.3

Einstein Functions

x	$\frac{x^2 e^x}{(e^x - 1)^2}$	$\frac{x}{e^x - 1}$	$\ln(1 - e^{-x})$	$\frac{x}{e^x - 1} - \ln(1 - e^{-x})$
1.6	0.81143	0.40475	-0.22552	0.63027
1.7	0.79035	0.37998	-0.20173	0.58171
1.8	0.76869	0.35646	-0.18068	0.53714
1.9	0.74657	0.33416	-0.16201	0.49617
2.0	0.72406	0.31304	-0.14541	0.45845
2.1	0.70127	0.29304	-0.13063	0.42367
2.2	0.67827	0.27414	-0.11744	0.39158
2.3	0.65515	0.25629	-0.10565	0.36194
2.4	0.63200	0.23945	-0.09510	0.33455
2.5	0.60889	0.22356	-0.08565	0.30921
2.6	0.58589	0.20861	-0.07718	0.28578
2.7	0.56307	0.19453	-0.06957	0.26410
2.8	0.54049	0.18129	-0.06274	0.24403
2.9	0.51820	0.16886	-0.05659	0.22545
3.0	0.49627	0.15719	-0.05107	0.20826
3.2	0.45363	0.13598	-0.04162	0.17760
3.4	0.41289	0.11739	-0.03394	0.15133
3.6	0.37429	0.10113	-0.02770	0.12883
3.8	0.33799	0.08695	-0.02262	0.10958
4.0	0.30409	0.07463	-0.01849	0.09311
4.2	0.27264	0.06394	-0.01511	0.07905
4.4	0.24363	0.05469	-0.01235	0.06705
4.6	0.21704	0.04671	-0.01010	0.05681
4.8	0.19277	0.03983	-0.00826	0.04809
5.0	0.17074	0.03392	-0.00676	0.04068
5.2	0.15083	0.02885	-0.00553	0.03438
5.4	0.13290	0.02450	-0.00453	0.02903
5.6	0.11683	0.02078	-0.00370	0.02449
5.8	0.10247	0.01761	-0.00303	0.02065
6.0	0.08968	0.01491	-0.00248	0.01739

$\left[\begin{matrix} (-4) \\ 4 \end{matrix} \right] \quad \left[\begin{matrix} (-4) \\ 4 \end{matrix} \right] \quad \left[\begin{matrix} (-4) \\ 4 \end{matrix} \right] \quad \left[\begin{matrix} (-4) \\ 4 \end{matrix} \right]$

[27.4] H. L. Johnston, L. Savedoff and J. Belzer, Contributions to the thermodynamic functions by a Planck-Einstein oscillator in one degree of freedom, NAVEXOS p. 646, Office of Naval Research, Department of the Navy, Washington, D.C. (1949). Values of $x^2 e^x (e^x - 1)^{-2}$, $x(e^x - 1)^{-1}$, $-\ln(1 - e^{-x})$ and $x(e^x - 1)^{-1} - \ln(1 - e^{-x})$ for $x = 0(.001)3(.01) 14.99$, 5D with first differences.

27.4. Sievert Integral

$$\int_0^\theta e^{-x \sec \phi} d\phi$$

Relation to the Error Function

27.4.1

$$\int_0^\theta e^{-x \sec \phi} d\phi \sim \sqrt{\frac{\pi}{2x}} e^{-x} \operatorname{erf}\left(\sqrt{\frac{x}{2}} \theta\right) \quad (x \rightarrow \infty)$$

(For erf, see chapter 7.)

Representation in Terms of Exponential Integrals

27.4.2

$$\int_0^\theta e^{-x \sec \phi} d\phi = \int_0^{\frac{\pi}{2}} e^{-x \sec \phi} d\phi - \sum_{k=0}^\infty \alpha_k (\cos \theta)^{2k+1} E_{2k+2}\left(\frac{x}{\cos \theta}\right)$$

$(x \geq 0, 0 < \theta < \frac{\pi}{2})$

$$\alpha_0 = 1, \alpha_k = \frac{1 \cdot 3 \cdot 5 \dots (2k-1)}{2 \cdot 4 \cdot 6 \dots (2k)}$$

(For $E_{2k+2}(x)$, see chapter 5.)

Relation to the Integral of the Bessel Function $K_0(x)$

27.4.3

$$\int_0^{\frac{\pi}{2}} e^{-x \sec \phi} d\phi = \operatorname{Ki}_1(x) = \int_x^\infty K_0(t) dt \text{ where}$$

$$x^\dagger e^x \operatorname{Ki}_1(x) \sim \left(\frac{1}{2}\pi\right)^\dagger \left\{ 1 - \frac{5}{8x} + \frac{129}{128x^2} - \frac{2655}{1024x^3} + \frac{301035}{32768x^4} - \dots \right\}$$

(For $\operatorname{Ki}_1(x)$, see chapter 11.)

[27.5] National Bureau of Standards, Table of the Sievert integral, Applied Math. Series— (U.S. Government Printing Office, Washington, D.C. In press).

[27.6] R. M. Sievert, Die v-Strahlungsintensität an der Oberfläche und in der nächsten Umgebung von Radiumnadeln, Acta Radiologica II, 239-301 (1930).

$$x=0(.01)2(.02)5(.05)10, \theta=0^\circ(1^\circ)90^\circ, 9D.$$

$$\int_0^{\theta} e^{-x \sin \phi} d\phi, \phi=30^\circ(1^\circ)90^\circ, A=0(.01).5, 3D.$$

Sievert Integral $\int_0^{\theta} e^{-x \sin \phi} d\phi$

Table 27.4

$x \setminus \theta$	10°	20°	30°	40°	50°	60°	75°	90°
0.0	0.174533	0.349066	0.523599	0.698132	0.872665	1.047198	1.308997	1.570796
0.1	0.157843	0.315187	0.471456	0.625886	0.777323	0.923778	1.123611	1.228632
0.2	0.142749	0.284598	0.424515	0.561159	0.692565	0.815477	0.968414	1.023680
0.3	0.129099	0.256978	0.382255	0.503165	0.617194	0.720366	0.837712	0.868832
0.4	0.116754	0.232040	0.344209	0.451198	0.550154	0.636769	0.727031	0.745203
0.5	0.105589	0.209522	0.309957	0.404629	0.490508	0.563236	0.632830	0.643694
0.6	0.095492	0.189191	0.279118	0.362893	0.437428	0.498504	0.552287	0.558890
0.7	0.086361	0.170833	0.251353	0.325486	0.390178	0.441478	0.483134	0.487198
0.8	0.078103	0.154256	0.226354	0.291957	0.348109	0.391204	0.423535	0.426062
0.9	0.070634	0.139289	0.203845	0.261901	0.310642	0.346851	0.371996	0.373579
1.0	0.063880	0.125775	0.183579	0.234956	0.277267	0.307694	0.327288	0.328286
1.2	0.052247	0.102553	0.148899	0.189138	0.221027	0.242523	0.254485	0.254889
1.4	0.042733	0.083620	0.120780	0.152298	0.176336	0.191533	0.198885	0.199051
1.6	0.034951	0.068183	0.097979	0.122667	0.140792	0.151541	0.156087	0.156156
1.8	0.028587	0.055597	0.079488	0.098829	0.112497	0.120105	0.122932	0.122961
2.0	0.023381	0.045335	0.064492	0.079644	0.089954	0.095342	0.097108	0.097121
2.2	0.019123	0.036967	0.052329	0.064201	0.071979	0.075797	0.076905	0.076911
2.4	0.015641	0.030145	0.042463	0.051766	0.057635	0.060342	0.061040	0.061043
2.6	0.012793	0.024582	0.034460	0.041170	0.046179	0.048100	0.048541	0.048542
2.8	0.010463	0.020045	0.027968	0.033680	0.037024	0.038387	0.038667	0.038668
3.0	0.008558	0.016347	0.022700	0.027177	0.029702	0.030670	0.030848	0.030848
3.5	0.005178	0.009817	0.013477	0.015912	0.017164	0.017576	0.017634	0.017634
4.0	0.003132	0.005896	0.008005	0.009330	0.009951	0.010128	0.010147	0.010147
4.5	0.001895	0.003542	0.004756	0.005478	0.005787	0.005862	0.005869	0.005869
5.0	0.001147	0.002127	0.002828	0.003221	0.003374	0.003407	0.003409	0.003409
5.5	0.000694	0.001278	0.001682	0.001896	0.001972	0.001986	0.001987	0.001987
6.0	0.000420	0.000768	0.001001	0.001117	0.001155	0.001162	0.001162	0.001162
6.5	0.000254	0.000461	0.000596	0.000659	0.000678	0.000681	0.000681	0.000681
7.0	0.000154	0.000277	0.000355	0.000389	0.000399	0.000400	0.000400	0.000400
7.5	0.000093	0.000167	0.000211	0.000230	0.000235	0.000235	0.000235	0.000235
8.0	0.000056	0.000100	0.000126	0.000136	0.000139	0.000139	0.000139	0.000139
8.5	0.000034	0.000060	0.000075	0.000081	0.000082	0.000082	0.000082	0.000082
9.0	0.000021	0.000036	0.000045	0.000048	0.000048	0.000048	0.000048	0.000048
9.5	0.000012	0.000022	0.000027	0.000028	0.000029	0.000029	0.000029	0.000029
10.0	0.000008	0.000013	0.000016	0.000017	0.000017	0.000017	0.000017	0.000017

$$\left[\begin{matrix} (-3)2 \\ 6 \end{matrix} \right] \quad \left[\begin{matrix} (-4)5 \\ 6 \end{matrix} \right] \quad \left[\begin{matrix} (-4)8 \\ 6 \end{matrix} \right] \quad \left[\begin{matrix} (-3)1 \\ 7 \end{matrix} \right] \quad \left[\begin{matrix} (-3)1 \\ 7 \end{matrix} \right] \quad \left[\begin{matrix} (-3)2 \\ 7 \end{matrix} \right] \quad \left[\begin{matrix} (-3)4 \\ 7 \end{matrix} \right] \quad \left[\begin{matrix} (-2)2 \\ 11 \end{matrix} \right]$$

27.5. $f_m(x) = \int_0^{\infty} t^m e^{-t^2 - \frac{x}{t}} dt$ and

Related Integrals

$$m=0, 1, 2 \dots$$

Differential Equations

27.5.1 $xf_m''' - (m-1)f_m'' + 2f_m = 0$

27.5.2 $f_m' = -f_{m-1} \quad (m=1, 2, \dots)$

Recurrence Relation

27.5.3 $2f_m = (m-1)f_{m-2} + xf_{m-3} \quad (m \geq 3)$

Power Series Representations

27.5.4 $2f_1(x) = \sum_{k=0}^{\infty} (a_k \ln x + b_k) x^k$

$$a_k = \frac{-2a_{k-2}}{k(k-1)(k-2)} \quad b_k = \frac{-2b_{k-2} - (3k^2 - 6k + 2)a_k}{k(k-1)(k-2)}$$

$$a_0 = a_1 = 0 \quad a_2 = -b_0$$

$$b_0 = 1 \quad b_1 = -\sqrt{\pi} \quad b_2 = \frac{3}{2}(1-\gamma)$$

(For γ , see chapter 6.)

27.5.5

$$2f_1(x) = 1 - \sqrt{\pi}x + .6342x^2 + .5908x^3 - .1431x^4 - .01968x^5 + .00324x^6 + .000188x^7 \dots - x^2 \ln x(1 - .08333x^2 + .001389x^4 - .0000083x^6 + \dots)$$

27.5.6

$$2f_2(x) = \frac{\sqrt{\pi}}{2} - x + \frac{\sqrt{\pi}}{2}x^2 - .3225x^3 - .1477x^4 + .03195x^5 + .00328x^6 - .000491x^7 - .0000235x^8 \dots + x^3 \ln x(\frac{1}{3} - .01667x^2 + .000198x^4 - \dots)$$

27.5.7

$$2f_3(x) = 1 - \frac{\sqrt{\pi}}{2}x + \frac{x^2}{2} - .2954x^3 + .1014x^4 + .02954x^5 - .00578x^6 - .00047x^7 + .000064x^8 \dots - x^4 \ln x(.0833 - .00278x^2 + .000025x^4 - \dots)$$

Asymptotic Representation

27.5.8

$$f_m(x) \sim \sqrt{\frac{\pi}{3}} 3^{-\frac{m}{2}} v^{\frac{m}{2}} e^{-v} \left(a_0 + \frac{a_1}{v} + \frac{a_2}{v^2} + \dots + \frac{a_k}{v^k} + \dots \right) \quad (x \rightarrow \infty)$$

$$v = 3 \left(\frac{x}{2} \right)^{2/3}$$

$$a_0 = 1, a_1 = \frac{1}{12} (3m^2 + 3m - 1)$$

$$12(k+2)a_{k+2} = -(12k^2 + 36k - 3m^2 - 3m + 25)a_{k+1} + \frac{1}{2}(m-2k)(2k+3-m)(2k+3+2m)a_k \quad (k=0, 1, 2 \dots)$$

27.5.9 $g_1(x) + ig_2(x) = \int_0^\infty t^3 e^{-t^2 + it^{\frac{2}{3}}} dt$

27.5.10

$$g_1(x) = \mathcal{H}f_3(ix) \quad g_2(x) = -\mathcal{H}f_3(ix)$$

Asymptotic Representation

27.5.11

$$g_1(x) = \left(\frac{\pi}{3} \right)^{1/2} \frac{x}{2} \exp \left[-\frac{3}{2} \left(\frac{x}{2} \right)^{2/3} \right] (A \sin \theta + B \cos \theta)$$

27.5.12

$$g_2(x) = -\left(\frac{\pi}{3} \right)^{1/2} \frac{x}{2} \exp \left[-\frac{3}{2} \left(\frac{x}{2} \right)^{2/3} \right] (A \cos \theta - B \sin \theta)$$

$$\theta = \frac{3}{2} \sqrt{3} \left(\frac{x}{2} \right)^{2/3}$$

$$A \sim a_0 - a_3 \left(\frac{2}{x} \right)^2 + \frac{1}{2} \left[a_1 \left(\frac{2}{x} \right)^{2/3} - a_2 \left(\frac{2}{x} \right)^{4/3} - a_4 \left(\frac{2}{x} \right)^{8/3} + a_5 \left(\frac{2}{x} \right)^{10/3} - \dots \right] \quad (x \rightarrow \infty)$$

$$B \sim \frac{\sqrt{3}}{2} \left[a_1 \left(\frac{2}{x} \right)^{2/3} + a_2 \left(\frac{2}{x} \right)^{4/3} - a_4 \left(\frac{2}{x} \right)^{8/3} - a_5 \left(\frac{2}{x} \right)^{10/3} + \dots \right] \quad (x \rightarrow \infty)$$

$$a_0 = 1 \quad a_1 = .972222 \quad a_2 = .148534$$

$$a_3 = -.017879 \quad a_4 = .004594 \quad a_5 = -.000762$$

[27.7] M. Abramowitz, Evaluation of the integral $\int_0^\infty e^{-u^2 - x/u} du$, J. Math. Phys. **32**, 188-192 (1953).

[27.8] H. Faxén, Expansion in series of the integral $\int_y^\infty \exp[-x(t \pm t^{-n})] t^2 dt$, Ark. Mat., Astr., Fys. **15**, 13, 1-57 (1921).

[27.9] J. E. Kilpatrick and M. F. Kilpatrick, Discrete energy levels associated with the Lennard-Jones potential, J. Chem. Phys. **19**, 7, 930-933 (1951).

[27.10] U. E. Kruse and N. F. Ramsey, The integral $\int_0^\infty y^3 \exp(-y^2 + i \frac{x}{y}) dy$, J. Math. Phys. **30**, 40 (1951).

[27.11] O. Laporte, Absorption coefficients for thermal neutrons, Phys. Rev. **52**, 72-74 (1937).

[27.12] H. C. Torrey, Notes on intensities of radio frequency spectra, Phys. Rev. **59**, 293 (1941).

[27.13] C. T. Zahn, Absorption coefficients for thermal neutrons, Phys. Rev. **52**, 67-71 (1937).

$$\int_0^\infty y^n e^{-y-x/\sqrt{y}} dy \text{ for } n=0, \frac{1}{2}, 1; x=0(.01).1(.1)1.$$

$$f_m(x) = \int_0^\infty t^m e^{-t^2 - \frac{x}{t}} dt$$

Table 27.5

x	$f_1(x)$	$f_2(x)$	$f_3(x)$	x	$f_1(x)$	$f_2(x)$	$f_3(x)$	x	$f_1(x)$	$f_2(x)$	$f_3(x)$
0.00	0.5000	0.4431	0.5000	0.1	0.4263	0.3970	0.4580	0.6	0.2255	0.2415	0.3025
0.01	0.4914	0.4382	0.4956	0.2	0.3697	0.3573	0.4204	0.7	0.2015	0.2202	0.2793
0.02	0.4832	0.4333	0.4912	0.3	0.3238	0.3227	0.3864	0.8	0.1807	0.2011	0.2584
0.03	0.4753	0.4285	0.4869	0.4	0.2855	0.2923	0.3557	0.9	0.1626	0.1839	0.2392
0.04	0.4676	0.4238	0.4826	0.5	0.2531	0.2654	0.3278	1.0	0.1466	0.1685	0.2215
0.05	0.4602	0.4191	0.4784								

$$\left[\begin{matrix} (-5)5 \\ 2 \end{matrix} \right] \left[\begin{matrix} (-5)5 \\ 2 \end{matrix} \right] \left[\begin{matrix} (-5)5 \\ 2 \end{matrix} \right] \quad \left[\begin{matrix} (-3)1 \\ 4 \end{matrix} \right] \left[\begin{matrix} (-4)7 \\ 3 \end{matrix} \right] \left[\begin{matrix} (-4)5 \\ 3 \end{matrix} \right] \quad \left[\begin{matrix} (-4)6 \\ 3 \end{matrix} \right] \left[\begin{matrix} (-4)4 \\ 3 \end{matrix} \right] \left[\begin{matrix} (-4)4 \\ 3 \end{matrix} \right]$$

x	$\mathcal{R}f_3(ix)$	$-\mathcal{I}f_3(ix)$	x	$\mathcal{R}f_3(ix)$	$-\mathcal{I}f_3(ix)$	x	$\mathcal{R}f_3(ix)$	$-\mathcal{I}f_3(ix)$
0.0	0.50000	0.00000	4.0	-0.2626	0.0430	8.0	0.06078	-0.09808
0.2	0.49019	0.08754	4.2	-0.2552	+0.0094	8.5	0.07562	-0.07131
0.4	0.46229	0.16933	4.4	-0.2441	-0.0214	9.0	0.08221	-0.04496
0.6	0.41950	0.24139	4.6	-0.2299	-0.0490	9.5	0.08191	-0.02082
0.8	0.36543	0.30136	4.8	-0.2132	-0.0734	10.0	0.07626	-0.00010
1.0	0.30366	0.34805	5.0	-0.1945	-0.0944	10.5	0.06684	+0.01654
1.2	0.23746	0.38122	5.2	-0.1745	-0.1120	11.0	0.05507	0.02889
1.4	0.16972	0.40127	5.4	-0.1536	-0.1263	11.5	0.04224	0.03707
1.6	0.10288	0.40910	5.6	-0.1322	-0.1374	12.0	0.02937	0.04146
1.8	+0.03892	0.40592	5.8	-0.1108	-0.1455	12.5	0.01727	0.04259
2.0	-0.02062	0.39314	6.0	-0.0896	-0.1507	13.0	+0.00650	0.04109
2.2	-0.0746	0.3722	6.2	-0.0691	-0.1533	13.5	-0.00259	0.03758
2.4	-0.1221	0.3448	6.4	-0.0493	-0.1535	14.0	-0.00982	0.03268
2.6	-0.1629	0.3122	6.6	-0.0307	-0.1515	14.5	-0.01517	0.02696
2.8	-0.1966	0.2759	6.8	-0.0132	-0.1476	15.0	-0.01872	0.02089
3.0	-0.2233	0.2371	7.0	+0.00286	-0.14211	16.0	-0.02118	+0.00921
3.2	-0.2432	0.1971	7.2	0.01749	-0.13518	17.0	-0.01906	-0.00022
3.4	-0.2565	0.1569	7.4	0.03061	-0.12709	18.0	-0.01435	-0.00650
3.6	-0.2639	0.1173	7.6	0.04220	-0.11805	19.0	-0.00879	-0.00965
3.8	-0.2657	0.0792	7.8	0.05224	-0.10830	20.0	-0.00360	-0.01021

$$\left[\begin{matrix} (-3)2 \\ 6 \end{matrix} \right] \left[\begin{matrix} (-3)2 \\ 5 \end{matrix} \right] \quad \left[\begin{matrix} (-4)5 \\ 3 \end{matrix} \right] \left[\begin{matrix} (-4)4 \\ 4 \end{matrix} \right] \quad \left[\begin{matrix} (-3)1 \\ 5 \end{matrix} \right] \left[\begin{matrix} (-4)7 \\ 5 \end{matrix} \right]$$

Compiled from U. E. Kruse and N. F. Ramsey, The integral $\int_0^\infty y^3 \exp\left(-y^2 + \frac{x}{y}\right) dy$, J. Math. Phys. 30, 40 (1951) (with permission).

27.6. $f(x) = \int_0^\infty \frac{e^{-t^2}}{t+x} dt$

Power Series Representation

27.6.1

$$f(x) = -e^{-x^2} \ln x + e^{-x^2} \left[\sqrt{\pi} \sum_{k=0}^\infty \frac{x^{2k+1}}{k!(2k+1)} - \sum_{k=1}^\infty \frac{x^{2k}}{k! 2k} \frac{\gamma}{2} \right]$$

27.6.2

$$= -e^{-x^2} \ln x + \frac{1}{2} \sum_{k=0}^\infty \frac{(-1)^k \psi(k+1) x^{2k}}{k!} + \sqrt{\pi} \sum_{k=0}^\infty \frac{(-2)^k x^{2k+1}}{1 \cdot 3 \cdot 5 \dots (2k+1)}$$

(For γ and the digamma function $\psi(x)$, see chapter 6.)

Relation to the Exponential Integral

27.6.3 $f(x) = -\frac{1}{2} e^{-x^2} \text{Ei}(x^2) + \sqrt{\pi} e^{-x^2} \int_0^x e^{t^2} dt$

(For $\text{Ei}(x)$ see chapter 5; $e^{-x^2} \int_0^x e^{t^2} dt$, see chapter 7.

Asymptotic Representation

27.6.4

$$f(x) \sim \frac{\sqrt{\pi}}{2} \left[\frac{1}{x} + \frac{1}{2x^3} + \frac{1 \cdot 3}{4x^5} + \frac{1 \cdot 3 \cdot 5}{8x^7} + \dots \right] - \frac{1}{2} \left[\frac{1}{x^2} + \frac{1}{x^4} + \frac{2!}{x^6} + \frac{3!}{x^8} + \dots \right] \quad (x \rightarrow \infty)$$

[27.14] A. Erdélyi, Note on the paper "On a definite integral" by R. H. Ritchie, Math. Tables Aids Comp. 4, 31, 179 (1950).

[27.15] E. T. Goodwin and J. Staton, Table of $\int_0^\infty \frac{e^{-u^2}}{u+x} du$, Quart. J. Mech. Appl. Math. 1, 319 (1948). $x=0(.02)2(.05)3(.1)10$. Auxiliary function for $x=0(.01)1$.

[27.16] R. H. Ritchie, On a definite integral, Math. Tables Aids Comp. 4, 30, 75 (1950).

Table 27.6

$$f(x) = \int_0^\infty \frac{e^{-t^2}}{t+x} dt$$

x	$f(x) + \ln x$	x	$f(x) + \ln x$	x	$f(x)$	x	$f(x)$	x	$f(x)$
0.00	-0.2886	0.50	0.2704	1.0	0.6051	2.0	0.3543	3.0	0.2519
0.05	-0.2081	0.55	0.3100	1.1	0.5644	2.1	0.3404	3.5	0.2203
0.10	-0.1375	0.60	0.3479	1.2	0.5291	2.2	0.3276	4.0	0.1958
0.15	-0.0735	0.65	0.3842	1.3	0.4980	2.3	0.3157	4.5	0.1762
0.20	-0.0146	0.70	0.4192	1.4	0.4705	2.4	0.3046	5.0	0.1602
0.25	+0.0402	0.75	0.4529	1.5	0.4460	2.5	0.2944	5.5	0.1468
0.30	0.0915	0.80	0.4854	1.6	0.4239	2.6	0.2848	6.0	0.1356
0.35	0.1398	0.85	0.5168	1.7	0.4040	2.7	0.2758	6.5	0.1259
0.40	0.1856	0.90	0.5472	1.8	0.3860	2.8	0.2673	7.0	0.1175
0.45	0.2290	0.95	0.5766	1.9	0.3695	2.9	0.2594	7.5	0.1102
0.50	0.2704	1.00	0.6051	2.0	0.3543	3.0	0.2519	8.0	0.1037

$\left[\begin{matrix} (-3)1 \\ 4 \end{matrix} \right]$ $\left[\begin{matrix} (-4)2 \\ 3 \end{matrix} \right]$ $\left[\begin{matrix} (-4)7 \\ 4 \end{matrix} \right]$ $\left[\begin{matrix} (-4)1 \\ 3 \end{matrix} \right]$ $\left[\begin{matrix} (-4)9 \\ 4 \end{matrix} \right]$

Compiled from E. T. Goodwin and J. Staton, Table of $\int_0^\infty \frac{e^{-u^2}}{u+x} du$, Quart. J. Mech. Appl. Math. 1, 319 (1948) (with permission).

27.7. Dilogarithm

(Spence's Integral for $n=2$)

27.7.1
$$f(x) = -\int_1^x \frac{\ln t}{t-1} dt$$

Series Expansion

27.7.2
$$f(x) = \sum_{k=1}^\infty (-1)^k \frac{(x-1)^k}{k^2} \quad (2 \geq x \geq 0)$$

Functional Relationships

27.7.3
$$f(x) + f(1-x) = -\ln x \ln(1-x) + \frac{\pi^2}{6} \quad (1 \geq x \geq 0)$$

27.7.4
$$f(1-x) + f(1+x) = \frac{1}{2} f(1-x^2) \quad (1 \geq x > 0)$$

27.7.5
$$f(x) + f\left(\frac{1}{x}\right) = -\frac{1}{2} (\ln x)^2 \quad (0 \leq x \leq 1)$$

27.7.6
$$f(x+1) - f(x) = -\ln x \ln(x+1) - \frac{\pi^2}{12} - \frac{1}{2} f(x^2) \quad (2 \geq x \geq 0)$$

Relation to Debye Functions

27.7.7
$$f(e^{-t}) = -f(e^t) - \frac{t^2}{2} = \int_0^t \frac{tdt}{e^t - 1}$$

[27.17] L. Lewin, Dilogarithms and associated functions (Macdonald, London, England, 1958).

[27.18] K. Mitchell, Tables of the function $\int_0^z \frac{-\log|1-y|}{y} dy$, with an account of some properties of this and related functions, Phil. Mag. 40, 351-368 (1949). $x = -1(.01)1; x = 0(.001).5, 9D$.

[27.19] E. O. Powell, An integral related to the radiation integrals, Phil. Mag. 7, 34, 600-607 (1943). $\int_1^x \frac{\log y}{y-1} dy, x = 0(.01)2(.02)6, 7D$.

[27.20] A. van Wijngaarden, Polylogarithms, by the Staff of the Computation Department, Report R24, Mathematisch Centrum, Amsterdam, Holland (1954). $F_n(z) = \sum_{h=1}^\infty h^{-n} z^h$ for $z = x = -1(.01)1; z = ix$, for $x = 0(.01)1; z = e^{i\pi\alpha/2}$ for $\alpha = 0(.01)2, 10D$.

Dilogarithm

Table 27.7

$$f(x) = -\int_1^x \frac{\ln t}{t-1} dt$$

<i>x</i>	<i>f(x)</i>	<i>x</i>	<i>f(x)</i>	<i>x</i>	<i>f(x)</i>	<i>x</i>	<i>f(x)</i>	<i>x</i>	<i>f(x)</i>
0.00	1.64493 4067	0.10	1.29971 4723	0.20	1.07479 4600	0.30	0.88937 7624	0.40	0.72758 6308
0.01	1.58862 5448	0.11	1.27452 9160	0.21	1.05485 9830	0.31	0.87229 1733	0.41	0.71239 5042
0.02	1.54579 9712	0.12	1.25008 7584	0.22	1.03527 7934	0.32	0.85542 7404	0.42	0.69736 1058
0.03	1.50789 9041	0.13	1.22632 0101	0.23	1.01603 0062	0.33	0.83877 6261	0.43	0.68247 9725
0.04	1.47312 5860	0.14	1.20316 7961	0.24	0.99709 9088	0.34	0.82233 0471	0.44	0.66774 6644
0.05	1.44063 3797	0.15	1.18058 1124	0.25	0.97846 9393	0.35	0.80608 2689	0.45	0.65315 7631
0.06	1.40992 8300	0.16	1.15851 6487	0.26	0.96012 6675	0.36	0.79002 6024	0.46	0.63870 8705
0.07	1.38068 5041	0.17	1.13693 6560	0.27	0.94205 7798	0.37	0.77415 3992	0.47	0.62439 6071
0.08	1.35267 5161	0.18	1.11580 8451	0.28	0.92425 0654	0.38	0.75846 0483	0.48	0.61021 6108
0.09	1.32572 8728	0.19	1.09510 3088	0.29	0.90669 4053	0.39	0.74293 9737	0.49	0.59616 5361
0.10	1.29971 4723	0.20	1.07479 4600	0.30	0.88937 7624	0.40	0.72758 6308	0.50	0.58224 0526

$$\left[\begin{matrix} (-3) \\ 2 \end{matrix} \right]$$

$$\left[\begin{matrix} (-4) \\ 1 \end{matrix} \right]$$

$$\left[\begin{matrix} (-5) \\ 7 \end{matrix} \right]$$

$$\left[\begin{matrix} (-5) \\ 6 \end{matrix} \right]$$

$$\left[\begin{matrix} (-5) \\ 5 \end{matrix} \right]$$

From K. Mitchell, Tables of the function $\int_0^{z-\log|1-y|} \frac{dy}{y}$, with an account of some properties of this and related functions, Phil. Mag. 40, 351-368 (1949) (with permission).

27.8. Clausen's Integral and Related Summations

27.8.1

$$f(\theta) = -\int_0^\theta \ln \left(2 \sin \frac{t}{2} \right) dt = \sum_{k=1}^{\infty} \frac{\sin k\theta}{k^2} \quad (0 \leq \theta \leq \pi)$$

Series Representation

27.8.2

$$f(\theta) = -\theta \ln |\theta| + \theta + \sum_{k=1}^{\infty} \frac{(-1)^{k-1}}{(2k)!} B_{2k} \frac{\theta^{2k+1}}{2k(2k+1)} \quad \left(0 \leq \theta < \frac{\pi}{2} \right)$$

27.8.3

$$f(\pi - \theta) = \theta \ln 2 - \sum_{k=1}^{\infty} \frac{(-1)^{k-1}}{(2k)!} B_{2k} (2^{2k} - 1) \frac{\theta^{2k+1}}{2k(2k+1)} \quad (\pi/2 < \theta < \pi)$$

Functional Relationship

27.8.4 $f(\pi - \theta) = f(\theta) - \frac{1}{2} f(2\theta) \quad \left(0 \leq \theta \leq \frac{\pi}{2} \right)$

Relation to Spence's Integral

27.8.5

$$if(\theta) = g(e^{i\theta}) + \frac{\theta^2}{4} \text{ where } g(x) = \int_1^x \frac{dt}{t} \ln|1+t|$$

Summable Series

27.8.6

$$\sum_{n=1}^{\infty} \frac{\cos n\theta}{n} = -\ln \left(2 \sin \frac{\theta}{2} \right) \quad (0 < \theta < 2\pi)$$

$$\sum_{n=1}^{\infty} \frac{\cos n\theta}{n^2} = \frac{\pi^2}{6} - \frac{\pi\theta}{2} + \frac{\theta^2}{4} \quad (0 \leq \theta \leq 2\pi)$$

$$\sum_{n=1}^{\infty} \frac{\cos n\theta}{n^4} = \frac{\pi^4}{90} - \frac{\pi^2\theta^2}{12} + \frac{\pi\theta^3}{12} - \frac{\theta^4}{48} \quad (0 \leq \theta \leq 2\pi)$$

$$\sum_{n=1}^{\infty} \frac{\sin n\theta}{n} = \frac{1}{2} (\pi - \theta) \quad (0 < \theta < 2\pi)$$

$$\sum_{n=1}^{\infty} \frac{\sin n\theta}{n^3} = \frac{\pi^2\theta}{6} - \frac{\pi\theta^2}{4} + \frac{\theta^3}{12} \quad (0 \leq \theta \leq 2\pi)$$

$$\sum_{n=1}^{\infty} \frac{\sin n\theta}{n^5} = \frac{\pi^4\theta}{90} - \frac{\pi^2\theta^3}{36} + \frac{\pi\theta^4}{48} - \frac{\theta^5}{240} \quad (0 \leq \theta \leq 2\pi)$$

[27.21] A. Ashour and A. Sabri, Tabulation of the function

$$\psi(\theta) = \sum_{n=1}^{\infty} \frac{\sin n\theta}{n^2}, \text{ Math. Tables Aids Comp. 10, 54, 57-65 (1956).}$$

[27.22] T. Clausen, Über die Zerlegung reeller gebrochener Funktionen, J. Reine Angew. Math. 8, 298-300 (1832). $x=0^\circ(1^\circ)180^\circ$, 16D.

[27.23] L. B. W. Jolley, Summation of series (Chapman Publishing Co., London, England, 1925).

[27.24] A. D. Wheelon, A short table of summable series, Report No. SM-14642, Douglas Aircraft Co., Inc., Santa Monica, Calif. (1953).

Table 27.8

Clausen's Integral

$$f(\theta) = -\int_0^\theta \ln \left(2 \sin \frac{t}{2} \right) dt$$

θ°	$f(\theta) + \theta \ln \theta$	θ°	$f(\theta)$	θ°	$f(\theta)$	θ°	$f(\theta)$	θ°	$f(\theta)$
0	0.000000	15	0.612906	30	0.864379	60	1.014942	90	0.915966
1	0.017453	16	0.635781	32	0.886253	62	1.014421	95	0.883872
2	0.034908	17	0.657571	34	0.906001	64	1.012886	100	0.848287
3	0.052362	18	0.678341	36	0.923755	66	1.010376	105	0.809505
4	0.069818	19	0.698149	38	0.939633	68	1.006928	110	0.767800
5	0.087276	20	0.717047	40	0.953741	70	1.002576	115	0.723427
6	0.104735	21	0.735080	42	0.966174	72	0.997355	120	0.676628
7	0.122199	22	0.752292	44	0.977020	74	0.991294	125	0.627629
8	0.139664	23	0.768719	46	0.986357	76	0.984425	130	0.576647
9	0.157133	24	0.784398	48	0.994258	78	0.976776	135	0.523889
10	0.174607	25	0.799360	50	1.000791	80	0.968375	140	0.469554
11	0.192084	26	0.813635	52	1.006016	82	0.959247	145	0.413831
12	0.209567	27	0.827249	54	1.009992	84	0.949419	150	0.356908
13	0.227055	28	0.840230	56	1.012773	86	0.938914	160	0.240176
14	0.244549	29	0.852599	58	1.014407	88	0.927755	170	0.120755
15	0.262049	30	0.864379	60	1.014942	90	0.915966	180	0.000000

$$\left[\begin{matrix} (-7)8 \\ 3 \end{matrix} \right]$$

$$\left[\begin{matrix} (-4)1 \\ 4 \end{matrix} \right]$$

$$\left[\begin{matrix} (-4)3 \\ 4 \end{matrix} \right]$$

$$\left[\begin{matrix} (-4)1 \\ 4 \end{matrix} \right]$$

$$\left[\begin{matrix} (-4)4 \\ 6 \end{matrix} \right]$$

Compiled from A. Ashour and A. Sabri, Tabulation of the function $\psi(\theta) = \sum_{n=1}^{\infty} \frac{\sin n\theta}{n^2}$, Math. Tables Aids Comp. 10, 54, 57-65 (1956) (with permission).

27.9. Vector-Addition Coefficients

(Wigner coefficients or Clebsch-Gordan coefficients)

Definition

27.9.1

$$(j_1 j_2 m_1 m_2 | j_1 j_2 j m) = \delta(m, m_1 + m_2) \cdot \sqrt{\frac{(j_1 + j_2 - j)!(j + j_1 - j_2)!(j + j_2 - j_1)!(2j + 1)}{(j + j_1 + j_2 + 1)!}}$$

$$\cdot \sum_k \frac{(-1)^k \sqrt{(j_1 + m_1)!(j_1 - m_1)!(j_2 + m_2)!(j_2 - m_2)!(j + m)!(j - m)!}}{k!(j_1 + j_2 - j - k)!(j_1 - m_1 - k)!(j_2 + m_2 - k)!(j - j_2 + m_1 + k)!(j - j_1 - m_2 + k)!}$$

$$\delta(i, k) = \begin{cases} 1, & i = k \\ 0, & i \neq k \end{cases}$$

Conditions

27.9.2 $j_1, j_2, j = +n$ or $+\frac{n}{2}$ ($n = \text{integer}$)

27.9.3 $j_1 + j_2 + j = n$

27.9.4 $j_1 + j_2 - j$
 27.9.5 $j_1 - j_2 + j$
 27.9.6 $-j_1 + j_2 + j$ } ≥ 0

27.9.7 $m_1, m_2, m = \pm n$ or $\pm \frac{n}{2}$

27.9.8 $|m_1| \leq j_1, |m_2| \leq j_2, |m| \leq j$

27.9.9 $(j_1 j_2 m_1 m_2 | j_1 j_2 j m) = 0$ $m_1 + m_2 \neq m$

Special Values

27.9.10 $(j_1 0 m_1 0 | j_1 0 j m) = \delta(j_1, j) \delta(m_1, m)$

27.9.11 $(j_1 j_2 0 0 | j_1 j_2 j 0) = 0$ $j_1 + j_2 + j = 2n + 1$

27.9.12 $(j_1 j_1 m_1 m_1 | j_1 j_1 j m) = 0$ $2j_1 + j = 2n + 1$

Symmetry Relations

27.9.13

$$(j_1 j_2 m_1 m_2 | j_1 j_2 j m)$$

$$= (-1)^{j_1 + j_2 - j} (j_1 j_2 - m_1 - m_2 | j_1 j_2 j - m)$$

27.9.14

$$= (j_2 j_1 - m_2 - m_1 | j_2 j_1 j - m)$$

27.9.15

$$= (-1)^{j_1 + j_2 - j} (j_2 j_1 m_1 m_2 | j_2 j_1 j m)$$

27.9.16

$$= \sqrt{\frac{2j+1}{2j_1+1}} (-1)^{j_1+m_2} (j j_2 - m m_2 | j j_2 j_1 - m_1)$$

27.9.17

$$= \sqrt{\frac{2j+1}{2j_1+1}} (-1)^{j_1-m_1+j-m} (j j_2 m - m_2 | j j_2 j_1 m_1)$$

27.9.18

$$= \sqrt{\frac{2j+1}{2j_1+1}} (-1)^{j-m+j_1-m_1} (j_2 j m_2 - m | j_2 j j_1 - m_1)$$

27.9.19

$$= \sqrt{\frac{2j+1}{2j_2+1}} (-1)^{j_1-m_1} (j_1 j m_1 - m | j_1 j j_2 - m_2)$$

27.9.20

$$= \sqrt{\frac{2j+1}{2j_2+1}} (-1)^{j_1-m_1} (j j_1 m - m_1 | j j_1 j_2 m_2)$$

$(j_1 \frac{1}{2} m_1 m_2 | j_1 \frac{1}{2} j m)$

Table 27.9.1

$j =$	$m_2 = \frac{1}{2}$	$m_2 = -\frac{1}{2}$
$j_1 + \frac{1}{2}$	$\sqrt{\frac{j_1 + m + \frac{1}{2}}{2j_1 + 1}}$	$\sqrt{\frac{j_1 - m + \frac{1}{2}}{2j_1 + 1}}$
$j_1 - \frac{1}{2}$	$-\sqrt{\frac{j_1 - m + \frac{1}{2}}{2j_1 + 1}}$	$\sqrt{\frac{j_1 + m + \frac{1}{2}}{2j_1 + 1}}$

$(j_1 1 m_1 m_2 | j_1 1 j m)$

Table 27.9.2

$j =$	$m_2 = 1$	$m_2 = 0$	$m_2 = -1$
$j_1 + 1$	$\sqrt{\frac{(j_1 + m)(j_1 + m + 1)}{(2j_1 + 1)(2j_1 + 2)}}$	$\sqrt{\frac{(j_1 - m + 1)(j_1 + m + 1)}{(2j_1 + 1)(j_1 + 1)}}$	$\sqrt{\frac{(j_1 - m)(j_1 - m + 1)}{(2j_1 + 1)(2j_1 + 2)}}$
j_1	$-\sqrt{\frac{(j_1 + m)(j_1 - m + 1)}{2j_1(j_1 + 1)}}$	$\frac{m}{\sqrt{j_1(j_1 + 1)}}$	$\sqrt{\frac{(j_1 - m)(j_1 + m + 1)}{2j_1(j_1 + 1)}}$
$j_1 - 1$	$\sqrt{\frac{(j_1 - m)(j_1 - m + 1)}{2j_1(2j_1 + 1)}}$	$-\sqrt{\frac{(j_1 - m)(j_1 + m)}{j_1(2j_1 + 1)}}$	$\sqrt{\frac{(j_1 + m + 1)(j_1 + m)}{2j_1(2j_1 + 1)}}$

Table 27.9.3

 $(j_1 \frac{1}{2} m_1 m_2 | j_1 \frac{1}{2} j m)$

$j =$	$m_2 = \frac{1}{2}$	$m_2 = \frac{1}{2}$
$j_1 + \frac{1}{2}$	$\sqrt{\frac{(j_1 + m - \frac{1}{2})(j_1 + m + \frac{1}{2})(j_1 + m + \frac{3}{2})}{(2j_1 + 1)(2j_1 + 2)(2j_1 + 3)}}$	$\sqrt{\frac{3(j_1 + m + \frac{1}{2})(j_1 + m + \frac{3}{2})(j_1 - m + \frac{3}{2})}{(2j_1 + 1)(2j_1 + 2)(2j_1 + 3)}}$
$j_1 + \frac{1}{2}$	$-\sqrt{\frac{3(j_1 + m - \frac{1}{2})(j_1 + m + \frac{1}{2})(j_1 - m + \frac{3}{2})}{2j_1(2j_1 + 1)(2j_1 + 3)}}$	$-(j_1 - 3m + \frac{3}{2})\sqrt{\frac{j_1 + m + \frac{1}{2}}{2j_1(2j_1 + 1)(2j_1 + 3)}}$
$j_1 - \frac{1}{2}$	$\sqrt{\frac{3(j_1 + m - \frac{1}{2})(j_1 - m + \frac{1}{2})(j_1 - m + \frac{3}{2})}{(2j_1 - 1)(2j_1 + 1)(2j_1 + 2)}}$	$-(j_1 + 3m - \frac{1}{2})\sqrt{\frac{j_1 - m + \frac{1}{2}}{(2j_1 - 1)(2j_1 + 1)(2j_1 + 2)}}$
$j_1 - \frac{3}{2}$	$-\sqrt{\frac{(j_1 - m - \frac{1}{2})(j_1 - m + \frac{1}{2})(j_1 - m + \frac{3}{2})}{2j_1(2j_1 - 1)(2j_1 + 1)}}$	$\sqrt{\frac{3(j_1 + m - \frac{1}{2})(j_1 - m - \frac{1}{2})(j_1 - m + \frac{1}{2})}{2j_1(2j_1 - 1)(2j_1 + 1)}}$
$j =$	$m_2 = -\frac{1}{2}$	$m_2 = -\frac{1}{2}$
$j_1 + \frac{3}{2}$	$\sqrt{\frac{3(j_1 + m + \frac{3}{2})(j_1 - m + \frac{1}{2})(j_1 - m + \frac{3}{2})}{(2j_1 + 1)(2j_1 + 2)(2j_1 + 3)}}$	$\sqrt{\frac{(j_1 - m - \frac{1}{2})(j_1 - m + \frac{1}{2})(j_1 - m + \frac{3}{2})}{(2j_1 + 1)(2j_1 + 2)(2j_1 + 3)}}$
$j_1 + \frac{1}{2}$	$(j_1 + 3m + \frac{3}{2})\sqrt{\frac{j_1 - m + \frac{1}{2}}{2j_1(2j_1 + 1)(2j_1 + 3)}}$	$\sqrt{\frac{3(j_1 + m + \frac{3}{2})(j_1 - m - \frac{1}{2})(j_1 - m + \frac{1}{2})}{2j_1(2j_1 + 1)(2j_1 + 3)}}$
$j_1 - \frac{1}{2}$	$-(j_1 - 3m - \frac{1}{2})\sqrt{\frac{j_1 + m + \frac{1}{2}}{(2j_1 - 1)(2j_1 + 1)(2j_1 + 2)}}$	$\sqrt{\frac{3(j_1 + m + \frac{1}{2})(j_1 + m + \frac{3}{2})(j_1 - m - \frac{1}{2})}{(2j_1 - 1)(2j_1 + 1)(2j_1 + 2)}}$
$j_1 - \frac{3}{2}$	$-\sqrt{\frac{3(j_1 + m - \frac{1}{2})(j_1 + m + \frac{1}{2})(j_1 - m - \frac{1}{2})}{2j_1(2j_1 - 1)(2j_1 + 1)}}$	$\sqrt{\frac{(j_1 + m - \frac{1}{2})(j_1 + m + \frac{1}{2})(j_1 + m + \frac{3}{2})}{2j_1(2j_1 - 1)(2j_1 + 1)}}$

Table 27.9.4

$(j_1 \ 2 \ m_1 \ m_2 \ | \ j_1 \ 2 \ j \ m)$

$j =$	$m_2 = 2$	$m_2 = 1$	$m_2 = 0$
$j_1 + 2$	$\sqrt{\frac{(j_1 + m - 1)(j_1 + m)(j_1 + m + 1)(j_1 + m + 2)}{(2j_1 + 1)(2j_1 + 2)(2j_1 + 3)(2j_1 + 4)}}$	$\sqrt{\frac{(j_1 - m + 2)(j_1 + m + 2)(j_1 + m + 1)(j_1 + m)}{(2j_1 + 1)(j_1 + 1)(2j_1 + 3)(j_1 + 2)}}$	$\sqrt{\frac{3(j_1 - m + 2)(j_1 - m + 1)(j_1 + m + 2)(j_1 + m + 1)}{(2j_1 + 1)(2j_1 + 2)(2j_1 + 3)(j_1 + 2)}}$
$j_1 + 1$	$-\sqrt{\frac{(j_1 + m - 1)(j_1 + m)(j_1 + m + 1)(j_1 - m + 2)}{2j_1(j_1 + 1)(j_1 + 2)(2j_1 + 1)}}$	$-(j_1 - 2m + 2)\sqrt{\frac{(j_1 + m + 1)(j_1 + m)}{2j_1(2j_1 + 1)(j_1 + 1)(j_1 + 2)}}$	$m\sqrt{\frac{3(j_1 - m + 1)(j_1 + m + 1)}{j_1(2j_1 + 1)(j_1 + 1)(j_1 + 2)}}$
j_1	$\sqrt{\frac{3(j_1 + m - 1)(j_1 + m)(j_1 - m + 1)(j_1 - m + 2)}{(2j_1 - 1)2j_1(j_1 + 1)(2j_1 + 3)}}$	$(1 - 2m)\sqrt{\frac{3(j_1 - m + 1)(j_1 + m)}{(2j_1 - 1)j_1(2j_1 + 2)(2j_1 + 3)}}$	$\frac{3m^2 - j_1(j_1 + 1)}{\sqrt{(2j_1 - 1)j_1(j_1 + 1)(2j_1 + 3)}}$
$j_1 - 1$	$-\sqrt{\frac{(j_1 + m - 1)(j_1 - m)(j_1 - m + 1)(j_1 - m + 2)}{2(j_1 - 1)j_1(j_1 + 1)(2j_1 + 1)}}$	$(j_1 + 2m - 1)\sqrt{\frac{(j_1 - m + 1)(j_1 - m)}{(j_1 - 1)j_1(2j_1 + 1)(2j_1 + 2)}}$	$-m\sqrt{\frac{3(j_1 - m)(j_1 + m)}{(j_1 - 1)j_1(2j_1 + 1)(j_1 + 1)}}$
$j_1 - 2$	$\sqrt{\frac{(j_1 - m - 1)(j_1 - m)(j_1 - m + 1)(j_1 - m + 2)}{(2j_1 - 2)(2j_1 - 1)2j_1(2j_1 + 1)}}$	$-\sqrt{\frac{(j_1 - m + 1)(j_1 - m)(j_1 - m - 1)(j_1 + m - 1)}{(j_1 - 1)(2j_1 - 1)j_1(2j_1 + 1)}}$	$\sqrt{\frac{3(j_1 - m)(j_1 - m - 1)(j_1 + m)(j_1 + m - 1)}{(2j_1 - 2)(2j_1 - 1)j_1(2j_1 + 1)}}$
$j =$	$m_2 = -1$	$m_2 = -2$	
$j_1 + 2$	$\sqrt{\frac{(j_1 - m + 2)(j_1 - m + 1)(j_1 - m)(j_1 + m + 2)}{(2j_1 + 1)(j_1 + 1)(2j_1 + 3)(j_1 + 2)}}$	$\sqrt{\frac{(j_1 - m - 1)(j_1 - m)(j_1 - m + 1)(j_1 - m + 2)}{(2j_1 + 1)(2j_1 + 2)(2j_1 + 3)(2j_1 + 4)}}$	
$j_1 + 1$	$(j_1 + 2m + 2)\sqrt{\frac{(j_1 - m + 1)(j_1 - m)}{j_1(2j_1 + 1)(2j_1 + 2)(j_1 + 2)}}$	$\sqrt{\frac{(j_1 - m - 1)(j_1 - m)(j_1 - m + 1)(j_1 + m + 2)}{j_1(2j_1 + 1)(j_1 + 1)(2j_1 + 4)}}$	
j_1	$(2m + 1)\sqrt{\frac{3(j_1 - m)(j_1 + m + 1)}{(2j_1 - 1)j_1(2j_1 + 2)(2j_1 + 3)}}$	$\sqrt{\frac{3(j_1 - m - 1)(j_1 - m)(j_1 + m + 1)(j_1 + m + 2)}{(2j_1 - 1)j_1(2j_1 + 2)(2j_1 + 3)}}$	
$j_1 - 1$	$-(j_1 - 2m - 1)\sqrt{\frac{(j_1 + m + 1)(j_1 + m)}{(j_1 - 1)j_1(2j_1 + 1)(2j_1 + 2)}}$	$\sqrt{\frac{(j_1 - m - 1)(j_1 + m)(j_1 + m + 1)(j_1 + m + 2)}{(j_1 - 1)j_1(2j_1 + 1)(2j_1 + 2)}}$	
$j_1 - 2$	$-\sqrt{\frac{(j_1 - m - 1)(j_1 + m + 1)(j_1 + m)(j_1 + m - 1)}{(j_1 - 1)(2j_1 - 1)j_1(2j_1 + 1)}}$	$\sqrt{\frac{(j_1 + m - 1)(j_1 + m)(j_1 + m + 1)(j_1 + m + 2)}{(2j_1 - 2)(2j_1 - 1)2j_1(2j_1 + 1)}}$	

Table 27.9.5 [By use of symmetry relations, coefficients may be put in standard form $j_1 \leq j_2 \leq j$ and $m \geq 0$]

m_2	m	j_1	j	$(j_1 j_2 m_1 m_2 j_1 j_2 j m)$	
$j_2 = \frac{1}{2}$					
$-\frac{1}{2}$	0	$\frac{1}{2}$	1	$\sqrt{\frac{1}{2}}$	0. 70711
$\frac{1}{2}$	0	$\frac{1}{2}$	1	$\sqrt{\frac{1}{2}}$	0. 70711
$\frac{1}{2}$	1	$\frac{1}{2}$	1		1. 00000
$j_2 = 1$					
-1	0	1	1	$\sqrt{\frac{1}{2}}$	0. 70711
0	0	1	1		0. 00000
1	0	1	1	$-\sqrt{\frac{1}{2}}$	-0. 70711
0	1	1	1	$\sqrt{\frac{1}{2}}$	0. 70711
1	1	1	1	$-\sqrt{\frac{1}{2}}$	-0. 70711
0	$\frac{1}{2}$	$\frac{1}{2}$	$\frac{3}{2}$	$\sqrt{\frac{3}{4}}$	0. 81650
1	$\frac{1}{2}$	$\frac{1}{2}$	$\frac{3}{2}$	$\sqrt{\frac{1}{4}}$	0. 57735
1	$\frac{3}{2}$	$\frac{1}{2}$	$\frac{3}{2}$		1. 00000
-1	0	1	2	$\sqrt{\frac{1}{4}}$	0. 40825
0	0	1	2	$\sqrt{\frac{3}{4}}$	0. 81650
1	0	1	2	$\sqrt{\frac{1}{4}}$	0. 40825
0	1	1	2	$\sqrt{\frac{1}{2}}$	0. 70711
1	1	1	2	$\sqrt{\frac{1}{2}}$	0. 70711
1	2	1	2		1. 00000
$j_2 = \frac{3}{2}$					
$-\frac{1}{2}$	$\frac{1}{2}$	1	$\frac{3}{2}$	$\sqrt{\frac{9}{16}}$	0. 73030
$\frac{1}{2}$	$\frac{1}{2}$	1	$\frac{3}{2}$	$-\sqrt{\frac{1}{16}}$	-0. 25820
$\frac{1}{2}$	$\frac{1}{2}$	1	$\frac{3}{2}$	$-\sqrt{\frac{3}{8}}$	-0. 63246
$\frac{1}{2}$	$\frac{3}{2}$	1	$\frac{3}{2}$	$\sqrt{\frac{3}{4}}$	0. 63246
$\frac{3}{2}$	$\frac{3}{2}$	1	$\frac{3}{2}$	$-\sqrt{\frac{3}{8}}$	-0. 77460
$-\frac{1}{2}$	0	$\frac{1}{2}$	2	$\sqrt{\frac{1}{2}}$	0. 70711
$\frac{1}{2}$	0	$\frac{1}{2}$	2	$\sqrt{\frac{1}{2}}$	0. 70711
$\frac{1}{2}$	1	$\frac{1}{2}$	2	$\frac{1}{2}\sqrt{3}$	0. 86603
$\frac{3}{2}$	1	$\frac{1}{2}$	2		0. 50000
$\frac{3}{2}$	2	$\frac{1}{2}$	2		1. 00000
$-\frac{3}{2}$	0	$\frac{3}{2}$	2		0. 50000
$-\frac{1}{2}$	0	$\frac{3}{2}$	2		0. 50000
$\frac{1}{2}$	0	$\frac{3}{2}$	2		-0. 50000
$\frac{3}{2}$	0	$\frac{3}{2}$	2		-0. 50000
$-\frac{1}{2}$	1	$\frac{3}{2}$	2	$\sqrt{\frac{1}{2}}$	0. 70711
$\frac{1}{2}$	1	$\frac{3}{2}$	2		0. 00000
$\frac{3}{2}$	1	$\frac{3}{2}$	2	$-\sqrt{\frac{1}{2}}$	-0. 70711
$\frac{1}{2}$	2	$\frac{3}{2}$	2	$\sqrt{\frac{1}{2}}$	0. 70711
$\frac{3}{2}$	2	$\frac{3}{2}$	2	$-\sqrt{\frac{1}{2}}$	-0. 70711
$-\frac{1}{2}$	$\frac{1}{2}$	1	$\frac{5}{2}$	$\sqrt{\frac{3}{10}}$	0. 54772
$\frac{1}{2}$	$\frac{1}{2}$	1	$\frac{5}{2}$	$\sqrt{\frac{3}{5}}$	0. 77460
$\frac{3}{2}$	$\frac{1}{2}$	1	$\frac{5}{2}$	$\sqrt{\frac{1}{10}}$	0. 31623
$\frac{1}{2}$	$\frac{3}{2}$	1	$\frac{5}{2}$	$\sqrt{\frac{3}{5}}$	0. 77460
$\frac{3}{2}$	$\frac{3}{2}$	1	$\frac{5}{2}$	$\sqrt{\frac{3}{5}}$	0. 63246
$\frac{3}{2}$	$\frac{5}{2}$	1	$\frac{5}{2}$		1. 00000

Compiled from A. Simon, Numerical tables of the Clebsch-Gordan coefficients, Oak Ridge National Laboratory Report 1718, Oak Ridge, Tenn. (1954) (with permission).

- [27.25] E. U. Condon and G. A. Shortley, Theory of atomic spectra (Cambridge Univ. Press, Cambridge, England, 1935).
- [27.26] M. E. Rose, Elementary theory of angular momentum (John Wiley & Sons, Inc., New York, N. Y., 1955).
- [27.27] A. Simon, Numerical tables of the Clebsch-Gordan coefficients, Oak Ridge National Laboratory Report 1718, Oak Ridge, Tenn. (1954). $C(j_1 j_2 j; m_1 m_2 m)$ for all angular moments $< \frac{1}{2}, 10D$.

28. Scales of Notation

S. PEAVY,¹ A. SCHOPF²

Contents

	Page
Representation of Numbers	1012
Numerical Methods	1013
References.	1015
Table 28.1. $2^{\pm n}$ in Decimal, $n=0(1)50$, Exact	1016
Table 28.2. 2^x in Decimal, $x=.001(.001).01(.01).1(.1).9$, 15D	1017
Table 28.3. $10^{\pm n}$ in Octal, $n=0(1)18$, Exact or 20D	1017
Table 28.4. $n \log_{10} 2$, $n \log_2 10$ in Decimal, $n=1(1)10$, 10D	1017
Table 28.5. Addition and Multiplication Tables, Binary and Octal Scales	1017
Table 28.6. Mathematical Constants in Octal Scale	1017

The authors acknowledge the assistance of David S. Liepman in the preparation and checking of the tables.

¹ National Bureau of Standards.

² Guest worker, National Bureau of Standards, from The American University (deceased).

28. Scales of Notation

Representation of Numbers

Any positive real number x can be uniquely represented in the scale of some integer $b > 1$ as

$$x = (A_m \dots A_1 A_0 \cdot a_{-1} a_{-2} \dots)_{(b)},$$

where every A_i and a_{-j} is one of the integers $0, 1, \dots, b-1$, not all A_i, a_{-j} are zero, and $A_m > 0$ if $x \geq 1$. There is a one-to-one correspondence between the number and the sequence

$$x = A_m b^m + \dots + A_1 b + A_0 + \sum_{j=1}^{\infty} a_{-j} b^{-j}$$

where the infinite series converges. The integer b is called the base or radix of the scale.

The sequence for x in the scale of b may terminate, i.e., $a_{-n-1} = a_{-n-2} = \dots = 0$ for some $n \geq 1$ so that

$$x = (A_m \dots A_1 A_0 \cdot a_{-1} a_{-2} \dots a_{-n})_{(b)};$$

then x is said to be a finite b -adic number.

A sequence which does not terminate may have the property that the infinite sequence a_{-1}, a_{-2}, \dots becomes periodic from a certain digit $a_{-n} (n \geq 1)$ on; according as $n=1$ or $n > 1$ the sequence is then said to be pure or mixed recurring.

A sequence which neither terminates nor recurs represents an irrational number.

Names of Scales

Base	Scale	Base	Scale
2	Binary	8	Octal
3	Ternary	9	Nonary
4	Quaternary	10	Decimal
5	Quinary	11	Undenary
6	Senary	12	Duodenary
7	Septenary	16	Hexadecimal

General Conversion Methods

Any number can be converted from the scale of b to the scale of some integer $\bar{b} \neq b, \bar{b} > 1$, by using arithmetic operations in either the b -scale or the \bar{b} -scale. Accordingly, there are four methods of conversion, depending on whether the number to be converted is an integer or a proper fraction.

Integers $X = (A_m \dots A_1 A_0)_{(b)}$

(I) \bar{b} -scale arithmetic. Convert \bar{b} to the b -scale and define

$$X/\bar{b} = X_1 + \bar{A}'_0/\bar{b},$$

$$X_1/\bar{b} = X_2 + \bar{A}'_1/\bar{b},$$

⋮

$$X_m/\bar{b} = 0 + \bar{A}'_m/\bar{b},$$

where $\bar{A}'_0, \bar{A}'_1, \dots, \bar{A}'_m$ are the remainders and X_1, X_2, \dots, X_m the quotients (in the b -scale) where X, X_1, \dots, X_{m-1} , respectively are divided by \bar{b} in the b -scale. Then convert the remainders to the \bar{b} -scale,

$$(\bar{A}'_0)_{(\bar{b})} = \bar{A}_0, (\bar{A}'_1)_{(\bar{b})} = \bar{A}_1, \dots, (\bar{A}'_m)_{(\bar{b})} = \bar{A}_m$$

and obtain

$$X = (\bar{A}_m \dots \bar{A}_1 \bar{A}_0)_{(\bar{b})}.$$

(II) \bar{b} -scale arithmetic. Convert b and A_0, A_1, \dots, A_m to the \bar{b} -scale and define, using arithmetic operations in the \bar{b} -scale,

$$X_{m-1} = A_m b + A_{m-1},$$

$$X_{m-2} = X_{m-1} b + A_{m-2},$$

$$X_1 = X_2 b + A_1,$$

then

$$X = X_1 b + A_0.$$

Proper fractions $x = (0.a_{-1} a_{-2} \dots)_{(b)}$

To convert a proper fraction x , given to n digits in the b -scale, to the scale of $\bar{b} \neq b$ such that inverse conversion from the \bar{b} -scale may yield the same n rounded digits in the b -scale, the representation of x in the \bar{b} -scale must be obtained to \bar{n} rounded digits where \bar{n} satisfies $\bar{b}^{\bar{n}} > b^n$.

(III) \bar{b} -scale arithmetic. Convert \bar{b} to the b -scale and define

$$x\bar{b} = x_1 + \bar{a}'_{-1}$$

$$x_1\bar{b} = x_2 + \bar{a}'_{-2}$$

$$x_{\bar{n}-1}\bar{b} = x_{\bar{n}} + \bar{a}'_{-\bar{n}}$$

where $\bar{a}_{-1}, \bar{a}'_{-2}, \dots, \bar{a}_{-n}$ are the integral parts and x_1, x_2, \dots, x_n the fractional parts (in the b -scale) of the products $x\bar{b}, x_1\bar{b}, \dots, x_{n-1}\bar{b}$, respectively. Then convert the integral parts to the \bar{b} -scale,

$$(\bar{a}'_{-1})_{(\bar{b})} = \bar{a}_{-1}, (\bar{a}'_{-2})_{(\bar{b})} = \bar{a}_{-2}, \dots, (\bar{a}'_{-n})_{(\bar{b})} = \bar{a}_{-n},$$

and obtain

$$x = (0.\bar{a}_{-1}\bar{a}_{-2} \dots \bar{a}_{-n})_{(\bar{b})}.$$

(IV) \bar{b} -scale arithmetic. Convert b and $a_{-1}, a_{-2}, \dots, a_{-n}$ to the \bar{b} -scale and define, using arithmetic operations in the \bar{b} -scale,

$$x_{-n+1} = a_{-n}/b + a_{-n+1},$$

$$x_{-n+2} = x_{-n+1}/b + a_{-n+2},$$

$$x_{-1} = x_2/b + a_{-1};$$

then

$$x = x_{-1}/b.$$

Numerical Methods

The examples are restricted to the scales of 2, 8, 10 because of their importance to electronic computers.

Note that the octal scale is a power of the binary scale. In fact, an octal digit corresponds to a triplet of binary digits. Then, binary arithmetic may be used whenever a number either is to be converted to the octal scale or is given in the octal scale and is to be converted to some other scale.

Decimal	1	2	3	4	5	6	7	8	9	10
Octal	1	2	3	4	5	6	7	10	11	12
Binary	1	10	11	100	101	110	111	1 000	1 001	1 010

Example 1. Convert $X = (1369)_{(10)}$ to the octal scale. By (I) we have $b = 10, \bar{b} = 8_{(10)}$ and so, using decimal arithmetic,

$$1369/8 = 171 + 1/8,$$

$$171/8 = 21 + 3/8,$$

$$21/8 = 2 + 5/8,$$

$$2/8 = 0 + 2/8;$$

then

$$X = (2531)_{(8)}.$$

By (II) we have $b = (12)_{(8)}$ and $A_3 = 1_{(8)}, A_2 = 3_{(8)}, A_1 = 6_{(8)}, A_0 = (11)_{(8)}$. Hence, using octal arithmetic,

$$X_2 = 1 \cdot 12 + 3 = (15)_{(8)},$$

$$X_1 = 15 \cdot 12 + 6 = (210)_{(8)},$$

$$X = 210 \cdot 12 + 11 = (2531)_{(8)}.$$

Using binary arithmetic we have, by (II), $b = (1010)_{(2)}$ and $A_3 = 1_{(2)}, A_2 = (11)_{(2)}, A_1 = (110)_{(2)}, A_0 = (1001)_{(2)}$. Thus

$$X_2 = 1 \cdot 1010 + 11 = (1101)_{(2)},$$

$$X_1 = 1101 \cdot 1010 + 110 = (10 001 000)_{(2)},$$

$$X = 10 001 000 \cdot 1010 + 1001 = (10 101 011 001)_{(2)},$$

whence, on converting to the octal scale,

$$X = (2531)_{(8)}.$$

Example 2. Convert $X = (2531)_{(8)}$ to the decimal scale. By (I) we have $\bar{b} = 10 = (12)_{(8)}$ and hence, using octal arithmetic,

$$2531/12 = 210 + 11/12$$

$$210/12 = 15 + 6/12$$

$$15/12 = 1 + 3/12$$

$$1/12 = 0 + 1/12$$

Thus, converting to the decimal scale,

$$\bar{A}_0 = (11)_{(8)} = 9, \bar{A}_1 = 6_{(8)} = 6, \bar{A}_2 = 3_{(8)} = 3, \bar{A}_3 = 1,$$

and so

$$X = (1369)_{(10)}.$$

By (II) we have $\bar{b} = 10$, and the octal digits of X are unchanged in the decimal scale. Hence, using decimal arithmetic,

$$X_2 = 2 \cdot 8 + 5 = (21)_{(10)},$$

$$X_1 = 21 \cdot 8 + 3 = (171)_{(10)},$$

$$X = 171 \cdot 8 + 1 = (1369)_{(10)}.$$

Using binary arithmetic we have, by (II), $b = 8 = (1000)_{(2)}$ and $A_0 = 1, A_1 = (11)_{(2)}, A_2 = (101)_{(2)}, A_3 = (10)_{(2)}$. Then,

$$X_2 = 10 \cdot 1000 + 101 = (10 101)_{(2)},$$

$$X_1 = 10 101 \cdot 1000 + 11 = (10 101 011)_{(2)},$$

$$X = 10 101 011 \cdot 1000 + 1 = (10 101 011 001)_{(2)},$$

whence, on converting to the decimal scale,

$$X = (1369)_{(10)}.$$

Observe that in both examples above, octal arithmetic is used as an intermediate step to convert, according to (II), the given number to the binary scale. If, instead, the given number is first converted to the binary scale, then binary arithmetic may be applied directly to convert, according to (I), the given number from the binary scale to the scale desired.

For example, in converting $X=(2531)_{(8)}$ to the decimal scale, we find first $X=(10101011001)_{(2)}$ and then obtain, using (I) with $\bar{b}=10=(1010)_{(2)}$,

$$\begin{aligned} 10\ 101\ 011\ 001/1010 &= 10\ 001\ 000 + 1001/1010, \\ 10\ 001\ 000/1010 &= 1101 + 110/1010, \\ 1101/1010 &= 1 + 11/1010, \\ 1/1010 &= 0 + 1/1010. \end{aligned}$$

Thus, on converting to the decimal scale,

$$\begin{aligned} A_0 &= (1001)_{(2)} = 9, & A_1 &= (110)_{(2)} = 6, \\ & & A_2 &= (11)_{(2)} = 3, & A_3 &= 1, \end{aligned}$$

whence

$$X = (1369)_{(10)}.$$

Example 3. Convert $x=(0.355)_{(10)}$ to the binary scale.

We first convert to the octal scale, using decimal arithmetic. By (III), we find with $\bar{b}=8$

$$\begin{aligned} (0.355) \cdot 8 &= 2 + 0.840, & (0.080) \cdot 8 &= 0 + 0.640 \\ (0.840) \cdot 8 &= 6 + 0.720, & (0.640) \cdot 8 &= 5 + 0.120 \\ (0.720) \cdot 8 &= 5 + 0.760, & (0.120) \cdot 8 &= 0 + 0.960 \\ (0.760) \cdot 8 &= 6 + 0.080, & (0.960) \cdot 8 &= 7 + 0.680 \end{aligned}$$

whence $x=(0.26560507 \dots)_{(8)}$. Thus, on converting to the binary scale,

$$x = (0.010\ 110\ 101\ 110\ 000\ 101\ 000\ 111 \dots)_{(2)}.$$

In order that inverse conversion of x from the binary to the decimal scale yield again x to the given number n of decimal digits, we must round x in the binary scale to at least \bar{n} digits where \bar{n} is chosen such that $2^{\bar{n}} > 10^n$. As a working rule, we may take $\bar{n} \geq \frac{10}{3}n$. Hence, to obtain $x=(0.355)_{(10)}$ by inverse conversion, x must be rounded in the binary scale to $\bar{n} \geq \frac{10}{3} \cdot 3 = 10$ digits.

Thus,

$$x = (0.010\ 110\ 110\ 0)_{(2)}.$$

To carry out the inverse conversion we can first convert to the octal scale,

$$x = (0.266)_{(8)},$$

and then apply (IV) with $b=8$, using decimal arithmetic:

$$\begin{aligned} x_{-2} &= 6/8 + 6 = 6.75, \\ x_{-1} &= 6.75/8 + 2 = 2.84375, \\ x &= 2.84375/8 = 0.355\ 46875. \end{aligned}$$

Alternatively, we can apply (III) with $\bar{b}=(1010)_{(2)}$, using binary arithmetic:

$$\begin{aligned} (0.010\ 110\ 11) \cdot 1010 &= 11 + (0.100\ 011\ 1), \\ (0.100\ 011\ 1) \cdot 1010 &= 101 + (0.100\ 011), \\ (0.100\ 011) \cdot 1010 &= 101 + (0.011\ 11), \\ (0.011\ 11) \cdot 1010 &= 100 + (0.101\ 1). \end{aligned}$$

Converting the integral parts to the decimal scale, we find

$$\begin{aligned} \bar{a}_{-1} &= (11)_{(2)} = 3, & \bar{a}_{-2} = \bar{a}_{-3} &= (101)_{(2)} = 5, \\ & & \bar{a}_{-4} &= (100)_{(2)} = 4, \end{aligned}$$

and thus

$$x = (0.3554)_{(10)}$$

Note that the fractional part in any step is the unconverted remainder. Thus, to round at any step, it is only necessary to ascertain whether the unconverted portion to be neglected is greater or less than $\frac{1}{2}$; i.e., whether, in the binary scale, the first neglected digit is 1 or 0.

Example 4. Convert $x=(3.141593)_{(10)} \cdot 10^{-9}$ to the binary scale.

The desired representation is

$$x = (1.a_{-1}a_{-2} \dots a_{-n})_{(2)} \cdot 2^{-k}$$

where n and k are such that inverse conversion from the binary scale to the decimal scale will produce x to the same given 15 decimal digits. Accordingly, by the rule stated in **Example 3**, n and k are to be chosen so as to satisfy $n+k \geq \frac{10}{3} \cdot 15 = 50$.

From **Table 28.1** we find

$$2^{-29} < (3.141593)_{(10)} \cdot 10^{-9} < 2^{-28}$$

Thus, we must take $k=29$ and, consequently, choose $n > 21$. The conversion on a desk calculator thus proceeds as follows. First, we obtain by use of **Table 28.1**

$$2^{29}x = (1.686\ 629\ 899)_{(10)}$$

Then, for convenience's sake, we convert this number to the octal scale, using the method of **Example 3** and rounding as required, to at least 7 octal (=21 binary) digits. We find

$$2^{29}x = (1.537\ 4337)_{(8)}.$$

Hence

$$x = (1.537\ 433\ 7)_{(8)} \cdot 2^{-29}$$

and, consequently,

$$x = (1.\ 101\ 011\ 111\ 100\ 011\ 011\ 111)_{(2)} \cdot 2^{-29}.$$

To convert x back to the decimal scale we only need to obtain from **Table 28.1** the various powers of 2 which appear in the above representation and sum them. However, since $2^{-m} = 2^{-m+1} - 2^{-m}$ for any real constant m , it is more convenient to reduce first the binary representation of x to the form

$$x = 2^{-28} - 2^{-31} - 2^{-33} - 2^{-39} + 2^{-42} - 2^{-45} - 2^{-50}$$

and then sum these powers of 2. (Note that the number of summands is thereby decreased from 16 to 7.) From **Table 28.1** we have

$+2^{-28} =$	+3.725	290	298	$\cdot 10^{-9}$
$-2^{-31} =$	-.465	661	287	$\cdot 10^{-9}$
$-2^{-33} =$.116	415	322	$\cdot 10^{-9}$
$-2^{-39} =$.001	818	989	$\cdot 10^{-9}$
$+2^{-42} =$.000	227	374	$\cdot 10^{-9}$
$-2^{-45} =$.000	028	422	$\cdot 10^{-9}$
$-2^{-50} =$.000	000	888	$\cdot 10^{-9}$
$x =$	3.141	592	764	$\cdot 10^{-9}$

Nine decimal digits are used for sufficient accuracy reserve. Hence, rounding to seven significant figures, we find

$$x = (3.141593)_{(10)} \cdot 10^{-9}$$

To convert a number such as

$$x = (\xi)_{(10)} \cdot 10^k$$

to the binary scale, where k is a positive integer so large that **Table 28.1** cannot be used, apply the following device: Compute

$$\log_2 x = \frac{\log_{10} x}{\log_{10} 2} = k + \frac{x_1}{\log_{10} 2}$$

where k is the quotient and x_1 the remainder, the division being carried out in the decimal scale. Then find $\eta = 10^{x_1}$, i.e., $x_1 = \log_{10} \eta$, so that

$$\log_2 x = k + \frac{\log_{10} \eta}{\log_{10} 2} = k + \log_2 \eta$$

whence

$$x = (\eta)_{(10)} 2^k$$

Now convert $(\eta)_{(10)}$ to the binary scale by any of the methods described above.

A similar device may be used to convert to the decimal scale a binary number that is outside the range of **Table 28.1**.

Example 5. Convert $x = (2.773)_{(10)} \cdot 10^{83}$ to the binary scale.

We first compute, using **4.1.19** and **Table 4.1**,

$$\log_2 x = \frac{\log_{10} x}{\log_{10} 2} = \frac{83.44295}{.30103} = 277 + \frac{.05764}{.30103},$$

and find from **Table 4.1**, $.05764 = \log_{10} 1.1419$. Hence

$$\log_2 x = 277 + \frac{\log_{10} 1.1419}{\log_{10} 2} = 277 + \log_2 1.1419$$

and so

$$x = (1.1419)_{(10)} \cdot 2^{277}$$

Now we apply the methods of **Example 3** to obtain $(1.1419)_{(10)} = (1.110516)_{(8)}$ where octal notation is used for the sake of convenience.

To round such that inverse conversion will yield the same decimal digits of x , observe that the last non-zero decimal digit of x is $3 \cdot 10^{80}$. **Table 28.4** shows that $2^{265} < 10^{80} < 2^{266}$. Hence, in the binary scale, x must be a binary integer times 2^{265} ; i.e., $(1.110516)_{(8)}$ must be rounded to 4 octal (=12 binary) digits. As a result,

$$\begin{aligned} x &= (1.1105)_{(8)} \cdot 2^{277} = (11105)_{(8)} \cdot 2^{265} \\ &= (1\ 001\ 001\ 000\ 101)_{(2)} 2^{265} \end{aligned}$$

Conversion back to the decimal scale proceeds as follows, we write

$$\begin{aligned} \log_{10} x &= \log_{10} 2 \log_2 x \\ &= \log_{10} 2 \{ 265 + \log_2 (11105)_{(8)} \} \\ &= \log_{10} 2 \left\{ 265 + \frac{\log_{10} (11105)_{(8)}}{\log_{10} 2} \right\} \\ &= 265 \log_{10} 2 + \log_{10} (11105)_{(8)}. \end{aligned}$$

Hence, converting $(11105)_{(8)}$ to the decimal scale by any of the methods of **Example 2**, we obtain

$$\log_{10} x = 265 \log_{10} 2 + \log_{10} 4677$$

which yields, using **Table 4.1**

$$\log_{10} x = 83.44292$$

Thus, by **Table 4.1**, we find, rounded to four significant figures,

$$x = (2.773)_{(10)} \cdot 10^{83}$$

References

[28.1] J. Malengreau, *Étude des écritures binaires*, Bibliothèque Sci. 32 Mathématique. Édition Griffon, Neuchâtel, Suisse (1958).
 [28.2] D. D. McCracken, *Digital computer programming* (John Wiley & Sons, Inc., New York, N.Y., 1957).
 [28.3] R. K. Richards, *Arithmetic operation in digital computers* (D. Van Nostrand Co., Inc., New York, N.Y., 1955).

Table 28.1

2^{±n} IN DECIMAL

2 ⁿ	n	2 ⁻ⁿ
1	0	1.0
2	1	0.5
4	2	0.25
8	3	0.125
16	4	0.0625
32	5	0.03125
64	6	0.015625
128	7	0.0078125
256	8	0.00390625
512	9	0.001953125
1024	10	0.0009765625
2048	11	0.00048828125
4096	12	0.000244140625
8192	13	0.0001220703125
16384	14	0.00006103515625
32768	15	0.000030517578125
65536	16	0.0000152587890625
131072	17	0.00000762939453125
262144	18	0.000003814697265625
524288	19	0.0000019073486328125
1048576	20	0.00000095367431640625
2097152	21	0.000000476837158203125
4194304	22	0.0000002384185791015625
8388608	23	0.00000011920928955078125
16777216	24	0.000000059604644775390625
33554432	25	0.0000000298023223876953125
67108864	26	0.00000001490116119384765625
134217728	27	0.000000007450580596923828125
268435456	28	0.0000000037252902984619140625
536870912	29	0.00000000186264514923095703125
1073741824	30	0.000000000931322574615478515625
2147483648	31	0.0000000004656612873077392578125
4294967296	32	0.00000000023283064365386962890625
8589934592	33	0.000000000116415321826934814453125
17179869184	34	0.0000000000582076609134674072265625
34359738368	35	0.00000000002910383045673370361328125
68719476736	36	0.000000000014551915228366851806640625
137438953472	37	0.0000000000072759576141834259033203125
274877906944	38	0.00000000000363797880709171295166015625
549755813888	39	0.000000000001818989403545856475830078125
1099511627776	40	0.0000000000009094947017729282379150390625
2199023255552	41	0.00000000000045474735088646411895751953125
4398046511104	42	0.000000000000227373675443232059478759765625
8796093022208	43	0.0000000000001136868377216160297393798828125
17592186044416	44	0.00000000000005684341886080801486968994140625
35184372088832	45	0.00000000000002842170943040400743484970703125
70368744177664	46	0.000000000000014210854715202003717424853515625
140737488355328	47	0.00000000000000710542735760100185871124267578125
281474976710656	48	0.000000000000003552713678800500929355621337890625
562949953421312	49	0.0000000000000017763568394002504646778106689453125
1125899906842624	50	0.00000000000000088817841970012523233890533447265625

2^x IN DECIMAL

Table 28.2

x	2 ^x	x	2 ^x	x	2 ^x
0.001	1.00069 33874 62581	0.01	1.00695 55500 56719	0.1	1.07177 34625 36293
0.002	1.00138 72557 11335	0.02	1.01395 94797 90029	0.2	1.14869 83549 97035
0.003	1.00208 16050 79633	0.03	1.02101 21257 07193	0.3	1.23114 44133 44916
0.004	1.00277 64359 01078	0.04	1.02811 38266 56067	0.4	1.31950 79107 72894
0.005	1.00347 17485 09503	0.05	1.03526 49238 41377	0.5	1.41421 35623 73095
0.006	1.00416 75432 38973	0.06	1.04246 57608 41121	0.6	1.51571 65665 10398
0.007	1.00486 38204 23785	0.07	1.04971 66836 23067	0.7	1.62450 47927 12471
0.008	1.00556 05803 98468	0.08	1.05701 80405 61380	0.8	1.74110 11265 92248
0.009	1.00625 78234 97782	0.09	1.06437 01824 53360	0.9	1.86606 59830 73615

10^{±n} IN OCTAL

Table 28.3

10 ⁿ	n	10 ⁻ⁿ	10 ⁿ	n	10 ⁻ⁿ
1	0	1.000 000 000 000 000 00	112 402 762 000	10	0.000 000 000 006 676 337 66
12	1	0.063 146 314 631 463 146 31	1 351 035 564 000	11	0.000 000 000 000 537 657 77
144	2	0.005 075 341 217 270 243 66	16 432 451 210 000	12	0.000 000 000 000 043 136 32
1 750	3	0.000 406 111 564 570 651 77	221 411 634 520 000	13	0.000 000 000 000 003 411 35
23 420	4	0.000 032 155 613 530 704 15	2 657 142 036 440 000	14	0.000 000 000 000 000 264 11
303 240	5	0.000 002 476 132 610 706 64	34 327 724 461 500 000	15	0.000 000 000 000 000 022 01
3 641 100	6	0.000 000 206 157 364 055 37	434 157 115 760 200 000	16	0.000 000 000 000 000 001 63
46 113 200	7	0.000 000 015 327 745 152 75	5 432 127 413 542 400 000	17	0.000 000 000 000 000 000 14
575 360 400	8	0.000 000 001 257 143 561 06	67 405 553 164 731 000 000	18	0.000 000 000 000 000 000 01
7 346 545 000	9	0.000 000 000 104 560 276 41			

n log₁₀ 2, n log₂ 10 IN DECIMAL

Table 28.4

n	n log ₁₀ 2	n log ₂ 10	n	n log ₁₀ 2	n log ₂ 10
1	0.30102 99957	3.32192 80949	6	1.80617 99740	19.93156 85693
2	0.60205 99913	6.64385 61898	7	2.10720 99696	23.25349 66642
3	0.90308 99870	9.96578 42847	8	2.40823 99653	26.57542 47591
4	1.20411 99827	13.28771 23795	9	2.70926 99610	29.89735 28540
5	1.50514 99783	16.60964 04744	10	3.01029 99566	33.21928 09489

ADDITION AND MULTIPLICATION TABLES

Table 28.5

Addition

Multiplication

Binary Scale

$$\begin{aligned} 0 + 0 &= 0 \\ 0 + 1 &= 1 + 0 = 1 \\ 1 + 1 &= 10 \end{aligned}$$

$$\begin{aligned} 0 \times 0 &= 0 \\ 0 \times 1 &= 1 \times 0 = 0 \\ 1 \times 1 &= 1 \end{aligned}$$

Octal Scale

0	01	02	03	04	05	06	07
1	02	03	04	05	06	07	10
2	03	04	05	06	07	10	11
3	04	05	06	07	10	11	12
4	05	06	07	10	11	12	13
5	06	07	10	11	12	13	14
6	07	10	11	12	13	14	15
7	10	11	12	13	14	15	16

MATHEMATICAL CONSTANTS IN OCTAL SCALE

Table 28.6

$\pi = (3.11037 552421)_{(8)}$	$e = (2.55760 521305)_{(8)}$	$\gamma = (0.44742 147707)_{(8)}$
$\pi^{-1} = (0.24276 301556)_{(8)}$	$e^{-1} = (0.27426 530661)_{(8)}$	$\ln \gamma = -(0.43127 233602)_{(8)}$
$\sqrt{\pi} = (1.61337 611067)_{(8)}$	$\sqrt{e} = (1.51411 230704)_{(8)}$	$\log_2 \gamma = -(0.62573 030645)_{(8)}$
$\ln \pi = (1.11206 404435)_{(8)}$	$\log_{10} e = (0.33626 754251)_{(8)}$	$\sqrt{2} = (1.32404 746320)_{(8)}$
$\log_2 \pi = (1.51544 163223)_{(8)}$	$\log_2 e = (1.34252 166245)_{(8)}$	$\ln 2 = (0.54271 027760)_{(8)}$
$\sqrt{10} = (3.12305 407267)_{(8)}$	$\log_2 10 = (3.24464 741136)_{(8)}$	$\ln 10 = (2.23273 067355)_{(8)}$

29. Laplace Transforms

Contents

	Page
29.1. Definition of the Laplace Transform	1020
29.2. Operations for the Laplace Transform	1020
29.3. Table of Laplace Transforms	1021
29.4. Table of Laplace-Stieltjes Transforms	1029
References	1030

29. Laplace Transforms

29.1. Definition of the Laplace Transform

One-dimensional Laplace Transform

29.1.1 $f(s) = \mathcal{L}\{F(t)\} = \int_0^{\infty} e^{-st} F(t) dt$

$F(t)$ is a function of the real variable t and s is a complex variable. $F(t)$ is called the original function and $f(s)$ is called the image function. If the integral in 29.1.1 converges for a real $s = s_0$, i.e.,

$$\lim_{\substack{A \rightarrow 0 \\ B \rightarrow \infty}} \int_A^B e^{-s_0 t} F(t) dt$$

exists, then it converges for all s with $\Re s > s_0$, and the image function is a single valued analytic

function of s in the half-plane $\Re s > s_0$.

Two-dimensional Laplace Transform

29.1.2

$$f(u, v) = \mathcal{L}\{F(x, y)\} = \int_0^{\infty} \int_0^{\infty} e^{-ux - vy} F(x, y) dx dy$$

Definition of the Unit Step Function

29.1.3
$$u(t) = \begin{cases} 0 & (t < 0) \\ \frac{1}{2} & (t = 0) \\ 1 & (t > 0) \end{cases}$$

In the following tables the factor $u(t)$ is to be understood as multiplying the original function $F(t)$.

29.2. Operations for the Laplace Transform¹

	<i>Original Function</i> $F(t)$	<i>Image Function</i> $f(s)$
29.2.1	$F(t)$	$\int_0^{\infty} e^{-st} F(t) dt$
	Inversion Formula	
29.2.2	$\frac{1}{2\pi i} \int_{c-i\infty}^{c+i\infty} e^{ts} f(s) ds$	$f(s)$
	Linearity Property	
29.2.3	$AF(t) + BG(t)$	$Af(s) + Bg(s)$
	Differentiation	
29.2.4	$F'(t)$	$sf(s) - F(+0)$
29.2.5	$F^{(n)}(t)$	$s^n f(s) - s^{n-1} F(+0) - s^{n-2} F'(+0) - \dots - F^{(n-1)}(+0)$
	Integration	
29.2.6	$\int_0^t F(\tau) d\tau$	$\frac{1}{s} f(s)$
29.2.7	$\int_0^t \int_0^\tau F(\lambda) d\lambda d\tau$	$\frac{1}{s^2} f(s)$
	Convolution (Faltung) Theorem	
29.2.8	$\int_0^t F_1(t-\tau) F_2(\tau) d\tau = F_1 * F_2$	$f_1(s) f_2(s)$
	Differentiation	
29.2.9	$-tF(t)$	$f'(s)$
29.2.10	$(-1)^n t^n F(t)$	$f^{(n)}(s)$

¹ Adapted by permission from R. V. Churchill, Operational mathematics, 2d ed., McGraw-Hill Book Co., Inc., New York, N.Y., 1958.

	<i>Original Function F(t)</i>	<i>Image Function f(s)</i>
29.2.11	$\frac{1}{t} F(t)$	Integration $\int_s^\infty f(x) dx$
29.2.12	$e^{at} F(t)$	Linear Transformation $f(s-a)$
29.2.13	$\frac{1}{c} F\left(\frac{t}{c}\right) \quad (c > 0)$	$f(cs)$
29.2.14	$\frac{1}{c} e^{(b/c)t} F\left(\frac{t}{c}\right) \quad (c > 0)$	$f(cs-b)$

Translation

29.2.15	$F(t-b)u(t-b) \quad (b > 0)$	$e^{-bs}f(s)$
----------------	------------------------------	---------------

Periodic Functions

29.2.16	$F(t+a) = F(t)$	$\frac{\int_0^a e^{-st} F(t) dt}{1 - e^{-as}}$
29.2.17	$F(t+a) = -F(t)$	$\frac{\int_0^a e^{-st} F(t) dt}{1 + e^{-as}}$

Half-Wave Rectification of F(t) in 29.2.17

29.2.18	$F(t) \sum_{n=0}^{\infty} (-1)^n u(t-na)$	$\frac{f(s)}{1 - e^{-as}}$
----------------	---	----------------------------

Full-Wave Rectification of F(t) in 29.2.17

29.2.19	$ F(t) $	$f(s) \coth \frac{as}{2}$
----------------	----------	---------------------------

Heaviside Expansion Theorem

29.2.20	$\sum_{n=1}^m \frac{p(a_n)}{q'(a_n)} e^{a_n t}$	$\frac{p(s)}{q(s)}, q(s) = (s-a_1)(s-a_2) \dots (s-a_m)$ $p(s)$ a polynomial of degree $< m$
29.2.21	$e^{at} \sum_{n=1}^r \frac{p^{(r-n)}(a)}{(r-n)! (n-1)!} t^{n-1}$	$\frac{p(s)}{(s-a)^r}$ $p(s)$ a polynomial of degree $< r$

29.3. Table of Laplace Transforms^{2,3}

For a comprehensive table of Laplace and other integral transforms see [29.9]. For a table of two-dimensional Laplace transforms see [29.11].

	$f(s)$	$F(t)$
29.3.1	$\frac{1}{s}$	1
29.3.2	$\frac{1}{s^2}$	t

² The numbers in bold type in the $f(s)$ and $F(t)$ columns indicate the chapters in which the properties of the respective higher mathematical functions are given.

³ Adapted by permission from R. V. Churchill, Operational mathematics, 2d. ed., McGraw-Hill Book Co., Inc., New York, N. Y., 1958.

	$f(s)$		$F(t)$
29.3.3	$\frac{1}{s^n} \quad (n=1, 2, 3, \dots)$		$\frac{t^{n-1}}{(n-1)!}$
29.3.4	$\frac{1}{\sqrt{s}}$		$\frac{1}{\sqrt{\pi t}}$
29.3.5	$s^{-3/2}$		$2\sqrt{t/\pi}$
29.3.6	$s^{-(n+1/2)} \quad (n=1, 2, 3, \dots)$		$\frac{2^n t^{n-1/2}}{1 \cdot 3 \cdot 5 \dots (2n-1) \sqrt{\pi}}$
29.3.7	$\frac{\Gamma(k)}{s^k} \quad (k>0)$	6	t^{k-1}
29.3.8	$\frac{1}{s+a}$		e^{-at}
29.3.9	$\frac{1}{(s+a)^2}$		te^{-at}
29.3.10	$\frac{1}{(s+a)^n} \quad (n=1, 2, 3, \dots)$		$\frac{t^{n-1} e^{-at}}{(n-1)!}$
29.3.11	$\frac{\Gamma(k)}{(s+a)^k} \quad (k>0)$	6	$t^{k-1} e^{-at}$
29.3.12	$\frac{1}{(s+a)(s+b)} \quad (a \neq b)$		$\frac{e^{-at} - e^{-bt}}{b-a}$
29.3.13	$\frac{s}{(s+a)(s+b)} \quad (a \neq b)$		$\frac{ae^{-at} - be^{-bt}}{a-b}$
29.3.14	$\frac{1}{(s+a)(s+b)(s+c)}$		$\frac{(b-c)e^{-at} + (c-a)e^{-bt} + (a-b)e^{-ct}}{(a-b)(b-c)(c-a)}$
	$(a, b, c \text{ distinct constants})$		
29.3.15	$\frac{1}{s^2+a^2}$		$\frac{1}{a} \sin at$
29.3.16	$\frac{s}{s^2+a^2}$		$\cos at$
29.3.17	$\frac{1}{s^2-a^2}$		$\frac{1}{a} \sinh at$
29.3.18	$\frac{s}{s^2-a^2}$		$\cosh at$
29.3.19	$\frac{1}{s(s^2+a^2)}$		$\frac{1}{a^2} (1 - \cos at)$
29.3.20	$\frac{1}{s^2(s^2+a^2)}$		$\frac{1}{a^3} (at - \sin at)$
29.3.21	$\frac{1}{(s^2+a^2)^2}$		$\frac{1}{2a^3} (\sin at - at \cos at)$

	$f(s)$	$F(t)$	
29.3.22	$\frac{s}{(s^2+a^2)^2}$	$\frac{t}{2a} \sin at$	
29.3.23	$\frac{s^2}{(s^2+a^2)^2}$	$\frac{1}{2a} (\sin at + at \cos at)$	
29.3.24	$\frac{s^2-a^2}{(s^2+a^2)^2}$	$t \cos at$	
29.3.25	$\frac{s}{(s^2+a^2)(s^2+b^2)}$ ($a^2 \neq b^2$)	$\frac{\cos at - \cos bt}{b^2 - a^2}$	
29.3.26	$\frac{1}{(s+a)^2 + b^2}$	$\frac{1}{b} e^{-at} \sin bt$	
29.3.27	$\frac{s+a}{(s+a)^2 + b^2}$	$e^{-at} \cos bt$	
29.3.28	$\frac{3a^2}{s^3+a^3}$	$e^{-at} - e^{iat} \left(\cos \frac{at\sqrt{3}}{2} - \sqrt{3} \sin \frac{at\sqrt{3}}{2} \right)$	
29.3.29	$\frac{4a^3}{s^4+4a^4}$	$\sin at \cosh at - \cos at \sinh at$	
29.3.30	$\frac{s}{s^4+4a^4}$	$\frac{1}{2a^2} \sin at \sinh at$	
29.3.31	$\frac{1}{s^4-a^4}$	$\frac{1}{2a^3} (\sinh at - \sin at)$	
29.3.32	$\frac{s}{s^4-a^4}$	$\frac{1}{2a^2} (\cosh at - \cos at)$	
29.3.33	$\frac{8a^3 s^2}{(s^2+a^2)^3}$	$(1+a^2 t^2) \sin at - at \cos at$	
29.3.34	$\frac{1}{s} \left(\frac{s-1}{s} \right)^n$	$L_n(t)$	22
29.3.35	$\frac{s}{(s+a)^{\frac{1}{2}}}$	$\frac{1}{\sqrt{\pi t}} e^{-at} (1-2at)$	
29.3.36	$\sqrt{s+a} - \sqrt{s+b}$	$\frac{1}{2\sqrt{\pi t^3}} (e^{-bt} - e^{-at})$	
29.3.37	$\frac{1}{\sqrt{s+a}}$	$\frac{1}{\sqrt{\pi t}} - ae^{at} \operatorname{erfc} a\sqrt{t}$	7
29.3.38	$\frac{\sqrt{s}}{s-a^2}$	$\frac{1}{\sqrt{\pi t}} + ae^{at} \operatorname{erf} a\sqrt{t}$	7
29.3.39	$\frac{\sqrt{s}}{s+a^2}$	$\frac{1}{\sqrt{\pi t}} - \frac{2a}{\sqrt{\pi}} e^{-a^2 t} \int_0^{a\sqrt{t}} e^{-\lambda^2} d\lambda$	7
29.3.40	$\frac{1}{\sqrt{s}(s-a^2)}$	$\frac{1}{a} e^{at} \operatorname{erf} a\sqrt{t}$	7

	$f(s)$	$F(t)$	
29.3.41	$\frac{1}{\sqrt{s}(s+a^2)}$	$\frac{2}{a\sqrt{\pi}} e^{-a^2 t} \int_0^{a\sqrt{t}} e^{\lambda^2} d\lambda$	7
29.3.42	$\frac{b^2-a^2}{(s-a^2)(b+\sqrt{s})}$	$ea^{2t}[b-a \operatorname{erf} a\sqrt{t}] - be^{b^2 t} \operatorname{erfc} b\sqrt{t}$	7
29.3.43	$\frac{1}{\sqrt{s}(\sqrt{s}+a)}$	$e^{a^2 t} \operatorname{erfc} a\sqrt{t}$	7
29.3.44	$\frac{1}{(s+a)\sqrt{s+b}}$	$\frac{1}{\sqrt{b-a}} e^{-at} \operatorname{erf}(\sqrt{b-a}\sqrt{t})$	7
29.3.45	$\frac{b^2-a^2}{\sqrt{s}(s-a^2)(\sqrt{s}+b)}$	$e^{a^2 t} \left[\frac{b}{a} \operatorname{erf}(a\sqrt{t}) - 1 \right] + e^{b^2 t} \operatorname{erfc} b\sqrt{t}$	7
29.3.46	$\frac{(1-s)^n}{s^{n+\frac{1}{2}}}$	$\frac{n!}{(2n)!\sqrt{\pi t}} H_{2n}(\sqrt{t})$	22
29.3.47	$\frac{(1-s)^n}{s^{n+\frac{1}{2}}}$	$\frac{n!}{(2n+1)!\sqrt{\pi}} H_{2n+1}(\sqrt{t})$	22
29.3.48	$\frac{\sqrt{s+2a}-\sqrt{s}}{\sqrt{s}} - 1$	$ae^{-at}[I_1(at) + I_0(at)]$	9
29.3.49	$\frac{1}{\sqrt{s+a}\sqrt{s+b}}$	$e^{-\frac{1}{2}(a+b)t} I_0\left(\frac{a-b}{2} t\right)$	9
29.3.50	$\frac{\Gamma(k)}{(s+a)^k(s+b)^k} \quad (k>0) \quad 6$	$\sqrt{\pi} \left(\frac{t}{a-b}\right)^{k-\frac{1}{2}} e^{-\frac{1}{2}(a+b)t} I_{k-\frac{1}{2}}\left(\frac{a-b}{2} t\right)$	10
29.3.51	$\frac{1}{(s+a)^{\frac{1}{2}}(s+b)^{\frac{1}{2}}}$	$te^{-\frac{1}{2}(a+b)t} \left[I_0\left(\frac{a-b}{2} t\right) + I_1\left(\frac{a-b}{2} t\right) \right]$	9
29.3.52	$\frac{\sqrt{s+2a}-\sqrt{s}}{\sqrt{s+2a}+\sqrt{s}}$	$\frac{1}{t} e^{-at} I_1(at)$	9
29.3.53	$\frac{(a-b)^k}{(\sqrt{s+a}+\sqrt{s+b})^{2k}} \quad (k>0)$	$\frac{k}{t} e^{-\frac{1}{2}(a+b)t} I_k\left(\frac{a-b}{2} t\right)$	9
29.3.54	$\frac{(\sqrt{s+a}+\sqrt{s})^{-2\nu}}{\sqrt{s}\sqrt{s+a}} \quad (\nu>-1)$	$\frac{1}{a^\nu} e^{-\frac{1}{2}at} I_\nu\left(\frac{1}{2}at\right)$	9
29.3.55	$\frac{1}{\sqrt{s^2+a^2}}$	$J_0(at)$	9
29.3.56	$\frac{(\sqrt{s^2+a^2}-s)^\nu}{\sqrt{s^2+a^2}} \quad (\nu>-1)$	$a^\nu J_\nu(at)$	9
29.3.57	$\frac{1}{(s^2+a^2)^k} \quad (k>0)$	$\frac{\sqrt{\pi}}{\Gamma(k)} \left(\frac{t}{2a}\right)^{k-\frac{1}{2}} J_{k-\frac{1}{2}}(at)$	6, 10

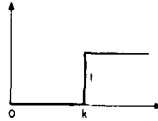
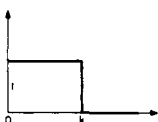
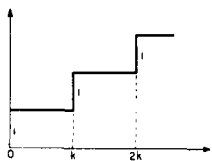
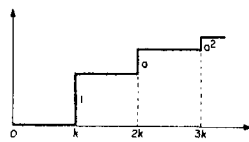
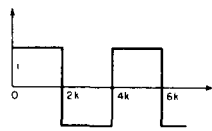
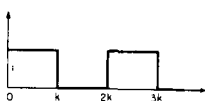
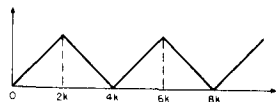
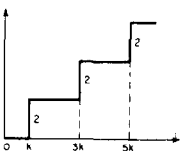
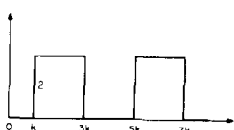
	$f(s)$		$F(t)$	
29.3.58	$(\sqrt{s^2+a^2}-s)^k \quad (k>0)$		$\frac{ka^k}{t} J_k(at)$	9
29.3.59	$\frac{(s-\sqrt{s^2-a^2})^\nu}{\sqrt{s^2-a^2}} \quad (\nu>-1)$		$a^\nu I_\nu(at)$	9
29.3.60	$\frac{1}{(s^2-a^2)^k} \quad (k>0)$		$\frac{\sqrt{\pi}}{\Gamma(k)} \left(\frac{t}{2a}\right)^{k-\frac{1}{2}} I_{k-\frac{1}{2}}(at)$	6, 10
29.3.61	$\frac{1}{s} e^{-ks}$		$u(t-k)$	
29.3.62	$\frac{1}{s^2} e^{-ks}$		$(t-k)u(t-k)$	
29.3.63	$\frac{1}{s^\mu} e^{-ks} \quad (\mu>0)$		$\frac{(t-k)^{\mu-1}}{\Gamma(\mu)} u(t-k)$	
29.3.64	$\frac{1-e^{-ks}}{s}$		$u(t)-u(t-k)$	
29.3.65	$\frac{1}{s(1-e^{-ks})} = \frac{1+\coth \frac{1}{2}ks}{2s}$		$\sum_{n=0}^{\infty} u(t-nk)$	
29.3.66	$\frac{1}{s(e^{ks}-a)}$		$\sum_{n=1}^{\infty} a^{n-1} u(t-nk)$	
29.3.67	$\frac{1}{s} \tanh ks$		$u(t) + 2 \sum_{n=1}^{\infty} (-1)^n u(t-2nk)$	
29.3.68	$\frac{1}{s(1+e^{-ks})}$		$\sum_{n=0}^{\infty} (-1)^n u(t-nk)$	
29.3.69	$\frac{1}{s^2} \tanh ks$		$tu(t) + 2 \sum_{n=1}^{\infty} (-1)^n (t-2nk)u(t-2nk)$	
29.3.70	$\frac{1}{s \sinh ks}$		$2 \sum_{n=0}^{\infty} u[t-(2n+1)k]$	
29.3.71	$\frac{1}{s \cosh ks}$		$2 \sum_{n=0}^{\infty} (-1)^n u[t-(2n+1)k]$	

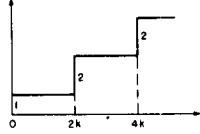
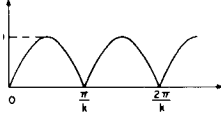
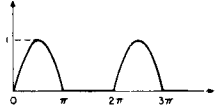
	$f(s)$	$F(t)$	
29.3.72	$\frac{1}{s} \coth ks$	$u(t) + 2 \sum_{n=1}^{\infty} u(t-2nk)$	
29.3.73	$\frac{k}{s^2+k^2} \coth \frac{\pi s}{2k}$	$ \sin kt $	
29.3.74	$\frac{1}{(s^2+1)(1-e^{-\pi s})}$	$\sum_{n=0}^{\infty} (-1)^n u(t-n\pi) \sin t$	
29.3.75	$\frac{1}{s} e^{-\frac{k}{s}}$	$J_0(2\sqrt{kt})$	9
29.3.76	$\frac{1}{\sqrt{s}} e^{-\frac{k}{s}}$	$\frac{1}{\sqrt{\pi t}} \cos 2\sqrt{kt}$	
29.3.77	$\frac{1}{\sqrt{s}} e^{\frac{k}{s}}$	$\frac{1}{\sqrt{\pi t}} \cosh 2\sqrt{kt}$	
29.3.78	$\frac{1}{s^{3/2}} e^{-\frac{k}{s}}$	$\frac{1}{\sqrt{\pi k}} \sin 2\sqrt{kt}$	
29.3.79	$\frac{1}{s^{3/2}} e^{\frac{k}{s}}$	$\frac{1}{\sqrt{\pi k}} \sinh 2\sqrt{kt}$	
29.3.80	$\frac{1}{s^\mu} e^{-\frac{k}{s}} \quad (\mu > 0)$	$\left(\frac{t}{k}\right)^{\frac{\mu-1}{2}} J_{\mu-1}(2\sqrt{kt})$	9
29.3.81	$\frac{1}{s^\mu} e^{\frac{k}{s}} \quad (\mu > 0)$	$\left(\frac{t}{k}\right)^{\frac{\mu-1}{2}} I_{\mu-1}(2\sqrt{kt})$	9
29.3.82	$e^{-k\sqrt{s}} \quad (k > 0)$	$\frac{k}{2\sqrt{\pi t^3}} \exp\left(-\frac{k^2}{4t}\right)$	
29.3.83	$\frac{1}{s} e^{-k\sqrt{s}} \quad (k \geq 0)$	$\operatorname{erfc} \frac{k}{2\sqrt{t}}$	7
29.3.84	$\frac{1}{\sqrt{s}} e^{-k\sqrt{s}} \quad (k \geq 0)$	$\frac{1}{\sqrt{\pi t}} \exp\left(-\frac{k^2}{4t}\right)$	
29.3.85	$\frac{1}{s^3} e^{-k\sqrt{s}} \quad (k \geq 0)$	$2\sqrt{\frac{t}{\pi}} \exp\left(-\frac{k^2}{4t}\right) - k \operatorname{erfc} \frac{k}{2\sqrt{t}} = 2\sqrt{t} i \operatorname{erfc} \frac{k}{2\sqrt{t}}$	7
29.3.86	$\frac{1}{s^{1+i^n}} e^{-k\sqrt{s}} \quad (n=0, 1, 2, \dots; k \geq 0)$	$(4t)^{i^n} i^n \operatorname{erfc} \frac{k}{2\sqrt{t}}$	7
29.3.87	$\frac{n-1}{s^2} e^{-k\sqrt{s}} \quad (n=0, 1, 2, \dots; k > 0)$	$\frac{\exp\left(-\frac{k^2}{4t}\right)}{2^n \sqrt{\pi t^{n+1}}} H_n\left(\frac{k}{2\sqrt{t}}\right)$	22
29.3.88	$\frac{e^{-k\sqrt{s}}}{a+\sqrt{s}} \quad (k \geq 0)$	$\frac{1}{\sqrt{\pi t}} \exp\left(-\frac{k^2}{4t}\right) - a e^{ak} e^{a^2 t} \operatorname{erfc}\left(a\sqrt{t} + \frac{k}{2\sqrt{t}}\right)$	7

*See page II.

	$f(s)$		$F(t)$	
29.3.89	$\frac{ae^{-k\sqrt{s}}}{s(a+\sqrt{s})} \quad (k \geq 0)$		$-e^{ak}e^{a^2t} \operatorname{erfc}\left(a\sqrt{t} + \frac{k}{2\sqrt{t}}\right) + \operatorname{erfc} \frac{k}{2\sqrt{t}}$	7
29.3.90	$\frac{e^{-k\sqrt{s}}}{\sqrt{s}(a+\sqrt{s})} \quad (k \geq 0)$		$e^{ak}e^{a^2t} \operatorname{erfc}\left(a\sqrt{t} + \frac{k}{2\sqrt{t}}\right)$	7
29.3.91	$\frac{e^{-k\sqrt{s(s+a)}}}{\sqrt{s(s+a)}} \quad (k \geq 0)$		$e^{-\frac{1}{2}at} I_0\left(\frac{1}{2}a\sqrt{t^2-k^2}\right)u(t-k)$	9
29.3.92	$\frac{e^{-k\sqrt{s^2+a^2}}}{\sqrt{s^2+a^2}} \quad (k \geq 0)$		$J_0(a\sqrt{t^2-k^2})u(t-k)$	9
29.3.93	$\frac{e^{-k\sqrt{s^2-a^2}}}{\sqrt{s^2-a^2}} \quad (k \geq 0)$		$I_0(a\sqrt{t^2-k^2})u(t-k)$	9
29.3.94	$\frac{e^{-k(\sqrt{s^2+a^2}-s)}}{\sqrt{s^2+a^2}} \quad (k \geq 0)$		$J_0(a\sqrt{t^2+2kt})$	9
29.3.95	$e^{-ks} - e^{-k\sqrt{s^2+a^2}} \quad (k > 0)$		$\frac{ak}{\sqrt{t^2-k^2}} J_1(a\sqrt{t^2-k^2})u(t-k)$	9
29.3.96	$e^{-k\sqrt{s^2-a^2}} - e^{-ks} \quad (k > 0)$		$\frac{ak}{\sqrt{t^2-k^2}} I_1(a\sqrt{t^2-k^2})u(t-k)$	9
29.3.97	$\frac{a^\nu e^{-k\sqrt{s^2+a^2}}}{\sqrt{s^2+a^2}(\sqrt{s^2+a^2}+s)^\nu} \quad (\nu > -1, k \geq 0)$		$\left(\frac{t-k}{t+k}\right)^{\frac{\nu}{2}} J_\nu(a\sqrt{t^2-k^2})u(t-k)$	9
29.3.98	$\frac{1}{s} \ln s$		$-\gamma - \ln t$ ($\gamma = .57721\ 56649 \dots$ Euler's constant)	
29.3.99	$\frac{1}{s^k} \ln s \quad (k > 0)$		$\frac{t^{k-1}}{\Gamma(k)} [\psi(k) - \ln t]$	6
29.3.100	$\frac{\ln s}{s-a} \quad (a > 0)$		$e^{at}[\ln a + E_1(at)]$	5
29.3.101	$\frac{\ln s}{s^2+1}$		$\cos t \operatorname{Si}(t) - \sin t \operatorname{Ci}(t)$	5
29.3.102	$\frac{s \ln s}{s^2+1}$		$-\sin t \operatorname{Si}(t) - \cos t \operatorname{Ci}(t)$	5
29.3.103	$\frac{1}{s} \ln(1+ks) \quad (k > 0)$		$E_1\left(\frac{t}{k}\right)$	5
29.3.104	$\ln \frac{s+a}{s+b}$		$\frac{1}{t} (e^{-bt} - e^{-at})$	
29.3.105	$\frac{1}{s} \ln(1+k^2s^2) \quad (k > 0)$		$-2 \operatorname{Ci}\left(\frac{t}{k}\right)$	5
29.3.106	$\frac{1}{s} \ln(s^2+a^2) \quad (a > 0)$		$2 \ln a - 2 \operatorname{Ci}(at)$	5

	$f(s)$		$F(t)$	
29.3.107	$\frac{1}{s^2} \ln(s^2+a^2) \quad (a>0)$		$\frac{2}{a} [at \ln a + \sin at - at \operatorname{Ci}(at)]$	5
29.3.108	$\ln \frac{s^2+a^2}{s^2}$		$\frac{2}{t} (1 - \cos at)$	
29.3.109	$\ln \frac{s^2-a^2}{s^2}$		$\frac{2}{t} (1 - \cosh at)$	
29.3.110	$\arctan \frac{k}{s}$		$\frac{1}{t} \sin kt$	
29.3.111	$\frac{1}{s} \arctan \frac{k}{s}$		$\operatorname{Si}(kt)$	5
29.3.112	$e^{k^2 s^2} \operatorname{erfc} ks \quad (k>0)$	7	$\frac{1}{k\sqrt{\pi}} \exp\left(-\frac{t^2}{4k^2}\right)$	
29.3.113	$\frac{1}{s} e^{k^2 s^2} \operatorname{erfc} ks \quad (k>0)$	7	$\operatorname{erf} \frac{t}{2k}$	7
29.3.114	$e^{ks} \operatorname{erfc} \sqrt{ks} \quad (k>0)$	7	$\frac{\sqrt{k}}{\pi \sqrt{t(t+k)}}$	
29.3.115	$\frac{1}{\sqrt{s}} \operatorname{erfc} \sqrt{ks} \quad (k \geq 0)$	7	$\frac{1}{\sqrt{\pi t}} u(t-k)$	
29.3.116	$\frac{1}{\sqrt{s}} e^{ks} \operatorname{erfc} \sqrt{ks} \quad (k \geq 0)$	7	$\frac{1}{\sqrt{\pi(t+k)}}$	
29.3.117	$\operatorname{erf} \frac{k}{\sqrt{s}}$	7	$\frac{1}{\pi t} \sin 2k\sqrt{t}$	
29.3.118	$\frac{1}{\sqrt{s}} e^{\frac{k^2}{s}} \operatorname{erfc} \frac{k}{\sqrt{s}}$	7	$\frac{1}{\sqrt{\pi t}} e^{-2k\sqrt{t}}$	
29.3.119	$K_0(ks) \quad (k>0)$	9	$\frac{1}{\sqrt{t^2-k^2}} u(t-k)$	
29.3.120	$K_0(k\sqrt{s}) \quad (k>0)$	9	$\frac{1}{2t} \exp\left(-\frac{k^2}{4t}\right)$	
29.3.121	$\frac{1}{s} e^{ks} K_1(ks) \quad (k>0)$	9	$\frac{1}{k} \sqrt{t(t+2k)}$	
29.3.122	$\frac{1}{\sqrt{s}} K_1(k\sqrt{s}) \quad (k>0)$	9	$\frac{1}{k} \exp\left(-\frac{k^2}{4t}\right)$	
29.3.123	$\frac{1}{\sqrt{s}} e^{\frac{k}{s}} K_0\left(\frac{k}{s}\right) \quad (k>0)$	9	$\frac{2}{\sqrt{\pi t}} K_0(2\sqrt{2kt})$	9
29.3.124	$\pi e^{-ks} I_0(ks) \quad (k>0)$	9	$\frac{1}{\sqrt{t(2k-t)}} [u(t) - u(t-2k)]$	
29.3.125	$e^{-ks} I_1(ks) \quad (k>0)$	9	$\frac{k-t}{\pi k \sqrt{t(2k-t)}} [u(t) - u(t-2k)]$	

	$f(s)$		$F(t)$
29.3.126	$e^{as}E_1(as) \quad (a>0)$	5	$\frac{1}{t+a}$
29.3.127	$\frac{1}{a}-se^{as}E_1(as) \quad (a>0)$	5	$\frac{1}{(t+a)^2}$
29.3.128	$a^{1-n}e^{as}E_n(as) \quad (a>0; n=0, 1, 2, \dots)$	5	$\frac{1}{(t+a)^n}$
29.3.129	$\left[\frac{\pi}{2}-\text{Si}(s)\right] \cos s + \text{Ci}(s) \sin s$	5	$\frac{1}{t^2+1}$

29.4. Table of Laplace-Stieltjes Transforms ⁴

	$\phi(s)$		$\Phi(t)$
29.4.1	$\int_0^\infty e^{-st}d\Phi(t)$		$\Phi(t)$
29.4.2	$e^{-ks} \quad (k>0)$		$u(t-k)$
29.4.3	$\frac{1}{1-e^{-ks}} \quad (k>0)$		$\sum_{n=0}^\infty u(t-nk)$
29.4.4	$\frac{1}{1+e^{-ks}} \quad (k>0)$		$\sum_{n=0}^\infty (-1)^n u(t-nk)$
29.4.5	$\frac{1}{\sinh ks} \quad (k>0)$		$2 \sum_{n=0}^\infty u[t-(2n+1)k]$
29.4.6	$\frac{1}{\cosh ks} \quad (k>0)$		$2 \sum_{n=0}^\infty (-1)^n u[t-(2n+1)k]$
29.4.7	$\tanh ks \quad (k>0)$		$u(t) + 2 \sum_{n=1}^\infty (-1)^n u(t-2nk)$
29.4.8	$\frac{1}{\sinh (ks+a)} \quad (k>0)$		$2 \sum_{n=0}^\infty e^{-(2n+1)a} u[t-(2n+1)k]$
29.4.9	$\frac{e^{-hs}}{\sinh (ks+a)} \quad (k>0, h>0)$		$2 \sum_{n=0}^\infty e^{-(2n+1)a} u[t-h-(2n+1)k]$
29.4.10	$\frac{\sinh (hs+b)}{\sinh (ks+a)} \quad (0<h<k)$		$\sum_{n=0}^\infty e^{-(2n+1)a} \{ e^b u[t+h-(2n+1)k] - e^{-b} u[t-h-(2n+1)k] \}$
29.4.11	$\sum_{n=0}^\infty a_n e^{-k_n s} \quad (0<k_0<k_1<\dots)$		$\sum_{n=0}^\infty a_n u(t-k_n)$

For the definition of the Laplace-Stieltjes transform see [29.7]. In practice, Laplace-Stieltjes transforms are often written as ordinary Laplace transforms involving Dirac's delta function $\delta(t)$. This "function" may formally be considered as

the derivative of the unit step function, $du(t) = \delta(t) dt$, so that $\int_{-\infty}^x du(t) = \int_{-\infty}^x \delta(t) dt = \begin{cases} 0 & (x < 0) \\ 1 & (x > 0). \end{cases}$ The correspondence 29.4.2, for instance, then assumes the form $e^{-ks} = \int_0^\infty e^{-st} \delta(t-k) dt$.

⁴ Adapted by permission from P. M. Morse and H. Feshbach, Methods of theoretical physics, vols. 1, 2, McGraw-Hill Book Co., Inc., New York, N.Y., 1953.

References

Texts

- [29.1] H. S. Carslaw and J. C. Jaeger, *Operational methods in applied mathematics*, 2d ed. (Oxford Univ. Press, London, England, 1948).
- [29.2] R. V. Churchill, *Operational mathematics*, 2d ed. (McGraw-Hill Book Co., Inc., New York, N.Y., Toronto, Canada, London, England, 1958).
- [29.3] G. Doetsch, *Handbuch der Laplace-Transformation*, vols. I-III (Birkhäuser, Basel, Switzerland, 1950; Basel, Switzerland, Stuttgart, Germany, 1955, 1956).
- [29.4] G. Doetsch, *Einführung in Theorie und Anwendung der Laplace-Transformation* (Birkhäuser, Basel, Switzerland, Stuttgart, Germany, 1958).
- [29.5] P. M. Morse and H. Feshbach, *Methods of theoretical physics*, vols. I, II (McGraw-Hill Book Co., Inc., New York, N.Y., Toronto, Canada, London, England, 1953).
- [29.6] B. van der Pol and H. Bremmer, *Operational calculus*, 2d ed. (Cambridge Univ. Press, Cambridge, England, 1955).
- [29.7] D. V. Widder, *The Laplace transform* (Princeton Univ. Press, Princeton, N.J., 1941).

Tables

- [29.8] G. Doetsch, *Guide to the applications of Laplace transforms* (D. Van Nostrand, London, England; Toronto, Canada; New York, N.Y.; Princeton, N.J., 1961).
- [29.9] A. Erdélyi et al., *Tables of integral transforms*, vols. I, II (McGraw-Hill Book Co., Inc., New York, N.Y., Toronto, Canada, London, England, 1954).
- [29.10] W. Magnus and F. Oberhettinger, *Formulas and theorems for the special functions of mathematical physics* (Chelsea Publishing Co., New York, N.Y., 1949).
- [29.11] D. Voelker and G. Doetsch, *Die zweidimensionale Laplace-Transformation* (Birkhäuser, Basel, Switzerland, 1950).

Subject Index

	A	Page		B	Page
Adam's formulas		896	Basic numbers		822
Airy functions	367, 446, 510, 540,	689	Bateman function		510
ascending series for		446	Bernoulli numbers		804
ascending series for integrals of		447	table of		810
asymptotic expansions of		448	Bernoulli polynomials		803
asymptotic expansions of modulus and phase		449	as sums of powers		804
asymptotic forms of integrals of		449	coefficients of		809
asymptotic forms of related functions		450	derivatives of		804
complex zeros and associated values of $Bi(z)$ and			differences of		804
$Bi'(z)$		478	expansions of		804
computation of		454	Fourier expansions of		805
computation of zeros of		454	generating function for		804
definitions		446	inequalities for		805
differential equations	446,	448	integrals involving		805
graphs of		446	multiplication theorem for		804
integral representations of		447	relations with Euler polynomials		806
integrals involving		448	special values of		805
modulus and phase		449	symbolic operations		806
related functions		448	symmetry relations		804
relations between		446	Bessel functions		
representations in terms of Bessel functions		447	as parabolic cylinder functions	692,	697
tables of		475	definite integrals		485
tables of integrals of		478	modified	374,	509
Wronskian for products of		448	notation for		358
Wronskian relations		446	of fractional order		437
zeros and their asymptotic expansions		450	of the first kind	358,	509
Airy functions and their derivatives		446	of the second kind	358,	509
zeros and associated values of		478	of the third kind	358,	510
Airy integrals		447	orthogonality properties of		485
Aitken's δ^2 -process		18	representations in terms of Airy functions		447
Aitken's iteration method		879	spherical	437,	509
Anger's function		498	Bessel functions of half-integer order	437,	497
relation to Weber's function		498	zeros and associated values		467
Antilogarithm		89	zeros of the derivative and associated values		468
Approximate values		14	Bessel functions, integrals	479,	485
Approximation methods		18	asymptotic expansions	480,	482
Aitken's δ^2 -process		18	computation of		488
Newton's method		18	convolution type		485
regula falsi		18	Hankel-Nicholson type		488
successive substitution		18	involving products of		484
Argument		16	polynomial approximations	481,	482
Arithmetic functions		826	recurrence relations	480,	483
table of		840	reduction formulas		483
Arithmetic-geometric mean	571, 577, 578, 580, 598,	601	repeated		482
Arithmetic mean		10	simple		480
Arithmetic progression		10	tables of		492
Associated Legendre functions		331	Weber-Schafheitlin type		487
(see Legendre functions)			Bessel functions $J_\nu(z), Y_\nu(z)$	358, 379, 381,	385
Asymptotic expansions		15	addition theorems for		363

	Page		Page
powers of.....	16	general solution.....	538
roots of.....	17	graphs of.....	539, 541
Confluent hypergeometric functions.....	262,	integral representations of.....	539
298, 300, 362, 377, 486, 503, 686, 691, 695, 780		recurrence relations.....	539
alternative notations for.....	504	series expansions for.....	538
analytic continuation of.....	504	special values of.....	542
asymptotic expansions and limiting forms.....	508	tables of.....	546
Barnes-type contour integrals.....	506	Wronskian relations.....	539
calculation of zeros and turning points of.....	513	Cubic equation, solution of.....	17, 20
computation of.....	511	Cumulants.....	928
connections with Bessel functions.....	506	Cumulative distribution function	
differential properties of.....	506	multivariate.....	927
expansions in series of Bessel functions.....	506	univariate.....	927
general confluent equation.....	505	Cunningham function.....	510
graphing of.....	513	Cylinder functions.....	361
graph of zeros of.....	513		
graphs of.....	514	D	
integral representations of.....	505	Dawson's integral.....	262, 298, 305, 692
Kummer's equation.....	504	graph of.....	297
Kummer's functions.....	504	table of.....	319
Kummer's transformations.....	505	Debye functions.....	998
recurrence relations.....	506	DeMoivre's theorem.....	74, 84
special cases of.....	509	Derivatives.....	11
table of.....	516	of algebraic functions.....	11
table of zeros of.....	535	of circular functions.....	77
Whittaker's equation.....	505	of hyperbolic functions.....	85
Whittaker's functions.....	505	of inverse circular functions.....	82
Wronskian relations.....	505	of inverse hyperbolic functions.....	88
zeros and turning values.....	510	of logarithmic functions.....	69
Conformal mapping.....	642	partial.....	883
Conical functions.....	337	Differences.....	877
Constants		central.....	877
mathematical.....	1	divided.....	877
physical, miscellaneous.....	5	forward.....	877
Continued fractions.....	19, 22, 68, 70,	in terms of derivatives.....	883
75, 81, 85, 88, 229, 258, 263, 298, 363, 932, 941, 944		mean.....	877
Conversion factors		reciprocal.....	878
mathematical.....	1	Differential equations.....	896
physical.....	5	of second order with turning points.....	450
Cornish-Fisher asymptotic expansions.....	935	ordinary first order.....	896
Correlation.....	936	solution by Adam's formulas.....	896
Cosine integral.....	231, 510	by Gill's method.....	896
asymptotic expansions of.....	233	by Milne's method.....	896
computation of.....	233	by point-slope formula.....	896
definitions.....	231	by predictor-corrector methods.....	896
graphs of.....	232	by Runge-Kutta method.....	896
integral representation of.....	232	solution by trapezoidal formula.....	896
integrals involving.....	232	system of.....	897
rational approximations.....	233	Differentiation.....	882
relation to the exponential integral.....	232	Everett's formula.....	883
series expansions for.....	232	Lagrange's formula.....	882
symmetry relations.....	232	Markoff's formula.....	883
tables of.....	238, 243	Differentiation coefficients.....	882
Coulomb wave functions.....	509, 537	table of.....	914
asymptotic behavior of.....	542	Digamma function.....	258
asymptotic expansions of.....	540	(see psi function)	
computation of.....	543	Dilogarithm function.....	1004
differential equation.....	538	Distribution functions.....	927
expansions in terms of Airy functions.....	540	asymptotic expansions of.....	935
expansions in terms of Bessel-Clifford functions.....	539	characteristics of.....	928
expansions in terms of spherical Bessel functions.....	540	continuous.....	927

	Page		Page
Expected value operator.....	928	maxima and minima of.....	329
Exponential function.....	69, 90, 509	rational approximations.....	302
Chebyshev approximation.....	71	relation to spherical Bessel functions.....	301
continued fractions for.....	70	relation to the confluent hypergeometric function.....	301
differentiation formulas.....	71	relation to the error function.....	301
Euler's formula.....	74	series expansion for.....	301
graph of.....	70	symmetry relations.....	301
identities.....	70	table of.....	321, 323
indefinite integrals.....	71	value at infinity.....	301
inequalities for.....	70	Fundamental period parallelogram.....	629
limiting values.....	70		
periodic property of.....	70	G	
polynomial approximations.....	71	Gamma function.....	255, 263
series expansions for.....	69	asymptotic formulas.....	257
tables of.....	116, 140, 219	binomial coefficient.....	256
Exponential integral.....	227, 262, 510	continued fraction for.....	258
asymptotic expansion of.....	231	definite integrals.....	258
computation of.....	233	duplication formula.....	256
continued fraction for.....	229	Euler's formula.....	255
definite integrals.....	230	Euler's infinite product.....	255
derivatives of.....	230	Euler's integral.....	255
graphs of.....	228	fractional values of.....	255
indefinite integrals.....	230	Gauss' multiplication formula.....	256
inequalities for.....	229	graph of.....	255
interrelations.....	228	Hankel's contour integral.....	255
polynomial approximations.....	231	in the complex plane.....	256
rational approximations.....	231	integer values of.....	255
recurrence relations.....	229	Pochhammer's symbol.....	256
relation to incomplete gamma function.....	230	polynomial approximations.....	257
relation to spherical Bessel functions.....	230	power series for.....	256
series expansions for.....	229	recurrence formulas.....	256
tables of.....	238, 243, 245, 248, 249, 251	reflection formula.....	256
		series expansion for $1/\Gamma(z)$	256
F		Stirling's formula.....	257
F -distribution function.....	946	tables of.....	267, 272, 274, 276
approximations to.....	947, 948	triplication formulas.....	256
computation of.....	961	Wallis' formula.....	258
limiting forms.....	947, 948	Gauss series.....	556
non-central.....	947	Gaussian integration.....	887
reflexive relation.....	946	abscissas and weight factors for.....	916
relation to the χ^2 -distribution.....	946	for integrands with a logarithmic singularity.....	920
relation to Student's t -distribution.....	947	of moments.....	921
series expansions for.....	946, 948	Gaussian probability function.....	931
statistical properties of.....	946	Gauss' transformation.....	573
Factorial function.....	255	Gegenbauer polynomials.....	561
(see gamma function)		(see orthogonal polynomials)	
Factorization.....		coefficients for and x^n in terms of.....	794
table of.....	844, 864	graphs of.....	776
Faltung theorem.....	1020	Generalized hypergeometric function.....	362, 377, 556
Filon's quadrature formula.....	890	Generalized Laguerre polynomials.....	771
coefficients for.....	924	(see orthogonal polynomials)	
Floquet's theorem.....	727	Generalized mean.....	10
Fresnel integrals.....	262, 300, 440	Geometric mean.....	10
asymptotic expansions of.....	302	Geometric progression.....	10
auxiliary functions.....	300, 323	Gill's method.....	896
complex zeros of.....	329	Gudermannian.....	77
definition.....	300		
derivatives of.....	301	H	
graph of.....	301	Hankel functions.....	358, 379, 510
integrals involving.....	303	Hankel's contour integral.....	255
interrelations.....	300	Harmonic analysis.....	202, 881

	Page		Page
Harmonic mean.....	10	recurrence formulas.....	263, 944
Haversine.....	78	relation to other functions.....	945
Heaviside expansion theorem.....	1021	relation to the binomial expansion.....	263
Hermite functions.....	509, 691	relation to the χ^2 -distribution.....	944
Hermite integration.....	890	relation to the hypergeometric function.....	263
abscissas and weight factors for.....	924	series expansion for.....	944
Hermite polynomials.....	300, 510, 691, 775	symmetry relation.....	263
(see orthogonal polynomials)		Incomplete gamma function.....	230, 260, 486, 509
coefficients for and x^n in terms of.....	801	as a confluent hypergeometric function.....	262
graph of.....	780	asymptotic expansions of.....	263
values of.....	802	computation of.....	959
Heuman's lambda function.....	595	continued fraction for.....	263
graph of.....	595	definite integrals.....	263
table of.....	622	derivatives and differential equations.....	262
<i>Hh</i> function.....	300, 691	graph of.....	261
Hölder's inequality for integrals.....	11	Pearson's form of.....	262
for sums.....	11	recurrence formulas.....	262
Horner's scheme.....	788	series developments for.....	262
Hyperbolic functions.....	83	special values of.....	262
addition and subtraction of.....	84	table of.....	978
addition formulas for.....	83	Indeterminate forms (L'Hospital's rule).....	13
continued fraction for.....	85	Inequality, Cauchy's.....	11
DeMoivre's theorem.....	84	Chebyshev's.....	11
differentiation formulas.....	85	Hölder's for integrals.....	11
graph of.....	83	Hölder's for sums.....	11
half-angle formulas.....	83	Minkowski's for integrals.....	11
indefinite integrals.....	86	Minkowski's for sums.....	11
infinite products.....	85	Schwarz's.....	11
modulus and phase.....	84	triangle.....	11
multiple angle formulas.....	84	Integral of a bivariate normal distribution over a polygon.....	956
negative angle formulas.....	83	Integrals.....	
periodic properties of.....	83	of circular functions.....	77
products of.....	84	of exponential functions.....	71
real and imaginary parts.....	84	of hyperbolic functions.....	86
relations between.....	83	of inverse circular functions.....	82
relation to circular functions.....	83	of inverse hyperbolic functions.....	88
series expansions for.....	85	of irrational algebraic functions.....	12
tables of.....	213, 219	of logarithmic functions.....	69
Hypergeometric differential equation.....	562	of rational algebraic functions.....	12
solution of.....	563	Integration.....	885
Hypergeometric functions.....	332,	Bode's rule.....	886
335, 336, 362, 377, 487, 555, 779		by parts.....	12
as Legendre functions.....	561	Chebyshev's equal weight formula.....	887
as polynomials.....	561	Euler-Maclaurin summation formula.....	886
as reductions of Riemann's <i>P</i> -function.....	565	Filon's formula.....	890
asymptotic expansions of.....	565	five-point rule for analytic functions.....	887
differentiation formulas.....	557	Gaussian type formulas.....	887
Gauss series.....	556	iterated integrals.....	891
Gauss' relations for contiguous functions.....	557	Lagrange formula.....	886
integral representations.....	558	Lobatto's integration formula.....	888
special cases of.....	561	multidimensional.....	891
special elementary cases.....	556	Newton-Cotes formula.....	886
special values of the argument.....	556	Radau's integration formula.....	888
transformation formulas.....	559	Simpson's rule.....	886
		trapezoidal rule.....	885
I		Interpolation.....	878
Incomplete beta function.....	263, 944	Aitken's iteration method.....	879
approximations to.....	945	Bessel's formula.....	881
asymptotic expansions of.....	945	bivariate.....	882
computation of.....	959	Everett's formula.....	880
continued fraction for.....	944		

	Page		Page
harmonic analysis.....	881	quarter periods.....	569
inverse.....	881	reciprocal parameter.....	573
Lagrange formula.....	878	relations between squares of the functions.....	573
Newton's divided difference formula.....	880	relation to the copolar trio.....	570
Newton's forward difference formula.....	880	relation with Weierstrass functions.....	649
Taylor's expansion.....	880	series expansions in terms of the nome q	575
Thiele's formula.....	881	special arguments.....	571
throwback formulas.....	880	Jacobi's eta function.....	577
trigonometric.....	881	Jacobi's polynomials.....	561, 773
Invariants.....	629	(see orthogonal polynomials)	
tables of.....	680	coefficients for.....	793
Inverse circular functions.....	22, 79, 92	graphs of.....	773, 776
addition and subtraction of.....	80	Jacobi's theta function (see theta functions).....	576
Chebyshev approximations.....	82	Jacobi's zeta function.....	578, 595
continued fractions for.....	81	addition theorem for.....	595
differentiation formulas.....	82	calculation by use of the arithmetic-geometric	
graph of.....	79	mean.....	578
indefinite integrals.....	82	graph of.....	595
logarithmic representation.....	80	Jacobi's imaginary transformation.....	595
negative arguments.....	80	q -series for.....	595
polynomial approximations.....	81	relation to theta functions.....	578, 595
real and imaginary parts.....	80	special values.....	595
relation to inverse hyperbolic functions.....	80	table of.....	619
series expansions for.....	81		
table of.....	203	K	
Inverse hyperbolic functions.....	86, 93	Kelvin functions.....	379, 387, 509
addition and subtraction of.....	87	ascending series for.....	379
continued fractions for.....	88	ascending series for products of.....	381
differentiation formulas.....	88	asymptotic expansions for large arguments.....	381
graphs of.....	86	asymptotic expansions for large zeros.....	383
indefinite integrals.....	88	asymptotic expansions of modulus and phase.....	383
logarithmic representations.....	87	asymptotic expansions of products.....	383
negative arguments.....	87	definitions.....	379
relation to inverse circular functions.....	87	differential equations.....	379
series expansions for.....	88	expansions in series of Bessel functions.....	381
tables of.....	221	graphs of.....	382
J		indefinite integrals.....	380
Jacobian elliptic functions.....	567	modulus and phase.....	382
addition theorems for.....	574	of negative argument.....	380
approximations in terms of circular functions.....	573	polynomial approximations.....	384
approximations in terms of hyperbolic functions.....	574	recurrence relations.....	380
calculation by use of the arithmetic-geometric		recurrence relations for products.....	380
mean.....	571	relations between.....	379
calculation of.....	579, 581	tables of.....	430
change of argument.....	572	uniform asymptotic expansions for large orders.....	384
change of parameter.....	573	zeros of functions of order zero.....	381
classification of.....	570	Kronecker delta.....	822
complex arguments.....	575	Kummer functions.....	504
definitions.....	569	Kummer's transformation of series.....	16
derivatives of.....	574		
double arguments.....	574	L	
graphs of.....	570	Lagrange differentiation formula.....	882
half-arguments.....	574	Lagrange integration coefficients.....	886
integrals.....	575	table of.....	915
integrals of the squares.....	576	Lagrange interpolation coefficients.....	878
Jacobi's imaginary transformation.....	574	table of.....	900
Landen transformation.....	573	Lagrange interpolation formula.....	878
leading terms of series in powers of u	575	Lagrange's expansion.....	14
parameter.....	569	Laguerre integration.....	890
principal terms.....	572	abscissas and weight factors for.....	923

	Page		Page
Laguerre polynomials	509, 510, 773	continued fractions for	68
(see orthogonal polynomials)		definite integrals	69
coefficients for and x^n in terms of	799	differentiation formula	69
graph of	780	graph of	67
values of	800	indefinite integrals	69
Lamé's equation	641	inequalities for	68
Landen's transformation		limiting values	68
ascending	573, 598, 604	mantissa	89
descending	573, 597, 604	polynomial approximations	68
Laplace transforms	1019	series expansions for	68
definition	1020	tables of	95
operations	1020	Logarithmic integral	228, 231, 510
tables of	1021	graph of	231
Laplace-Stieltjes transforms	1029		
tables of	1029	M	
Laplace's equation	17	Markoff's differentiation formula	883
Laplacian	885	Mathematical constants	1
in spherical coordinates	752	in octal scale	1017
Laurent series	635	Mathieu functions	721
Least square approximations	790	asymptotic representations of	740
Legendre functions	332, 362, 377, 561, 774	comparative notation for	744
asymptotic expansions of	335	expansions for small q	730
computation of	339	expansions in terms of parabolic cylinder functions	742
explicit expressions for	333	graphs of	725, 734
graphs of	338, 780	integral equations for	735
integral representations of	335	integral representations of	736
integrals involving	337	joining factors, table of	748
notation for	332	normalization of	732
of negative argument	333	orthogonality properties of	732
of negative degree	333	other properties of	735, 738
of negative order	333	power series in q for periodic solutions	725
recurrence relations	333	proportionality factors	735
relation to elliptic integrals	337	recurrence relations among the coefficients	723
relations between	333	special cases of	728
Rodrigues' formula	334	special values of	740
special values of	334	table of coefficients for	750
summation formulas	335	table of critical values of	748
tables of	342	zeros of	739
trigonometric expansions of	335	Mathieu's equation	722
values on the cut	333	characteristic exponent	727
Wronskian relation	333	generation of	727
Legendre polynomials	332, 486, 773	graphs of	728
(see orthogonal polynomials)		characteristic values	722, 748
coefficients for and x^n in terms of	798	asymptotic expansions of	726
graph of	338, 780	determination of	722
values of	342	graph of	724
Legendre's differential equation	332	power series for	724
solutions of	332	Floquet solutions	727
Leibniz' theorem for		other solutions	730
differentiation of a product	12	relation to spheroidal wave equation	722
differentiation of an integral	11	solutions involving products of Bessel functions	731
Lemniscate constant	658	stability regions of	728
Lemniscatic case	658	Mathieu's modified equation	722
L'Hospital's rule	13	radial solutions of	732
Lobatto integration	888	Maxima	14
abscissas and weight factors for	920	Mean	928
Logarithmic function	67, 89	arithmetic	10
change of base	67, 89	generalized	10
characteristic	89	geometric	10
Chebyshev approximations	69	harmonic	10
common	68, 89		

	Page		Page
Milne's method.....	896	Multinomial coefficients.....	823
Minima.....	14	table of.....	831
Minkowski's inequality for integrals.....	11		N
for sums.....	11	Neumann's polynomial.....	363
Miscellaneous functions.....	997	Neville's notation.....	578
Möbius function.....	826	Neville's theta functions.....	578
Modified Bessel functions, $I_\nu(z)$, $K_\nu(z)$	374	expression as infinite products.....	579
analytic continuation of.....	376	expression as infinite series.....	579
ascending series for.....	375	graphs of.....	578
asymptotic expansions for large arguments.....	377	tables of.....	582
connection with Legendre functions.....	377	Newton coefficients.....	880
derivatives with respect to order.....	377	relation to Lagrange coefficients.....	880
differential equation.....	374	Newton interpolation formula.....	880, 883
formulas for derivatives.....	376	Newton's method of approximation.....	18
generating function and associated series.....	376	Newton-Cotes formula.....	886
graphs of.....	374	None.....	591, 602
in terms of hypergeometric functions.....	377	table of.....	608, 610, 612
integral representations of.....	376	Normal probability density function	
limiting forms for small arguments.....	375	derivatives of.....	933
multiplication theorems for.....	377	Normal probability function.....	931
Neumann series for $K_\nu(z)$	377	asymptotic expansions of.....	932
other differential equations.....	377	bounds for.....	933
polynomial approximations.....	378	computation of.....	953
recurrence relations.....	376	continued fraction for.....	932
relations between.....	375	error curves for.....	933
tables of.....	416	polynomial and rational approximations.....	932
uniform asymptotic expansions for large orders..	378	power series for.....	932
Wronskian relations.....	375	relation to other functions.....	934
zeros of.....	377	values of x for extreme values of $P(x)$ and $Q(x)$..	977
Modified Mathieu functions.....	722	values of x in terms of $P(x)$ and $Q(x)$	976
graphs of.....	734	values of $Z(x)$ in terms of $P(x)$ and $Q(x)$	975
Modified spherical Bessel functions.....	443, 453, 498	Normal probability functions and derivatives.....	933
addition theorems for.....	445	tables of.....	966
ascending series for.....	443	Normal probability integral	
computation of.....	453	repeated integrals of.....	934
definitions.....	443	Number theoretic functions.....	826
degenerate forms.....	445		O
derivatives with respect to order.....	445	Oblate spheroidal coordinates.....	752
differential equation.....	443	Octal scale.....	1017
differentiation formulas.....	444	Octal tables.....	1017
duplication formula.....	445	Operations with series.....	15
formulas of Rayleigh's type.....	445	Orthogonal polynomials.....	771
generating functions for.....	445	as confluent hypergeometric functions.....	780
graphs of.....	444	as hypergeometric functions.....	779
recurrence relations.....	444	as Legendre functions.....	780
representations by elementary functions.....	443	as parabolic cylinder functions.....	780
tables of.....	469	change of interval of orthogonality.....	790
Wronskian relations.....	443	coefficients for.....	793
Modified Struve functions.....	498	definition.....	773
asymptotic expansion for large $ z $	498	differential equations.....	773, 781
computation of.....	499	differential relations.....	783
graph of.....	498	evaluation of.....	788
integral representations of.....	498	explicit expressions for.....	775
integrals.....	498	generating functions for.....	783
power series expansion for.....	498	graphs of.....	773, 776-780
recurrence relations.....	498	inequalities for.....	786
relation to modified spherical Bessel functions..	498	integral representations of.....	784
tables of.....	501	integrals involving.....	785
Modulus.....	16	interrelations.....	777
Moments.....	928		
Multidimensional integration.....	891		

Orthogonal polynomials—Continued	Page		Page
limit relations.....	787	unrestricted.....	825
of a discrete variable.....	788	Pearson's form of the incomplete gamma function..	262
orthogonality relations.....	774	Pentagamma function.....	260
powers of x in terms of.....	793, 794–801	(see polygamma functions)	
recurrence relations, miscellaneous.....	773, 782	Percentage points of the χ^2 -distribution	
recurrence relations with respect to degree n	782	values of χ^2 in terms of Q and ν	984
Rodrigues' formula.....	773, 785	Percentage points of the F -distribution	
special values of.....	777	values of F in terms of Q , ν_1 , ν_2	986
sum formulas.....	785	Percentage points of the t -distribution	
tables of.....	795, 796, 800, 802	values of t in terms of A and ν	990
zeros of.....	787	Planck's radiation function.....	999
		Plane triangles, solution of.....	78, 92
		Pochhammer's symbol.....	256
		Point-slope formula.....	896
		Poisson-Charlier function.....	509
		Poisson distribution.....	959
		table of cumulative sums of.....	978
		Polar form.....	16
		Polygamma functions.....	260
		asymptotic formulas.....	260
		fractional values of.....	260
		integer values of.....	260
		multiplication formula for.....	260
		recurrence formula.....	260
		reflection formula.....	260
		series expansions for.....	260
		tables of.....	267, 271
		Polynomial evaluation.....	788
		Powers	
		computation of.....	19, 90
		general.....	69
		graph of.....	19
		of complex numbers.....	16
		of two.....	1016
		of $x^n/n!$	818
		tables of.....	24
		Predictor-corrector method.....	896
		Primes.....	231
		table of.....	870
		Primitive roots.....	827
		table of.....	864
		Probability density function.....	931
		asymptotic expansion of.....	935
		Probability functions.....	927
		Probability integral.....	262, 691
		of the χ^2 -distribution, table of.....	978
		Progressions	
		arithmetic.....	10
		geometric.....	10
		Prolate spheroidal coordinates.....	752
		Pseudo-lemniscatic case.....	662
		Psi function.....	258, 264
		asymptotic formulas.....	259
		definite integrals.....	259
		duplication formula.....	259
		fractional values of.....	258
		graph of.....	258
		in the complex plane.....	259
		integer values of.....	258
		recurrence formulas.....	258
		reflection formula.....	259
Parabolic cylinder functions $U(a, x)$, $V(a, x)$	300, 509, 685, 780		
asymptotic expansions of.....	689		
computation of.....	697		
connection with Bessel functions.....	692, 697		
connection with confluent hypergeometric functions.....	691		
connection with Hermite polynomials and functions.....	691		
connection with probability integrals and Dawson's integral.....	691		
Darwin's expansions.....	689		
differential equation.....	686		
expansions for a large, x moderate.....	689		
expansions for x large, a moderate.....	689		
expansions in terms of Airy functions.....	689		
integral representations of.....	687		
modulus and phase.....	690		
power series in x for.....	686		
recurrence relations.....	688		
standard solutions.....	687		
table of.....	700		
Wronskian and other relations.....	687		
zeros of.....	696		
Parabolic cylinder functions $W(a, x)$	692		
asymptotic expansions of.....	693		
complex solutions.....	693		
computation of.....	699		
connection with Bessel functions.....	695		
connection with confluent hypergeometric functions.....	695		
Darwin's expansions.....	694		
differential equation.....	686, 692		
expansions for a large, x moderate.....	694		
expansions for x large, a moderate.....	693		
expression in terms of Airy functions.....	693		
integral representations of.....	693		
modulus and phase.....	695		
power series in x for.....	692		
standard solutions.....	692		
table of.....	712		
Wronskian and other relations.....	693		
zeros of.....	696		
Parameter m	589, 602		
table of.....	612		
Partitions.....	825		
into distinct parts.....	825		
tables of.....	831, 836		

	Page		Page
series expansions for	259	Kummer's transformation of	16
tables of	267, 272, 276, 288	Lagrange's expansion	14
zeros of	259	logarithmic	68
Q			
Quadratic equation, solution of	17, 19	operations with	15
Quartic equation, resolution into quadratic factors ..	17, 20	reversion of	16
R			
Radau's integration formula	888	Taylor's	14
Random deviates, generation of	949	trigonometric	74
Random numbers	949	Shifted Chebyshev polynomials	774
methods of generation of	949	(see orthogonal polynomials)	
table of	991	Shifted Legendre polynomials	774
Repeated integrals of the error function	299	(see orthogonal polynomials)	
as a single integral	299	Sievert integral	1000
asymptotic expansion of	300	Simpson's rule	886
definition	299	Sine integral	231, 510
derivatives of	300	asymptotic expansions of	233
differential equation	299	computation of	233
graph of	300	definitions	231
power series for	299	graphs of	232
recurrence relations	299	integral representation of	232
relation to Hermite polynomials	300	integrals	232
relation to parabolic cylinder functions	300	rational approximations	233
relation to the confluent hypergeometric func- tion	300	relation to exponential integral	232
relation to the Hh function	300	series expansions for	232
table of	317	symmetry relations	232
value at zero	300	tables of	238, 243
Representation of numbers	1012	Skewness	928
Reversion of series	16, 882	Spence's integral	1004
Riccati-Bessel functions	445	Spherical Bessel functions	230, 301, 435, 540
definitions	445	addition theorems for	440
differential equation	445	analytic continuation of	439
Wronskian relations	445	ascending series for	437
Riemann zeta function	256, 807	complex zeros of $h_n^{(1)}(z)$, $h_n^{(2)}(z)$	441
special values of	807	computation of	452
Riemann's differential equation	564	cross products of	439
solutions of	564	definitions	437
Riemann's P function	564	degenerate forms	440
transformation formulas	565	derivatives with respect to order	440
Ring functions	336	differential equation	437
Rodrigues' formula	334, 773, 785	differentiation formulas	439
Roots		duplication formula	440
computation of	19, 89	Gegenbauer's generalization for	438
graph of	19	generating functions for	439
of complex numbers	17, 20	graphs of	438
tables of	24, 223	infinite series involving $j_n^2(z)$	440
Runge-Kutta methods	896	limiting values as $z \rightarrow 0$	437
S			
Scales of notation	1011	modulus and phase	439
general conversion methods	1012	Poisson's integral for	438
Schwarz's inequality	11	Rayleigh's formula for	439
Sectoral harmonics	332	recurrence relations	439
Series	14	relation to Fresnel integrals	440
binomial	14	representations by elementary functions	437
Euler-Maclaurin summation formula	16, 22	tables of	457
Euler's transformation of	16, 21	Wronskian relations	437
exponential	69	zeros and their asymptotic expansions	440
		Spherical polynomials (Legendre)	332
		(see orthogonal polynomials)	
		Spherical triangles, solution of	79
		Spheroidal wave functions	751
		asymptotic behavior of	756
		asymptotic expansions of	755

Spheroidal wave functions—Continued	Page		Page
characteristic values for	753, 756	Thiele's interpolation formula	881
differential equations	753	Toroidal functions	336
evaluation of coefficients for	755	Toronto function	509
expansions for	755	Trapezoidal rule	885
joining factors for	757	Triangle inequality	11
normalization of	755	Trigamma function	260
tables of	766	(see polygamma functions)	
table of eigenvalues of	760	Trigonometric functions	71
table of prolate joining factors	769	(see circular functions)	
Stirling numbers	824	Truncated exponential function	70, 262
table of the first kind	833		
table of the second kind	835	U	
Stirling's formula	257	Ultraspherical polynomials	774
Struve's functions	495	(see orthogonal polynomials)	
asymptotic expansions for large orders	498	coefficients for and x^* in terms of	794
asymptotic expansions for large $ z $	497, 498	graphs of	776
computation of	499	Unit step function	1020
differential equation	496		
graphs of	496	V	
integral representations of	496, 498	Variance	928
integrals	497, 498	Variance-ratio distribution function	946
modified	498	(see F -distribution function)	
power series expansion for	496, 498	Vector-addition coefficients	1006
recurrence relations	496, 498		
relation to Weber's function	498	W	
special properties of	497	Wallis' formula	258
tables of	501	Wave equation	
Student's t -distribution	948	in prolate and oblate spheroidal coordinates	752
approximations to	949	Weber's function	498
asymptotic expansion of	949	relation to Anger's function	498
limiting distribution	949	relation to Struve's function	498
non-central	949	Weierstrass elliptic functions	627
series expansions for	948	addition formulas for	635
statistical properties of	948	case $\Delta = 0$	651
Subtabulation	881	computation of	663
Summable series	1005	conformal mapping of	642, 654, 659
Summation of rational series	264	definitions	629
Sums of positive powers	813	derivatives of	640
Sums of powers	804	determination of periods from given invariants	665
Sums of reciprocal powers	807, 811	determination of values at half-periods, etc., from	
Systems of differential equations of first order	897	given periods	664
		differential equation	629, 640
T		discriminant	629
Taylor expansion	880	equianharmonic case	652
Taylor's formula	14	expressing any elliptic function in terms of \mathcal{P} and \mathcal{P}'	651
Tesseral harmonics	332	fundamental period parallelogram	629
Tetrachoric functions	934	fundamental rectangle	630
Tetragamma function	260	homogeneity relations	631
(see polygamma functions)		integrals	641
Theta functions	576	invariants	629
addition of quarter-periods	577	Legendre's relation	634
calculation by use of the arithmetic-geometric mean	577, 580	lemniscatic case	658
expansions in terms of the nome q	576	maps of	642, 654, 659
Jacobi's notation for	577	multiplication formulas	635
logarithmic derivatives of	576	other series involving \mathcal{P} , \mathcal{P}' , ζ	639
logarithms of sum and difference	577	pseudo-lemniscatic case	662
Neville's notation for	578, 582	reduction formulas	631
relations between squares of the functions	576	relation with complete elliptic integrals	649
relation to Jacobi's zeta function	578	relations with Jacobi's elliptic functions	649
relation with Weierstrass elliptic functions	650	relations with theta functions	650

	Page		Page
reversed series for large $ \mathcal{P} , \mathcal{P}' , f $ -----	638	Whittaker functions-----	505
reversed series for small $ \sigma $ -----	640	Wigner coefficients-----	1006
series expansions for-----	635	Z	
special values and relations-----	633	Zeta function	
symbolism-----	629	Jacobi's-----	578
tables of-----	673	Riemann's-----	256, 807

Index of Notations

	Page		Page
$(a)_n = \Gamma(a+n)/\Gamma(a)$ (Pochhammer's symbol).....	256	Ei(x) exponential integral.....	228
$a_r(q)$ characteristic value of Mathieu's equation.....	722	$E_1(z)$ exponential integral.....	228
$A(x) = 2P(x) - 1$ normal probability function.....	931	$E[g(X)]$ expected value operator for the function $g(x)$	928
Ai(z) Airy function.....	446	Ein(z) modified exponential integral.....	228
A.G.M. arithmetic-geometric mean.....	571	E_n Euler number.....	804
am z amplitude of the complex number z.....	16	$E_n(x)$ Euler polynomial.....	804
antilog antilogarithm (\log^{-1}).....	89	$E_n(z)$ exponential integral.....	228
arcsin z, arccos z inverse circular functions.....	79	erf z error function.....	297
arctan z, arccot z.....		erfc z complementary error function.....	297
arcsec z, arccsc z.....		exp $z = e^z$ exponential function.....	69
arcsinh z, arccosh z inverse hyperbolic functions.....	86	exsec A, exsecant A.....	78
arctanh z, arccoth z.....		$f_{r,r}, f_{o,r}$ joining factors for Mathieu functions.....	735
arcsech z, arcsch z.....		$F(a, b; c; z)$ hypergeometric function.....	556
arg z argument of z.....	16	$F(\varphi \setminus \alpha)$ elliptic integral of the first kind.....	589
$b_r(q)$ characteristic value of Mathieu's equation.....	722	$F_L(\eta, \rho)$ Coulomb wave function (regular).....	538
B_n Bernoulli number.....	804	FPP fundamental period parallelogram.....	629
$B_n(x)$ Bernoulli polynomial.....	804	${}_nF_m(a_1, \dots, a_n; b_1, \dots, b_m; z)$ generalized hypergeometric function.....	556
ber _x , bei _x , Kelvin functions.....	379	g_2, g_3 invariants of Weierstrass elliptic functions.....	629
Bi(z) Airy function.....	446	$g_{r,r}, g_{o,r}$ joining factors for Mathieu functions.....	740
cd, sd, nd Jacobian elliptic functions.....	570	$g(x, y, \rho)$ bivariate normal probability function.....	936
c.d.f. cumulative distribution function.....	927	Gi(z) related Airy function.....	448
$ce_r(z, q)$ Mathieu function.....	725	$G_L(\eta, \rho)$ Coulomb wave function (irregular or logarithmic).....	538
cn Jacobian elliptic function.....	569	$G_n(p, q, x)$ Jacobi polynomial.....	774
Cn, Dn, Sn integrals of the squares of Jacobian elliptic functions.....	576	gd(z) Gudermannian.....	77
cs, ds, ns Jacobian elliptic functions.....	570	$h_n^{(3)}(z)$ spherical Bessel function of the third kind.....	437
$C(x)$ Fresnel integral.....	300	hav A haversine A.....	78
$C_n(x)$ Chebyshev polynomial of the second kind.....	774	$H_r(z)$ Struve's function.....	496
$C(x, a)$ generalized Fresnel integral.....	262	Hi(z) related Airy function.....	448
$Ce_r(z, q)$ modified Mathieu function.....	732	$He_n(z)$ Hermite polynomial.....	775
$C_1(z), C_2(z)$ Fresnel integrals.....	300	$H_n^{(3)}(z)$ Bessel function of the third kind (Hankel).....	358
$C_n^{(\omega)}(x)$ ultraspherical (Gegenbauer) polynomial.....	774	$Hh_n(x)$ Hh (probability) function.....	300, 691
Chi(z) hyperbolic cosine integral.....	231	$H_n(x)$ Hermite polynomial.....	775
Ci(z) cosine integral.....	231	$H(m, n, x)$ confluent hypergeometric function.....	695
Cin(z) cosine integral.....	231	$I_r(z)$ modified Bessel function.....	374
Cinh(z) hyperbolic cosine integral.....	231	$\sqrt{\frac{1}{2}\pi/z} I_{n+\frac{1}{2}}(z)$ modified spherical Bessel function of the first kind.....	443
colog cologarithm.....	89	$\sqrt{\frac{1}{2}\pi/z} I_{-n-\frac{1}{2}}(z)$ modified spherical Bessel function of the second kind.....	443
covers A, coversine A.....	78	$I(u, p)$ incomplete gamma function (Pearson's form).....	262
dc, nc, sc Jacobian elliptic functions.....	570	$I_x(a, b)$ incomplete beta function.....	263
dn = $\Delta(\varphi)$ delta amplitude (Jacobian elliptic function).....	569	$\mathcal{I}z$ imaginary part of $z (=y)$	16
$D_r(x)$ parabolic cylinder function (Whittaker's form).....	687	i^r erfc z repeated integral of the error function.....	299
e_1, e_2, e_3 roots of a polynomial (Weierstrass form).....	629	$j_n(z)$ spherical Bessel function of the first kind.....	437
e^z exponential function.....	69	$J_r(z)$ Anger's function.....	498
$e_n(z)$ truncated exponential function.....	262	$J_r(z)$ Bessel function of the first kind.....	358
$E(\varphi \setminus \alpha)$ elliptic integral of the second kind.....	589	k modulus of Jacobian elliptic functions.....	590
$E(a, x)$ parabolic cylinder function.....	693	k' complementary modulus.....	590
$E_r(z)$ Weber's function.....	498	$k_r(z)$ Bateman's function.....	510
$E_r^{(m)}(z)$ Weber parabolic cylinder function.....	509		
$E(m)$ complete elliptic integral of the second kind.....	590		

	Page		Page
$K_1(z)$ repeated integrals of $K_0(z)$	483	$q(n)$ number of partitions into distinct integer summands.....	825
$\sqrt{\frac{1}{2}\pi/z} K_{n+\frac{1}{2}}(z)$ modified spherical Bessel function of the third kind.....	443	$Q_n^*(z)$ associated Legendre function of the second kind.....	332
$K_\nu(z)$ modified Bessel function.....	374	$Q_n(x)$ Legendre function of the second kind.....	334
$K(m)$ complete elliptic integral of the first kind.....	590	$\Re z$ real part of $z(=x)$	16
$\ker x, \text{kei} x$ Kelvin functions.....	379	$R_{mn}^{(p)}(c, \xi)$ radial spheroidal wave function.....	753
$\text{li}(x)$ logarithmic integral.....	228	$S_n^{(m)}$ Stirling number of the first kind.....	824
\lim limit.....	13	$\mathfrak{S}_n^{(m)}$ Stirling number of the second kind.....	824
$\log_a x$ common (Briggs) logarithm.....	68	$\mathfrak{se}_r(z, q)$ Mathieu function.....	725
$\log_a z$ logarithm of z to base a	67	sn Jacobian elliptic function.....	569
$\ln z (= \log_e z)$ natural, Napierian or hyperbolic logarithm.....	68	$S(z)$ Fresnel integral.....	300
$\mathcal{L}\{F(t)\}=f(s)$ Laplace transform.....	1020	$S_1(z), S_2(z)$ Fresnel integrals.....	300
$L(h, k, \rho)$ cumulative bivariate normal probability function.....	936	$\mathfrak{Se}_r(z, q)$ modified Mathieu function.....	733
$L_n(x)$ Laguerre polynomial.....	775	$S(x, a)$ generalized Fresnel integral.....	262
$L_n^{(\alpha)}(x)$ generalized Laguerre polynomial.....	775	$\text{Shi}(z)$ hyperbolic sine integral.....	231
$\mathbf{L}_\nu(z)$ modified Struve function.....	498	$\text{Si}(z)$ sine integral.....	231
$m = \mu_1'$ mean.....	928	$S_n(x)$ Chebyshev polynomial of the first kind.....	774
m parameter (elliptic functions).....	569	$\text{Sih}(z)$ hyperbolic sine integral.....	231
m_1 complementary parameter.....	569	$S_{\nu}^{(p)}(c, \eta)$ angular spheroidal wave function.....	753
$M(a, b, z)$ Kummer's confluent hypergeometric function.....	504	$\text{si}(z)$ sine integral.....	232
$M_c^{(i)}(z, q)$ modified Mathieu function.....	733	$\sin z, \cos z, \tan z$ circular functions.....	71
$M_s^{(i)}(z, q)$ modified Mathieu function.....	733	$\cot z, \sec z, \csc z$	72
$M_{\kappa, \mu}(z)$ Whittaker function.....	505	$\sinh z, \cosh z, \tanh z$ hyperbolic functions.....	83
n characteristic of the elliptic integral of the third kind.....	590	$\coth z, \text{sech} z, \text{csch} z$	83
$O(v_n) = u_n, u_n$ is of the order of v_n (u_n/v_n is bounded).....	15	$T(m, n, r)$ Toronto function.....	509
$o(v_n) = u_n, \lim_{n \rightarrow \infty} \frac{u_n}{v_n} = 0$	259	$T_n(x)$ Chebyshev polynomial of the first kind.....	774
$O_n(z)$ Neumann's polynomial.....	363	$T_n^*(x)$ shifted Chebyshev polynomial of the first kind.....	774
$p(n)$ number of partitions.....	825	$U(a, b, z)$ Kummer's confluent hypergeometric function.....	504
$\mathcal{P}(z)$ Weierstrass elliptic function.....	629	$U_n(x)$ Chebyshev polynomial of the second kind.....	774
$\text{ph } z$ phase of the complex number z	16	$U_n^*(x)$ shifted Chebyshev polynomial of the second kind.....	774
$P(a, x)$ incomplete gamma function.....	260	$U(a, x)$ Weber parabolic cylinder function.....	687
$P(\chi^2 v)$ probability of the χ^2 -distribution.....	262, 940	$\text{vers } A, \text{versine } A$	78
$P_n^*(z)$ associated Legendre function of the first kind.....	332	$V(a, x)$ Weber parabolic cylinder function.....	687
$P(x)$ normal probability function.....	931	$w(z)$ error function.....	297
$P_n(z)$ Legendre function (spherical polynomials).....	333, 774	$W(a, x)$ Weber parabolic cylinder function.....	692
$P_n^*(x)$ shifted Legendre polynomial.....	774	$W_{\kappa, \mu}(z)$ Whittaker function.....	505
$P_n^{(\alpha, \beta)}(x)$ Jacobi polynomial.....	774	$W\{f(x), g(x)\} (= f(x)g'(x) - f'(x)g(x))$ Wronskian relation.....	505
$\text{Pr}\{X \leq x\}$ probability of the event $X \leq x$	927	$[x_0, x_1, \dots, x_k]$ divided difference.....	877
q nome.....	591	$y_n(z)$ spherical Bessel function of the second kind.....	437
$Q(x) = 1 - P(x)$ normal probability function (tail area).....	931	$Y_\nu(z)$ Bessel function of the second kind.....	358
		$Y_n^*(\theta, \varphi)$ surface harmonic of the first kind.....	332
		$Z(x)$ normal probability density function.....	931

Notation — Greek Letters

	Page		Page
α modular angle (elliptic function).....	590	$\Theta(u m)$ Jacobi's theta function.....	577
$\alpha_n(z) = \int_1^\infty t^n e^{-st} dt$	228	κ_n n th cumulant.....	928
$\beta_n(z) = \int_{-1}^1 t^n e^{-st} dt$	228	$\kappa_{mn}^{(p)}$ joining factor for spheroidal wave functions.....	757
$\beta(n) = \sum_{k=0}^\infty (-1)^k (2k+1)^{-n}$	807	$\lambda(n) = \sum_{k=0}^\infty (2k+1)^{-n}$	807
$B_x(a, b)$ incomplete beta function.....	263	λ_{mn} characteristic value of the spheroidal wave equation.....	753
$B(z, w)$ beta function.....	258	$\Lambda_0(\varphi \setminus \alpha)$ Heuman's lambda function.....	595
γ Euler's constant.....	255	$\mu(f_n)$ mean difference.....	877
$\gamma(a, x)$ incomplete gamma function (normalized).....	260	$\mu(n)$ Möbius function.....	826
$\gamma_1 = \frac{\mu_3}{\sigma_3}$ coefficient of skewness.....	928	μ'_n n th central moment.....	928
$\gamma_2 = \frac{\mu_4}{\sigma^4} - 3$ coefficient of excess.....	928	μ''_n n th moment about the origin.....	928
$\Gamma(z)$ gamma function.....	255	$\pi(x)$ number of primes $\leq x$	231
$\Gamma(a, x)$ incomplete gamma function.....	260	$\pi_n(x) = (x-x_0)(x-x_1) \dots (x-x_n)$	878
δ_{ij} Kronecker delta ($=0$ if $i \neq j$; $=1$ if $i=j$).....	822	$\Pi(n; \varphi \setminus \alpha)$ elliptic integral of the third kind.....	590
$\delta_n^*(f_n)$ central difference.....	877	$\Pi(z)$ factorial function.....	255
Δ difference operator.....	822	ρ correlation coefficient.....	936
Δ discriminant of Weierstrass' canonical form.....	629	$\rho_n(x_0, x_1, \dots, x_n)$ reciprocal difference.....	878
$\Delta(f_n)$ forward difference.....	877	$\rho_n(\nu, x)$ Poisson-Charlier function.....	509
Δx absolute error.....	14	σ standard deviation.....	298
$\zeta(x)$ Riemann zeta function.....	807	σ^2 variance.....	928
$\zeta(z)$ Weierstrass zeta function.....	629	$\sigma(z)$ Weierstrass sigma function.....	629
$Z(u m)$ Jacobi's zeta function.....	578	$\sigma_k(n)$ divisor function.....	827
$\eta(n) = \sum_{k=1}^\infty (-1)^{k-1} k^{-n}$	807	$\tau_n(x)$ tetrachoric function.....	934
$\eta_a = \zeta(\omega_a)$ Weierstrass elliptic function.....	631	$\varphi = am$ u , amplitude.....	569
$H(u), H_1(u)$ Jacobi's eta function.....	577	$\varphi(n)$ Euler-Totient function.....	826
$\vartheta_n(z)$ theta function.....	576	$\varphi(t) = E(e^{tX})$ characteristic function of X	928
$\vartheta_s(\epsilon \setminus \alpha), \vartheta_d(\epsilon \setminus \alpha)$, Neville's notation.....	578	$\Phi(a; b; z)$ confluent hypergeometric function.....	504
for		$\psi(z)$ logarithmic derivative of the gamma function.....	258
$\vartheta_n(\epsilon \setminus \alpha), \vartheta_s(\epsilon \setminus \alpha)$ theta functions		$\Psi(a; c; z)$ confluent hypergeometric function.....	504
		ω_a period of Weierstrass elliptic functions.....	629
		$\omega_{\alpha, \mu}(x)$ Cunningham function.....	510

Miscellaneous Notations

	Page		Page
$[a_{ik}]$ determinant.....	19	$\langle x \rangle$ nearest integer to x	222
$[a_i]$ column matrix.....	19	\bar{z} complex conjugate of $z (=x-iy)$	16
∇^n Laplacian operator.....	752	$z=x+iy$ complex number (Cartesian form).....	16
Δ_n^k forward difference operator.....	877	$=re^{i\theta}$ (polar form).....	16
$\frac{\partial}{\partial z}$ partial derivative.....	883	$ z $ absolute value or modulus of z	16
i ($=\sqrt{-1}$).....	70	Σ overall summation.....	822
$\binom{n}{k}$ binomial coefficient.....	10	Σ' restricted summation.....	755
$n!$ factorial function.....	255	$\Sigma \Pi$ sum or product taken over all prime numbers p	807
$(2n)!! = 2 \cdot 4 \cdot 6 \dots (2n) = 2^n n!$	258	$\sum_{d n} \Pi$ sum or product over all positive divisors d of n	826
(m, n) greatest common divisor.....	822	\int Cauchy's principal value of the integral.....	228
$(n, k) = \frac{\Gamma(\frac{1}{2}+n+k)}{k\Gamma(\frac{1}{2}+n-k)}$ (Hankel's symbol).....	437	\approx approximately equal.....	14
$(n; n_1, n_2, \dots, n_m)$ multinomial coefficient.....	823	\sim asymptotically equal.....	15
$[x]$ largest integer $\leq x$	66	$<, >, \leq, \geq$ inequality, inclusion.....	10
		\neq unequal.....	12

**A CATALOGUE OF SELECTED DOVER BOOKS
IN ALL FIELDS OF INTEREST**

**A CATALOGUE OF SELECTED DOVER BOOKS
IN ALL FIELDS OF INTEREST**

AMERICA'S OLD MASTERS, James T. Flexner. Four men emerged unexpectedly from provincial 18th century America to leadership in European art: Benjamin West, J. S. Copley, C. R. Peale, Gilbert Stuart. Brilliant coverage of lives and contributions. Revised, 1967 edition. 69 plates. 365pp. of text.

21806-6 Paperbound \$3.00

FIRST FLOWERS OF OUR WILDERNESS: AMERICAN PAINTING, THE COLONIAL PERIOD, James T. Flexner. Painters, and regional painting traditions from earliest Colonial times up to the emergence of Copley, West and Peale Sr., Foster, Gustavus Hesselius, Feke, John Smibert and many anonymous painters in the primitive manner. Engaging presentation, with 162 illustrations. xxii + 368pp.

22180-6 Paperbound \$3.50

THE LIGHT OF DISTANT SKIES: AMERICAN PAINTING, 1760-1835, James T. Flexner. The great generation of early American painters goes to Europe to learn and to teach: West, Copley, Gilbert Stuart and others. Allston, Trumbull, Morse; also contemporary American painters—primitives, derivatives, academics—who remained in America. 102 illustrations. xiii + 306pp.

22179-2 Paperbound \$3.00

A HISTORY OF THE RISE AND PROGRESS OF THE ARTS OF DESIGN IN THE UNITED STATES, William Dunlap. Much the richest mine of information on early American painters, sculptors, architects, engravers, miniaturists, etc. The only source of information for scores of artists, the major primary source for many others. Unabridged reprint of rare original 1834 edition, with new introduction by James T. Flexner, and 394 new illustrations. Edited by Rita Weiss. 6 $\frac{3}{8}$ x 9 $\frac{3}{8}$.

21695-0, 21696-9, 21697-7 Three volumes, Paperbound \$13.50

EPOCHS OF CHINESE AND JAPANESE ART, Ernest F. Fenollosa. From primitive Chinese art to the 20th century, thorough history, explanation of every important art period and form, including Japanese woodcuts; main stress on China and Japan, but Tibet, Korea also included. Still unexcelled for its detailed, rich coverage of cultural background, aesthetic elements, diffusion studies, particularly of the historical period. 2nd, 1913 edition. 242 illustrations. lii + 439pp. of text.

20364-6, 20365-4 Two volumes, Paperbound \$6.00

THE GENTLE ART OF MAKING ENEMIES, James A. M. Whistler. Greatest wit of his day deflates Oscar Wilde, Ruskin, Swinburne; strikes back at inane critics, exhibitions, art journalism; aesthetics of impressionist revolution in most striking form. Highly readable classic by great painter. Reproduction of edition designed by Whistler. Introduction by Alfred Werner. xxxvi + 334pp.

21875-9 Paperbound \$2.50

CATALOGUE OF DOVER BOOKS

VISUAL ILLUSIONS: THEIR CAUSES, CHARACTERISTICS, AND APPLICATIONS, Matthew Luckiesh. Thorough description and discussion of optical illusion, geometric and perspective, particularly; size and shape distortions, illusions of color, of motion; natural illusions; use of illusion in art and magic, industry, etc. Most useful today with op art, also for classical art. Scores of effects illustrated. Introduction by William H. Ittleson. 100 illustrations. xxi + 252pp.

21530-X Paperbound \$2.00

A HANDBOOK OF ANATOMY FOR ART STUDENTS, Arthur Thomson. Thorough, virtually exhaustive coverage of skeletal structure, musculature, etc. Full text, supplemented by anatomical diagrams and drawings and by photographs of undraped figures. Unique in its comparison of male and female forms, pointing out differences of contour, texture, form. 211 figures, 40 drawings, 86 photographs. xx + 459pp. 5 $\frac{3}{8}$ x 8 $\frac{3}{8}$.

21163-0 Paperbound \$3.50

150 MASTERPIECES OF DRAWING, Selected by Anthony Toney. Full page reproductions of drawings from the early 16th to the end of the 18th century, all beautifully reproduced: Rembrandt, Michelangelo, Dürer, Fragonard, Urs, Graf, Wouwerman, many others. First-rate browsing book, model book for artists. xviii + 150pp. 8 $\frac{3}{8}$ x 11 $\frac{1}{4}$.

21032-4 Paperbound \$2.50

THE LATER WORK OF AUBREY BEARDSLEY, Aubrey Beardsley. Exotic, erotic, ironic masterpieces in full maturity: Comedy Ballet, Venus and Tannhauser, Pierrot, Lysistrata, Rape of the Lock, Savoy material, Ali Baba, Volpone, etc. This material revolutionized the art world, and is still powerful, fresh, brilliant. With *The Early Work*, all Beardsley's finest work. 174 plates, 2 in color. xiv + 176pp. 8 $\frac{1}{8}$ x 11.

21817-1 Paperbound \$3.00

DRAWINGS OF REMBRANDT, Rembrandt van Rijn. Complete reproduction of fabulously rare edition by Lippmann and Hofstede de Groot, completely reedited, updated, improved by Prof. Seymour Slive, Fogg Museum. Portraits, Biblical sketches, landscapes, Oriental types, nudes, episodes from classical mythology—All Rembrandt's fertile genius. Also selection of drawings by his pupils and followers. "Stunning volumes," *Saturday Review*. 550 illustrations. lxxviii + 552pp. 9 $\frac{1}{8}$ x 12 $\frac{1}{4}$.

21485-0, 21486-9 Two volumes, Paperbound \$10.00

THE DISASTERS OF WAR, Francisco Goya. One of the masterpieces of Western civilization—83 etchings that record Goya's shattering, bitter reaction to the Napoleonic war that swept through Spain after the insurrection of 1808 and to war in general. Reprint of the first edition, with three additional plates from Boston's Museum of Fine Arts. All plates facsimile size. Introduction by Philip Hofer, Fogg Museum. v + 97pp. 9 $\frac{3}{8}$ x 8 $\frac{1}{4}$.

21872-4 Paperbound \$2.00

GRAPHIC WORKS OF ODILON REDON. Largest collection of Redon's graphic works ever assembled: 172 lithographs, 28 etchings and engravings, 9 drawings. These include some of his most famous works. All the plates from *Odilon Redon: oeuvre graphique complet*, plus additional plates. New introduction and caption translations by Alfred Werner. 209 illustrations. xxvii + 209pp. 9 $\frac{1}{8}$ x 12 $\frac{1}{4}$.

21966-8 Paperbound \$4.00

CATALOGUE OF DOVER BOOKS

JOHANN SEBASTIAN BACH, Philipp Spitta. One of the great classics of musicology, this definitive analysis of Bach's music (and life) has never been surpassed. Lucid, nontechnical analyses of hundreds of pieces (30 pages devoted to St. Matthew Passion, 26 to B Minor Mass). Also includes major analysis of 18th-century music. 450 musical examples. 40-page musical supplement. Total of xx + 1799pp.

(EUK) 22278-0, 22279-9 Two volumes, Clothbound \$15.00

MOZART AND HIS PIANO CONCERTOS, Cuthbert Girdlestone. The only full-length study of an important area of Mozart's creativity. Provides detailed analyses of all 23 concertos, traces inspirational sources. 417 musical examples. Second edition. 509pp.

(USO) 21271-8 Paperbound \$3.50

THE PERFECT WAGNERITE: A COMMENTARY ON THE NIBLUNG'S RING, George Bernard Shaw. Brilliant and still relevant criticism in remarkable essays on Wagner's Ring cycle, Shaw's ideas on political and social ideology behind the plots, role of Leitmotifs, vocal requisites, etc. Prefaces. xxi + 136pp.

21707-8 Paperbound \$1.50

DON GIOVANNI, W. A. Mozart. Complete libretto, modern English translation; biographies of composer and librettist; accounts of early performances and critical reaction. Lavishly illustrated. All the material you need to understand and appreciate this great work. Dover Opera Guide and Libretto Series; translated and introduced by Ellen Bleiler. 92 illustrations. 209pp.

21134-7 Paperbound \$1.50

HIGH FIDELITY SYSTEMS: A LAYMAN'S GUIDE, Roy F. Allison. All the basic information you need for setting up your own audio system: high fidelity and stereo record players, tape records, F.M. Connections, adjusting tone arm, cartridge, checking needle alignment, positioning speakers, phasing speakers, adjusting hums, trouble-shooting, maintenance, and similar topics. Enlarged 1965 edition. More than 50 charts, diagrams, photos. iv + 91pp.

21514-8 Paperbound \$1.25

REPRODUCTION OF SOUND, Edgar Villchur. Thorough coverage for laymen of high fidelity systems, reproducing systems in general, needles, amplifiers, preamps, loudspeakers, feedback, explaining physical background. "A rare talent for making technicalities vividly comprehensible," R. Darrell, *High Fidelity*. 69 figures. iv + 92pp.

21515-6 Paperbound \$1.00

HEAR ME TALKIN' TO YA: THE STORY OF JAZZ AS TOLD BY THE MEN WHO MADE IT, Nat Shapiro and Nat Hentoff. Louis Armstrong, Fats Waller, Jo Jones, Clarence Williams, Billy Holiday, Duke Ellington, Jelly Roll Morton and dozens of other jazz greats tell how it was in Chicago's South Side, New Orleans, depression Harlem and the modern West Coast as jazz was born and grew. xvi + 429pp.

21726-4 Paperbound \$2.50

FABLES OF AESOP, translated by Sir Roger L'Estrange. A reproduction of the very rare 1931 Paris edition; a selection of the most interesting fables, together with 50 imaginative drawings by Alexander Calder. v + 128pp. 6 1/2 x 9 1/4.

21780-9 Paperbound \$1.25

CATALOGUE OF DOVER BOOKS

ALPHABETS AND ORNAMENTS, Ernst Lehner. Well-known pictorial source for decorative alphabets, script examples, cartouches, frames, decorative title pages, calligraphic initials, borders, similar material. 14th to 19th century, mostly European. Useful in almost any graphic arts designing, varied styles. 750 illustrations. 256pp. 7 x 10. 21905-4 Paperbound \$4.00

PAINTING: A CREATIVE APPROACH, Norman Colquhoun. For the beginner simple guide provides an instructive approach to painting: major stumbling blocks for beginner; overcoming them, technical points; paints and pigments; oil painting; watercolor and other media and color. New section on "plastic" paints. Glossary. Formerly *Paint Your Own Pictures*. 221pp. 22000-1 Paperbound \$1.75

THE ENJOYMENT AND USE OF COLOR, Walter Sargent. Explanation of the relations between colors themselves and between colors in nature and art, including hundreds of little-known facts about color values, intensities, effects of high and low illumination, complementary colors. Many practical hints for painters, references to great masters. 7 color plates, 29 illustrations. x + 274pp. 20944-X Paperbound \$2.75

THE NOTEBOOKS OF LEONARDO DA VINCI, compiled and edited by Jean Paul Richter. 1566 extracts from original manuscripts reveal the full range of Leonardo's versatile genius: all his writings on painting, sculpture, architecture, anatomy, astronomy, geography, topography, physiology, mining, music, etc., in both Italian and English, with 186 plates of manuscript pages and more than 500 additional drawings. Includes studies for the Last Supper, the lost Sforza monument, and other works. Total of xlvii + 866pp. 7 $\frac{7}{8}$ x 10 $\frac{3}{4}$. 22572-0, 22573-9 Two volumes, Paperbound \$10.00

MONTGOMERY WARD CATALOGUE OF 1895. Tea gowns, yards of flannel and pillow-case lace, stereoscopes, books of gospel hymns, the New Improved Singer Sewing Machine, side saddles, milk skimmers, straight-edged razors, high-button shoes, spittoons, and on and on . . . listing some 25,000 items, practically all illustrated. Essential to the shoppers of the 1890's, it is our truest record of the spirit of the period. Unaltered reprint of Issue No. 57, Spring and Summer 1895. Introduction by Boris Emmet. Innumerable illustrations. xiii + 624pp. 8 $\frac{1}{2}$ x 11 $\frac{5}{8}$. 22377-9 Paperbound \$6.95

THE CRYSTAL PALACE EXHIBITION ILLUSTRATED CATALOGUE (LONDON, 1851). One of the wonders of the modern world—the Crystal Palace Exhibition in which all the nations of the civilized world exhibited their achievements in the arts and sciences—presented in an equally important illustrated catalogue. More than 1700 items pictured with accompanying text—ceramics, textiles, cast-iron work, carpets, pianos, sleds, razors, wall-papers, billiard tables, beehives, silverware and hundreds of other artifacts—represent the focal point of Victorian culture in the Western World. Probably the largest collection of Victorian decorative art ever assembled—indispensable for antiquarians and designers. Unabridged republication of the Art-Journal Catalogue of the Great Exhibition of 1851, with all terminal essays. New introduction by John Gloag, F.S.A. xxxiv + 426pp. 9 x 12. 22503-8 Paperbound \$4.50

CATALOGUE OF DOVER BOOKS

DESIGN BY ACCIDENT; A BOOK OF "ACCIDENTAL EFFECTS" FOR ARTISTS AND DESIGNERS, James F. O'Brien. Create your own unique, striking, imaginative effects by "controlled accident" interaction of materials: paints and lacquers, oil and water based paints, splatter, crackling materials, shatter, similar items. Everything you do will be different; first book on this limitless art, so useful to both fine artist and commercial artist. Full instructions. 192 plates showing "accidents," 8 in color. viii + 215pp. 8 $\frac{3}{8}$ x 11 $\frac{1}{4}$. 21942-9 Paperbound \$3.50

THE BOOK OF SIGNS, Rudolf Koch. Famed German type designer draws 493 beautiful symbols: religious, mystical, alchemical, imperial, property marks, runes, etc. Remarkable fusion of traditional and modern. Good for suggestions of timelessness, smartness, modernity. Text. vi + 104pp. 6 $\frac{1}{8}$ x 9 $\frac{1}{4}$. 20162-7 Paperbound \$1.25

HISTORY OF INDIAN AND INDONESIAN ART, Ananda K. Coomaraswamy. An unabridged republication of one of the finest books by a great scholar in Eastern art. Rich in descriptive material, history, social backgrounds; Sunga reliefs, Rajput paintings, Gupta temples, Burmese frescoes, textiles, jewelry, sculpture, etc. 400 photos. viii + 423pp. 6 $\frac{3}{8}$ x 9 $\frac{3}{4}$. 21436-2 Paperbound \$4.00

PRIMITIVE ART, Franz Boas. America's foremost anthropologist surveys textiles, ceramics, woodcarving, basketry, metalwork, etc.; patterns, technology, creation of symbols, style origins. All areas of world, but very full on Northwest Coast Indians. More than 350 illustrations of baskets, boxes, totem poles, weapons, etc. 378 pp. 20025-6 Paperbound \$3.00

THE GENTLEMAN AND CABINET MAKER'S DIRECTOR, Thomas Chippendale. Full reprint (third edition, 1762) of most influential furniture book of all time, by master cabinetmaker. 200 plates, illustrating chairs, sofas, mirrors, tables, cabinets, plus 24 photographs of surviving pieces. Biographical introduction by N. Bienenstock. vi + 249pp. 9 $\frac{7}{8}$ x 12 $\frac{3}{4}$. 21601-2 Paperbound \$4.00

AMERICAN ANTIQUE FURNITURE, Edgar G. Miller, Jr. The basic coverage of all American furniture before 1840. Individual chapters cover type of furniture—clocks, tables, sideboards, etc.—chronologically, with inexhaustible wealth of data. More than 2100 photographs, all identified, commented on. Essential to all early American collectors. Introduction by H. E. Keyes. vi + 1106pp. 7 $\frac{7}{8}$ x 10 $\frac{3}{4}$. 21599-7, 21600-4 Two volumes, Paperbound \$11.00

PENNSYLVANIA DUTCH AMERICAN FOLK ART, Henry J. Kauffman. 279 photos, 28 drawings of tulipware, Fraktur script, painted tinware, toys, flowered furniture, quilts, samplers, hex signs, house interiors, etc. Full descriptive text. Excellent for tourist, rewarding for designer, collector. Map. 146pp. 7 $\frac{7}{8}$ x 10 $\frac{3}{4}$. 21205-X Paperbound \$2.50

EARLY NEW ENGLAND GRAVESTONE RUBBINGS, Edmund V. Gillon, Jr. 43 photographs, 226 carefully reproduced rubbings show heavily symbolic, sometimes macabre early gravestones, up to early 19th century. Remarkable early American primitive art, occasionally strikingly beautiful; always powerful. Text. xxvi + 207pp. 8 $\frac{3}{8}$ x 11 $\frac{1}{4}$. 21380-3 Paperbound \$3.50