

ANTENNA RADIATION PATTERNS

An antenna is used to either transmit or receive electromagnetic waves. It serves as a transducer converting guided waves into free-space waves in the transmitting mode or vice versa in the receiving mode. Antennas, including aeriels, can take many forms according to the radiation mechanism involved and can be divided into different categories. Some common types are wire antennas, aperture antennas, reflector antennas, lens antennas, traveling-wave antennas, frequency-independent antennas, horn antennas, printed and conformal antennas, etc. (see Antennas). When applications require radiation characteristics that cannot be met by a single radiating element, multiple elements are employed. Various configurations are utilized by suitably spacing the elements in one or two dimensions. These configurations, known as *array antennas*, can produce the desired radiation characteristics by appropriately feeding each individual element with different amplitudes and phases, which allows increasing the electrical size of the antenna. Furthermore, antenna arrays combined with signal processing lead to *smart antennas* (switched-beam or adaptive antennas), which offer more degrees of freedom in wireless system design (1). Moreover, active antenna elements or arrays incorporate solid-state components producing effective integrated antenna transmitters or receivers with many applications (see Antennas and Ref. 1).

Regardless of the antenna considered, there are some fundamental figures of merit that describe its performance. The response of an antenna as a function of direction is given by the *antenna pattern*. This pattern commonly consists of a number of lobes; the largest one is called the main lobe, and the others are called sidelobes, minor lobes, or back lobes. If the pattern is measured sufficiently far from the antenna so there is no change in the pattern with distance, the pattern is the so-called *far-field pattern*. Measurements at shorter distances yield *near-field patterns*, which are a function of both angle and distance. The pattern may be expressed in terms of the field intensity (*field pattern*) or in terms of the Poynting vector or radiation intensity (*power pattern*). If the pattern is symmetrical, a simple pattern is sufficient to completely specify the variation of the radiation with angle. Otherwise, a three-dimensional diagram or a contour map is required to show the pattern in its entirety. However, in practice two patterns, perpendicular to each other and to the main-lobe axis, may suffice. These are called the *principal-plane* patterns for the E plane and the H plane, containing the field vectors \mathbf{E} and \mathbf{H} , respectively.

Having established the radiation patterns of an antenna, some important parameters can now be considered, such as radiated power, radiation efficiency, directivity, gain, and antenna polarization. All of them will be considered in detail in this article.

Here scalar quantities are presented in lightface italics, while vector quantities are boldface, e.g., the electric field \mathbf{E} (vector) of magnitude E ($=|\mathbf{E}|$) (scalar). Unit vectors are boldface with a circumflex over the letter; \hat{x} , \hat{y} , \hat{z} and \hat{r} are the unit vectors in the x , y , z , and r directions, respectively. A dot over a symbol means that the quantity is harmonically time-varying or a phasor. For example, taking the electric field, $\dot{\mathbf{E}}$ represents a space vector and time phasor, but \dot{E}_{xx} is a scalar phasor. The relations between them are $\dot{\mathbf{E}} = \hat{x}\dot{E}_x$, where $\dot{E}_x = E_x e^{j\omega t}$.

2 ANTENNA RADIATION PATTERNS

The first section of this article introduces several antenna patterns, giving the necessary definitions and presenting the common types. The field regions of an antenna are also pointed out. The most common reference antennas are the ideal isotropic radiator and the very short dipole. Their fields are used to show the calculation and meaning of the different parameters of antennas covered in this article. The second section begins with a treatment of the Poynting vector and radiation power density, starting from the general case of an electromagnetic wave and extending the definitions to a radiating antenna. After this, radiation performance measures such as the beam solid angle, directivity, and gain of an antenna are defined. In the third section the concepts of wave and antenna polarization are discussed. Finally, in the fourth section, a general case of antenna pattern calculation is considered, and numerical solutions are suggested for radiation patterns that are not available in simple closed-form expressions.

Radiation From Antennas

Radiation Patterns. The radiation pattern of an antenna is generally its most basic requirement, since it determines the spatial distribution of the radiated energy. This is usually the first property of an antenna that is specified, once the operating frequency has been stated. An *antenna radiation pattern*, or *antenna pattern*, is defined as a graphical representation of the radiation properties of the antenna as a function of space coordinates. Since antennas are commonly used as parts of wireless telecommunication systems, the radiation pattern is determined in the far-field region where no change in pattern with distance occurs. Using a spherical coordinate system, shown in Fig. 1, with the antenna at the origin, the radiation properties of the antenna depend only on the angles ϕ and θ along a path or surface of constant radius. A plot of the radiated or received power at a constant radius is called a *power pattern*, while the spatial variation of the electric or magnetic field along a constant radius is called the *amplitude field pattern*. In practice, the necessary information from the complete three-dimensional pattern of an antenna can be obtained by taking a few two-dimensional patterns, according to the complexity of radiation pattern of the specific antenna. For most applications, a number of plots of the pattern as a function of θ for some particular values of ϕ , plus a few plots as a function of ϕ for some particular values of θ , give the needed information.

Antennas usually behave as reciprocal devices. This is very important, since it permits the characterization of the antenna either as a transmitting or as a receiving antenna. For example, radiation patterns are often measured with the test antenna operating in the receive mode. If the antenna is reciprocal, the measured pattern is identical when the antenna is in the transmit mode. If nonreciprocal materials, such as ferrites and active devices, are not present in an antenna, its transmitting and receiving properties are identical.

The radiation fields from a transmitting antenna vary inversely with distance, whereas the variation with observation angles (ϕ , θ) depends on the antenna type. A very simple but basic configuration antenna is the *ideal*, or *very short*, dipole antenna. Since any linear or curved wire antenna may be regarded as being composed of a number of short dipoles connected in series, knowledge of this antenna is useful. So we will use the fields radiated from an ideal antenna to define and understand the properties of radiation patterns. An ideal dipole positioned symmetrically at the origin of the coordinate system and oriented along the z axis is shown in Fig. 1. The pattern of electromagnetic fields, with wavelength λ , around a very short wire antenna of length $L \ll \lambda$, carrying a uniform current $I_0 e^{j\omega t}$, is described by functions of distance, frequency, and angle. Table 1 summarizes the expressions for the fields from a very short dipole antenna as given in Refs. 2 and 3. We have $E_\phi = H_r = H_\theta = 0$ for $r \gg \lambda$ and $L \ll \lambda$. The variables shown in these relations are I_0 = amplitude (peak value in time) of current (A), supposed to be constant along the dipole; L = length of dipole (m); $\omega = 2\pi f$ = radian frequency, where f is the frequency in hertz; t = time (s), $\beta = 2\pi/\lambda$ = phase constant (rad/m) θ = azimuthal angle, (dimensionless); c = velocity of light $\approx 3 \times 10^8$ m/s; λ = wavelength (m); j = complex operator

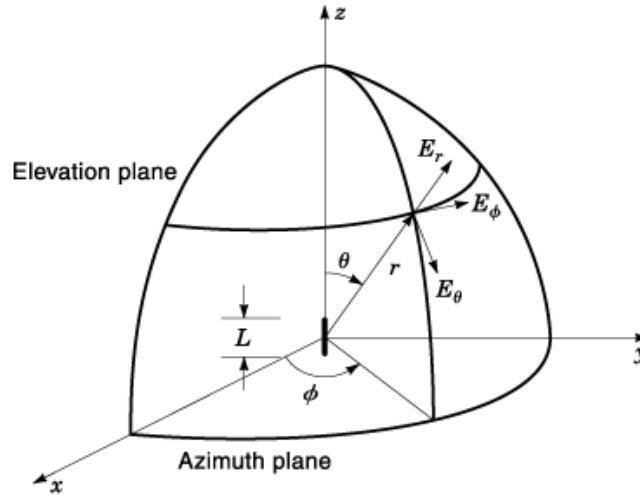

Fig. 1. Spherical coordinate system for antenna analysis. A very short dipole is shown with the directions of its nonzero field components.

Table 1. Fields of an Ideal or Very Short Dipole

Component	General Expression for All Regions	Far Field Only
E_r	$\frac{I_0 L e^{j(\omega t - \beta r)} \cos \theta}{j \omega \epsilon_0 4 \pi r} \left(\frac{2 j \beta}{r} + \frac{2}{r^2} \right)$	0
E_θ	$\frac{I_0 L e^{j(\omega t - \beta r)} \sin \theta}{j \omega \epsilon_0 4 \pi r} \left(\beta^2 - \frac{j \beta}{r} - \frac{1}{r^2} \right)$	$\frac{j(L/\lambda) I_0 e^{j(\omega t - \beta r)} \sin \theta}{2 \epsilon_0 c r}$
H_ϕ	$\frac{I_0 L e^{j(\omega t - \beta r)} \sin \theta}{4 \pi r} \left(j \beta + \frac{1}{r} \right)$	$\frac{j(L/\lambda) I_0 e^{j(\omega t - \beta r)} \sin \theta}{2 r}$

$= \sqrt{-1}$; r = distance from center of dipole to observation point, (m) and ϵ_0 = permittivity of free space = 8.85 pF/m.

Note that E_θ and H_ϕ are in time phase in the far field. Thus, the electric and magnetic fields in the far field of the spherical wave from the dipole are related in the same manner as in a plane traveling wave. Both

4 ANTENNA RADIATION PATTERNS

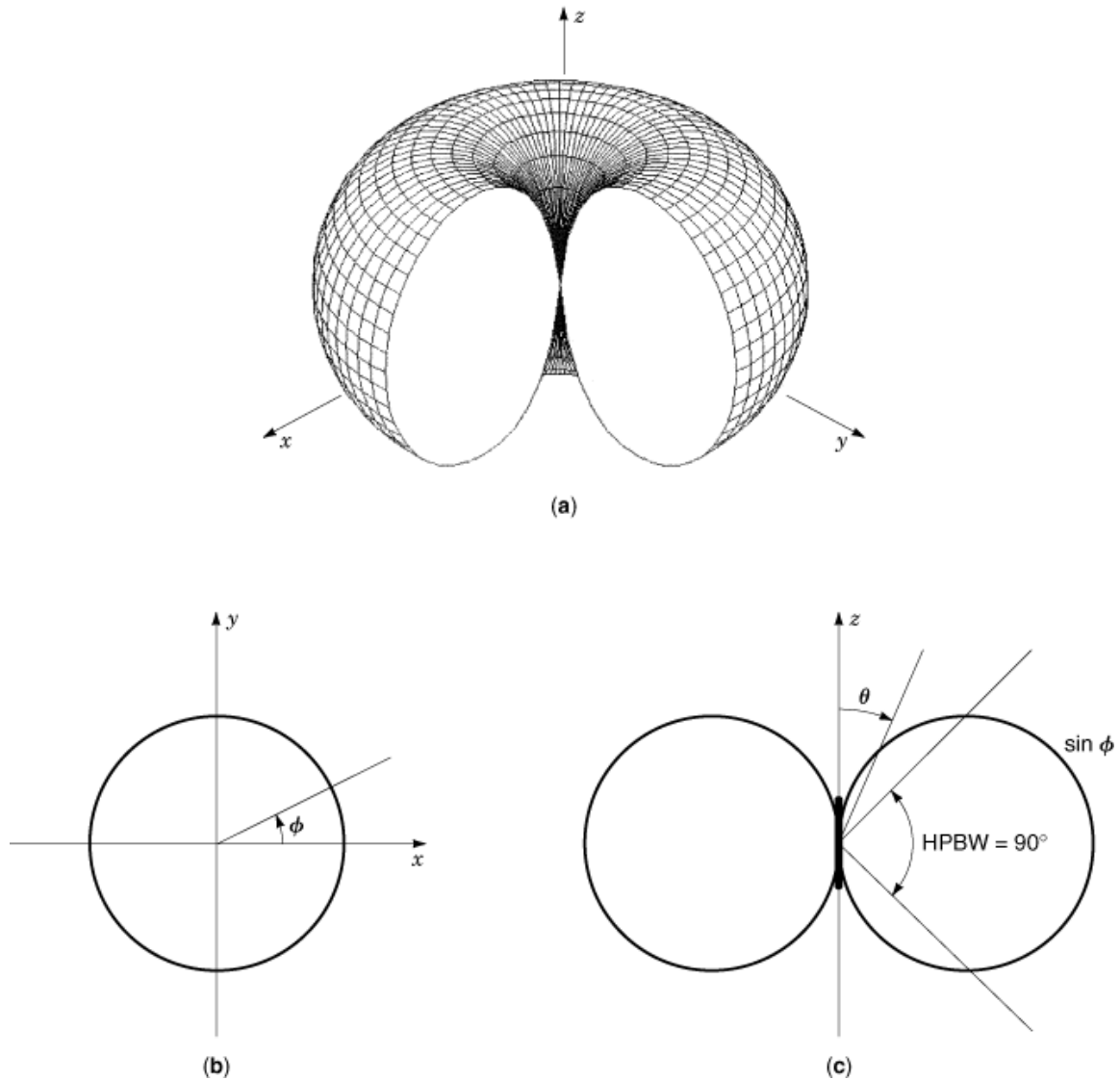

Fig. 2. Radiation field pattern of far field from an ideal (very short) dipole: (a) three-dimensional pattern plot, (b) E -plane radiation-pattern polar plot, and (c) H -plane radiation-pattern polar plot (HPBW, H -plane beamwidth).

are also proportional to $\sin \theta$. That is, both are at a maximum when $\theta = 90^\circ$ and a minimum when $\theta = 0^\circ$ (in the direction of the dipole axis). This variation of E_θ or H_ϕ with angle can be presented by a *field pattern*, shown in Fig. 2, the length r of the radius vector being proportional to the value of the far field (E_θ or H_ϕ) in that direction from the dipole. The pattern in Fig. 2(a) is the three-dimensional far-field pattern for the ideal dipole, while the patterns in Fig. 2(b, c) are two-dimensional and represent cross sections of the three-dimensional pattern, showing the dependence of the fields on the angles θ and ϕ .

All far-field components of a very short dipole are functions of I_0 , the dipole current; L/λ , the dipole length in wavelengths; $1/r$, the distance factor; $j e^{j(\omega t - \beta r)}$, the phase factor; and $\sin \theta$, the pattern factor, which gives

the variation of the field with angle. In general, the expression for the field of any antenna will involve these factors.

For longer antennas with complicated current distribution the field components generally are functions of the above factors, which are grouped into the *element factor* and the *space factor*. The element factor includes everything except the current distribution along the source, which is the space factor of the antenna. For example, consider the case of a finite dipole antenna. The field expressions are produced by dividing the antenna into a number of very short dipoles and summing all their contributions. The element factor is equal to the field of the very short dipole located at a reference point, while the space factor is a function of the current distribution along the source, the latter usually described by an integral. The total field of the antenna is given by the product of the element and space factors. This procedure is known as *pattern multiplication*.

A similar procedure is also employed in array antennas, which are used when directive characteristics are needed. The increased electrical size of an array antenna due to the use of more than one radiating element gives better directivity and special radiation patterns. The total field of an array is determined by the product of the field of a single element and the *array factor* of the array antenna. If we use isotropic radiating elements, the pattern of the array is simply the pattern of the array factor. The array factor is a function of the geometry of the array and the excitation phase. Thus, changing the number of elements, their geometrical arrangement, their relative magnitudes, their relative phases, and their spacing, we obtain different patterns. Figure 3 shows some of characteristic patterns of an array antenna with two isotropic point sources as radiating elements, using different values of the above quantities, which produce different array factors.

Common Types of Radiation Patterns. An *isotropic source* or *radiator* is an ideal antenna that radiates uniformly in all directions in space. Although no practical source has this property, the concept of the isotropic radiator is very useful, and it is often used as a reference for expressing the directive properties of actual antennas. It is worth recalling that the power flux density S at a distance r from an isotropic radiator is $P_t/4\pi r^2$, P_t being the transmitted power, since all the transmitted power is evenly distributed on the surface of a spherical wavefront with radius r . The electric field intensity is calculated as $\sqrt{30P_t}/r$ (using the relation from electric circuits, power = E^2/η , where η is the characteristic impedance of free space, 377 Ω).

On the contrary, a *directional* antenna is one that radiates or receives electromagnetic waves more effectively in some directions than in others. An example of an antenna with a directional radiation pattern is that of an ideal or very short dipole, shown in Fig. 2. It is seen that this pattern, which resembles a doughnut with no hole, is nondirectional in the azimuth plane, which is the xy plane characterized by the set of relations [$f(\phi)$, $\theta = \pi/2$], and directional in the elevation plane, which is any orthogonal plane containing the z axis characterized by [$g(\theta)$, $\phi = \text{constant}$]. This type of directional pattern is called an *omnidirectional* pattern and is defined as one having an essentially nondirectional pattern in a given plane, which for this case is the azimuth plane, and a directional pattern in any orthogonal plane, in this case the elevation plane. The omnidirectional pattern—known also as broadcast-type—is used for many broadcast or communication services where all directions are to be covered equally well. The horizontal-plane pattern is generally circular, while the vertical-plane pattern may have some directivity in order to increase the gain.

Other forms of directional patterns are pencil-beam, fan-beam, and shaped-beam patterns. The *pencil-beam pattern* is a highly directional pattern, which is used when it is desired to obtain maximum gain and when the radiation pattern is to be concentrated in as narrow an angular sector as possible. The beamwidths in the two principal planes are essentially equal. The *fan-beam pattern* is similar to the pencil-beam pattern except that the beam cross section is elliptical in shape rather than circular. The beamwidth in one plane may be considerably broader than in the other plane. As with the pencil-beam pattern, the fan-beam pattern generally implies a rather substantial amount of gain. The *shaped-beam pattern* is used when the pattern in one of the principal planes is desired to have a specified type of coverage. A typical example is the cosecant pattern, which is used to provide a constant radar return over a range of angles in the vertical plane. The

6 ANTENNA RADIATION PATTERNS

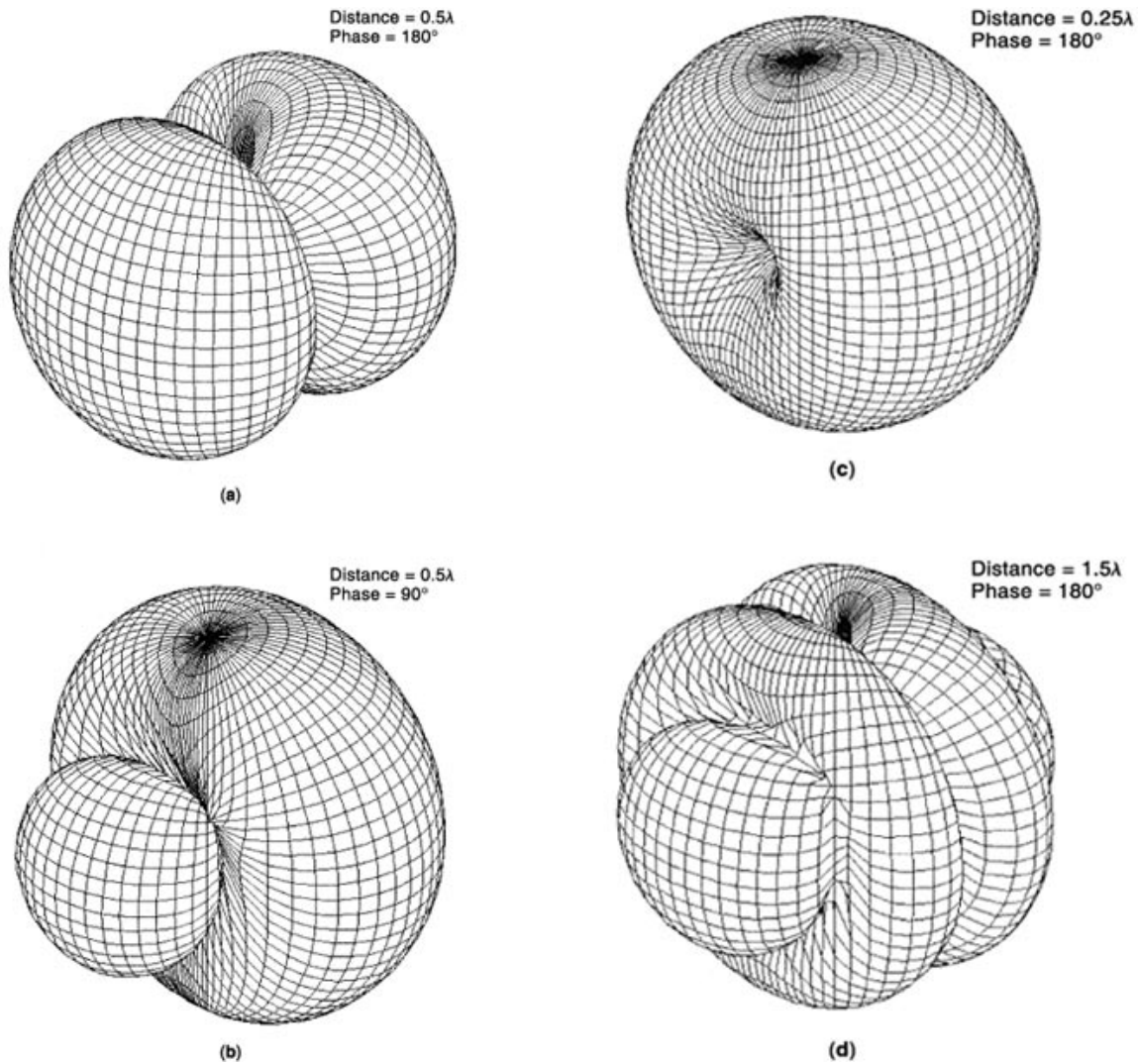

Fig. 3. Three-dimensional graphs of power radiation patterns for an array of two isotropic elements of the same amplitude and (a) opposite phase, spaced 0.5λ apart, (b) phase quadrature, spaced 0.5λ apart, (c) opposite phase, spaced 0.25λ apart, and (d) opposite phase, spaced 1.5λ apart.

pattern in the other principal plane is usually a pencil-beam type, but may sometimes be circular, as in certain types of beacon antennas.

In addition to the above pattern types, there are a number of special shapes used for direction finding and other purposes. These include the well-known figure-of-eight pattern, the cardioid pattern, split-beam patterns, and multilobed patterns whose lobes are of substantially equal amplitude. For such patterns, it is generally necessary to specify the pattern by an actual plot of its shape or by a mathematical relationship.

Antennas are often referred to by the type of pattern they produce. Two terms, which usually characterize array antennas, are broadside and endfire. A *broadside antenna* is one for which the main beam maximum is in a direction normal to the plane containing the antenna. An *endfire antenna* is one for which the main beam

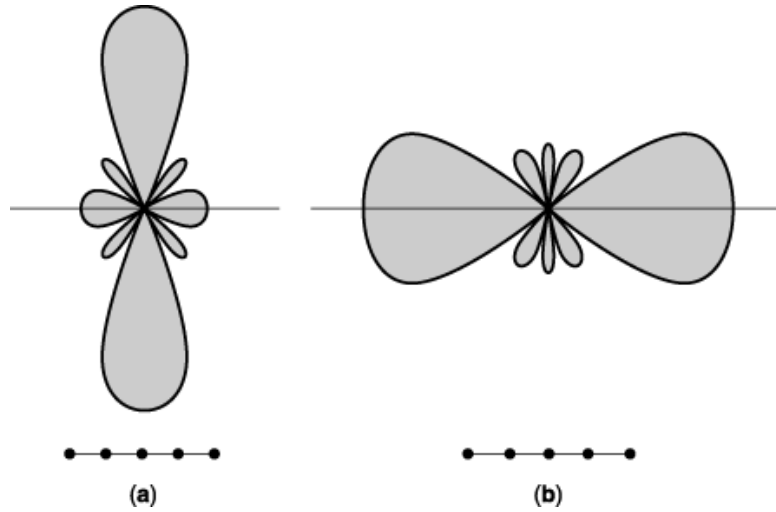

Fig. 4. Polar plots of a linear uniform-amplitude array of five isotropic sources with 0.5-wavelength spacing between the sources: (a) broadside radiation pattern (0° phase shift between successive elements), and (b) endfire radiation pattern (180° phase shift).

is in the plane containing the antenna. For example, the short dipole antenna is a broadside antenna. Figure 4 shows two cases of broadside and endfire radiation patterns, which are produced from a linear uniform array of isotropic sources of 0.5-wavelength spacing between adjacent elements. The type of radiation pattern is controlled by the choice of phase shift between the elements. Zero phase shift produces a broadside pattern, and 180° phase shift (for this case where the spacing between adjacent element is 0.5λ) leads to an endfire pattern, while intermediate values produce radiation patterns with the main lobes between these two cases.

Characteristics of simple patterns. For a linearly polarized antenna, such as a very short dipole antenna, performance is often described in terms of two patterns [Fig. 2(b, c)]. Any plane containing the z axis has the same radiation pattern, since there is no variation in the fields with angle ϕ [Fig. 2(b)]. A pattern taken in one of these planes is called an *E-plane pattern*, because it is parallel to the electric field vector \mathbf{E} and passes through the antenna in the direction of the beam maximum. A pattern taken in a plane orthogonal to an *E* plane and cutting through the short dipole antenna (the xy plane in this case) is called an *H-plane pattern*, because it contains the magnetic field \mathbf{H} and also passes through the antenna in the direction of the beam maximum [Fig. 2(c)]. The *E*- and *H*-plane patterns, in general, are referred to as the *principal-plane patterns*. The pattern plots in Fig. 2(b, c) are called *polar patterns* or *polar diagrams*. For most types of antennas it is a usual practice to orient them so that at least one of the principal-plane patterns coincides with one of the geometrical principal planes. An illustration is shown in Fig. 5, where the principal planes of a microstrip antenna are plotted. The xy plane (azimuthal plane, $\theta = \pi/2$) is the principal *E* plane, and the xz plane (elevation plane, $\phi = 0$) is the principal *H* plane.

A typical antenna power pattern is shown in Fig. 6. In Fig. 6(a), a polar plot on a linear scale is depicted, and in Fig. 6(b), the same pattern is shown in rectangular coordinates in decibels. As can be seen, the radiation pattern of the antenna consists of various parts, which are known as *lobes*. The *main lobe* (or *main beam* or *major lobe*) is defined as the lobe containing the direction of maximum radiation. In Fig. 6(a) the main lobe is pointing in the $\theta = 0$ direction. In some antennas there may exist more than one major lobe. A *minor lobe* is any lobe except the main lobe. Minor lobes comprise sidelobes and back lobes. The term *sidelobe* is sometimes reserved for those minor lobes near the main lobe, but is most often taken to be synonymous with minor lobe. A *back lobe* is a radiation lobe in, approximately, the opposite direction to the main lobe. Minor lobes usually

8 ANTENNA RADIATION PATTERNS

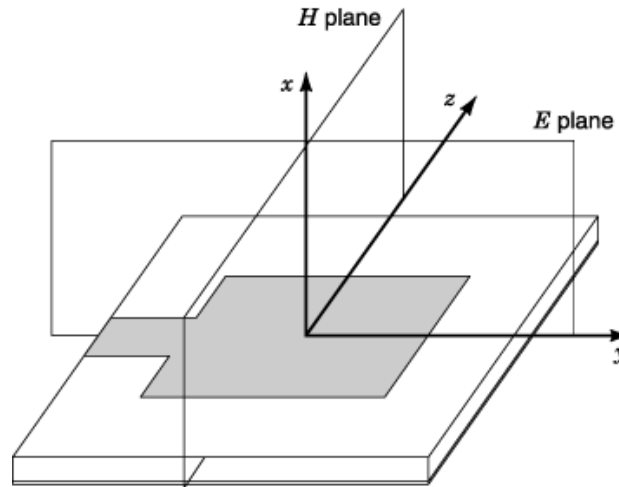

Fig. 5. The principal-plane patterns of a microstrip antenna: the xy plane or E plane (azimuth plane, $\theta = \pi/2$), and the xz plane or H plane (elevation plane, $\phi = 0$).

represent radiation in undesired directions, and they should be minimized. Sidelobes are normally the largest of the minor lobes. The level of side or minor lobes is usually expressed as a ratio of the power density in the lobe in question to that of the main lobe. This ratio is often termed the *sidelobe ratio* or *sidelobe level* and desired values of it depend on the antenna application.

For antennas with simple patterns, the half-power beamwidth and the sidelobe level in the two principal planes specify the important characteristics of the patterns. The *half-power beamwidth* (HPBW) is defined in a plane containing the major maximum beam, as the angular width within which the radiation intensity is at least one-half the maximum value for the beam. The *beamwidth between first nulls* (BWFN) and the beam widths 10 dB or 20 dB below the pattern maximum are also sometimes used. All of them are shown in Fig. 6. However the term *beamwidth* by itself is usually reserved to describe the half-power (3 dB) beamwidth.

The beamwidth of the antenna is a very important figure of merit in the overall design of an antenna application. As the beamwidth of the radiation pattern increases, the sidelobe level decreases, and vice versa. So there is a tradeoff between the sidelobe ratio and beamwidth.

In addition, the beamwidth of the antenna is used to describe the *resolution* of the antenna: its ability to distinguish between two adjacent radiating sources or radar targets. The most common measure of resolution is half the first null beamwidth, which is usually used to approximate the half-power beamwidth. This means that two sources separated by angular distances equal to or greater than the HPBW of an antenna, with a uniform distribution, can be resolved. If the separation is smaller, then the antenna will tend to smooth the two signals into one.

Field Regions of an Antenna. For convenience, the space surrounding a transmitting antenna is divided into several regions, although, obviously, the boundaries of the regions cannot be sharply defined. The names given to the various regions denote some pertinent prominent property of each region.

In free space there are mainly two regions surrounding a transmitting antenna, the *near-field region* and the *far-field region*. The near-field region can be subdivided into two regions, the *reactive near field* and the *radiating near field*.

The first and innermost region, which is immediately adjacent to the antenna, is called the *reactive or induction near-field region*. Of all the regions, it is the smallest. It derives its name from the reactive field, which lies close to every current-carrying conductor. In this region the reactive field, which decreases with either the

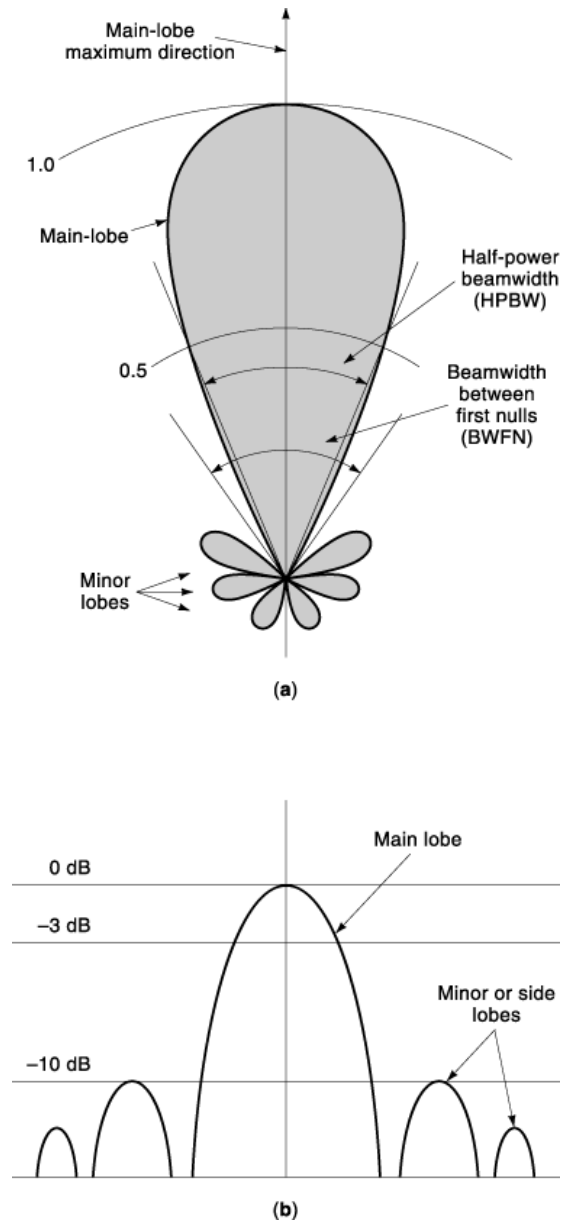

Fig. 6. Antenna power patterns: (a) a typical polar plot on a linear scale, and (b) a plot in rectangular coordinates on a decibel (logarithmic) scale. The associated lobes and beamwidths are also shown.

square or the cube of distance, dominates over all radiated fields, the components of which decrease with the first power of distance. For most antennas, this region is taken to extend over distances $r < 0.62\sqrt{D^3/\lambda}$ from the antenna as long as $D \gg \lambda$, where D is the largest dimension of the antenna and λ is the wavelength (2). For the case of an ideal or very short dipole, for which $D = \Delta z \ll \lambda$, this distance is approximately one-sixth

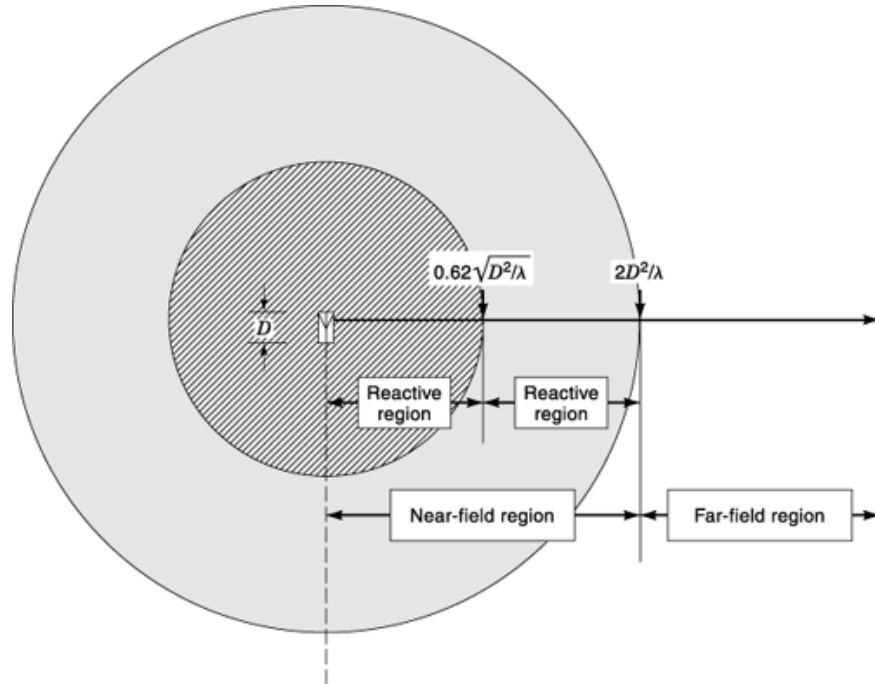

Fig. 7. Field regions of an antenna and some commonly used boundaries.

of a wavelength ($\lambda/2\pi$). At this distance from the very short dipole the reactive and radiation field components are respectively equal in magnitude.

Between the reactive near-field region and far-field regions lies the *radiating near-field region*, which is the region where the radiation fields dominate, but the angular field distribution still depends on the distance from the antenna. For a transmitting antenna focused at infinity, which means that the rays at a large distance from the antenna are parallel, the radiating near-field region is sometimes referred to as the Fresnel region, a term taken from the field of optics. This is taken to be that between the end of reactive near-field region ($r >$

$0.62\sqrt{D^3/\lambda}$) and the starting distance of the far-field region ($r < 2D^2/\lambda$)(2).

The outer boundary of the near-field region lies where the reactive field intensity becomes negligible with respect to the radiation field intensity. This occurs at distances of either a few wavelengths or a few times the major dimension of the antenna, whichever is the larger. The *far-field* or *radiation region* begins at the outer boundary of the near-field region and extends outward indefinitely into free space. In this region the angular distribution of the field is essentially independent of the distance from the antenna. For example, for the case of a very short dipole, the $\sin \theta$ pattern dependence is valid anywhere in this region. The far-field region is commonly taken to be at distances $r > 2D^2/\lambda$ from the antenna, and for an antenna focused at infinity it is sometimes referred to as the Fraunhofer region.

All three regions surrounding an antenna and their boundaries are illustrated in Fig. 7.

Antenna Performance Measures

Poynting Vector and Radiation Power Density. In an electromagnetic wave, energy is stored in equal amounts in the electric and magnetic fields, which together constitute the wave. The power flow is found by making use of the Poynting vector, \mathbf{S} , defined as

$$\mathbf{S} = \mathbf{E} \times \mathbf{H} \quad (1)$$

where \mathbf{E} (V/m) and \mathbf{H} (A/m) are the field vectors. Since the Poynting vector represents a surface power density (W/m^2), the integral of its normal component over a closed surface always gives the total power through the surface. That is,

$$\oint_A \mathbf{S} \cdot d\mathbf{A} = P \quad (2)$$

where P is the total power (W) flowing out of closed surface A , and $d\mathbf{A} = \hat{\mathbf{n}}dA$, $\hat{\mathbf{n}}$ being the unit vector normal to surface. The Poynting vector \mathbf{S} and the power P in the above relations are instantaneous values.

Normally, it is the time-averaged Poynting vector \mathbf{S}_{av} , which represents the average power density, that is of practical interest. It is given by

$$\mathbf{S}_{\text{av}} = \frac{1}{2} \text{Re}(\dot{\mathbf{E}} \times \dot{\mathbf{H}}^*) \quad (\text{W/m}^2) \quad (3)$$

where Re stands for the real part of the complex number and the asterisk denotes the complex conjugate. Note that $\dot{\mathbf{E}}$ and $\dot{\mathbf{H}}$ in Eq. (3) are the electric and magnetic fields written as complex numbers to include the change with time. That is, for a plane wave traveling in the positive z direction with electric and magnetic field components in the x and y directions, respectively, the electric field is $\mathbf{E} = \hat{x}E_{x0}e^{j\omega T}$ while in Eq. (1) it is $\mathbf{E} = \hat{x}E_{x0}$. The factor $\frac{1}{2}$ appears because the fields represent peak values; it should be omitted for rms values.

The average power P_{av} flowing outward through a closed surface can now be obtained by integrating Eq. (3):

$$P_{\text{av}} = \oint_A \text{Re} \dot{\mathbf{S}} \cdot d\mathbf{A} = \frac{1}{2} \oint_A \text{Re}(\dot{\mathbf{E}} \times \dot{\mathbf{H}}^*) \cdot d\mathbf{A} = P_{\text{rad}} \quad (\text{W}) \quad (4)$$

Consider the case that the electromagnetic wave is radiated by an antenna. If the closed surface is taken around the antenna within the far-field region, then this integration results in the average power radiated by the antenna. This is called *radiation power*, P_{rad} , while Eq. (3) represents the *radiation power density*, \mathbf{S}_{av} , of the antenna. The imaginary part of Eq. (3) represents the reactive power density stored in the near field of an antenna. Since the electromagnetic fields of an antenna in its far-field region are predominately real, Eq. (3) is enough for our purposes.

The average power density radiated by the antenna as a function of direction, taken on a large sphere of constant radius in the far-field region, results in the *power pattern* of the antenna.

As an example, for an isotropic radiator, the total radiation power is given by

$$P_{\text{rad}} = \iint_A \mathbf{S}_i \cdot d\mathbf{A} = \int_0^{2\pi} \int_0^\pi [r^2 \mathbf{S}_i(r)] \cdot [\hat{r}^2 \sin\theta d\theta d\phi] = 4\pi r^2 \mathbf{S}_i \quad (5)$$

12 ANTENNA RADIATION PATTERNS

Here, because of symmetry, the Poynting vector $\mathbf{S}_i = \hat{r} S_i(r)$ is taken independent of the spherical coordinate angles θ and ϕ , having only a radial component.

From Eq. (5) the power density can be found:

$$\mathbf{S}_i = r\mathbf{S}_i = \hat{r} \left(\frac{P_{\text{rad}}}{4\pi r^2} \right) \quad (\text{W/m}^2) \quad (6)$$

The above result can also be reached if we assume that the radiated power expands radially in all directions with the same velocity and is evenly distributed on the surface of a spherical wavefront of radius r .

As we will see later, an electromagnetic wave may have an electric field consisting of two orthogonal linear components of different amplitudes, E_{x0} and E_{y0} , respectively, and a phase angle between them, δ . Thus, the total electric field vector, called an elliptically polarized vector, becomes

$$\dot{\mathbf{E}} = \hat{x}\dot{E}_x + \hat{y}\dot{E}_y = \hat{x}E_{x0}e^{j(\omega t - \beta z)} + \hat{y}E_{y0}e^{j(\omega t - \beta z + \delta)} \quad (7)$$

which at $z = 0$ becomes

$$\dot{\mathbf{E}} = \hat{x}\dot{E}_x + \hat{y}\dot{E}_y = \hat{x}E_{x0}e^{j\omega t} + \hat{y}E_{y0}e^{j(\omega t + \delta)} \quad (8)$$

So $\dot{\mathbf{E}}$ is a complex vector (phasor-vector), which is resolvable into two components $\hat{x}\dot{E}_x$ and $\hat{y}\dot{E}_y$. The total $\dot{\mathbf{H}}$ vector associated with $\dot{\mathbf{E}}$, at $z = 0$, is then

$$\dot{\mathbf{H}} = \hat{y}\dot{H}_y - \hat{x}\dot{H}_x = \hat{y}H_{y0}e^{j(\omega t - \zeta)} - \hat{x}H_{x0}e^{j(\omega t + \delta - \zeta)} \quad (9)$$

where ζ is the phase lag of $\dot{\mathbf{H}}$, with respect to \dot{E}_x . From Eq. (9) the complex conjugate magnetic field can be found changing only the signs of exponents.

Now the average Poynting vector can be calculated using the above fields:

$$\begin{aligned} \mathbf{S}_{\text{av}} &= \frac{1}{2} \text{Re} [(\hat{x} \times \hat{y}) \dot{E}_x \dot{H}_y^* - (\hat{y} \times \hat{x}) \dot{E}_y \dot{H}_x^*] \\ &= \frac{1}{2} \hat{z} \text{Re} (\dot{E}_x \dot{H}_y^* + \dot{E}_y \dot{H}_x^*) \\ &= \frac{1}{2} \hat{z} \text{Re} (E_{x0} H_{y0} + E_{y0} H_{x0}) \cos \zeta \end{aligned} \quad (10)$$

It should be noted that \mathbf{S}_{av} is independent of δ , the phase angle between the electric field components.

In a lossless medium $\zeta = 0$, because the electric and magnetic fields are in time phase and $E_{x0}/H_{x0} = E_{y0}/H_{y0} = \eta$, where η is the intrinsic impedance of the medium, which is real. If $E = \sqrt{E_{x0}^2 + E_{y0}^2}$ and $H = \sqrt{H_{x0}^2 + H_{y0}^2}$

are the amplitudes of the total \mathbf{E} and \mathbf{H} fields respectively, then

$$\begin{aligned} \mathbf{S}_{\text{av}} &= \frac{1}{2} \hat{\mathbf{z}} \frac{E_{x0}^2 + E_{y0}^2}{\eta} = \frac{1}{2} \hat{\mathbf{z}} \frac{E^2}{\eta} \\ &= \frac{1}{2} \hat{\mathbf{z}} (H_{x0}^2 + H_{y0}^2) \eta = \frac{1}{2} \hat{\mathbf{z}} H^2 \eta \end{aligned} \quad (11)$$

The above expressions are the most general form of radiation power density of an elliptically polarized wave or of an elliptically polarized antenna, respectively, and hold for all cases, including the linear and circular polarization cases, that we will introduce later on.

Radiation Intensity. Radiation intensity is a far-field parameter, in terms of which any antenna radiation power pattern can be determined. Thus, the antenna power pattern, as a function of angle, can be expressed in terms of its radiation intensity as (2,3)

$$\begin{aligned} U(\theta, \phi) &= S_{\text{av}} r^2 \\ &= \frac{r^2}{2\eta} |\mathbf{E}(r, \theta, \phi)|^2 \\ &= \frac{r^2}{2\eta} [|E_\theta(r, \theta, \phi)|^2 + |E_\phi(r, \theta, \phi)|^2] \\ &\approx \frac{1}{2\eta} [|E_\theta(\theta, \phi)|^2 + |E_\phi(\theta, \phi)|^2] \end{aligned} \quad (12)$$

where

- $U(\theta, \phi)$ = radiation intensity (W/unit solid angle)
- S_{av} = radiation density, or radial component of Poynting vector (W/m^2)
- $E(r, \theta, \phi)$ = total transverse electric field (V/m)
- $H(r, \theta, \phi)$ = total transverse magnetic field (A/m)
- r = distance from antenna to point of measurement (m)
- η = intrinsic impedance of medium (Ω/square)

In Eq. (12) the electric and magnetic fields are expressed in spherical coordinates.

What makes radiation intensity important is that it is independent of distance. This is because in the far field the Poynting vector is entirely radial, which means the fields are entirely transverse and E and H vary as $1/r$.

Since the radiation intensity is a function of angle, it can also be defined as the power radiated from an antenna per unit solid angle. The unit of solid angle is the *steradian*, defined as the solid angle with its vertex at the center of a sphere of radius r that is subtended by an area on the sphere equal to r^2 . But the area of a sphere of radius r is given by $A = 4\pi r^2$, so in the whole sphere there are $4\pi r^2/r^2 = 4\pi$ sr. For a sphere of radius r , an infinitesimal area dA on the surface of it can be written as

$$dA = r^2 \sin \theta d\theta d\phi \quad (\text{m}^2) \quad (13)$$

14 ANTENNA RADIATION PATTERNS

and therefore the element of solid angle $d\Omega$ of a sphere is given by

$$d\Omega = \frac{dA}{r^2} = \sin \theta d\theta d\phi \quad (\text{sr}) \quad (14)$$

Thus, the total power can be obtained by integrating the radiation intensity, as given by Eq. (12), over the entire solid angle of 4π as

$$P_{\text{rad}} = \oint_{\Omega} U(\theta, \phi) d\Omega = \int_0^{2\pi} \int_0^{\pi} U(\theta, \phi) \sin \theta d\theta d\phi \quad (15)$$

As an example, for the isotropic radiator ideal antenna, the radiation intensity $U(\theta, \phi)$ will be independent of the angles θ and ϕ , and the total radiated power will be

$$P_{\text{rad}} = \oint_{\Omega} U_i d\Omega = U_i \int_0^{2\pi} \int_0^{\pi} \sin \theta d\theta d\phi = U_i \oint_{\Omega} d\Omega = 4\pi U_i \quad (16)$$

or $U_i = P_{\text{rad}}/4\pi$, which is the power density of Eq. (6) multiplied by r^2 .

Dividing $U(\theta, \phi)$ by its maximum value $U_{\text{max}}(\theta, \phi)$, we obtain the *normalized antenna power pattern*,

$$U_n(\theta, \phi) = \frac{U(\theta, \phi)}{U_{\text{max}}(\theta, \phi)} \quad (\text{dimensionless}) \quad (17)$$

A term associated with the normalized power pattern is the *beam solid angle* Ω_A defined as the solid angle through which all the power from a radiating antenna would flow if the power per unit solid angle were constant over that solid angle and equal to its maximum value (Fig. 8). This means that, for typical patterns, the beam solid angle is approximately equal to the half-power beamwidth (HPBW), that is,

$$\Omega_A = \int_0^{2\pi} \int_0^{\pi} U_n(\theta, \phi) \sin \theta d\theta d\phi = \oint_{4\pi} U_n(\theta, \phi) d\Omega \quad (\text{sr}) \quad (18)$$

If the integration is done over the main lobe, the *main-lobe solid angle*, Ω_M , results, and the difference of $\Omega_A - \Omega_M$ gives the *minor-lobe solid angle*. These definitions hold for patterns with clearly defined lobes. The *beam efficiency* (BE) of an antenna is defined as the ratio Ω_M/Ω_A and is a measure of the amount of power in the major lobe compared to the total power. A high beam efficiency means that most of the power is concentrated in the major lobe and that minor lobes are minimized.

Directivity and Gain. A very important antenna parameter, which indicates how well an antenna concentrates power into a limited solid angle, is its *directivity* D , defined as the ratio of the maximum radiation intensity to the radiation intensity averaged over all directions. The average radiation intensity is calculated

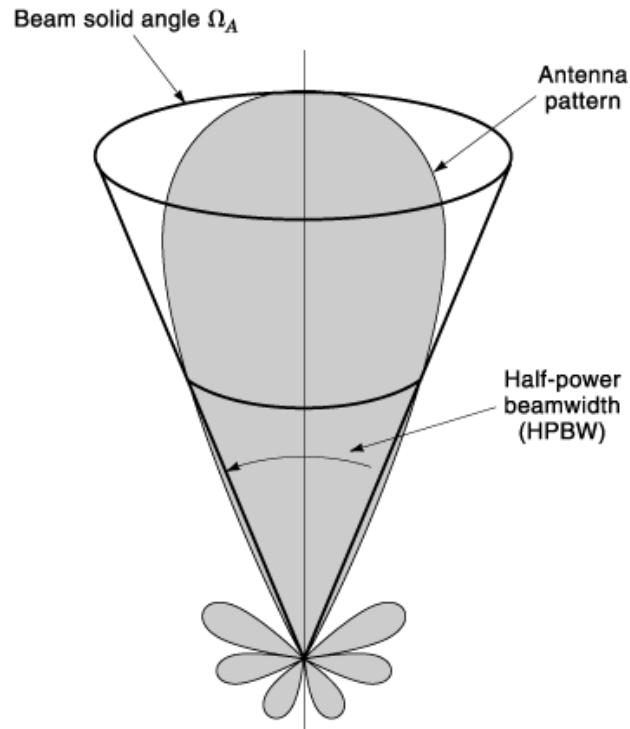

Fig. 8. Power pattern and beam solid angle of an antenna.

by dividing the total power radiated by 4π sr. Hence,

$$\begin{aligned}
 D &= \frac{U_{\max}(\theta, \phi)}{U_{\text{av}}} = \frac{U_{\max}(\theta, \phi)}{U_i} \\
 &= \frac{U_{\max}(\theta, \phi)}{P_{\text{rad}}/4\pi} = \frac{4\pi U_{\max}(\theta, \phi)}{P_{\text{rad}}} \quad (\text{dimensionless}) \quad (19)
 \end{aligned}$$

since from Eq. (16), $P_{\text{rad}}/4\pi = U_i$. So, alternatively, the directivity of an antenna can be defined as the ratio of its radiation intensity in a given direction (which usually is taken to be the direction of maximum radiation intensity) to the radiation intensity of an isotropic source with the same total radiation intensity. Equation

16 ANTENNA RADIATION PATTERNS

(19) can also be written

$$\begin{aligned}
 D &= \frac{U_{\max}(\theta, \phi)}{P_{\text{rad}}/4\pi} \\
 &= \frac{4\pi U_{\max}(\theta, \phi)}{\oint_{4\pi} U(\theta, \phi) d\Omega} \\
 &= \frac{4\pi}{\oint_{4\pi} U(\theta, \phi) / U_{\max}(\theta, \phi) d\Omega} \\
 &= \frac{4\pi}{\oint_{4\pi} U_n(\theta, \phi) d\Omega} \\
 &= \frac{4\pi}{\Omega_A}
 \end{aligned} \tag{20}$$

Thus, the directivity of an antenna is equal to the solid angle of a sphere, which is 4π sr, divided by the antenna beam solid angle Ω_A . We can say that by this relation the value of directivity is derived from the antenna pattern. It is obvious from this relation that the smaller the beam solid angle, the larger the directivity, or, stated in a different way, an antenna that concentrates its power in a narrow main lobe has a large directivity.

Obviously, the directivity of an isotropic antenna is unity. By definition an isotropic source radiates equally in all directions. If we use Eq. (20), $\Omega_A = 4\pi$, since $U_n(\theta, \phi) = 1$. This is the smallest directivity value that one can attain. However, if we consider the directivity in a specified direction, for example $D(\theta, \phi)$, its value can be smaller than unity.

As an example let us calculate the directivity of the very short dipole. We can calculate its normalized radiated power using the electric or the magnetic field components, given in Table 1. Using the electric field E_θ for the far-field region, from Eq. (12) we have

$$U_n(\theta, \phi) = \frac{U(\theta, \phi)}{U_{\max}(\theta, \phi)} = \frac{E_\theta^2(\theta, \phi)}{[E_\theta^2(\theta, \phi)]_{\max}} = \sin^2 \theta \tag{21}$$

and

$$D = \frac{4\pi}{\oint_{4\pi} U_n(\theta, \phi) d\Omega} = \frac{4\pi}{\int_0^{2\pi} \int_0^\pi \sin^3 \theta d\theta d\phi} = \frac{3}{2} = 1.5 \tag{22}$$

Alternatively, we can work using power densities instead of power intensities. The power flowing in a particular direction can be calculated using Eq. (3) and the electric and magnetic far-field components given in Table 1:

$$S_{\text{av}} = \frac{\eta}{2} \left(\frac{I_0 L \beta}{4\pi r} \right)^2 \sin^2 \theta \quad (\text{W/m}^2) \tag{23}$$

By integrating over all angles the total power flowing outwards is seen to be

$$P_T = \frac{\eta}{12\pi} (I_0 L \beta)^2 \quad (\text{W}) \quad (24)$$

The directivity is the ratio of the maximum power density to the average power density. For the very short dipole antenna, the maximum power density is in the $\theta = 90^\circ$ direction (Fig. 2), and the average power density is found by averaging the total power P_T from Eq. (24) over a sphere of surface area $4\pi r^2$. So

$$D = \frac{S_{\text{av}}}{P_T/4\pi r^2} = \frac{(\eta/2)(I_0 L \beta/4\pi r)^2}{(\eta/12\pi)(I_0 L \beta)^2/4\pi r^2} = \frac{3}{2} \quad (25)$$

Thus, the directivity of a very short dipole is 1.5, which means that the maximum radiation intensity is 1.5 times the power of the isotropic radiator. This is often expressed in decibels:

$$D = 10 \log_{10} d \quad \text{dB} = 10 \log_{10}(1.5) = 1.76 \quad \text{dB} \quad (26)$$

Here, we use a lowercase letter for the absolute value and a capital letter for the logarithmic value of the directivity, as is a common in the field of antennas and propagation.

The gain of an antenna is another basic property for its characterization. Gain is closely associated with directivity, which is dependent upon the radiation patterns of an antenna. The gain is commonly defined as the ratio of the maximum radiation intensity in a given direction to the maximum radiation intensity produced in the same direction from a reference antenna *with the same power input*. Any convenient type of antenna may be taken as the reference. Many times the type of the reference antenna is dictated by the application area, but the most commonly used one is the isotropic radiator, the hypothetical lossless antenna with uniform radiation intensity in all directions. So

$$G = \frac{U_{\text{max}}(\theta, \phi)}{U_i} = \frac{U_{\text{max}}(\theta, \phi)}{P_{\text{in}}/4\pi} \quad (\text{dimensionless}) \quad (27)$$

where the radiation intensity of the reference antenna (isotropic radiator) is equal to the power in the input, P_{in} , of the antenna divided by 4π .

Real antennas are not lossless, which means that if they accept an input a power P_{in} , the radiated power P_{rad} generally will be less than P_{in} . The *antenna efficiency* k is defined as the ratio of these two powers:

$$k = \frac{P_{\text{rad}}}{P_{\text{in}}} = \frac{R_r}{R_r + R_{\text{loss}}} \quad (\text{dimensionless}) \quad (28)$$

where R_r is the *radiation resistance* of the antenna. R_r is defined as an equivalent resistance in which the same current as that flowing at the antenna terminals would produce power equal to that produced by the antenna. R_{loss} is the *loss resistance*, which allows for any heat loss due to the finite conductivity of the materials used to construct the antenna or due to the dielectric structure of the antenna. So, for a real antenna with losses, its radiation intensity at a given direction $U(\theta, \phi)$ will be

$$U(\theta, \phi) = kU_0(\theta, \phi) \quad (29)$$

where $U_0(\theta, \phi)$ is the radiation intensity of the same antenna with no losses.

18 ANTENNA RADIATION PATTERNS

Using Eq. (29) in Eq. (27) yields the expression for the gain in terms of the antenna directivity:

$$G = \frac{U_{\max}(\theta, \phi)}{U_i} = \frac{kU_{\max}(\theta, \phi)}{U_i} = kD \quad (30)$$

Thus, the gain of an antenna over a lossless isotropic radiator equals its directivity if the antenna efficiency is $k = 1$, and it is less than the directivity if $k < 1$.

The values of gain range between zero and infinity, while those of directivity range between unity and infinity. However, while the directivity can be computed from either theoretical considerations or measured radiation patterns, the gain of an antenna is almost always determined by a direct comparison of measurement against a reference, usually a standard-gain antenna.

Gain is expressed also in decibels:

$$G = 10 \log_{10} g \quad (\text{dB}) \quad (31)$$

where, as in Eq. (26), lowercase and capital letters mean absolute and logarithmic values, respectively. The reference antenna used is sometimes declared in a subscript; for example, dB_i means decibels over isotropic.

Polarization

Wave and antenna polarization. Polarization refers to the vector orientation of the radiated waves in space. As is known, the direction of oscillation of an electric field is always perpendicular to the direction of propagation. For an electromagnetic wave, if its electric field oscillation occurs only within a plane containing the direction of propagation, it is called *linearly polarized* or *plane-polarized*. This is because the locus of oscillation of the electric field vector within a plane perpendicular to the direction of propagation forms a straight line. On the other hand, when the locus of the tip of an electric field vector forms an ellipse or a circle, the electromagnetic wave is called an *elliptically polarized* or *circularly polarized* wave.

The decision to label polarization orientation according to the electric intensity is not as arbitrary as it seems; its causes the direction of polarization to be the same as the direction of the antenna. Thus, vertical antennas radiate vertically polarized waves, and horizontal antennas radiate horizontally polarized waves. There has been a tendency, over the years, to transfer the label to the antenna itself. Thus people often refer to antennas as vertically or horizontally polarized, whereas it is only their radiations that are so polarized.

It is a characteristic of antennas that the radiation they emit is polarized. These polarized waves are deterministic, which means that the field quantities are definite functions of time and position. On the other hand, other forms of radiation, for example light emitted by *incoherent* sources, such as the sun or light bulbs, has a random arrangement of field vectors and is said to be *randomly polarized* or *unpolarized*. In this case the field quantities are completely random and the components of the electric field are uncorrelated. In many situations the waves may be *partially polarized*. In fact, this case can be seen as the most general situation of wave polarization; a wave is partially polarized when it may be considered to be of two parts, one completely polarized and the other completely unpolarized. Since we are mainly interested in waves radiated from antennas, we consider only polarized waves.

Linear, Circular, and Elliptical Polarization. Consider a plane wave traveling in the positive z direction, with the electric field at all times in the x direction, as in Fig. 9(a). This wave is said to be *linearly*

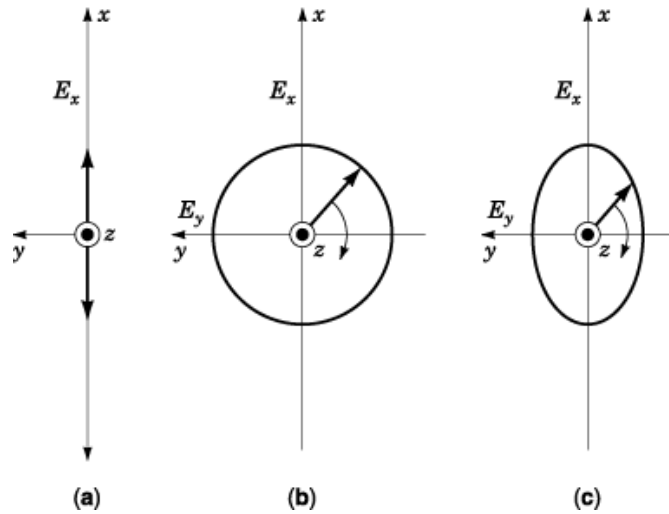

Fig. 9. Polarization of a wave: (a) linear, (b) circular, and (c) elliptical.

polarized (in the x direction), and its electric field as a function of time and position can be described by

$$E_x = E_{x0} \sin(\omega t - \beta z) \quad (32)$$

In general the electric field of a wave traveling in the z direction may have both an x and a y component, as shown in Fig. 9(b, c). If the two components E_x and E_y are of equal amplitude, the total electric field at a fixed value of z rotates as a function of time, with the tip of the vector forming a circular trace, and the wave is said to be *circularly polarized* [Fig. 9(b)].

Generally, the wave consists of two electric field components, E_x and E_y , of different amplitude ratios and relative phases. (Obviously, there are also magnetic fields, not shown in Fig. 9 to avoid confusion, with amplitudes proportional to and in phase with E_x and E_y , but orthogonal to the corresponding electric field vectors.) In this general situation, at a fixed value of z the resultant electric vector rotates as a function of time, the tip of the vector describing an ellipse, which is called the *polarization ellipse*, and the wave is said to be *elliptically polarized* [Fig. 9(c)]. The polarization ellipse may have any orientation, which is determined by its tilt angle, as shown in Fig. 10; the ratio of the major to the minor axis of the polarization ellipse is called the *axial ratio* (AR). Since the two cases of linear and circular polarization, can be seen as two particular cases of elliptical polarization, we will analyze the latter. Thus, for a wave traveling in the positive z direction, the electric field components in the x and y directions are

$$E_x = E_{x0} \sin(\omega t - \beta z) \quad (33)$$

$$E_y = E_{y0} \sin(\omega t - \beta z + \delta) \quad (34)$$

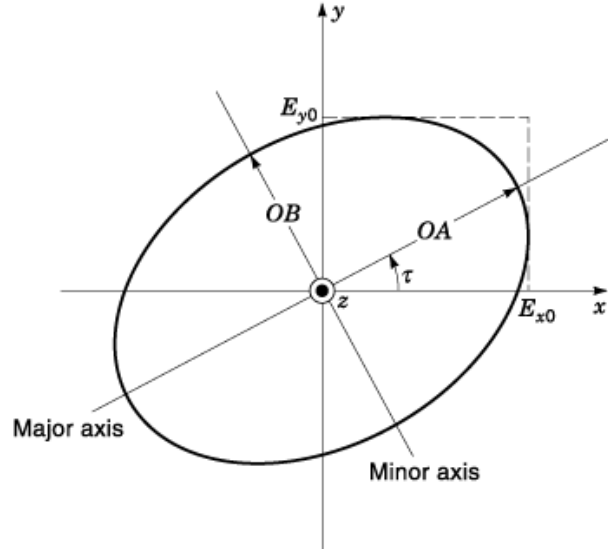

Fig. 10. Polarization ellipse at $z = 0$ of an elliptically polarized electromagnetic wave.

where E_{x0} and E_{y0} are the amplitudes in the x and y directions, respectively, and δ is the time-phase angle between them. The total instantaneous vector field \mathbf{E} is

$$\mathbf{E} = \hat{x}E_{x0} \sin(\omega t - \beta z) + \hat{y}E_{y0} \sin(\omega t - \beta z + \delta) \quad (35)$$

At $z = 0$, we have $E_x = E_{x0} \sin \omega t$ and $E_y = E_{y0} \sin(\omega t + \delta)$. The expansion of E_y gives

$$E_y = E_2(\sin \omega t \cos \delta + \cos \omega t \sin \delta) \quad (36)$$

Using the relation for E_x , we obtain $\sin \omega t = E_x/E_1$ and $\cos \omega t = \sqrt{1 - (E_x/E_1)^2}$. Introduction of these into Eq. (36) eliminates ωt , giving after rearranging

$$\frac{E_x^2}{E_1^2} - \frac{2E_x E_y \cos \delta}{E_1 E_2} + \frac{E_y^2}{E_2^2} = \sin^2 \delta \quad (37)$$

If we define

$$a = \frac{1}{E_1^2 \sin^2 \delta}, \quad b = \frac{2 \cos \delta}{E_1 E_2 \sin^2 \delta}, \quad c = \frac{1}{E_2^2 \sin^2 \delta}$$

Eq. (37) takes the form

$$aE_x^2 - bE_xE_y + cE_y^2 = 1 \quad (38)$$

which is the equation of an ellipse, the polarization ellipse shown in Fig. 10. The line segment OA is the semimajor axis, and the line segment OB is the semiminor axis. The tilt angle of the ellipse is τ . The axial ratio is

$$\text{AR} = \frac{OA}{OB} \quad (1 \leq \text{AR} \leq \infty) \quad (39)$$

From this general case, the cases of linear and circular polarization can be found. Thus, if there is only E_x ($E_{y0} = 0$), the wave is linearly polarized in the x direction, and if there is only E_y ($E_{x0} = 0$), the wave is linearly polarized in the y direction. When both E_x and E_y exist, for linear polarization they must be in phase or antiphase with each other. In general, the necessary condition for linear polarization is that the time-phase difference between the two components must be a multiple of π . If $\delta = 0, \pi, 2\pi, \dots$ and $E_{x0} = E_{y0}$, the wave is linearly polarized but in a plane at an angle of $\pm\pi/4$ with respect to the x axis ($\tau = \pm\pi/4$). If the ratio of the amplitudes E_{x0} and E_{y0} is different, then the tilt angle will also be different.

If $E_{x0} = E_{y0}$ and $\delta = \pm\pi/2$, the wave is circularly polarized. Generally, circular polarization can be achieved only when the magnitudes of the two components are the same and the time-phase angle between them is an odd multiple of $\pi/2$.

Consider the case that $\delta = \pi/2$. Taking $z = 0$, from Eq. (33), (34), and (35) at $t = 0$ one has $\mathbf{E} = \hat{y}E_{y0}$, and one-quarter cycle later, at $\omega t = \pi/2$, one has $\mathbf{E} = \hat{x}E_{x0}$. Thus, at a fixed position ($z = 0$) the electric field vector rotates with time, tracing a circle. The sense of rotation, also referred to as the sense of polarization, can be defined by the sense of rotation of the wave as it is observed along the direction of propagation. Thus the above wave rotates clockwise if it is observed looking towards the source (viewing the wave approaching) or counterclockwise if it is observed looking away from the source (viewing the wave moving away). Thus, unless the wave direction is specified, there is ambiguity. The most generally accepted notation is that of the IEEE, by which the sense of rotation is always taken as that with the wave it traveling away from the observer. If the rotation is clockwise, the wave is *right-handed* or *clockwise circularly polarized* (RH or CW). If the rotation is counterclockwise, the wave is *left-handed* or *counterclockwise circularly polarized* (LH or CCW). Yet another way to define the polarization is with the aid of helical-beam antennas. A right-handed helical-beam antenna radiates (or receives) right-handed waves regardless of the position from which it is viewed, while a left-handed one radiates right-handed waves.

Although linear and circular polarizations can be seen as special cases of elliptical, usually, in practice, “elliptical polarization” refers to other than linear or circular. A wave is characterized as elliptically polarized if the tip of its electric vector forms an ellipse. For a wave to be elliptically polarized, its electric field must have two orthogonal linearly polarized components, E_{x0} and E_{y0} . If the two components are not of the same magnitude, the time-phase angle between them must not be 0 or a multiple of π , while in the case of equal magnitude, the angle must not be an odd multiple of $\pi/2$. Thus, a wave that is not linearly or circular polarized is elliptically polarized. The sense of its rotation is determined according to the same rule as for circular polarization. So a wave is *right-handed* or *clockwise elliptically polarized* (RH or CW) if the rotation of its electric field is clockwise, and it is *left-handed* or *counterclockwise elliptically polarized* (LH or CCW) if the electric field vector rotates counterclockwise.

In addition to the sense of rotation, elliptically polarized waves are characterized by their axial ratio AR and their tilt angle τ . The tilt angle is used to identify the spatial orientation of the ellipse and can

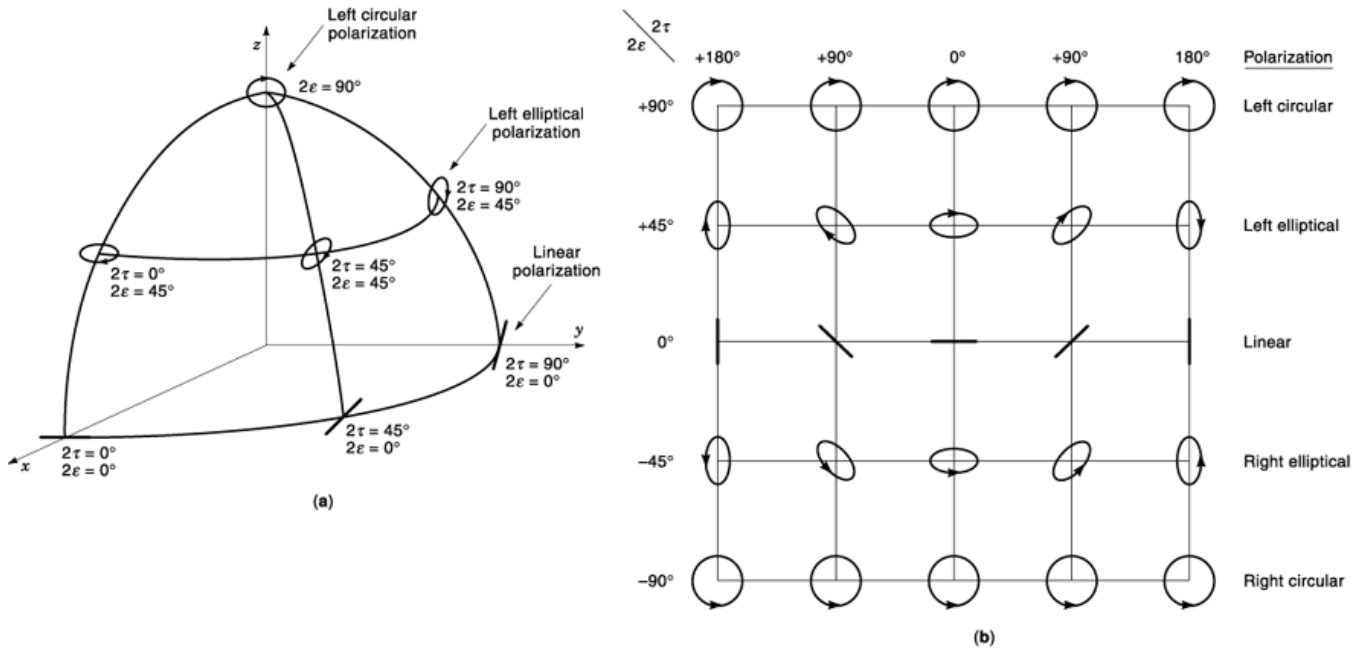

Fig. 11. Polarization states of an electromagnetic wave represented with the aid of the Poincaré sphere: (a) one octant of the Poincaré sphere with polarization states, (b) the full range of polarization states in rectangular projection.

be measured counterclockwise or clockwise from the reference direction (Fig. 10). If the electric field of an elliptically polarized wave has two components of different magnitude with a time-phase angle between them an odd multiple of $\pi/2$, the polarization ellipse will not be tilted. Its position will be aligned with the principal axes of the field components, so that the major axis of the ellipse will be aligned with the axis of the larger field component and the minor axis with the smaller one.

The Poincaré Sphere and Antenna Polarization Characteristics. The polarization of a wave can be represented and visualized with the aid of a Poincaré sphere. The polarization state is described by a point on this sphere, whose longitude and latitude are related to parameters of the polarization ellipse. Each point represents a unique polarization state. On the Poincaré sphere the north pole represents left circular polarization, the south pole right circular polarization, and the points along the equator linear polarization of different tilt angles. All other points on the sphere represent elliptical polarization states. One octant of the Poincaré sphere with polarization states is shown in Figure 11(a), while the full range of polarization states is shown in Figure 11(b), which presents a rectangular projection of the Poincaré sphere.

The polarization state described by a point on Poincaré sphere can be expressed in terms of:

- (1) The longitude L and latitude l of the point, which are related to the parameters of the polarization ellipse by

$$L = 2\tau \quad \text{and} \quad l = 2\epsilon$$

where τ is the tilt angle with values $0 \leq \tau \leq \pi$ and $\epsilon = \cot^{-1}(\mp AR)$ with values $-\pi/4 \leq \epsilon \leq +\pi/4$. The axial ratio AR is negative and positive for right- and left-handed polarization respectively.

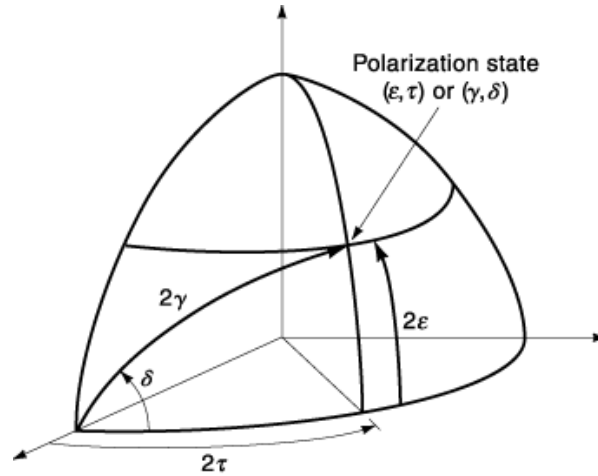

Fig. 12. One octant of the Poincaré sphere, showing the relations of the angles τ , ϵ , γ , and δ that can be used to describe a polarization state.

- (2) The angle subtended by the great circle drawn from a reference point on the equator, and the angle between the great circle and the equator:

$$\text{great-circle angle} = 2\gamma \quad \text{and} \quad \text{equator-to-great-circle angle} = \delta$$

where $\gamma = \tan^{-1}(E_{y0}/E_{x0})$ with $0 \leq \gamma \leq \pi/2$ and δ the time-phase difference between the components of the electric field ($-\pi \leq \delta \leq +\pi$).

All the above quantities τ , ϵ , γ , and δ , are interrelated by trigonometric formulae (4), and knowing τ , ϵ one can determine γ , δ and vice versa. As a result, the polarization state can be described by either of these two sets of angles. The geometric relation between these angles is shown in Fig. 12.

The polarization state of an antenna is defined as the polarization state of the wave radiated by the antenna when it is transmitting. It is characterized by the axial ratio AR, the sense of rotation, and the tilt angle, which identifies the spatial orientation of the ellipse. However, care is needed in the characterization of the polarization of a receiving antenna. If the receiving antenna has a polarization that is different from that of the incident wave, a polarization mismatch occurs. In this case the amount of power extracted by the receiving antenna from the incident wave will be lower than the expected value, because of the polarization loss. A figure of merit, which can be used as a measure of polarization mismatch, is the *polarization loss factor* (PLF). It is defined as the cosine squared of the angle between the polarization states of the antenna in its transmitting mode and the incoming wave. Another quantity that can be used to describe the relation between the polarization characteristics of an antenna and an incoming wave is the *polarization efficiency*, also known as *loss factor* or *polarization mismatch*. It is defined as the ratio of the power received by an antenna from a given plane wave of arbitrary polarization to the power that would be received by the same antenna from a plane wave of the same power flux density and direction of propagation, whose state of polarization has been adjusted for maximum received power.

In general an antenna is designed for a specific polarization. This is the desired polarization and is called the *copolariation* or *normal polarization*, while the undesired polarization, usually taken orthogonal to the desired one, is known as the *cross polarization* or *opposite polarization*. The latter can be due to a change

24 ANTENNA RADIATION PATTERNS

of polarization characteristics during the propagation of waves, which is known as *polarization rotation*. In general an actual antenna does not completely discriminate against a cross-polarized wave, due to engineering and structural restrictions. The directivity pattern obtained over the entire direction on a representative plane for cross polarization with respect to the maximum directivity for normal polarization is called *antenna cross-polarization discrimination*, and it is an important factor in determining the antenna performance.

The *polarization pattern* gives the polarization characteristics of an antenna and is the spatial distribution of the polarization of the electric field vector radiated by the antenna over its radiation sphere. The description of the polarizations is accomplished by specifying reference lines, which are used to measure the tilt angles of polarization ellipses, or the directions of polarization for the case of linear polarization.

Evaluation Of Antenna Pattern And Directivity (General Case)

Derivation of Electromagnetic Fields. As already pointed out, the radiation pattern of an antenna is generally its most basic property and it is usually the first requirement to be specified. Of course, the patterns of an antenna can be measured in the transmitting or receiving mode; in most cases one selects the receiving mode if the antenna is reciprocal. But to find the radiation patterns analytically, we have to evaluate the fields radiated from the antenna.

In radiation problems, the case where the sources are known and the fields radiated from these sources are required is characterized as an *analysis* problem. It is a very common practice during the analysis process to introduce auxiliary functions that will aid in the solution of the problem. These functions are known as vector potentials, and for radiation problems the most widely used ones are the *magnetic vector potential* \mathbf{A} and the *electric vector potential*, \mathbf{F} . Although it is possible to calculate the electromagnetic fields \mathbf{E} and \mathbf{H} directly from the source current densities the electric current \mathbf{J} and magnetic current \mathbf{M} , it is simpler to calculate \mathbf{A} and \mathbf{F} first and then evaluate the fields. The vector potential \mathbf{A} is used for the evaluation of the electromagnetic field generated by a known harmonic electric current density \mathbf{J} . The vector potential \mathbf{F} can give the fields generated by a harmonic magnetic current, which, although physically unrealizable, has applications in some cases, as in volume or surface equivalence theorems. Here, we restrict ourselves to the use of the magnetic vector potential \mathbf{A} , which is the potential that gives the fields for the most common wire antennas.

Using the appropriate equations from electromagnetic theory, one can express the vector potential \mathbf{A} as

$$\mathbf{A} = \frac{\mu_0}{4\pi} \iiint_v \mathbf{J} \frac{e^{-j\beta r}}{r} dv \quad (40)$$

where $k^2 = \omega^2 \mu_0 \epsilon_0$, with μ_0 and ϵ_0 the magnetic permeability and electric permittivity of the air, respectively, and ω is the radian frequency. r is the distance from any point in the source to the observation point. The fields are then given by

$$\mathbf{E} = -\nabla V - j\omega \mathbf{A} \quad (41a)$$

and

$$\mathbf{H} = \frac{1}{\mu_0} \nabla \times \mathbf{A} \quad (41b)$$

where in 41a the scalar function V represents an arbitrary electric scalar potential, which is a function of position. The fields radiated by antennas with finite dimensions are spherical waves, and in the far-field region, the electric and magnetic field components are orthogonal to each other and form a TEM (transverse electromagnetic mode) wave. Thus in the far field region, Eq. (41a) simplify to

$$\mathbf{E} \approx -j\omega\mathbf{A} \Rightarrow \begin{cases} E_r \approx 0 \\ E_\theta \approx -j\omega A_\theta \\ E_\phi \approx -j\omega A_\phi \end{cases} \quad (42a)$$

and

$$\mathbf{H} \approx \frac{1}{\eta} \hat{\mathbf{r}} \times \mathbf{E} \Rightarrow \begin{cases} H_r \approx 0 \\ H_\theta \approx -E_\phi/\eta \\ H_\phi \approx +E_\theta/\eta \end{cases} \quad (42b)$$

So the problem becomes that of first evaluating the function \mathbf{A} from the specified electric current density on the antenna; then, using Eq. (42a), the \mathbf{E} and \mathbf{H} fields are evaluated and the radiation pattern extracted. For example, for the case of a very short dipole the magnetic vector potential \mathbf{A} is given by

$$\mathbf{A} = \hat{\mathbf{z}} \frac{\mu_0 I_0}{4\pi r} e^{-jkr} \int_{-L/2}^{L/2} dz = \hat{\mathbf{z}} \frac{\mu_0 I_0 L}{4\pi r} e^{-jkr} \quad (43)$$

Using Eq. (43), the fields shown in Table 1 can be evaluated.

Numerical Calculation of Directivity. Usually, the directivity of a practical antenna is easiest to evaluate from its radiation pattern using numerical methods. This is especially true when the radiation patterns are so complex that closed-form mathematical expressions are not available. Even when such expressions exist, because of their complicated form the necessary integration to find the radiated power is very difficult to perform. A numerical method of integration, like the Simpson or trapezoidal rule, can greatly simplify the evaluation of radiated power and yield the directivity, leading in this way to a method of general application that needs only a function or a matrix supplying the values of radiated field. However, in many cases the evaluation of the integral that gives the radiated power, using a series approximation, has proven to give the correct value of the directivity.

Consider the case where the radiation intensity of a given antenna can be written in the following form:

$$U(\theta, \phi) = Af(\theta)g(\phi) \quad (44)$$

which means that it is separable into two functions, each being a function of one variable only, and A is a constant. Then P_{rad} from Eq. (15) will be

$$P_{\text{rad}} = A \int_0^{2\pi} \left(\int_0^\pi f(\theta)g(\phi) \sin \theta d\theta \right) d\phi \quad (45)$$

26 ANTENNA RADIATION PATTERNS

If we take N equal divisions over the interval π of the variable θ , and M equal divisions over the interval 2π of the variable ϕ , the two integrals can be calculated by a series approximation, respectively:

$$\int_0^\pi f(\theta) \sin \theta d\theta = \sum_{i=1}^N [f(\theta_i) \sin \theta_i] \Delta\theta_i \quad (46a)$$

and

$$\int_0^{2\pi} g(\phi) d\phi = \sum_{j=1}^M g(\phi_j) \Delta\phi_j \quad (46b)$$

Introducing Eq. (46a) into Eq. (45), we obtain

$$P_{\text{rad}} = A \left(\frac{\pi}{N} \right) \left(\frac{2\pi}{M} \right) \sum_{j=1}^M \left\{ g(\phi_j) \left[\sum_{i=1}^N f(\theta_i) \sin \theta_i \right] \right\} \quad (47)$$

A computer program can easily evaluate the above equation. The directivity then is given by Eq. (19), which is repeated here:

$$D = \frac{4\pi U_{\text{max}}(\theta, \phi)}{P_{\text{rad}}}$$

In the case that θ and ϕ variations are not separable, P_{rad} can also be calculated by a computer program using a slightly different expression,

$$P_{\text{rad}} = B \left(\frac{\pi}{N} \right) \left(\frac{2\pi}{M} \right) \sum_{j=1}^M \left(\sum_{i=1}^N F(\theta_i, \phi_j) \sin \theta_i \right) \quad (48)$$

where we consider that in this case $U(\theta, \phi) = BF(\theta, \phi)$.

For more information about radiation patterns in general and radiation patterns of specific antennas, the reader should consult Refs. 1 and 5,6,7,8,9,10,11.

BIBLIOGRAPHY

1. S. Drabowitch *et al.* *Modern Antennas*, London: Chapman & Hall, 1998.
2. C. A. Balanis *Antenna Theory, Analysis and Design*, New York: Wiley, 1997.
3. J. D. Kraus *Antennas*, New York: McGraw-Hill, 1988.
4. J. D. Kraus K. R. Carver *Electromagnetics*, New York: McGraw-Hill, 1973.
5. W. L. Stutzman G. A. Thiele *Antenna Theory and Design*, New York: Wiley, 1981.
6. W. L. Weeks *Antenna Engineering*, New York: McGraw-Hill, 1968.
7. S. A. Schelkunoff H. T. Friis *Antenna Theory and Practice*, New York: Wiley, 1952.
8. E. Jordan K. Balmain *Electromagnetic Waves and Radiating Systems*, New York: Prentice-Hall, 1968.

9. T. A. Milligan *Modern Antenna Design*, New York: McGraw-Hill, 1985.
10. R. C. Johnson H. Jasik (ed.) *Antenna Engineering Handbook*, New York: McGraw-Hill, 1993.
11. Y. T. Lo S. W. Lee (ed.) *Antenna Handbook: Theory, Applications and Design*, New York: Van Nostrand Reinhold, 1988.

MICHAEL CHRYSOMALLIS
Democritus University of Thrace
CHRISTOS CHRISTODOULOU
The University of New Mexico