

ceous component. Many other industrial waste products can be used as raw materials. Cement plants are of two types, those that use the wet process and those that use the dry process. As indicated by the name, in a wet process plant the raw materials are mixed with water, and in the dry process plant the raw material are dry. The life of a cement plant can exceed 50 years. Most of the cement plants built before 1970 used wet process, and plants built after 1970 are mainly of the dry process type.

Figure 1 shows a flowchart for a wet process cement plant. The raw materials are mined in a quarry, generally adjacent to the plant. Typically, the quarry operates 40 h a week. The limestone is crushed in a primary crusher and is then conveyed by conveyor belt to a secondary crusher and into some type of storage, finally ending up in a limestone silo. The clay is crushed in a crusher, broken apart in a log washer or clay wash mill, mixed with water, and ground in a rod mill before being pumped into a clay basin equipped with rotating rakes and air bubbles to keep the clay in suspension. Limestone, clay slurry, and water are then fed to a slurry mill, in which the raw materials are ground to make the raw material feed stock which will contain between 30% and 40% water, just enough to make it viscous enough that it can be pumped. The raw mill department normally operates 14 to 20 shifts weekly. This raw material is stored in a slurry basin equipped with rotating rakes and air bubbles to keep it in suspension and to homogenize the kiln feed. Then the slurry is pumped into the kiln. The kilns vary in sizes and production rates between 400 t/day with a dimension of 3 m diameter and 122 m length and 3700 t/day with a dimension of 7 m diameter and 232 m length.

The kiln rotates with an adjustable speed of approximately 1 rpm. The raw materials are fed into one end of the kiln which is equipped with steel chain used as a heat exchange media, and it also serves as a dust curtain to catch some of the dust generated in the process. As the kiln is mounted on a slight decline, (approximately 4%) the slurry travels down through the kiln, which is refractory lined, through the heating zone, calcining zone, and finally the burning zone before being discharged into the cooler. The material temperature in the burning zone is approximately 1300°C, and the air temperature is approximately 1500°C. The air leaving the kiln outlet is approximately 200°C and is cleaned by a baghouse dust collector or electrostatic precipitator before being emitted through the stack. The kiln operates around the clock with 85% to 95% utilizations per year. The fuel burned in the kiln is generally oil, natural gas, or coal, but many waste products can be safely used as fuel and disposed of in a cement kiln. The specific heat consumption is approximately 7000 kJ/kg for the less efficient wet process kilns to approximately 5000 kJ/kg for the most efficient ones.

The semifinished product produced by the kiln is called clinker and is approximately 1300°C. The clinker is cooled on grates in a cooler with air blown up through the grates, part of the air heated by the clinker is exhausted through the kiln's secondary air, its heat value is used to heat the raw materials, and another part, called primary air, is used to transport the pulverized coal into the kiln while the excess is vented out through a baghouse or precipitator after being mixed with ambient temperature air. Some coolers are

## CEMENT INDUSTRY

### CEMENT PROCESS, EQUIPMENT, AND DESIGN CRITERIA

Cement is an inexpensive commodity that requires efficient production and distribution. Cement plants are very highly capital-intensive. To minimize capital cost, the plant layout must be compact, and no extraneous equipment should be installed. Normally, a plant does not operate at full capacity the first years of operation; therefore, backup equipment and installed spares are not needed but can be installed when production increases and the plant is making a profit. However, provisions must be made during the design of the plant to allow for installation of the equipment at a later date. Ordinarily, cement plant kiln lines operate at utilization rates of 85% to 95%; consequently, it is important that the equipment is of high quality and of a design that requires very little maintenance.

The raw materials for cement manufacturing are calcareous and argillaceous. Generally, the calcareous component is limestone or chalk, and the argillaceous component is clay or marl. Power plant fly ash can be used as a part of the argilla-

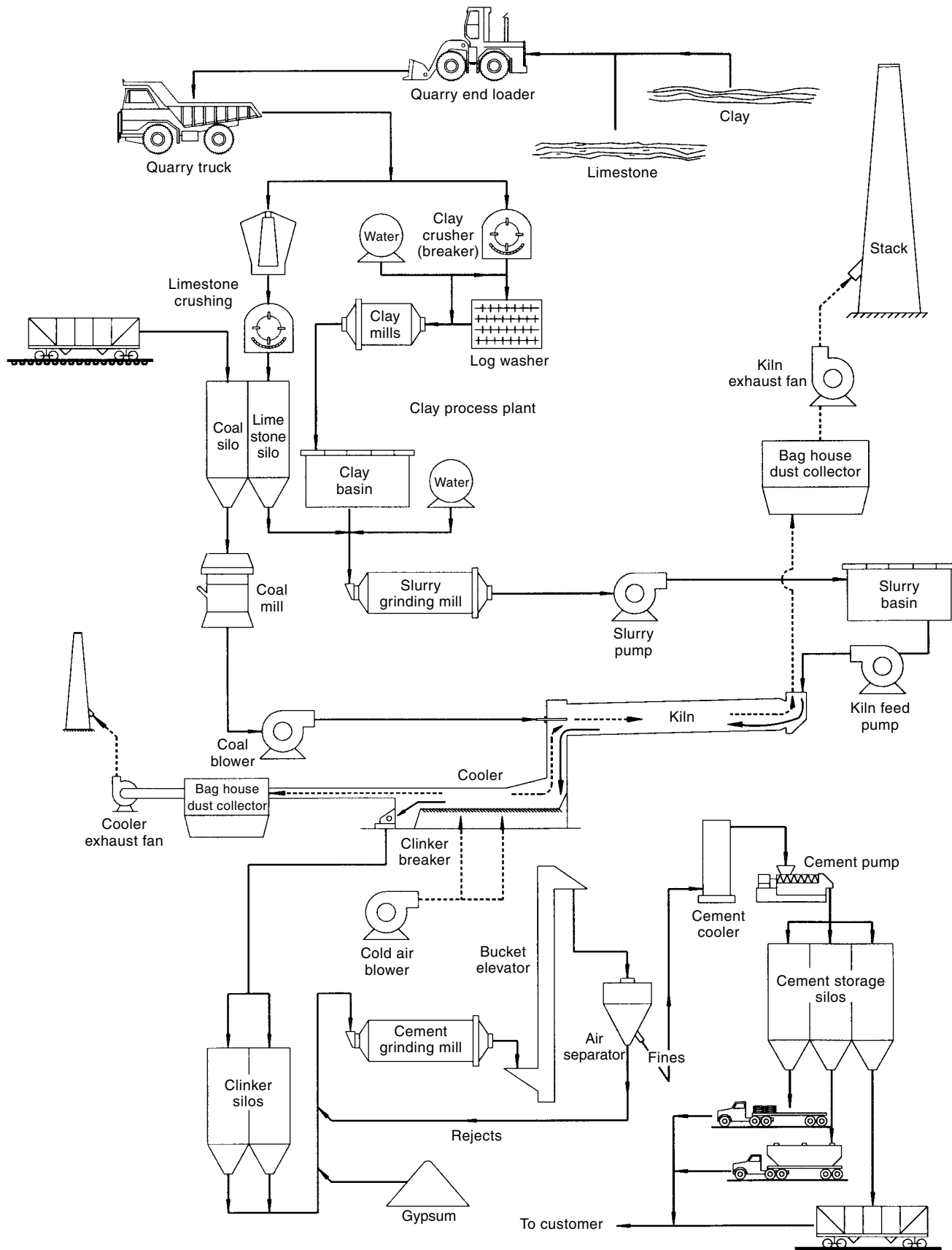

Figure 1. Flowsheet for a wet process cement plant.

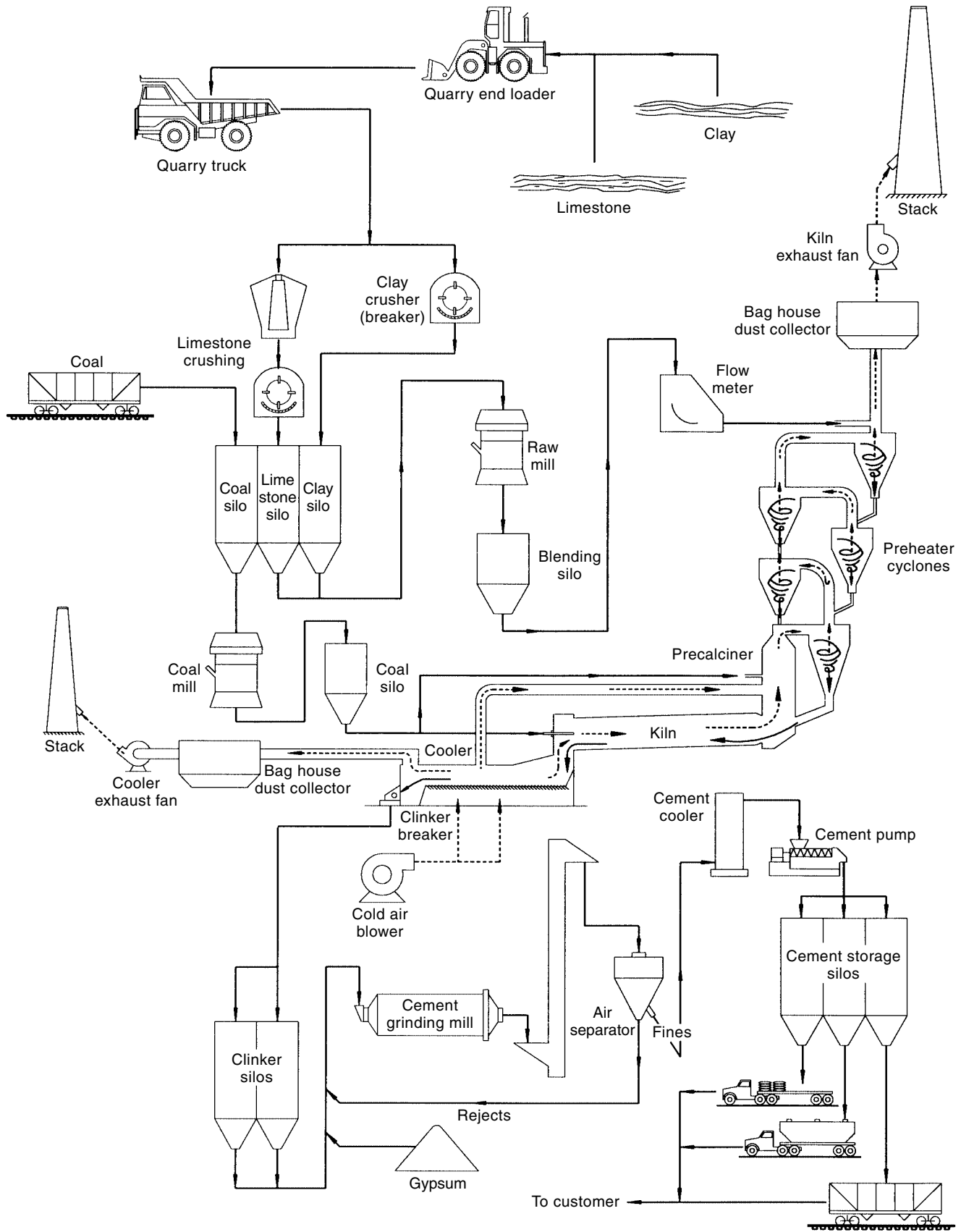

Figure 2. Flowsheet for a typical modern dry process plant.

equipped with a heat exchanger to avoid wasting this heat and eliminating discharging it to the environment.

The clinker is transported to clinker storage before being ground into finished cement in ball mills rotating at 11 rpm to 17 rpm. The size of the drives for the ball mills is between 600 kW (size 2 m diameter  $\times$  12 m length) and 5000 kW (size 4.5 m diameter by 15 m length). Five percent gypsum is added to the clinker to retard the setting time of the concrete. The fineness of the cement is between 2600 blaine and 4000 blaine. The mills are typically operated 14 to 20 shifts weekly. Finally, the cement is ready to be shipped to the customers in bulk by trucks or rail cars; or if the plant is located riparian to a navigable waterway, the cement is sent by barge or ship. It can also be packed in bags. Typically, shipping operates 40 h per week.

Figure 2 shows a flowchart for a typical modern dry process plant. In order to save the reader's time, only the differences from the wet process plant will be discussed. The advantage compared to the wet process is better fuel economy because only a small amount of water will have to be evaporated; however, the disadvantages are (1) up to 10% higher electric power consumption, (2) more difficult homogenizing of raw materials (powders are more difficult to mix than slurry), and (3) difficulty to eliminate circulating constituent of alkalis, sulfur, and chlorides in the kiln preheater system, which can cause plug-ups in that system and quality problems with the cement.

The quarry operation is the same; however, the clay component is handled dry. Sometimes the clay and limestone is prehomogenized in large storage halls with special stacking and reclaiming machines before being conveyed to the raw mill. Some drying can be done in the raw mill with hot gases from the kiln system; but if the moisture content in the raw materials is too high, they will have to be pre-dried.

In the dry process kiln system, the drying, heating, and part of the calcining is done outside the kiln. The calcining is performed in a precalciner vessel where the fuel, is generally the same as the kiln fuel, and the combustion air is taken from the cooler through a separate tertiary air duct with an air temperature of approximately 875°C. The heating is done through preheater cyclones. The outlet air from the preheater cyclones are approximately 310°C. This air is cleaned by a baghouse dust collector or electrostatic precipitator. The outlet air temperature from the kiln is approximately 1150°C, and, as with the wet process kiln, the outlet material temperature is approximately 1300°C and the air temperature at the outlet is approximately 1500°C. The kiln is lined with refractory material. Part of the process done within the wet process kiln is done outside in the precalciner and preheater. The dry process kiln is smaller and rotates somewhat faster, at approximately 3 rpm. The capacity of a dry process kiln is normally between 1000 t/day and 8000 t/day. A 1000 t/day kiln will have a size of approximately 3.8 m diameter and 56 m length, and an 8000 t/day kiln will have a size of approximately 5.6 m diameter and 84 m length. The specific fuel consumption for the kiln and preheater is between 3000 kJ/kg and 4000 kJ/kg. The ball Mill power can be on the order of 6500 kW with a size of 5.2 m diameter by 17.1 m length. The plants shown in Figs. 1 and 2 have one process line. Plants can have more than one, but it is less expensive to build and operate a one-process line plant.

## CEMENT SHIPPING

Years ago, small cement plants were located close to the consumers; however, as the economy of large production units forced cement companies to build fewer but bigger plants, the old method of bagging cement and shipping by truck became uneconomical. Larger shipping distances can be achieved by shipment by rail to terminals where the cement is stored in silos close to the consumers. Often these terminals are also bagging cement in automatic bagging machines with a production as high 1000 bags/h placed on pallets and shrink-wrapped with plastic film. Still a larger market area can be served if the plant is located at a navigable waterway where cement can be shipped by barge. These barges can be self-unloading with cement pumps on the barge pumping the cement to a silo pneumatically. Shore-mounted pneumatic unloading systems manipulated with a shore-mounted crane is an economic way of unloading standard barges with no special equipment on board. Additional market areas can be reached if the plant location is accessible to ocean-going ships. These ships can be self-unloaders or normal bulk carriers requiring a shore-mounted pneumatic or mechanical unloading system. Cement storage capacity on the order of 100,000 t is not uncommon for a cement terminal designed to receive cement from ocean-going ships.

## POWER DISTRIBUTION

The power cost in a cement plant can be as high as 25% of the production cost. Consequently, decisions on utility supply voltage, utility contract, and wheeling of power must be carefully considered. This section will address power distribution planning and design criterias for cement plant power distribution systems.

### Power Distribution Planning for Cement Plant

The typical cement plant is divided into departments (Fig. 3). The power distribution system should be congruent to these departments with a feeder and distribution transformer for each department. If the plant has more than one production line, each department should be split up with a feeder and distribution transformer for each production line in the department. For example, if a cement plant has three finish or cement ball mills, each mill must have its own feeder and distribution transformer. The main substation should be located far away from the direction of the prevailing winds to prevent contamination with cement dust of the insulators. The transformer and high-voltage bushing should be specified as the high creepage type to increase the time between cleaning and application of silicone grease. It is also recommended that the substation primary voltage insulators be specified for the next higher insulations level. Due to the cleaning problems with insulators, extra design efforts should be placed on minimizing the total number of insulators and bushings. Besides increasing the reliability, this, will also decrease the construction cost.

Figure 4 shows a simplified one-line diagram for a 3700 t/day wet process plant. This plant's incoming power is 161 kV from two parallel lines feeding two main transformers connected as a secondary selective system, but with the tie breaker normally closed to secure low voltage drop during the

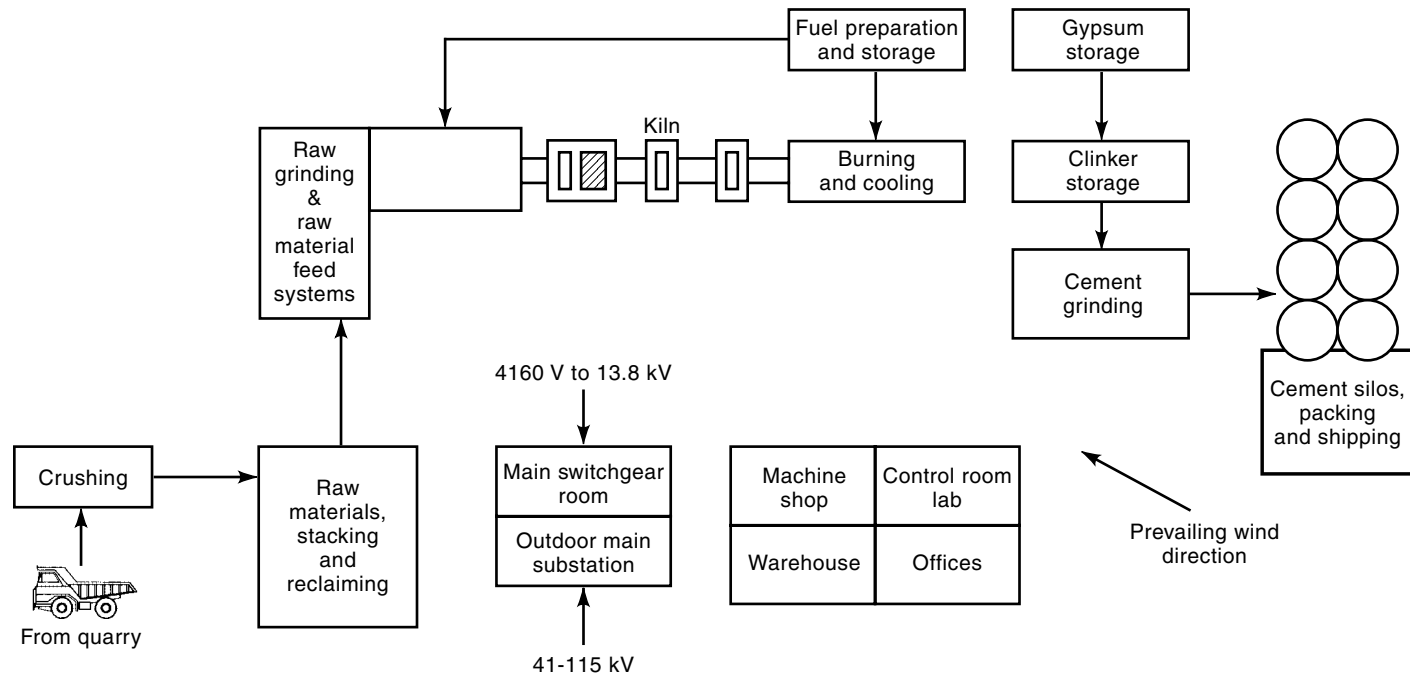

Figure 3. Departments of a typical cement plant.

start of the big motors across the line. As this plant has several big motors, the designers decided to have a 13.8 kV as well as a 4160 V plant distribution system. To the 13.8 kV system is connected the three 5000 kW mill motors and the kiln direct current (dc) drives. In addition, all the 480 V distribution transformers are connected to the 13.8 kV bus together with the three transformers supplying the three 4160 V switchgear line ups. All the alternating current (ac) motors between 200 kW and 1200 kW are connected to the 4160 V bus. The 4160 switchgear is connected through normally open tie breakers. The plant can operate with few loads curtailed with one 161 kV/13.8 kV/4160 transformer faulty. The main transformer kVA and impedance must be sized for the maximum allowable voltage drop in the plant due to the large motors starting across the line. The maximum voltage drop during start of one of the large motors should be below 10%; however, many installations exist where the voltage drop during large motor starts are in excess of 20%, causing problems with control circuits dropping out and lights dimming. In addition to the voltage drop caused by the starting of the offending motor, the current drawn by all other motors running will increase, thereby exacerbating the voltage drop problem.

Automatic switching devices incorporating reactors and capacitors can be installed if excessive voltage drops are caused by a weak utility system. These devices are expensive; however, in some cases, they are the only economical solution.

**Voltage Levels.** For plants with main substation transformers up to 25,000 kVA, a primary distribution voltage of 4160 V or 6000 V should be used. Above 25,000 kVA, two distribution voltages may be used as shown in Fig. 4: a 4160 V system and a 13.8 kV system. In most cases, the choice of voltage level is decided by the size of the motors. The motors above 200 kW can constitute approximately half of the total motor load. In selecting transformers one should be aware of the

trade-off between designing for limiting the short-circuit current and excessive voltage drop due to large motors starting.

A range of 480 V to 600 V is normally chosen as the secondary distribution voltage because the distance between the distribution transformer and the load can be fairly long. Yard lighting and (in some cases), shop lighting can be powered with the 480 V phase to a neutral voltage of 277 V; however, the preferred voltage for countries using 120 V lighting circuits is a three-phase lighting transformer with a voltage rating of 208 y/120. The standard control voltage in the United States is 115 V ac. However, other voltages have been used such as 12 V dc, 24 V dc, and 48 V dc. A popular voltage used in many countries and gaining popularity in the United States is 24 V dc. You have to be careful using voltages below 115 V ac in a cement plant. The potential risks from minute amounts of dust on contacts preventing the signal from reaching its termination point are too high. If such a low voltage is used, the switching devices should have contacts designed for low-voltage dc applications.

**Transformers and Low-Voltage Substations.** It is recommended that the low-voltage substation is in a clean and air-conditioned room. Historically, the medium-voltage transformer has been located inside the room; however, because a modern substation has a plethora of electronic equipment susceptible to failure due to overheating, it is recommended to locate this transformer outside and connect it to the motor control center (MCC) with a bus duct or cable.

The transformer should be  $\Delta y$  connected with the secondary neutral solid grounded. Preferably the kVA size should be 1000 kVA or below to reduce the available short-circuit current. If high short-circuit currents are a problem, the transformers can be wound with a higher-than-normal impedance. For transformers mounted inside a building, a cast-coil transformer or a dry type is recommended; however, the Basic In-

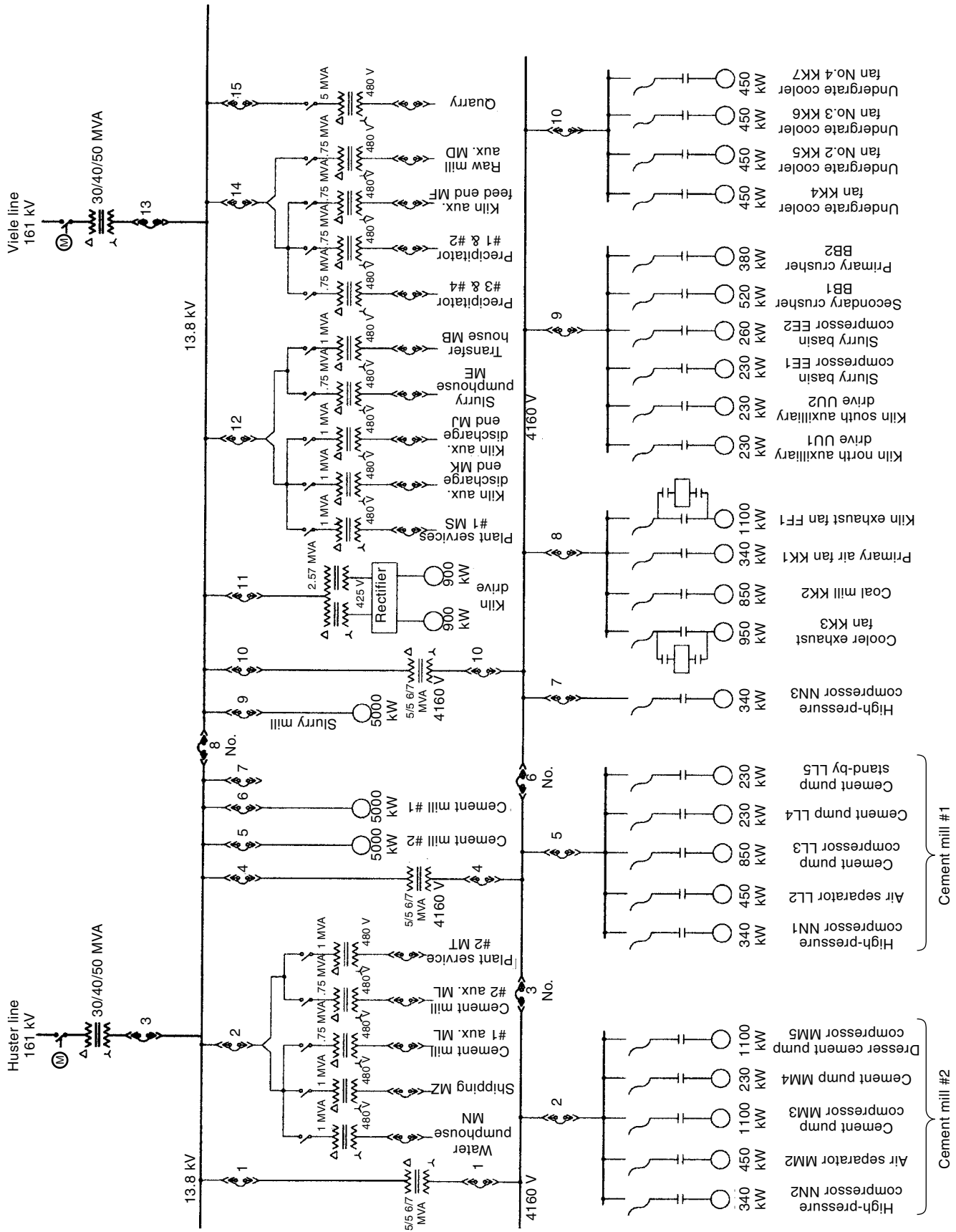

Figure 4. A 3700 t/day wet process plant.

sulation Level (BIL) rating is lower than a comparable liquid-filled type. For transformers mounted outside a high-molecular-weight oil type is recommended.

Cement plants are using many adjustable speed drives which may cause harmonic problems. A transformer must be either purchased for this duty or derated. The following formula can be used for derating:

$$\text{HLF} = \frac{\text{HL}}{\text{HL} + \text{OH}} \times 100 \quad (1)$$

where

HLF = harmonic load factor

HL = harmonic load kVA

OL = sinusoidal wave form load kVA

The 480 V substations should be located as close to the center of the loads as possible to minimize voltage drops. The low-voltage system recommended for cement plants is the reliable simple radial system. If two substations are close enough together, a secondary selective system can be used where the two substations' 480 V switchgear can be connected together with a normally open breaker, which can be closed if a transformer or the supply cable fails.

**Grounding.** For safety to personnel and equipment, it is recommended that the main substation transformers' secondary neutral or  $y$  point be grounded through a resistor; or if there is no neutral, a zigzag connected grounding transformer must be installed with a grounded neutral. The resistor should be of high enough resistance that it limits the ground fault current to a safe limit, but low enough to avoid nuisance trips due to the system charging currents. The resistor is normally rated at 400 A 10 s. The current transformer used should be a window type on the ground conductor. The residual ground fault current detection system is not recommended for a cement plant. Power distribution transformers transforming the plants medium voltage to the low-voltage 480 V or 600 V level should have a solidly grounded neutral if no compelling reasons exist to use resistance grounding. This ground should also be connected to the building steel and carried through the cable system to the electrical equipment. A continuity check on this grounding system should be done yearly.

#### Design Criteria

**Estimating Loads.** Some assumptions will have to be made when estimating loads on the power distribution system. The sum of the electrical rating of each piece of equipment will give the total connected load, but because some equipment operates at less than full load and some intermittently, the resulting demand upon the power source is less than the connected load. As a help in estimating the load of some cement plant departments, Table 1 can be used.

Table 1 shows the average consumption (in kWh/t) in the different departments of over 60 wet-process and dry-process cement plants, as well as the consumption at the lowest and highest plant in the group.

**Calculations.** To avoid duplications, no actual calculations will be done in this section. Refer to the relevant articles in this encyclopedia and in the reading list. The calculations that are needed for a cement plant power distribution system are as follows:

- Load calculations to determine main transformer size.
- Obtain motor sizes for different department.
- Calculate preliminary heating and lighting loads.
- Calculate distribution transformer size.
- Calculate feeder cable sizes using cable loading and maximum allowable voltage drops during start of the motors [remember low  $\cos \varphi$  (power factor) during start].
- Calculate short-circuit currents and voltage drops at buses using one of the available software packages.
- Readjust cable sizes if required due to mechanical/thermal requirements to withstand short circuits.
- Calculate protective relay settings to obtain selectivity.
- Calculate control wire size to ascertain that the voltage across the starter and relay coils are sufficiently high for proper closing of the magnetic circuit, and remember that the pickup current is considerably higher than the sealed current. A maximum voltage drop of 5% is generally accepted.
- Calculate lighting feeder sizes, and do not allow more than 2% voltage drop or as allowable in the electrical code.
- Calculate the maximum harmonic distortion caused by the different adjustable speed drives. IEEE standard 519 (6) limits the total harmonic distortion at the point of metering to 5%. Check for resonance problems caused by harmonics. As a general rule, if the adjustable speed drives (AFD) short circuit ratio is higher than 20, there should be no harmonic problems.

$$\text{AFD short circuit ratio} \frac{\text{MVA}}{\text{MW}} \geq 20 \quad (2)$$

where

MVA = available short circuit in MVA

MW = total AFD load in MW

**Table 1. Average Consumption in Different Departments of Over 60 Wet-Process and Dry-Process Cement Plants**

	Raw Material Extraction	Clinker Production	Cement Grinding	Packing Shipping	Auxiliary Cost Centers	Total Plant
Average kWh/t	38	37.26	46.96	2.62	5.61	121.54
Lowest plant kWh/t	10.7	18.83	30.21	0.29	0.25	81.17
Highest plant kWh/t	68.91	82.7	67.08	9	27.4	200.1

The distribution system's resonant frequency harmonic is determined by using the following equation:

$$hr = \sqrt{\frac{MVA}{MVAR}} \quad (3)$$

where

hr = distribution systems resonant frequency

MVA = available short circuit in MVA

MVAR = capacitor bank rating in MVAR

If hr is a 5th, 7th, 11th, 13th, or  $\pm 0.5$  of these values, a reactor to tune the capacitor to the 5th harmonic is required even if the AFD short-circuit ratio is higher than 20. Power factor or  $\cos \varphi$  has to be calculated as power companies levy a penalty for low  $\cos \varphi$  (power factor); also problems with resonance with the power factor correcting capacitors must be investigated. When applying capacitors directly to motors, make sure that the size in kVAR for the capacitor does not exceed the recommendations for the kW and rpm for the motor. Remember that the application of capacitors will reduce the line current (check overload protection) and increase the voltage. This may be a cure for low-voltage problems and for increasing the capacity of the power distribution system.

**Cable Selection and Installation.** Cement plants have some unique environments requiring careful selection of the cable system. In some cement plants in the United States, the wiring is pulled in rigid steel conduit. This is a very inflexible method, but is an electrical code requirement in some counties and cities. Rigid steel conduit gives superior mechanical protection and is a very good shield for electrical noise, both electrostatic and electromagnetic. Under no circumstances should control and power wire be run in the same conduit.

The preferred wiring method is placing the cable in a cable tray. Interlocked steel armored cable with an overall polyvinyl chloride (PVC) cover is an excellent choice because it offers both mechanical, moisture penetration and noise protection. Furthermore, the PVC cover can be color-coded, differentiating between voltage levels. Control cables and power cables should not be placed in the same tray, but in separate cable trays located at least 0.5 m from each other. To avoid corrosion due to alkali attack, an aluminum tray should not be used, especially outside. Cable tray cable with no armor can also be used, but noise is a concern. Under no condition should single conductors in a three-phase system be used, either in a cable tray system or in its own conduit (each conduit has to contain all phase leads).

Cement plants have many very hot locations. Cables should never be placed over the clinker cooler or near other hot locations of the kiln system. Locating cables in cable trenches with covers is not recommended. The trenches will fill up with dust and prevent the cables from dissipating heat, thereby causing early failures. Cables are fire-rated in three groups. Group 1 does not propagate flames; consequently, group 1 is a good choice for cement plants.

If a cable is supplying adjustable frequency drives, it should be derated to compensate for the skin effect caused by the harmonic loading. Cable failures on these applications are also caused by high-voltage transients. If an investigation in-

dicates this is a problem, a cable with a higher voltage rating may be the solution.

**Electric Noise.** Electric noise is a major problem in cement plants because of the large drives, high number of adjustable frequency drives, and high input impedance control equipment. In order to have an electrical noise problem, there must be three elements: a source, a means of coupling, and a circuit sensitive to noise.

1. *Sources.* All electrical signals are potential sources of noise to any other signal. This makes it difficult to remove the source.
2. *Coupling.* An effort to minimize the coupling is the most practical technique to eliminate the electrical noise problem. This can be achieved by maintaining physical separation between the noise source and the sensitive equipment/control cable. All cable crossings should be at 90°.
3. *Protection Against Electrostatic Coupling.* Use shielded twisted wire with the shield connected to ground in one location. Unused wires should be grounded. The wire should have 12 twists per foot (4 twists per 10 cm).
4. *Protection Against Magnetic Coupling.* Use twisted conductors with 12 twists per foot (4 twists per 10 cm). A normal shield will help some, but to be truly effective the shield should be of magnetic material.
5. *Protection Against Electromagnetic Radiation.* It is very difficult, but shielded twisted pairs will give some protection.
6. *Protection Against Impedance Coupling.* Use one pair of twisted wire for each signal; do not use common return wire. Use separate power supply to sensitive circuits.

**Protection.** The protective relaying for a cement plant is not different from other power distribution systems described in this encyclopedia; however, because a cement plant may use several large synchronous motors, their protection has to include high-speed relays to protect against high-speed reclosing of the utilities breakers.

The large motors also need protection against switching surges and lightning; therefore, surge arrestors and surge protectors should be installed within 50 cm of their terminals. Large motors should have electronic protection units with at least overload, under voltage, winding temperature phase reversal, and single-phase protection.

**Metering.** Each department should be metered separately for energy management purposes. In addition, some feeders with high loads within a department may warrant separate metering equipment. Mill motors should have separate metering.

## ELECTRIC DRIVES

This section will list some general application notes about drives and drive application for specific equipment.

### General Application Notes

As already noted, cement plants have many hot locations; therefore, it may be necessary to derate motors or to use a



high-temperature insulation system such as Nema Class F. Several cement plants are located at a high altitude, which does require a special motor. The motor bearings should preferably be antifriction bearings with grease pressure relief valves and special seals as taconite seals. A totally enclosed fan-cooled (TEFC) enclosure made from gray cast iron is preferable. If an aluminum enclosure is substituted, the motor should not be exposed to moisture because the alkalis in the cement will corrode the aluminum. In dust-free locations, a drip-proof fully guarded motor may be used; however, outside one may be able to use weatherproof Nema type 1 or weatherproof Nema type 2. If a totally enclosed motor is mounted inclined or vertical, one must make sure that drains are located in the low spot of the housing.

Tables are published with recommended maximum Nema load inertia in  $wk^2$  from 1 hp (0.745 kW) to 800 hp (600 kW) and at speeds between 3600 rpm and 514 rpm. With all the high-inertia drive applications in a cement plant, it is necessarily to size the motors for the drive inertia.

Large drives, especially adjustable speed drives, should be checked for torsional vibrations. Control circuits for large motor drives should include a timer controlling the time between starts to prevent heat buildup.

#### Drive Applications for Specific Equipment

**Ball Mill Drives.** The ball mill is the single largest electric power-consuming device in a cement plant with a drive motor as big as 5000 kW. It is also important for the cement production and represents a large investment. A ball mill rotates at approximately 11 rpm to 15 rpm; therefore, it requires a gear reduction. The simplest and most reliable drive is a girth gear with a single pinion and a 200 rpm motor. An alternative is to use a higher-speed (600 rpm to 900 rpm) motor coupled to a gear reducer.

A mill trunion drive is often used in which the gear reducer is connected to the mill through a hollow trunion axle whose centerline corresponds to the mill's rotational centerline. The input speed to these drives are typically a 720 rpm motor. In considering a high-speed versus a low-speed drive the low-speed motor with no gear reducer is normally the most expensive; however, the low-speed drive requires less maintenance and has established a remarkable reliability. The required net torque on the motor output shaft is 110% to 150%. Pull-in torque is 120% to 130%, and for pull-out torque is 150% to 200%. If the drive motor cannot develop enough start torque, a clutch can be used. The drive motor can be a synchronous motor or a wound rotor motor. In the United States, the synchronous motor is used extensively. It has the advantage of reducing the plant's  $\cos \phi$  (power factor) by being designed to operate either at unity or at 0.8 leading  $\cos \phi$  (power factor).

A special type of synchronous motor has been used on some big mills where the rotor is built directly on the mill shell. To reduce the start current and to control the start torque, the power supply to these "wrap-around" synchronous motors is a cycloconverter. The advantage of the "wrap-around" constructions is that no mechanical gearing is used.

The wound rotor motor is used extensively in Europe because the start current and torque can be closely regulated. It is recommended that a liquid rheostat be used as the secondary resistor. Spotting or inching is the operation where

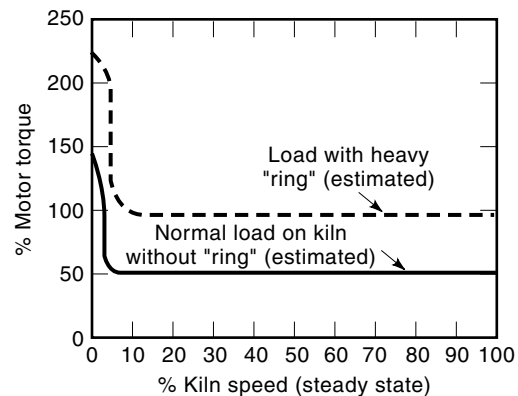

**Figure 5.** Torque required to start a kiln. Breakaway torques may increase up to 250 to 400% when load initially is held by backstop.

the mill is rotated at a low speed to position the manholes, thus facilitating the replacement of the ball charge. One method for spotting is an auxiliary Nema design c high-torque squirrel cage motor connected to the drive motor shaft through a gear reducer and electric-operated clutch. A braking system is also needed to prevent overspeeds if rollback occurs due to the exentric load in the mill.

Synchronous motors are also spotted by producing magnetic fields flowing through both stator and rotor. The rotor field is generated by the normal dc rotor field from a "spotting" dc generator. The stators rotating magnetic field of approximately 1% line frequency is produced by energizing the ac windings with the dc as controlled through six contactors and a sequencer.

The mill motors are normally pedestal-mounted with sleeve bearings. It is recommended that a wall be constructed between the mill and the motor enclosing the mill motor and its controls in a separate ventilated room. The motor insulation system should be of an abrasion-resistant Nema Class F, and the coils should be well tied down to prevent movements during start or spotting. In addition to its normal protection, the motor has surge protectors and capacitors installed, space heaters to keep the insulation dry, differential overcurrent protection, bearing temperature protection, and hot spot RTDs installed. The metering should be volt meter, ammeter, dc ammeter, kilowatt hour meter, and kilowatt meter.

**Kiln Drives.** The kiln is driven through a girth gear with the motor connected through a gear reducer, and sometimes V belt drives are connected to a pinion. The larger kilns may have two motors driving the kiln through independent drive components. A kiln is a long rotating tube with the load concentrated in the bottom; but due to the rotation, the load is sliding and cascading part way up one side. When the kiln is stopped loaded, gravity may try to rotate the kiln back and concentrate the load in the bottom. If the kiln is started with material in the bottom, a higher start torque is required than during a normal start where the kiln is empty.

Figure 5 depicts the required torque to start a kiln. As can be seen, 200% to 250% full load torque is required. The minimum continuous operating speed ranges should be three to one, but wider speed ranges are frequently specified. The kiln drive motors are mounted on an incline which requires special attention to the bearing specifications both due to the ad-

ditional axial thrust and to prevent water from running along the shaft into the bearing. The drive location of the kiln is hot; therefore, heat shields should be mounted between the kiln shell and the drives. With an plant locations ambient not exceeding 40°C the motor insulation should be designed for an ambient temperature of 50°C. Because of the possibility of an eccentric load, the kiln drive should be equipped with a backstop and protection against overspeeding when deenergized.

The kiln would be severely damaged if stopped due to a power failure or faulty motor; therefore, emergency drives are needed to turn the kiln slowly until a safe temperature is reached. Either an internal combustion engine or an electric motor supplied from an emergency generator can be used. These motors should be coupled to the main drive through devices protecting them against overspeeding and control the rollback.

Historically the kiln drive has been a dc drive capable of delivering the required torque and speed control. If two drives are used, load sharing is required to prevent excessive wear of the gearing. The preferred method is to connect the two motor armatures in series; however, for large motors, the armature currents may be too large for the brushes and commutators, in which case the motors must be connected in parallel and a very good load sharing controller used. Squirrel cage motors powered by vector-controlled inverters can be used for kiln drives; however, great care should be taken in sizing the motors and specifically the inverters.

**Fan Drives.** Cement plants, especially dry process plants, have many large fans in the kiln department. The air volume can be controlled either by dampers or by adjustable speed drives. Dampers are not an efficient method to control the air volume; therefore, adjustable speed drives are recommended. The following should be recognized in the application of electric motors for fan drives. Fan designers may calculate the connected motor kW at the operating temperature at the air handled; however, the motor has to start during a lower-than-normal operating condition.

Figure 6 depicts the difference in torque required. This condition can be alleviated by having a damper installed and close the damper when colder air is handled during start up and cool down.

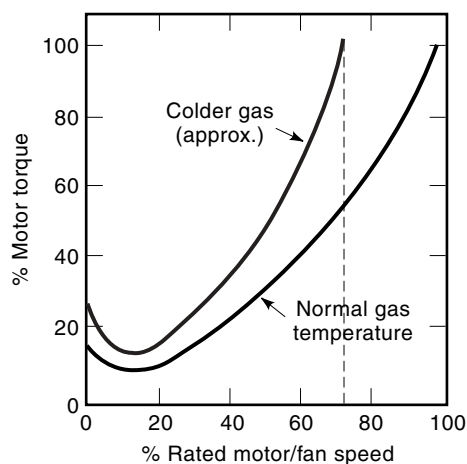

Figure 6. Different torque requirements.

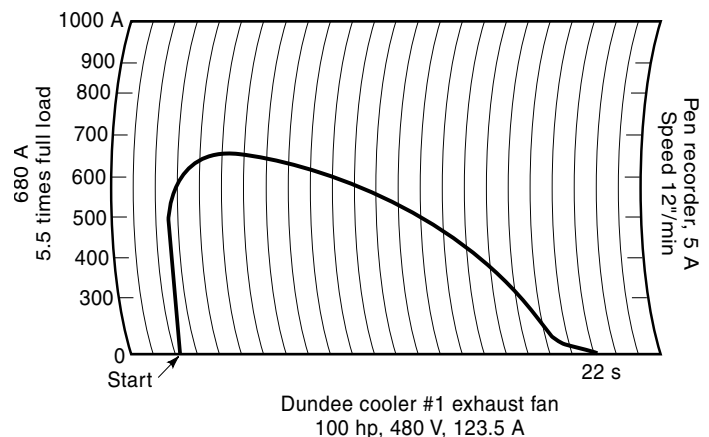

Figure 7. Across-the-line start of cooler fan.

Figure 7 shows a recording of a cooler fan which tripped the overload during startup due to ignoring the drives requirement for handling colder air. The problem was solved or more correctly bypassed by installing motor overloads with longer trip times. In the application of large fans, it is imperative to calculate the inertia ( $wk^2$ ) needed to accelerate the fan and to make sure that both the motor and power distribution system can handle the load.

Figure 8 shows a recording of the across-the-line start of a 1250 hp 4160 V squirrel cage motor starting an air foil fan across the line; note that the start time was 72 s at 5.25 times full load current. This is an extremely long start time; a more normal time is approximately 30 s. Many older fan drives with damper control are being converted to adjustable speed with a inverter power supply. It is recommended to retain the damper control as a backup and an aid in starting the fan when handling cold air. By the application of a bypass contactor the inverter can be removed for repair without process interruption. The one-line diagram in Fig. 4 shows this feature for the kiln exhaust and cooler exhaust fans.

**Conveyor Drives.** In designing a drive for a belt conveyor, the following should be considered. A conveyor stopped with load requires a considerable start torque to get running.

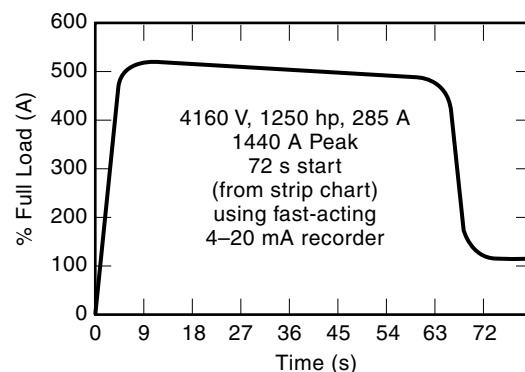
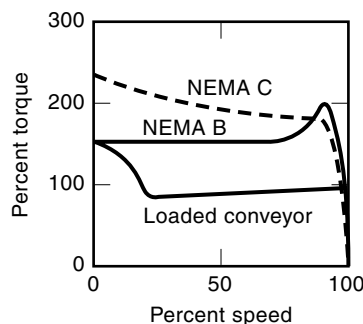

Figure 8. Recording of the across-the-line start of a 1250 hp 4160 V squirrel cage motor starting an air foil fan across the line.



**Figure 9.** Squirrel cage motor performance for Nema designs B and C.

Figure 9 indicates that a Nema design B squirrel cage motor may be marginal and that a Nema design C is a better choice. Generally, long belt conveyors require controlled torque and acceleration time to prevent excessive stresses and raising off the idlers during starting. Wound rotor motors, or squirrel cage motors with either a soft start controller or adjustable frequency drive, are generally used. If the belt is partly or entirely on an incline or decline, a hold-back and a brake are required to prevent reversal and free wheeling when the drive is deenergized.

**Clinker Cooler Drives.** Clinker coolers are normally in a hot and dusty environment; many coolers require adjustable speed drives, and generally dc or adjustable speed ac drives are used. The motors should be totally enclosed, fan-cooled with special bearing seals, and designed to operate at an ambient of 50°C if the plant ambient is below 40°C. For adjustable speed ac drives, it is recommended that an inverter one size bigger than required be used.

## CONTROL

Clinkers have been produced for over 100 years, yet today we do not have a clear picture of the physical and chemical reactions in a cement kiln. For more than 50 years the kiln operated on manual control only or with few loops using the simplest of automatic controls. Controls can be divided into two basic groups: (1) motor sequence and interlock controls, historically maintained by electricians, and (2) process controls, also called “analog controls,” maintained by instrument technicians.

### Motor Control

The motor control system protects the safety of personnel and the equipment from operating outside its design parameters. It directs the machinery to perform a specific task—for example, building and reclaiming a homogenizing pile; controlling the different arms, levers, and turntables on automatic cement bag palletizers; and so on.

The basic material handling controls for conveyors are as follows:

- Stop if the equipment down the line stops by interlocking to an auxiliary contact on the down-the-line conveyor’s main contactor.

- Stop if equipment down the line slows down using speed sensor.
- Stop if any emergency stops are actuated.
- Stop if the conveyor belt breaks as indicated by, for example, a limit switch on the belt conveyor’s counterweight.
- Stop in case of overload.
- Allow equipment to operate on manual with equipment interlocks bypassed, for maintenance purposes only.
- Incorporate the timer to limit the number of starts per hour if required.

Relay control has been used to perform these functions for many years; however, around 1969, on the encouragement of General Motors, three companies developed a device called a programmable logic controller. Two of these companies still make programmable logic controllers.

The programmable logic controller (PLC), as it is called today, was build for and marketed to the machine tool industry; however, in 1972, the first one was installed in a cement plant in Dundee, Michigan. However, it took several years before the PLC gained acceptance and widespread use in heavy industry. Today the PLC is widely used for motor control. Historically, the start and stop control has been done in impressive central control rooms with huge panels containing both the motor and process control. Today computer graphic display connected to personal computers (PCs) supplies the operators with a plethora of process and equipment status information. Motors are started and stopped, and process set points are manipulated with a click on a mouse. These displays are called Man Machine Interface (MMI).

### Process Controls

As late as the mid-1930s, enough control theory was postulated, and meaningful cement plant controls were manufactured and installed. Until the advent of computers, individual analog controllers were controlling different control loops with little interrelation. In the mid-1960s, computers found the way into cement plants. These early computers were using complex mathematical models of the process to manipulate the analog controllers. These early computers did not work very well. Only when adaptive computer models were used did computers have some measure of success.

The early computer system was direct digital control (DDC) with a centrally located computer. This big, complicated computer system did not have the reliability needed for cement plant control and was soon replaced by the familiar analog controllers each controlling a control loop.

It is recommended that the simplest possible control and control device be used. If a simple closed-loop discontinued system (e.g., thermostat or pressure switch) will do, use it. If a more sophisticated control is needed, check if an offset can be tolerated, then use a proportional controller; if not, use a proportional integral (PI) controller. A proportional integral derivative (PID) controller should be used only as the last choice. It is difficult to tune and difficult maintain in tune; furthermore, it is rarely needed for adequate control.

Distributed control systems, also marketed by some suppliers as a DCS control system, are performing both motor control process control and the man-machine interface. These systems should be divided so each subsystem is controlling a

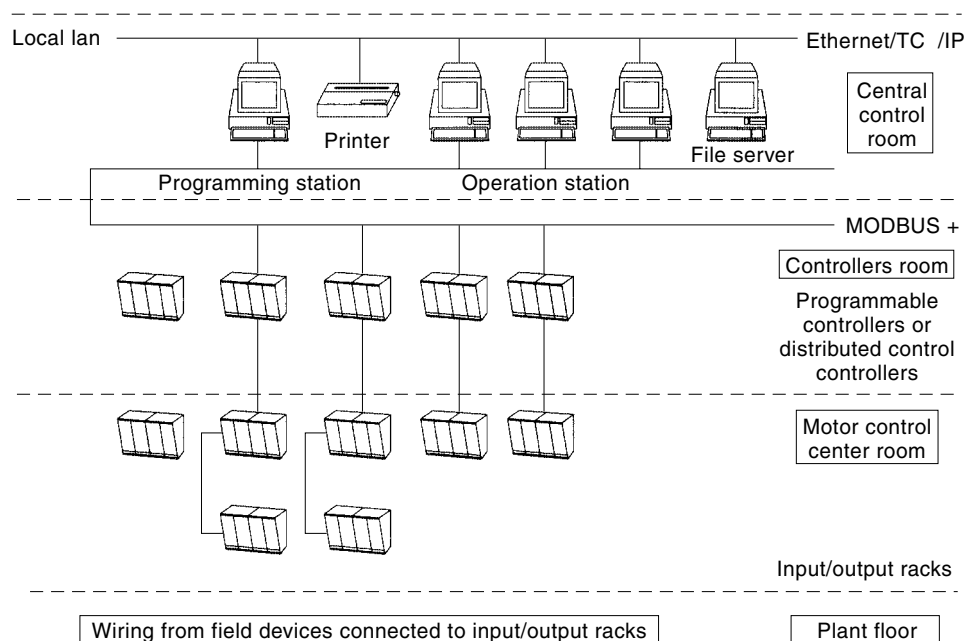

**Figure 10.** Connection of different department PLC or DCS field modules with central control rooms MMI.

separate department or major machine. A modern PLC can perform both process control (analog) and motor logic. PLCs can be used for DCS and connected to a personal computer (PC) with the MMI program in the central control room.

As the difference between a PC and PLC becomes less and less, a PC could be programmed to do the control functions and be connected to input–output modules which will filter out the plant noise. The trend is to get more and more smart devices in the field connected with open nonproprietary networks.

Figure 10 depicts the connection of the different department PLC or DCS field modules with the central control rooms MMI. A separate network also connects the high-level controls computer and the office PC's network.

**Kiln/Cooler Control.** The control system can be divided into the following subsystems:

- Raw mix feed into preheater (wet process into kiln).
- Rate of fuel to kiln.
- Recuperated heat from clinker entering as air through the kiln hood (secondary air).
- Volumes of gases leaving the cooler and preheater. (Wet process leaving kiln.)
- Revolution of kiln.
- Ratio of kiln feed rate to kiln speed.
- Clinker quality control by manipulating burning zone temperature. Inlet temperature reacts faster and may be used.
- Preheater retention time is only on the order of 25 s, in which time the raw meal is heated from approximately 50°C to 800°C and the gases cooled from 1100°C to 330°C. No control is possible except fuel to the precalciner.

The following manipulated process variables are generally used:

- Controller to stabilize cooler air.
- Velocity of cooler grates.
- Kiln speed.
- Fuel at kiln burner.
- Fuel at precalciner (dry process only).
- Control of tertiary air damper (dry process only).
- Pressure after preheater (dry process only).

The following input variables are generally used:

- Cooler undergrate pressure (individual compartments).
- Temperature of cooler grate plates.
- Kiln speed.
- Power demand of kiln drive.
- Kiln feed quantity.
- Burning zone temperature.
- Kiln inlet temperature.
- Tertiary air temperature (dry process only).
- Temperature after precalciner (dry process only).
- Temperature after preheater (dry process only).
- Analyses of free lime in clinker.
- Gas analyses of O<sub>2</sub> and CO at kiln inlet, and for a dry process after precalciner and preheater.
- Gas analyses of O<sub>2</sub>, CO, and NO<sub>x</sub> at preheater outlet (dry process only).
- Pressure and temperature after each cyclone (dry process only).

The cooler may have seven compartments under the grates with seven fans, all with piezometer sensors mounted in the

inlet to the fan. These readings are used to control the air volume by controlling dampers or adjustable frequency drives. The undergrate pressure in the first compartment is used to control the speed of the second compartment reciprocating grates, and the speed of the other compartments reciprocating grates are controlled in proportion to the second. The oxygen reading and the temperature profile of the process are used to control the kiln exhaust fan (ID fan) speed or damper opening. The material flow through the kiln is controlled with the kiln speed.

**High-Level Kiln Control.** The high-level control system is emulating the kiln operators. It is installed on top of the control system and is supplied with process data from the control system, and it will manipulate the controlled variables just like the operators. The high-level control system will increase production, decrease fuel consumption, and increase refractory life because of stable operation. The high-level control system programs are so large that they normally reside on their own computer. The programs are normally written using fuzzy logic, which has proven to be well-suited for cement kilns.

The inputs to the fuzzy logic are as follows:

- Burning zone temperature.
- Kiln rpm.
- Power input to kiln drive.
- Fuel quantity.
- Negative pressure in the kiln end housing.
- Temperature of exit gases.
- O<sub>2</sub> and NO<sub>x</sub> of exit gases.
- Volumes of primary air.
- Free lime of clinker.

The controlled variables are as follows:

- Fuel quantity.
- Kiln exhaust fan speed controlled by the O<sub>2</sub> in exit gases.
- Kiln speed.
- Kiln feed rate.

**Mill Control.** The purpose of the mill control is to maximize production of the mill by increasing the mill feed (clinker plus 5% gypsum) without overloading the mill (thereby avoiding spills), maintain a preselected blaine (fineness of the finished cement), and minimize the power consumption. It has been customary for many years to control the mill feed using the mill elevator amps. This is not a very good control; a good operator can judge the loading of the mill by listening to the grinding noise and, if needed, override the elevator amps. Several years ago a company invented a control system using microphones mounted very close to the mill shell to control the mill feed together with the elevator amps. This system is still used as part of a modern mill control. The blaine of the cement is controlled by the separator, which separates the finished product (fines) from the coarser particles which are recirculated to the mill. In effect, this recirculated material, together with the clinker and gypsum, becomes the mill feed. To further complicate matters, other materials (e.g., fly ash), are added to the mill feed.

A modern mill control system uses the following inputs:

- Bucket elevator power.
- Mill sound.
- Separator power.
- Circulating load.
- Mill drive power.

The only controlled variable is the mill feed. The separator speed is used to control the blaine.

#### REGULATIONS TO BURN HAZARDOUS WASTE DERIVED FUELS (HWDFs)

The cement kiln is a very good incinerator for HWDFs because the kiln has to be very hot and the material retention time very long to manufacture a product meeting all specifications to be sold as cement. Furthermore, the HWDFs add heat value to the fuel thus reduces the use of valuable fuels which can be used for other purposes. The cement kiln is also used for incinerating scrap tires either whole or shredded and can be used to dispose of a multitude of other products, as a matter of fact, a cement plant in Colorado burned used lottery tickets.

A cement kiln utilizing HWDF is considered an industrial furnace subject to EPA's regulations for boilers and industrial furnaces (BIFs). The BIF rules require that several operating parameters be "continuously monitored" to ensure that operations are maintained within the maximum or minimum values set during a compliance test. EPA defines a continuous monitor as "one which continuously samples the regulated parameter without interruption, evaluates the detector response at least once every 15 s, and computes and records the average value at least every 60 seconds." For several parameters, the regulations require an automatic shut-off of HWDF if a limit is exceeded.

#### ENVIRONMENTAL REGULATIONS

The passage of the 1970 Clean Air Act (The Act) and the subsequent amendments in 1977 and 1990 marked fundamental changes in the way that US industries conduct business. Prior to the 1970 regulations, measurement of emissions from industrial processes was unheard of. Stack emissions were the clear sign of industrial productivity and regarded as a necessary consequence of an industrial society. As a result of the 1970 Clean Air Act the United States Environmental Protection Agency (USEPA or EPA) targeted 20 specific air pollutants for regulation. These pollutants were deemed to pose the most serious threat to the health and safety of the American public. The most significant of these first targeted pollutants were the six so-called "criteria pollutants." These criteria pollutants are particulate matter (PM and PM<sub>10</sub>), sulfur dioxide (SO<sub>2</sub>), nitrogen oxides (NO<sub>x</sub>), carbon monoxide (CO) ozone measured as volatile organic carbon (VOC), and lead (Pb). Industry-specific emission rates for each of these pollutants are specified in The Act's New Source Performance Standards (NSPS) that are specified in Section 40, Part 60 of the Code of Federal Regulations. For example, the allowable particulate emission rates from cement kiln stacks and kiln

clinker coolers are 0.3 pound per ton of dry kiln feed and 0.1 pound per ton of dry kiln feed, respectively (1).

Under the old program, compliance with this (and any other) NSPS mission rate could *only* be demonstrated only by conducting a specific stack test method for a specific pollutant. These methods are rigorously defined in the regulations.

The 1990 Amendments to the Clean Air Act have completely redefined how compliance will be measured in the future. Through proposed programs like the Compliance Assurance Monitoring (CAM) and the Any Credible Evidence (ACE) rules, the EPA has vastly extended the methods available to regulatory agencies for determining the compliance status of an industrial source far beyond the handful of methods listed in Appendix A of 40 CFR 60. Under the proposed CAM rule, process parameters can be used as surrogate measures of emissions. The source owner has to specify the parameters to be monitored and demonstrate a correlation between the parameter and emissions. Once this relationship is established and accepted by the regulatory agency, the process parameter becomes the compliance issue rather than the measured emission rate of a particular pollutant from the process. For example, pressure drop across a baghouse is a favorite process parameter for use in this program. Under CAM an inspector would assess the compliance or noncompliance status of a source equipped with a baghouse based on the records of the pressure drop across a baghouse kept by the source rather than on a measured particulate emission rate emanating from the outlet duct of that baghouse (2).

The future of emission measurements from industrial processes will include the old methods specified in the existing Code of Federal Regulations as well as a completely new generation of process parameter surrogates for actual emissions. The new emphasis on process parameters will make the job of the instrumentation engineer simultaneously simpler and more difficult. Simpler because the instrumentation required to capture the compliance data will be less expensive and, presumably, easier to operate and maintain than the current continuous emissions monitoring systems.

## BIBLIOGRAPHY

1. J. M. Stensvaag, *Clean Air Act 1990 Amendments Law and Practice*, New York: Wiley Law Publications, 1991.
2. T. F. Sullivan, *Environmental Law Handbook*, 12th ed., Rockville, MD: Government Institutes, 1993.

### Reading List

- 277-1994 *IEEE Recommended Practice for Cement Plant Power Distribution*.
- 499-1997 *IEEE Recommended Practice for Cement Plant Electric Drives and Related Electrical Equipment*.
- 625-1990 *IEEE Recommended Practice to Improve Electrical Maintenance and Safety in the Cement Industry*.
- 519-1992 *IEEE Recommended Practices and Requirements for Harmonic Control in Electric Power Systems*.
- ANSI/NFPA 70 *National Electrical Code*.
- 141-1993 *IEEE Recommended Practice for Electric Power Distribution for Industrial Plants* (IEEE Red Book).
- 142-1991 *IEEE Recommended Practice for Grounding of Industrial and Commercial Power Systems* (IEEE Green Book).

242-1986 (R1991) *IEEE Recommended Practice for Protection and Coordination of Industrial and Commercial Power Systems* (IEEE Buff Book).

399-1990 *IEEE Recommended Practice for Industrial and Commercial Power Systems Analysis* (IEEE Brown Book).

446-1995 *IEEE Recommended Practice for Emergency and Standby Power Systems for Industrial and Commercial Applications* (IEEE Orange Book).

493-1990 *IEEE Recommended Practice for the Design of Reliable Industrial and Commercial Power Systems* (IEEE Gold Book).

739-1995 *IEEE Recommended Practice for Energy Management in Commercial and Industrial Facilities* (IEEE Bronze Book).

1015-1997 *IEEE Recommended Practice for Applying Low-Voltage Circuit Breakers Used in Industrial and Commercial Power Systems* (IEEE Blue Book).

1100-1992 *IEEE Recommended Practice for Powering and Grounding Sensitive Electronic Equipment* (IEEE Emerald Book).

IB BENTZEN-BILKVIST  
Holnam, Inc.

**CENTRAL AUTOMATION SYSTEMS.** See HOME AUTOMATION.