

In regard to mobile communications, a standard is simply a document that establishes technical requirements for the design, function, interoperability, and interworking of mobile stations, base stations, and mobile telecommunications networks.

Basically, there are two different types of standards: *de jure* and *de facto*.

A *de jure* standard is formed by committee. These standards can take many years to develop because the process used in committees tends to be long, bureaucratic, and political. Nevertheless, most of the mobile communications standards in use today are the result of standards committees.

A *de facto* standard is the result of a manufacturer or service provider dominating a market. A good example of a *de facto* standard is Microsoft Windows. Most personal computers (PCs) on the market today use Microsoft Windows, yet there is no standard in existence that specifies the use of this software on all PCs.

Voluntary Standards. *De jure* and *de facto* standards can be either voluntary or regulatory in nature. Voluntary standards are adopted by companies on a voluntary basis. There are no rules that say all manufacturers must comply with a voluntary standard. However, the advantages of compliance are many. In regard to mobile communications, a voluntary standard helps ensure that everyone who develops products will design/build their products for interoperability. Without this, only a few subscriber/infrastructure equipment manufacturers would win the market—those with the largest installed base.

Other advantages offered by complying with voluntary standards are:

- Increased productivity and efficiency in industry because of larger-scale, lower-cost production (e.g., the exponential reduction in the cost of hand-held mobile phones in the United States and the rest of the world is the direct result of the fact that the mobile communications standards-making bodies have published a limited number of voluntary standards).
- Increased competition by allowing smaller firms to market products. Voluntary standards are quite often at the forefront of technology development, and they provide a valuable source of knowledge to smaller carriers or subscriber/infrastructure equipment manufacturers in emerging markets.
- Quality control. By specifying minimum performance requirements for subscriber/infrastructure equipment, voluntary standards enable quality control to be maintained at a high level.

Regulatory Standards. Regulatory standards are created by government agencies and must be conformed to by the industry. In general, regulatory standards do not offer any major advantage to the carrier or the subscriber/infrastructure equipment manufacturer, but instead are in place (in most cases) to protect the consumer.

Regulatory standards are monitored by government agencies such as the Federal Communications Commission (FCC). These agencies ensure the protection of the public by enforcing standards covering safety, interconnectivity, electromag-

MOBILE TELECOMMUNICATIONS STANDARDS

What Is a Standard

Although there is no widely accepted and quoted definition of the term *standard*, the following definition from the 1979 National Policy on Standards for the United States encompasses the essential concept (National Standards Policy Advisory Committee, *National Policy on Standards for the United States*, 1979):

A prescribed set of rules, conditions, or requirements concerning the definition of terms; the classification of components; the specification of materials, performance, or operation; the delineation of procedures; or the measurement of quantity and quality in describing materials, products, systems, services, or practices.

netic emissions, and in some cases health. A good example is the FCC Code of Regulations (Title 47), Part 15—"Radio Frequency Devices," Subpart A—*General*, Subpart B—*Unintentional Radiators*, Subpart C—*Intentional Radiators*, and Subpart D—*Unlicensed Personal Communication Service Devices*.

Mobile Communications Standards-Making Process

The mobile communications standards-making process involves cooperation between hundreds of diverse organizations at many levels—both national and international. Cooperation exists between industrial concerns within a country (e.g., carriers and subscriber/infrastructure equipment manufacturers), between industrial concerns and their national governments (e.g., carriers and regulatory agencies), and between nations.

The mobile communications standards-making process is hierarchical in nature and can be categorized into three tiers:

- Base standardization
- Functional standardization
- Conformance standardization

The *base standardization* process requires the participation of international standards-making bodies. Base standards typically incorporate alternative specifications in their requirements in order to satisfy varying regional/national needs. They offer the implementor a degree of flexibility. Adopting the alternative specifications means that, even though the implementation will be in compliance with the base standard, there is no guarantee that equipment based on separate alternative specifications will be interoperable.

The problem of interoperability is tackled to a large extent by the *functional standardization* process, which requires the

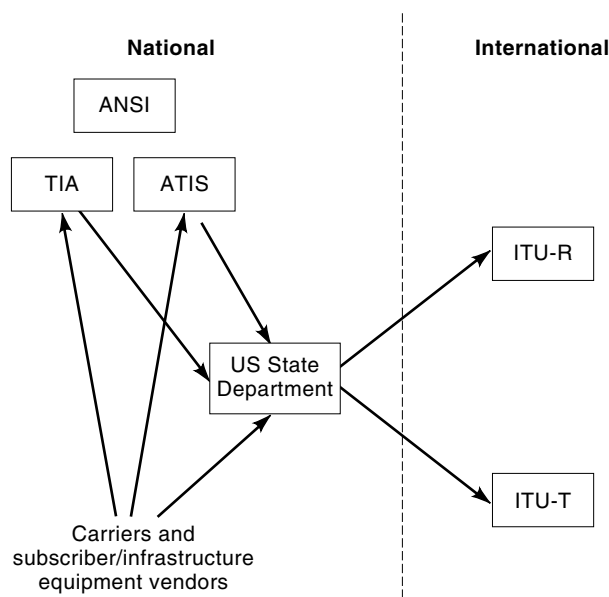

Figure 1. Example mobile communications standards-making process in the United States. ANSI: American National Standards Institute; TIA: Telecommunications Industry Association; ATIS: Alliance for Telecommunication Industry Solutions; ITU: International Telecommunications Union.

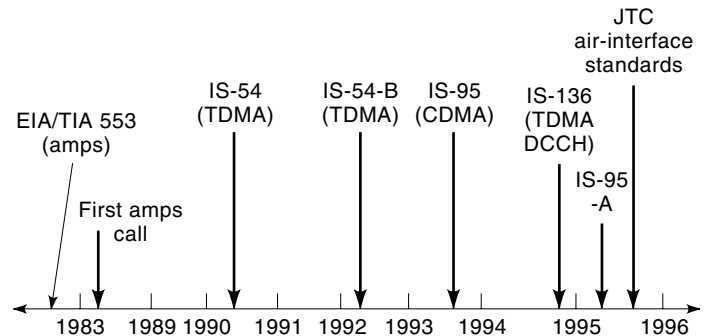

Figure 2. Timeline for North American mobile communications standards.

participation of regional/national standards-making bodies. Confronted with a much more specific set of requirements than international standards-making bodies, regional/national standards-making bodies tend to adopt base standards as functional standards that incorporate only a limited subset of the permissible base standard alternative specifications.

The conformance standardization process is the most narrowly focused. Conformance standards prescribe test specifications and methods, which specialized test houses must use when they conduct conformance tests to certify products.

Figure 1 shows an example of the mobile communications standards-making process in the United States.

What all of this means is that, due to the amount of cooperation required in the standards-making process and its hierarchical nature, standardization takes a long time. How long? Figures 2 and 3 illustrate North American and European mobile communications standards timelines, respectively. The process of migrating from purely analog cellular systems to analog/digital cellular systems has taken approximately 10 years in both North America and Europe.

MOBILE COMMUNICATIONS STANDARDS ORGANIZATIONS

Mobile communications standards are the result of years of research and development conducted by many different international and national standards organizations. Within these standards organization there are a myriad of study groups

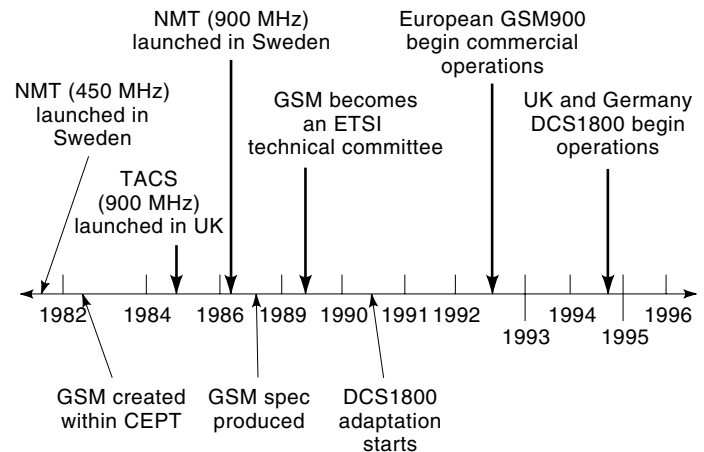

Figure 3. Timeline for European mobile communications standards.

and working groups that come and go as the need arises. Many independent forums also evolve. Typically, they are composed of government agencies, carriers, and subscriber/infrastructure equipment manufacturers representing many different countries.

International Standards Organizations

ITU. The ITU (International Telecommunications Union) is a United Nations (UN) treaty organization whose purpose is to develop standards that will allow end-to-end compatibility between international radiocommunications and telecommunications networks. Founded in 1865 as the Union Télégraphique, the ITU is organized into three sectors: the Radiocommunication Sector (ITU-R), the Telecommunication Standardization Sector (ITU-T), and the Telecommunication Development Sector (ITU-D). Figure 4 shows the organizational structure of the ITU. Even though the ITU has not developed any significant mobile communication standards, it is likely to play a significant role in development of third-generation mobile communication standards.

The primary responsibility of the ITU-R (known as the CCIR prior to 1993) is to develop technical standards in the radiocommunication field. The ITU-R is composed of eight *study groups* (SGs). The key SG for mobile communications standards development is SG 8 (mobile, radiodetermination, amateur, and related satellite services). Under SG 8 is Task Group 8/1 (TG 8/1). TG 8/1 is responsible for International Mobile Telecommunications-2000 (IMT-2000), formerly known as Future Public Land Mobile Telecommunication Systems (FPLMTS). IMT-2000 is the ITU-R name for third-generation digital cellular systems.

The primary responsibility of the ITU-T (known as the CCITT prior to 1993) is to develop technical standards in the telecommunications field. The ITU-T is composed of fourteen SGs. The key SGs for mobile communications and IMT-2000 standards development are SG 2 (network and service operation), SG 4 [Telecommunications Network Management (TNM) and network maintenance], SG 7 (data networks and open system communications), SG 11 (signaling requirements and protocols), SG 13 (global infrastructure), and SG 16 (multimedia services and systems).

The primary responsibility of ITU-D is to promote and offer technical assistance to developing countries in the field of telecommunications and also to promote the mobilization of the material and financial resources needed for implementation. The ITU-D consists of two SGs.

ISO. Established in 1947, the ISO (International Standards Organization) is responsible for many data communications standards, including the *open systems interconnection* (OSI) model. The ISO is divided into more than 150 technical committees. The key technical committee for mobile communications standards development is the Joint ISO/IEC (International Electrotechnical Commission) Technical Committee 1 (JTC1). Established in 1987, its scope is information technology, and it collaborates closely with ITU-T. Under JTC1 is Subcommittee 6 (SC 6). JTC1/SC 6 deals with telecommunications and information exchange between systems.

The ISO is composed of standards bodies from various countries—mostly government agencies responsible for set-

ting communications standards within their own governments. The United States representative is ANSI.

North American (United States) Standards Organizations

ANSI. At the forefront of the United States telecommunications standardization process is the American National Standards Institute (ANSI). Founded in 1918, ANSI is responsible for accrediting other U.S. standards-making bodies. The two key ANSI accredited standards-making bodies for mobile communications standards development are the Telecommunications Industry Association (TIA) and the Alliance for Telecommunications Industry Solutions (ATIS). Figure 5 depicts the U.S. standards organizations.

TIA. The TIA was formed in 1988 from the combination of the Information and Telecommunications Technology Group of the Electronics Industries Association (EIA) and the US Telecommunications Suppliers Association. The charter of the TIA is the formation of new telecommunications standards. Specifically, it develops standards for technologies as diverse as telecommunications networks, fiber optics, mobile communications, and satellite communications. The TIA is still associated with the EIA and is an ANSI-accredited standards-making body composed primarily of subscriber/infrastructure equipment manufacturers (carriers also participate in the standards committees, but are not full members of the TIA). The TIA has developed most of the mobile communications standards used in the United States today. TIA has changed its charter in 1998 to allow membership of organizations in Canada and Mexico.

The TIA primarily develops what are known as *interim standards* (ISs) (e.g., IS-95-A and IS-136-A). These standards have a limited life span of 3 years. An IS can eventually become a full ANSI standard if it is agreed upon by the larger membership of ANSI.

The TIA is composed of many committees that develop mobile communications and other telecommunications standards. Many of the committees are designated as TR committees (the designation is a relic of the term *transmission*, which was the original technology being standardized in the early days of the EIA). The key TR committees for mobile communications standards development are TR-45 (Public Mobile and Personal Communications Standards) and TR-46 (Public Mobile and Personal Communications Standards).

TR-45. TR-45 is responsible for the development of mobile communications and personal communications services (PCS) standards in the licensed 800 MHz and 1900 MHz bands [e.g., Advanced Mobile Phone Service (AMPS), D-AMPS, and CDMA].

Specifically, TR-45 develops ANSI standards, IS standards, Telecommunications Systems Bulletins (TSBs), and technical reports pertaining to the performance, compatibility, interoperability, and service descriptions of mobile communications and PCS. TR-45 also develops and recommends positions on related subjects under consideration by other domestic and international standards forums. TR-45 is composed of six subcommittees (see Fig. 5):

- TR-45.1 (Analog Technology—Mobile and Personal Communications Standards) works on analog standards (e.g., EIA/TIA-553).

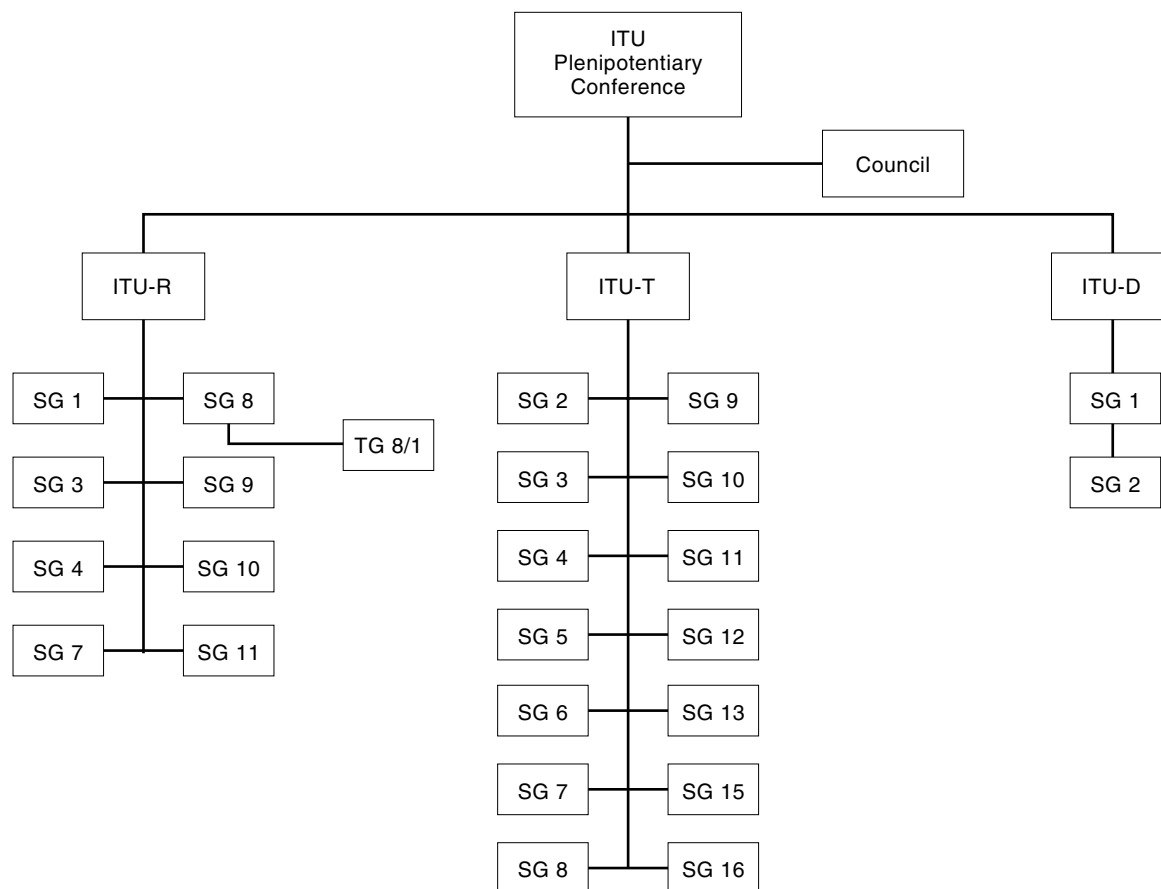

ITU-R Study Groups

- SG 1 — Spectrum management
- SG 3 — Radiowave propagation
- SG 4 — Fixed-satellite service
- SG 7 — Science services
- SG 8 — Mobile, radiodetermination, amateur, and related satellite services
- SG 9 — Fixed service
- SG 10 — Broadcasting service (sound)
- SG 11 — Broadcasting service (television)

ITU-T Study Groups

- SG 2 — Network and service operation
- SG 3 — Tariff and accounting principles
- SG 4 — Telecommunications network management (TNM) and network maintenance
- SG 5 — Protection against electromagnetic environment effects
- SG 6 — Outside plant
- SG 7 — Data networks and open system communications
- SG 8 — Characteristics of telematic systems
- SG 9 — Television and sound transmission
- SG 10 — Languages and general software aspects for telecommunications systems
- SG 11 — Signaling requirements and protocols
- SG 12 — End-to-end transmission performance of networks and terminals
- SG 13 — General network aspects (including, GII)
- SG 15 — Transport network, systems, and equipment
- SG 16 — Multimedia services and systems

ITU-D Study Groups

- SG 1 — Telecommunication development strategies and policies
- SG 2 — Development, harmonization, management, and maintenance of telecommunication networks and services, including spectrum management

Figure 4. ITU structure.

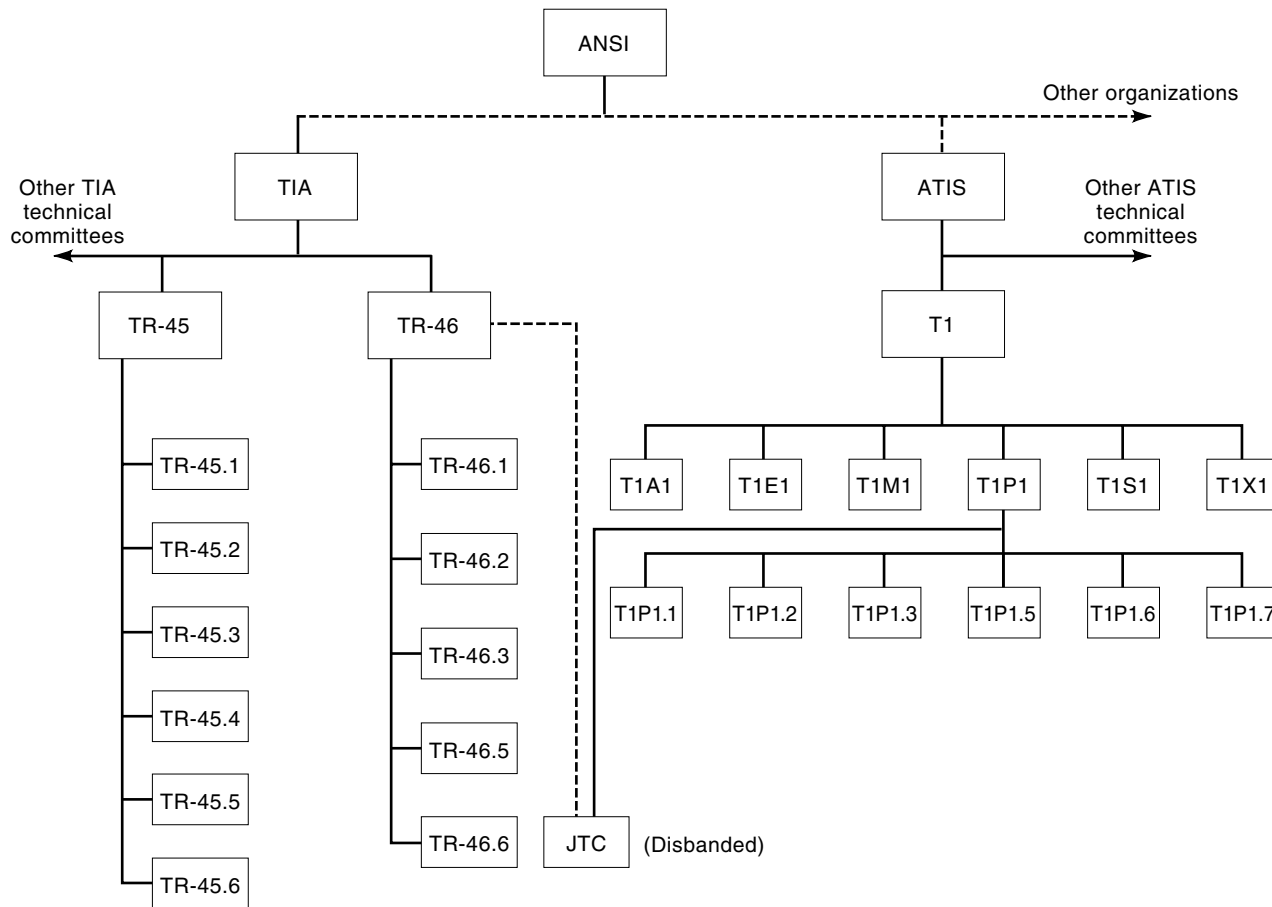

TIA

TR-45.1 — Analog Technology
 TR-45.2 — Wireless intersystem technology
 TR-45.3 — Time division digital technology
 TR-45.4 — Radio switching technology
 TR-45.5 — Spread spectrum digital technology
 TR-45.6 — Adjunct wireless packet data
 TR-46.1 — Wireless ISDN multimedia services
 TR-46.2 — Personal communications services intersystem operation
 TR-46.3 — Air interface
 TR-46.5 — PCS 1900
 TR-46.6 — Composite CDMA/TDMA

ATIS

T1A1 — Performance and signal processing
 T1E1 — Interfaces and protection for
 T1M1 — Networks
 T1P1 — Internetwork operations, administration, maintenance, and provisioning (OAM&P)
 T1S1 — Wireless/mobile services and signaling
 T1X1 — Digital hierarchy and synchronization

T1P1.1 — International personal communications services
 T1P1.2 — coordination
 Personal communications service descriptions and network architecture
 T1P1.3 — Personal advanced communications system (PACS)
 T1P1.5 — PCS 1900
 T1P1.6 — CDMA/TDMA
 T1P1.7 — Wideband CDMA

Figure 5. North American mobile communications standards organization.

- TR-45.2 (Wireless Intersystem Technology—Mobile and Personal Communications Standards) develops standards for intersystem operations (e.g., ANSI TIA/EIA-41).
- TR-45.3 (Time Division Digital Technology—Mobile and Personal Communications Standards) develops TDMA air interface standards (e.g., TIA/EIA/IS-136).
- TR-45.4 (Radio to Switching Technology—Mobile and Personal Communications Standards) develops stan-

dards for the interface of base stations to mobile switching centers (MSCs) (e.g., TIA/EIA/IS-634).

- TR-45.5 (Spread Spectrum Digital Technology—Mobile and Personal Communications Standards) is responsible for the development of CDMA standards (e.g., TIA/EIA/IS-95-A).
- TR-45.6 (Adjunct Wireless Packet Data Standards) is developing an industry standard based on the cellular digital packet data (CDPD) specifications, which were devel-

oped by the CDPD industry forum. The subcommittee will also work on other data standards for cellular and PCS.

Committee TR-45 also has a number of ad hoc groups that address specific technical topics but do not develop standards. The main ad hoc groups at present are the Authentication Ad Hoc Group, the Network Reference Model Ad Hoc Group, the Operations, Maintenance, Administration, and Provisioning (OMA&P) Ad Hoc Group, the Wireless Local Loop Ad Hoc Group, and the International Standards Development Ad Hoc Group.

TR-46. TR-46 develops and maintains performance, compatibility, interoperability, and service standards for PCS operating in the licensed 1900 MHz band and the unlicensed 1900 MHz band. TR-46 is now primarily limited to standards that are based on GSM and DCS-1800, which have been standardized in ETSI.

TR-46 is comprised of four subcommittees (see Fig. 5):

- TR-46.1 (Wireless ISDN Multimedia Services) develops standards for wireless multimedia services. Current efforts include definition of a wideband CDMA technology.
- TR-46.2 (Personal Communications Services Intersystem Operation) addresses cross technology issues including RF interference mitigation. TR46.2 published standards for interworking/interoperability between DCS 1900 (GSM) and IS-41-based mobile application parts (MAPs) for 1800 MHz PCS in 1996.
- TR-46.3 (Air Interface) is inactive but listed here because of the standards that were developed during the liaison between TR-46 and Committee T1 via the JTC.
- TR-46.5 (PCS 1900) concentrates on the enhancement and evolution of the PCS 1900 MHz family of standards [e.g., J-STD 007, An Air Interface for Personal Communications (GSM-based) for 1.8 GHz to 2.2 GHz].
- TR-46.6 (Composite CDMA/TDMA) develops and enhances the standards for the composite CDMA and time division multiple-access (TDMA) mobile communications systems.

When the FCC started the process of spectrum allocation in the PCS band, a Joint Technical Committee (JTC) was formed with the ATIS Committee T1 (see Fig. 5) to develop standards for operations in the new spectrum at 1.9 GHz. Several air interface standards were successfully completed and are still awaiting publication. Future revisions of these documents will not be handled by JTC, but rather by a lead organization, as per agreement between the TIA and Committee T1. Now that the work on the PCS standards has been completed, the JTC has been disbanded and the standards work on the air interfaces has been moved back to the TIA and T1 parent subcommittees.

ATIS. The ATIS was created in 1983 as part of the breakup of the Bell System. Initially, ATIS was known as the Exchange Carriers Standards Association (ECSA) and sponsored Committee T1 to give the exchange carriers a voice in the creation of interconnection standards, which had previously been done de facto by AT&T.

Committee T1. Established in February 1984, Committee T1 develops standards regarding the interconnection and interoperability of telecommunications networks with end-user systems, carriers, customer premises equipment (CPE), and information/enhanced-service providers.

Committee T1 is composed of six technical subcommittees (TSCs) (see Fig. 5) that are advised and managed by the T1 Advisory Group (T1AG):

- T1A1 (Performance and Signal Processing)
- T1E1 (Interfaces, Power, and Protection for Networks)
- T1M1 (Internetwork Operations, Administration, Maintenance, and Provisioning)
- T1P1 (Wireless/Mobile Services and Systems)
- T1S1 (Services, Architectures, and Signaling)
- T1X1 (Digital Hierarchy and Synchronizations)

Each technical subcommittee develops standards and technical reports in its designated area of expertise. The key TSC for mobile communications standards development is T1P1.

T1P1. Subcommittee T1P1 is composed of six working groups (see Fig. 5):

- T1P1.1 (International Personal Communications Services Coordination).
- T1P1.2 (Personal Communications Service Descriptions and Network Architectures) addresses reference models and Stage 1 service descriptions.
- T1P1.3 (Personal Advanced Communications Systems, PACS) developed J-STD 014, PAC-UA, and PAC-UB.
- T1P1.5 (PCS 1900) addresses all aspects of PCS 1900 standards (e.g., J-STD 007). The subcommittee is currently working closely with ETSI Special Mobile Group (SMG) on developing services and features for the Groupe Spécial Mobile (GSM) specifications required for North America.
- T1P1.6 (CDMA/TDMA) developed TIA/EIA/IS-661.
- T1P1.7 (Wideband-CDMA) developed TIA/EIA/IS-665.

European Standards Organizations

In 1990 the European Community (EC) set up the European Standardization Organization (ESO) to oversee the activities of European standards-making bodies such as the Comité Européen de Normalisation (CEN), the Comité Européen de Normalisation Electrotechnique (CENELEC), and the European Telecommunications Standard Institute (ETSI).

ETSI. The Conférence Européenne des Administrations des Postes et des Télécommunications (CEPT) was formed in 1958 by the European postal, telephone, and telegraph (PTT) authorities to harmonize the development of European telecommunications standards. It covers all of the countries of the EC and the European Free Trade Association (EFTA) in addition to PTTs from various European countries. In 1988, CEPT set up an independent body called the ETSI to conduct all telecommunications standards meetings on its behalf. Although the ETSI is an independent organization funded by its members, who decide on its work program, the EC and

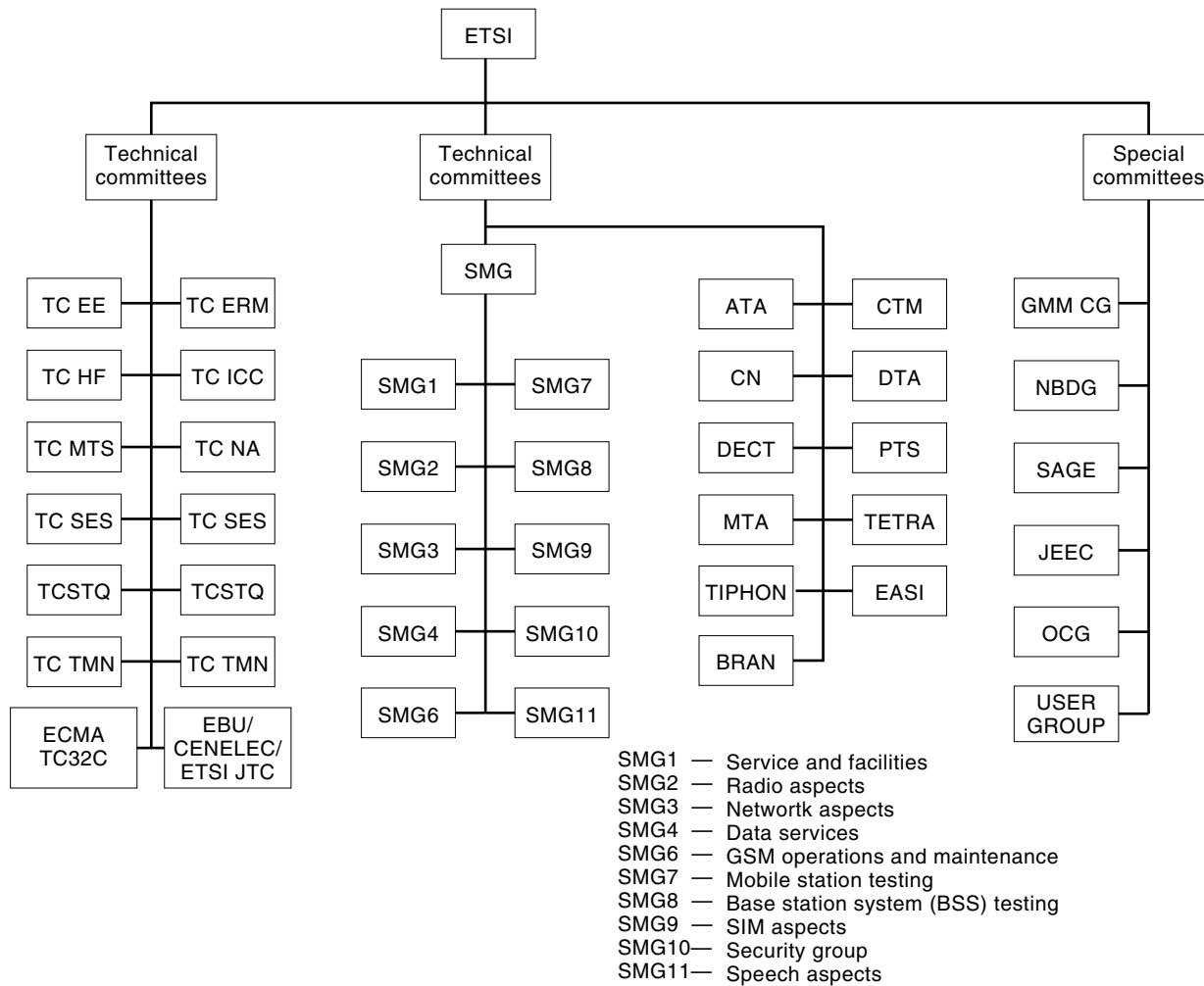

Figure 6. ETSI structure.

EFTA can also fund the ETSI to produce specific standards of interest to the EC. The ETSI's main interest lies in the area of telecommunications, although it also participates in issues relating to information technology, for which it cooperates with CEN/CENELEC.

The principal role of the ETSI is telecommunications, information technology, and broadcasting standardization. The ETSI membership includes administrations, national standards organizations, subscriber/infrastructure equipment manufacturers, subscriber groups, research bodies, and carriers. Under the ETSI are technical committees (TCs), ETSI projects (EPs), and special committees (SCs). Figure 6 shows the organizational structure of the ETSI, with emphasis on the EP SMG.

Within the ETSI, there are a total of twelve TCs (with two joint technical committees), twelve EPs, and six SCs. The key EP for mobile communications standards development is the EP SMG, which develops standards for the GSM family of digital mobile communications systems (i.e., GSM 900, DCS 1800, and UMTS) with a built-in capability for unrestricted world-wide roaming of users and/or terminals between any networks belonging to this family. ETSI SMG is made up of

10 SMG technical committees (STCs) and a Project Team (PT) (see Fig. 6):

- SMG1 (Services and Facilities)
- SMG2 (Radio Aspects)
- SMG3 (Network Aspects)
- SMG4 (Data Services)
- SMG6 (GSM Operations and Maintenance)
- SMG7 (Mobile Station Testing)
- SMG8 [Base Station System (BSS) Testing]
- SMG9 (SIM Aspects)
- SMG10 (Security Group)
- SMG11 (Speech Aspects)

Recently, the EP SMG has instituted a set of formal working procedures with T1P1 for the establishment, evolution, and maintenance of common GSM specifications.

Japanese Standards Organizations

Wireless standards in Japan are set by two organizations: the Association of Radio Industry Business (ARIB) and the Telecommunication Technology Committee (TTC).

The ARIB was established by the Ministry of Posts and Telecommunications in June 1995 as “the Realization Center for Efficient Use of Radio Spectrum.” The objectives of the ARIB are to develop standards for mobile communications systems and conduct research on the utilization of various wireless technologies.

The TTC was established as a private standardization organization in October 1985 to contribute to telecommunications standardization by establishing protocols and standards for interconnections between telecommunications networks.

Industry Forums

As the cellular industry matured, industry forums composed of carriers and subscriber/infrastructure equipment manufacturers began to evolve. These forums are primarily for the purpose of promoting a particular technology; however, they can also provide a means for specifying technical requirements, which may then be introduced into formal mobile communications standards-making bodies such as the TIA for the purpose of generating a new standard or for incorporation into an existing standard.

In regard to mobile communications standards development in North America, the key industry forums are: Cellular Telecommunications Industry Association (CTIA), Personal Communications Industry Association (PCIA), Universal Wireless Communications Consortium (UWCC), CDMA Development Group (CDG) and GSM North America (GSM NA).

CTIA. The CTIA established in 1984, represents all of the players in the wireless industry in North America—all commercial mobile radio service providers including cellular, personal communication services, enhanced specialized mobile radio, and mobile satellite services, as well as manufacturers of wireless devices and infrastructure equipment. CTIA has provided a forum for resolution of industry-wide issues and has guided the development of standards in TIA TR-45 and TIA TR-46.

PCIA. The PCIA represents wireless communication industry in North America. The association has been at the forefront of advancing regulatory policies, legislation and technology standards for PCS.

UWCC. The UWCC is a limited liability corporation established in 1995 to support an association of carriers and subscriber/network infrastructure equipment manufacturers that develop, build, and deploy products and services based on IS-136 TDMA and IS-41 WIN standards. The primary work of the UWCC is accomplished through general membership activities and the principal UWCC forums. The UWCC is composed of three forums: the Global TDMA Forum (GTF), the Global WIN Forum (GWF), and the Global Operators Forum (GOF) (see Fig. 7).

CDG. The CDG (CDMA Development Group) is an industry consortium of companies that have come together to develop the products and services necessary to promote the adoption of CMDA mobile communications systems around the world.

The CDG is composed of the world’s leading carriers and subscriber/network infrastructure equipment manufacturers.

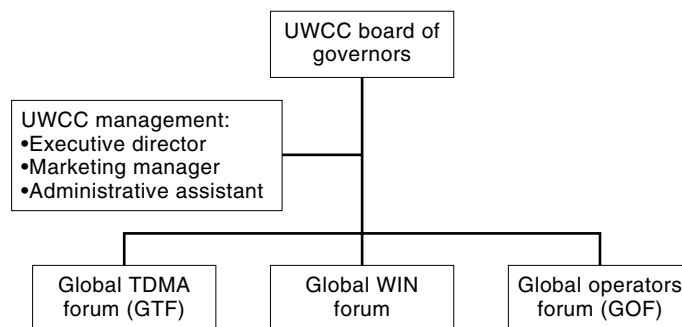

Figure 7. UWCC structure.

By working together, the members will help ensure interoperability among systems while extending the availability of CDMA technology to consumers. The CDG is composed of several technical groups (TGs), a Promotions/Conferences/Education Group, a Next Generation Systems Group, and an International Working Group (see Fig. 8).

GSM NA. GSM North America (GSM NA) is the North American interest group (NAIG) of the GSM MoU Association. This forum has been created to promote PCS1900 service providers’ business interests. The membership consists of the GSM/PCS1900 operators; however, manufacturers are allowed to participate. GSM NA has a number of working groups, which are primarily responsible for addressing and resolving issues from a high-level end user prospective (see Fig. 9).

AIR INTERFACE STANDARDS

First-Generation Analog Cellular Systems

AMPS. The development of mobile communications systems started during the 1930s. The first two-way mobile telephone system was placed into service by the New York City Police Department in 1933. In 1947, a major breakthrough occurred when the concept of cellular mobile communications was discovered. Cellular mobile communications replaces a single large cell (consisting of a single high-power transmitter which provides coverage to a large service area) with many small cells (consisting of many low-power transmitters, each of which provides coverage to only a small portion of a large service area). By dividing a large service area into small cells and using low-power transmitters, frequencies assigned in one small cell can be reused in another small cell. This significantly increases the traffic capacity. Unfortunately, due to technological limitations at the time (e.g., the transistor had not even been invented yet), the implementation of the cellular concept was delayed until the 1980s.

In 1975, AT&T was granted a license to operate a developmental cellular radio system in Chicago. Subsequently, AT&T formed a separate subsidiary known as Advanced Mobile Phone Service (AMPS) and on October 13, 1983, in Chicago, AMPS became the first cellular radio system to be put into operation. The modulation scheme for AMPS was FM (frequency modulation) for voice and FSK (frequency shift keying) for signaling. The multiple access scheme was FDMA (frequency division multiple access).

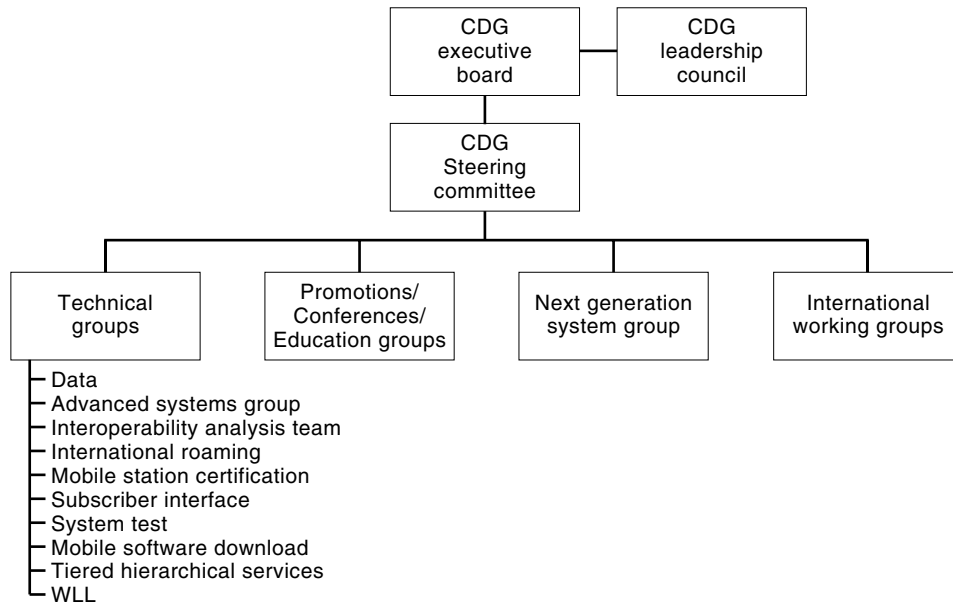

Figure 8. CDG structure.

EIA/IS-3. In order to make AMPS commercially viable, the development of an AMPS mobile communications standard was essential. This would ensure that an AMPS subscriber would be able to obtain service from any wireline or nonwireline carrier with a license to operate an AMPS cellular system. The first mobile communications standard in North America was the FCC Office of Engineering and Technology Bulletin No. 53, which included EIA/IS-3 and its revisions.

Control Channel Signaling. Signaling information is transferred on the EIA/IS-3 control channel via FSK. The data rate is 10 kbit/s. It is Manchester-encoded to allow the receiver to track the phase and to prevent any dc bias from creeping into the signal via a long series of ones or zeros in the baseband data.

On the *forward control channel (FCC)*, 10 words follow a dotting/sync sequence. Words are alternated A, B, A, B, etc. and repeated 5 times for diversity, with the A words designated for mobile stations with even number MINs (mobile station identification numbers) and the B words designated for mobile stations with odd number MINs. An FCC word is 40 bits long. Each word has BCH error correction/detection

included, so that the data content is 28 bits and parity is 12 bits. The FCC is interleaved with busy/idle (B/I) bits.

On the *reverse control channel (RCC)*, 5 words follow a dotting/sync sequence. An RCC word is 48 bits long, and each word has BCH error correction/detection included, so that the data content is 36 bits and parity is 12 bits. Each word is repeated 5 times for diversity. Messages are sent by the mobile station on the RCC as coordinated with the base station via the B/I bits sent on the FCC.

Voice Channel Signaling. Signaling on the voice channel is divided into in-band and out-of-band signaling. In-band signaling occurs when control signals between 300 Hz and 3000 Hz replace the voice signal. In-band signals on the voice channel are blank-and-burst FSK digital messages. To inform the receiver that a control signal is coming, a 101 bit dotting sequence, which produces a 5 kHz tone, precedes the message. Blank-and-burst signaling on the voice channel differs between the forward and the reverse direction. On the *forward voice channel (FVC)*, messages are repeated 11 times for diversity. Words contain 40 bits and have 12 bits of BCH error correction/detection included. On the *reverse voice channel*

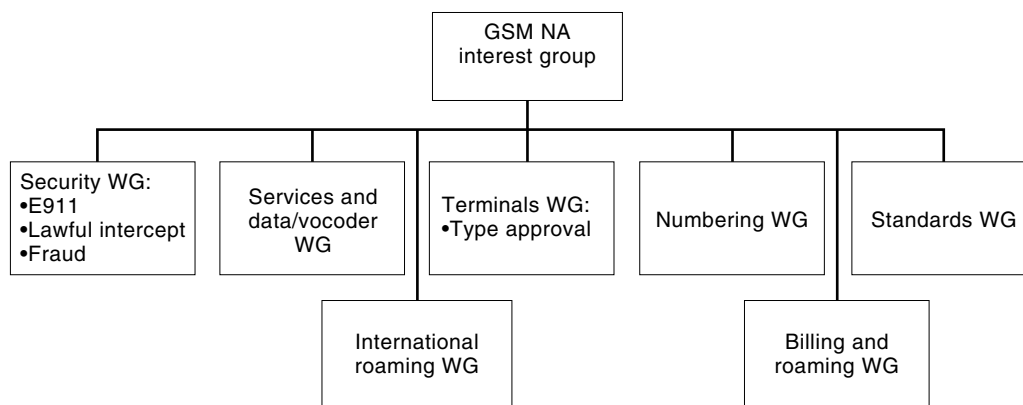

Figure 9. Structure of GSM NA working groups.

Table 1. Key North American Analog Standards^a

Standard	Publication Date	Authentication	MWI	CLI	SMS
EIA/TIA-553 (Basic AMPS)	Sept. 1989	NA	NA	NA	NA
TIA/EIA/IS-88 (NAMPS)	Jan. 1993	NA	EP	EP	EP
TIA/EIA/IS-94 (Private PBX)	Dec. 1993	NA	NA	NA	NA
TIA/EIA/IS-91 (553 + 88)	Dec. 1993	Yes	EP	EP	EP
TIA/EIA/IS-91-A (91 + 94 + WRE)	1998 ^b	Yes	MWN + EP	AWI/FWI + EP	AWI-SMS + EP
EIA/TIA-553-A Core Standard	1998 ^b	Yes	MWN	AWI	NA
ANSI TIA/EIA-691	1998 ^b	Yes	MWN + EP	AWI + EP	AWI-SMS + EP

^a Definitions: MWI, message waiting indicator; CLI, calling line identification; SMS, short-message service; EP, extended protocol (an optional mechanism to deliver the optional features (MWI, CLI, SMS); MWN, message waiting notification (an order that is used to indicate the number of messages in the mailbox); AWI, alert with information (an order that is used to alert the user that certain information has been delivered with caller ID); FWI, flash with information (an order that is used to send certain information to the mobile without alerting the user); AWI-SMS, alert with information—short-message services (an optional order that is used to alert the user that certain SMS information has been delivered); NAMPS, narrow AMPS (an optional system that users a 10 kHz/V channel); WRE, wireless residential extension (an optional mode of operation); ANSI, American National Standards Institute.

^b Expected.

(RVC), messages are repeated only 5 times. Words contain 48 bits and have 12 bits of BCH error correction/detection included.

Out-of-band signaling consists of control signals above the 300 Hz to 3000 Hz range, which may be transmitted without alternation of the voice signal. Out-of-band control signals sent on the voice channel include the supervisory audio tone (SAT), signaling tone (ST), and dual tone multifrequency (DTMF).

EIA/TIA-553. As AMPS cellular systems evolved, there was a need for more sophisticated call procedures and system features. EIA/IS-3 was ill equipped to accommodate this growth. This meant that new mobile communications standards had to be developed. However, although the need to standardize new features was great, it was imperative that the fundamental signaling compatibility requirements for both the mobile station and the base station (which were specified in EIA/IS-3 and its revisions) remain unchanged. Therefore, the new standards had to be backward compatible.

Table 1 lists all of the major North American analog mobile communications standards that postdate EIA/IS-3 and the new capabilities/system features that they incorporate.

In addition to the sophisticated new features that are incorporated in the analog mobile communications standards listed Table 1, interoperability and interconnectivity between AMPS cellular systems and digital cellular systems such as IS-136 (TDMA) and IS-95 (CDMA) soon became a major issue in North America. In order to address these issues, the Telecommunication Industrial Association (TIA) developed EIA/TIA-553-A, a new revision of the basic AMPS standard. EIA/TIA 553-A is defined as the “core” analog standard that is common to all TIA analog standards and analog specifications of digital dual-mode standards. With its development the AMPS technology is expected to remain a viable cellular technology in North America for years to come.

NMTS and TACS. While the AMPS cellular system was being developed in the United States, several analog cellular systems were being developed in Europe. The Nordic Mobile Telephone System (NMTS) was developed jointly by the telecommunications administrations of Denmark, Finland, Norway, and Sweden. The NMTS system was put into operation

at the end of 1981. The original NMTS system operated at 450 MHz, but it was updated to 900 MHz in 1986. Compared to the AMPS system, NMTS systems has different channel spacing, control channel modulation, and data coding (see Table 2).

Another cellular system was also developed in United Kingdom and put into operation in 1985—the Total Access Communication System (TACS). The basic requirements of the TACS system are similar to those of the AMPS system except for channel spacing and additional supplementary facilities such as call forwarding, message waiting, three-way conferencing, and call holding (see Table 2).

Second-Generation Digital Cellular Systems

North American TDMA. In September 1988, the CTIA (Cellular Telecommunications Industry Association) created a UPR (user performance requirements) document that described a new generation of cellular equipment that would meet the growing needs of the cellular industry. The UPR did not specify the use of either analog or digital technology; it only specified the system capacity requirements and the need for new features.

In response to this, major cellular carriers and manufacturers developed a digital cellular system for North America known as the IS-54 system or digital AMPS (D-AMPS). D-AMPS is a TDMA (time division multiple-access) system offering 3 times the capacity of AMPS. It provides dual-mode service, which features analog control channels and analog/digital voice channels. A single D-AMPS RF carrier can support up to three full-rate digital voice channels using the same amount of bandwidth as an analog voice channel (30 kHz). Subsequently, with the development of the IS-136 system in 1995, the *digital control channel* (DCCH) was introduced, thereby providing D-AMPS users with a platform for implementing personal communications services (PCS) into their existing networks.

IS-54. During 1989 the TIA subcommittee TR-45.3 formulated the interim digital cellular standard EIA/TIA/IS-54. Soon thereafter, field trials were conducted to verify that base stations and mobile stations manufactured by different companies met the requirements of this standard. After the publi-

Table 2. Comparison of Three Major Analog Cellular Systems^a

Specification	AMPS (North America)	NMTS-900 (Nordic Countries)	TACS (UK)
Mobile TX freq. (MHz)	824 to 849	890 to 915	890 to 915
Mobile RX freq. (MHz)	869 to 894	935 to 960	935 to 960
Channel separation (kHz)	30	25 or 12.5	25
Duplex spacing (MHz)	45	45	45
Modulation (voice channel)	FM	FM	FM
Modulation (control channel)	FSK	FFSK	FSK
Bit rate (kbit/s) (control channel)	10	1.2	8

^a Definitions: FM, frequency modulation; FSK, frequency shift keying; FFSK, fast frequency shift keying.

cation of EIA/TIA/IS-54-A in 1991, a limited number of systems were then put into operation; however, widespread commercial deployment did not occur until after the publication of EIA/TIA/IS-54-B in April 1992. EIA/TIA/IS-54-B became an official ANSI standard in June 1996. It is now known as ANSI TIA/EIA-627. See Table 3.

In September and October 1993, the minimum performance requirements for IS-54-B-compatible mobile stations and base stations were standardized in EIA/TIA/55-A and EIA/TIA/56-A, respectively. Both of these interim standards became official ANSI standards in September 1996, and they are now known as ANSI TIA/EIA-628 and ANSI TIA/EIA-629.

The major distinction between EIA/TIA/IS-54-B and the analog cellular specification EIA/TIA-553-A is the addition of the *digital traffic channel* (DTC). On the DTC, 1944 bits (or

972 $\pi/4$ DQPSK symbols) are transmitted every 40 ms, yielding a channel rate of 48.6 kbit/s. The 40 ms DTC frame is divided into six slots. Each slot consists of 324 bits. A full-rate user requires two slots every 40 ms.

IS-54-B specifies the use of the VSELP vocoder. Every 20 ms the vector-sum-excited linear predictive (VSELP) vocoder produces 159 bits of compressed speech data (7.95 kbit/s). 77 bits are designated as Class 1, and 82 bits are designated as Class 2. The Class 1 bits are given a 7 bit CRC, 5 tail bits are added, and then they are passed through a rate $\frac{1}{2}$, constraint length 5 convolutional encoder. This produces 178 coded Class 1 bits. Together, the coded Class 1 bits and uncoded Class 2 bits add up to 260 data bits every 20 ms (13 kbit/s). The 260 data bits are interslot interleaved.

The forward DTC frame is offset from the reverse DTC frame by 207 $\pi/4$ DQPSK symbols (assuming no timing ad-

Table 3. Key North American TDMA Standards

Publication ID	Publication Date	Title
EIA/TIA IS-54-B	April 1992	Cellular System Dual-Mode Mobile Station–Base Station Compatibility Standard
TIA/EIA IS-136.1 Rev. 0	December 1994	800 MHz TDMA Cellular–Radio Interface, Mobile Station–Base Station Compatibility—Digital Control Channel
TIA/EIA IS-136.2 Rev. 0	December 1994	800 MHz TDMA Cellular—Radio Interface, Mobile Station—Base Station Compatibility—Traffic Channels and FSK Control Channel
TIA/EIA IS-130	July 1995	800 MHz Cellular System, TDMA Cellular–Radio Interface—Layer-Two Logical Link Control—Radio Link Protocol 1
TIA/EIA IS-135	July 1995	800 MHz Cellular System, TDMA Services for Asynchronous Data and Fax
TIA/EIA IS-641	May 1996	TDMA Cellular/PCS Radio Interface, Enhanced Full-Rate Speech Codec
ANSI TIA/EIA-627	June 1996	800 MHz Cellular System, TDMA Radio Interface, Dual-Mode Mobile Station–Base Station Compatibility Standard
TIA/EIA TSB-73	July 1996	IS-136/IS-136-A Compatibility Issues
TIA/EIA IS-136.1-A	October 1996	TDMA Cellular/PCS Radio Interface, Mobile Station–Base Station Compatibility—Digital Control Channel
TIA/EIA IS-136.2-A	October 1996	TDMA Cellular/PCS Radio Interface, Mobile Station–Base Station Compatibility—Traffic Channels and FSK Control Channel
ANSI TIA/EIA-136	June 1998 ^a	TDMA Cellular/PCS Radio Interface, Mobile Station–Base Station Compatibility Standard

^a Expected.

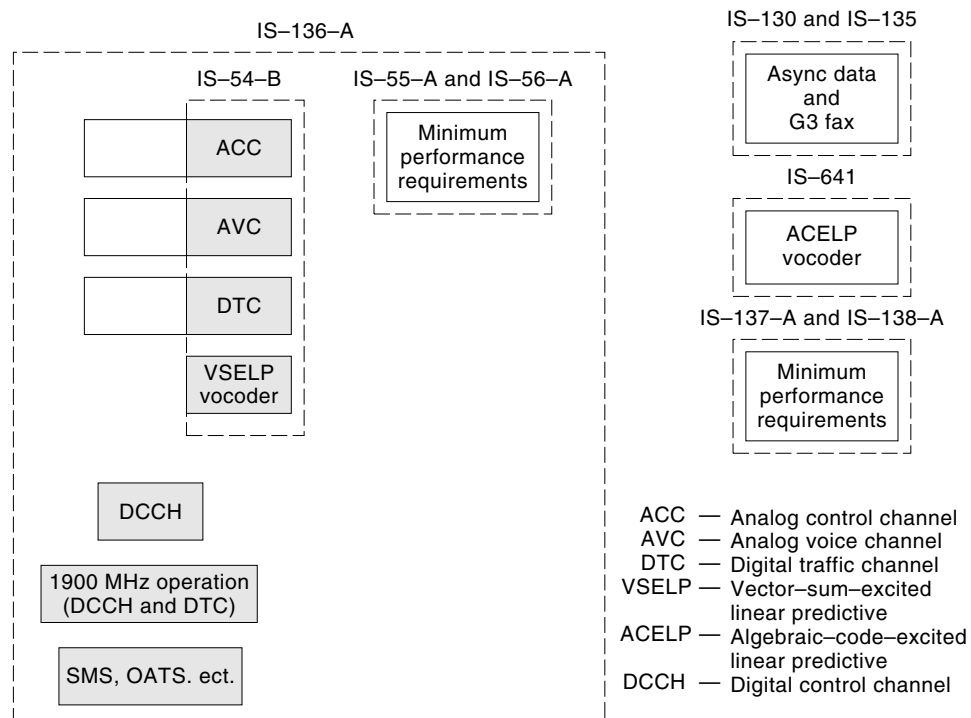

Figure 10. Scope of North American TDMA standards.

vance). Signaling on the DTC is a blank-and-burst $\pi/4$ DQPSK digital message—FACCH (fast associated control channel)—which is passed through a rate $\frac{1}{4}$, constraint length 5 convolutional encoder and interslot interleaved.

IS-136. Dissatisfied with the analog control channel's inefficiency and lack of features, TR-45.3 standardized the *digital control channel* (DCCH) in December 1994 by issuing the interim standard TIA/EIA/IS-136.1 Rev. 0. The DCCH contains the structure necessary for providing D-AMPS users with the platform for implementing PCS features such as short-message service (SMS) and over-the-air activation teleservice (OATS) into their existing networks. The DCCH did not become available for widespread commercial deployment until the publication of TIA/EIA/TSB-73 in July 1996 (which was composed of IS-136 Rev. 0 functionality along with selected IS-136-A functionality). Shortly thereafter, TIA/EIA/IS-136-A was published in October 1996. It is estimated that TIA/EIA/IS-136-A will become an official ANSI standard in June 1998 after undergoing major architectural changes to the document itself (the unlayered approach will no longer be maintained). It will then be known as ANSI TIA/EIA-136. In addition to IS-136-A requirements, ANSI TIA/EIA-136 will incorporate the minimum performance requirements for IS-136-A-compatible mobile stations and base stations, which were standardized in July 1996 in TIA/EIA/IS-137-A and TIA/EIA/IS-138-A. Figure 10 illustrates the scope of IS-136-A.

IS-136.1-A. The major distinction between TIA/EIA/IS-136.1-A and EIA/TIA/IS-54-B is the addition of the digital control channel (DCCH). The DCCH has a logical channel structure that adds the functionality of digital control to existing AMPS and D-AMPS systems. The DCCH retains the frame structure and timing used for the DTC that was introduced in IS-54-B, while at the same time providing a complete DCCH structure.

DCCH *superframes* are composed of TDMA time slots 1 and 4. They are used specifically for DCCH messaging. Each superframe contains 32 TDMA time slots (0.64 s). The purpose of the superframe is to provide a structure that will enhance the sleep mode in the mobile station. Each mobile station is assigned a paging channel (PCH) to monitor on the DCCH. The mobile station may go into sleep mode during the remaining portion of the superframe. When the mobile station is in sleep mode, it only wakes to monitor its PCH, thereby allowing it to receive calls while at the same time conserving battery life.

Hyperframes are composed of two superframes (1.28 s). The first superframe is called the primary superframe, and the second is called the secondary superframe. Every PCH in the first Superframe is always repeated in the second Superframe. This provides time diversity for the PCH while maintaining sleep mode efficiency.

The DCCH contains several subchannels, which will be discussed under two main headings: forward DCCH and reverse DCCH (see Fig. 11).

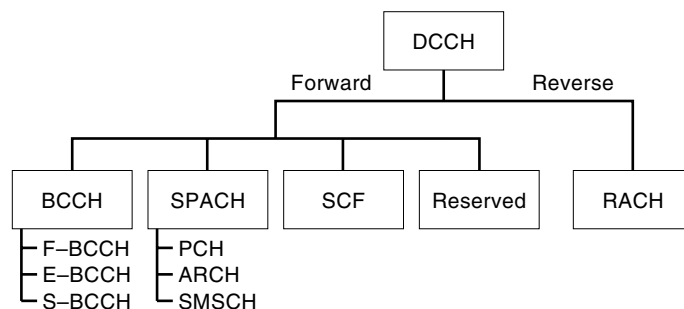

Figure 11. DCCH logical channel structure.

Forward DCCH. Forward DCCH messages are sent from the base station, mobile switching center (MSC), and interworking function (BMI) to the mobile station (MS). They are composed of three main types: broadcast control channel (BCCH); SMS, paging, and access response channel (SPACH); and shared channel feedback (SCF). A fourth logical channel, marked as reserved, has been designated for future use.

The BCCH is composed of the fast BCCH (F-BCCH), extended BCCH (E-BCCH), and SMS BCCH (S-BCCH). These three logical subchannels are generally used to carry system parameters, DCCH frame structure, neighbor cell DCCH list, and global SMS messages.

The SPACH is divided into three logical subchannels: paging channel (PCH); access response channel (ARCH); and SMS channel (SMSCH). A PCH is assigned to an MS after it completes the initialization process. This assigned PCH is a specific time slot within the whole PCH subchannel structure. The MS monitors its assigned PCH time slot for messages or incoming calls. When an MS originates a call, it sends an origination request on the random access channel (RACH). The MS then reads the complete ARCH structure and locates the specific message intended for it. This ARCH message assigns an AVC or DTC to the MS. The SMSCH is used to deliver alphanumeric short messages to a specific MS.

The SCF logical subchannel is used to provide the MS with the real-time status of the RACH.

Reverse DCCH. An MS sends a message to the BMI exclusively on the RACH. Messages sent by the MS are part of the initialization or call origination process.

IS-136.2-A. TIA/EIA/IS-136.2-A is a modified version of EIA/TIA/IS-54-B with no major architectural changes to the document itself (the unlayered approach is maintained). One key difference does exist in the forward DTC slot structure, though. IS-136.2-A specifies that 11 of the 12 RSVD bits on the forward DTC must be used for the coded digital control channel locator (CDL) field at the end of the slot. The CDL contains a coded version of the DCCH location (DL) values and provides information that may be used by a mobile station to assist in the location of a DCCH. Another key difference is the explicit support of dual-band operation (800 MHz and 1900 MHz) on the IS-136.2-A DTC.

IS-641. The first D-AMPS vocoder was the VSELP (vector-sum-excited linear predictive) vocoder. It was standardized in 1990 as part of EIA/TIA/IS-54-B. Dissatisfied with the voice quality that it achieved, TR-45.3 standardized the ACELP (algebraic-code-excited linear predictive) vocoder in May 1996 by issuing the interim standard TIA/EIA/IS-641. The IS-641 vocoder is commonly referred to as the EFRC (enhanced full-rate vocoder). Widespread commercial deployment commenced in late 1996.

Like the VSELP vocoder, the ACELP vocoder specified in TIA/EIA/IS-641 requires a full-rate DTC from IS-136.2-A. However, the ACELP vocoder is more robust to errors (there are 96 protected bits for ACELP versus 77 for VSELP), handles background noise better (ACELP uses predictive vector quantization for the short-term predictor, while VSELP uses scalar quantization), and handles female voices better (ACELP quantizes the long-term predictor in $\frac{1}{3}$ -sample increments over the mid-to-high pitch range, while VSELP quantizes in 1-sample increments).

Every 20 ms the IS-641 vocoder produces 148 bits of compressed speech data (7.4 kbit/s). 48 bits are designated as

Class 1A, 48 bits are designated as Class 1B, and 52 bits are designated as Class 2. The Class 1A and 1B bits are given a 7 bit CRC, 5 tail bits are added, and then they are passed through a rate $\frac{1}{2}$, constraint length 5 convolutional encoder. This produces 216 coded Class 1A and 1B bits. 8 of these bits are punctured, leaving 208 bits. Together, the coded/punctured Class 1A and 1B bits and uncoded Class 2 bits add up to 260 data bits every 20 ms (13 kbit/s). The 260 data bits are interslot interleaved.

IS-136-A Services. TIA/EIA/IS-136-A provides the framework for the implementation of several new services and features:

- IS-54-B compatibility
- Short message service (SMS)
- Over-the-air activation teleservice (OATS)
- Sleep mode for extending mobile station battery life
- Hierarchical cell structure, which allows cells of different sizes (macro, micro, and pico) to coexist within the same geographical area
- Intelligent rescan, which provides an efficient control channel selection process for mobile stations
- Identity structures to support caller ID and improve authentication
- Public, private, and residential wireless telephony support
- Data and fax services
- Explicit support of dual-band operation (800 MHz and 1900 MHz)
- Provision for future expansion

Many of these new services and features are more advanced than those offered by other mobile communications standards.

North American CDMA. The decision by TR-45.3 in 1989 to adopt TDMA as the air interface access scheme for second-generation cellular technology was made prior to the introduction of CDMA (Code Division Multiple Access) digital cellular technology.

Shortly thereafter, Qualcomm (along with a number of carriers and subscriber/infrastructure equipment manufacturers) presented CDMA concept to CTIA, April 1990, and conducted successful field trials on a CDMA digital cellular system. On December 5, 1991, the results were presented at the Cellular Telecommunications Industry Association's (CTIA) "Presentations of the Results of the Next Generation Cellular Field Trials." At this meeting CDMA garnered more support, and on January 6, 1992, the CTIA Board of Directors unanimously adopted a resolution to prepare "structurally" to accept contributions regarding wideband digital cellular systems.

IS-95. In early 1992 the TIA subcommittee TR-45.5 convened to develop spread spectrum digital cellular standards. This effort was initially driven by several US service providers such as Airtouch and Bell Atlantic Mobile, which were interested in CDMA's superior channel traffic capacity and performance. In July 1993, TR-45.5 adopted TIA/EIA/IS-95 (*Mobile-Base Station Compatibility Standards for Dual-Mode Wideband Spread Spectrum Cellular System*).

Table 4. Key North American CDMA Standards

Publication ID	Publication Date	Key Additions
TIA/EIA/IS-95	July 1993	Basic CDMA operations
TIA/EIA/IS-95-A	May 1995	Subscriber access control IMSI support SMS support
TIA/EIA/TSB-74	December 1995	Rate Set 2 (14.4 kbit/s) Service negotiation Status request/response
ANSI J-STD-008	Awaiting publication	1.8 GHz (PCS) support TMSI support
ANSI TIA/EIA-95-B	June 1998 ^a	Dual-mode, dual-band support High-speed data (up to 115.2 kbit/s) Enhanced soft handoff algorithm Enhanced access procedures

^a Expected.

Several revisions of the IS-95 standard were later released in order to support enhanced system features and capabilities. The latest revision of the IS-95 family is the ANSI TIA/EIA-95-B standard, which is expected to be published in September, 1998. Table 4 lists all of the IS-95 revisions and the key capabilities/system features that they support.

Digital cellular systems based on TIA/EIA/IS-95 support dual-mode (analog and digital) and dual-band (800 MHz and 1900 MHz) operation. Also, mobile stations can hand off from CDMA digital cellular systems both to narrowband analog (TIA/EIA/IS-88) and AMPS cellular systems and to 800 MHz and 1900 MHz CDMA digital cellular systems.

On the network side, CDMA is supported by TIA/EIA/IS-41 (*Cellular Radio Telecommunications Intersystem Operations*) and TIA/EIA/IS-634 (the A interface between the MSC and the BS for public 800 MHz operation).

IS-95 Techniques. The major distinction between CDMA and the other narrowband technologies such as AMPS or D-AMPS (i.e., TDMA) is that signals from different mobile sta-

tions in a CDMA digital cellular system share the same spectrum (1.25 MHz) and are distinguished from each other by unique codes. Many techniques specific to CDMA technology are used to achieve higher channel traffic capacity, better performance, and superior quality of service (QoS). These techniques include channel spreading, power control, soft-soft handoff, and variable-rate speech coding.

Forward Link Channels. The IS-95 forward link is channelized by spreading each channel with a unique code. These codes are mutually orthogonal and permit the separation of 64 logical channels on the forward link. There are four types of forward link channels: pilot channel, sync channel, paging channel, and forward traffic channel (see Fig. 12).

The pilot channel carries an unmodulated signal and is used to identify unique CDMA coverage area (i.e. cell or sector). There is only one pilot channel per IS-95 forward link. The pilot channel provides nearly perfect phase reference for the coherent demodulation of the other 63 forward channels. It is also used by the mobile station for acquisition and

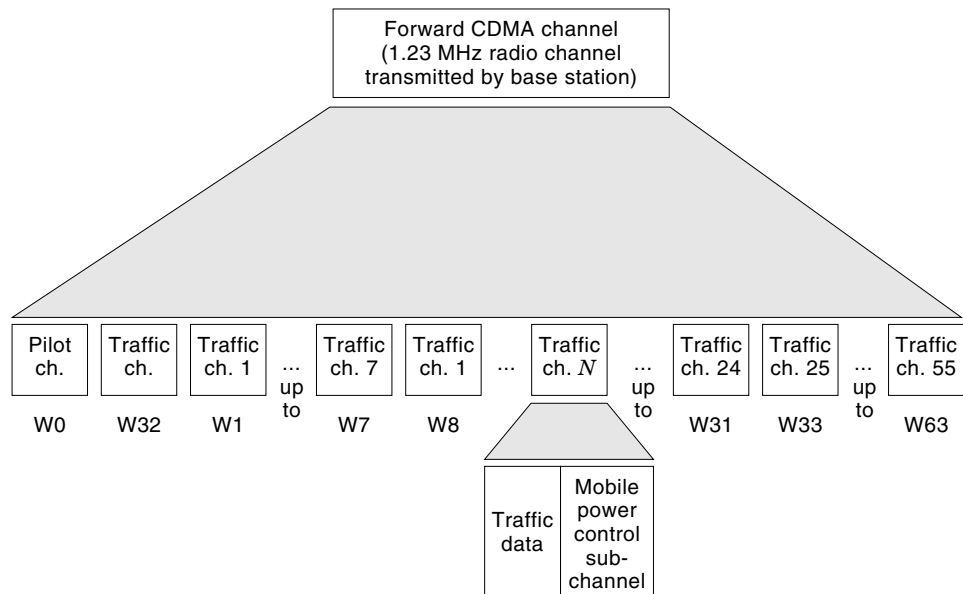

Figure 12. IS-95 forward link channels.

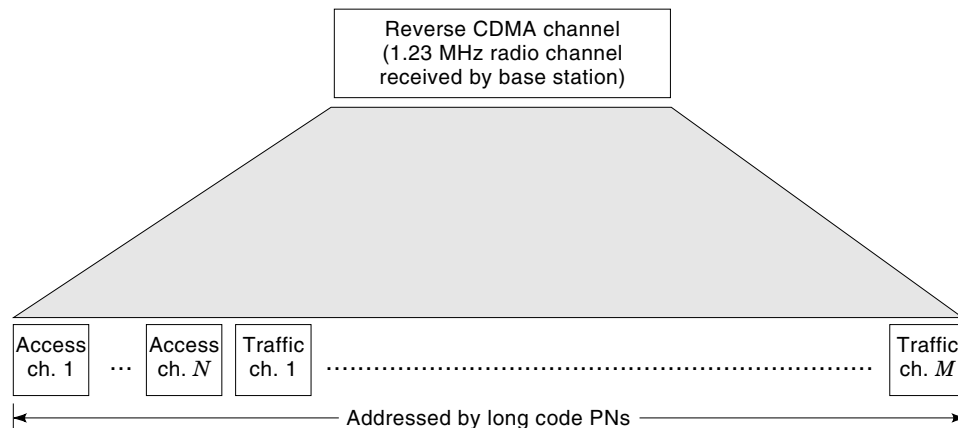

Figure 13. IS-95 reverse link channels.

tracking of new base stations when the mobile station moves from one coverage area to another.

The sync channel conveys information that can be used by the mobile station to synchronize its timing with the IS-95 network. There is only one sync channel per IS-95 forward link. The data rate on the sync channel is 1.2 kbit/s.

The paging channels carry information including system parameters, short messages, pages, etc. There can be up to seven paging channels per IS-95 forward link, depending on the paging capacity requirements. The paging channels are also monitored by the mobile station to determine whether or not the serving base station is reliable and whether or not to select another system—IS-95 or AMPS. The data rate on the paging channels can be either 4.8 kbit/s or 9.6 kbit/s.

Three types of traffic information can be multiplexed and carried on the traffic channels: primary, secondary, and signaling traffic. Data rates on the traffic channels are flexible in order to support variable-rate vocoding and to reduce the mutual interference between channels. The two sets of data rates supported are Rate Set 1 (9.6 kbit/s, 4.8 kbit/s, 2.4 kbit/s, and 1.2 kbit/s) and Rate Set 2 (14.4 kbit/s, 7.2 kbit/s, 3.6 kbit/s, and 1.8 kbit/s). The rates can change dynamically on a frame-by-frame basis (i.e., every 20 ms).

Reverse Link Channels. The IS-95 reverse link is also distinguished by spreading with a unique code. However, on the reverse link these codes are pseudorandom long codes and are not mutually orthogonal. There are two types of reverse link channels: access channel and reverse traffic channel (see Fig. 13).

The access channels are used by the mobile station to initiate transmission with the base station. There can be 32 access channels per paging channel in a cell or sector. Predefined long codes are used for the access channels. The data rate on the access channel is 4.8 kbit/s.

The reverse traffic channels, similar to the forward traffic channel, can carry up to three types of traffic: primary, secondary, and signaling traffic. Pseudorandom long codes are generated, based on the mobile station's electronic serial number (ESN), in order to guarantee uniqueness. Data rates are variable, and both Rate Set 1 and Rate Set 2 are supported.

Power Control. On the reverse traffic channel, the mobile station transmit power is tightly regulated to keep each mobile station transmitting at the minimum power level necessary to ensure acceptable QoS. Since CDMA capacity is inter-

ference-limited, precise control of mobile station transmit power maximizes CDMA channel traffic capacity. Two types of power control are used: open loop and closed loop.

Open loop power control allows the mobile station to estimate its transmit power based on the received base station power. Closed loop power control allows the base station to correct the mobile transmit power by sending power control bits on the forward link.

On the forward traffic channel, the base station transmit power can also be controlled to maximize system performance. For Rate Set 2, the mobile station sends an erasure indicator bit (EIB) to the base station every 20 ms to indicate whether or not a bad forward link frame (erasure) was received. The base station can use the EIB to adjust its transmit power on the forward traffic channel. Also, both Rate Sets 1 and 2 support signaling messages to convey forward link error statistics, which can be used by the base station to adjust the forward link transmit power.

Soft and Hard Handoffs. IS-95 supports seamless soft handoffs. This is accomplished by two or more base stations transmitting the traffic signals for the mobile station. The mobile station combines the signals from these base stations using its RAKE receiver. This provides spatial diversity, thereby improving QoS and coverage.

Soft handoffs are assisted by the mobile station, which measures and reports the received signal strengths of the neighboring pilot signals. When the mobile station detects a neighbor pilot of sufficient signal strength, it immediately reports the detected pilot to the base station. The base station can then assign a forward traffic channel to the mobile station on the neighboring cell or sector and direct the mobile station to perform a soft handoff.

Hard handoffs are supported during situations when the mobile station is transferred between base stations of different frequency bands and different CDMA frame offsets. Hard handoffs are also supported to transfer a mobile station between CDMA digital cellular systems and analog cellular systems.

Variable-Rate Speech Coding. While most speech coding algorithms restrict their design to fixed-channel-rate applications, the IS-95 speech codecs (TIA/EIA-96-B, TIA/EIA-IS-733, and TIA/EIA/IS-127) employ algorithms that exploit the time-varying nature of the speech signal in order to encode speech more efficiently in a variable-rate manner. For typical conversational speech, this variable-rate approach enables

Table 5. North American CDMA Services Standards

Publication ID	Publication Date	Service
TIA/EIA-96-B	July 1996	8 kbit/s speech service
CDG-27	May 1995	13 kbit/s speech service
TIA/EIA/IS-127	January 1997	8 kbit/s EVRC speech service
TIA/EIA/IS-707	March 1998 ^a	Radio link protocol AT command sets Circuit-switched data Digital fax Packet data STU-III secure voice service
TIA/EIA-637	December 1995	Short-message services
TIA/EIA/IS-683	February 1997	Over-the-air service provisioning
TIA/EIA-126	December 1994	Mobile station loopback

^a Expected.

the algorithm to achieve an average speech coding rate less than half that for the fixed-rate vocoders. This lower average rate is one of the factors that gives the IS-95 an overall higher channel traffic capacity.

IS-95 Services. IS-95 supports various services such as digital voice, data, and short message services. Table 5 lists the different standards and the services supported by IS-95 digital cellular systems.

GSM. The specification of the Groupe Spécial Mobile (GSM)—now known more familiarly as the Global System for Mobile Communications for marketing reasons—started in 1982 in Europe with the CEPT. The goal of GSM was to specify a common mobile communications system for Europe in the 900 MHz band. Commercial deployment was planned for 1991.

The early years of GSM were devoted primarily to the selection of a radio technology for the air interface. In 1986, GSM began to perform field trials on the different candidate systems that had been proposed. Considerable debate took place over which of these radio technologies represented by the candidate systems (i.e., FDMA, TDMA, or CDMA) was the most suitable. The final decision to adopt a TDMA approach was made in April 1987. On September 7, 1987, in Copenhagen, carriers representing 12 different countries prepared and signed a memorandum of understanding, agreeing on procedures and schedules to procure, build, and test GSM systems. This ensured that different national markets would evolve simultaneously and that international roaming could be successfully implemented.

GSM Technical Specifications. GSM mobile communications standards are not structured in the same manner as the North American ones. Therefore, it is not practical to list them all in a table. The structure of the entire set of GSM Phase 1 technical specifications is shown in Fig. 14. In regard to the GSM air interface standard, the key series are 04, 05, and 06.

GSM Channel Types. There are two types of GSM logical channels: traffic channels (TCHs) and control channels (CCHs) (see Fig. 15). TCHs carry digitally encoded speech or data and have identical functions and slot formats on both the forward and reverse links. CCHs carry signaling information

between the base station and the mobile station, with certain types of CCHs being defined for only the forward or the reverse link.

GSM Air Interface Techniques. GSM uses a TDMA air interface access scheme in conjunction with FDMA. The GSM specifications define a 200 kHz RF channel spacing that uses GMSK modulation and can support either 8 full-rate users or 16 half-rate users.

The GSM TDMA frame is 4.615 ms long and is composed of eight 577 μ s timeslots. These frames are grouped into multiframe, which are constructed differently for CCHs and TCHs. A group of 26 TCH frames is 120 ms long and defined as a 26 TDMA frame multiframe. For CCHs, 51 frames are grouped into a multiframe of 51 TDMA frames. A superframe is common to both CCHs and TCHs, lasting 6.12 s (i.e., 51 TCH multiframe or 26 CCH multiframe). A group of 2048 superframes forms a *hyperframe*, which forms the basis for frame numbering in GSM. A hyperframe is 12,533.760 s long (or just under 3½ h).

Third Generation Digital Cellular Systems Standards

International Mobile Telecommunications-2000 (IMT-2000)—known as Future Public Land Mobile Telecommunication Systems (FPLMTS) prior to 1994—is the ITU name given to third generation (3G) digital cellular systems, which aim to unify today's diverse digital cellular systems into a common, flexible radio infrastructure capable of offering a wide range of services in many different operating environments around the year 2000.

Background. The study of FPLMTS began with the establishment of CCIR Interim Working Party 8/13 (IWP 8/13) in 1985. IWP 8/13 made a significant contribution in the area of FPLMTS spectrum requirements with Recommendation ITU-R 205. In 1987, the ITU World Administrative Radio Conference for Mobile Services (WARC MOB-87) adopted Recommendation 205, which dealt with the need to designate suitable frequency bands for “international use by future public land mobile telecommunication systems.” WARC-92 followed the technical advice of the CCIR and identified 230 MHz of global spectrum in the 1885 MHz to 2025 MHz and

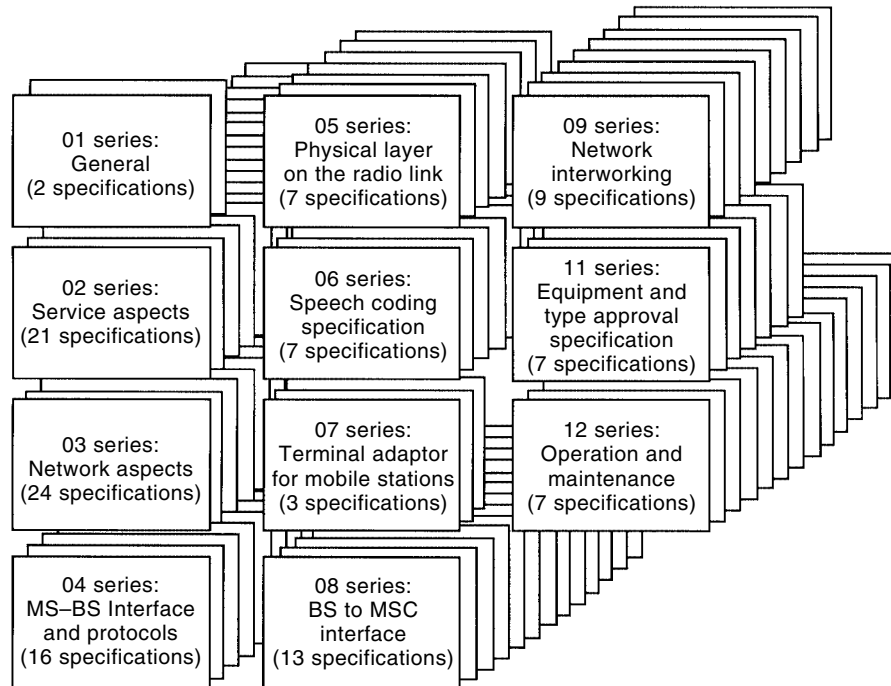

Figure 14. GSM Phase 1 technical specifications.

2110 MHz to 2200 MHz bands for FPLMTS. This global spectrum also had a satellite component (1980 MHz to 2010 MHz and 2170 MHz to 2200 MHz bands).

Today, studies on IMT-2000 continue in ITU-R (known as the CCIR prior to 1993) Study Group 8 (SG 8) under the auspices of Task Group 8/1 (TG 8/1). This work has resulted in the publication of 15 recommendations covering all technical aspects of IMT-2000, such as requirements for radio interfaces, satellite operation, security mechanisms, and network architecture.

In 1997, the ITU approved Recommendation ITU-R M.1225 (Guidelines for Evaluation of Radio Transmission Technologies for IMT-2000). A formal request by the ITU-R director for submission of candidate radio transmission technologies (RTTs) for IMT-2000 was distributed on April 4, 1997, with a closing date of June 30, 1998. Independent evaluations of these proposals, based on Recommendation ITU-R M.1225, will be carried out by various ITU-R members (e.g., TIA TR-45 ISD and ATIS T1P1/TIA TR-46 IAH in the United States) and submitted to the ITU-R by September 1998. Con-

sensus on the key characteristics of the IMT-2000 radio interfaces is planned for March 1999, with the objective of completing detailed ITU-R IMT-2000 standards in time for service to begin shortly after the year 2000.

In addition to the ITU-R activities, related IMT-2000 studies are underway in the ITU-T. To facilitate coordination of the activities between the ITU-R and ITU-T, an Intersector Coordination Group (ICG) on IMT-2000 has been formed.

3G Efforts in North America. The North American 3G activities have been concentrating in large part on the evolution of the CDMA IS-95 technology as the RTT for IMT-2000. In 1997, the CDMA Development Group (CDG) agreed on a requirements document that emphasized backward compatibility as one of the key requirements for a 3G system. Soon thereafter, discussions started on a W-cdmaOne proposal, which is a natural evolution of IS-95 and meets all CDG requirements. In the meantime, the UWC also initiated similar standards efforts, which are leading to a proposal for evolution of IS-136 systems to UWC-136 3G RTT submission. Since

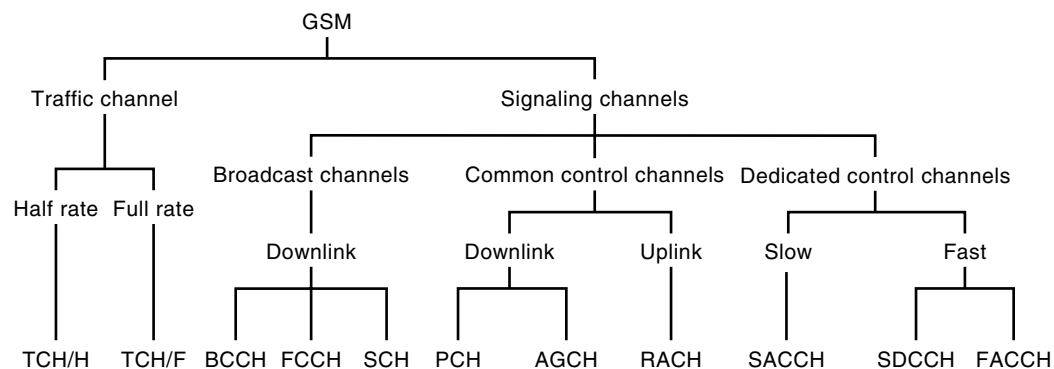

Figure 15. GSM logical channel structure.

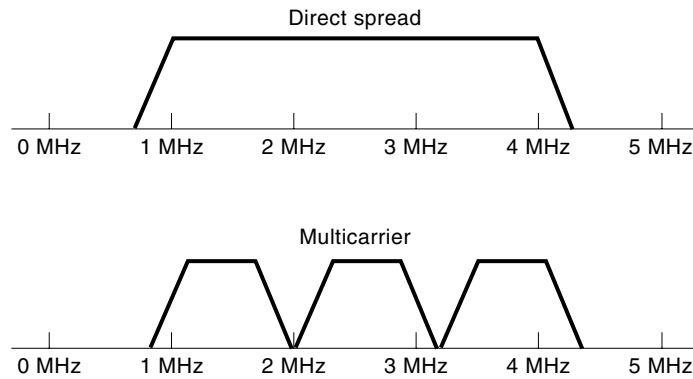

Figure 16. W-cdmaOne forward link.

most of the 3G discussions in North America have been on W-cdmaOne, it is described below.

W-cdmaOne Forward Link. The W-cdmaOne proposal uses multiples of the IS-95 1.228 Mchip/s. As illustrated in Fig. 16 there are two approaches being considered for the W-cdmaOne forward link. One is the direct spread approach, which scales up the 1.25 MHz IS-95 channels to form a wideband channel. The other is the multicarrier approach, which bundles up multiple 1.25 MHz IS-95 channels to form a wideband channel.

Currently, both approaches are being analyzed and compared. In terms of performance and technical parameters, there are no major differences between the two. In terms of deployment, however, there is one notable difference. A multicarrier forward link can be overlaid on top of a narrowband IS-95 forward link because orthogonality is preserved. This feature is particularly attractive for D, E, or F block PCS carriers, because without overlay they may not be able to deploy any 3G systems without having to disable one or more of their existing second-generation (2G) systems.

Major enhancements to the forward link include: QPSK modulation and QPSK spreading, which doubles the number of Walsh codes available; an auxiliary pilot to provide spot coverage and beamforming, which further reduces interference; continuous transmission, which reduces interference with medical devices; and variable-length Walsh codes (shorter Walsh codes for higher-data-rate users). Faster forward power control at 800 bit/s is also provided.

W-cdmaOne Reverse Link. Figure 17 illustrates the W-cdmaOne reverse link. The reverse link is mainly just a scaled-up version of the IS-95 reverse link. The most significant modification is the use of four Walsh code channels as a dedicated pilot channel, fundamental channel, supplemental channel, and control channel.

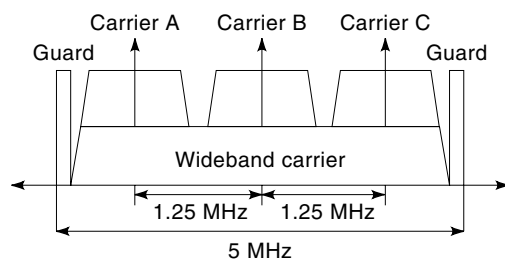

Figure 17. W-cdmaOne reverse link.

The user-specific pilot channel is used for coherent detection, which makes the reverse link demodulation similar to the forward link. The fundamental channel is used mainly for voice and signaling traffic (same as the IS-95 reverse link). The supplemental channel is the high-speed data channel, with a different number of repetitions giving different data rates. Finally, the control channel is designed to help the base station efficiently schedule forward and reverse link resources and realize fast forward power control. Other enhancements include continuous transmission for reducing interference, and for allowing different types of traffic (e.g., voice/signaling versus data) to be sent at different power levels, which will substantially maximize the system capacity.

3G Efforts in Europe. 3G activities in Europe have also been very intense. At an ETSI SMG2 meeting held on January 28 to 29, 1998 in Paris, France, a consensus was reached on the radio interface for universal mobile telecommunications systems (UMTS). The solution, called UTRA (UMTS terrestrial radio access), draws on both W-CDMA and TD/CDMA technologies.

316 delegates representing carriers, subscriber/infrastructure equipment manufacturers, government administrations, and research bodies agreed on the following:

1. In the paired band [i.e., frequency division duplex (FDD)] of UMTS, UTRA adopts the radio access technique proposed by the ETSI Alpha group, that is, W-CDMA (wideband code division multiple access).
2. In the unpaired band [i.e., time division duplex (TDD)] of UMTS, UTRA adopts the radio access technique proposed by the ETSI Delta group, that is TD/CDMA (time division/code division multiple access).
3. During the process, it was agreed that the following technical parameters shall be objectives:
 - Low-cost terminal
 - Harmonization with GSM
 - FDD-TDD dual-mode operation
 - Fit into 2×5 MHz spectrum allocation

According to ETSI SMG2 #24 Document TDoc SMG 903/97, some key performance enhancement features of the W-CDMA proposal include: downlink antenna diversity; transmitter diversity; receiver structures; adaptive antennas; and support of relaying and ODMA (Opportunity Driven Multiple Access, an intelligent relaying protocol). The document also indicates that the W-CDMA system supports interfrequency handover for operation with hierarchical cell structures and intersystem handover with 2G systems such as GSM.

Another SMG2 document—ETSI SMG2 #24 Document Tdoc SMG 897/97—points out that the TD/CDMA proposal was specifically designed for the purpose of building the IMT-2000 system on top of the proven GSM technology (see Fig. 18). Key performance enhancement features of the proposal include: base transceiver station (BTS) antenna hopping; frequency and time slot hopping; directive and/or adaptive antennas; faster and quality-based power control; relaying and advanced relay protocols such as ODMA. Hierarchical cell structure and handovers are also supported.

3G Efforts Elsewhere and the Final Convergence. At least three standards are foreseen as potential members of the

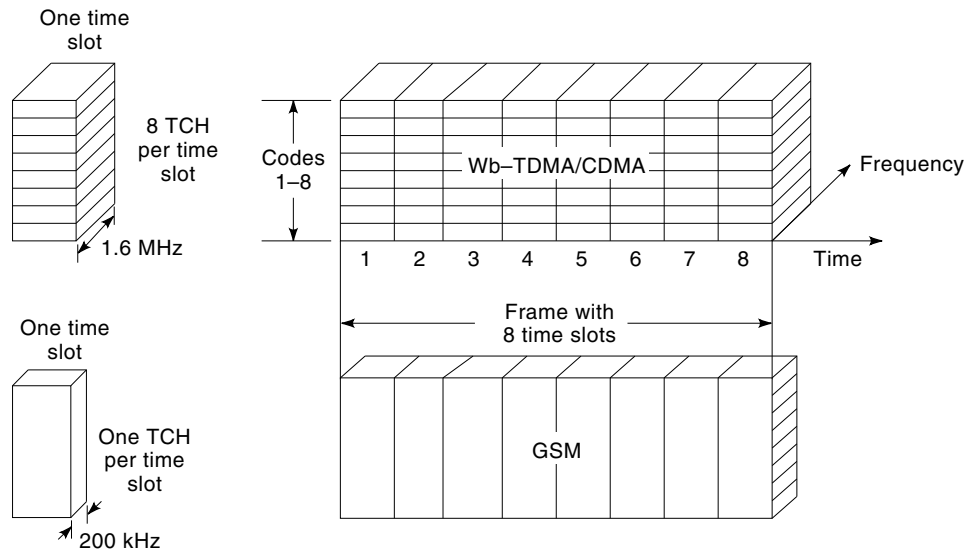

Figure 18. TD/CDMA and GSM.

IMT-2000 family. These are shown in Table 6. In principle, any of these four regional standards could be recognized as IMT-2000 family members with the understanding that a regional standard can also be deployed outside the region where it originated from.

In other parts of the world, 3G proposals are also being discussed and evaluated, especially in Asian countries such as Japan, Korea, and China. For example, Japan has been making progress in consolidating proposals from NTT DoCoMo, which is aligned with the ETSI W-CDMA proposal, and the W-cdmaOne proposal. Currently, the key remaining difference is the chip rate, which is set to 4.096 Mchip/s in W-CDMA and 3.6864 Mchip/s (3 times the 1.2288 Mchip/s IS-95 chip rate) in W-cdmaOne. It is anticipated that major progress will be made down the road, especially in the REVAL process, for converging different regional proposals into a possible global standard.

NETWORK STANDARDS

In regard to mobile communications systems, network elements are not directly related to the air interface between mobile stations and base stations. Network elements provide switching system functions, call and services control, mobility management, and data-based functions, while the air interface provides the means for radio communication between mobile stations and base stations.

The basic mobile communications network architecture consists of a number of network elements and interfaces (see Fig. 19). The principal network elements include:

- Mobile station (MS)
- Radio base station system (BSS)
- Mobile switching center (MSC)
- Home location register (HLR)
- Visitor location register (VLR)
- Authentication center (AC)
- Short-message service—service/message center (SMS-SC or SMS-MC)

The principal network interfaces include:

- Um air interface between the MS and BSS
- A interface between the BSS and MSC
- B interface between the MSC and VLR
- C interface between the MSC and HLR
- D interface between the VLR and HLR
- E interface between MSCs

(In the majority of network configurations, the VLR functionality is integrated or colocated with the MSC.)

Table 6. Possible 3G Family Members

Standard:	Europe—UMTS	U.S.—TDMA	U.S.—CDMA
Radio:	W-CDMA for FDD TD/CDMA for TDD	UWC-136	W-cdmaOne
Network:	GSM Map evolution	IS-41 evolution	IS-41 evolution
Standards body:	ETSI	ANSI TIA	ANSI TIA

^a Expected.

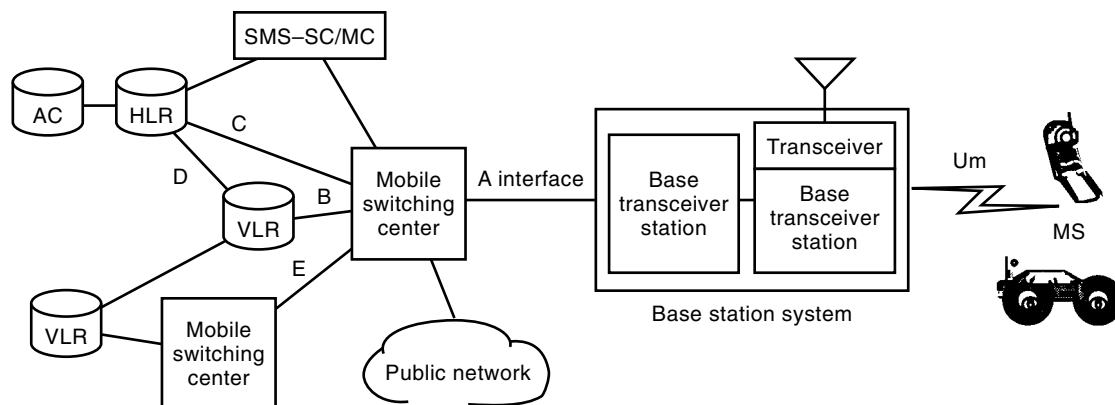

Figure 19. Mobile communications network architecture.

Network Elements

Base Station System. The mobile station communicates to the network via the air interface. The base station system (BSS) includes a base station controller (BSC) and one or more base transceiver stations (BTSs). The BSC manages radio channels on the radio interface and handovers. Radio transmission and reception devices, including antennas, and all radio interface signal processing are contained in the BTS. The BSS terminates the air interface from the mobile station and then connects the network signaling and user traffic to the mobile switching system over the A interface. The BSC manages the air interface to the mobile station and usually any associated air interface encryption protection. The BSC, along with the MS and MSC, manages the handoff between cells. When cells span MSCs, the handoff signaling for the cells is exchanged between MSCs. This type of handoff is referred to as *intersystem handoff*.

Mobile Switching Center. The MSC provides switching and call control for basic and supplementary services (call origination and termination, call transfer, call hold, etc.), connection to the public network, and connection to the user's home system during roaming. The originating MSC accesses location and routing information from the HLR, and routes the call to the destination/serving MSC.

Location Registers. The home location register (HLR) and visitor location register (VLR) store user subscription and location information. The HLR provides for user registration, user location, and user profile information (features and services subscribed to by the user). Each service provider has an HLR for its subscribers. The HLR can support multiple MSCs and can either be integrated into a MSC or exist on a separate, centralized platform. In a roaming scenario the serving system MSC/VLR communicates with the user's home HLR to obtain user profile and user authentication information. The information is then stored in the VLR.

Authentication Center. The authentication center (AC) provides for user verification and manages security data used in authentication. The HLR communicates with the AC to validate users of the network.

Short-Message Service–Service/Message Center. The SMS-SC or SMS-MC is responsible for the transmission of a short message to/from a mobile station.

Network Interfaces

Network interfaces carry user traffic and network signaling between the network entities. This signaling can be classified as call and service control, mobility control, or resource management. *Call* signaling includes origination and termination requests and user signaling such as busy tone and ringing. *Service control* includes user requests such as transfer, forward, hold, and conference. *Mobility control* includes signaling to register a user, authenticate a user, provide user profile information in a roaming environment, and locate a user. *Resource management* includes management of radio resources (air traffic and signaling channels), and traffic and signaling channels between the BSC and MSC.

A Interface. The A interface provides the communication capability between the BSC and MSC and carries user traffic, call and service control signaling, mobility control signaling, and radio resource management signaling. This interface is used for:

- Allocation and maintenance of terrestrial channels (voice trunks) that connect the MSC and the BSS
- Control of operations and resources that are a shared responsibility of the MSC and BSC
- Transparent passing of information from the mobile set (MS) to the MSC.

GSM A Interface. In GSM standards the A-interface signaling protocol is also referred to as the BSSAP (BSS application part) protocol as a user function of Signaling System No. 7 (SS7 and MTP); see Fig. 20. BSSAP is further subdivided into two separate functions:

- DTAP (direct transfer application subpart) is used to transfer call control and mobility management messages to and from the MS. DTAP messages are not interpreted by the BSS; they pass transparently through to the MSC.
- BSSMAP (BSS management application subpart) is used to coordinate procedures between the MSC and BSS re-

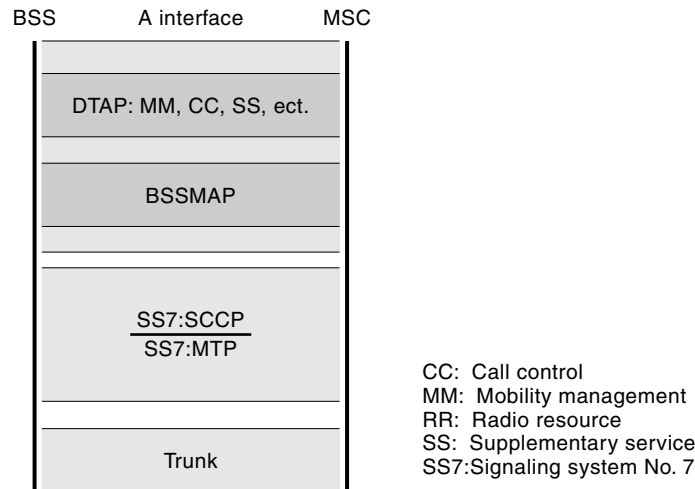

Figure 20. GSM A interface protocol stack.

lated to the MS (e.g. resource management or handover control), and coordinate connection between the MSC and BSS.

The latest revision of the GSM standards, GSM '96, was released in 1997. Table 7 lists the standards related to the A interface.

North American SS7-Based A Interfaces. The specification that defines an open A interface for North American mobile communications systems is called IS-634 (MSC-BS Interface for Public Wireless Communications Systems). It uses a standard SS7 carriage protocol. IS-634 is developed by the TIA subcommittee TR-45.4 and supports AMPS/TDMA/CDMA/NAMPS, (narrow AMPS) through common messages and procedures, thereby providing some air interface isolation from the MSC. Table 8 lists the revisions of the IS-634 standard.

The IS-634 standard is based on the GSM A-I/F standard and includes most of the GSM BSS Management Application Part in addition to a subset of GSM Call Control and Mobility Management. It also includes modifications needed to support North American air interface standards and uses a modified subset of the GSM DTAP-like messages with interworking to create/convert messages in the BSS. Figure 21 gives a comparison between IS-634 and GSM A interface architectures.

Table 7. GSM A Interface Standards Revisions

GSM A Interface Specifications	1997 Revision	Title
GSM 4.07	5.2.0	Mobile radio interface signaling layer 3: general aspects
GSM 4.08	5.7.0	Mobile radio interface layer 3 (DTAP)
GSM 8.02	5.1.0	BSS-MSC interface principles
GSM 8.06	5.1.0	Signaling transport mechanism specification for BSS-MSC I/F
GSM 8.08	5.6.3	MSC-BSS layer 3 specification (BSSMAP)

MAP Interfaces. The protocol that is used for communication between the network interfaces in a mobile communications system is referred to as the mobile application part (MAP). There are two main MAP standards: ANSI-41 (used by AMPS-based systems), and GSM MAP (used by GSM-based systems).

The B interface between the MSC and VLR, the C interface between the MSC and HLR, the D interface between the VLR and HLR, and the E interface between the MSCs all use the MAP protocol.

ANSI-41. The network standard that is used by AMPS family of mobile communications systems (AMPS, TDMA, CDMA) for intersystem signaling is referred to as ANSI-41 (or ANSI TIA/EIA-41). It was developed and is maintained by the TIA subcommittee TR-45.2.

ANSI-41 specifies the protocol used by interfaces among elements in the cellular core network (e.g., HLR, VLR, MSC, AC). It supports all radio access technologies—AMPS, TDMA, and CDMA. ANSI-41 provides intersystem signaling support for cellular features and services as described in ANSI TIA/EIA-664. Examples of the services and capabilities include:

- Call origination and termination while roaming
- Inter-MSC handoff
- Call forwarding
- Remote feature activation/deactivation
- Mobile station “flash” capability (three-way calling, call waiting, call transfer)
- SMS (short message service)
- CNIP (calling number presentation)
- MWN (message waiting notification) and voice mail retrieval

The ANSI-41 protocol uses ANSI TCAP of Signaling System No. 7 (SS7) for intersystem operations. The ANSI-41 messages may be transported via X.25 or SS7 signaling links.

Interim Standard 41 (IS-4) Revision 0 was published in 1988 and has gone through many revisions since then. IS-41 Revision C was published in February 1996 as a TIA interim standard. IS-41 Revision C has now become a full ANSI standard, ANSI/TIA/EIA-41 Revision D, and was published in December 1997. The next revision of ANSI/TIA/EIA-41, Revision E, is planned to go to ballot in December 1998. This revision will include the contents of the numerous standalone feature documents (e.g., TDMA, CDMA, Data, E911, IMSI, WIN) that have been developed by the TIA subcommittee TR-45.2 over the last two years. Table 9 lists the revisions of the IS-41 standard.

GSM MAP. The standard that is used by GSM mobile communications systems for intersystem signaling is also called the mobile application part (MAP). It was developed and is maintained by ETSI SMG with input from ANSI T1P1 for North American requirements. GSM MAP is specified in ETSI GSM 09.02 specification.

The MAP is the GSM protocol used for mobility management signaling between network subsystem nodes. It is used to exchange location and service information between the MSC, HLR, and VLR. The MAP protocol is implemented on top of the ITU-T Transaction Capabilities Application Part (TCAP) and is transported over ITU-T SS7 and ANSI SS7 (for PCS 1900). The MAP uses protocol version and application

Table 8. Revisions of the IS-634 Specification

Reference	Publication Year	Key Functions/Additions
IS-634 Revision 0	1995	Call delivery Supplementary services Authentication/voice privacy Inter-BS/intersystem hard handoff
TSB-80	1996	Corrections to IS-634 Message waiting indication (MWI) Short-message services (SMS) Inter-BS/Intersystem soft handoff voice Frame format based on subrate circuit, via the MSC
IS-634 Revision A	1998 ^a	An alternative architecture (architecture B) Over-the-air service provisioning (OTASP) Circuit data (async. and G3 fax) Simplified call setup procedures Service negotiation Test calls ATM transport Packet-mode-based voice frame format for CDMA Direct BS-BS connection for inter-BS/intersystem soft handoff (IBSHO/ISSHO)
ANSI/TIA/EIA-634	1998 ^a	Promotion of IS-634 to full ANSI standard

^a Expected publication date.

context negotiation mechanisms for forwards and backwards compatibility.

The latest revision of the GSM MAP (i.e., MAP '96) was released in 1997. It is based on the Phase 2 MAP with specific enhancements to support GSM '96 network features and IN capabilities. MAP '96 uses a new Protocol Version, V3. In addition, new extensibility mechanisms were introduced to ease the burden of introduction of standardized and proprietary protocol elements.

Some of the most important network features in GSM '96 are:

- CAMEL Phase 1 (GSM IN)
- High-speed circuit switched data
- Support of optimal routing
- Enhanced data services and SMS
- Explicit call transfer

The ETSI standard body is currently developing the MAP '97 (or '98) revision. New parameters for new features will be included via the extensibility mechanism introduced in the MAP '96 release. Table 10 lists the standard for the GSM MAP protocol.

REGULATION IN THE UNITED STATES

There are two aspects to the regulation of mobile communications. First, mobile communication carriers may be regulated in terms of the service they offer, the tariffs they charge, and the interconnections that they make with other carriers—just like any wireline carrier. Second, due to their wireless transmission medium, mobile communications carriers are dependent upon how the usage of the frequency spectrum is regulated and allocated.

Since regulation and policies vary from country to country, the focus of this section is on the United States, with some

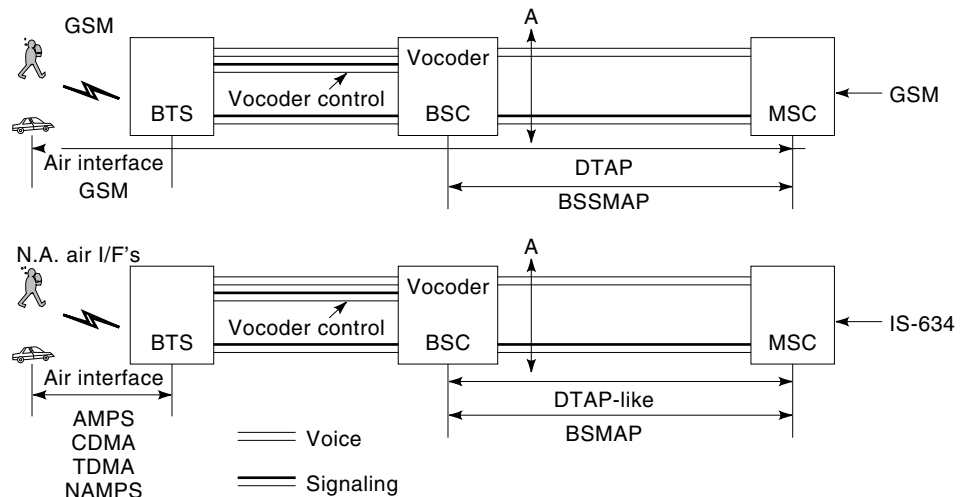

Figure 21. Architecture comparison between IS-634 and GSM.

Table 9. Revisions of the IS-41 Specification

Reference	Publication Year	Key Functions/Additions
IS-41 Revision 0	1988	Inter-MSC handoff
IS-41 Revision A	1991	Automatic roaming Call delivery Call forwarding Remote feature control ANSI TCAP message encoding
IS-41 Revision B	1992	Dual-mode (TDMA) handoff MS flash after handoff MIN-to-HLR global title translation
IS-41 Revision C	1996	Authentication/voice privacy Short-message service Calling number presentation Message waiting notification Support of CDMA mobiles Flexible alerting groups Subscriber PIN access Voice message retrieval
ANSI/TIA/EIA-41 Revision D	1997	Promotion of IS-41 to full ANSI standard
ANSI/TIA/EIA-41 Revision E	1999 ^a	PCS multiband support Digital control channel support Circuit mode data Enhanced emergency services Wireless number portability Wireless intelligent network Internalization of ANSI-41

^a Expected.

discussion of issues regarding spectrum allocation for the IMT-2000 spectrum. This will give the reader a general idea about some of the issues surrounding the regulation of mobile communications.

Telecommunication Regulation

Deregulation of Telecommunication. Until the 1960s, telecommunications in the United States was regulated as a common carrier activity with AT&T and a few independents being classified as common carriers. Regulation at the state level was administered by Public Utility Commissions (PUCs), and at the federal level by the Federal Communication Commission (FCC). The FCC was established by the US government after the enactment of the Communications Act of 1934. The structure of telecommunications regulation was such that competition was not allowed in either the local and long-distance services or the rental of customer premise equipment (CPE)—phones, key systems, etc.

The FCC decision on “Carterfone” in 1968 established the consumers’ right to interconnect equipment provided by non-common-carriers that was technically compatible with the ex-

isting network. The decision created a new competitive market.

In 1969, Microwave Communications Inc. (MCI), a small startup company with a dream, filed an application with the FCC to carry voice and data on dedicated private lines between Chicago and St. Louis (principally for large businesses that needed private-line long-distance connections between their branches in the two cities). Even though this was a specialized carrier application (i.e., MCI would not be competing with AT&T’s long-distance services offered to the public), AT&T opposed the application on the basis that it was “cream skimming.” AT&T was required to maintain an entire nationwide network, and in order to subsidize the extension of phone lines to rural customers, it charged urban and business users more for telephone service. MCI would not have to do this.

The FCC granted the application and soon thereafter more applications poured in from other companies wanting to offer similar services. Inundated with applications, the FCC created a new class of carrier for private line service—the *specialized common carrier*. In 1971, the FCC decided to permit the specialized common carriers to interconnect with the eighteen Bell operating companies’ (BOCs) local exchanges to allow users of their networks to reach any telephone outside the network.

Sensing that competition might be possible in the long-distance service market, the US Department of Justice filed its third antitrust suit against AT&T in November 1974, alleging monopolization of both long-distance service and the manu-

Table 10. GSM MAP Protocol Standards Revisions

GSM MAP Specification	1997 Revision	Title
GSM 9.02	5.7.0	Mobile Application Part (MAP)

facture of telecommunications equipment. The trial began in 1981 and resulted in the divestiture of AT&T into a long-distance service carrier (and telecommunications equipment manufacturing company) and the BOCs. The era of true long-distance service competition had begun; however, the local service market still remained monopolistic and regulated.

Telecommunications Act of 1996. The Telecommunications Act of 1996 is the culmination of the reform started with the breakup of AT&T. It is based on the premise that no sector of the telecommunications market should be immune from competition. Its intent is to make regulatory policy a catalyst for investment and to create a truly competitive environment. The highlights of the act are:

- Allow entry into the long-distance service market by regional BOCs (RBOCs) after meeting the criteria of competition in their region.
- Set fair tariffs and interconnection rules.
- Allow RBOCs to enter into manufacturing partnerships.
- Allow public utility companies to enter into the telecommunications business.
- Allow cable-TV–telephone company cross-ownership.
- Review telecommunications rules every two years.

The Telecommunications Act of 1996 is investor-friendly. With the removal of cross-ownership barriers, a number of joint ventures, alliances, and mergers/acquisitions have occurred. In the end, it is anticipated that only the most competitive carriers will prevail—providing both wireline and wireless services.

Mobile Communications Regulation

Radio broadcasting has been regulated by the US government since the Radio Act of 1912 (prompted by events involving failed radio communications such as the 1912 Titanic disaster). The Radio Act of 1927 created the Federal Radio Commission, which regulated all radio frequency use, including mobile communications. When the FCC was formed in 1934, the Federal Radio Commission was incorporated into it. The management of frequency spectrum in the United States is done jointly by the National Telecommunications and Information Management (NTIA) for federal government users and by the FCC for all other users. The allocation of frequency spectrum for cellular and PCS is discussed below.

Spectrum Allocation for Cellular Service. While cellular technology was ready for deployment by the early 1970s, the unwillingness of opposing interest groups to compromise delayed its commercial introduction until 1983. The FCC completed its report on how to allocate frequency spectrum for cellular in 1970. Another dozen years would pass before the actual assignment of spectrum took place and commercial mobile communications systems were up and running.

Originally, only a single carrier was to be allowed to provide cellular service in a given area (i.e., a wireline carrier). This policy however would have mirrored the earlier monopolistic practices of the telecommunications industry. Confronted with considerable opposition, the FCC modified its rules and issued a new order in 1981 to create a “duopoly” for cellular.

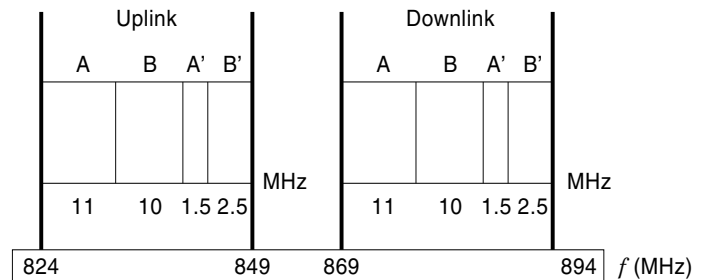

License A, 25 MHz—MSA and RSA
License B, 25 MHz—MSA and RSA

Figure 22. US cellular spectrum.

The country was divided into 306 metropolitan service areas (MSAs) and 428 regional service areas (RSAs). Two licenses were awarded in each type of area. In 1974, the FCC allocated 20 MHz of bandwidth per carrier in an area (this would be increased by 5 MHz in 1989 due to a shortage of channels). The two 20 MHz groups were identified as block A and block B (also known as the A and B bands). Figure 22 shows the cellular spectrum allocation in the United States.

In each area, the wireline carrier was awarded the license in the B band (to be operated by a separate subsidiary), while the A band licenses were initially awarded on a comparative bidding basis to nonwireline carriers. When the process of evaluating essentially similar bids proved to be too slow, the FCC finally resorted to a lottery scheme—creating a bonanza for the winners. As the buildout of cellular service occurred, a large number of individual A-band licenses were consolidated by the larger carriers (e.g., AT&T/McCaw Cellular). The B-band carriers, mostly BOCs, also acquired licenses on the A side outside their territory. Consequently, the cellular licensing process ended up creating a handful of large ventures instead of many smaller, highly competitive carriers as had originally been desired.

PCS Spectrum Allocation. Soon after the frequency spectrum in the 2 GHz band was set aside for third generation mobile communications systems by the ITU in 1992, the FCC started looking at ways of allocating this spectrum in United States. The FCC decided upon the final procedure for awarding licenses in the 2 GHz band for PCS on June 9, 1994.

This time the country was divided into *major trading areas* (MTAs) and *basic trading areas* (BTAs) based upon the Rand McNally definitions. There are 51 MTAs and 493 BTAs. The MTAs consist of a number of BTAs; consequently the licenses for MTAs and BTAs overlap. The 150 MHz available for PCS was divided into six distinct blocks, or bands—A, B, and C, each with 30 MHz (full duplex), and D, E, and F, each with 10 MHz (full duplex)—and an unlicensed band of 20 MHz in the middle (see Fig. 23). Each MTA has an A and a B license assigned; each BTA has a C, a D, an E, and an F license assigned. Consequently, there are a total of approximately 2000 licenses, each market having as many as six PCS service providers in addition to the two cellular service providers—a highly competitive landscape. The FCC also made a rule stating that no carrier can own more than 45 MHz in any market. This allowed existing cellular carriers (with 25 MHz of li-

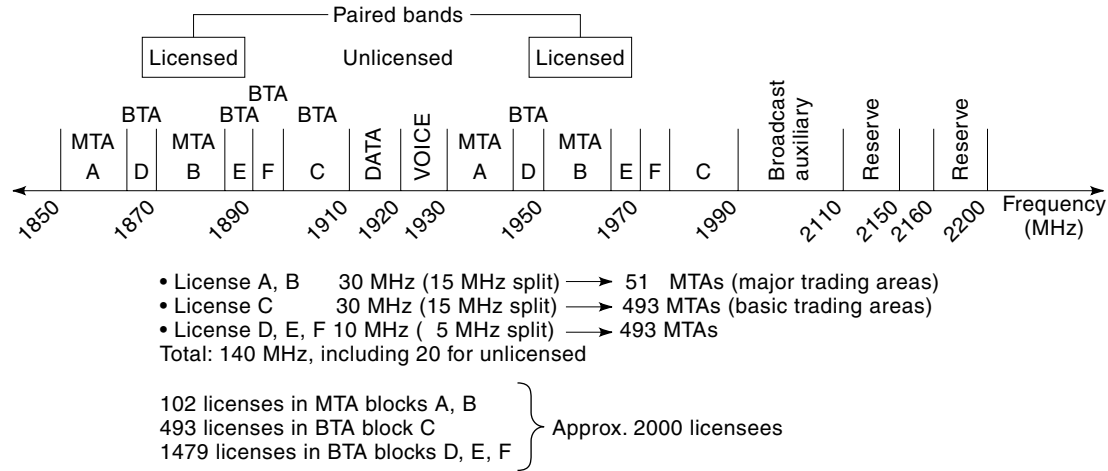

Figure 23. US PCS 1900 spectrum.

censed cellular spectrum) to purchase two 10 MHz licenses (but not a 30 MHz license) in the same market.

The licenses were awarded by auction. The auction process was conducted electronically and was completed in February 1997. The auctions generated considerable revenue for the federal government, and other countries are likely to emulate the US PCS auction process.

IMT-2000 Spectrum. In 1992, the ITU identified 230 MHz of global spectrum in the 1885 MHz to 2025 MHz and 2110 MHz to 2200 MHz bands for IMT-2000. This global spectrum also contained a satellite component (1980 MHz to 2010 MHz and 2170 MHz to 2200 MHz bands). Figure 24 shows the IMT-2000 frequency spectrum.

In Europe, other than the spectrum for DECT, most of the IMT-2000 spectrum is set aside for UMTS (universal mobile telecommunications systems)—the European version of IMT-2000. Similarly in Japan, other than spectrum for PHS, the spectrum for IMT-2000 is reserved. However, in the United States a large part of the IMT-2000 spectrum has already been assigned for PCS. This situation will create challenges for global roaming, which is the objective of IMT-2000.

Type Approval for Wireless Equipment. The FCC rules and regulations require products that emit radio signals to obtain FCC *type approval* before they can be offered for sale in the United States. The approval applies to products that are designed to emit radio signals (e.g., cellular phones) as well as

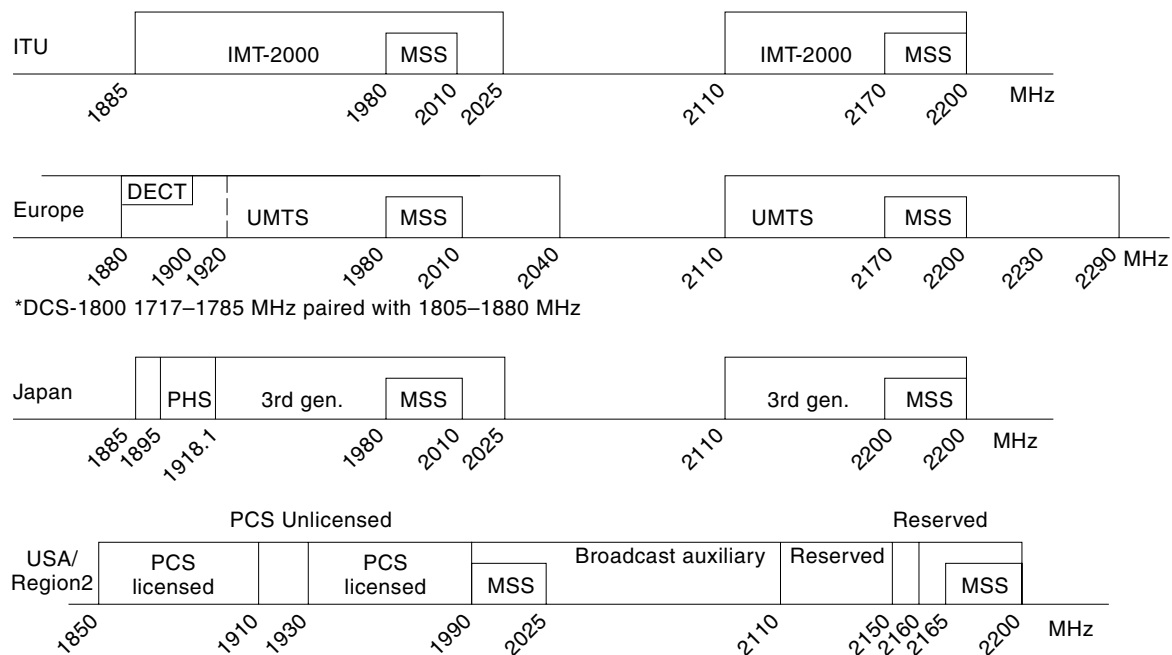

Figure 24. IMT-2000 spectrum.

to products that emit radio signals as a side effect (e.g., personal computers). The FCC has assessed substantial fines to manufacturers that offer products for sale that do not have FCC approval. Products can be displayed at trade shows before approval, if a notice indicates they will not be offered for sale until approval is obtained.

The type approval process for radio products includes UL (Underwriters Laboratories) electrical safety compliance, out-of-band signal compliance, limits for equipment connected to the PSTN, power limits, and compliance with new FCC human exposure limits. The human exposure limits mostly affect cellular phone design; the shielding and antenna configuration can make the difference between a product passing or failing the exposure test.

BIBLIOGRAPHY

- J. Bellamy, *Digital Telephony*, 2nd ed., New York: Wiley, 1991.
- M. Gallagher and R. Snyder, *Mobile Telecommunications Networking with IS-41*, New York: McGraw-Hill, 1997.
- L. Knauer, R. Machtley, and T. Lynch, *Telecommunications Act Handbook*, Rockville, MD: Government Institutes, 1996.
- B. Kumar, *Broadband Communications*, New York: McGraw-Hill, 1994.
- W. Lee, *Mobile Communications Design Fundamentals*, 2nd ed., New York: Wiley, 1993.
- A. Mehrotra, *Cellular Performance Engineering*, Norwood, MA: Artech House, 1994.
- A. Mehrotra, *Cellular Radio: Analog and Digital Systems*, Norwood, MA: Artech House, 1994.
- A. Mehrotra, *GSM System Engineering*, Boston: Artech House, 1997.
- C. W. Mines, Policy development for cellular telephone service in the United States and United Kingdom Program on Information Resources Policy, Harvard University, September 1993.
- M. Mouly and M.-B. Pautet, *The GSM system for mobile communications*, M. Mouly et Marie-B. Pautet, 4, rue Elisee Reclus, F-91120 Palaiseau, France.
- T. Rappaport, *Wireless Communications: Principles and Practice*, Upper Saddle River, NJ: Prentice-Hall, 1996.
- S. Redl, M. Weber, and M. Oliphant, *An Introduction to GSM*, Boston: Artech House, 1995.
- W. Saproinov, *Telecommunications and the Law—An Anthology*, Rockville, MD: Computer Science Press, 1988.
- B. Sklar, *Digital Communications*, 2nd ed., New York: Van Nostrand Reinhold, 1991.
- H. Taub and D. Schilling, *Principles of Communications Systems*, New York: McGraw-Hill, 1971.

www.ansi.org/default.htm

www.arib.or.jp/

www.atis.org/

www.cdg.org/

www.ctia.org/

www.etsi.fr/

www.iso.ch/

www.itu.ch/

www.pcia.com/

www.tiaonline.org/site.html

www.ttc.or.jp/index.html

www.uwcc.org/

MOBILE USER LOCATING. See PAGING COMMUNICATION FOR LOCATING MOBILE USERS.

MOBILITY. See ELECTRON AND HOLE MOBILITY IN SEMICONDUCTOR DEVICES.

MODEL CHECKING. See TEMPORAL LOGIC.