

VEHICULAR ELECTRONICS

A vehicle can be described as a device on wheels for conveyance. Modern vehicles, used for transport of people and goods, include automobiles, trucks, buses, trains, and streetcars. As a result of recent developments in vehicular technology and improvements in electronics, modern vehicles are improving in safety, convenience, entertainment, and comfort as well as in their primary function.

In 1887, the German engineer Gottlieb W. Daimler first applied the gasoline engine to road vehicles. The automobile in the United States began to be developed from 1895 onwards. Motor vehicles for freight and passenger transportation were well established before 1910 in the form of private cars, buses, and trucks. At the turn of the twentieth century, however, there were more battery-operated vehicles in use than either steam- or gasoline-driven vehicles. The period from 1890 to 1910 is generally regarded as the golden age of electric automobiles. Then, an explosive development of the gasoline engine began, and electric vehicles made no further progress on account of the severe range limitations of storage batteries. However, battery vehicles remained in use as fork lifts, for distribution of dairy products, etc. Interest in battery vehicles and alternatives to gasoline-driven engines was rekindled after the 1976 oil crises. Today, although many alternatives exist, the gasoline driven engine is still widely used, because of the cheap and convenient supply of gasoline. The modern automobile is a highly complex technical system consisting of thousands of components and employing many subsystems that perform specific functions.

Passenger cars have emerged as the primary means of family transportation. It is estimated that there are over half a billion private cars in the world. Every year, many different vehicles are introduced into the marketplace. The manufacturers capitalize on their particular technological advances to capture a bigger market share. Therefore, considerable research and development efforts are concentrated on the application of new technology, which may be considered to be the key to successful competition. The manufacturers and suppliers continually improve the body, chassis, engine, drive train, control systems, occupant safety, and environmental emission of their vehicles. An important aspect of these developments is the extensive use of new electronic components.

The use of electronics in modern vehicles is for the purposes of addressing environmental regulations, increasing reliability of vehicles, maximizing safety, reducing both manufacturing and running costs, and making servicing easy and effective. In parallel to this progress the customer's expectations increase, therefore the development of vehicle electronics becomes relentless. Today, the electronics are an essential part of the vehicle, particularly in the reduction of exhaust gas emissions, improved diagnostics, maximized safety, and improved vehicle efficiency. Extensive research is taking place worldwide to determine ways of improving the applications of electronics in vehicles' performance, safety, and comfort without adding excessive cost.

Standalone electronic components such as diodes and transistors were introduced into vehicles early in the 1960s. Solid-state (transistorized) ignition systems were well in use by 1973. However, the use of electronics recorded its most impressive rise and public acceptance after the mid 1970s. The main source of the new capability was the microprocessor. The microprocessor shifted the use of electronics from standalone components to increasingly sophisticated systems that linked many components together.

2 VEHICULAR ELECTRONICS

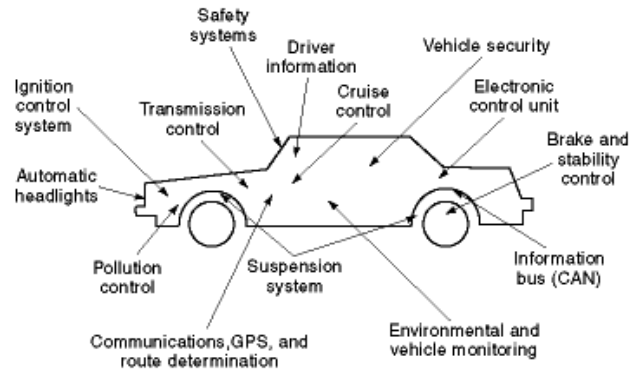

Fig. 1. Electronics is an integral part of modern vehicles. Some of the most common electronic systems are engine control, power train, cruise control, antitheft devices, automatic braking systems, driver display, suspension control systems, and safety systems such as airbags. Others electronic systems, such as Global Positioning System (*GPS*) access and route management, are well developed but not so common, mainly due to cost.

Today's vehicle electronics spans a wide range of hardware and software that contains many integrated circuit (*IC*) chips, microprocessors, and smart sensors backed up with highly dedicated programs for real-time operation. Some of the purposes of these electronic systems are engine control, driver information, entertainment, and ignition control. Vehicle electronics today include a total vehicle network that interconnects many sensors and actuators to work together in an efficient and reliable manner. Many vehicles are totally integrated with electronic systems, which are primarily aimed at optimizing their performance. The total system has flexibility and adaptability with extensive software control of multifunctional features. Many components are available in add-on format that can be customized by the buyer to suit his/her requirements and budget.

Automobile manufacturers worldwide are the main agents of advancement, research, and development of automobile electronics. There are, however, many other establishments and companies assisting in the research and development of vehicle electronics, offering discrete components or complete systems to manufacturers and consumers.

As an information-based system, the onboard electronics of vehicles uses extensive computing capacity: multiplexed networks and extensive memory. Some systems include speed control integrated together with engine and transmission control. Other features include torque demand power-train control, vehicle dynamics such as braking, steering, and suspension, electric power management, and displays for driver information, climate control, and entertainment functions. A block diagram of a typical vehicle control system is shown in Fig. 1.

Electronics is also finding increasing applications in chassis systems, consisting of steering, brakes, and suspensions. This leads to synergic integration of mechanical systems through integrated electronic networks. The use of electronics allows adaptive control of the suspension springs, the shock absorbers, and the suspension geometry. The electronic system senses displacement and acceleration in order to control the ride height, aerodynamic angle of attack, and dynamic response of the vehicle's body.

Traction control systems also improve vehicle stability and avoid collisions. In some applications the space all around the vehicle is monitored for the presence of collision risks, using a combination of sensing technologies, such as radar, laser, visual, infrared, or ultrasonic. The output of the sensors are analyzed by artificial intelligence (*AI*) software that directs the controllers to reduce acceleration, apply brakes, or tighten seat belts.

In modern vehicles, human factors and the design for driver information displays and controls are also highly advanced. Essential information such as vehicle speed is displayed on a reformattable multifunction

display panel. It uses several display technologies, such as liquid crystals, vacuum fluorescent devices, and light-emitting diodes (*LEDs*). The system displays performance data whenever it senses something unusual. In addition, in some vehicles, the driver is able to select particular arrays of information and the style in which it is presented. For example, the driver is able to request a complete display of all engine operating parameters, such as engine speed, oil pressure, coolant temperature, and fuel pressure. The display may also include maintenance information, such as the need for lubrication, brake checking, and so on.

Notifications of emergency and alarm conditions are in the form of audible or visual signals. In some cases, voice recognition is used for functions such as entertainment system control, driver display mode selection, and telephone dialing. Some systems include detection of impairment or loss of alertness on the part of the driver. These focus on the actions that are fundamental to the driver's safe operation of the vehicle, such as appropriate steering and braking behavior.

Climate control is another advanced feature of modern vehicles that is electronically controlled and electrically powered. The air distribution is designed to permit different temperature variations in different zones of the passenger compartment. Supplemental electric heaters are capable of fast response to peak heating demands and allow for the reduction of overall heater capacity.

Cellular telephones find extensive use in vehicles. Modern navigation aids also find increasing applications in passenger, commercial delivery, service, and rental vehicles. These systems operate on radio navigation systems such as loran C or the GPS. They also use map-matching techniques with digital maps that are stored on compact disks onboard the vehicle. The GPS is used to track vehicles' geographic locations, particularly in fleet operations. Some of these systems utilize an external data link that will enhance the on-vehicle navigation system by providing the driver with current traffic information.

Future development in vehicular electronics is dependent on the progress of the electronic industry, including smart sensors, smart actuators, and advances in communication technology. The use of electronics in modern vehicles can broadly be categorized as follows:

- Electric power and electronic signal management, such as power management control systems
- Electronic engine management systems
- Transmission control, traction assistance
- Chassis control systems, antilock–antiskid brake systems, control of vehicle dynamics such as stability control and steering systems
- Security systems, such as antitheft devices, immobilizers, keyless entry, remote locking, and alarms
- Body electronics for safety, such as crash detection, airbags and intelligent seats, cruise control, human–computer interfaces, dashboard displays, and voice recognition
- Automatic vehicle monitoring, position and path finding, and root determination.
- Electric or hybrid technology, such as electric vehicles, hybrid vehicles, and fuel-cell hybrid technology.

In this article, the details of onboard vehicle electronics will be given. However, due to lack of space, this article will not consider off-board vehicle electronics and other supporting systems used in the vehicle industry, such as wheel balancers, engine-tuning units, automatic testing, and other electronic design and manufacturing aids.

Vehicle electronics may vary considerably from one application to another, such as common automobiles, trucks, buses, and trains. Also, products may differ from one manufacturer to another or even from one type of vehicle to another from the same manufacturer. There is a diverse range of vehicle electronic products available in the marketplace, and new ones are introduced almost daily. Here, a conceptual approach will be adopted and general explanations will be given without distinguishing the form of application or the type of vehicle. Some examples will be introduced, and the application areas will be highlighted as the need occurs.

4 VEHICULAR ELECTRONICS

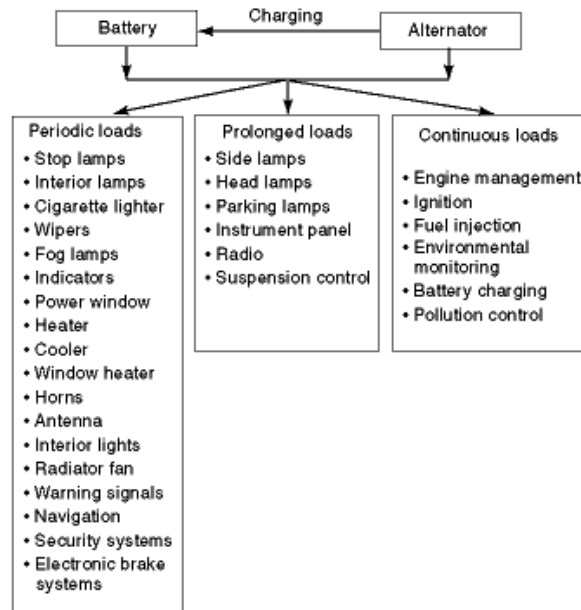

Fig. 2. Electric system in vehicles. An alternator coupled to the engine supplies power to the batteries and to the rest of the vehicle when the engine is running. The battery supplies power when the engine is off and during starting. The electric power must be available at all times for continuous load, prolonged loads, and periodic loads.

Power and Signal Management on Vehicles

Historically, electric arc lamps preceded both Kettering ignition and incandescent lighting on automobiles. They appeared for the first time on electric automobiles in the 1880s. In the early stages of development of gasoline vehicles, the electric systems were limited to ignition systems and electric starters. From 1912 onwards, electric lights began to replace the kerosene and acetylene lights, and electric horns replaced the mechanical bulb horns. By 1930, the electrification of vehicles could be considered to be complete, 6 V dc was used in most vehicles, with a lead-acid battery as a reservoir to store excess output of the generator. Today, 12 V dc is standard.

The electric systems in vehicles supply the power for various operations, as illustrated in Fig. 2. The system comprises a storage battery and charging system, a generator, a motor starting system, lighting, an ignition system, and body electric systems such as heaters, air conditioners, washer-wipers, power seats, windows, and mirrors.

The electric power in vehicles is required to be available at all times for the starter, for the ignition and fuel injection system, for the electronic controller unit, for lighting, for safety and convenience electronics, for driver information, and so on. The electric power is supplied by 14 V (28 V for commercial vehicles) alternators. Alternators are designed to generate dc (with brushes) or ac. When three-phase ac alternators are used, the voltage and current must be rectified, as exemplified in Fig. 3. Other electronics such as transistor or integrated circuit (*IC*) hybrid regulators are also used in power conditioning, voltage regulation, overvoltage protection, and the like.

The modern vehicle has complex wiring systems. The wiring system can be divided into two groups: (1) power distribution network, and (2) information distribution network. The power distribution network delivers the necessary power to all electric equipment. The information distribution network connects sensors,

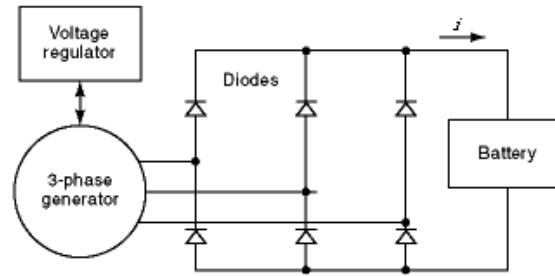

Fig. 3. Rectification of the ac voltage. Many vehicles are equipped with three-phase alternators supplying ac. The ac voltage is rectified by solid-state electronics using diode bridges. Voltage regulators are used to maintain the alternator voltage constant, irrespective of the load and rotation speed of the engine.

actuators, and other electronic components. The information distribution network uses both low-speed and high-speed buses. Currently, among many alternatives, the controller area network (CAN) of Bosch is the accepted standard for information distribution in vehicles.

The Controller Area Network. The conventional method of using dedicated wires to interconnecting sensors, actuators, and controllers has led to a rapid increase in the complexity of vehicle wiring harnesses due to the push by manufactures to add more functionality. Wiring harnesses have become excessively bulky. As the electronic devices shrink in physical size, due to technology advancement, the size of connectors has increased to accommodate more connection points. The CAN, shown in Fig. 4, has been developed to address these problems.

A CAN is a shared serial broadcast bus currently with a maximum speed of 1 million bits per second. Messages of various lengths, zero to eight bytes, are placed on the bus. Each message includes an identifier that specifies the data within the message and also defines the priority of the message. Two versions of CAN protocols have been defined: CAN 1.0 and CAN 2.0, as indicated in Table 1. The difference is in the length of the identifier field: the standard 11 bits, and the extended 29 bits, respectively.

The CAN uses the multimaster principle whereby the devices on the bus do not rely on a central master for accessing it. This approach provides protection against any local malfunctioning in the bus, enabling other components to work normally. Each message is assigned a unique identifier, which also defines its access priority to the bus. The devices are categorized to have either high priority or low priority. A high-priority device can interrupt the transmission of a low-priority device. This mechanism is needed to settle bus contention where two or more devices attempt to access the bus simultaneously. Nevertheless, all devices are required to sense the state of the bus before attempting to transmit. If interrupted, devices transmitting low-priority messages are able to notice that they have been interrupted. Then the low-priority devices discontinue transmission and switch to the receive mode. They can attempt retransmission once the bus becomes idle again.

Electromagnetic Compatibility. Electromagnetic compatibility (EMC) of a subsystem means by its ability to coexist with other subsystems, neither being adversely affected by the others nor adversely affecting them by the generation of electromagnetic interference. In electric systems, electromagnetic interference can take place through the leads and connectors or through airborne radiation. A vehicle is a harsh environment where sensitive electronic systems must coexist with high-powered electrical systems in a confined space. Since the vehicle contains a single electric power supply to which all electric systems are connected, any disturbance produced by one subsystem can easily affect all other subsystems. In vehicles, the DIN 40389 (Section 1) standard has been developed to classify types of disturbances in terms of shape, duration, current, and voltage. Five types of pulses have been defined, as shown in Table 2.

This standard defines four classes of increasing interference pulse amplitude of each disturbance type. This allows vehicle systems to be designed to specific DIN 40389 classes, for example, where all interference

6 VEHICULAR ELECTRONICS

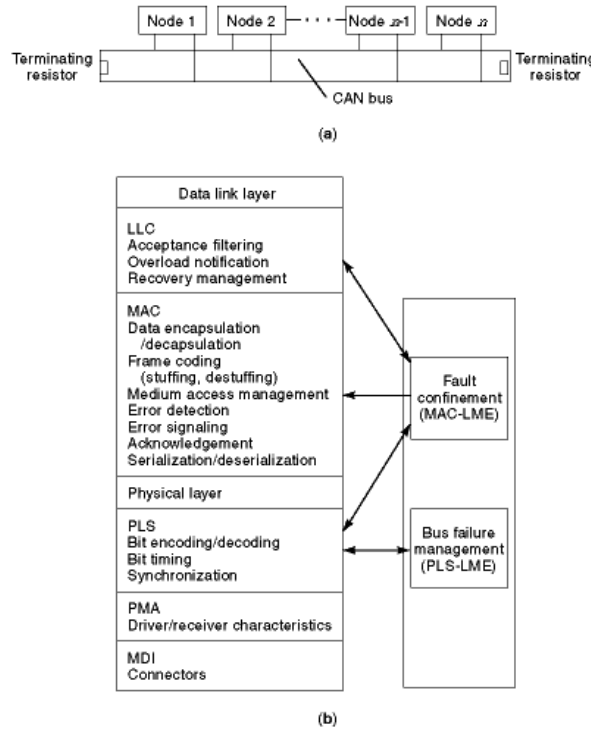

Fig. 4. A controller area network (CAN) bus connects the microprocessors and microcontrollers to sensors and actuators, forming a complex network. Many devices can be connected to a CAN bus (a). Some vehicles contain more than one bus. The bus has a physical layer and a data link layer (b). Various protocols are used to enable smooth information flow.

Table 1: Versions of CAN

Version	Description
CAN 1.0	Generates an error on reception of extended frames
CAN 2.0A	Generates an error on reception of extended frames
CAN 2.0B Passive	Ignores extended frames without generating an error
CAN 2.0B Active	Correctly receives and decodes extended frames

sources must not exceed class II and all susceptible devices must be capable of withstanding class III pulses, and so on.

Electromagnetic interference can propagate from the source to the receiver by a number of mechanisms: (1) directly, through electric connections between the source and the receiver, (2) indirectly through inductive or capacitive coupling, and (3) by radiation. In general, it is easiest to suppress interference at the source with electronic devices. In vehicles, this is the technique that is commonly applied, using suppression resistors, capacitors, coils, filters, shielding, and grounding:

Table 2: Types of Pulses

Type	Source
1	Switchoff of an inductive load
2	Switchoff of a motorized device
3	Overvoltage
4	Starter-motor cranking
5	Alternator load dump

Suppression Resistors. These are used in high-voltage circuits such as the ignition system. Installed as close to the source (spark plug) as possible they provide an increase in impedance that helps dampen the interference energy.

Suppression Capacitors. The impedance of a capacitor decreases as the frequency increases. Therefore, suppression capacitors shunt high-frequency interference energy to ground before it enters the device being protected.

Suppression Inductors (Coils). An inductor's impedance increases as the frequency increases. Inductors are used to provide increased resistance to interference energy.

Suppression Filters. A filter is a combination of capacitors and inductors. The correct combination of values and configuration provides greater attenuation of interference energy than a capacitor or an inductor alone.

Shielding. Completely enclosing the interference source with a conductive shield prevents electromagnetic energy radiating into the environment. A metallic braid can cover cables, while modules may be encased in metal or metal-coated enclosures (housings).

Grounding. Ground connections are extremely important. They are designed to minimize the impedance to the common ground point, and care is taken to ensure that the interference currents do not couple into other systems or cables that the ground is protecting. Improper grounding can be an important source of noise.

Engine Management and Control

Today's vehicles are designed and manufactured to have low exhaust emission. Modern electronics is used extensively to achieve this objective through microprocessor-based engine management systems. However, in order to gain a good understanding of the full functionality of electronics in engine management systems, some of the major processes in internal combustion engines must first be explained.

Internal Combustion Engine. The internal combustion engine (*ICE*) produces power by the combustion of a mixture of hydrocarbon fuel and air. Combustion is achieved either by producing a spark in the presence of the combustible mixture (gasoline engine) or by compressing the mixture above a certain temperature to achieve ignition (diesel engine). The ratio of fuel to air, the density of the air, the temperature of the engine, and the timing of ignition, together with many other factors, affect the power and by-products (emissions) produced. The theoretical ideal air/fuel ratio is 14.7 : 1 and is termed the stoichiometric ratio. The

8 VEHICULAR ELECTRONICS

ratio lambda (λ) is a common parameter and is defined as follows:

$$\lambda = \frac{\text{induction air mass}}{\text{air required for stoichiometric combustion}}$$

where the induction air mass is the mass of air inducted into the combustion chamber.

Maximum power is produced for a λ of 0.95 to 0.85, and minimum fuel consumption is achieved for a λ of 1.1 to 1.2. Similarly, no single λ value can achieve minimum emission values for NO_x , hydrocarbons (*HC*), and CO simultaneously. In practice a λ between 0.9 and 1.1 is used in conjunction with a three-way catalytic converter, which reduces exhaust emission by further chemical reactions. The optimal λ value is shifted by several operating conditions, such as:

- **Cold Start** The low temperature of the combustion chamber decreases the amount of fuel in the mixture due to reduced fuel vaporization and condensation on the sides of the chamber. To compensate, more fuel must be added to achieve reliable starting.
- **Poststart** Increased fuel is required to achieve a smooth idle until the chamber reaches normal temperature.
- **Part Throttle** During this stage λ is adjusted to achieve minimum fuel consumption.
- **Full Throttle** During this stage λ is adjusted to achieve maximum torque output by enriching the mixture.
- **Acceleration** The rapid opening of the throttle results in an immediate leaning out of the air/fuel ratio. To compensate, more fuel will need to be added to provide the required power for acceleration.
- **Overrun** When the throttle is suddenly closed or during descents and braking, the fuel supply is stopped.
- **High Altitude** The air density reduces for increases in altitude. The fuel delivery system must compensate for the reduced air density by reducing fuel supply to ensure the correct λ is maintained.

Electronic Fuel Control Systems. The fuel system must supply the required quantity of fuel for the current operating conditions, depending on the load on the engine. There are two major methods of fuel delivery to the engine: carburetor and fuel injection.

For many years the carburetor provided adequate performance at lower cost than fuel injection systems. It is a mechanical device based upon the Venturi effect and is still used in many vehicles. Various mechanical fuel injection systems have existed since 1898, although, it was not until 1951 that a mechanical injection system was first installed as a standard feature. The electronic fuel injection (*EFI*) system dates to 1957, when a limited-production Bendix EFI system was first offered on the Chrysler 300 sedan.

Analog EFI first appeared on the mass market in 1967, in the Bosch D Jetronic system installed by Volkswagen on air-cooled four-cylinder engines. Bosh, Bendix and various licensees worldwide have offered EFI systems continuously since then.

The year 1979 saw the introduction of the first digital engine control unit, which was a digital map control for ignition timing. Also, 1979 is a significant date because of the introduction of oxygen-sensing feedback control of air-to-fuel ratio, which enabled the use of three-way catalysts for simultaneous HC, CO, and NO_x reduction. The first vehicle to use the λ oxygen-sensing system was a 1979 Volvo sedan. However, O_2 feedback did not require digital feedback per se, though it had been in use since 1976, following the introduction of mass-market microprocessors. In the following year the Bosch Mono-Jetronic system appeared on the market; it provided a cost-effective single-point fuel injection system for small vehicles. Since mid-1980s fuel injection systems have become an essential automotive component.

A typical electronic fuel control, as shown in Fig. 5, controls the amount of fuel injected into each cylinder, cycle by cycle, in response to information obtained from the sensors. Timed current pulses supplied to the solenoid valve injectors control the amount of fuel delivered into each cylinder. The injector actuation process is performed either by group injection or sequential injection. The engine control unit (*ECU*) controls the

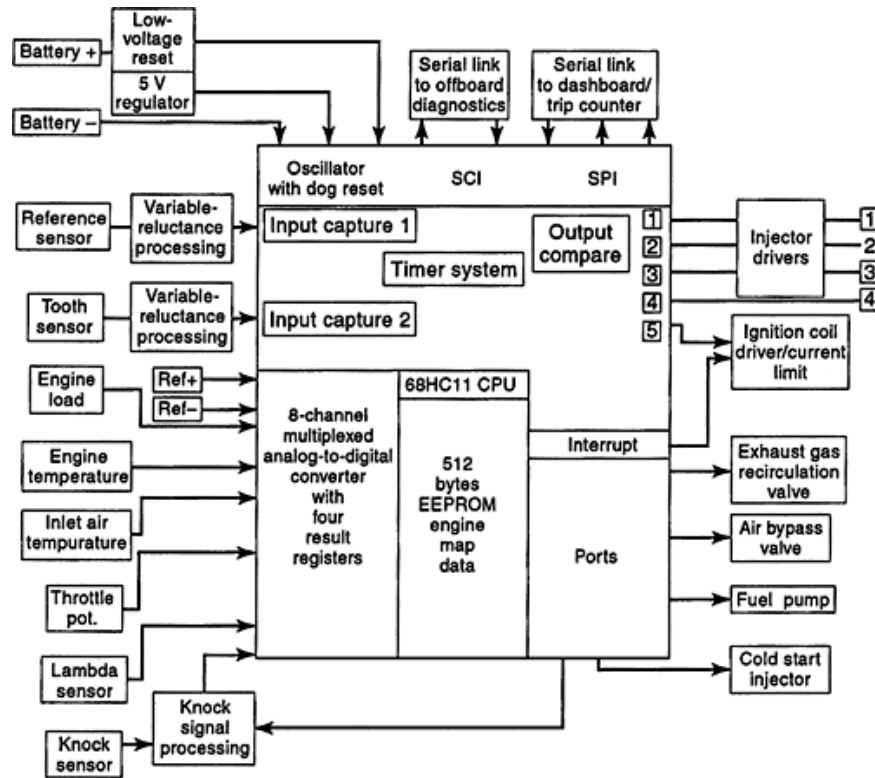

Fig. 5. A typical fuel injection system. Demand for efficient and smooth running of the engine necessitates precise mixture formation for every cycle. This is achieved by dedicated microprocessor systems, such as the Motorola MC68HC11, monitoring many parameters and issuing correct signals for the controllers.

fuel injectors according to the information received from the condition monitoring sensors such as the airflow sensors.

Electronic Ignition Systems. An ignition system consists of a triggering mechanism, an energy storage device, a high-voltage distribution system, and a spark gap. Although, over the years, many ignition systems have been developed, they all consist of those basic elements with slight variations in the design.

One of the oldest ignition systems is induction ignition, which consists of a distributor that contains both the triggering and the high-voltage distribution mechanisms. The distributor is a mechanical device geared to the engine to provide the required synchronization. The triggering mechanism consists of a set of contact points, which are mechanically opened and closed at the correct ignition point during the engine cycle. Breaker points are fitted to the distributor and are controlled by a cam that turns in synchronization with the engine. In addition, centrifugal and vacuum advance mechanisms are required to vary the triggering to compensate for variations in engine speed and load.

The coil ignition system is mechanically and electrically simple. Although it provides reliable service, it has a number of drawbacks. The first is the deterioration of the break points from both mechanical wear and pitting caused by high-voltage arcing. The second drawback is that the adjustment of ignition timing for speed and load variations can only be approximated by the centrifugal and vacuum advance mechanisms. Thirdly, the high-voltage distribution system is mechanical and prone to wear. The first step in addressing these problems has been the introduction of the transistor-assisted contact breaker system. In this system

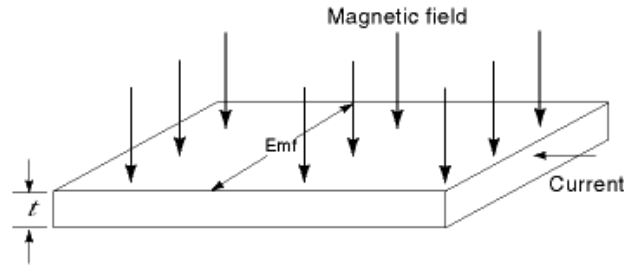

Fig. 6. A Hall sensor. When a current-carrying sensor is subjected to a magnetic field, a voltage is produced in the sensor that is proportional to current and intensity of the magnetic field. This is a typical example of many sensors used in vehicle electronics. Smart and miniature sensors are also finding increasing application.

the conventional distributor assembly is retained but the contact breaker points are used to drive high-power transistors, leading to following major advantages:

- Increasing the primary current, resulting in greater spark energy
- Increasing the service life of the breaker points, as they only interrupt the transistor control current

In modern vehicles, there are many different ignition systems: breakerless transistorized ignition, constant-energy electronic ignition, electronic spark advance ignition, capacitive discharge ignition, twin-spark ignition, and so on. The breakerless electronic ignition system is widely used, since it eliminates the mechanical wear of contact-type systems, which required regular adjustments to correct timing errors. To eliminate mechanical problems, a number of noncontact triggering methods have been developed, such as Hall-effect and inductive.

Hall-Effect Switching. When a magnetic field is applied at right angles to the flow of a supply current, a *Hall voltage* is produced perpendicular to both the magnetic field and the supply current, as shown in Fig. 6. The Hall voltage is produced by the force acting on the charged carriers moving under the influence of an electric field in a perpendicular magnetic field. When the magnetic field is removed, the Hall voltage vanishes. The output from this device is used to trigger a transistor to either pass or interrupt the primary current to the energy storage device. The Hall sensors are fitted to the distributor in place of the mechanical breaker points, and a permanent magnet is placed in close proximity such that the Hall voltage can be produced. A magnetic barrier is designed to pass between the Hall sensor and the permanent magnet, interrupting the magnetic field and consequently reducing the Hall voltage. The magnetic barrier is a circular vane mounted to the distributor shaft. The number of slots in the vane equals the number of engine cylinders.

Inductive Switching. The inductive sensor provides greater phase displacement between the trigger point and just-off-trigger points at high engine speeds. This characteristic improves ignition timing stability. The inductive sensor unit is constructed in two parts, a stator and a rotor. The stator consists of a permanent magnet, core, and inductive winding. The rotor and stator cores are both formed from soft magnetic steel and have a number of teeth that usually equals the number of cylinders of the engine. Both the stator and the rotor are fitted in the distributor in place of the mechanical breaker points. The stator is fixed to the housing and remains stationary, while the rotor is connected to the distributor shaft and rotates in synchronization with the engine. As the rotor turns, the gap between the stator and the rotor varies, which causes a variation in the magnetic flux. This induces a voltage in the inductive winding. A

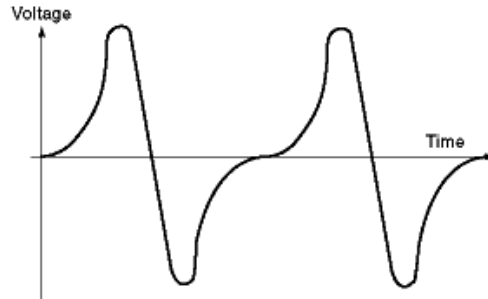

Fig. 7. A typical waveform of an inductive sensor. These sensors provide good ignition timing stability. The amplitude of the waveform ranges from 0.5 V to 100 V. Alternative switching mechanisms such as Hall-effect switching are widely used in the modern vehicles.

typical voltage waveform is shown in Fig. 7. The amplitude of the waveform ranges from approximately 0.5 V at low engine speed to 100 V at high speed.

The advent of the transistorized ignition system led the way to variable dwell-angle control. The *dwell angle* is defined as the number of degrees the breaker cam rotates from the closed position to the open position of the breaker points. It is also called the dwell period. A large dwell angle is needed if a large time interval is required for the energy storage device to reach full charge. The supply voltage and the impedance of the energy storage device determine the required dwell angle. At high engine speeds less time is available for the energy storage device to reach full charge. The spark produced from a partially charged energy storage device may not be sufficient to ignite the air–fuel mixture, and a misfire then results. At low engine speeds excessive current is dissipated in the energy storage device with no additional gain in spark energy. The inductive ignition system had to compromise on the setting of the dwell angle, as it was a function of the cam shape and fixed for all engine speeds. The transistorized ignition system allows the dwell angle to be varied electronically, thereby maintaining full charge of the energy storage device over the full engine speed range.

The next major improvement to take place was the replacement of the centrifugal and vacuum advance mechanisms with a semiconductor ignition system for more accurate and finer-resolution ignition timing control. This system provided the following advantages:

- Ignition timing can be matched to each operating condition of the engine.
- Other engine parameters, such as engine temperature, may be taken into account to further improve engine performance.
- Ignition timing can be optimized with the incorporation of knock control.

These improvements resulted in better starting, improved idle control, and lower fuel consumption.

The system uses several sensors to calculate the current operating condition of the engine. A map of optimum ignition timing is stored within the controller's memory. Using the engine's current speed and load, the controller selects the optimum ignition timing from the stored map. The resolution and accuracy of this map are many times greater than those of the mechanical centrifugal and vacuum mechanisms. Unlike the mechanical system, irregularities in the surface of the map can easily be accommodated.

The following information can be used to calculate the current operating condition of the engine:

- Engine speed and crankshaft position
- Load

12 VEHICULAR ELECTRONICS

- Throttle-valve position
- Engine temperature
- Battery voltage

The ignition timing is directly affected by the engine speed, which is determined with inductive position sensors together with the crankshaft position. The crankshaft position is required to synchronize the ignition timing with the engine cycle. The load is calculated from the intake-manifold pressure or air-mass-flow devices; it also directly affects the ignition timing. The throttle-valve position is determined with either a switch or a variable-resistor sensor. It is used during the idle and full load to modify the control algorithm to provide optimal performance. The engine temperature is measured with a thermistor. The engine temperature also modifies the control algorithm to ensure good cold starts and idle. The value of the battery voltage is used to calculate the correct dwell angle to ensure the energy storage device is fully charged at all engine speeds.

The final improvement has been obtained by replacing the mechanical high-voltage distribution mechanism completely with an electronic system, using a separate energy storage device for each engine cylinder. In the electronic system, the disadvantage of increased weight is outweighed by the following advantages:

- Reduced electromagnetic radiation level, as the sparks between the distributor arm and the termination points are eliminated
- Elimination of moving parts and the accompanying friction, wear, and noise
- Reduced number of high-voltage connections

Emission Control System. By-products of the operation of the gasoline engine include carbon monoxide, oxides of nitrogen, and hydrocarbons (unburned fuel compounds), all of which are pollutants. To control air pollution, governments establish quality standards and perform inspections to ensure that they are met. Over the years, the standards have become progressively more and more stringent, and the equipment necessary to meet them has become increasingly complex.

Over the years, various mechanical modifications to engines and the use of electronic devices that alter emission characteristics have been successfully introduced. These include adjustable carburetor air-fuel ratios, lowered compression ratios, retarded spark timings, reduced combustion chamber surface-to-volume ratios, and tighter production tolerances.

Exhaust-gas recirculation is a technique to control oxides of nitrogen, which are formed by the chemical reaction of nitrogen and oxygen at high temperatures during combustion. Reducing the concentrations of these elements or lowering the peak cycle temperatures reduces the amount of nitrogen oxides produced. To achieve this, exhaust gas is usually piped from the exhaust manifold to the intake manifold. This dilutes the incoming fuel-air mixture and effectively lowers the combustion temperature. The amount of recirculation is a function of throttle position but averages about 2%.

Fuel injection, as a replacement for carburetion, is widely employed to reduce exhaust emissions. The precise metering of fuel for each cylinder provides a means of ensuring that the chemically correct air-to-fuel ratio is being injected into the engine. This eliminates cylinder-to-cylinder variations and the tendency of cylinders that are most remote from the carburetor to receive less fuel than is desired. For this purpose, a variety of metering and control systems have become commercially made available. For example, timed injection, in which a small quantity of gasoline is squirted into each cylinder or intake-valve port during the intake stroke of the piston, is employed on a number of vehicles.

Another approach to pollution control is the stratified-charge engine, which is a variation on conventional cylinder combustion. Fuel is injected into a combustion-chamber pocket, and the nonhomogeneous, stratified charge is spark-ignited. Operation of the engine is realized at very lean air-to-fuel ratios, thus permitting high thermal efficiency at light engine loads. This provides good reductions in exhaust hydrocarbons, carbon

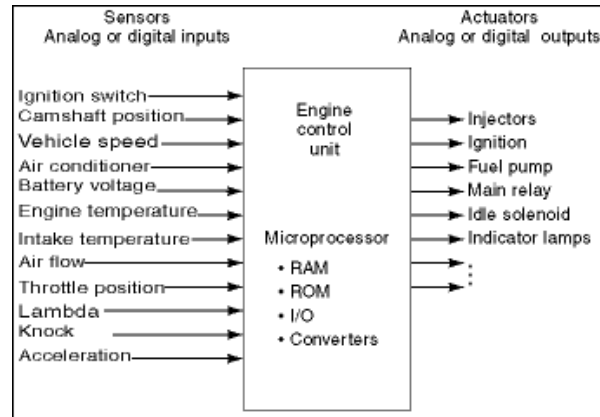

Fig. 8. The engine control unit (ECU). In some vehicles the ECU is the main electronic control mechanism, whereas in others it is a dedicated controller connected to the main computer. It contains microprocessors, supporting chips such as analog-to-digital and digital-to-analog converters, memory, and communication buses for networking.

monoxide, and oxides of nitrogen. The primary problem with the system is to make it function over a wide range of speeds and loads with good transient response.

Renewed interest in two-stroke cycle gasoline engines led several firms in the early 1990s to develop designs related to patents of the Orbital Engine Company of Australia. Air-assisted direct injection of fuel permits very lean-burning stratified combustion. A variable exhaust port confines exhaust gas within the cylinders. Electronic controls provide for proper actuation under varying speeds and loads to produce lower emissions and higher fuel economy with improved power-to-weight ratio.

The Hardware and the Software of the Engine Control Unit. The ECU is composed of a metal housing encasing a printed circuit board (*PCB*). The *PCB* holds the electronic components and provides the interconnection between components, as illustrated in Fig. 8. This is one of the most important and largest components in the vehicle electronic system. The *PCB* houses many electronic components and ICs of various sizes. The ECU is capable of directly driving high-power actuators and switches.

The environment within vehicles may be extremely harsh with temperatures ranging between -30°C and $+60^{\circ}\text{C}$. In addition; the battery voltage can also vary from 6 V during cranking to 14 V during charging. The ECU must be able to operate satisfactorily under all these conditions.

Modern ECUs encompass algorithms for both ignition and fuel injection systems within a single central controller. In addition, the ECU allows new systems, such as air conditioning, to be integrated with existing systems in an efficient manner. Stored within the unit are many algorithms developed to control such functions as ignition timing, dwell period, and fuel injection. These algorithms require information regarding the current operating condition of the engine, which the ECU acquires from a multitude of sensors that provide such information as the speed of the engine, airflow into the engine, and battery voltage. The output from these algorithms controls actuators and indicators, as shown in Fig. 8.

The algorithms are implemented by a microprocessor within the ECU; they are stored in read-only memory (*ROM*), which can only be programmed once, or in electrically erasable programmable read-only memory (*EEPROM*), which can be programmed many times. These are both forms of nonvolatile memory, which retain their contents even when power is removed from the ECU. Also stored in *ROM* or *EEPROM* are the performance curves and program maps required for engine control. As each engine and vehicle configuration is different, the engine manufacturers can modify the curves and maps to suit the particular requirements of an engine.

14 VEHICULAR ELECTRONICS

Random access memory (*RAM*), a volatile form of memory whose contents are lost when power is removed, is used to store calculated values, adaptation factors, and system errors. If the vehicle's battery is removed, then the ECU will have to recalculate the adaptation factors. To overcome this problem, some ECUs use EEPROMs instead of RAMs.

The outputs of the ECU are capable of directly driving actuators such as fuel injectors or ignition coils. Each output is protected against shorts to ground and overloads. The protection circuitry provides information to the microprocessor, enabling the fault to be logged and the defective output to be switched off. The error log of the ECU is used to locate faulty components efficiently.

There are three types of sensors used in conjunction with the ECU. The first provides simple on-off indication, such as the throttle idle switch position. This type of signal can simply be processed as a digital input. The second provides either a voltage or a current signal that is proportional to the parameter it is measuring, such as airflow or temperature. This type of signal requires an analog-to-digital converter (*ADC*) to convert the varying signal to a digital equivalent. The third type uses voltage or current pulses with varying timing to convey information such as the engine speed. This type of signal requires counters and timers to measure the time between pulses and the number of pulses within time intervals.

These sensors are placed at different positions on the engine and are connected to the ECU via the wiring harness. Although the ECU is protected from electromagnetic interference with the aid of shielding and by other means as discussed above, the connections to the wiring harness can allow harmful interference and unwanted noise that adversely affect the performance from time to time.

Transmission Control

Modern vehicles have automatic, semiautomatic, or manual transmission systems. The automatic transmission provides three or four gear shift positions controlled by hydraulic pressure produced by the engine. A conventional automatic transmission system consists of a number of components such as a torque converter, a gear train, friction elements, an oil pump, a hydraulic control unit, and transmission housing. The crankshaft rotation is transferred to the automatic transmission via a torque converter. The point of gear shift is set by mechanical adjustments that, once set, cannot be changed without readjustment. Compromises used to be required to achieve adequate performance over the widest range of operating conditions.

Commands issued from the ECU now control the electric, vacuum, or hydraulic actuators to engage or disengage the lockup mechanisms by directing fluid into the torque-converting chamber using solenoid valves. The use of a microcomputer-controlled system improves the automatic transmission by controlling the hydraulic system, thus offering smooth gear shifting and eliminating hunting shifts and the like.

With the availability of microprocessor-based control units, greater flexibility can be built into the control of automatic and semiautomatic transmissions. An example of an electronic transmission control system is shown in Fig. 9. In addition to engine load and speed, other factors such as engine temperature and the driver's characteristics can be taken into account in determining the optimal gear-shift scheme. A communication channel between the ECU and the transmission controller enables the engine to reduce power output during gear shift, resulting in smoother gear changes.

Chassis Control Systems

Chassis systems are associated with controlling the motion of the vehicle such as acceleration, braking, turning, and vibrations. Most chassis controllers are microcomputer-based devices, ranging from 8-bit microcontrollers (e.g., Motorola MC68HC11) to 16-bit or more (e.g., Motorola MC68HC16). There are over 50 versions of the

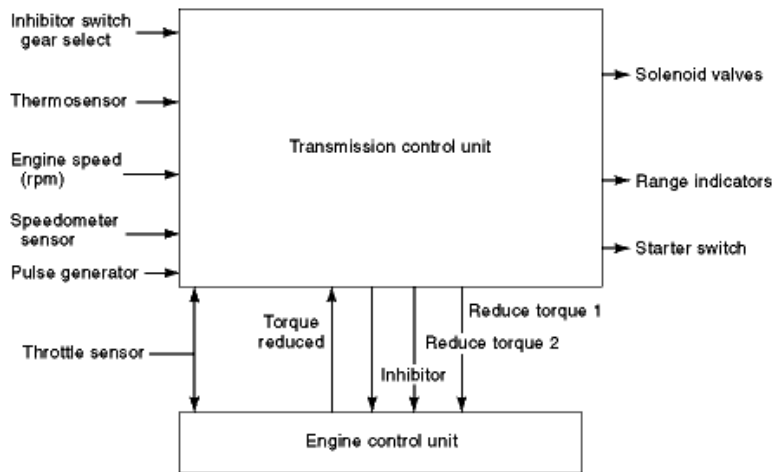

Fig. 9. A typical transmission control system. Electronic transmission control systems are used mainly in automatic and semiautomatic transmissions. The controller senses all the necessary parameters to actuate controllers for appropriate mechanical variations.

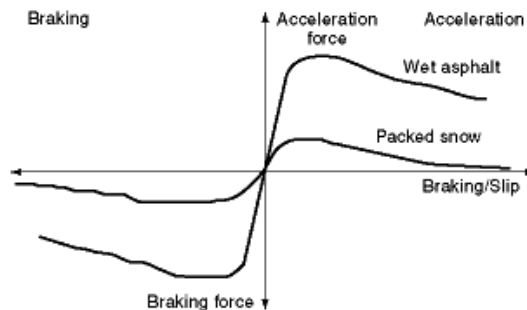

Fig. 10. The adhesion of the tire to the road surface is an important factor in the implementation of an electronic braking system. The acceleration and braking forces at different road conditions vary considerably; therefore, adaptability of the braking system is absolutely necessary.

HC11 microcontrollers, some of which are specifically designed for automobile applications. Some important and widely used chassis control systems are discussed below.

Antilock–Antiskid Brake Systems. Antilock braking systems (ABSs) improve the steerability and stability of vehicles. They also prevent the lockup of a vehicle’s wheel under braking conditions, with the use of a closed-loop feedback control system. The rotational speed of a wheel being braked is monitored, and in the event of a sharp rise in deceleration the braking effort is reduced. Once the wheel’s rotational speed increases, the braking effort is reapplied. The level of braking effort required to lock up a wheel is dependent upon the adhesion of the tire to the road. The condition of the tire affects the level of adhesion. Figure 10 shows the relationship between the coefficient of adhesion of the tire and its slippage under different road conditions.

The main components of an ABS are:

- Solenoid valve unit
- Master cylinder
- Wheel brake cylinder

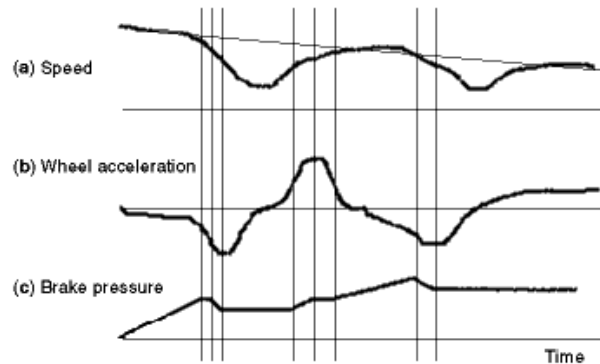

Fig. 11. A typical response of vehicles to brake pressure. Under braking conditions pressure activates the brake. The rotational speed of the wheel is monitored continuously, and the appropriate force is applied until the vehicle comes to a halt.

- Wheel speed sensor
- Controller

Under braking conditions, pressure is applied to the master cylinder, which applies hydraulic pressure to the wheel brake cylinder, which in turn activates the brake. The controller monitors the rotational speed of the wheel using the wheel speed sensor. If the deceleration of the wheel exceeds a preset limit, then the controller either stops or decreases the hydraulic pressure applied to the wheel cylinder by controlling the solenoid valve unit. Once the wheel is no longer on the verge of lockup, the hydraulic pressure to the wheel brake cylinders must be increased to prevent the wheel from becoming underbraked.

Figure 11 illustrates ABS control. The brake is applied at time zero. Graph (a) shows the wheel speed, equal to the vehicle speed before and shortly after the brake is applied. The brake pressure [graph (c)] at the wheel brake cylinder increases linearly, and the wheel decelerates. Once the deceleration exceeds a preset limit, the brake pressure is held constant by controlling the solenoid valve. If the wheel speed continues to drop below the slip threshold, the controller reduces the brake pressure by again controlling the solenoid valve. As the wheel begins to accelerate and crosses the preset limit, the solenoid valve is switched to hold the current pressure. The wheel's acceleration increases until it exceeds a preset limit, when the controller controls the solenoid valve to commence increasing brake pressure to the wheel brake cylinder. The wheel's velocity increases until it crosses the slip threshold velocity, at which time the controller switches the solenoid valve to hold the brake pressure constant. The cycle then continues until the vehicle comes to a stop.

An ABS is designed to be capable of adapting to changes such as:

- Change in the adhesion between the tire and road surface, such as driving onto gravel or ice
- Change in pressure from the master cylinder as a result of the driver changing the pressure on the brake pedal
- Periodic or erratic braking effort due to uneven brake disks/drums

Versions of ABSs have been produced that are characterized by their number of channels and sensor, each with its advantages and disadvantages. Some of the versions are:

- (1) **Four-Channel, Four-Sensor Systems** All four wheels have speed sensors and solenoid valves fitted. This version, although the most costly, provides the greatest control. When braking on split-adhesion-coefficient

surfaces the control system ensures that the yaw moment (torque around the vertical axis) does not increase to a point that would adversely affect the stability of the vehicle. This is achieved by applying to both rear wheels the minimum braking pressures.

- (2) **Three-Channel, Three-Sensor Systems** In this configuration the two front wheels have individual sensors and solenoid valves, while the two rear wheels share one set of sensors and solenoids.
- (3) **Two-Channel, Three-Sensor Systems** In this configuration, speed sensors are positioned on the two front wheels and a common sensor is used for the two rear wheels. One solenoid valve controls the front wheels, and second valve controls the rear wheels. This version offers reduced manufacturing cost but has some performance drawbacks. If the front wheel with the higher coefficient of adhesion is used to set the braking pressure, then the other wheel will lock, causing excessive tire wear. Alternatively, if the front wheel with the lower adhesion coefficient is used to set the braking pressure, then it is possible that the braking distance will be greater than if ABS were not employed.
- (4) **Two-Channel, Two-Sensors Systems** In this configuration only two wheels may be sensed, leading to similar limitations to those discussed for the two-channel, three-sensor configuration.

When a vehicle fitted with an ABS is braked on a split-adhesion-coefficient surface (e.g., left wheels on gravel and right wheels on asphalt), the vehicle experiences a yaw moment, which causes a turning motion. On larger-wheelbase vehicles, with greater moments of inertia, the driver can compensate for this effect by turning the steering wheel accordingly. For the smaller-wheelbase, lighter vehicles fitted with a ABSs, the turning force is more sudden and can result in vehicle instability. To reduce this effect, a delay is introduced in the application of brake pressure to the front wheel with the greater coefficient of adhesion. This has the effect of giving the driver time to compensate for the turning force. As this method reduces the pressure that can be applied to the wheel with the greatest adhesion coefficient, it can result in an increase in the stopping distance if not correctly tuned to the vehicle in question.

ABS principles are applied to commercial as well as passenger vehicles. The major difference is that commercial vehicles use pneumatic rather than hydraulic brake systems. An ABS, for commercial vehicles may be operated in one of three modes:

- **Individual Control** In this mode the maximum braking force is applied to each wheel. This results in the shortest braking distance on consistent road surfaces, but produces high yaw moments on split-adhesion-coefficient surfaces.
- **Select Low Control** This mode eliminates yaw moments on split-adhesion-coefficient roads, but can greatly increase the stopping distance.
- **Individual Control Modified** This mode provides a compromise between the preceding two modes. A solenoid valve is fitted to each wheel, and the braking pressure on the wheel with the higher coefficient of adhesion is reduced only so far as needed to reduce yaw moments. This results in slightly longer braking distances but with greatly improved stability and steerability.

Traction Control Systems. The aim of a traction control system (TCS) is to control the traction between the tires of the vehicle and the road. It determines the maximum torque that can be applied to the tire during standing starts and moving accelerations.

As the wheel is accelerated, the resultant slip produces a corresponding increase in adhesion, thereby reducing further slip. Once a point is reached where any further increase in acceleration results in slip that reduces the adhesion, the wheel will begin to spin. A TCS controls the wheel slip to maximize the transfer of force from the tire to the road, which results in improved traction and enhanced stability.

There are two methods used to control the force on the wheels. The first reduces the power from the vehicle's engine, and the second applies a braking force to the wheel. Where all wheels are on the same

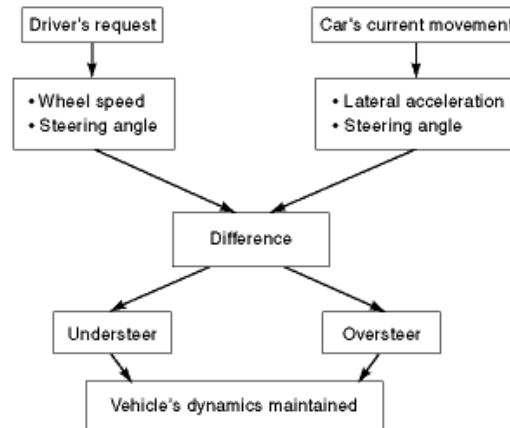

Fig. 12. A vehicle dynamics control system. This electronic system monitors many parameters and is particularly advantageous during acceleration of the vehicle. It operates by adjusting the power of the engine through the throttle or spark timing or fuel intake.

road surface (consistent coefficient of adhesion), wheel spin will be experienced when excessive torque is applied during acceleration. Under these circumstances all drive wheels will spin, and the TCS will respond by reducing the torque at the wheels. This is accomplished by reducing the power produced by the engine, either by throttling or by retarding the spark timing or by reducing the fuel.

Vehicles fitted with ECUs provide an integrated approach where any or all of the above methods are used to reduce the power produced by the engine while maintaining other constraints such as reduced emissions. Vehicles without ECUs are limited to mechanical control systems such as closing of the throttle by a servomechanism.

When accelerating on a split-adhesion-coefficient road surface (e.g., left wheels on gravel and right wheels on asphalt), the wheel with the lower coefficient of adhesion will experience wheel slip. The TCS responds by applying pressure to the brake cylinder of the slipping wheel. This results in a reduction of wheel slip and in the transfer of power to the wheel with the higher coefficient of adhesion. For heavily loaded commercial vehicles large braking forces are normally required to provide optimal control. Prolonged operation under these conditions results in thermal overload of the braking system. To prevent this effect the following modes of operation have been developed:

- Disabling traction control for speeds above some limit (e.g., 30 km/h)
- Monitoring the thermal load at the brake system and disabling traction controls when it exceeds some limit

Vehicle Dynamics Control. A vehicle dynamics control (VDC) system (Fig. 12) provides a further degree of sophistication to antilock brake and traction control systems by encompassing their functionality and providing additional benefits. It is a closed-loop control system that prevents lateral instability. Whereas an ABS is employed under braking conditions and a TCS is employed during accelerations, the VDC system responds under such conditions as full braking, partial braking, coasting, accelerating, load shifting, and engine drag to provide improved lateral stability and steerability.

A VDC system utilizes the wheel slip properties to implement servo control for vehicle handling. Consider a vehicle entering a right-hand turn. Part way into the maneuver the lateral force on the rear wheels exceeds the adhesion forces between the tire and the road surface. The vehicle begins to rotate about the front wheels, which have not yet slipped without VDC, the vehicle has already become unstable. For the same situation a

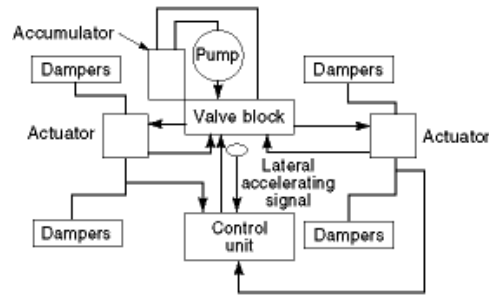

Fig. 13. A suspension control system. The system senses parameters such as acceleration and steering angle to control the air or hydraulic damping through various valves.

VDC system would control the yaw rate and slip angle to ensure that vehicle does not become unstable. The inputs to the VDC system are the wheel speed, the brake pressure, the steering-wheel position, the yaw rate, and the lateral acceleration.

The system calculates the vehicle speed and coefficient of friction between the tires and the road surface. The outputs of the system are control parameters for brake pressure modulation and engine management. The VDC system uses all available information to calculate the maximum performance of the vehicle under the current road conditions and the driver's requests (steering, braking, and acceleration). It also measures the current behavior of the vehicle. The VDC system attempts to minimize the difference between the maximum possible performance and the current performance of the vehicle by manipulating the forces at the interface between the wheels and the road surface. This is achieved by varying the torque and/or braking effort applied to each wheel.

Electronic Suspension Control. The suspension system minimizes the transmission of the road surface irregularities to the vehicle body. Suspension systems consist of springs, dampers (shock absorbers), and locating arms to align components, as illustrated in Fig. 13. By the use of electronic damping control different amounts of damping can be engaged according to road surface conditions. The major components of the electronic suspension systems are (1) the sensors (acceleration, steering angle, etc.), (2) the electronic control unit, and (3) the dampers controlled by solenoid valves. Electronically controlled air suspensions are also commonly used.

Body Electronics

Many vehicles are fitted with a wide variety of electronic devices within the passenger compartment to enhance comfort and safety of the occupants. Common systems are the dashboard instrumentation, central door locking, antitheft systems, cruise control, air conditioning, and air-bag systems. Also, collision avoidance and navigation aids are finding increasing application.

Dashboard Instrumentation. All vehicles are fitted with mechanical or analog or digital devices indicating road speed, engine speed, fuel level, and coolant temperature, and with a series of warning systems such as those for oil pressure, battery charging, open doors, and high beams. Although analog devices are still used, since the mid-1980s the use of digital displays has been increasing considerably. Some of these digital displays include quasianalog functions such as pictorial symbols.

In digital instruments, light-emitting diodes (*LEDs*), liquid crystal displays (*LCDs*), and vacuum fluorescent displays (*VFDs*) or cathode ray tubes (*CRTs*) display the information. Some vehicles are equipped with onboard computers (*OBCs*) that provide the user with journey information. The computer consists of a keypad

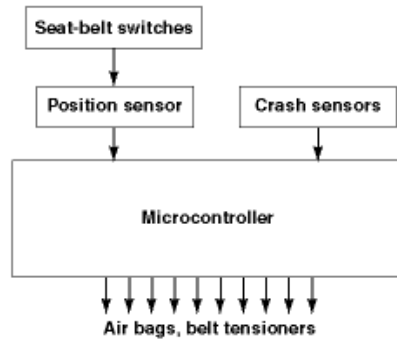

Fig. 14. An-air bag control system. Sensors generate signals on impact, and the air bag is activated and inflated to protect the driver and the passengers. The bag absorbs impact energy from occupants and collapses after a short time. There are also air-bag systems to protect against side crashing.

and a display. When required by the driver, the OBC displays information on time and date, average speed of the journey, fuel consumption, estimated arrival time at destination, outside and inside temperature, and so on, as well as some diagnostic information such as brake pad wear and windshield wash water level. In some cases, a drowsiness warning is given by monitoring the driving pattern of the driver.

Safety and Supplementary Restraint Systems. Systems for protecting occupants in the event of an accident fall into four major classes: maintenance of passenger-compartment integrity, occupant restraints, interior-impact energy-absorber systems, and exterior-impact energy absorbers.

A recent line of research has centered on passive restraints that do not require any action by the occupant. Supplementary restraint systems (*SRSs*) such as the air bag, as shown in Fig. 14, are a good example of this concept. The air-bag system consists of deceleration sensors (*D* sensors) mounted on the front of the vehicle, *S* sensors mounted in the passenger compartment, and an inflatable cushion that is concealed in the steering column or in areas of the car that are directly in front of passengers. The sensors provide information to the ECU. In case of a crash, the system provides passive crash protection by inflating to a position between occupants and the car structure in less than one-tenth of a second. The bag absorbs impact energy from occupants as they are thrown forward during a frontal crash. The bag collapses in approximately one second. Energy is absorbed by forcing gas out of the cushion through a series of ports or orifices in the fabric. Generally, the crash sensor sends an electric signal directly to an igniter, which triggers an explosion that generates nitrogen gas to inflate the air bag.

A complementary device to enhance safety of the occupants in a vehicle is the seatbelt tightening system (*STS*), which uses similar technology to the air-bag system. Once the signal for activation is generated, the seatbelt is tightened by a wire that wraps round the inertial seatbelt drum.

Security Systems and Alarms. Electronic vehicle security systems and alarms are well established. They can be factory-fitted by the manufacturer or can be purchased for add-on. There are two basic types: the antitheft devices (immobilizers) and alarms, which can be combined.

Antitheft Devices. These are among the most widely used and essential parts of electronics systems of modern vehicles, since motor vehicle theft is an increasing problem (costing billions of dollars) to owners, insurers, and manufacturers. The number of thefts increases almost every year. However, the problem is not new. Long ago, drastic actions were taken to prevent theft; for example, the 1900 Leach automobile was manufactured with a removable steering wheel. In modern times, antitheft devices range from electronic alarms to radio beacons.

An *immobilizer* is a device that, once activated, breaks one or more connections to several electric systems, making it difficult to start the vehicle. For example, the electric fuel pump is disconnected, a solenoid

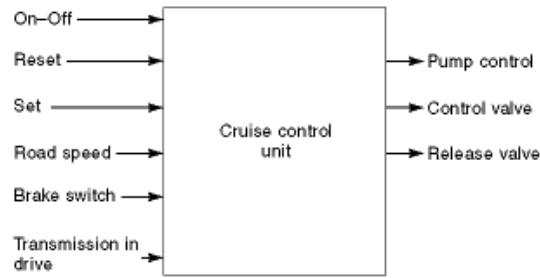

Fig. 15. A cruise control system. This system maintains the vehicle at a set speed. The speed of the vehicle is sensed and the throttle position is adjusted. Intelligent cruise control systems are also available to adapt to the conditions of the traffic.

valve is used to block the fuel supply, and the ignition system is disabled. The vehicle's engine is effectively incapacitated, preventing it from being started without deactivating the immobilizer. A small flashing light located, either on the vehicle's dash or near the front windshield, is used to indicate that immobilizer is activated. Several methods are used to activate and deactivate the immobilizer, including a radio-frequency (*RF*) transmitter and receiver, inductive proximity, and electric contact.

Keyless Entry. In recent years, the use of RF-based keyless entry systems for locking and unlocking vehicle doors, and for opening the trunk have become common. The systems make use of surface acoustic wave (*SAW*) resonators, which provide a high degree of frequency stabilization in the transmitters and receivers. The signals from the transmitter are commonly received by a loop antenna located in the car. The information received from the transmitter is processed and directed to appropriate mechanisms to lock or unlock the doors, open the trunk, etc. In many cases, an algorithm incorporated in the key produces a *rolling code* with which to electronically authenticate the user. Most low-power RF systems operate in the 260 MHz to 470 MHz band, where licensing is not required for transmitters producing less than 1 mW of power.

Vehicle Alarm System. An alarm system uses sensors to detect unauthorized admission to the vehicle and then sound an alarm—either the vehicle's horn or a siren. A wide variety of systems are in production, with different levels of protection, depending on the price.

Vehicle security systems offer protection on a number of levels: (1) perimetric protection to monitor the position of the opening panels of the vehicle, (2) volumetric protection, which detects movements (by infrared, ultrasonic, or microwave means) in the passenger compartment of the vehicle, and (3) engine immobilization by either software or hardware.

Many different sensors have been used, including door, trunk, and hood switches, ultrasonic sensors to detect air movement within the vehicle and microphones placed on door pillars to detect the opening of a door. Other security systems consist of radio and glove-compartment sensing, glass breakage sensing, tilt sensing, backward or forward rolling sensing, and so on.

These systems attempt to scare away a thief by drawing attention to a vehicle being stolen, but because there are many false alarms, they have become less effective.

Cruise Control System. The cruise control system, shown in Fig. 15, allows the driver to maintain a fixed speed without using the accelerator pedal. The system has three main assemblies: (1) a switch pack to set and resume the required speed, (2) a throttle actuator unit to control the throttle butterfly unit, and (3) a cruise control unit to determine the vehicle's operating conditions.

Intelligent cruise controls also exist that allow the vehicle to adjust to the traffic flow conditions by maintaining a safe distance. The system senses the range and speed of the vehicles in the vicinity by using a microwave radar system that operates on either the Doppler shift of the frequencies and/or time delays of reflected signals.

Recent Developments in Vehicle Electronics; Position and Route Determination

Due to recent advances in automotive technology and the progress in the computer-aided design techniques, manufacturers are delivering products much more quickly than before to fulfil consumer demands. These days many manufacturers sponsor focus groups, where potential customers are asked for new ideas for the future car. Engineers and designers have been teamed up to produce vehicles that meet the expectations of at least a niche market. Some examples of the recent developments are as follows:

The automatic temperature control in the Jeep Grand Cherokee uses infrared sensors to scan the surface body temperature of front seat passengers, and the on-board computer controls the mixture of hot and cold air for better comfort.

Perhaps the most important example in vehicle electronics is the integration of personal computers and laptops with the onboard electronic systems. This enables the linking of mobile telephones with the GPS, wireless data modem, and voice recognition and text-to-speech software, all running through the PC. The integration of PCs is providing important safety and convenience features. More than a dozen cities in the United States already report traffic flow over the Internet. In addition, rudimentary voice-command systems are already available to adjust the climate control and audio systems in vehicles like the Jaguar S-Type and Mercedes-Benz S-Class.

In the United States, General Motors offers *head-up* display on the Chevrolet Corvette. Speed, oil pressure, and other important information are projected directly onto the windshield. Cadillac has a night-vision system, which uses heat sensors to project onto the windshield an infrared image of objects that may lie beyond the range of headlights.

Mitsubishi has demonstrated a small dashboard video camera that is trained on the drivers to keep them awake and alert on long trips. Cruise-control systems are being upgraded considerably. Mercedes-Benz has developed a system that generates radar beams to detect the vehicle in front and adjust the speed accordingly. Collision avoidance systems that sense the closing speed and apply breaks are gaining wider acceptance.

In the recent years, vehicle position determination has attracted considerable attention for at least two reasons:

- The driver wants to know the distance and direction to the final destination. Radio and dead reckoning navigation aids can satisfy these requirements partially. However, the determination of the optimal route is based on the current traffic conditions, and the driver must receive that information from outside. In the United States and European countries cellular radio and VHF radio systems are used.
- Dispatch centers want to know their position and status of their fleet vehicles.

In addition to various radio navigation systems (e.g., loran-C), low-cost navigators such as odometer-magnetic-compass ones are used for the position determination of land vehicles such as automobiles, trucks, emergency vehicles, and rental cars. Nowadays, navigation aids using GPS systems are used extensively. Cross-country trucks, for example, transmit their position to a dispatch center via Geostar or Starfix satellite systems using HF radios. Many modern vehicles contain digital road maps onboard. The distance and the direction of destinations are displayed on the screen.

BIBLIOGRAPHY

1. E. Chowanietz *Automobile Electronics*, Oxford: Newness, 1990.
2. U. Kiencke L. Guzzella *Advances in Automotive Control*, Oxford: Pergamon, 1997.
3. M. Shiozaki N. Hobo I. Akahori Development of a fully capable electronic control system for diesel engines, SAE 85-0172, 1985.

4. H. Bauer (ed.) *Automotive Electrical/Electronic Systems*, 2nd ed., Stuttgart: Bosch, 1995.
5. H. Bauer (ed.) *Automotive Handbook*, 4th ed., Stuttgart: Bosch, 1992.
6. Vehicle electronics meeting society's needs: energy, environment, safety, SAE 92-80986, 1992.
7. Vehicle dynamics and electronic controlled suspensions, SAE SP-861, 1991.
8. Electronic controls of diesel engines, SAE SP-673, 1996.
9. *Eighth International Conference on Automotive Electronics*, Conference Publication No. 346, London: IEE, 1996.
10. Advances in multiplexing in automobiles, SAE SP-806, 1990.
11. Sensors and actuators, SAE SP-1066, 1995.

HALIT EREN
FRANK LONGBOTTOM
Curtin University of Technology